



80110



Booklet available in English on  
Heft in deutscher Sprache erhältlich auf  
Livret disponible en français sur  
Libretto disponibile in italiano su  
Folleto en español disponible en

[LEGO.com/service/buildinginstructions](https://www.lego.com/service/buildinginstructions)



[LEGO.com/sustainable-packaging](https://LEGO.com/sustainable-packaging)



# BUILDER



Apple and the Apple logo are trademarks of Apple Inc., registered in the U.S. and other countries and regions. App Store is a service mark of Apple Inc. Google Play and the Google Play logo are trademarks of Google LLC. Tencent and the Tencent logo are trademarks of Tencent Inc.

LEGO.com/devicecheck

EN Ask parents' permission before going online | DE Eltern um Erlaubnis bitten, bevor du online gehst | FR Demande l'autorisation d'un parent avant d'aller en ligne | IT Chiedi il permesso ai tuoi genitori prima di andare online | ES Pídeles permiso a tus papás antes de conectarte a Internet | PT Peça autorização aos pais antes de acederes online | JA オンラインになる前に ほかの方のきよかももらおう | ZH 上网前应先征得父母的同意 | KO 온라인 접속 전에 보호자 동의가 필요합니다 | RU Спроси разрешения у родителей, прежде чем заходить в интернет | PL Poproś rodziców o zgodę, zanim wejdiesz do Internetu | CS Než půjdeš na internet, požádej rodiče o svolení | SK Skôr než pôjdeš na internet, vypýtaj si povolenie od rodičov | HU Kérj szülői engedélyt, mielőtt online csatlakoznál! | RO Cere permisiunea părinților înainte de a te conecta online | BG Поискайте разрешение от родител, преди да влезете онлайн | LV Pirms došanās tiešsaistē palūdz atļauju vecākiem | ET Enne Interneti kasutamist küsi vanematelt luba | LT Prieš prisijungdami prie interneto, atsiklauskite tėvų



招  
財  
進  
寶



## USHERING IN WEALTH AND PROSPERITY

'This set is designed around the greeting of 招財進寶, which loosely means "ushering in wealth and prosperity". We've used symbols that anyone familiar with Chinese New Year will recognise. The two gold ingots are in a traditional gold *Yuan Bao* design, and there are also pairs of Koi fish and red pockets, all of which are symbols that mean good fortune.'

John Ho, LEGO® Senior Designer



Build Together  
Gemeinsam bauen  
Construire ensemble  
Costruiamo insieme  
Construye en compañía  
Construir juntos  
一起来拼搭  
Собирайте вместе  
Wspólnie budowanie

Stavíme spoločne  
Štaviame spoločne  
Építsetek együtt!  
Construim împreună  
Да строим заедно  
Korrigai bűvészanei  
Ehitame koos  
Konstruokite kartu

The Spring Festival  
Das Frühlingsfest  
La fête du Printemps  
La Festa di Primavera  
Fiesta de la Primavera  
O Festival da Primavera  
春节  
Праздник весны  
Festival Wiosny

Jarní festival  
Jarný festival  
Tavaszi Fesztivál  
Festivalul Primăverii  
Пролетният фестивал  
Pavasara svētki  
Kevadfestival  
Pavasario šventė

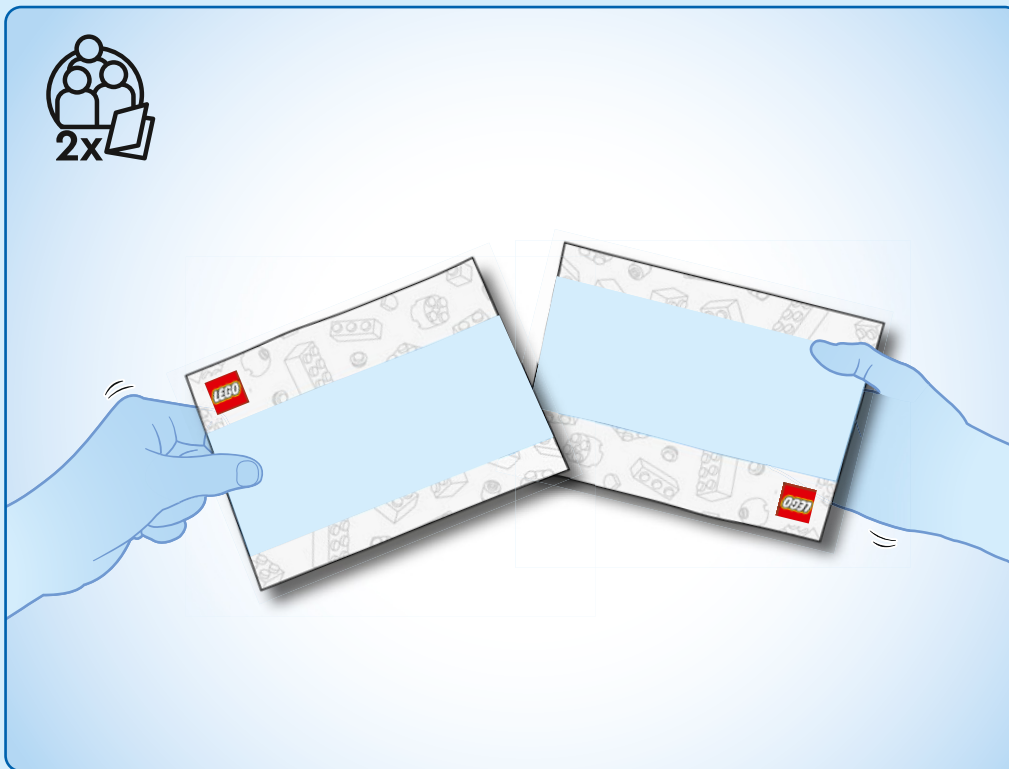

Chinese Festival  
Chinesisches Fest  
Nouvel An chinois  
Festa di Primavera  
Fiestas de China:  
Festival Chinês  
中国节日  
Китайские праздники  
Chiński festival

Čínský festival  
Čínske slávnosti  
Kínai Fesztivál  
Festivalul chinezesc  
Китайски фестивал  
Çhinešu svētki  
Hiina festivali  
Kinų šventė

Special edition  
Sonderedition  
Édition spéciale  
Edizione Speciale  
Edición especial  
Edição Especial  
特別版  
Особое издание  
Edycja specjalna

Speciální edice  
Špeciálna edícia  
Különleges kiadás  
Ediție specială  
Специално издание  
Ipašais izdevums  
Eriväljaanne  
Specialus leidimas



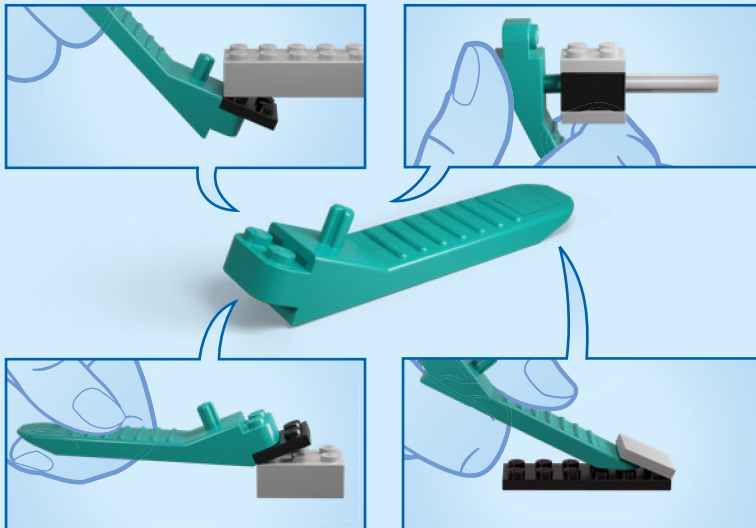



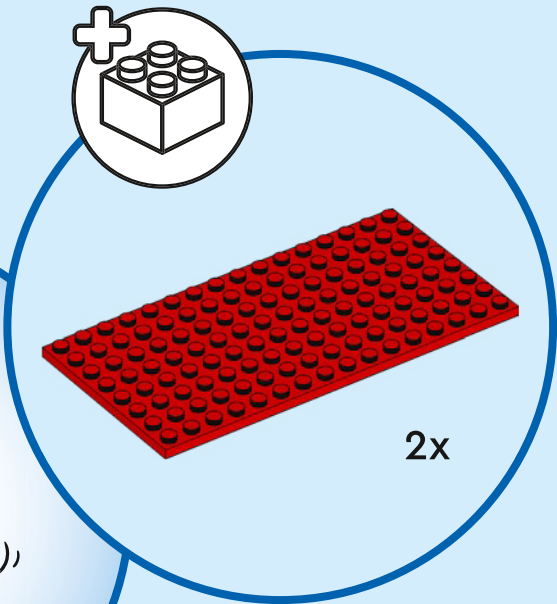
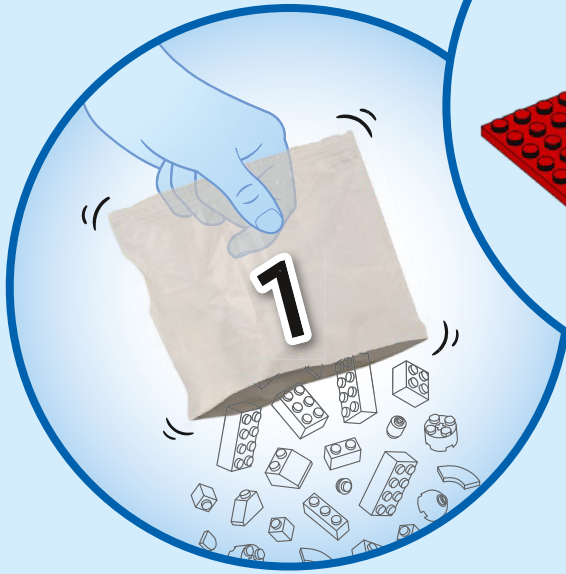

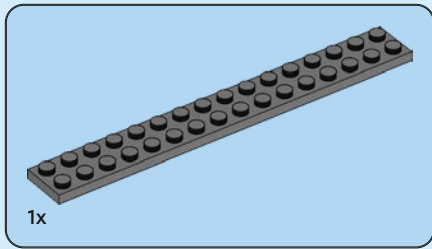

1

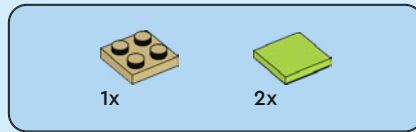
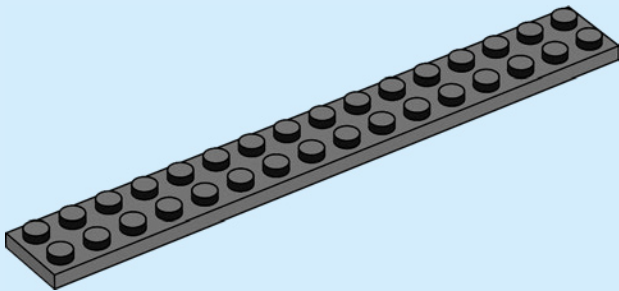

2

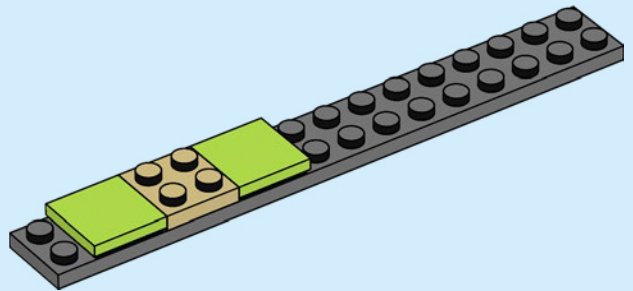

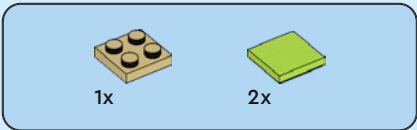

3

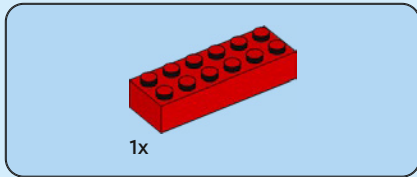
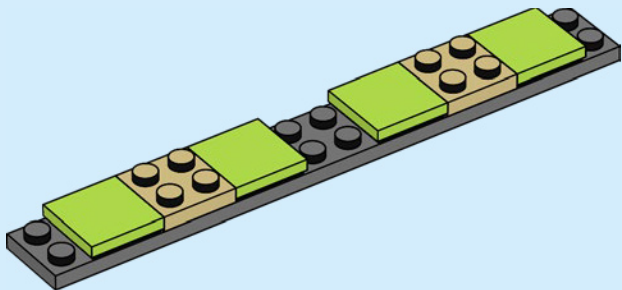

4

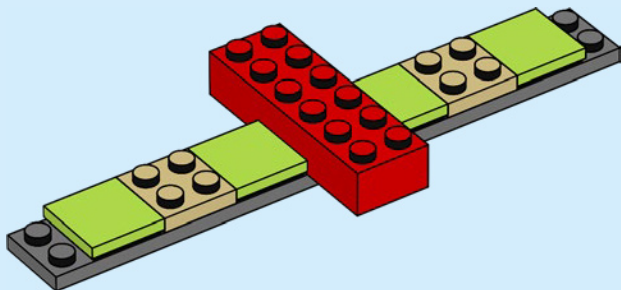

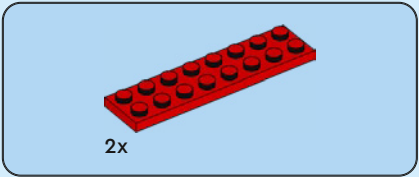

5

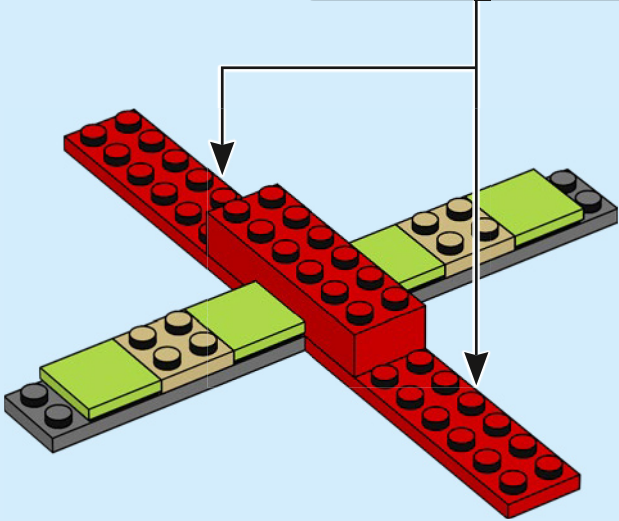
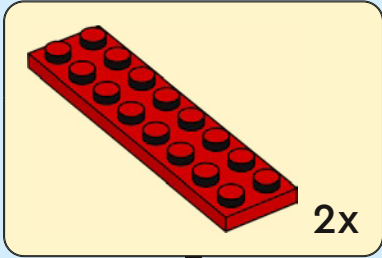



2x

6

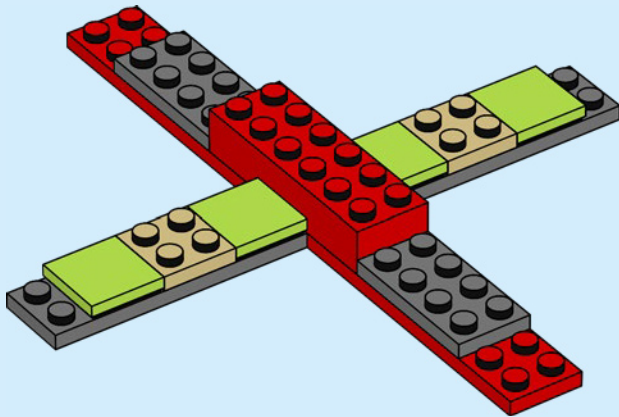

6x

7

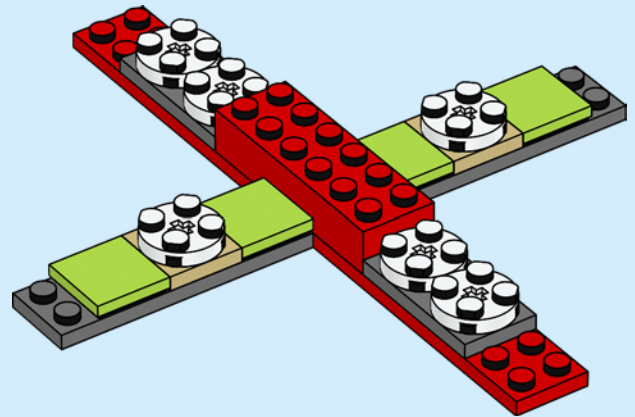



6x

8

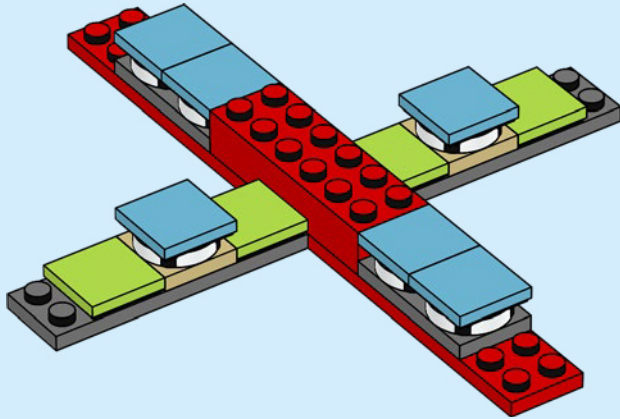

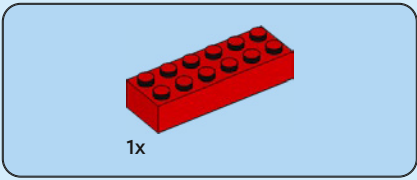

9

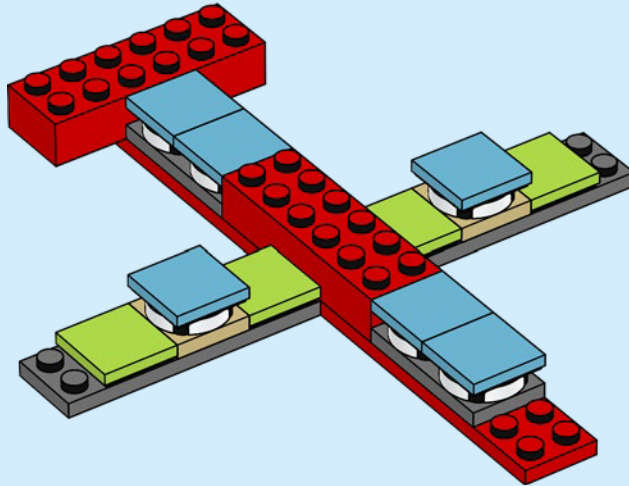

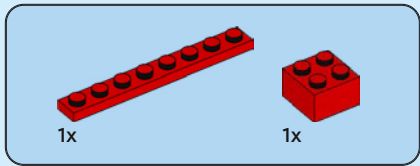

10

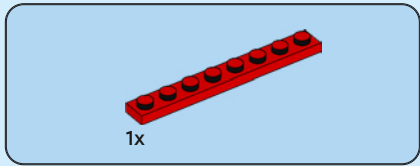
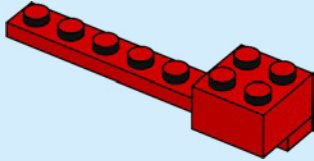

11

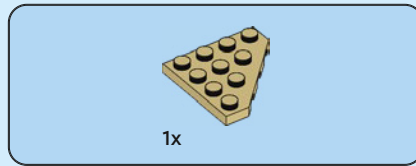
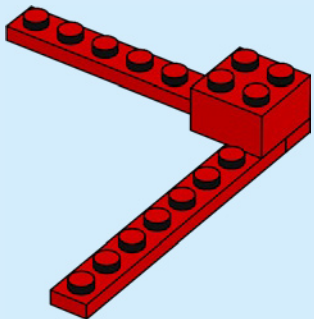

12

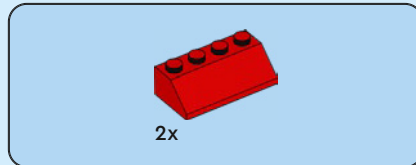
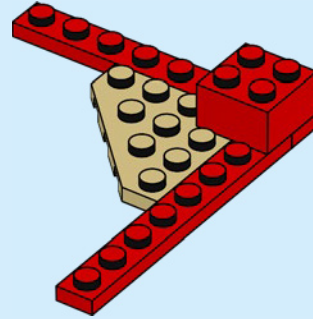

13

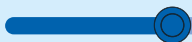
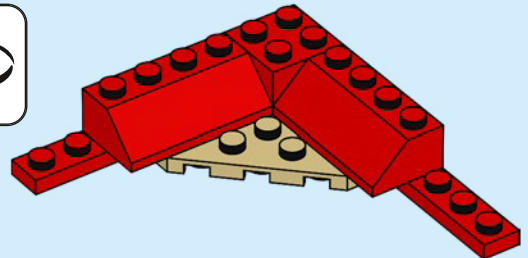
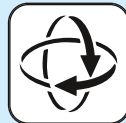



14

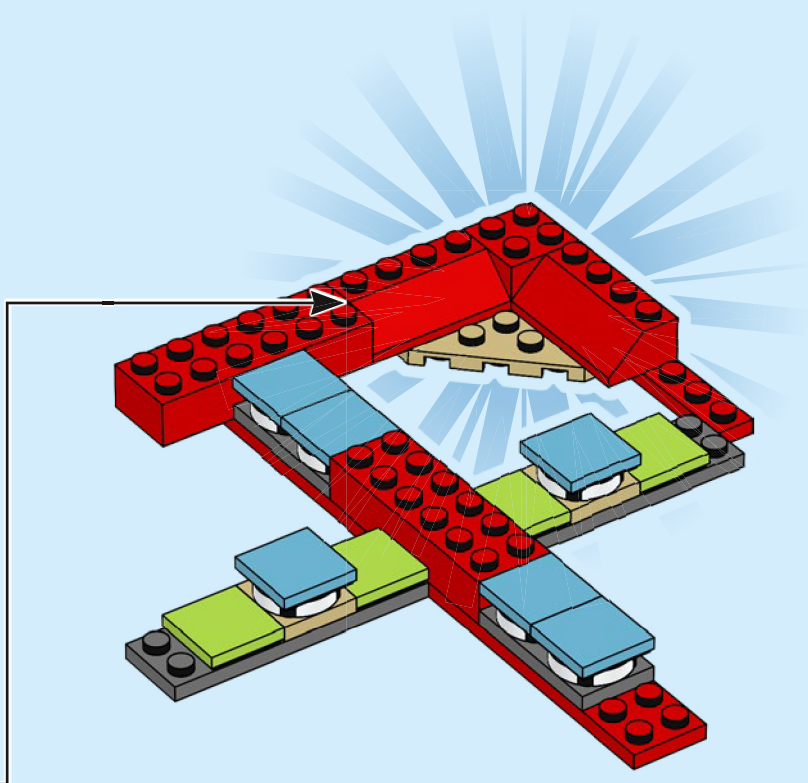

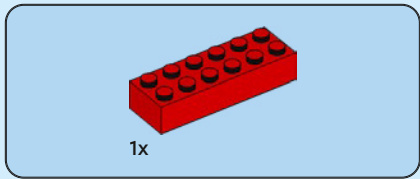

15

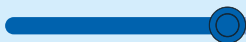
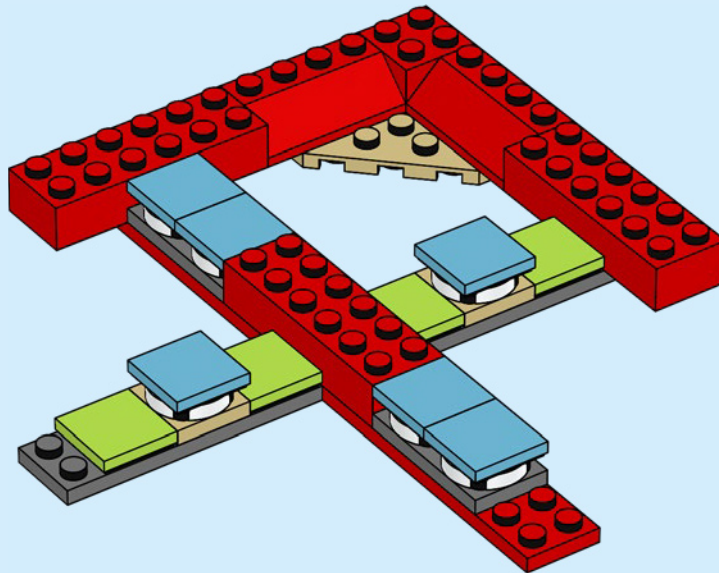

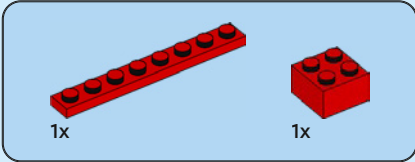
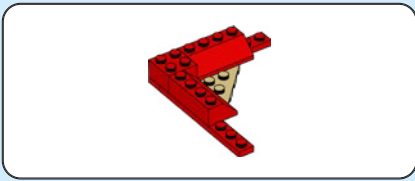

16

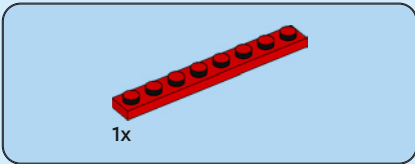
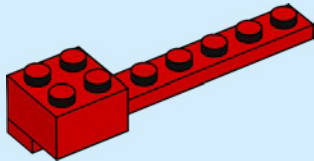

17

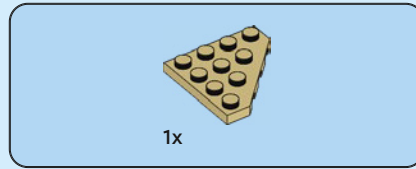
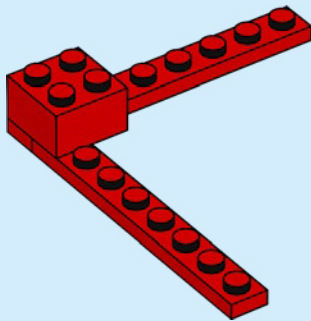

18

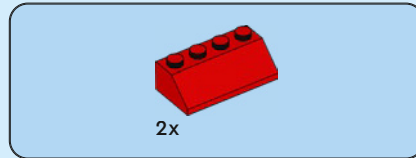
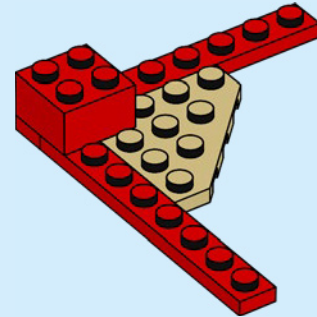

19

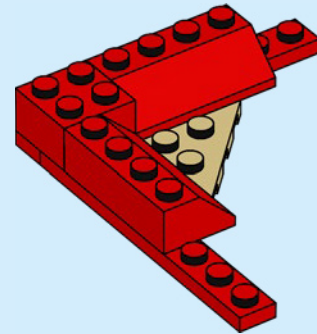

20

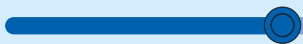
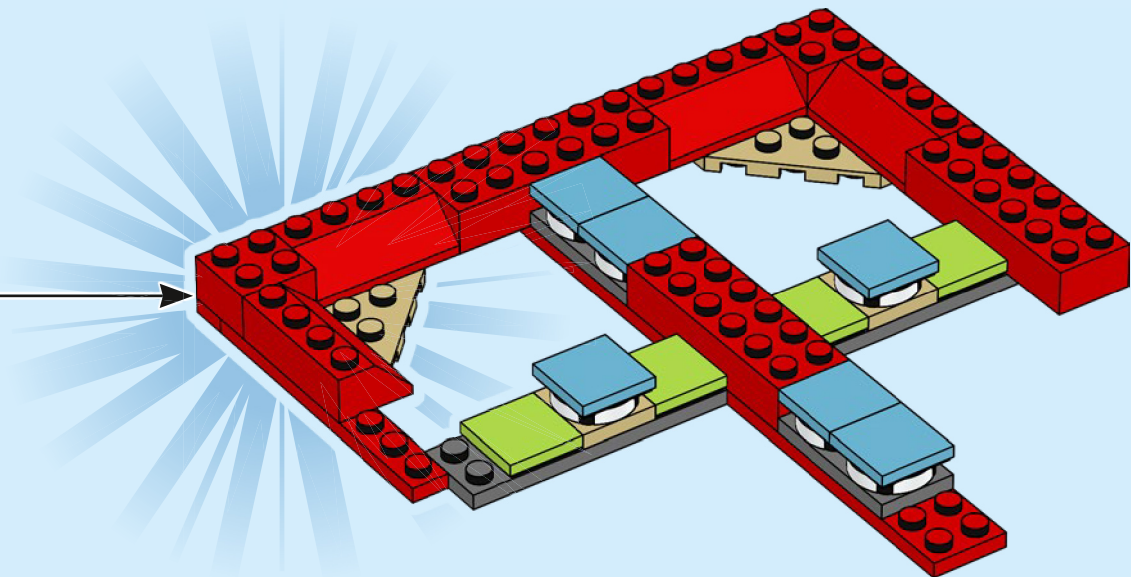

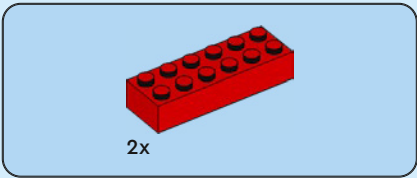

21

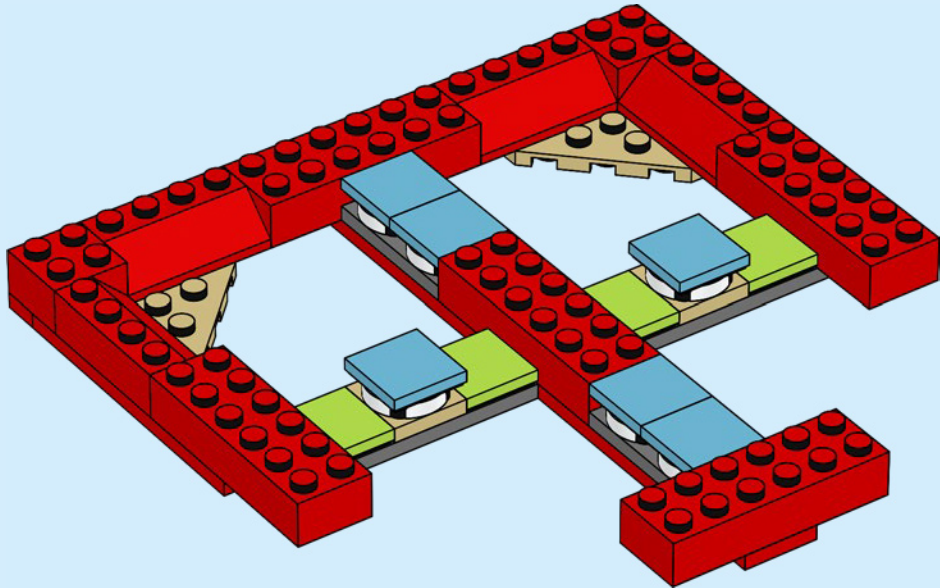

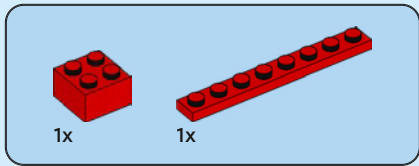

22

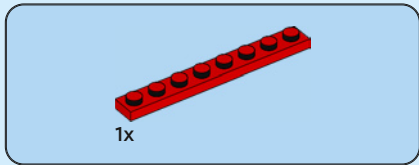
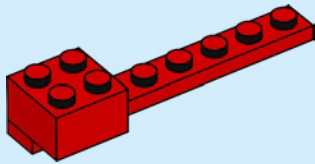

23

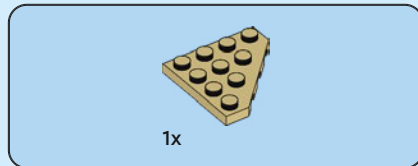
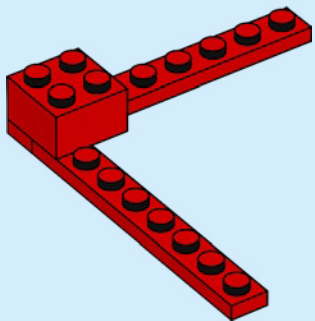

24

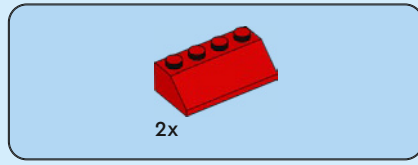
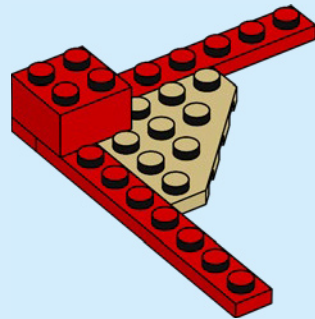

25

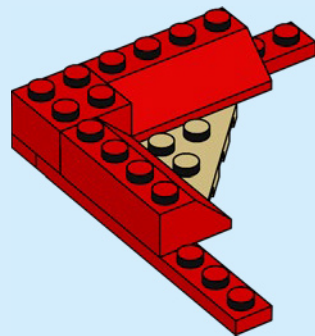

26

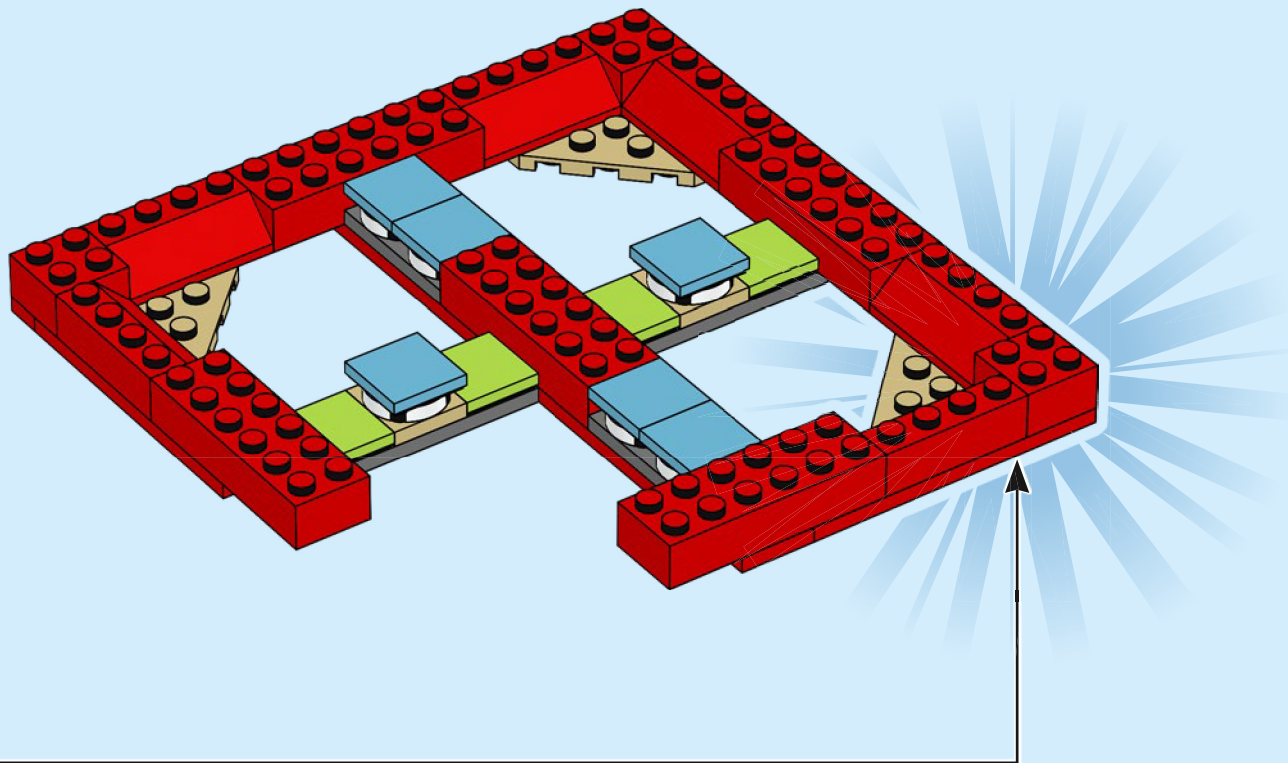

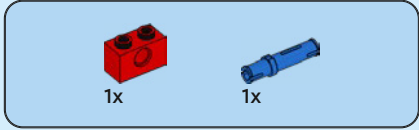
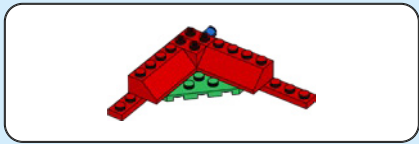

27

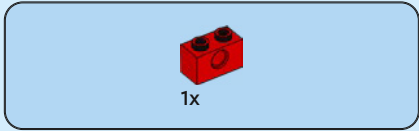
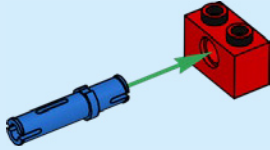

28

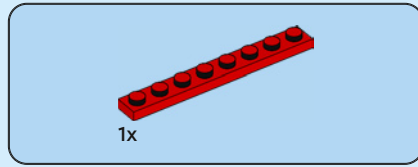
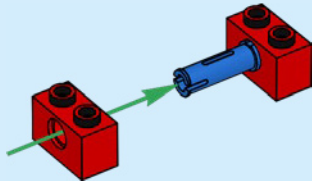

29

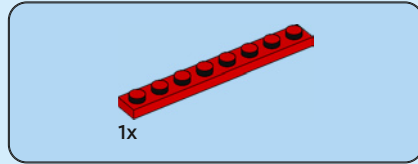
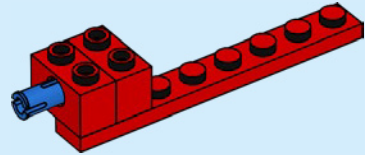

30

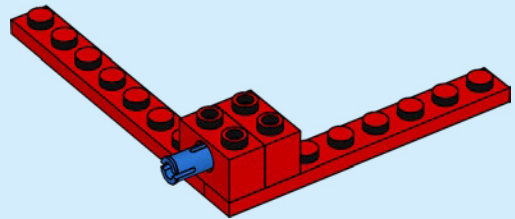





1x

31

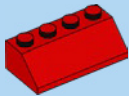
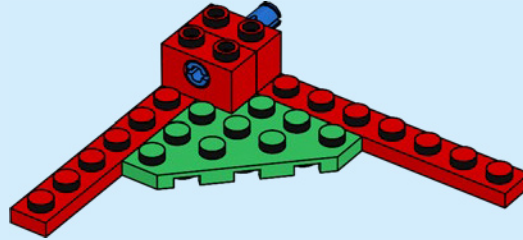

2x

32

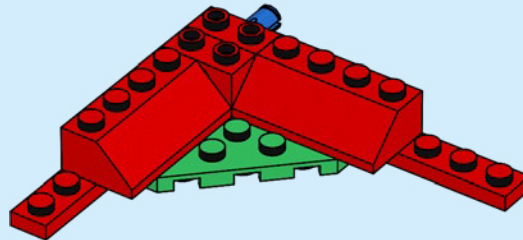

33

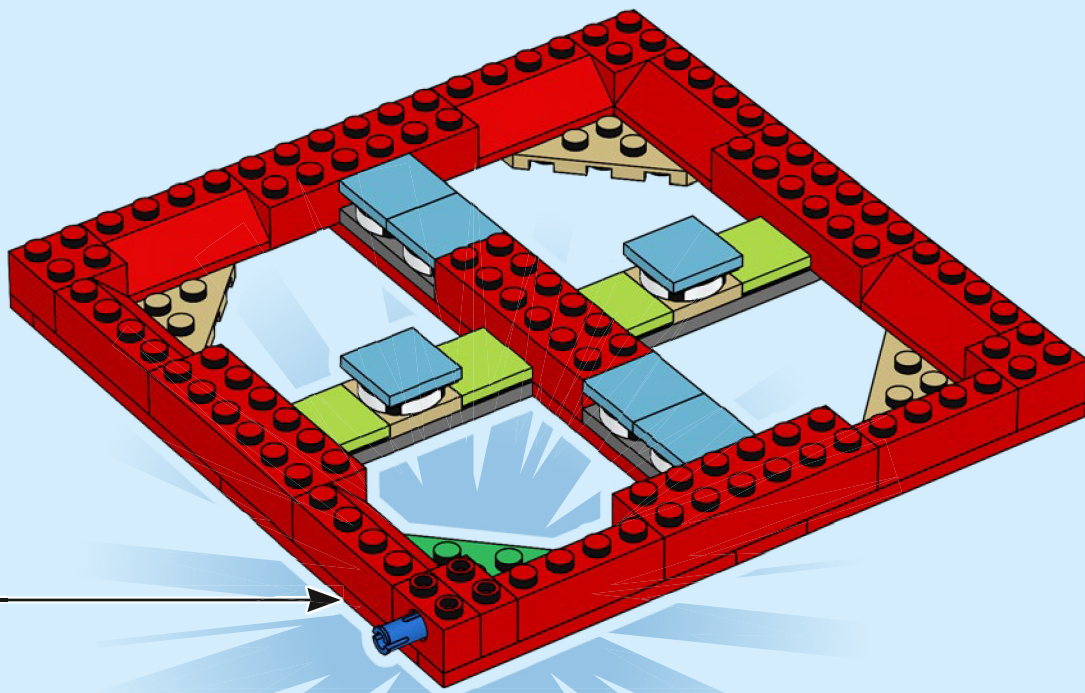

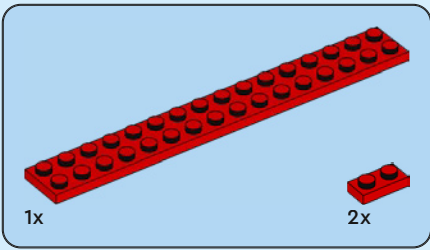

34

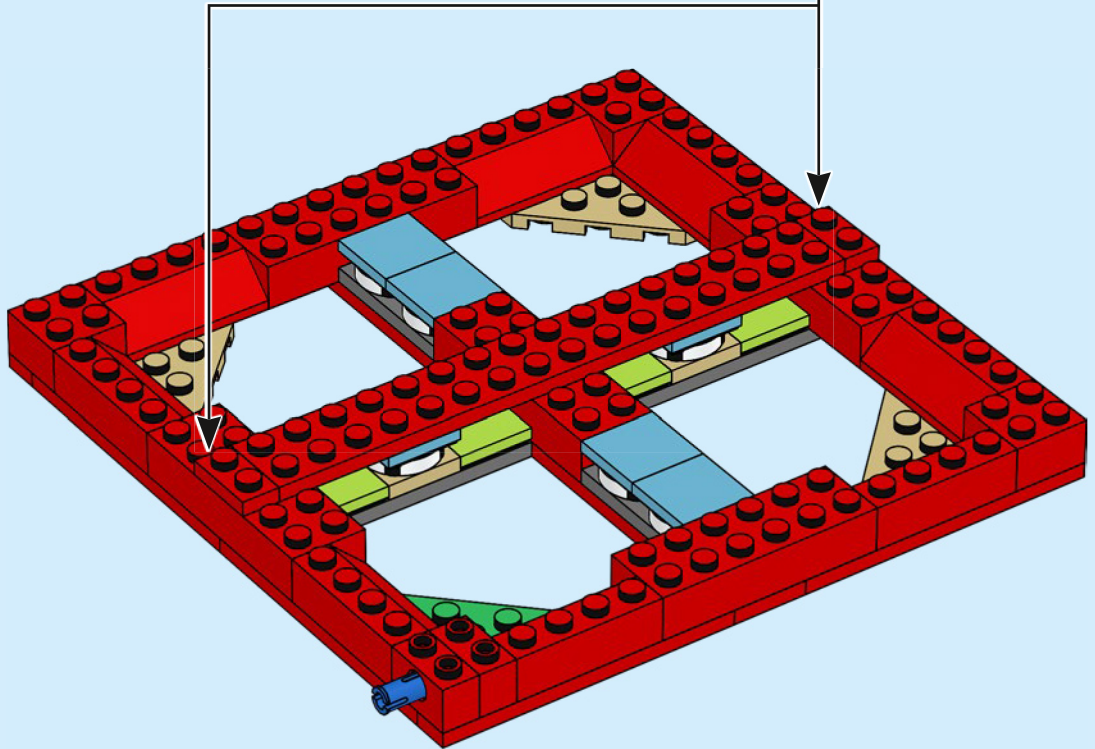

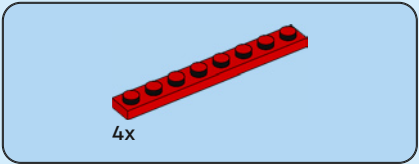

35

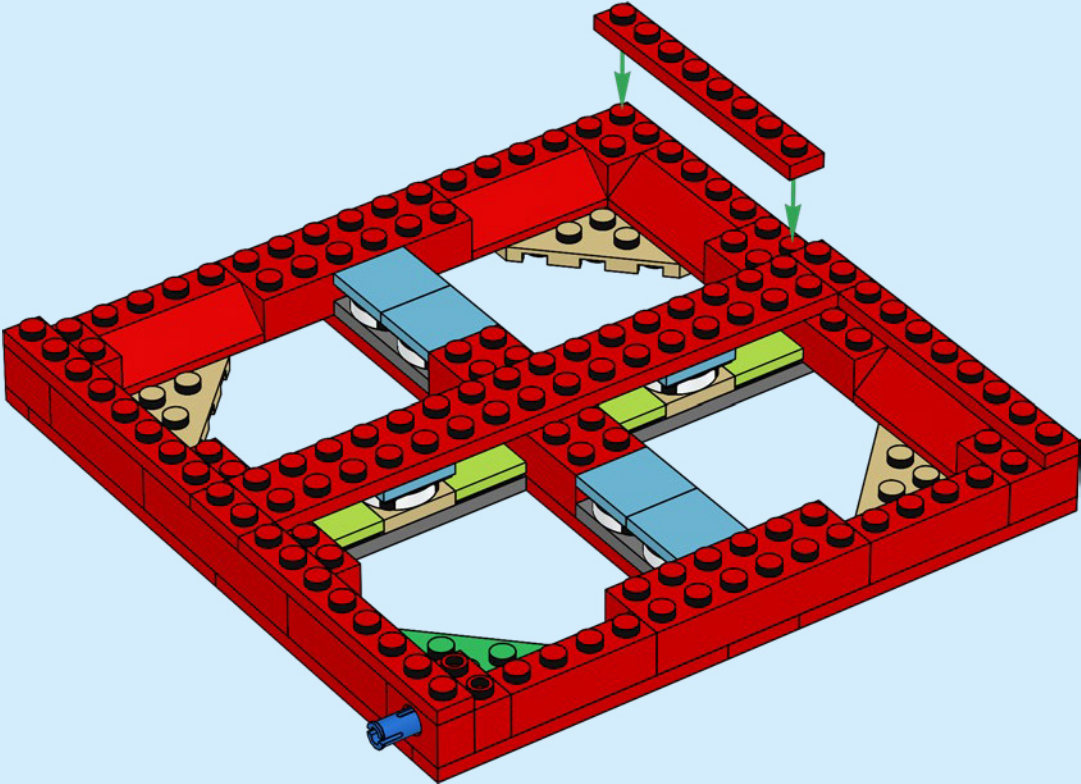

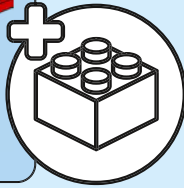
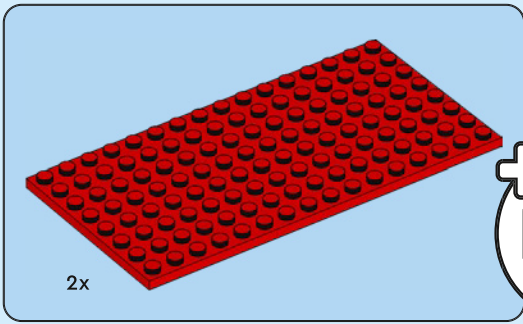

36

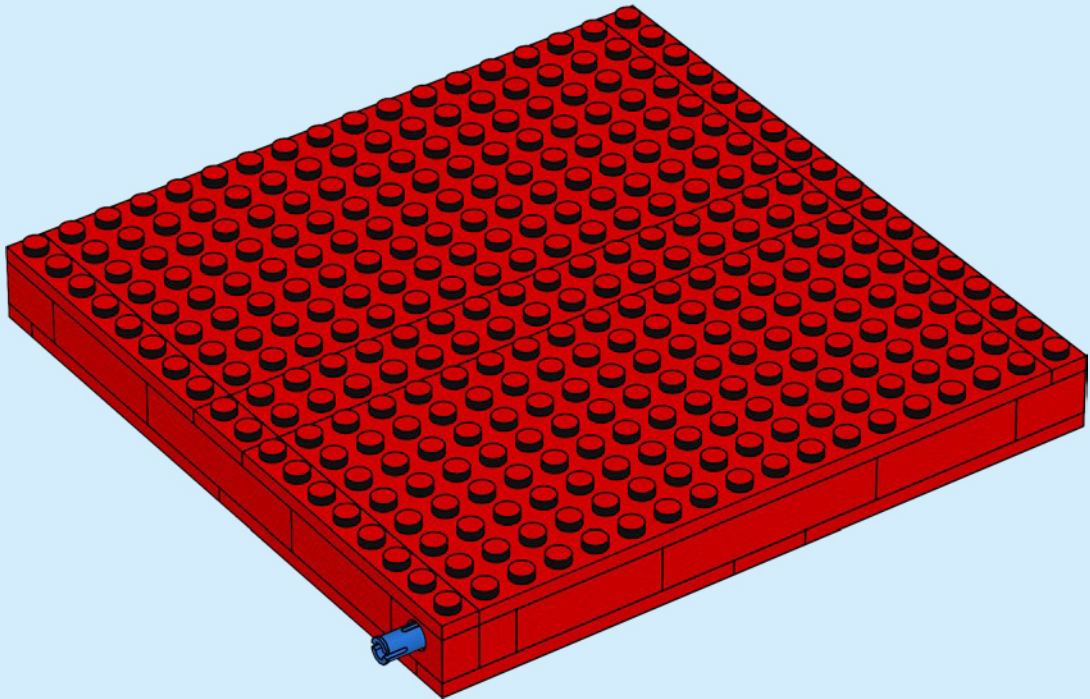



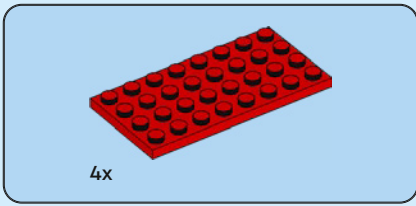

38

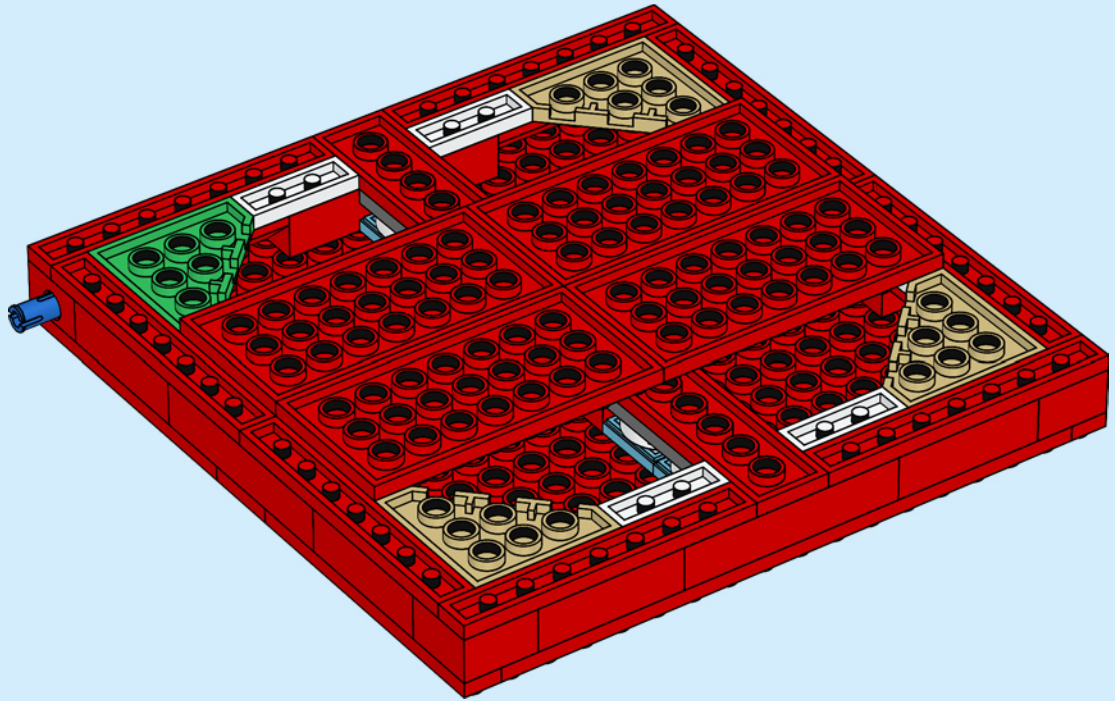

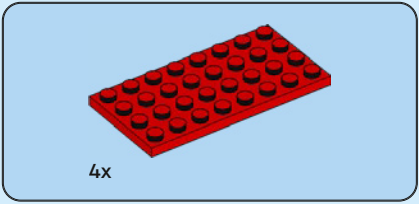

39

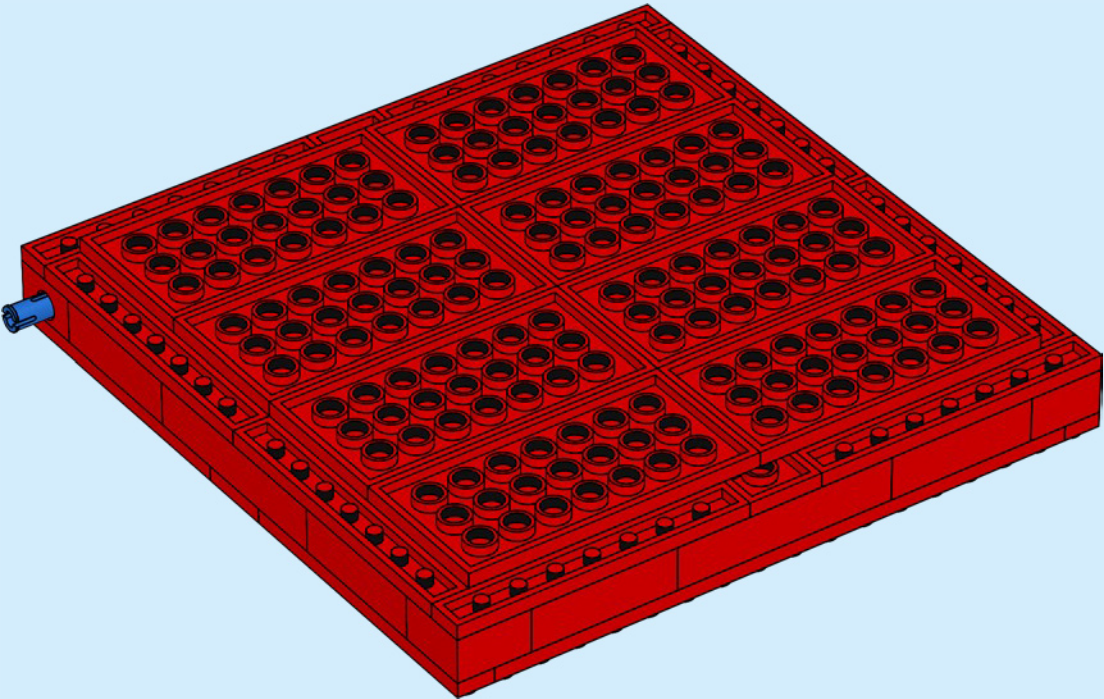



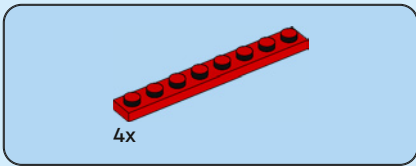

40

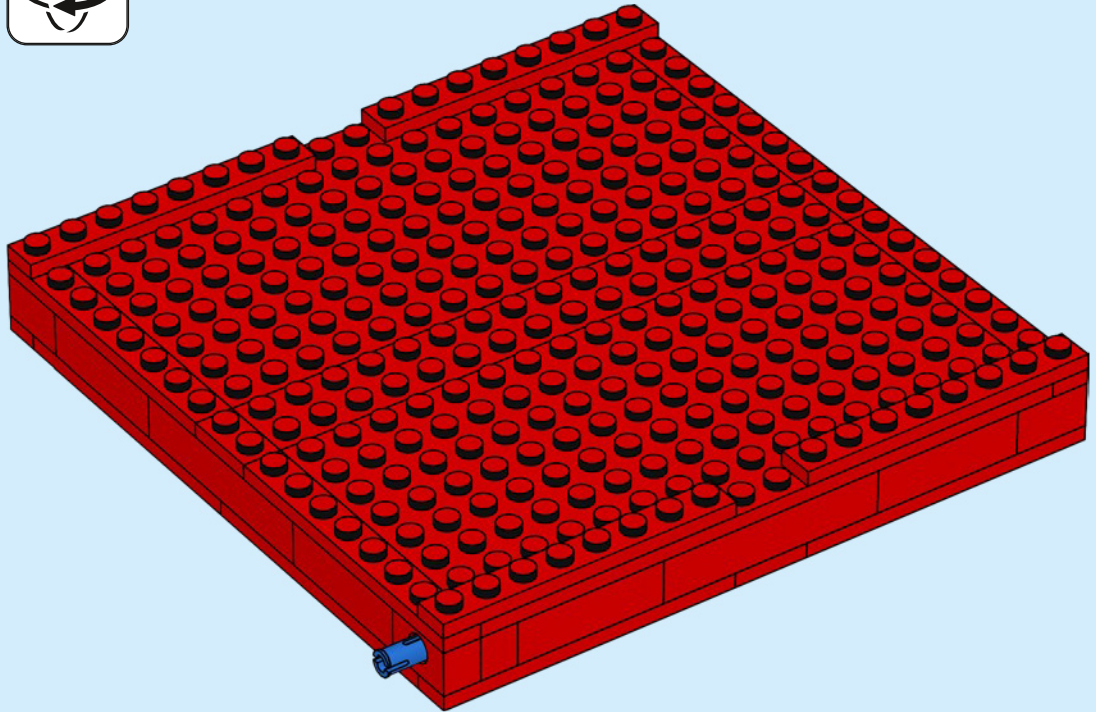



2x

41



2x

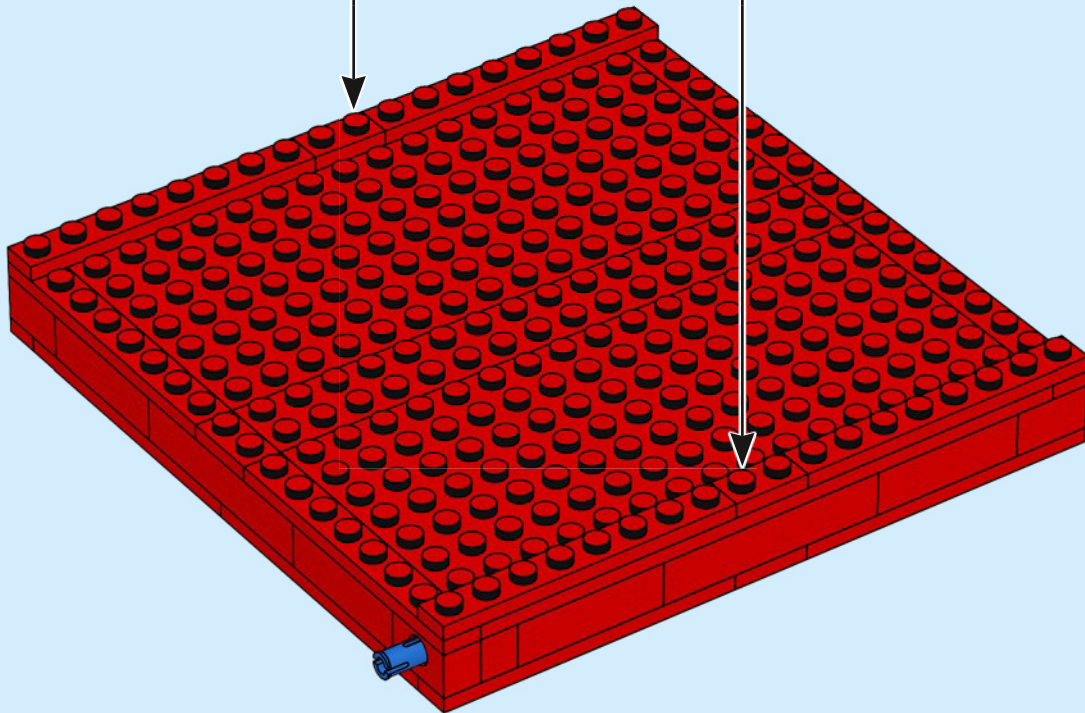

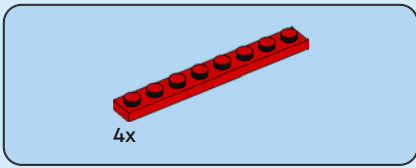

42

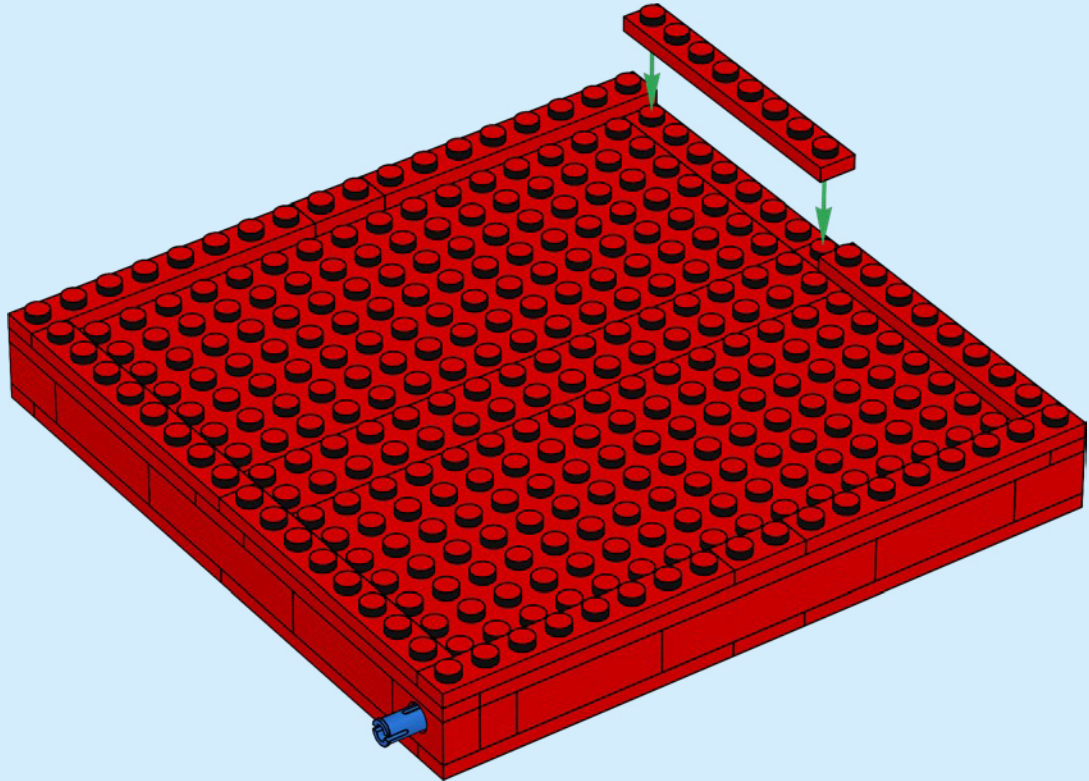

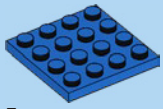

3x

43

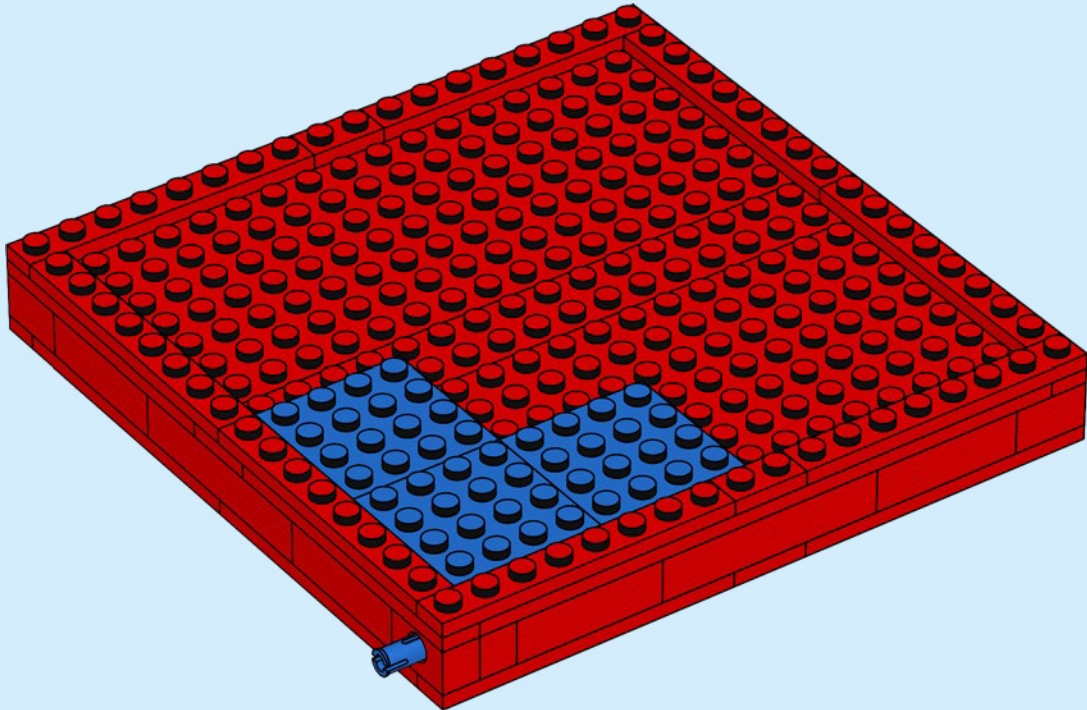



3x

44

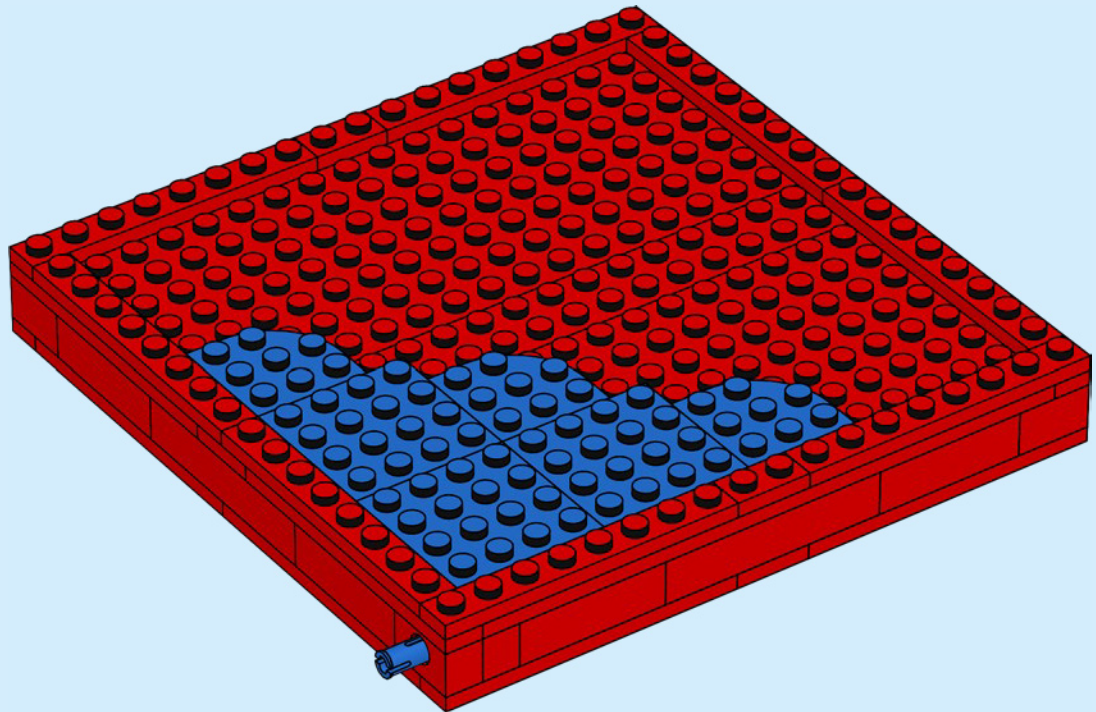



2x

45

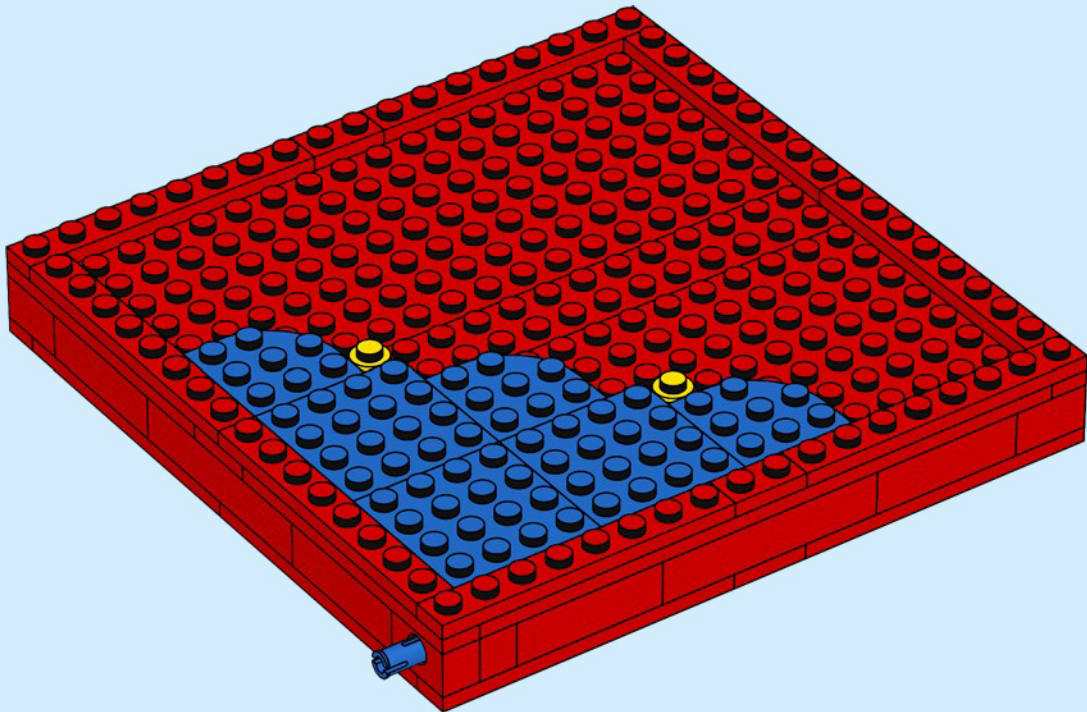



1x



1x

# 46

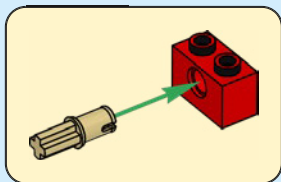
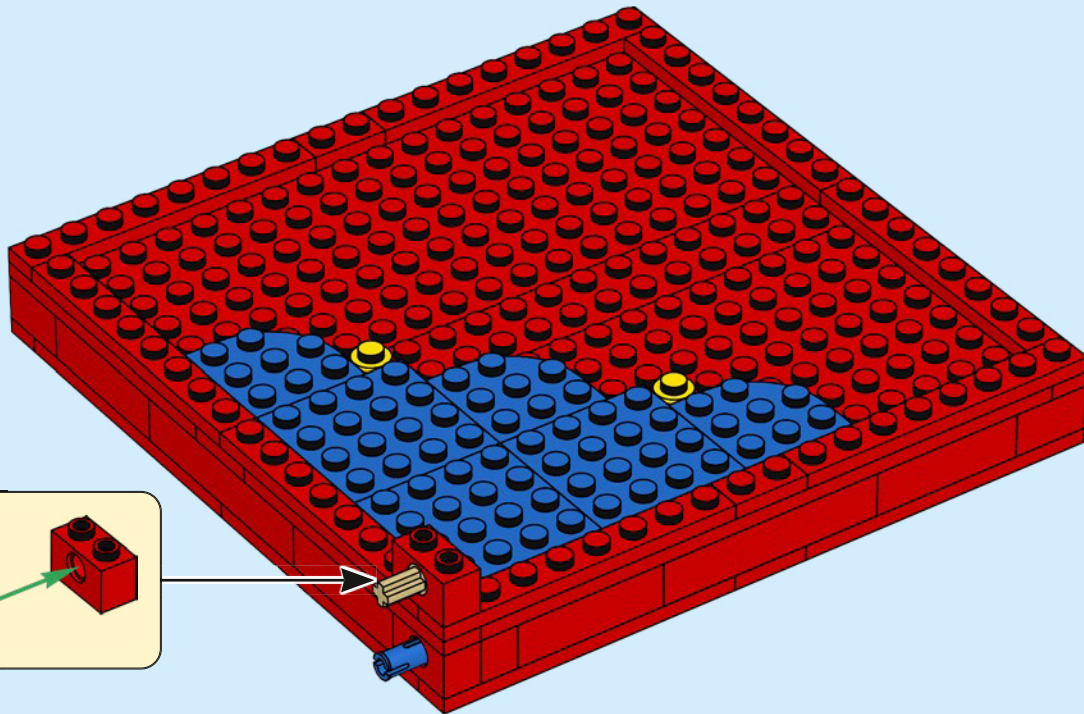







3x

47

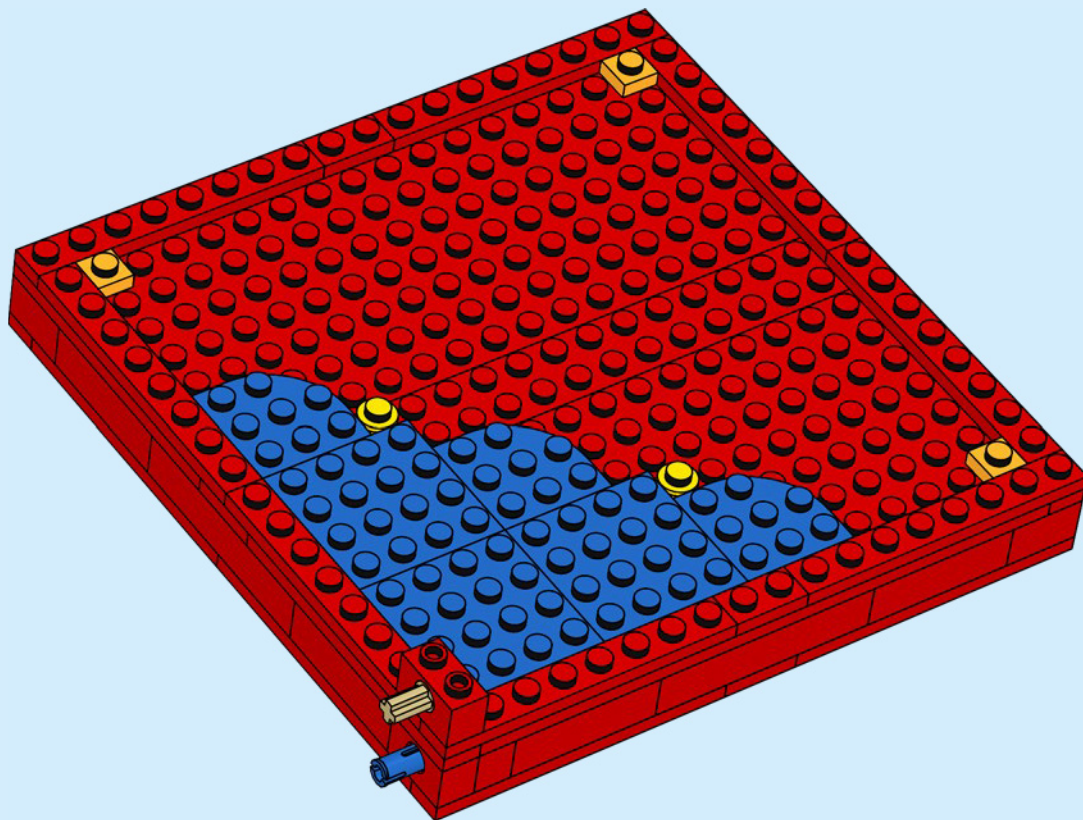

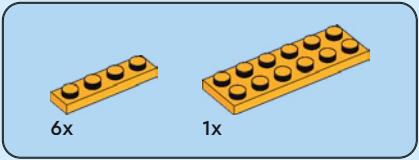

48

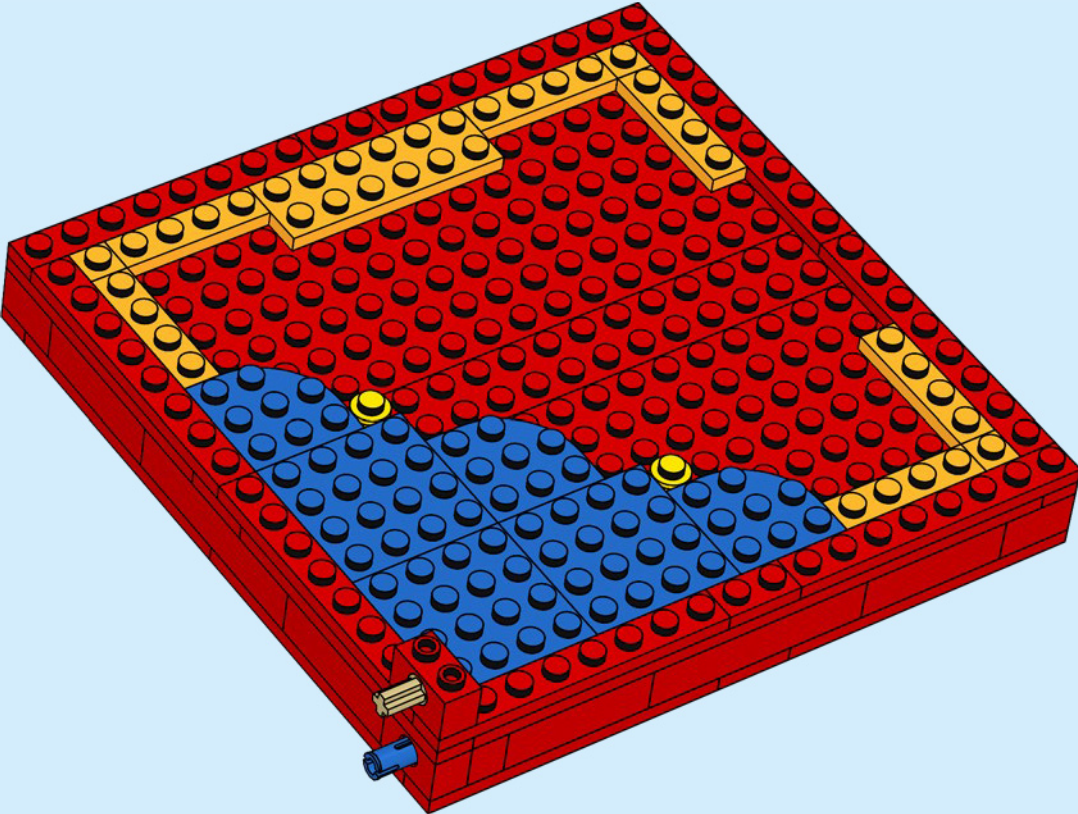



3x

49

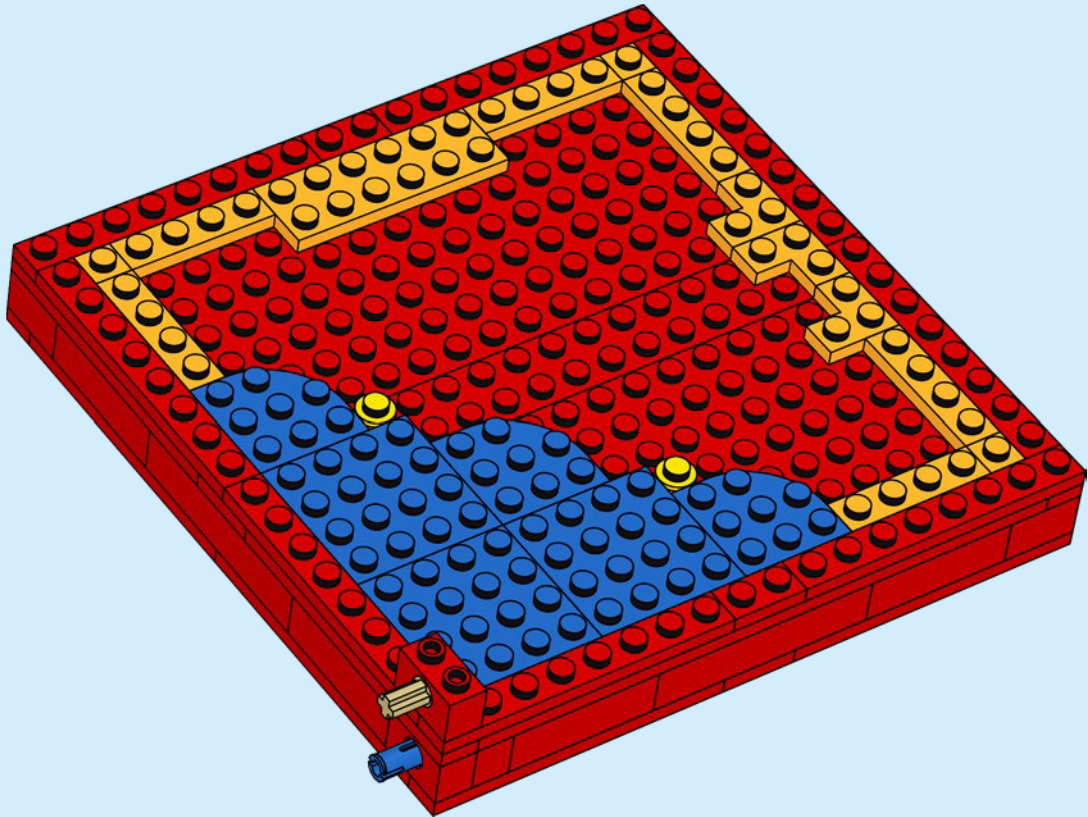



3x

50

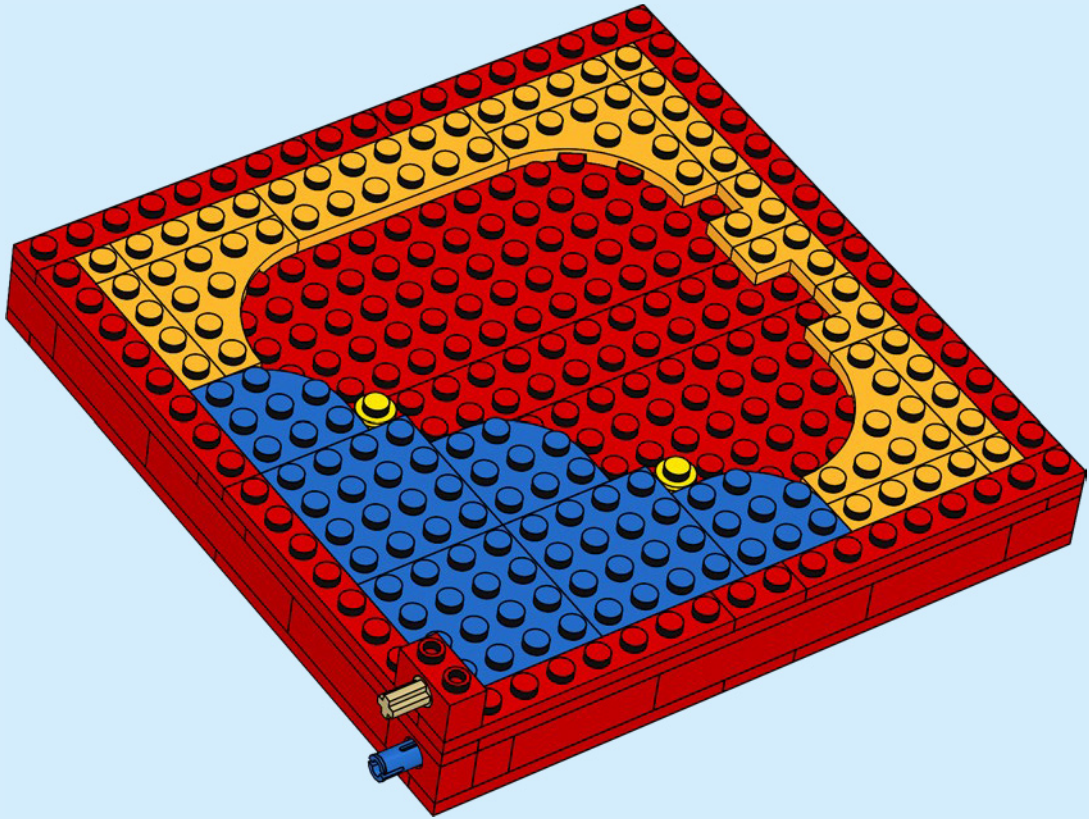



1x



1x

51

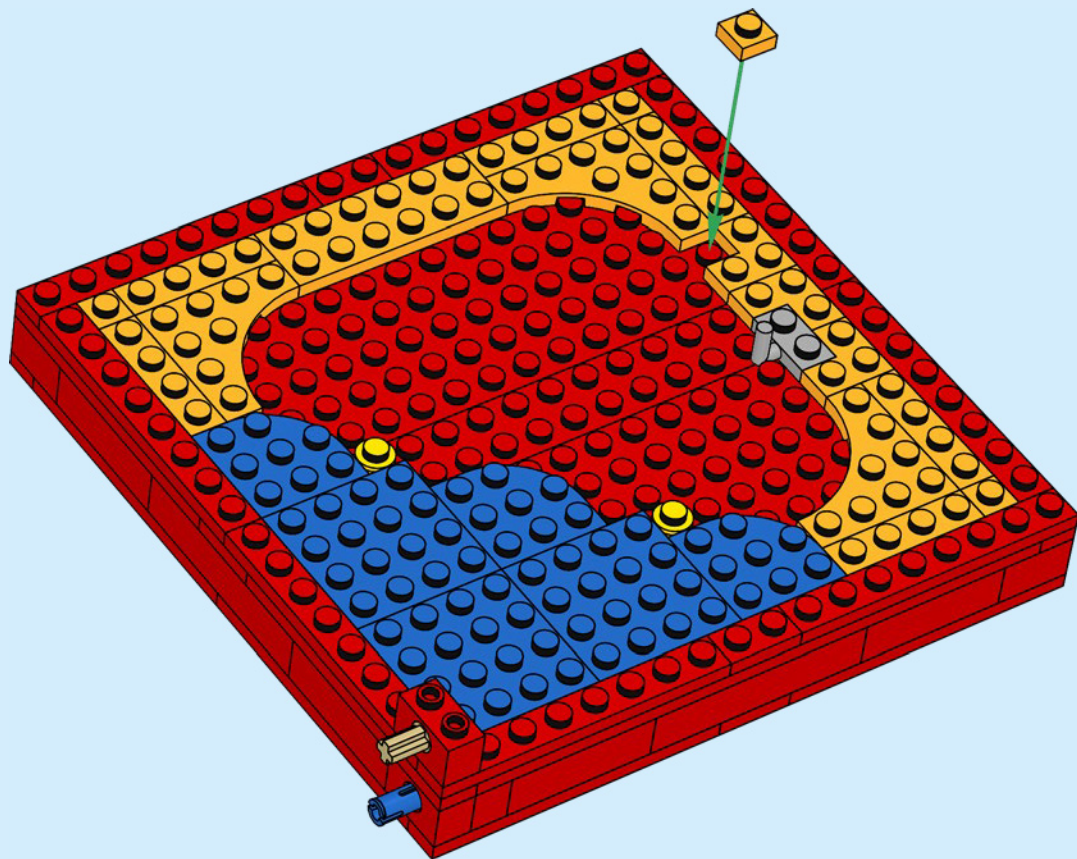

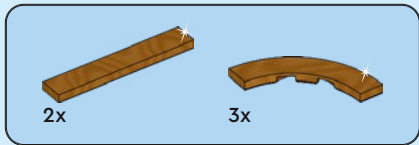

52

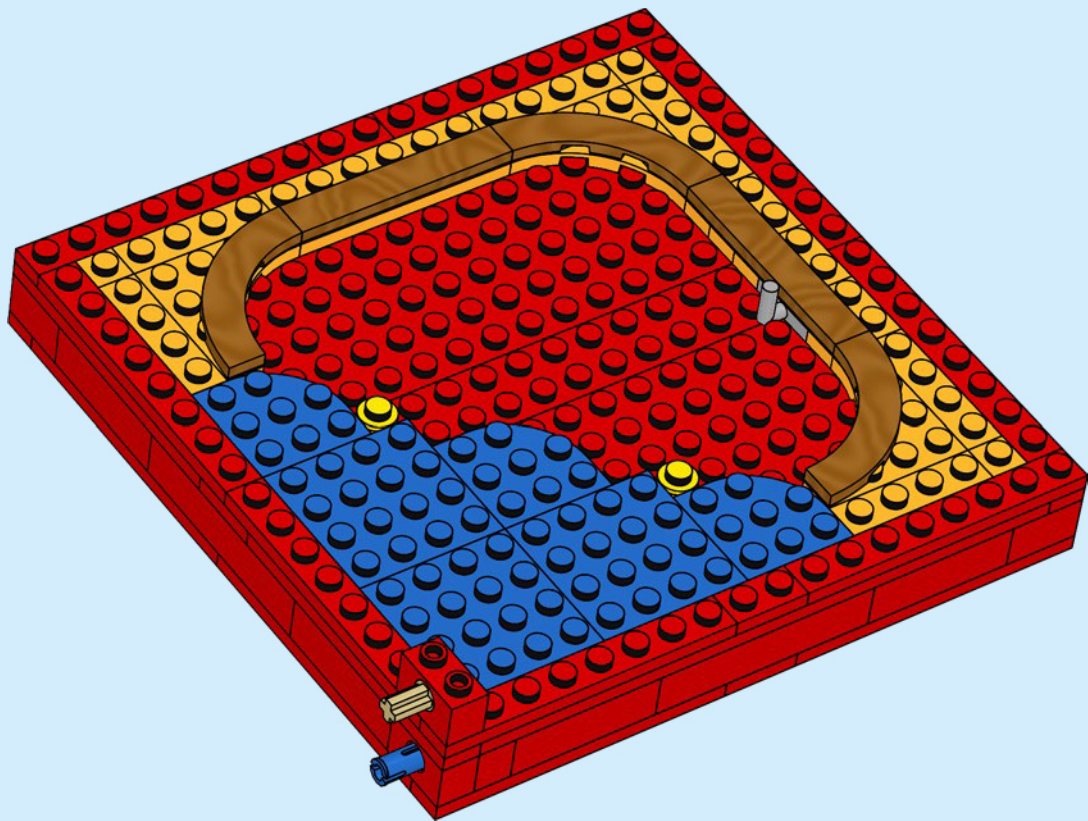

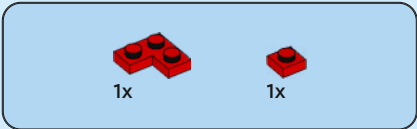

53

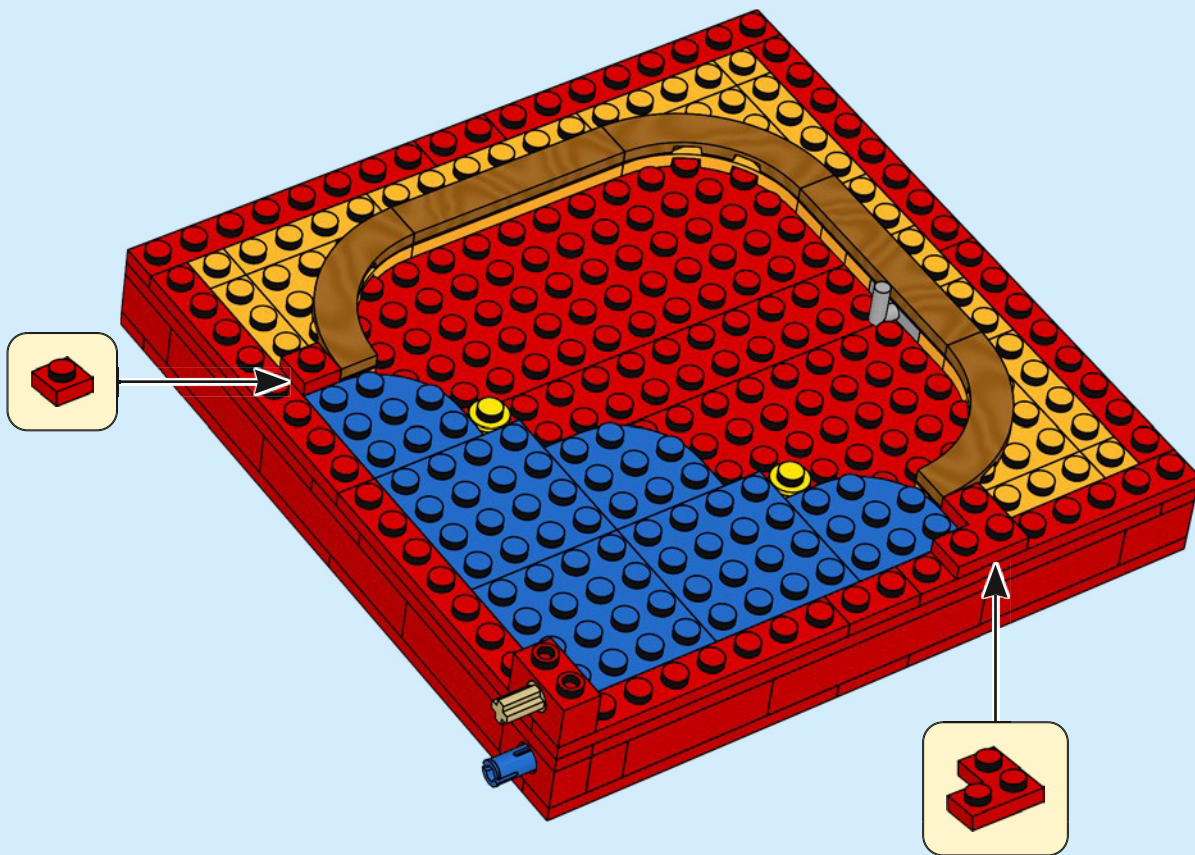



4x

54

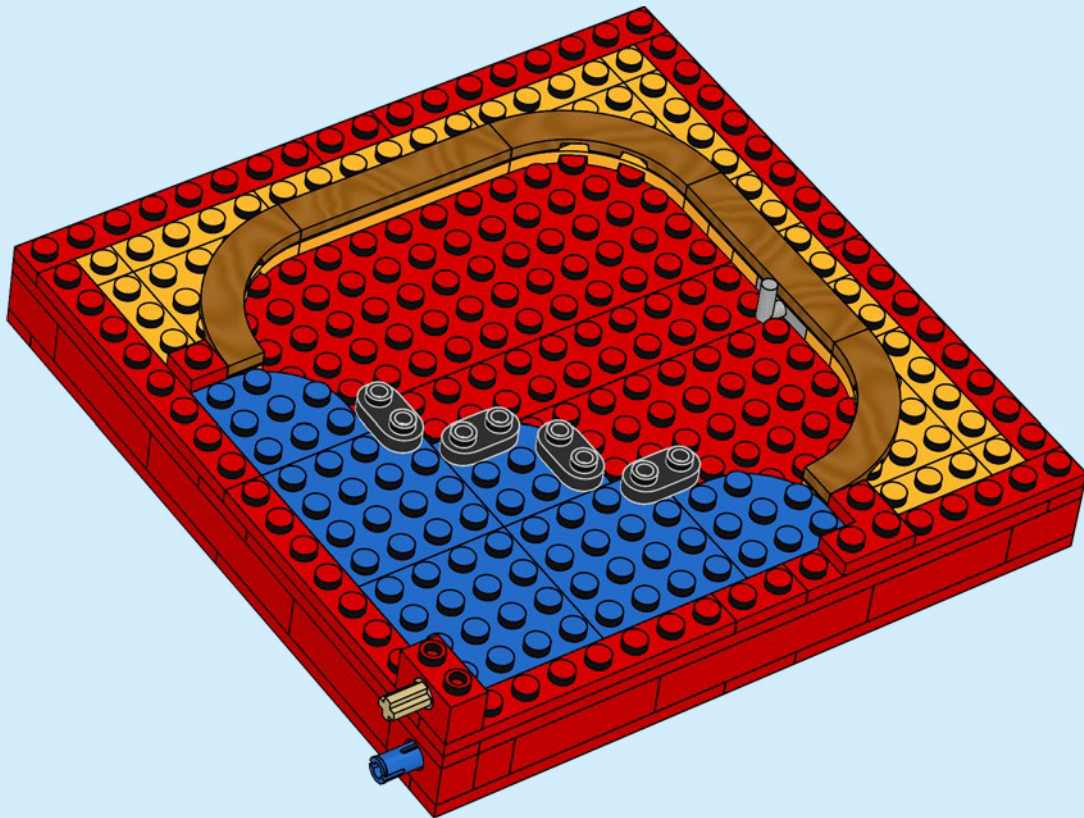



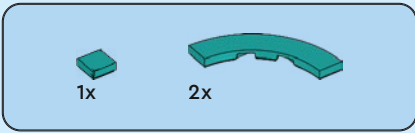

55

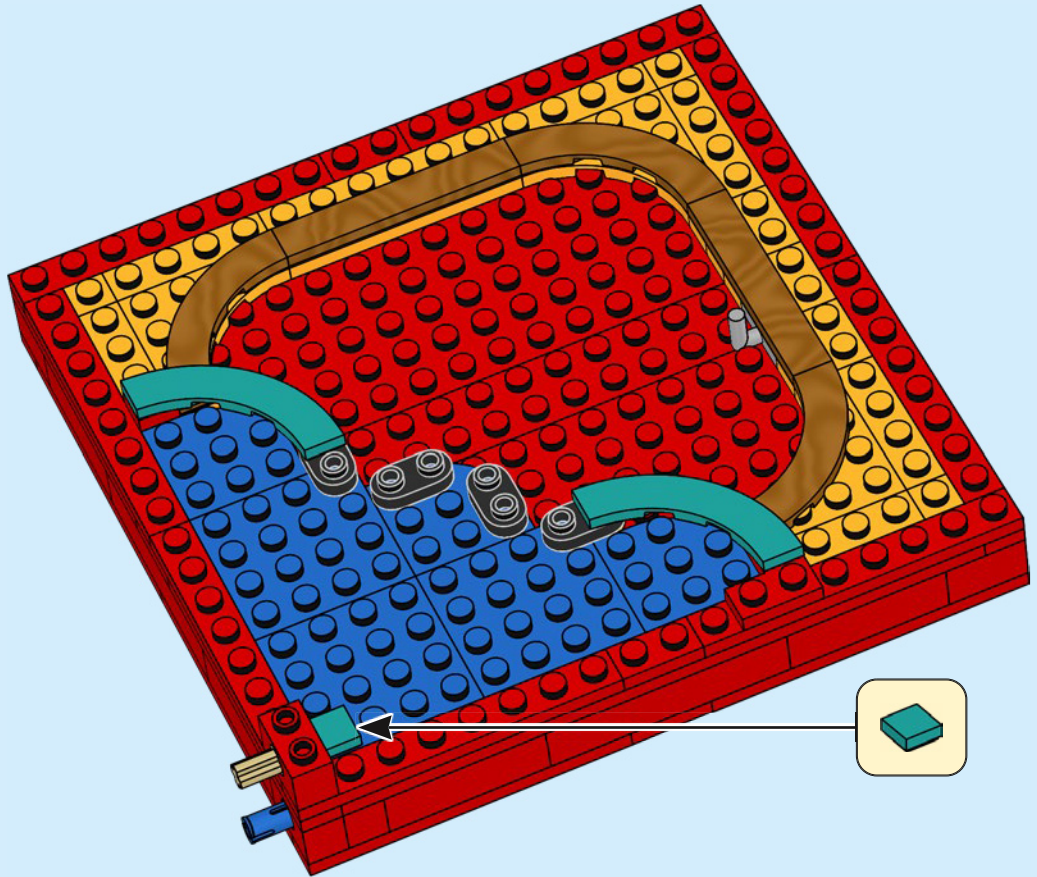

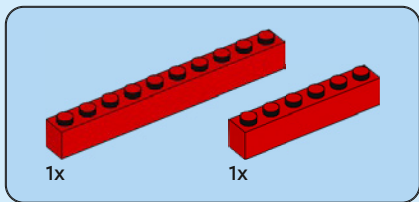

56

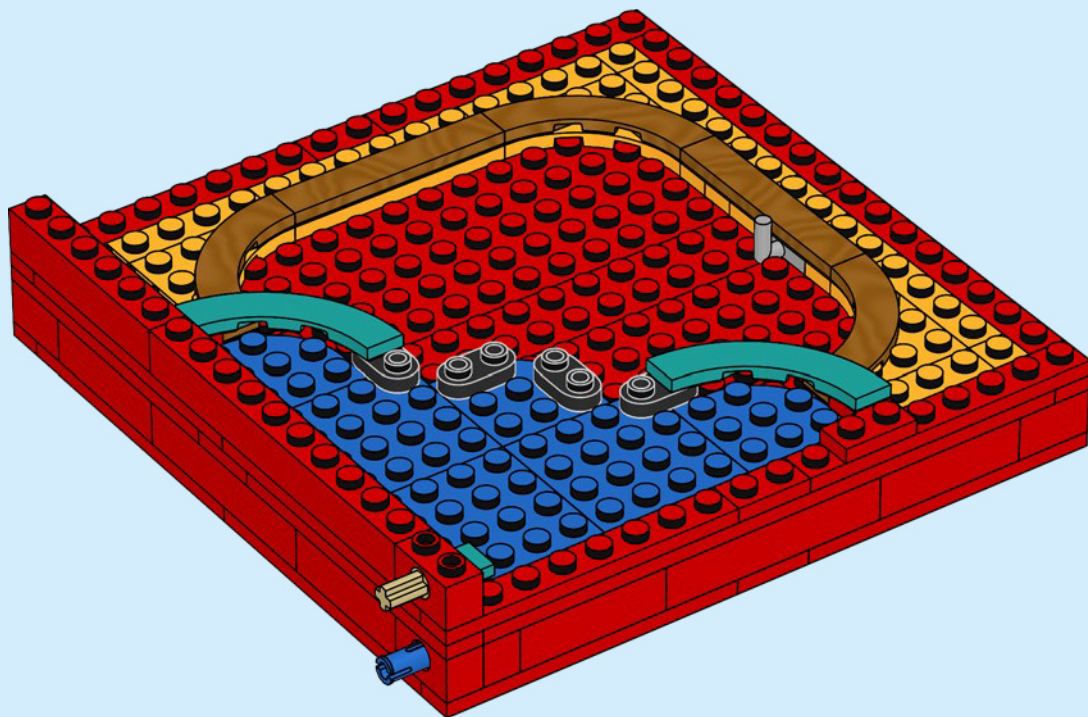

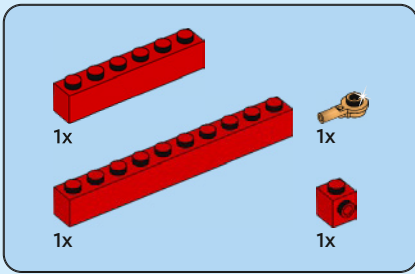

57

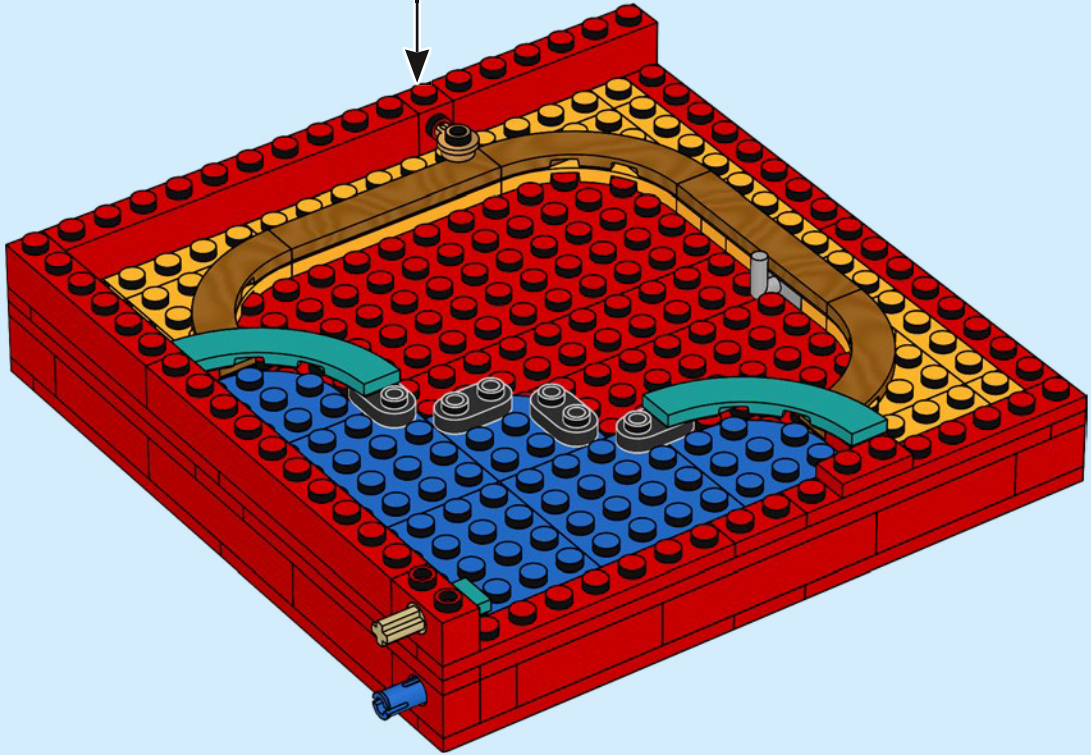
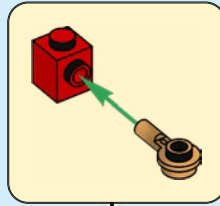

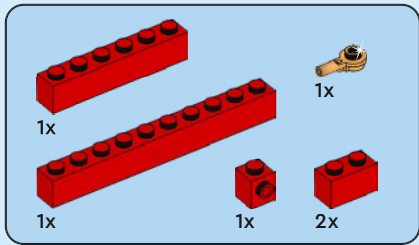

58

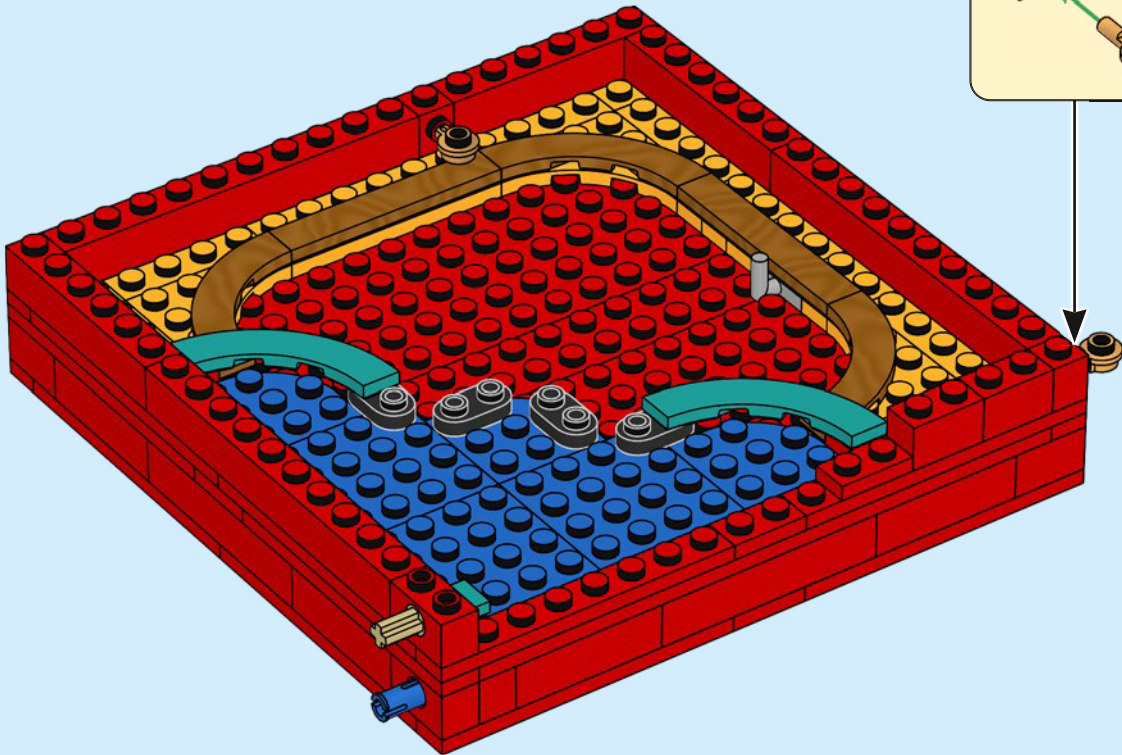
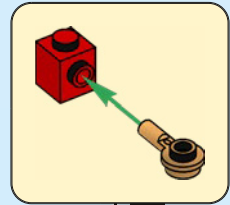

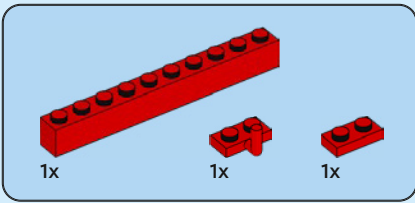

59

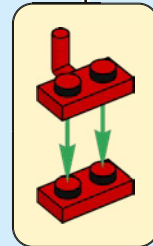
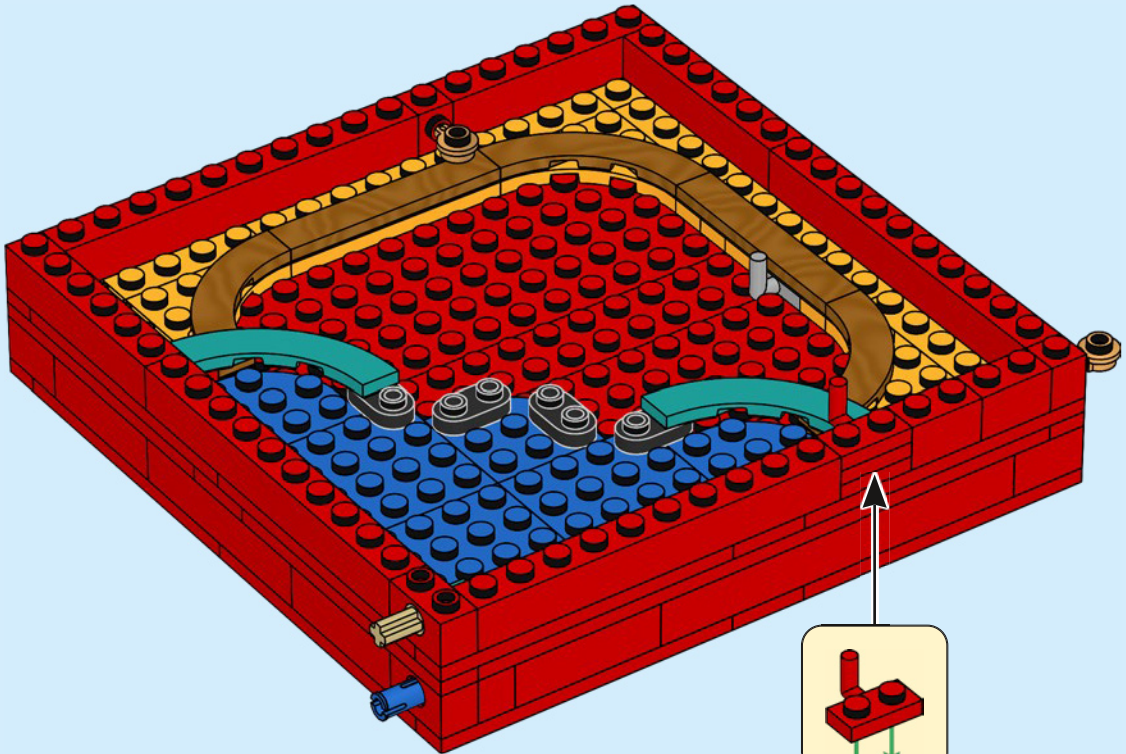

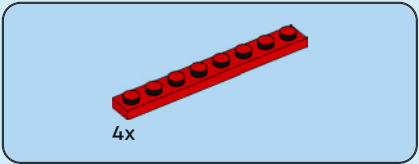

60

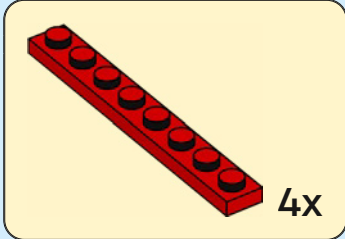
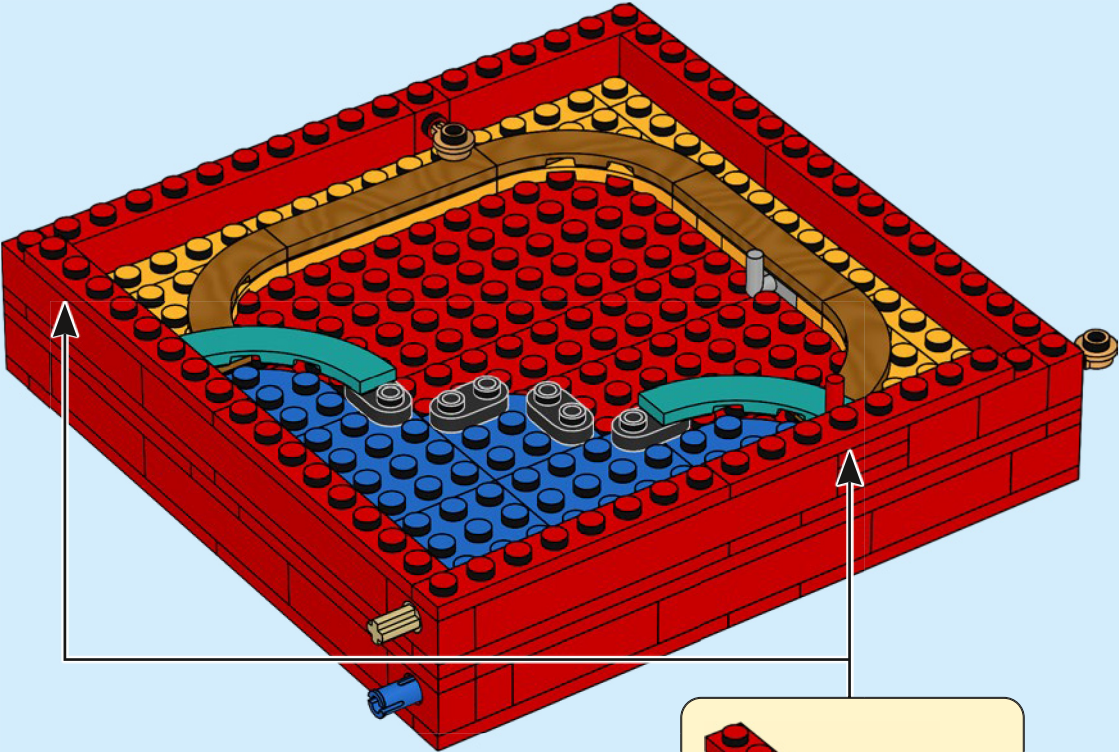

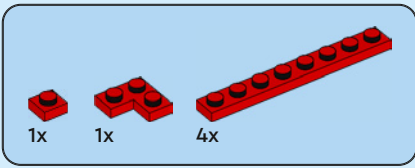

61

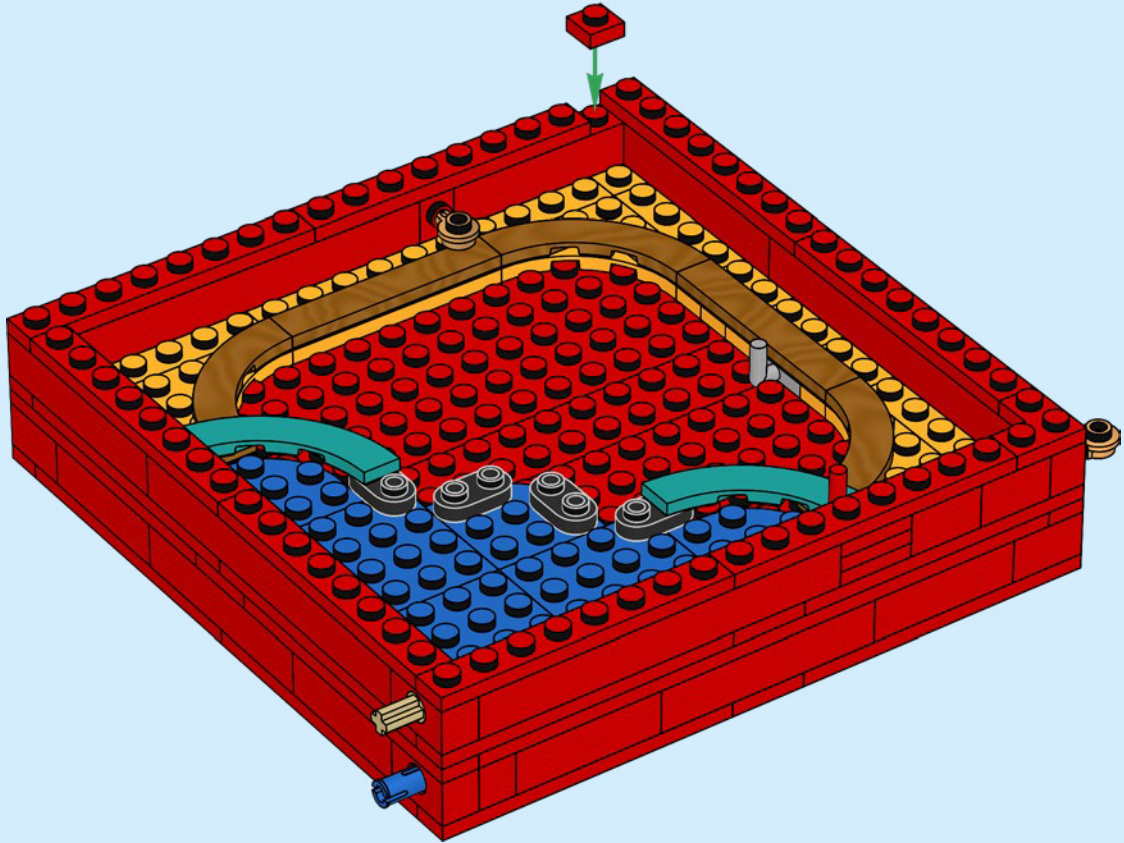



24x

62

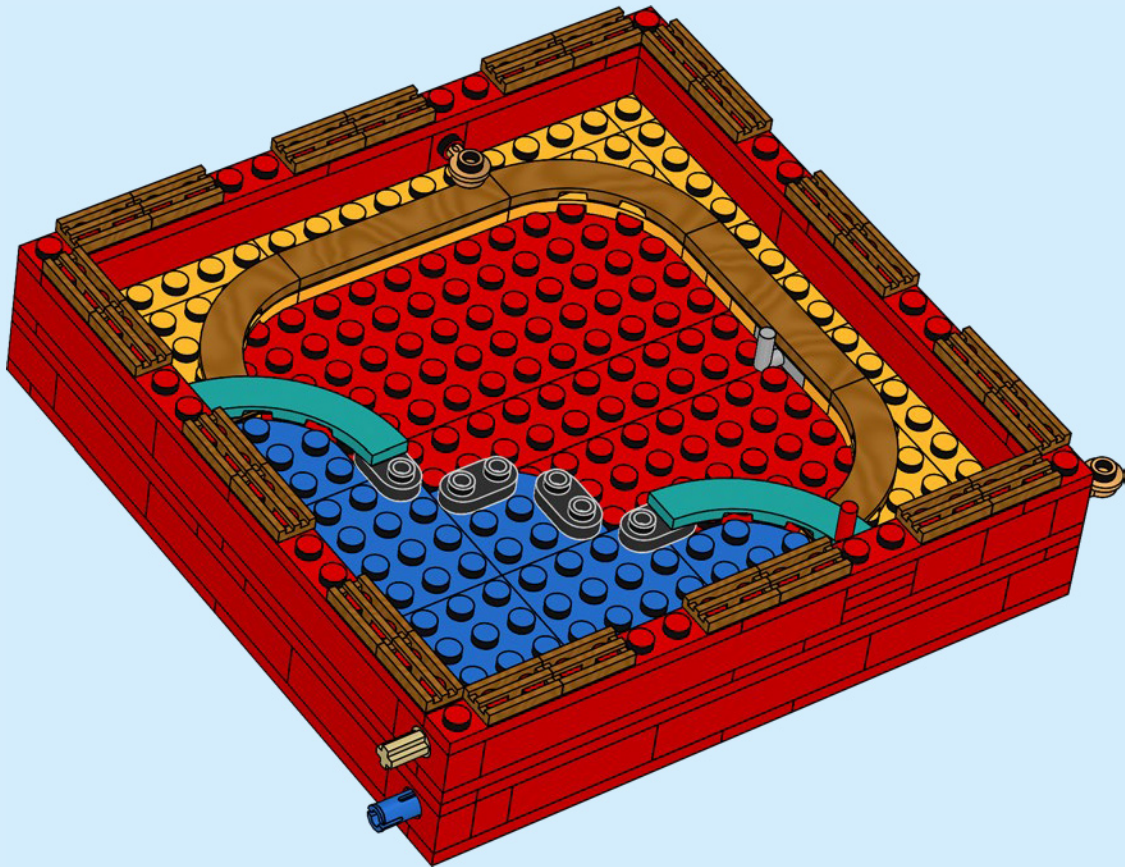





20x

63

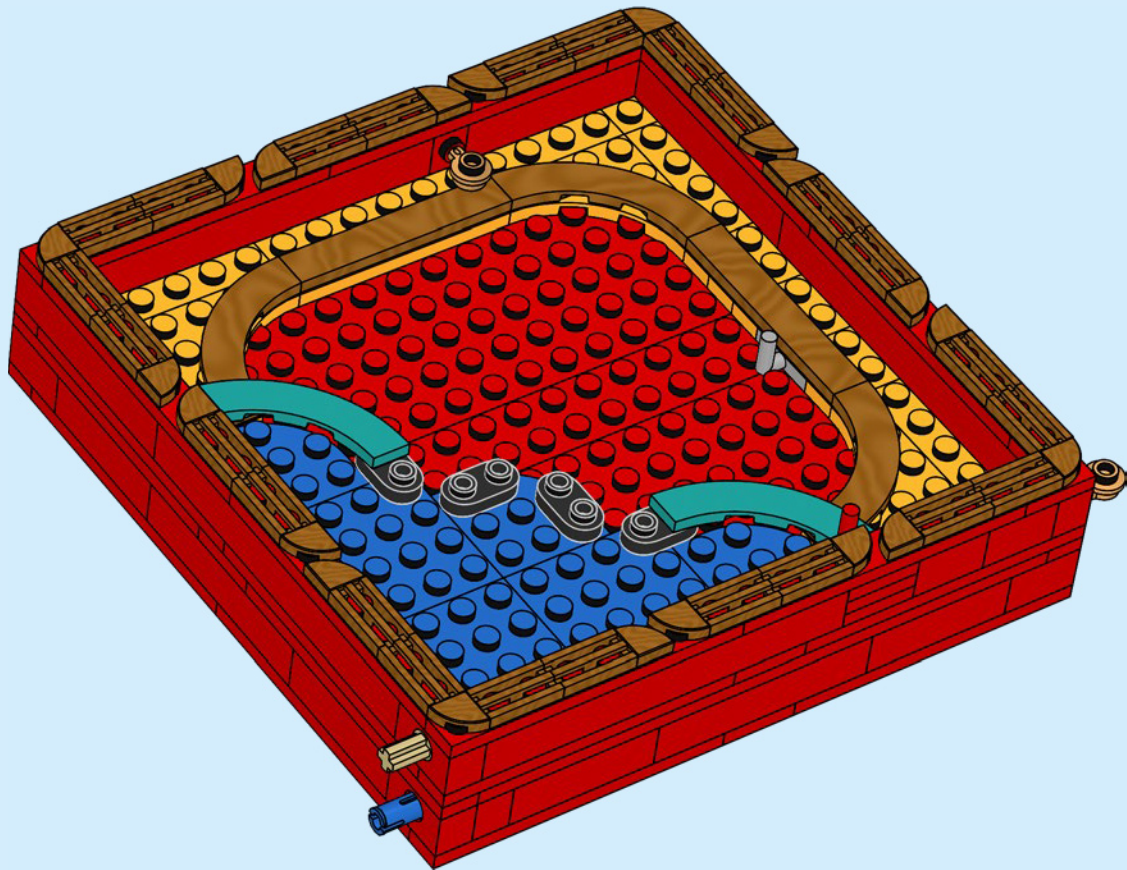





1x



1x

64

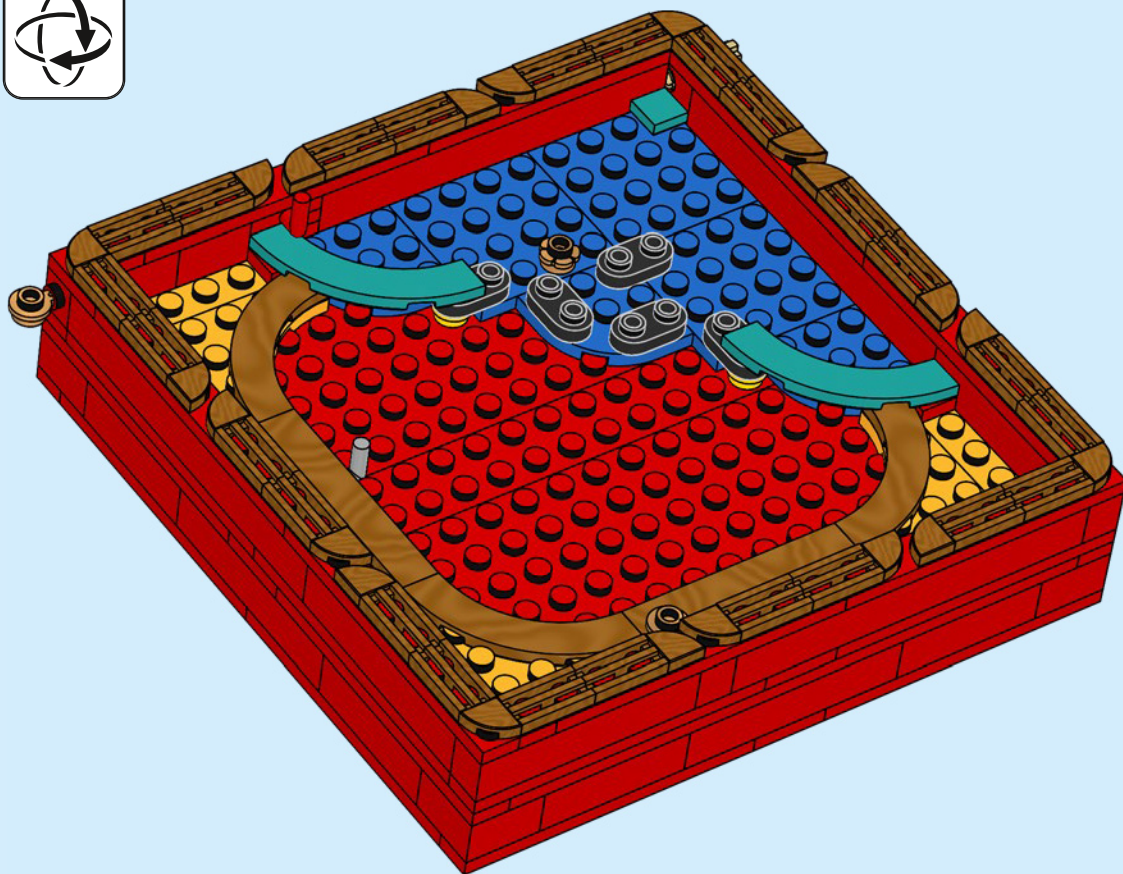





1x



2x

66

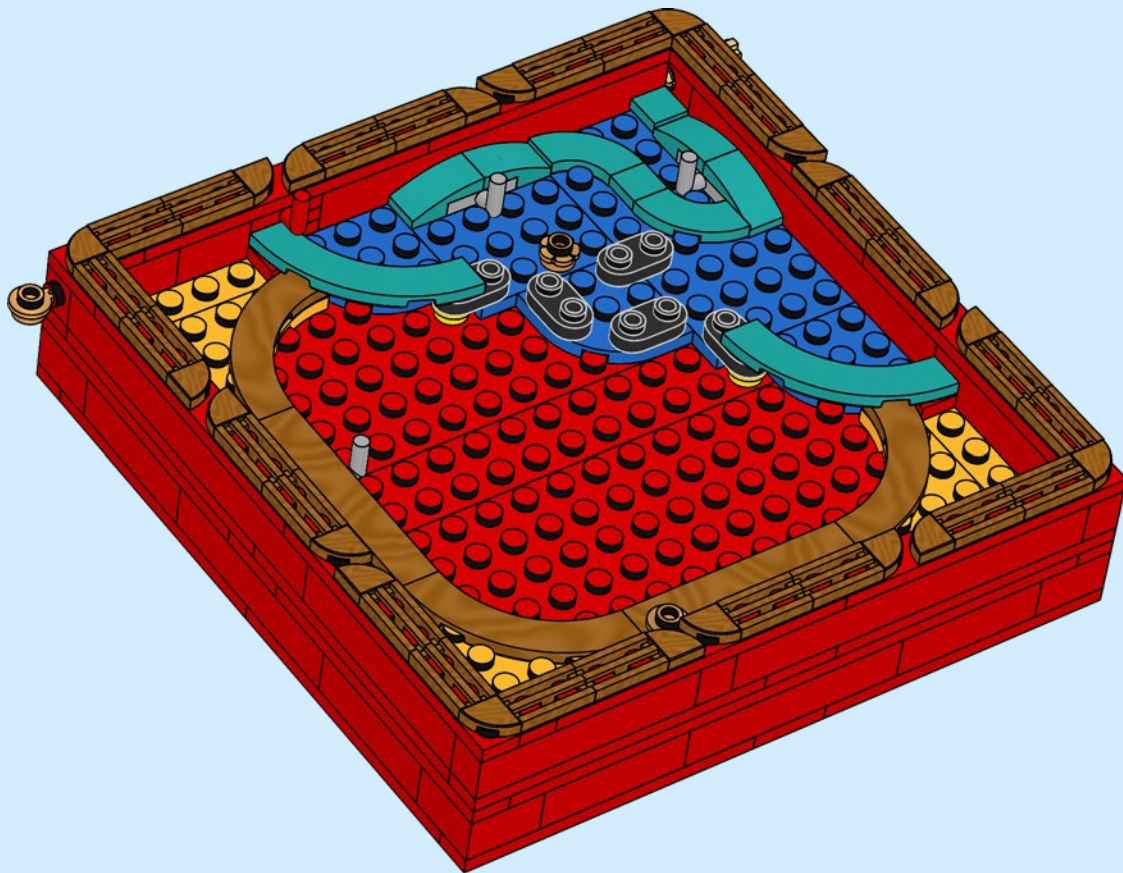



1x



1x

67

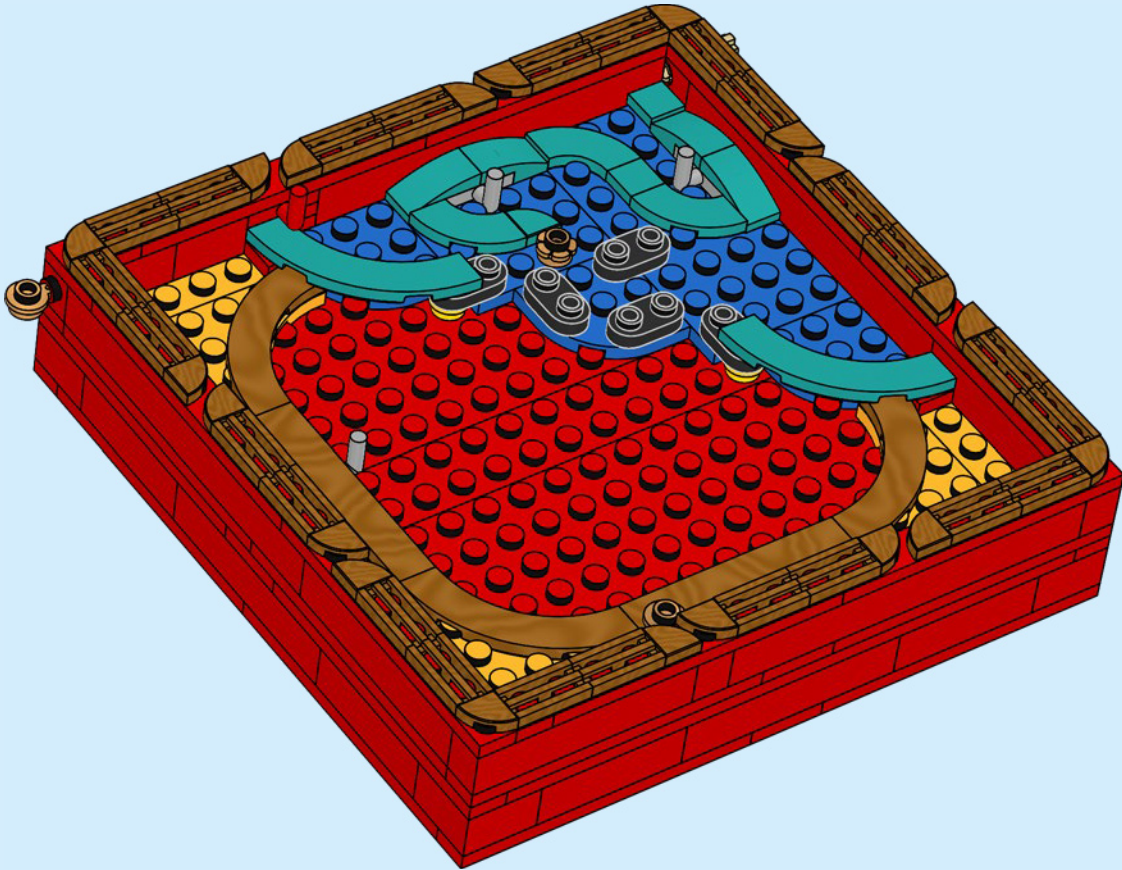

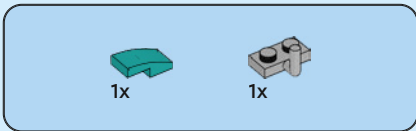

68

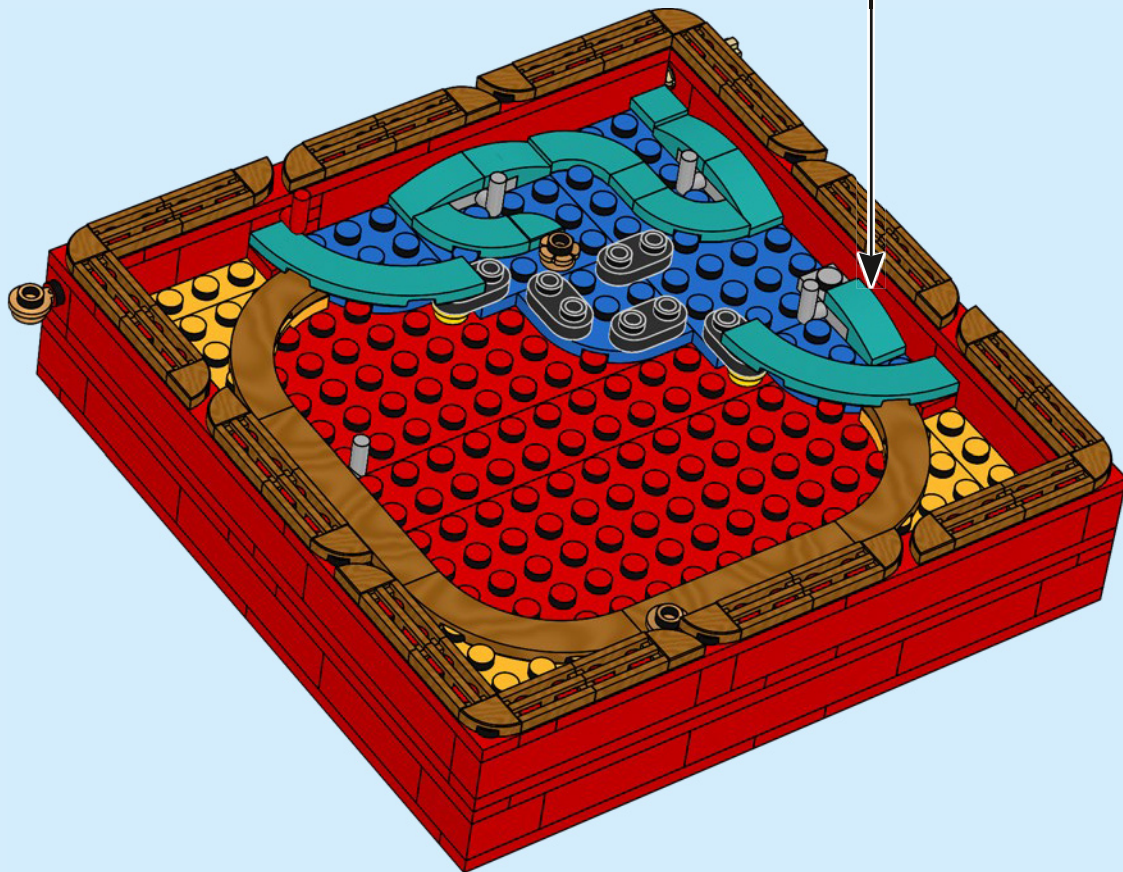
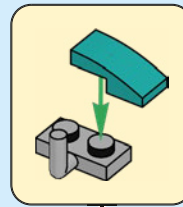

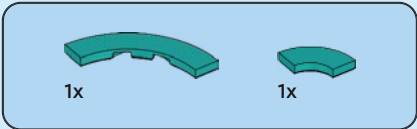

69

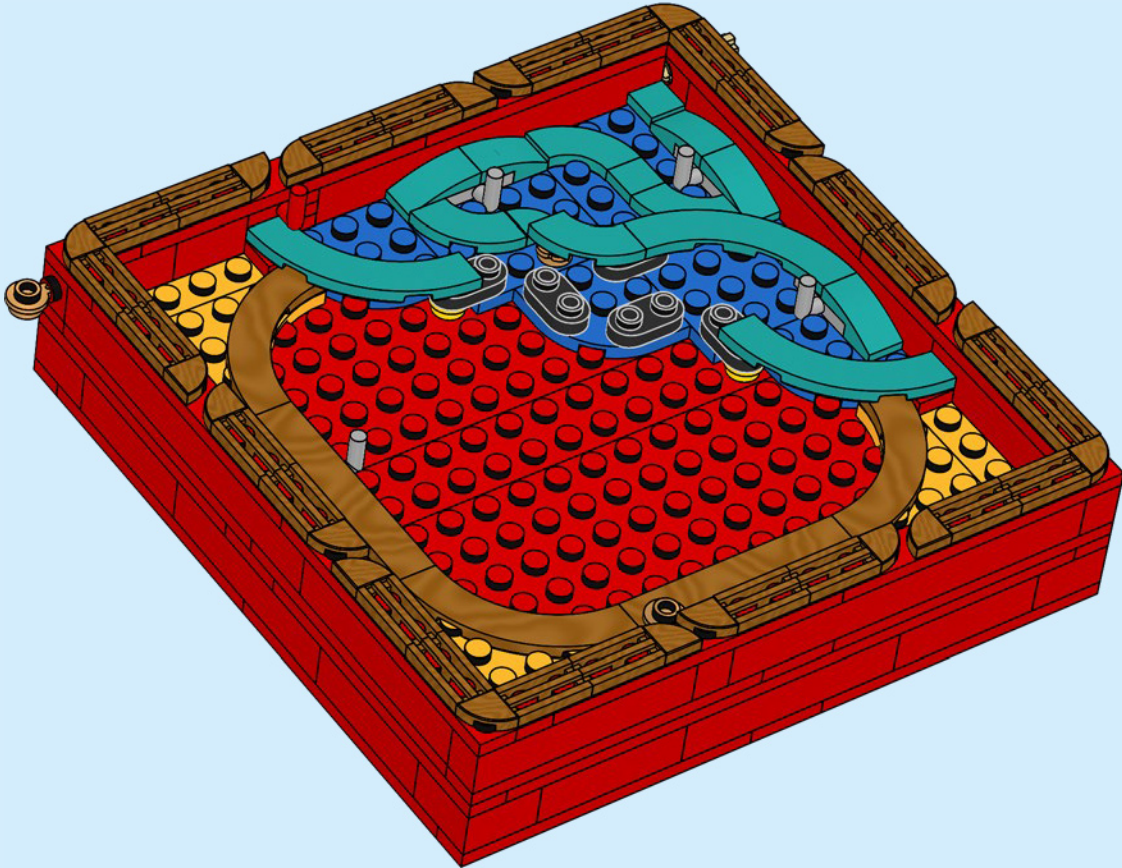





1x



2x

70

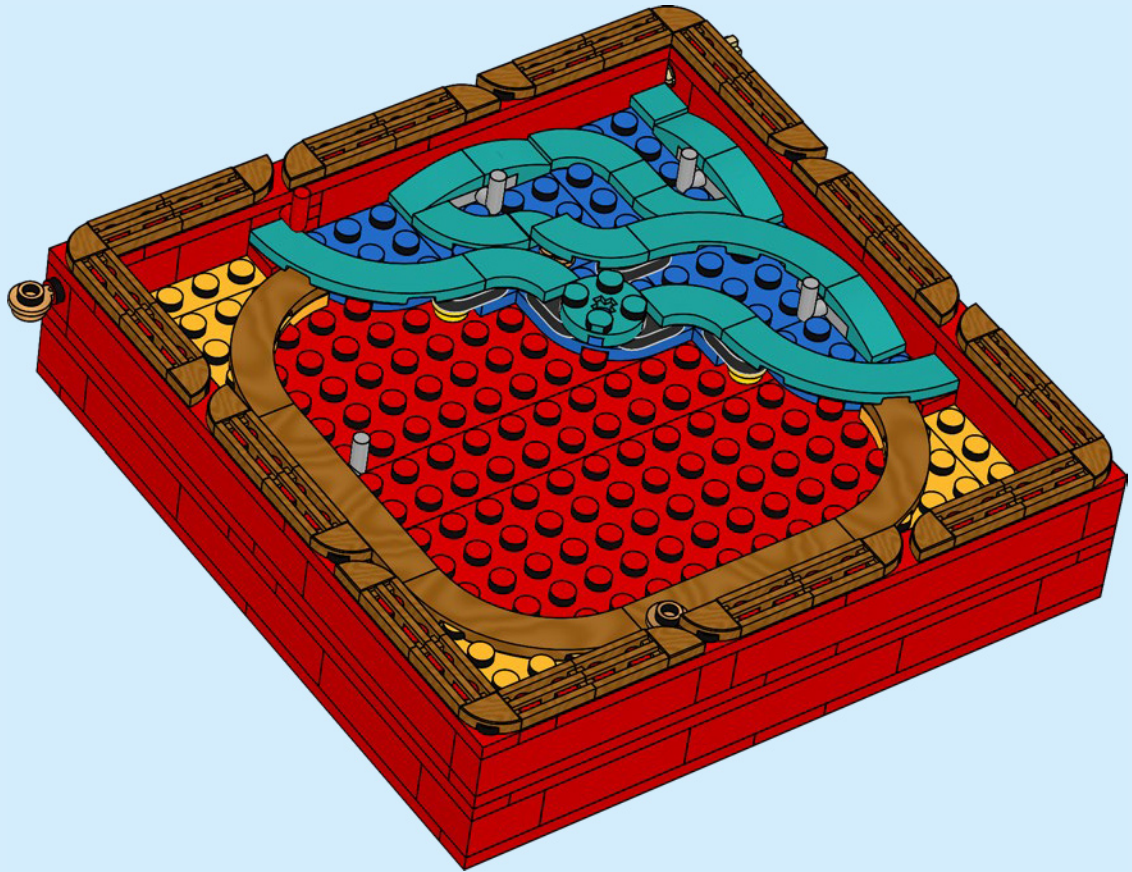



4x

71

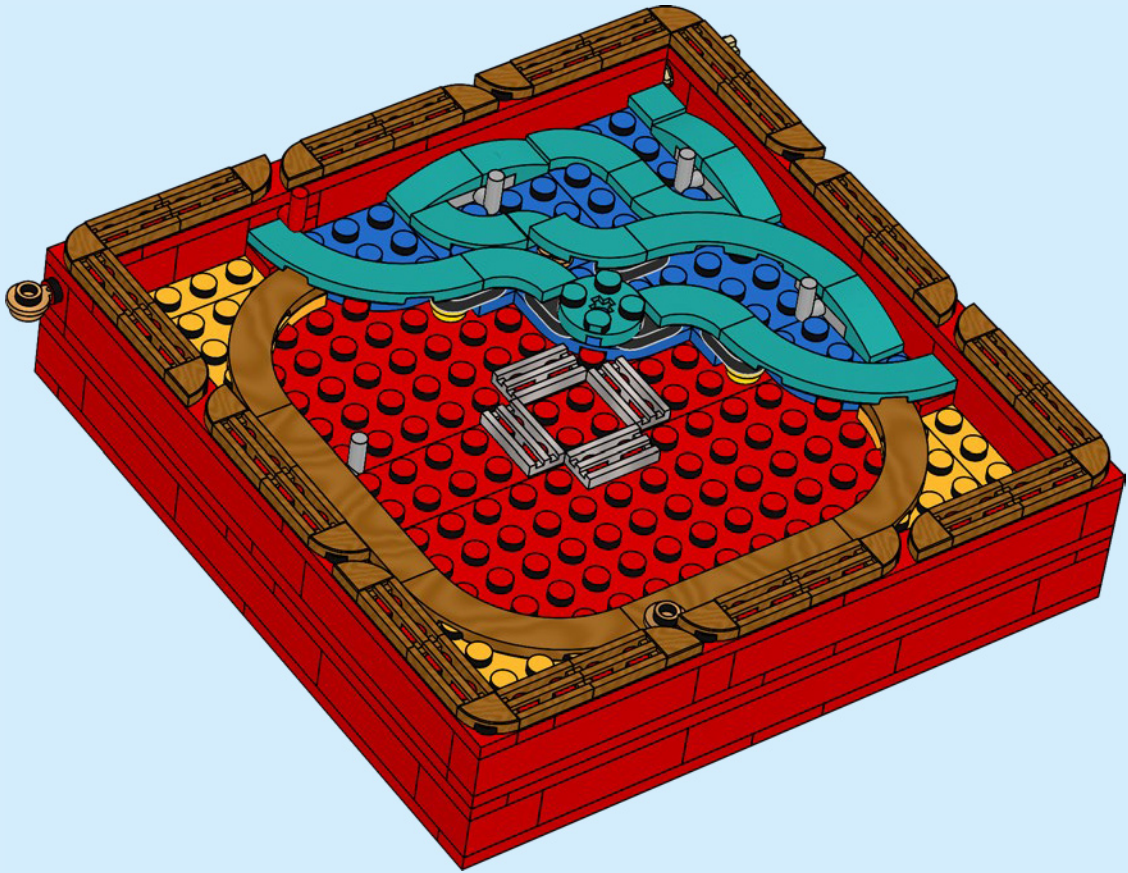



1x



3x

72

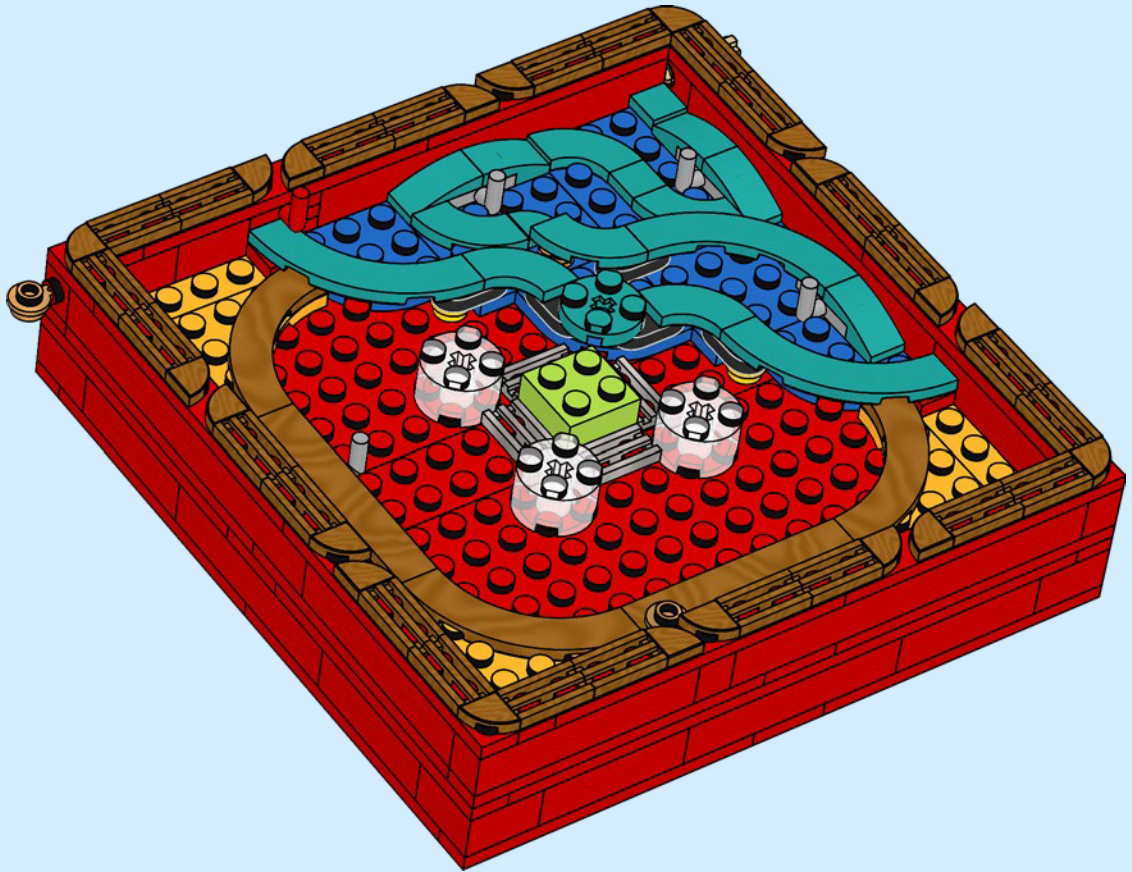



9x

73



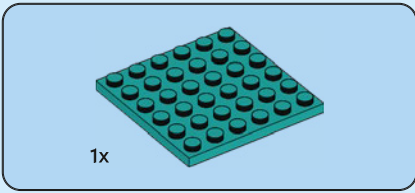

74

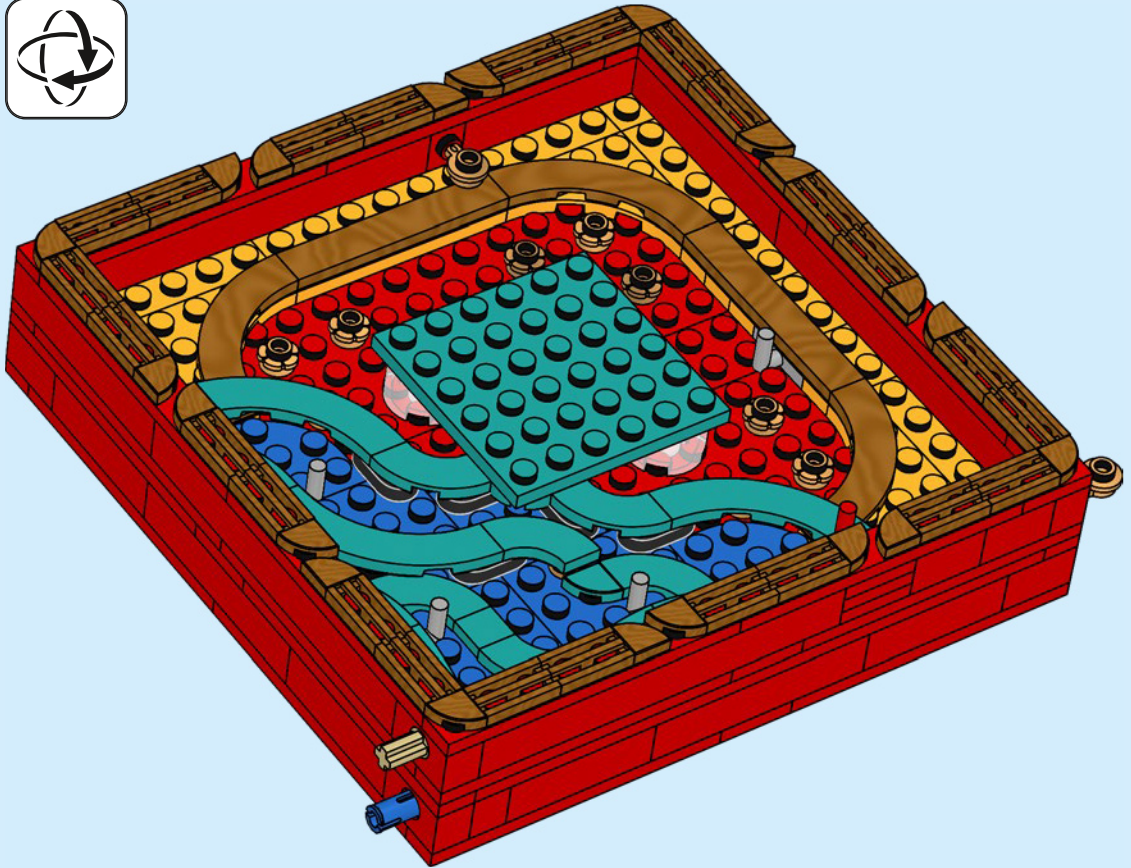



1x



2x

75

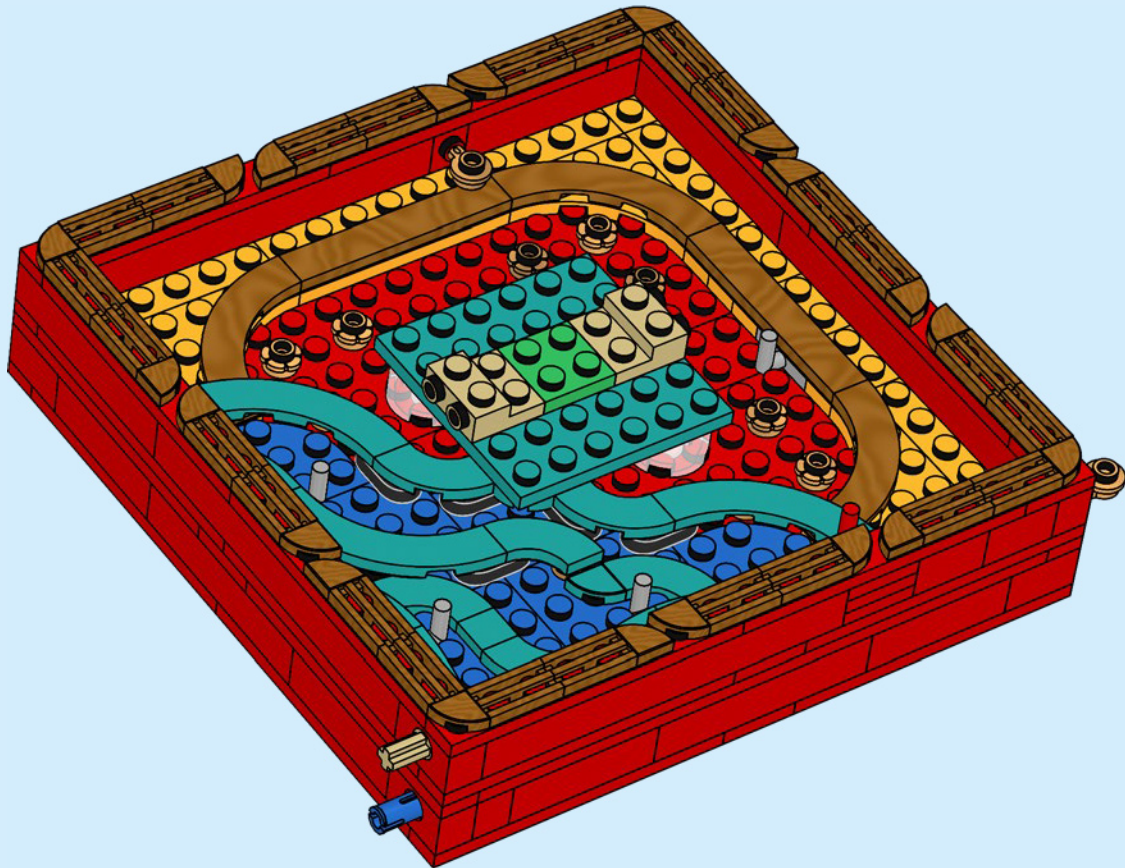

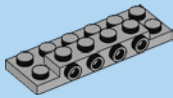

2x

76

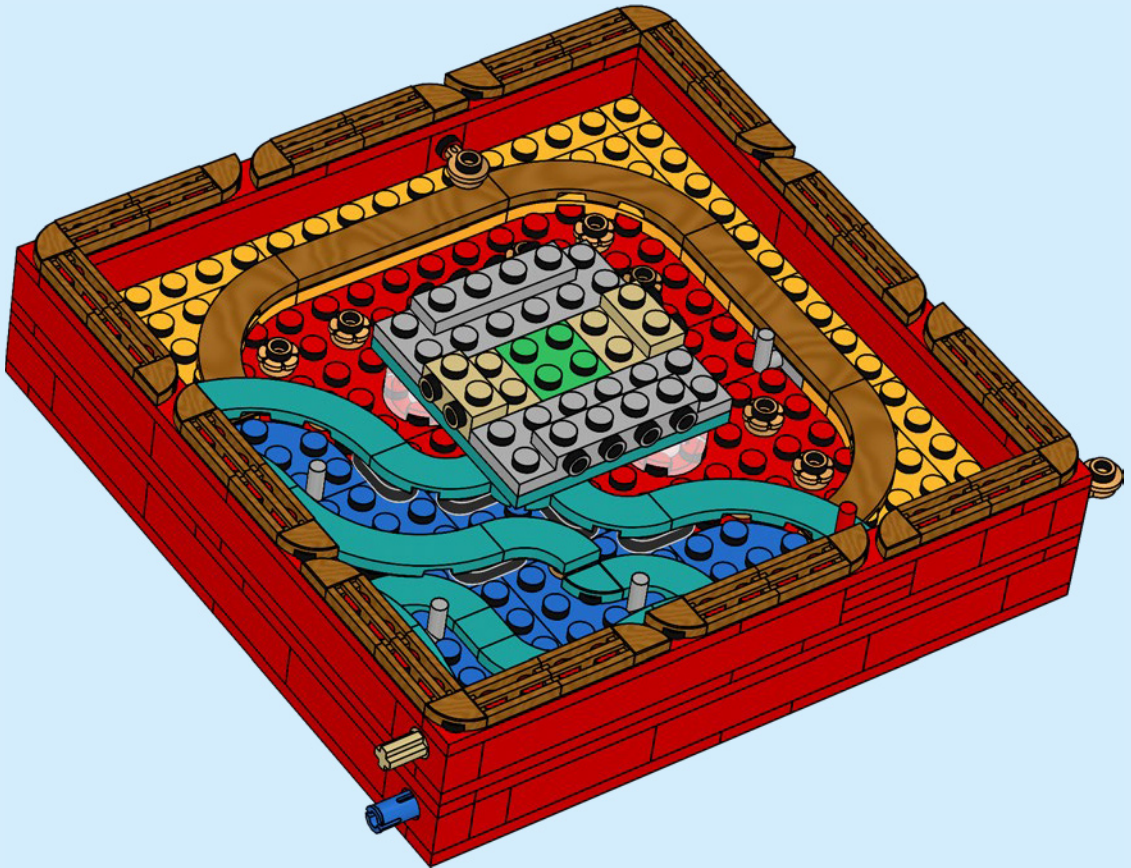

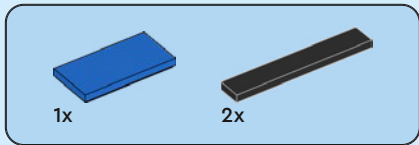

77

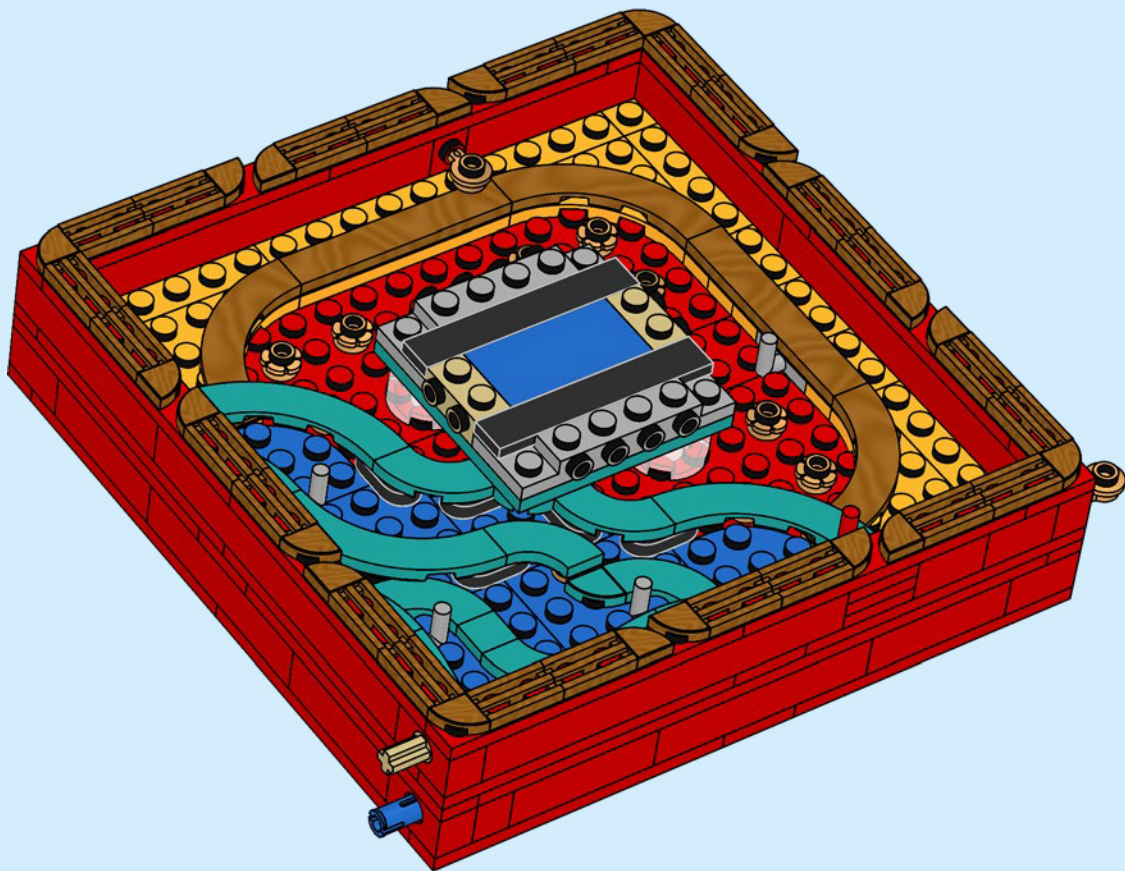



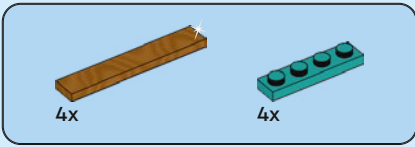

78

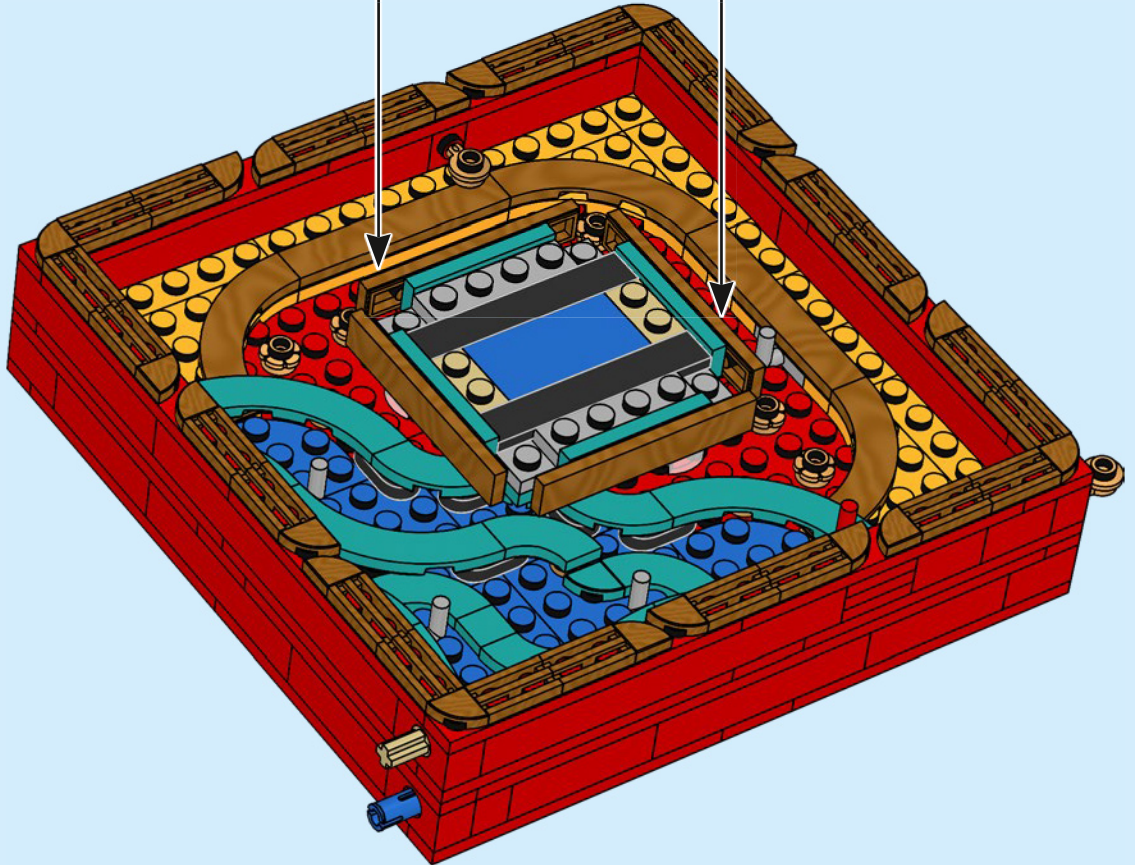
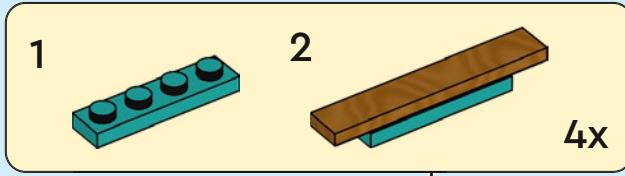



4x

79

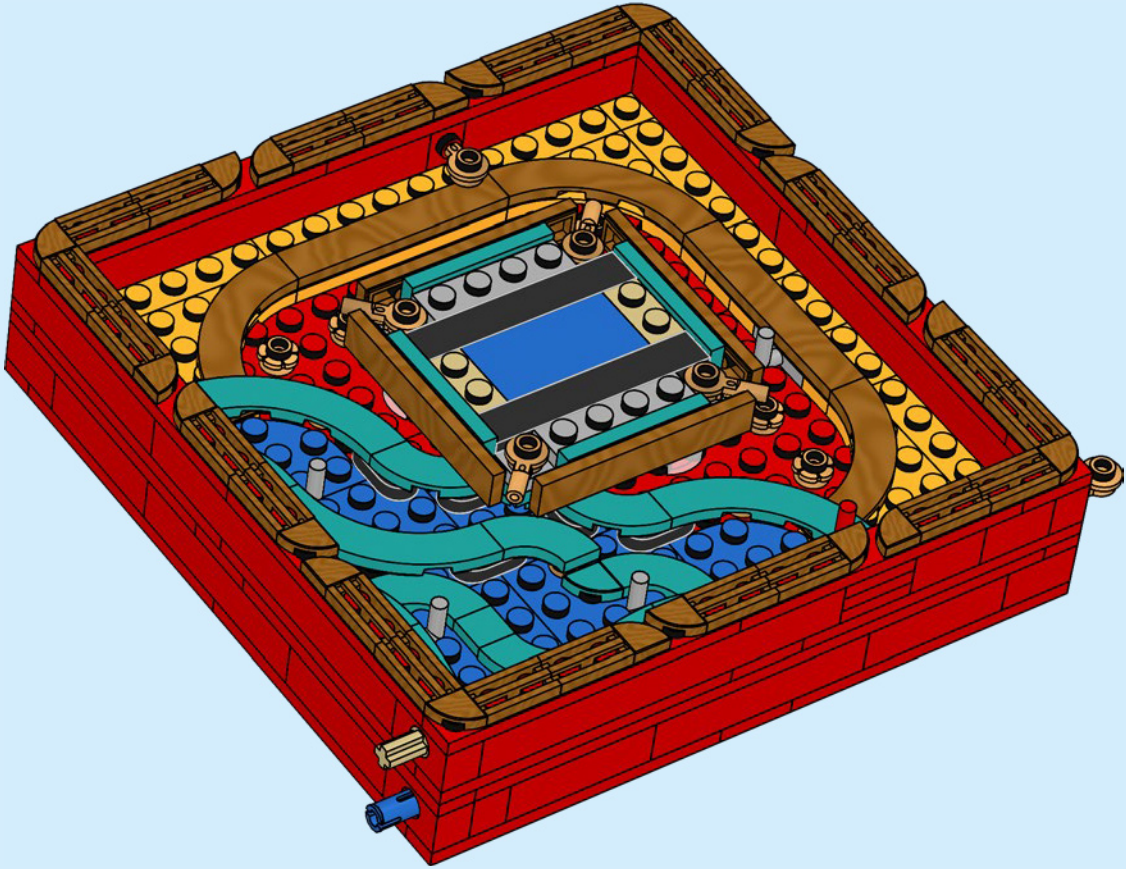

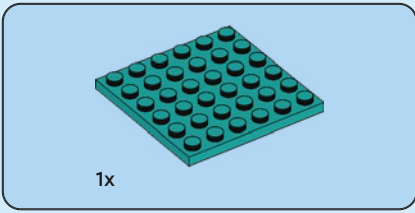

80

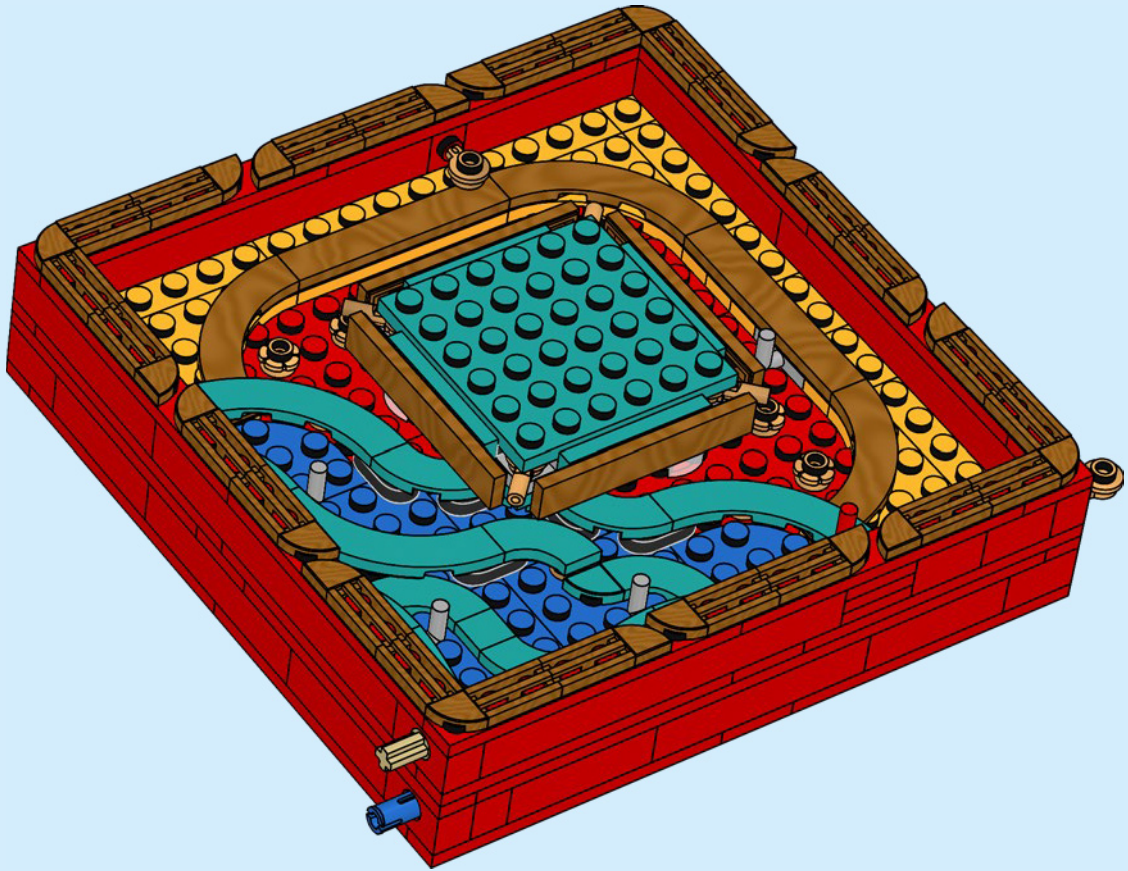



81

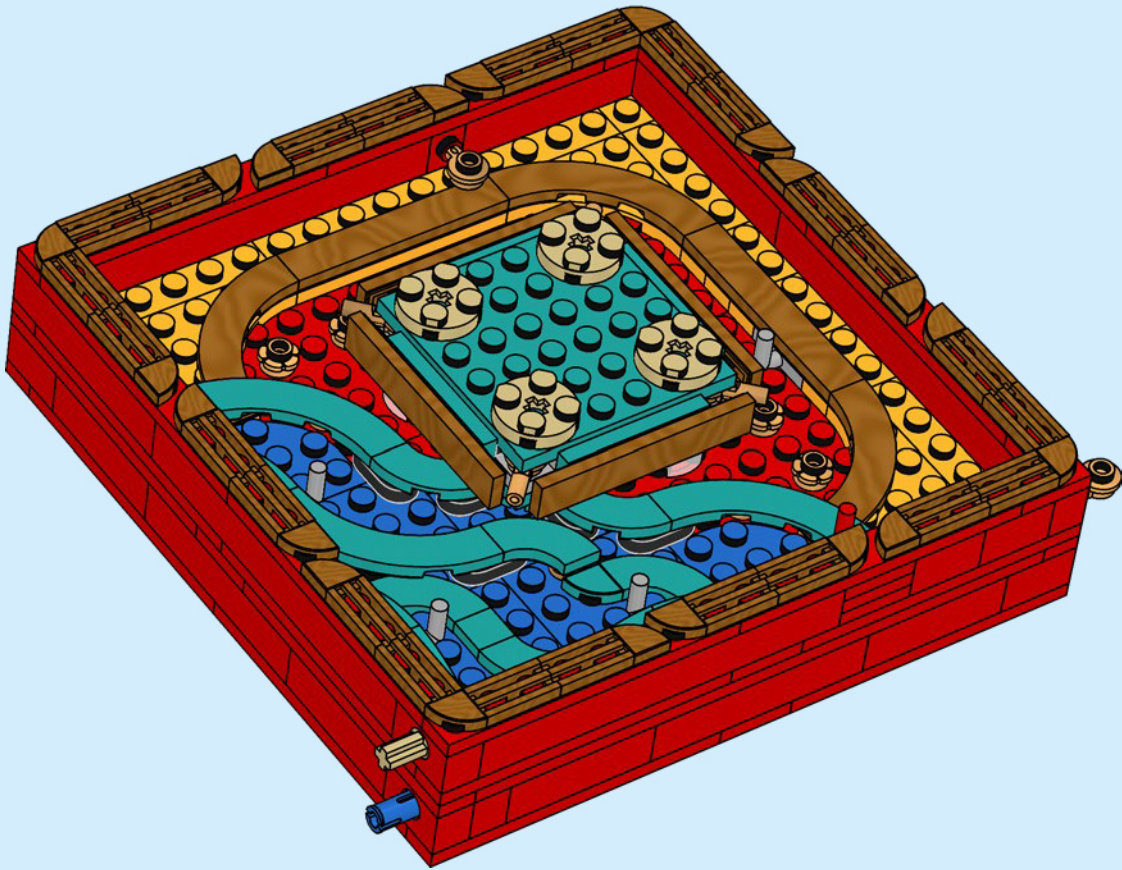



82





3x

83



3x



2x



1x



1x

84

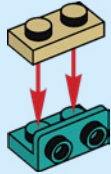

1x

85

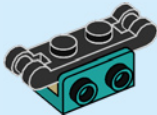

1x

86

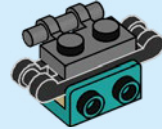

2x

87

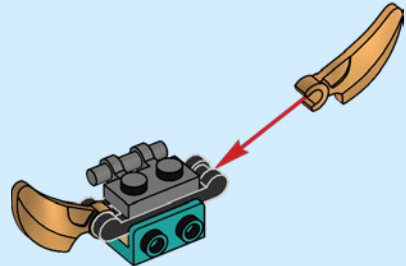

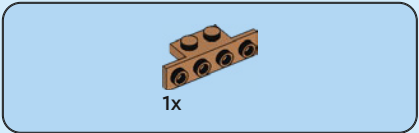

88

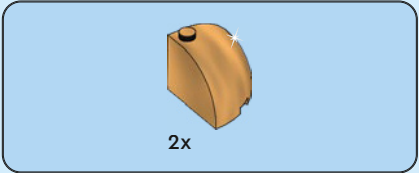
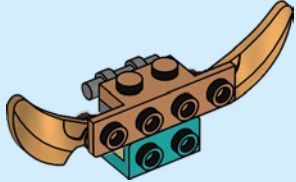

89

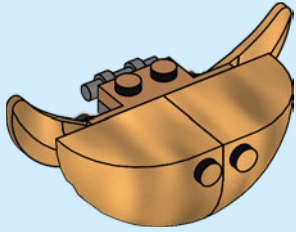

90

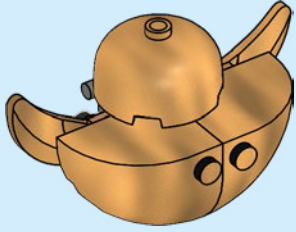

2x



91



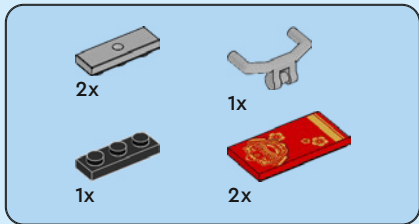

92

1

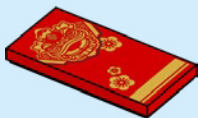

2

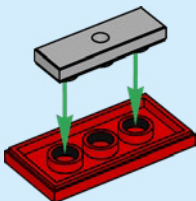

3

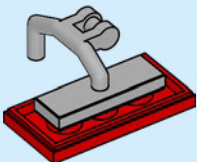

1

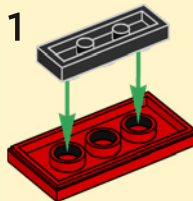

2

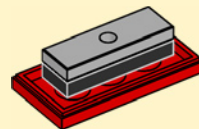

4

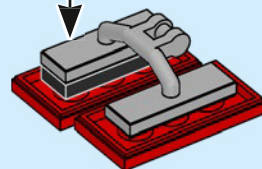

5





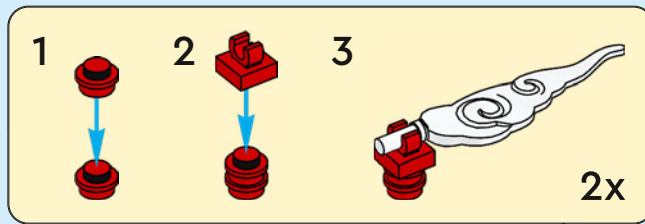
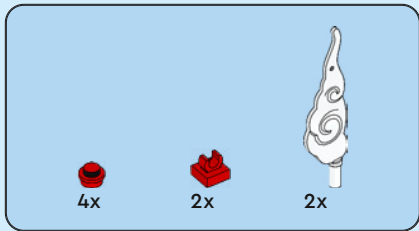

93

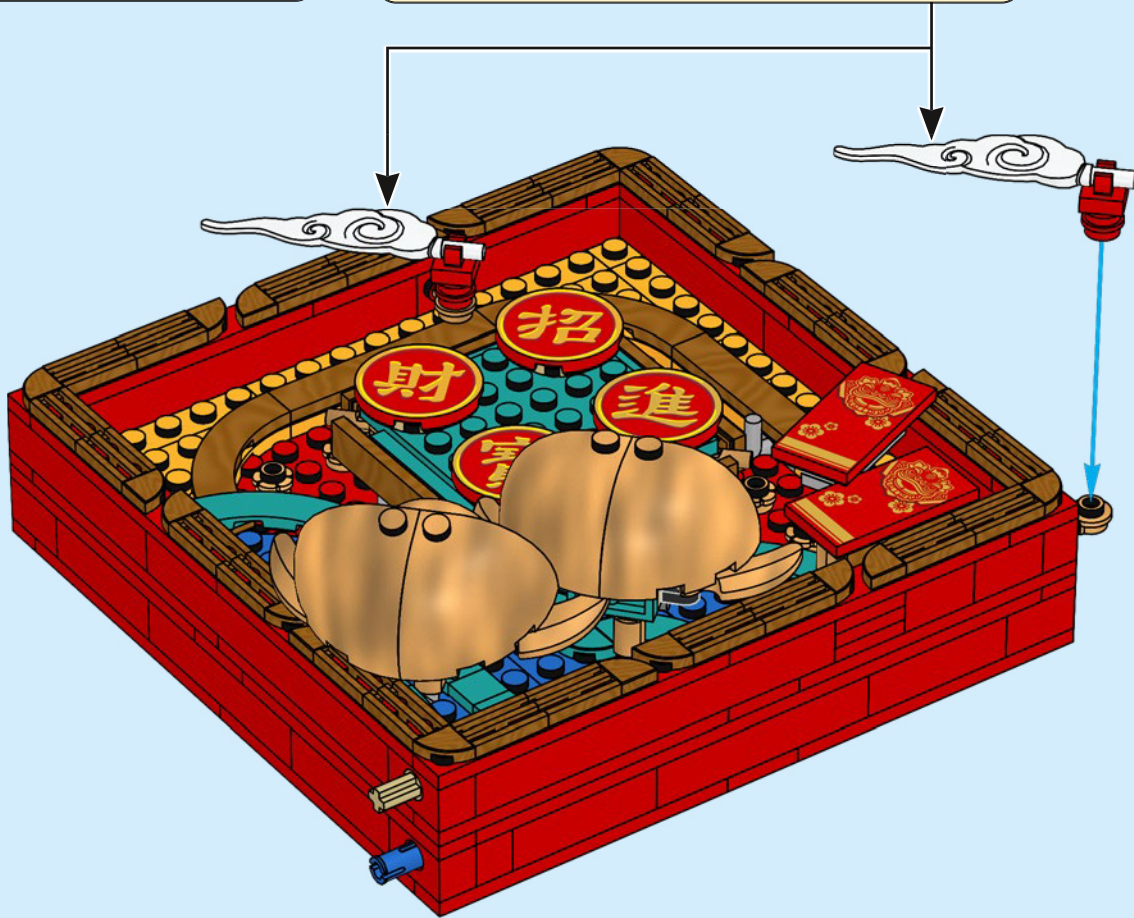





2x

94



2x

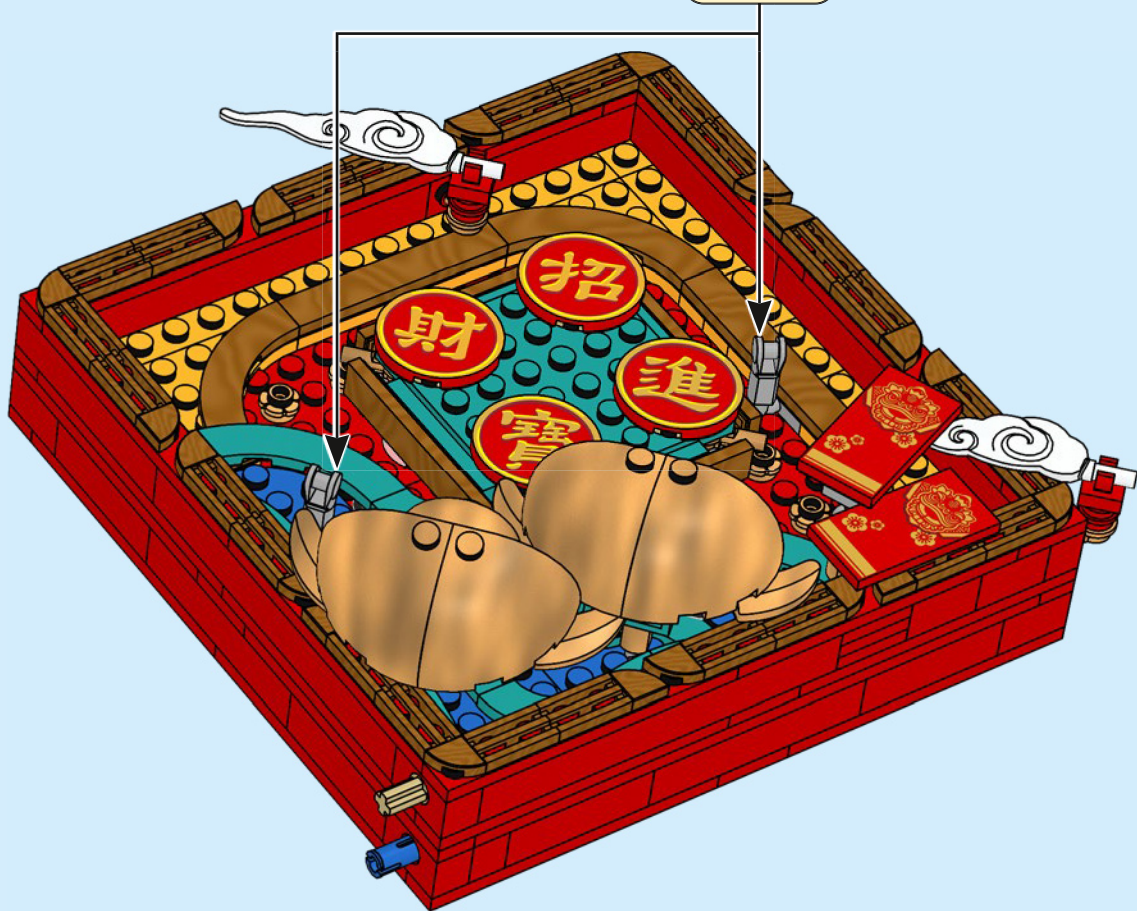

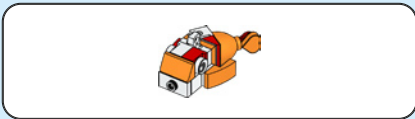

95

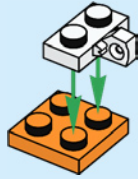

96

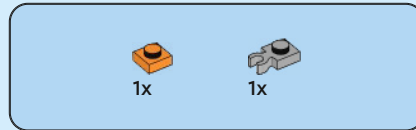

97

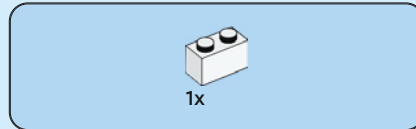

98

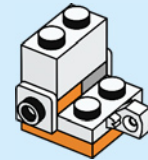



99

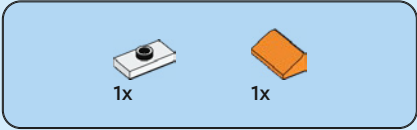
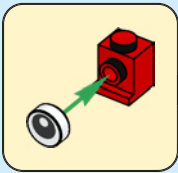
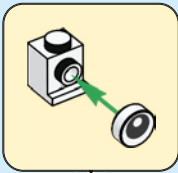

100

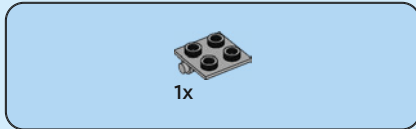
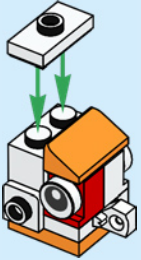

101

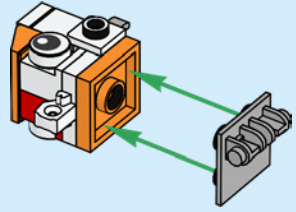



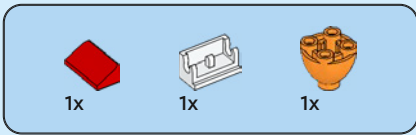

102

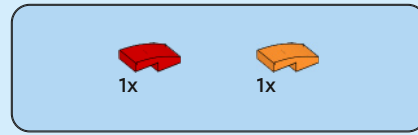
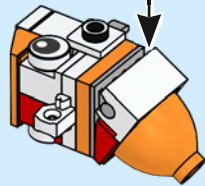
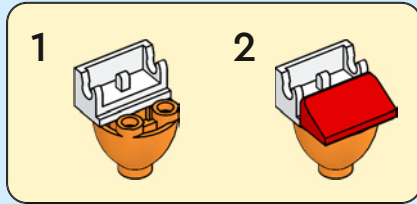

103

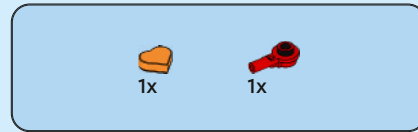
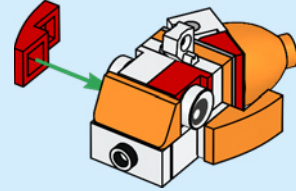

104

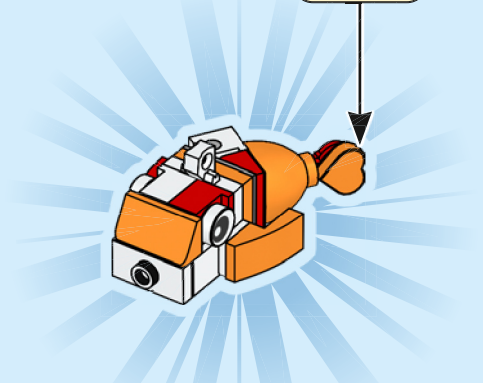
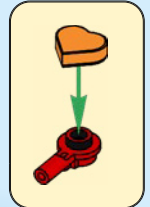

105



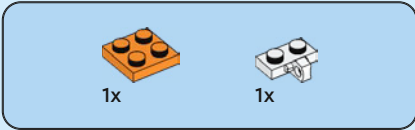
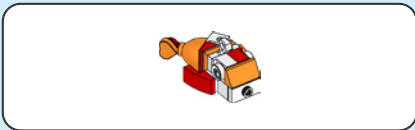

106

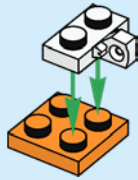

107

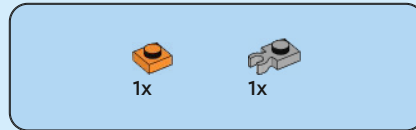

108

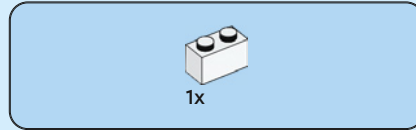
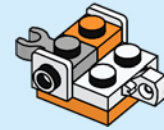

109

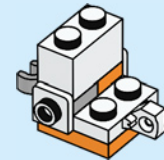

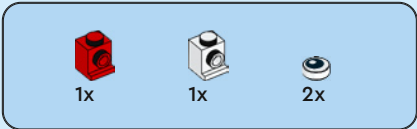

110

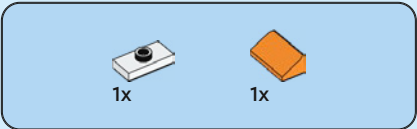
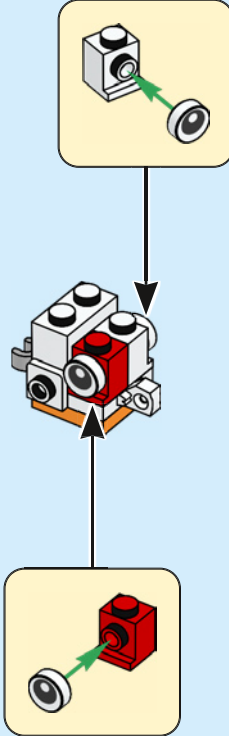

111

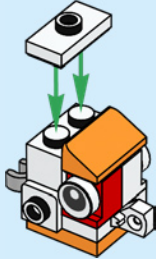

112

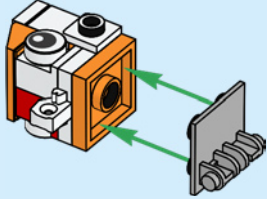

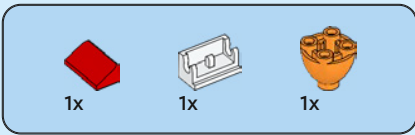

113

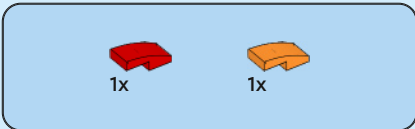
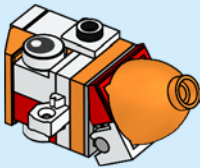
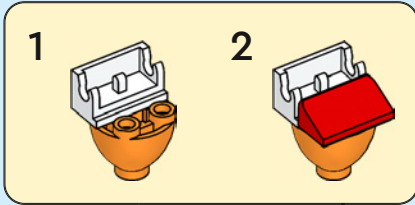

114

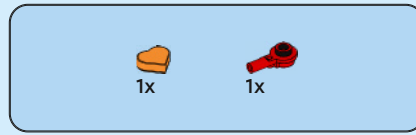
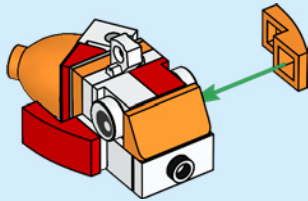
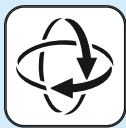

115

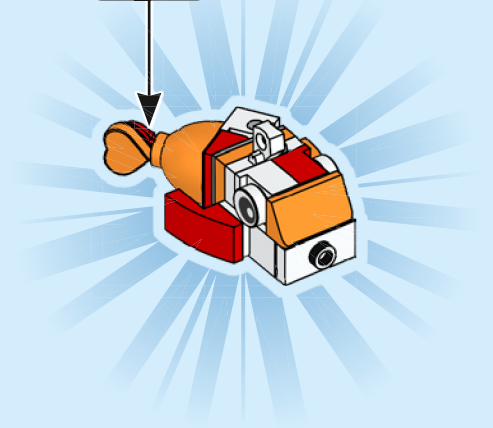
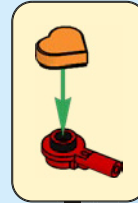

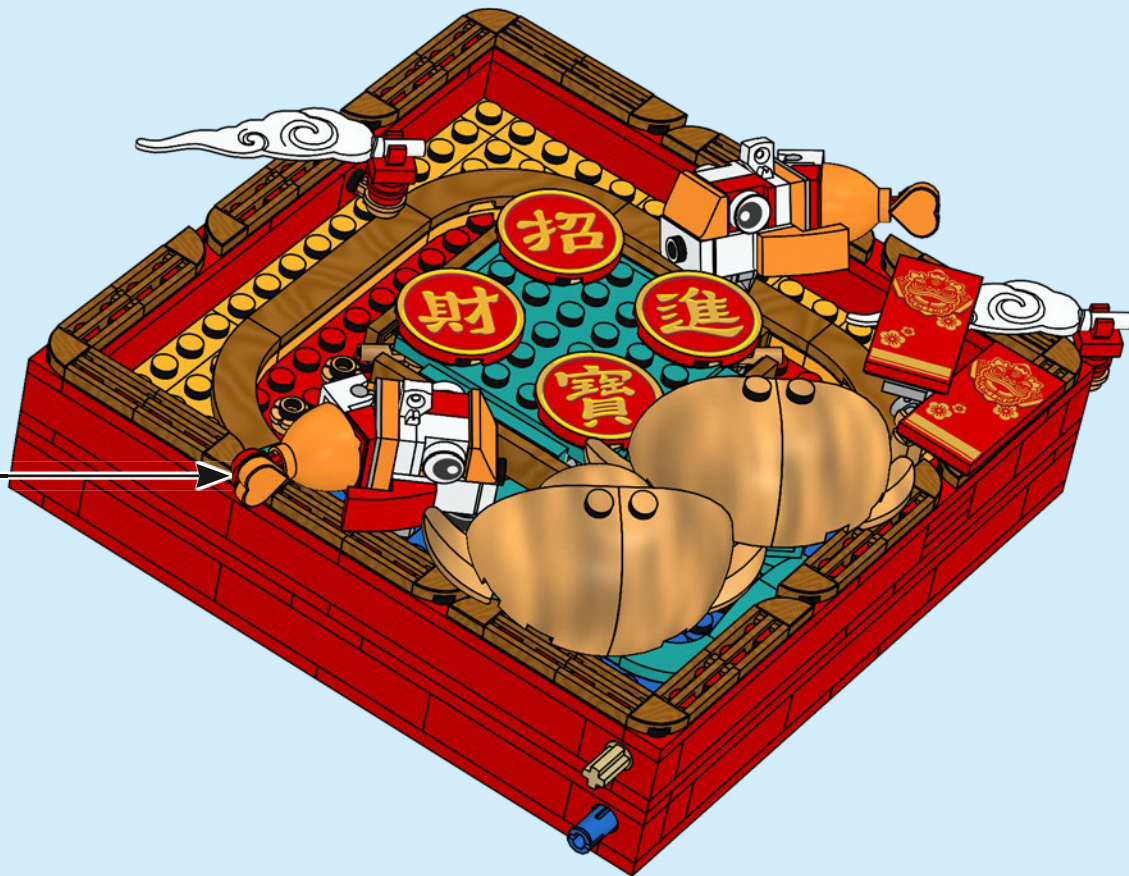

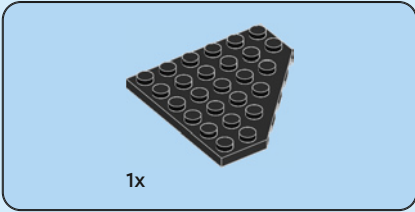
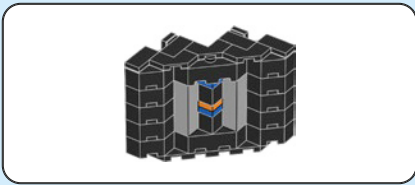

117

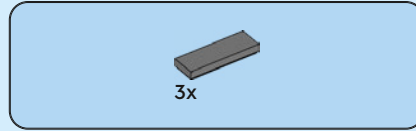
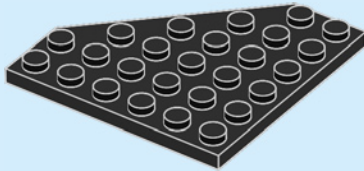

118

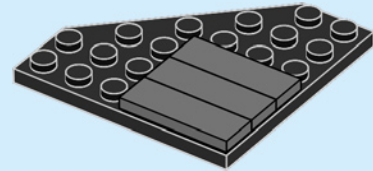



2x



2x

# 119

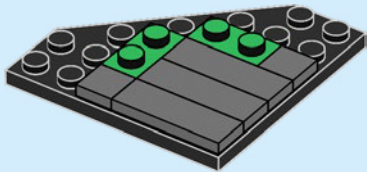

1x

# 120

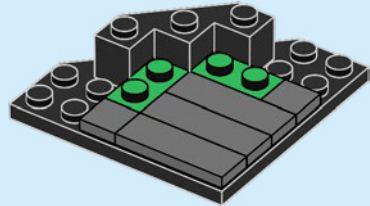





121

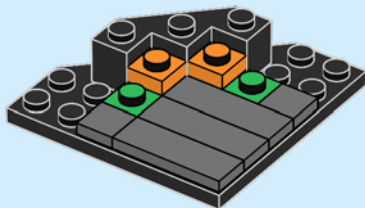

122

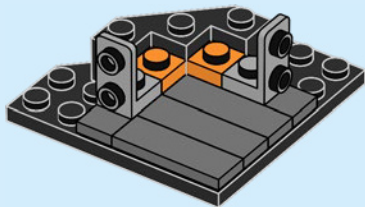

123

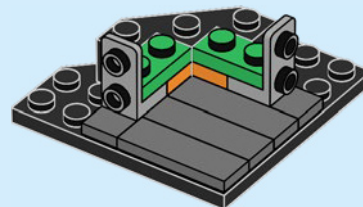

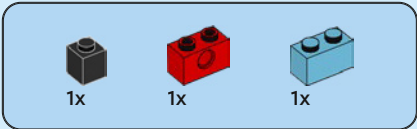

124

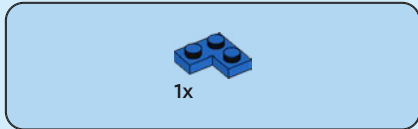
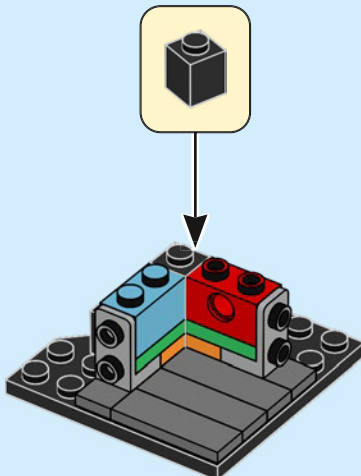

125

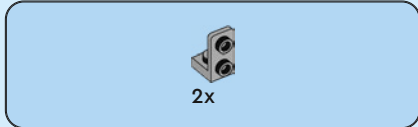
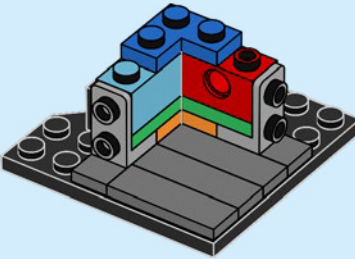

126

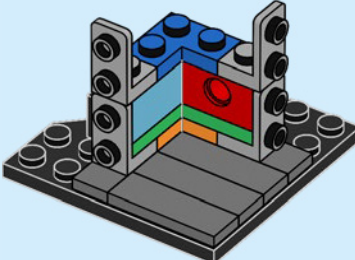



2x



1x

# 127

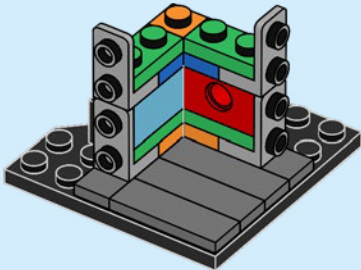

1x



1x



1x

# 128

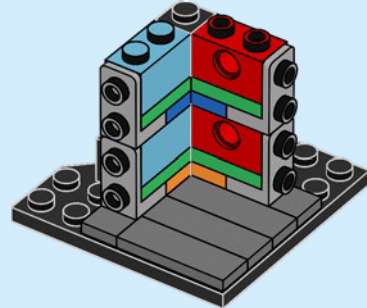



1x

129

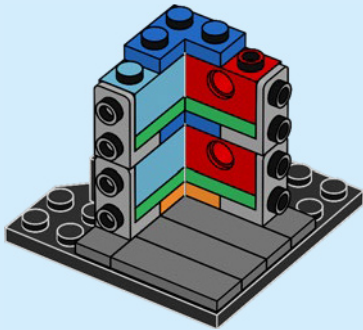

2x

130

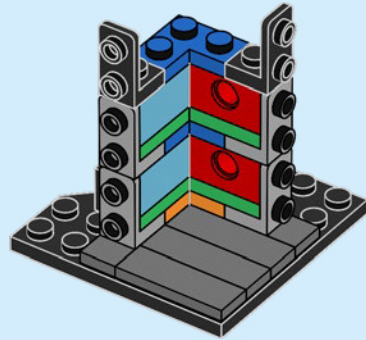



2x

131

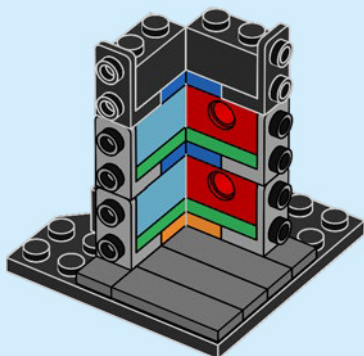

2x

132

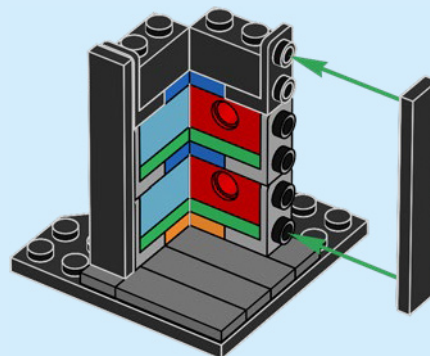

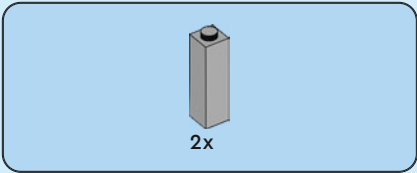

133

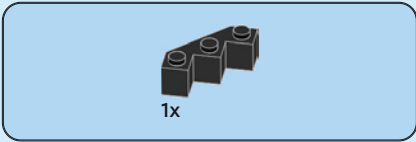
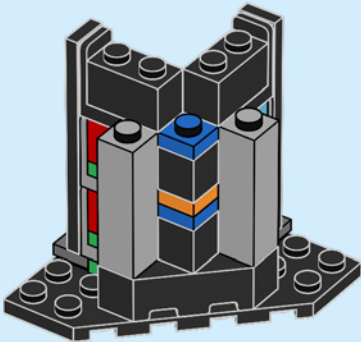

134

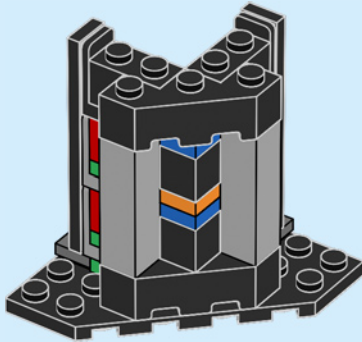



10x

135

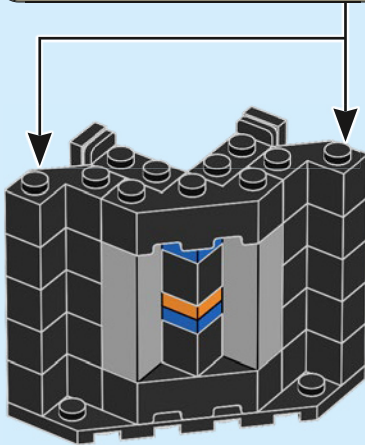
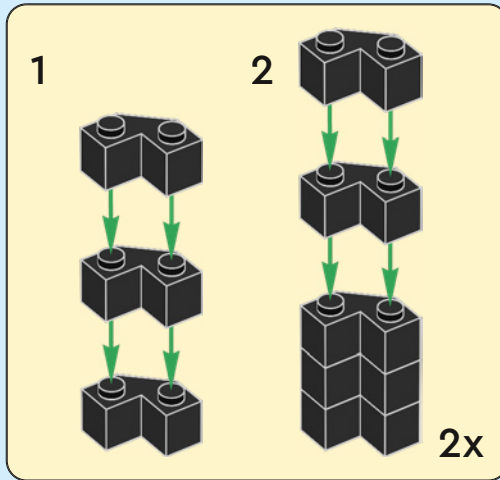

10x

136

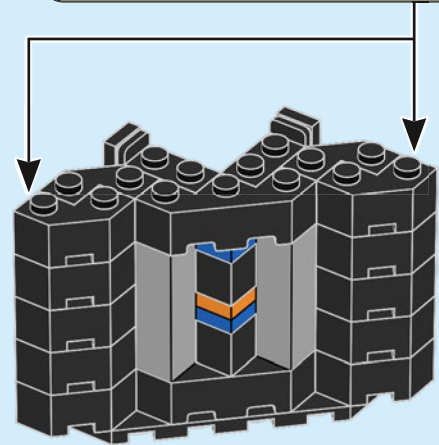
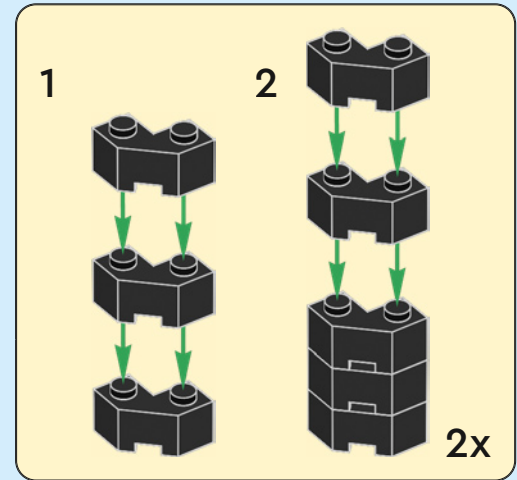



4x

137

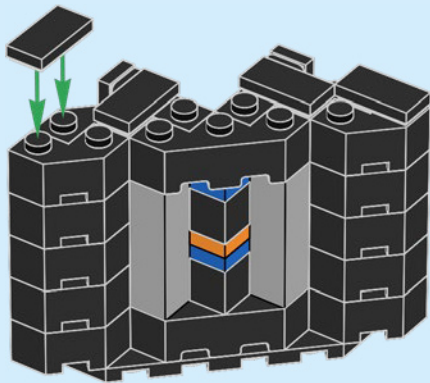

3x

138

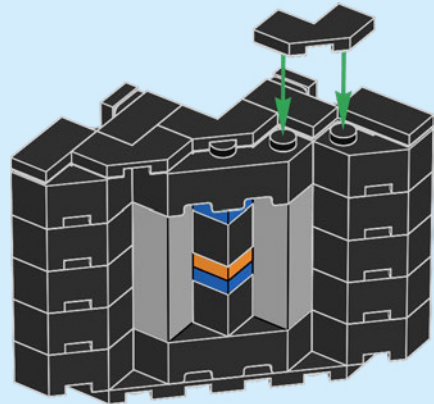



139







# MONKIE KID 悟空小侠



80040



80043



80041



80045

**COMBINE  
80036+80044**

Combine 80036 + 80044  
Kombinierbar mit 80036 und 80044  
Combinez les sets 80036 et 80044  
Combina 80036 + 80044  
可将 80036 和 80044 组合玩乐  
Объедините наборы 80036 + 80044  
Połącz 80036 + 80044  
Zkombinujte stavebnice 80036 a 80044  
Skombinujte stavebnice 80036 a 80044  
Kombinál a 80036-os és 80044-es szettel!  
Combină 80036 + 80044  
Комбинируйте 80036 + 80044  
Savieno komplektus 80036 un 80044  
Sobita kokku komplektid 80036 ja 80044  
Sujunkite 80036 + 80044



YOU COULD **WIN**



Scan this QR code or go to **LEGO.COM/PRODUCTFEEDBACK** and give us your short feedback about this LEGO® set for a chance to win a cool LEGO prize.

Terms and Conditions apply\*

**DE: Du könntest GEWINNEN.** Es gelten die Teilnahmebedingungen\* **FR: Tu pourrais GAGNER.** Des conditions s'appliquent\* **IT: Potresti VINCERE tu.** Termini e condizioni sono applicabili\* **ES: Puedes GANAR.** Aplican términos y condiciones\* **PT: Poderá GANHAR.** Aplicam-se termos e condições\* **JA: プレゼント付き! 利用規約が適用されます\*** **ZH: 轻松获奖. 条款和条件适用\*** **KO: 상품의 주인이 되어보세요. 소정의 약관이 적용됩니다\*** **RU: Вы можете ВЫИГРАТЬ.** Действуют положения и условия\* **PL: Szansa na WYGRANĄ.** Obowiązują warunki korzystania\* **CS: Máte šanci VYHRÁT.** Platí všeobecné smluvní podmínky\* **SK: Máte šancu VYHRAŤ.** Platia všeobecné zmluvné podmienky\* **HU: TE IS NYERHETSZ.** Felhasználási feltételek érvényesek\* **RO: Ai putea CÂȘTIGA.** Se aplică termeni și condiții\* **BG: Можете да СПЕЧЕЛИТЕ.** Има определени правила и условия\* **LV: Tu vari LAIMĒT.** Ir spēkā noteikumi un nosacījumi.\* **ET: Sul on võimalus VÕITA.** Kehtivad tingimused\* **LT: Jūs galite LAIMĖTI.** Taikomos sąlygos\*  
\*LEGO.com/productfeedback-terms