



MONKIE KID 悟空小侠



80050



5th Anniversary of LEGO® Monkie Kid™
5-jähriges Jubiläum von LEGO® Monkie Kid™
5ème anniversaire de LEGO® Monkie Kid™
5° anniversario di LEGO® Monkie Kid™
5.º Aniversario de LEGO® Monkie Kid™
5.º Aniversário de LEGO® Monkie Kid™
乐高“悟空小侠”推出 5 周年
5. rocznica serii LEGO® Monkie Kid™
5. výročí řady LEGO® Monkie Kid™
5. výročie série LEGO® Monkie Kid™
A LEGO® Monkie Kid™ 5. évfordulója
Aniversarea a 5 ani de LEGO® Monkie Kid™
Пета годишнина на LEGO® Monkie Kid™
LEGO® Monkie Kid™ 5. jubileja
LEGO® Monkie Kid™ 5. aastapäev
5-asis „LEGO® Monkie Kid™“ gimtadienis





LEGO® Builder



LEGO.com/sustainable-packaging



 ^{FR} **DONNEZ**
OU
RECYCLEZ

 OU  OU 

ASSOCIATION MAGASIN DÉCHÈTERIE

Adresses sur quefairedemesdechets.fr

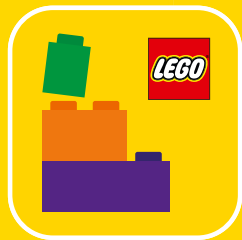

Q LEGO® Builder

BUILDER



Apple and the Apple logo are trademarks of Apple Inc., registered in the U.S. and other countries and regions. App Store is a service mark of Apple Inc. Google Play and the Google Play logo are trademarks of Google LLC. Tencent and the Tencent logo are trademarks of Tencent Inc.

Q [LEGO.com/devicecheck](https://lego.com/devicecheck)

EN Ask parents' permission before going online | **DE** Eltern um Erlaubnis bitten, bevor du online gehst | **FR** Demande l'autorisation d'un parent avant d'aller en ligne | **IT** Chiedi il permesso ai tuoi genitori prima di andare online | **ES** Pídeles permiso a tus papás antes de conectarte a Internet | **PT** Pede autorização aos pais antes de acederes online | **ZH** 上网前应先征得父母的同意 | **PL** Poproś rodziców o zgodę, zanim wejdiesz do Internetu | **CS** Než půjdeš na internet, požádej rodiče o svolení | **SK** Skôr než pôjdeš na internet, vypýtaj si povolenie od rodičov | **HU** Kérj szülői engedélyt, mielőtt online csatlakoznál! | **RO** Cere permisiunea părinților înainte de a te conecta online | **BG** Поискайте разрешение от родител, преди да влезете онлайн | **LV** Pirms došanās tiešsaistē palūdz atļauju vecākiem | **ET** Enne Interneti kasutamist küsi vanematelt luba | **LT** Prieš prisijungdami prie interneto, atsiklauskite tėvų

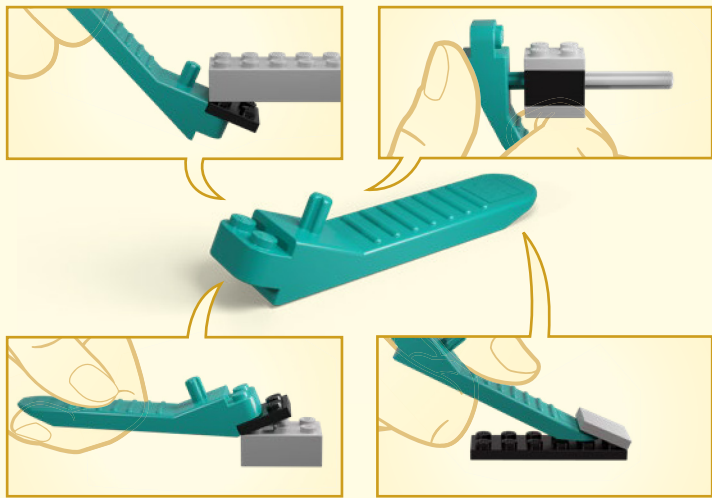

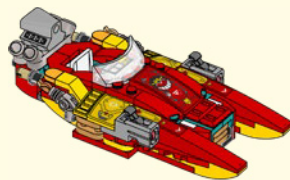



1x



1x



1x

1

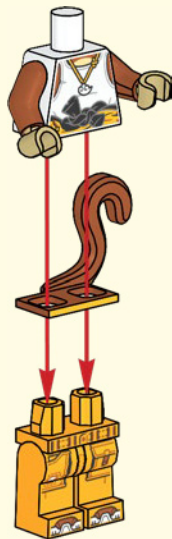



1x



1x

2

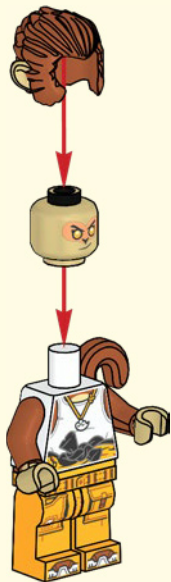

1x



1x



1x

3

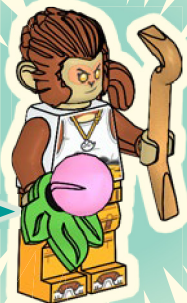
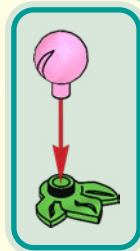

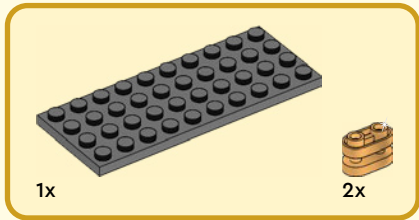
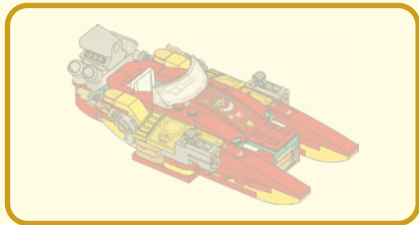

1

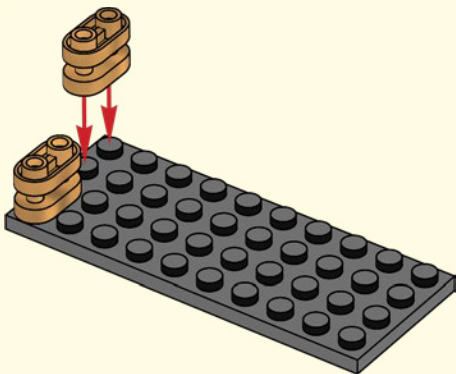



2x

2

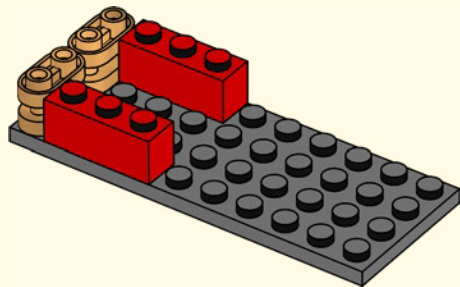

1x



2x

3

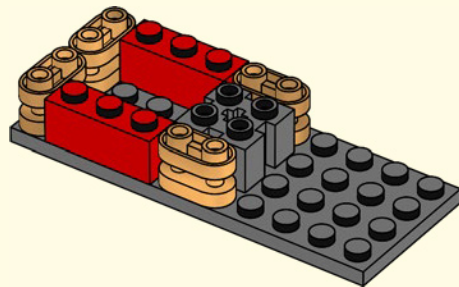



2x



2x

4

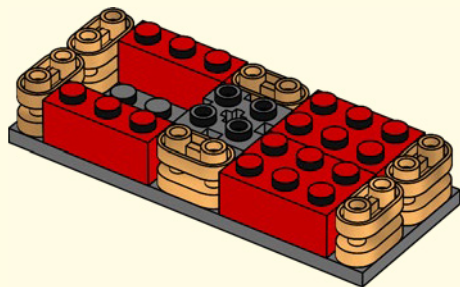

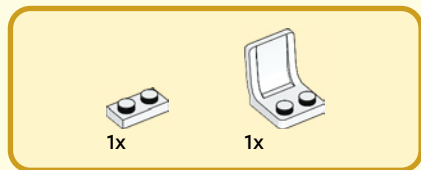

5

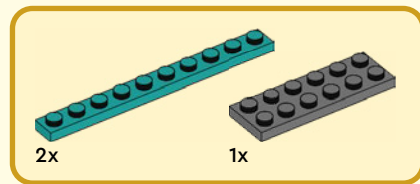
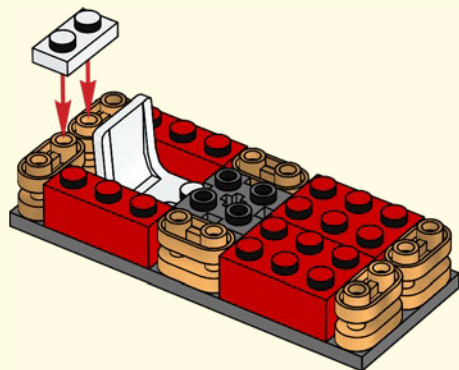

6

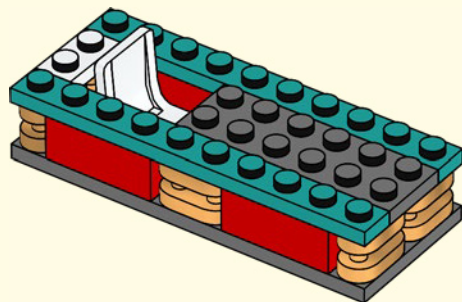

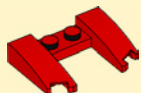

1x

7

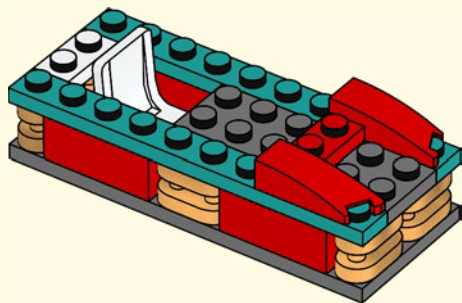



2x



1x

8

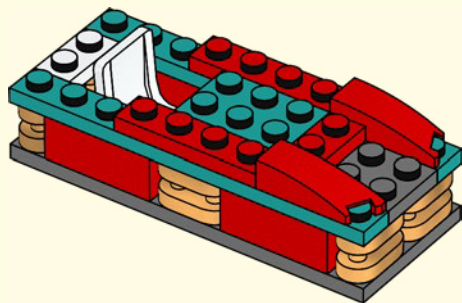

2x



2x

9

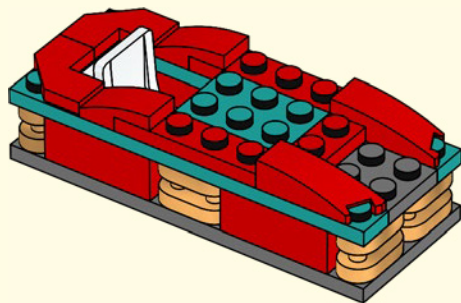



1x



1x

10

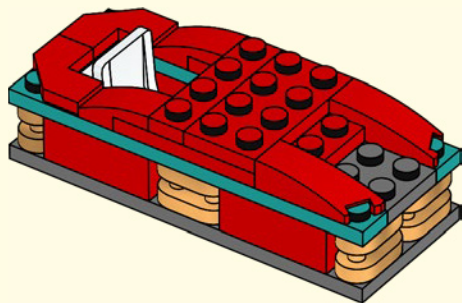



1x

11

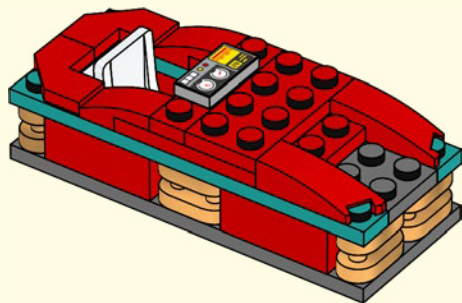

1x



1x

12

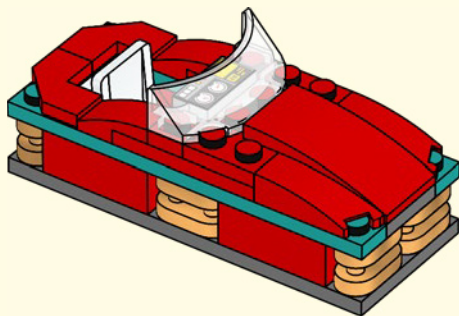

13

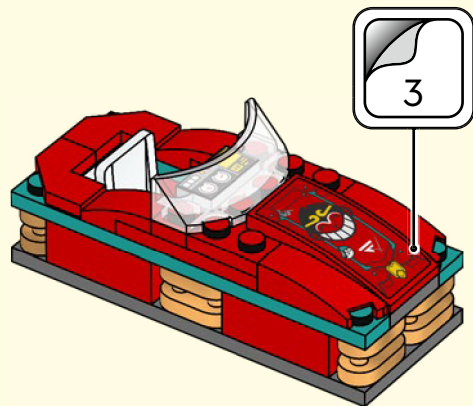



1x



1x

14

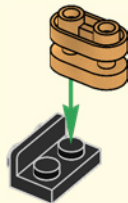

1x

15

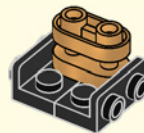



2x

16

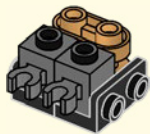

2x

17

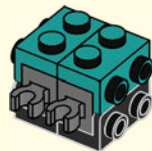

18





2x

18

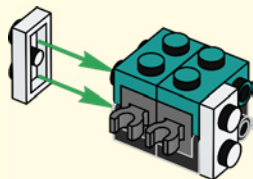

2x

19

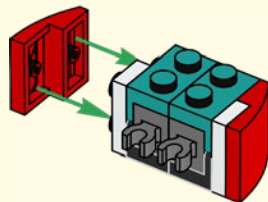



2x

20

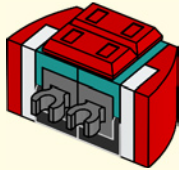

21





1x



1x

22

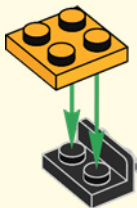

1x

23





4x

24

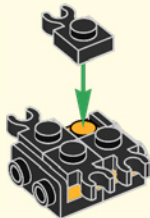

1x

25

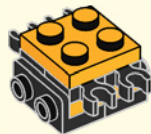



2x

26

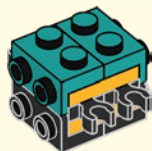

2x

27

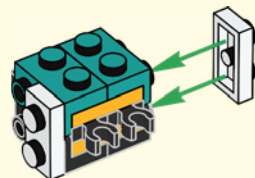



2x

28

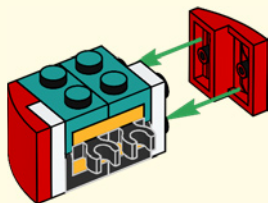

1x

29





2x

30



1x

31

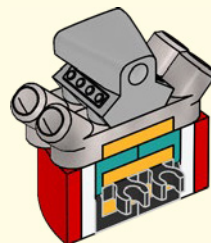

32

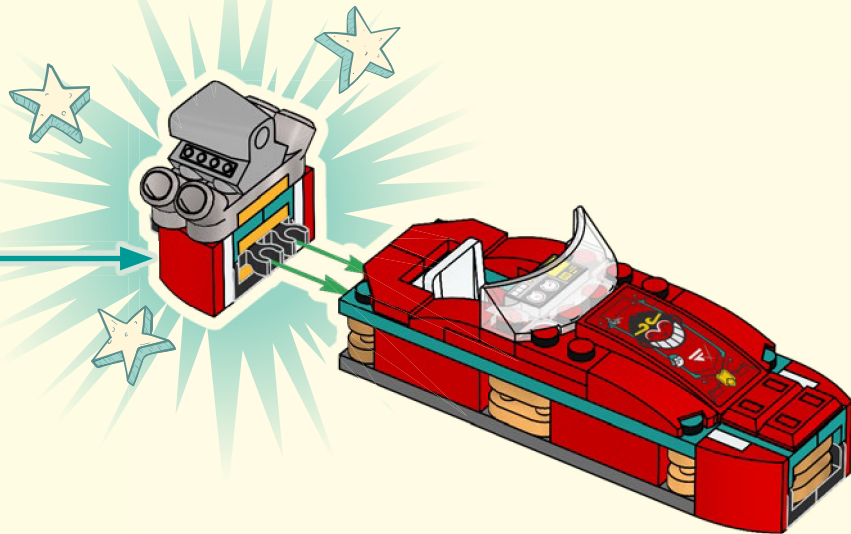

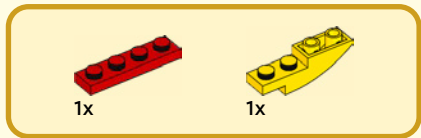

33

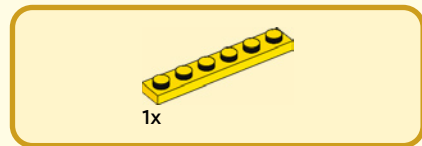
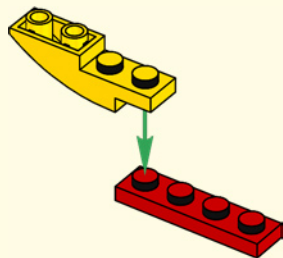

34

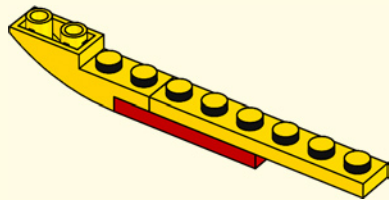



1x

35

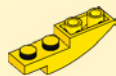
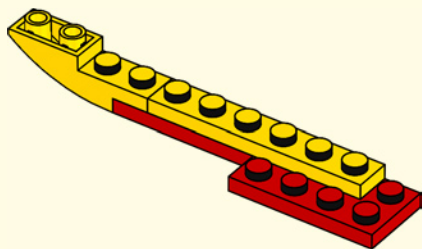

1x



1x

36

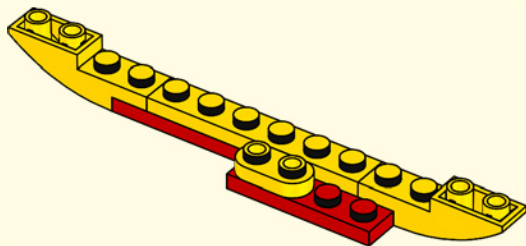

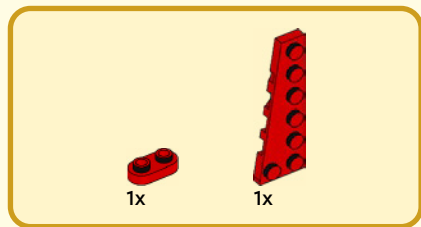

37

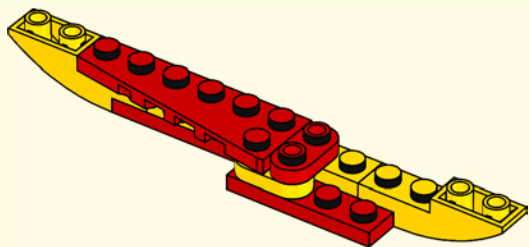

38

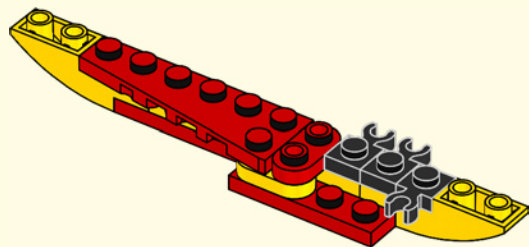



1x

39

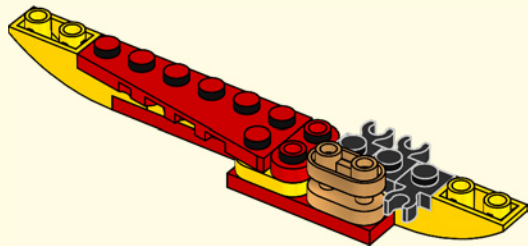

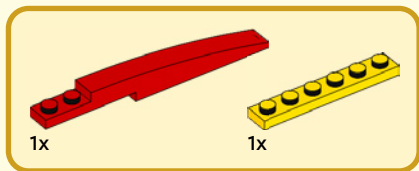

40

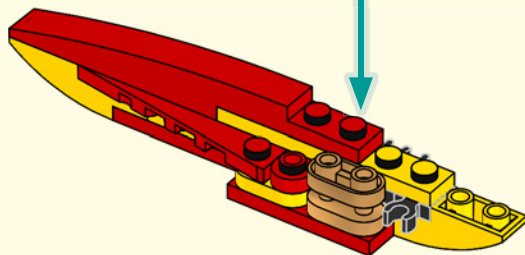
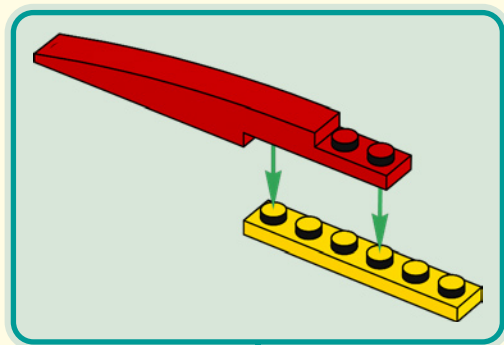

41

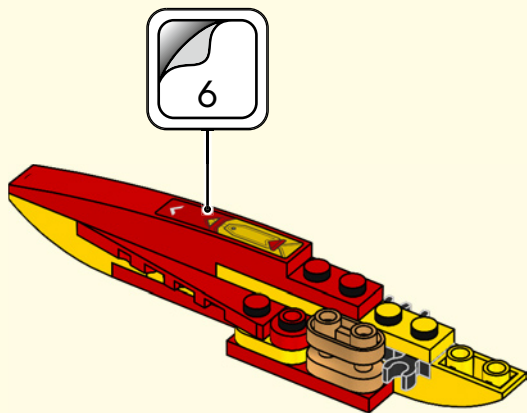

42

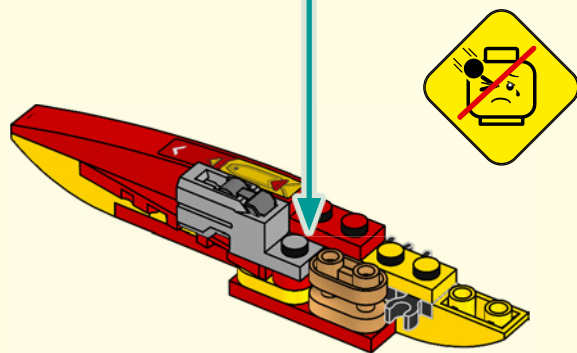
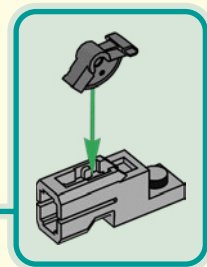
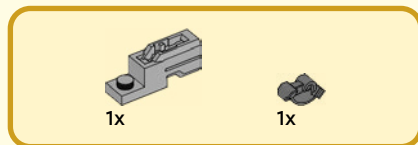



1x



1x

43

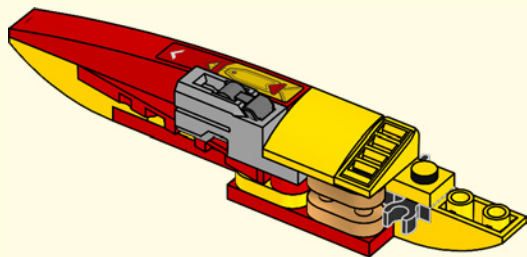



1x



1x



2x

44

1

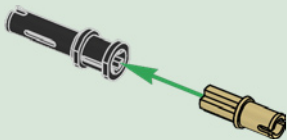

2

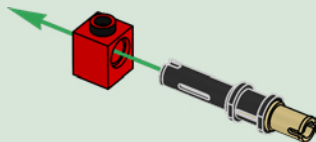

3

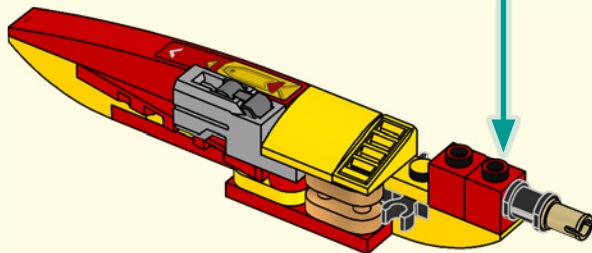
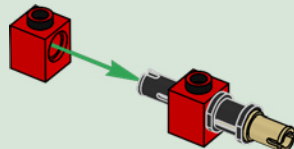



1x



1x

45

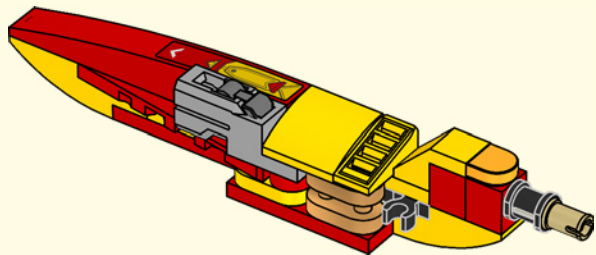

46

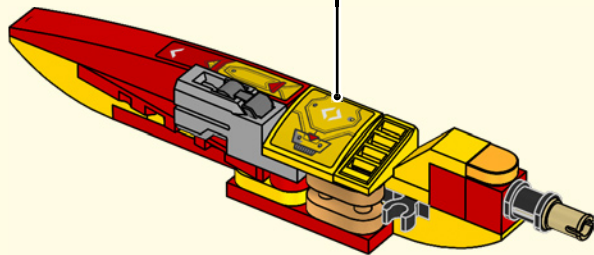



1x



1x

47

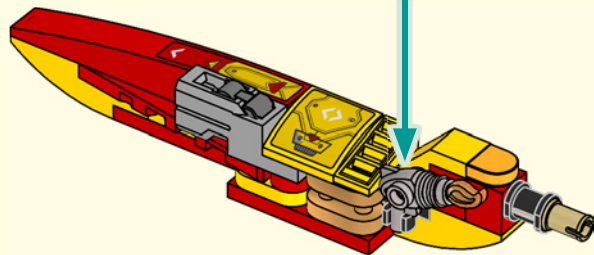
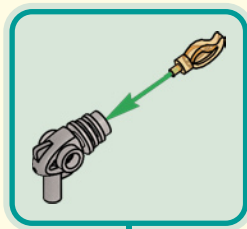

48

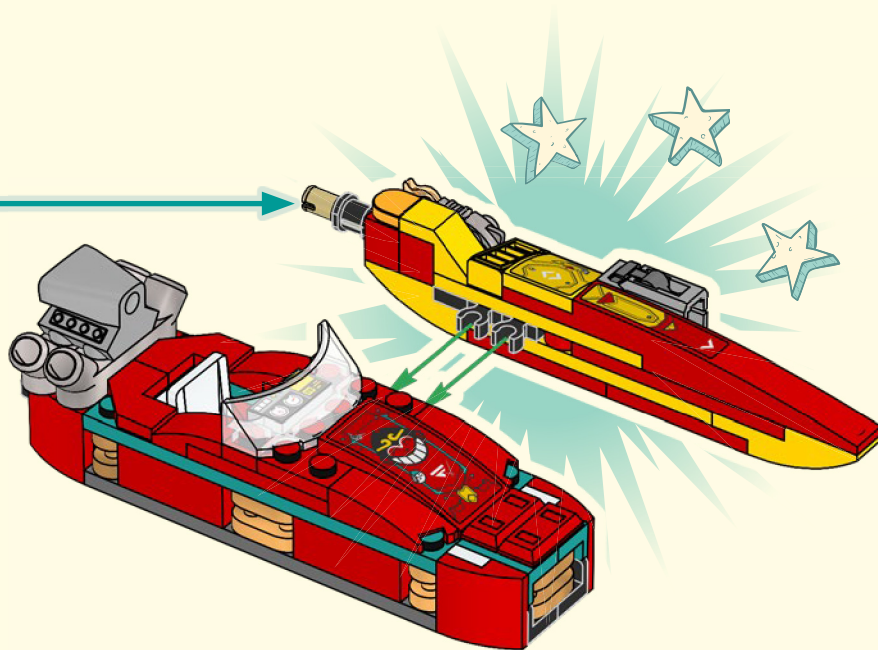

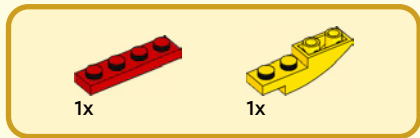

49

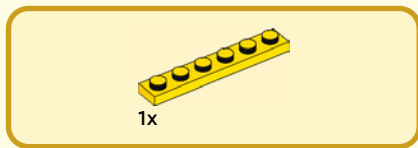
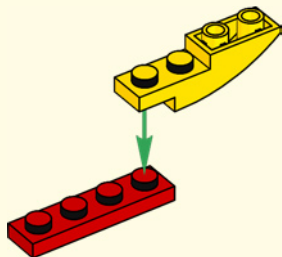

50

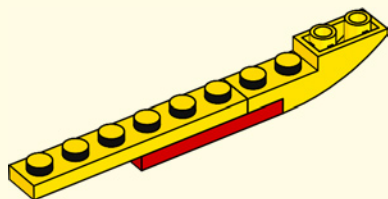



1x

51

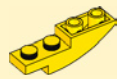
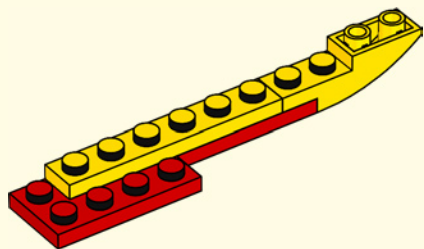

1x



1x

52

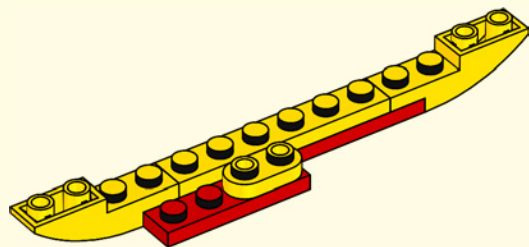

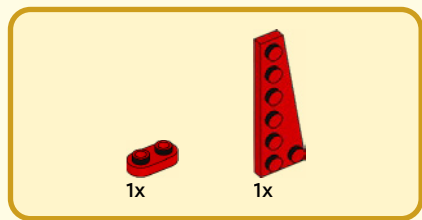

53

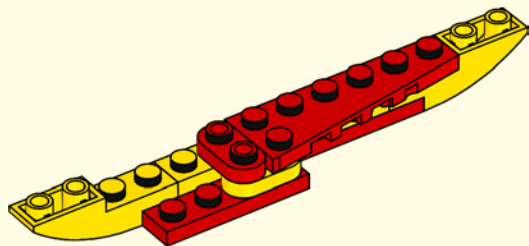



3x

54

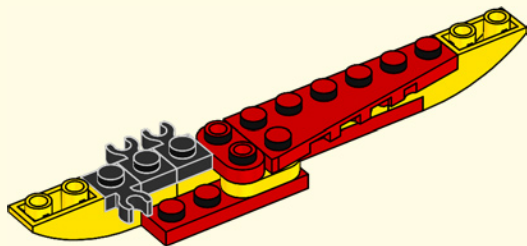

1x

55

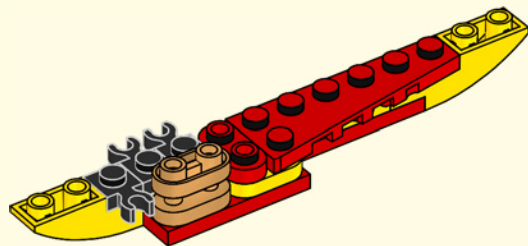

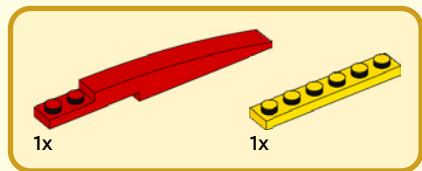

56

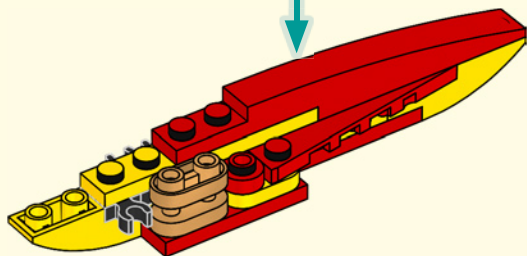
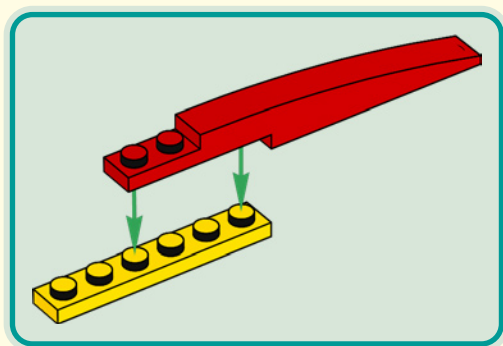

57

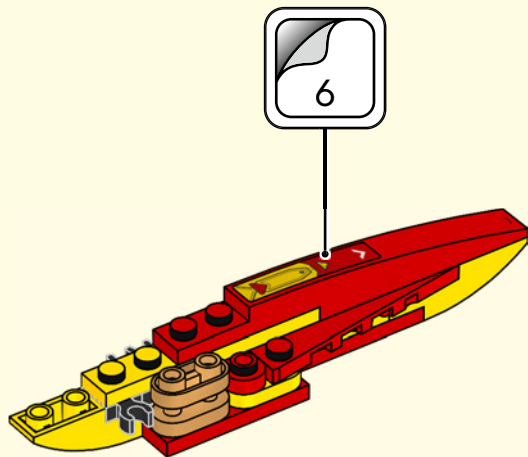

58

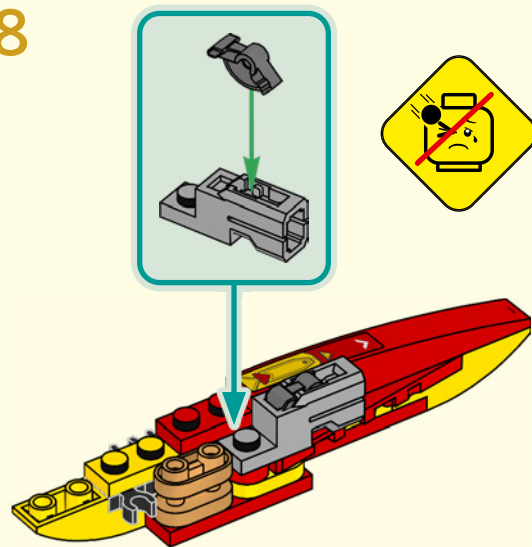
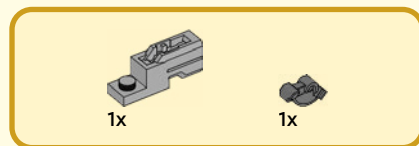



1x



1x

59

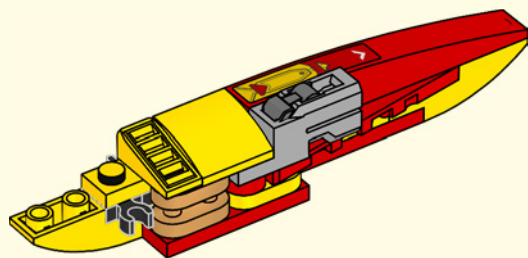



60

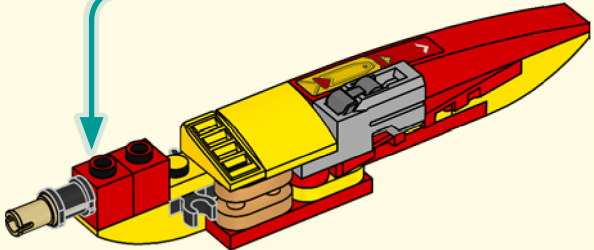
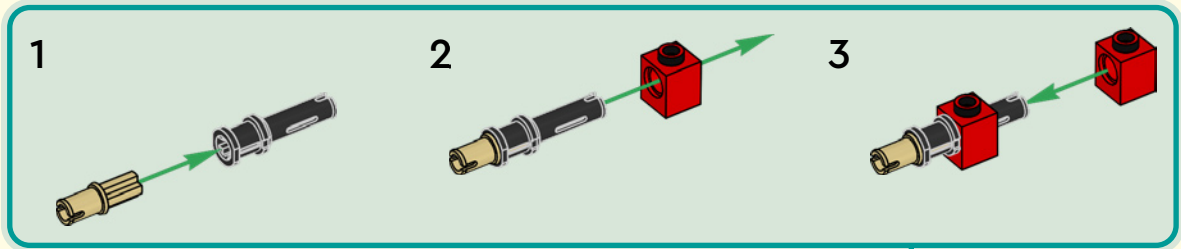



1x



1x

61

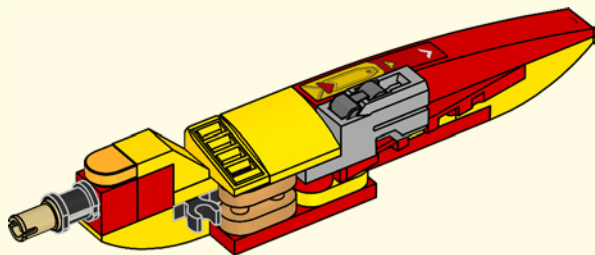

62

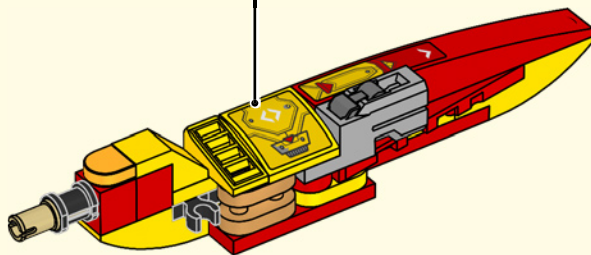



1x



1x

63

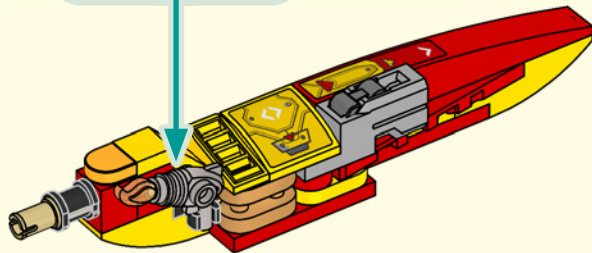
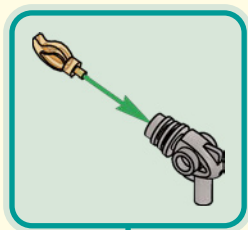

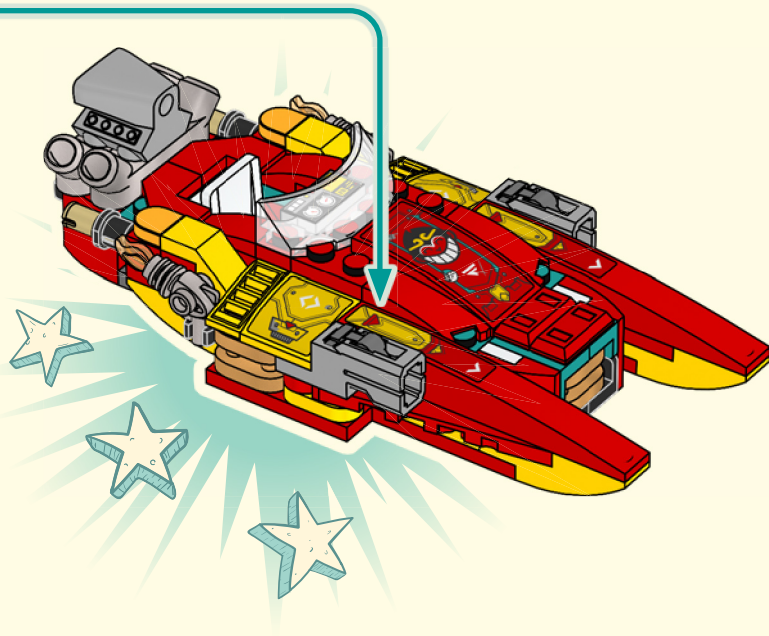

4x



65

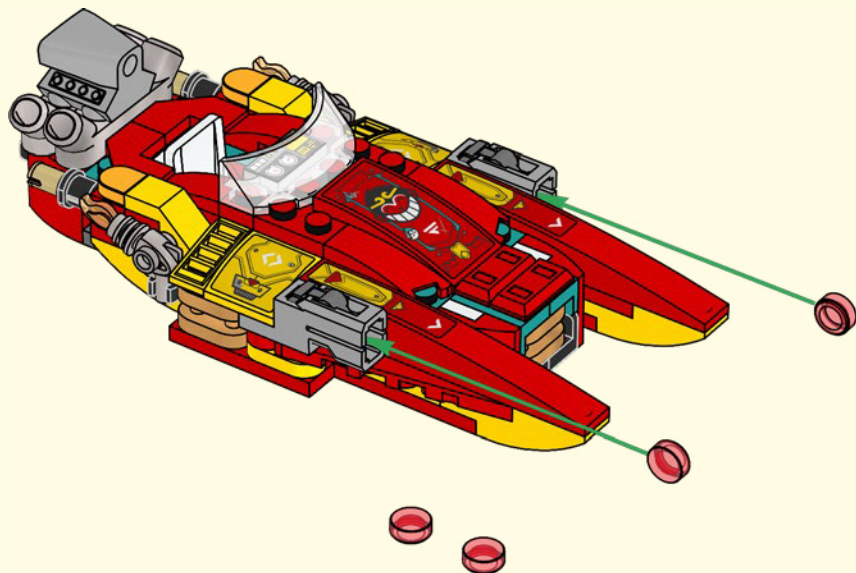

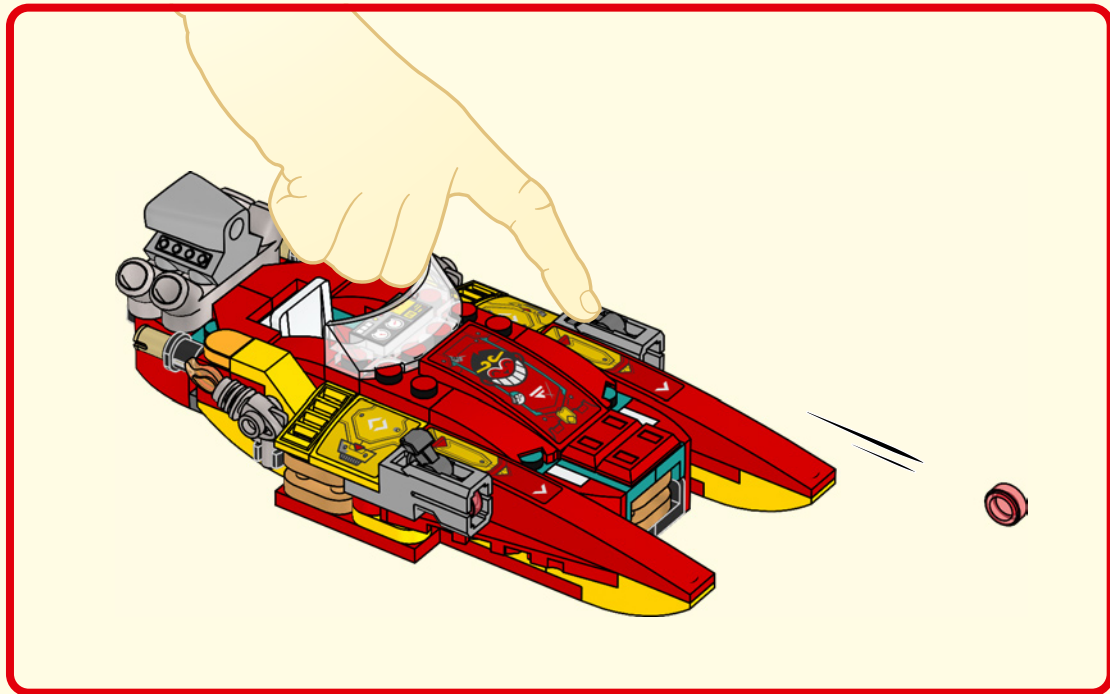

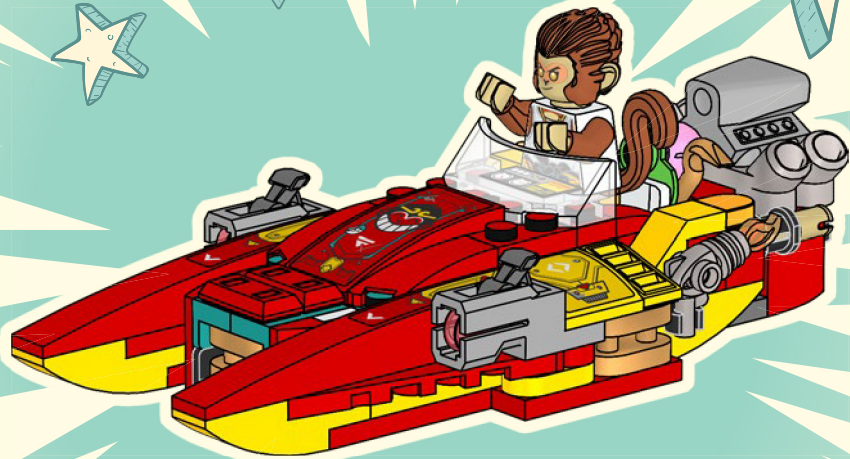

YOU COULD
WIN

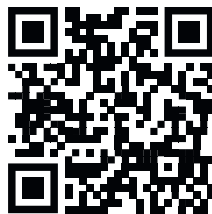

Scan this QR code or go to
LEGO.COM/PRODUCTFEEDBACK and give
us your short feedback about this LEGO® set
for a chance to win a cool LEGO prize.

Terms and Conditions apply*

EN: YOU COULD WIN. Terms and Conditions apply* **DE: Du könntest GEWINNEN.** Es gelten die Teilnahmebedingungen* **FR: Tu pourrais GAGNER.** Des conditions s'appliquent* **IT: Potresti VINCERE tu.** Termini e condizioni sono applicabili* **ES: Puedes GANAR.** Aplican términos y condiciones* **PT: Poderá GANHAR.** Aplicam-se termos e condições* **ZH: 轻松获奖. 条款和条件适用*** **PL: Szansa na WYGRANĄ.** Obowiązują warunki korzystania* **CS: Máte šanci VYHRÁT.** Platí všeobecné smluvní podmínky* **SK: Máte šancu VYHRAŤ.** Platia všeobecné zmluvné podmienky* **HU: TE IS NYERHETSZ.** Felhasználási feltételek érvényesek* **RO: Ai putea CÂȘTIGA.** Se aplică termenii și condiții* **BG: Можете да СПЕЧЕЛИТЕ.** Има определени правила и условия* **LV: Tu vari LAIMĒT.** Ir spēkā noteikumi un nosacījumi.* **ET: Sul on võimalus VÕITA.** Kehtivad tingimused* **LT: Jūs galite LAIMĖTI.** Taikomos sąlygos*

*[LEGO.com/productfeedback-terms](https://www.lego.com/productfeedback-terms)

LEGO and the LEGO logo are trademarks of the LEGO Group. ©2024 The LEGO Group.

6497714