



THE BATMAN



76179



2

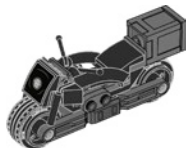

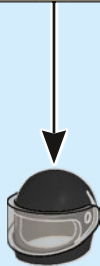
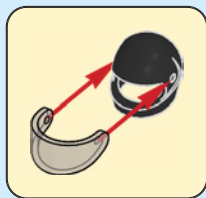
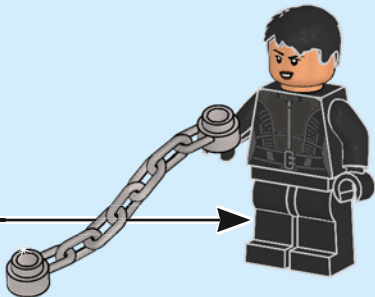
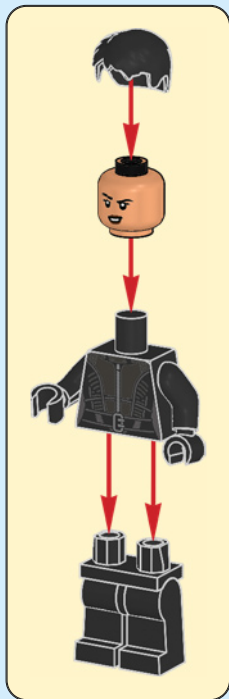

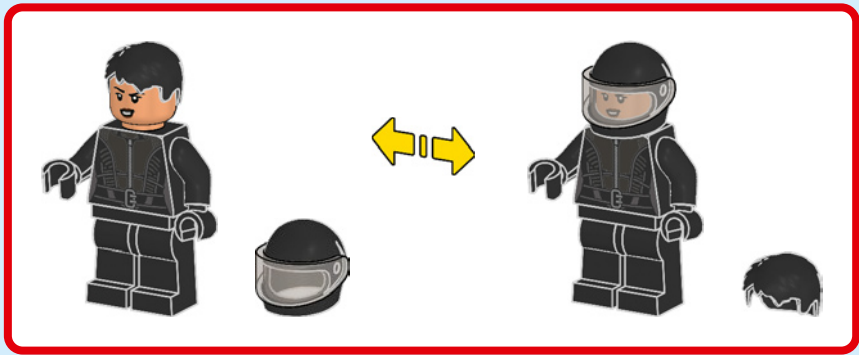

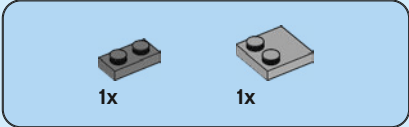

1

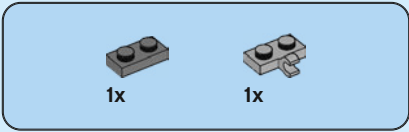
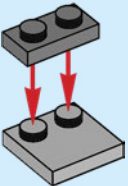

2

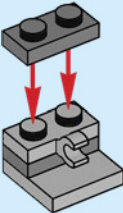



1x

3

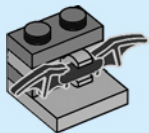

6

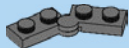

1x

4

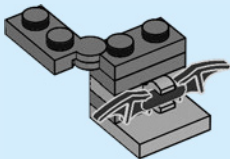



1x



1x

5

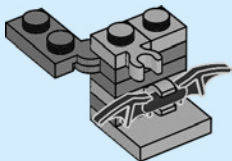

1x

6

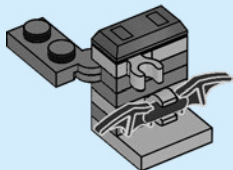

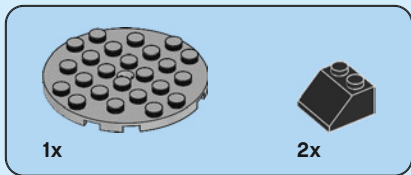

7

1

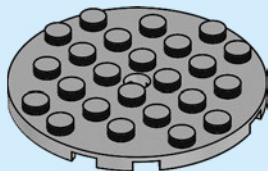

2

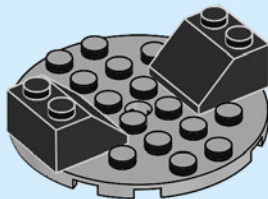

8

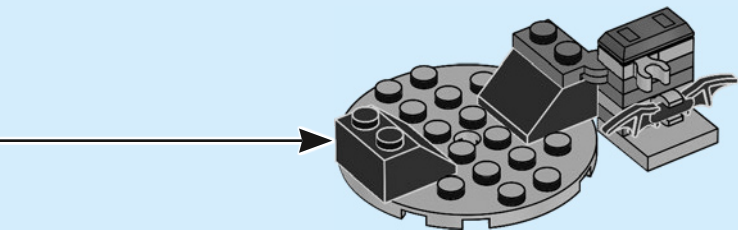



1x

8

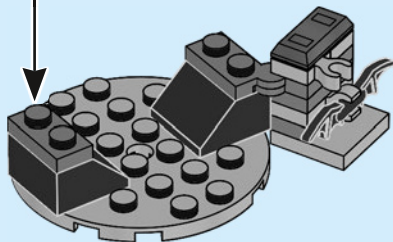

10

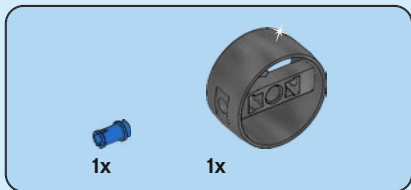

9

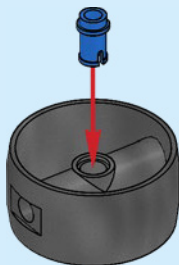

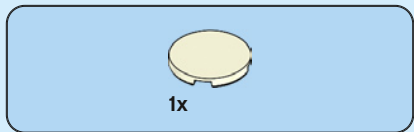

10

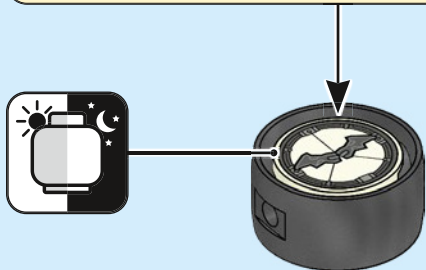
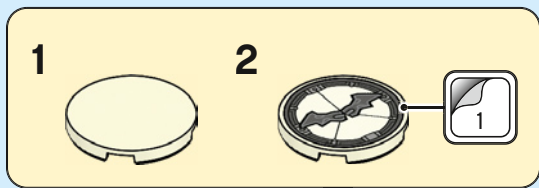



2x



2x



2x

11

1

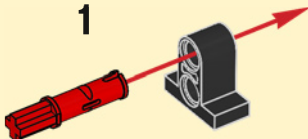

2

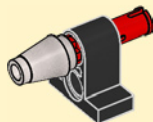

2x

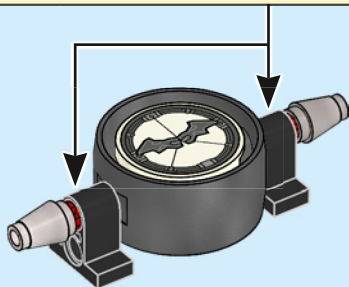

12

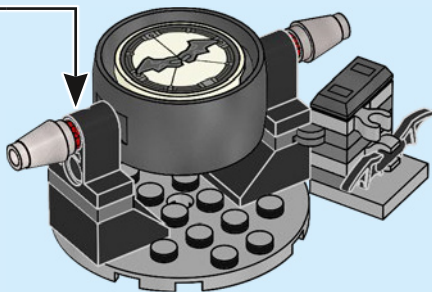

14



2x



1x



1x

13

1

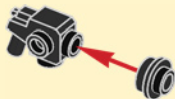

2

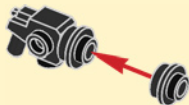

3

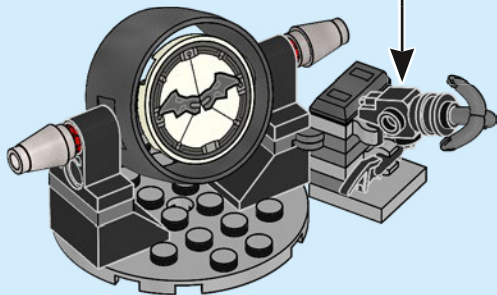

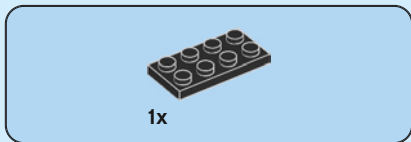
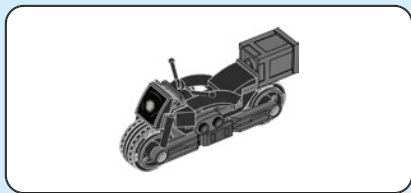

1

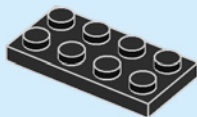

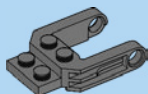

2x

2

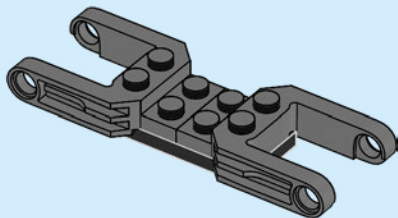

2x

3

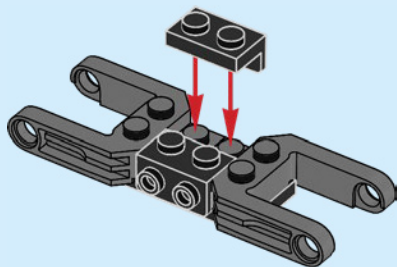



2x

4

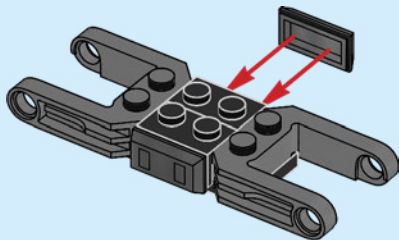

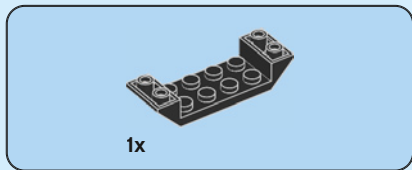

5

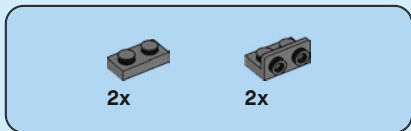
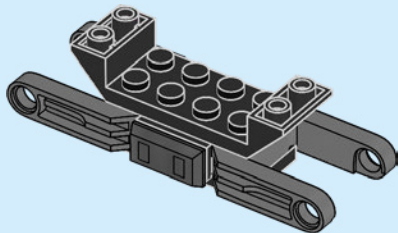

6

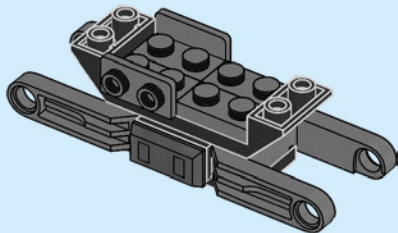



7

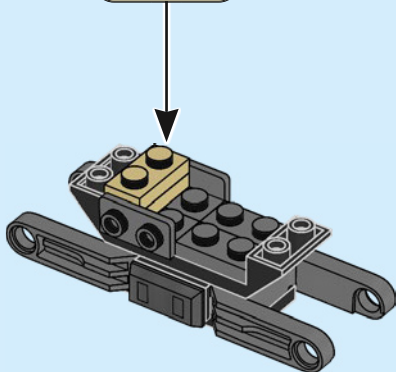
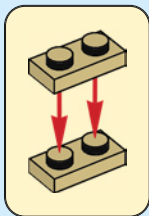

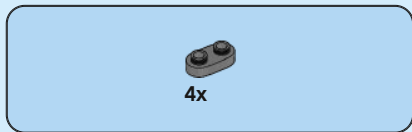

8

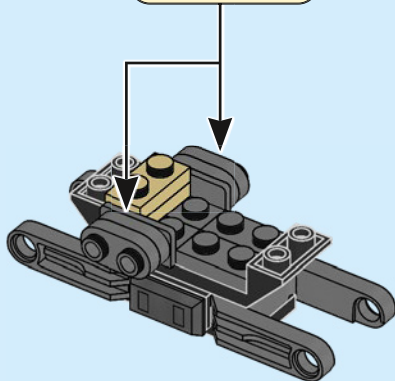
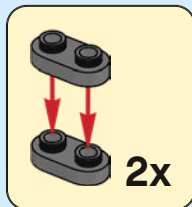



1x

9

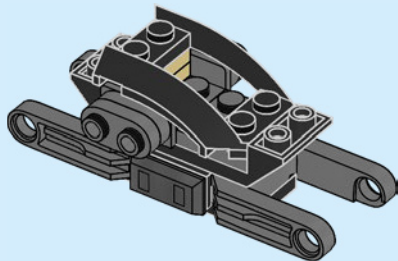

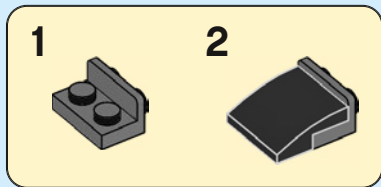
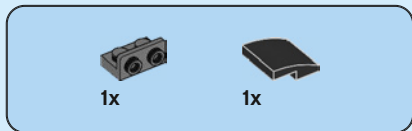

10

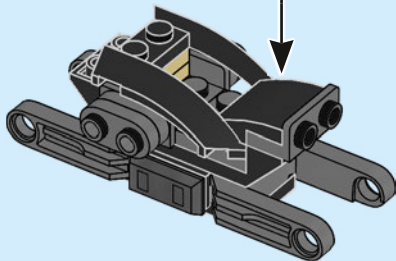



2x

11

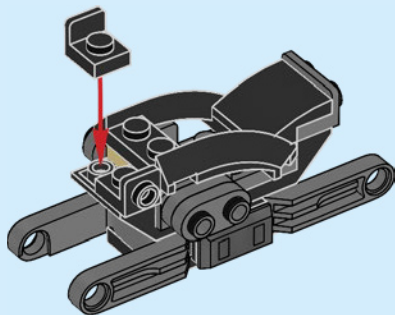



1x

12

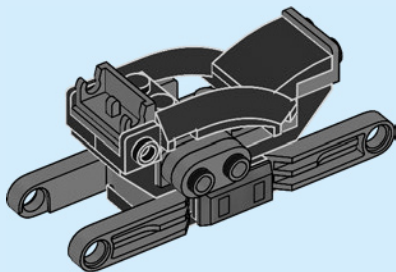

2x

13

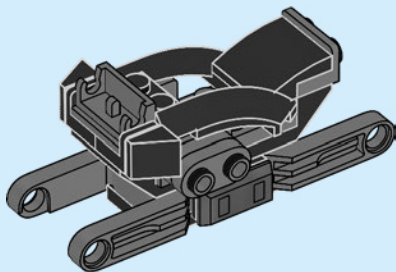

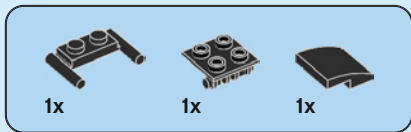

14

1

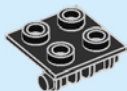

2

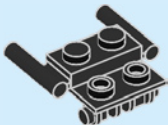

3



4

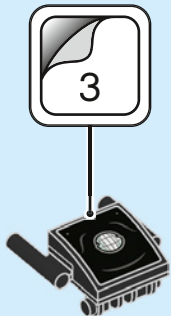

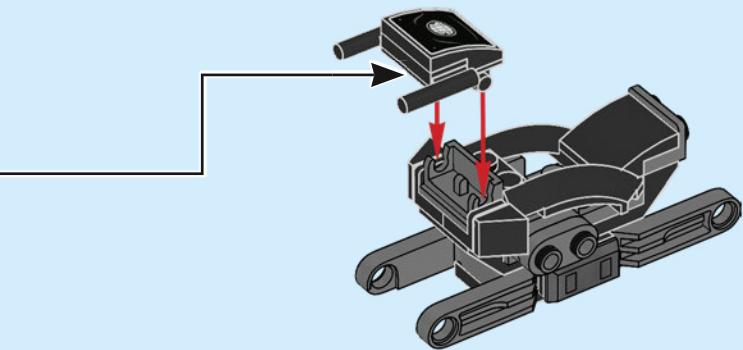



2x

15

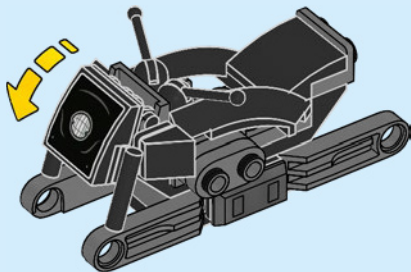



2x

16

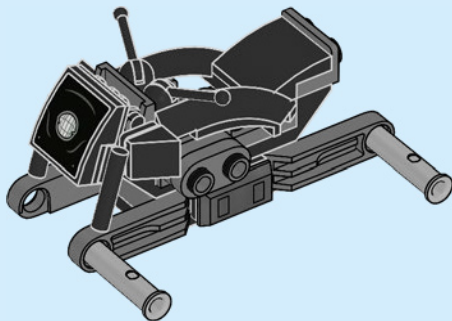

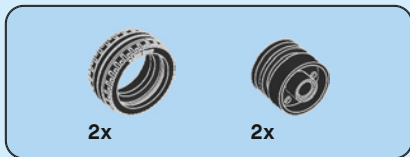

17

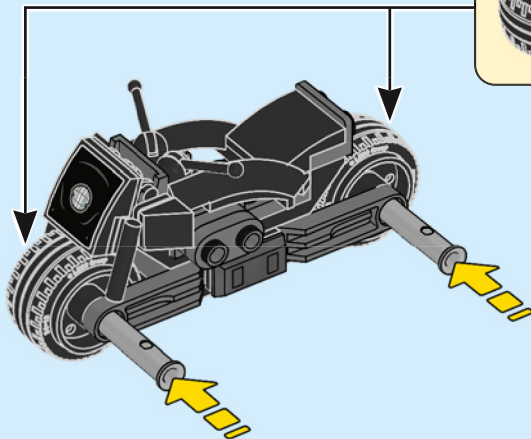
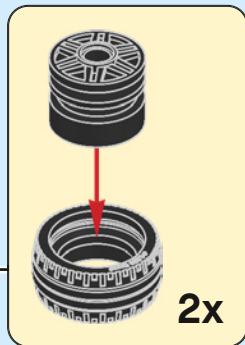

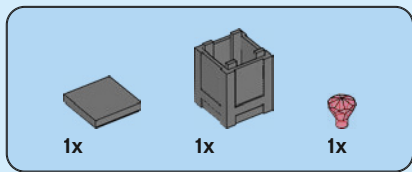

18

1

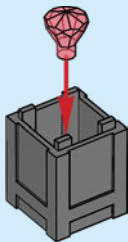

2

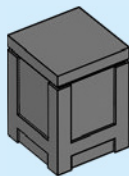

3

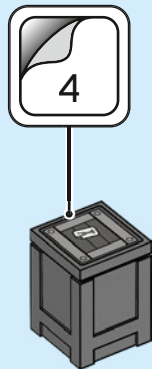

LEGO and the LEGO logo are trademarks of the LEGO Group.

©2022 The LEGO Group. 6411878



THE BATMAN and all related characters and elements © & ™ DC Comics and Warner Bros. Entertainment Inc. WB SHIELD: © & ™ WBEI. (s22)

