



# SPEED CHAMPIONS



75876

Porsche 919  
Hybrid and 917K  
Pit Lane



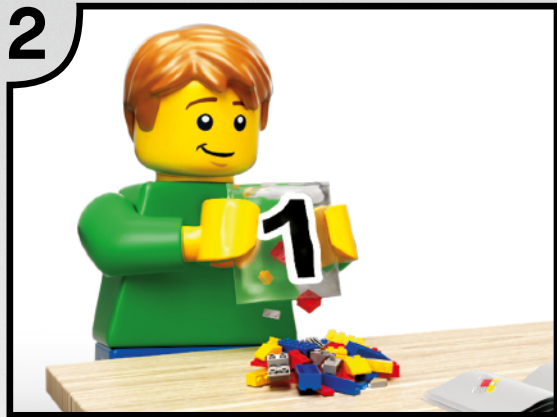

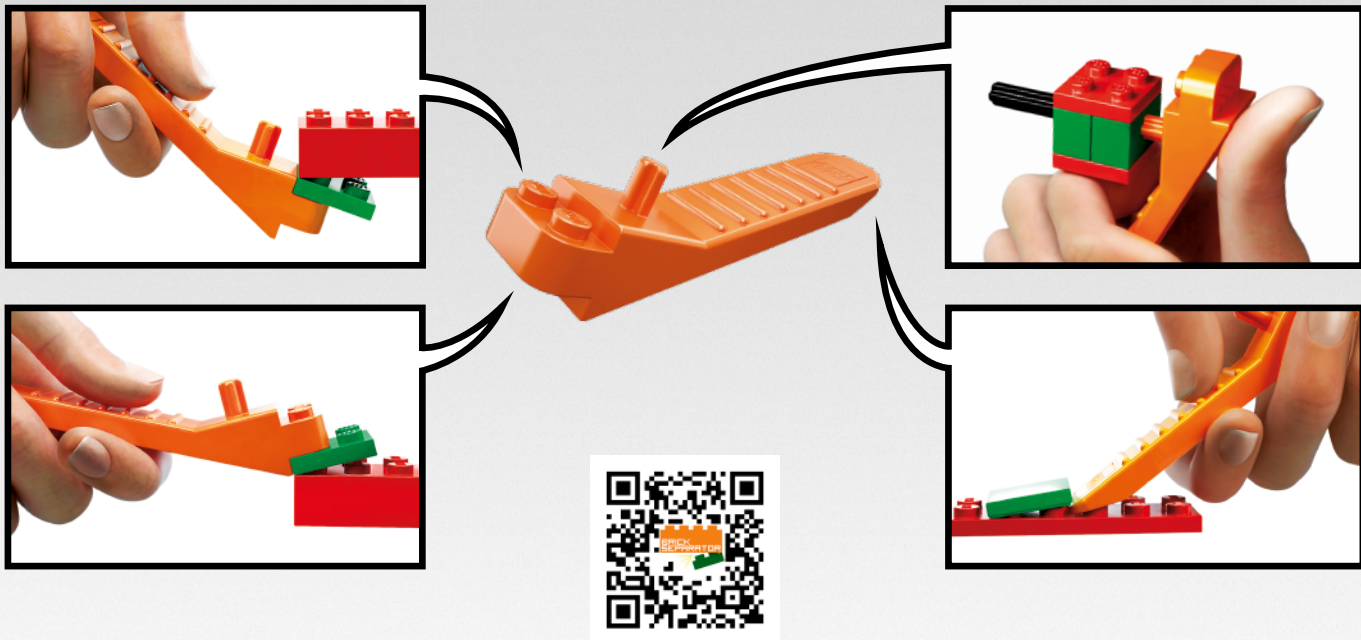

[LEGO.com/brickseparator](https://www.lego.com/brickseparator)

**Porsche 919 Hybrid and 917K Pit Lane**  
**Le poste de ravitaillement des Porsche 919 Hybride et 917K**  
**Le stand de la Porsche 919 Hybrid et 917K**  
**Puesto de reparación para Porsche 919 Hybrid y 917K**  
**Porsche 919 Híbrido e 917K das Boxes**  
**Porsche 919 Hybrid és 917K boksztutca**

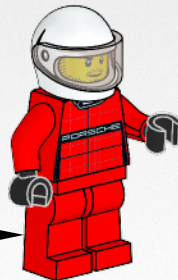
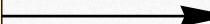
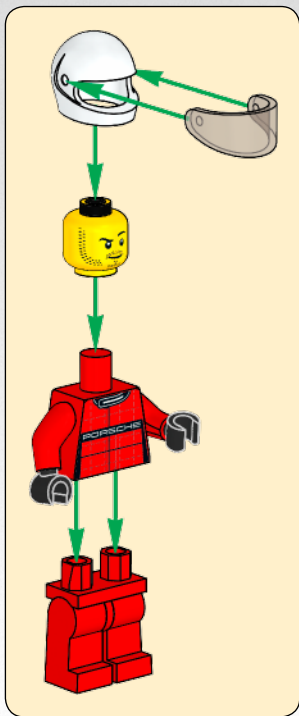
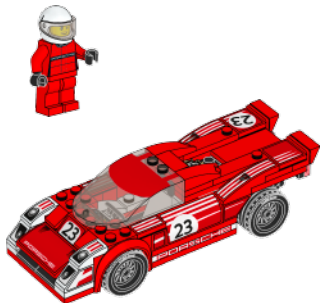

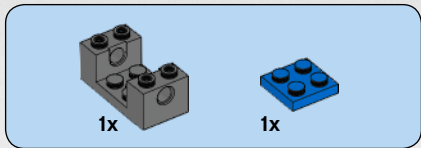
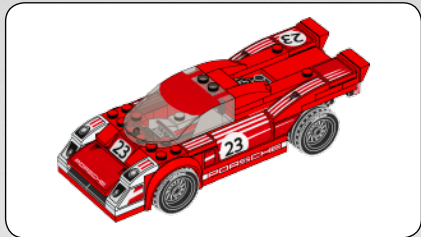

1

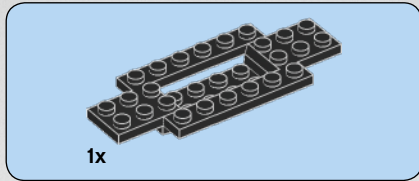
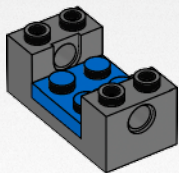

2

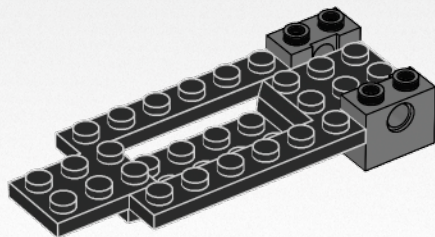

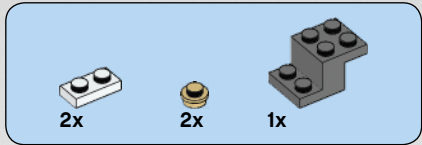

3

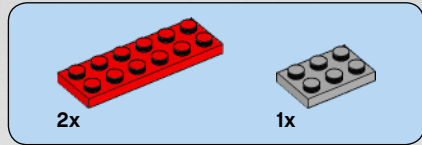
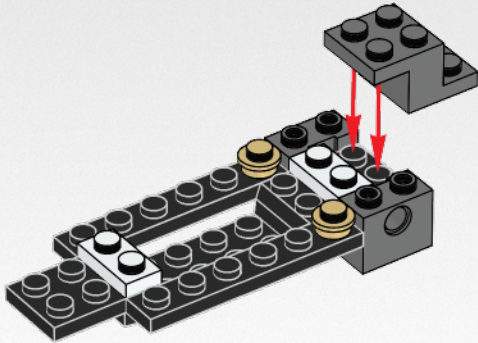

4

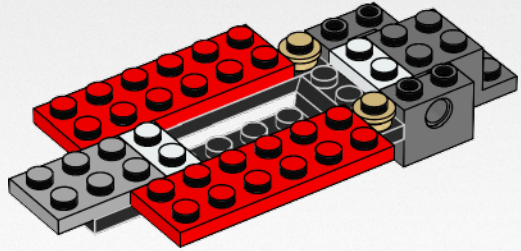



1x



2x

5

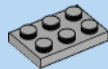
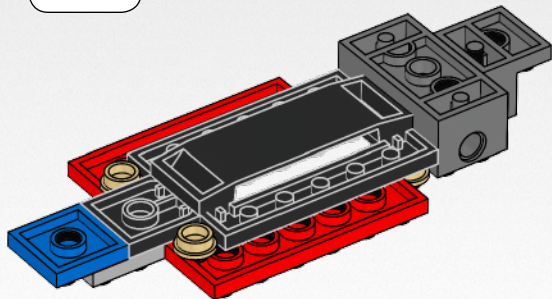
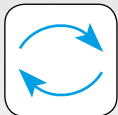

1x

6

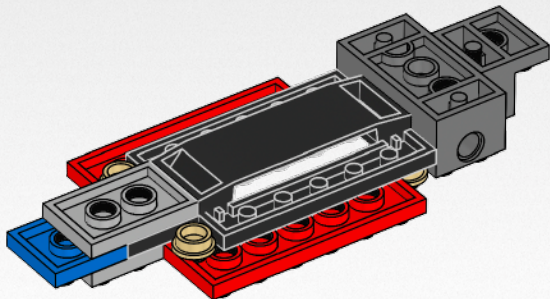

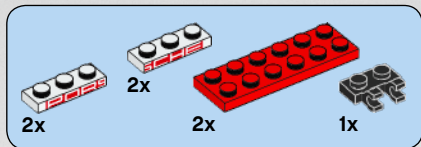

7

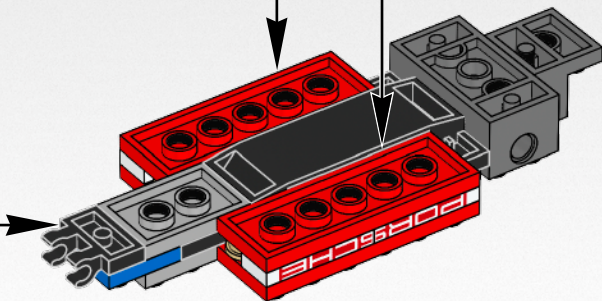
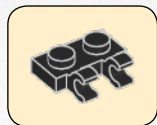
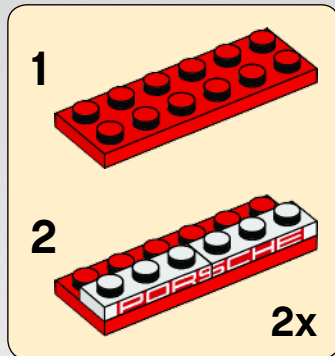

8



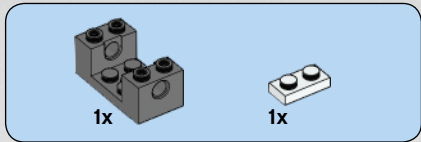

8

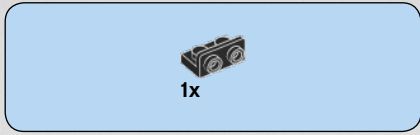
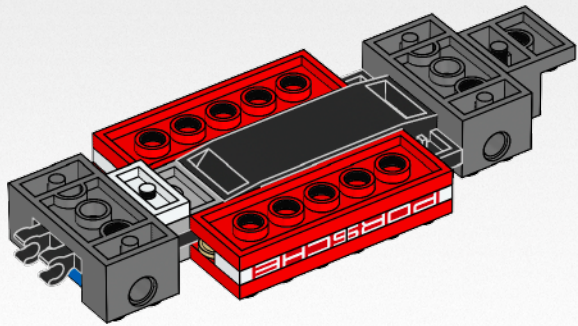

9

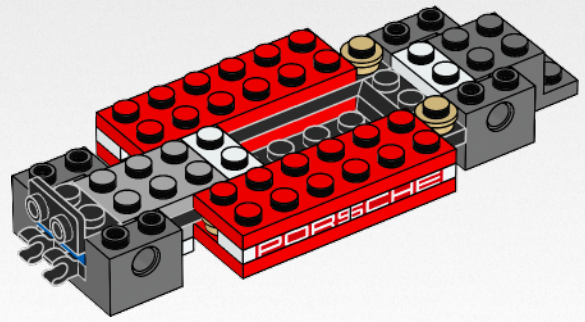
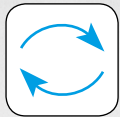

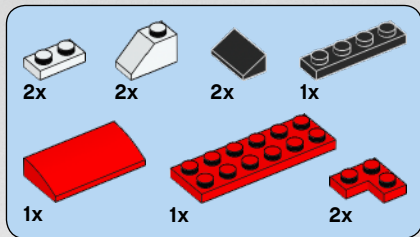

# 10

1

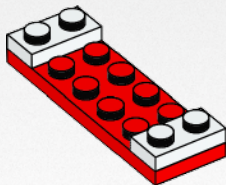

2

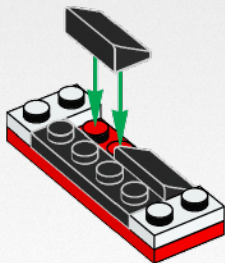

3

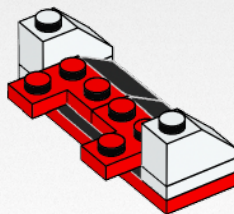

4

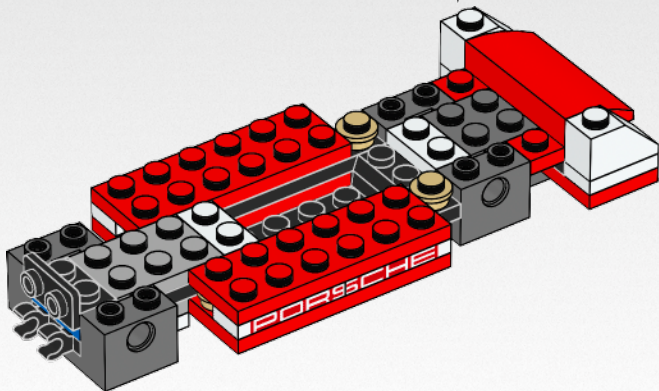
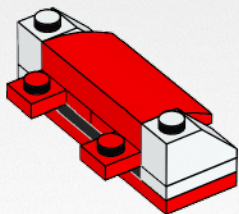

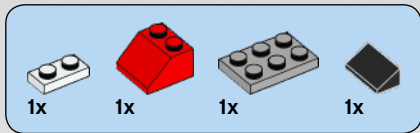

11

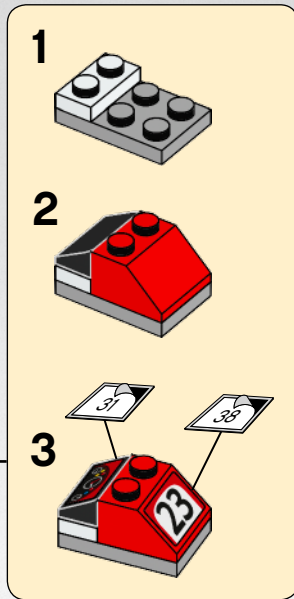
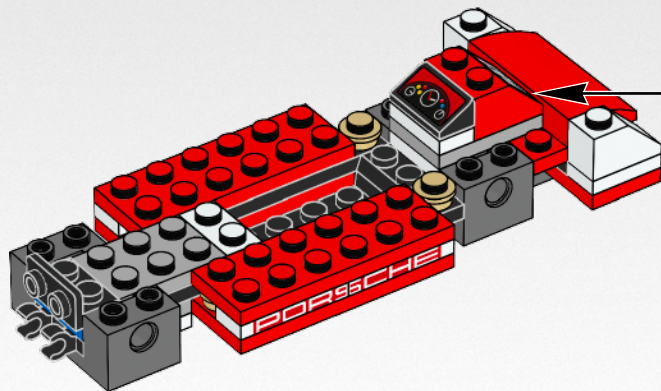





2x



2x



2x

# 13

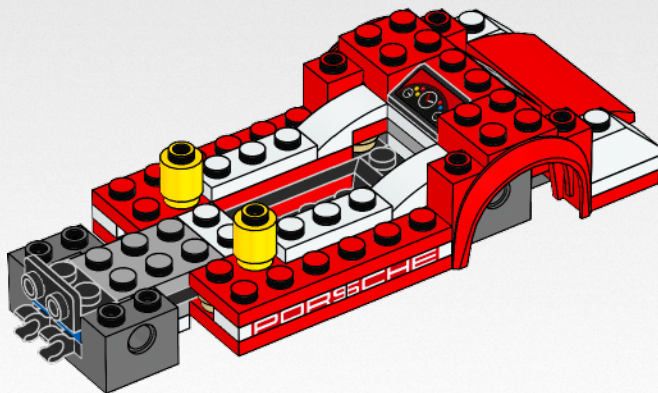

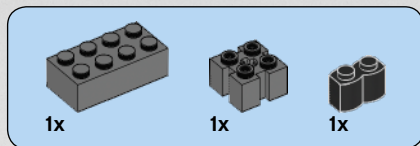

# 14

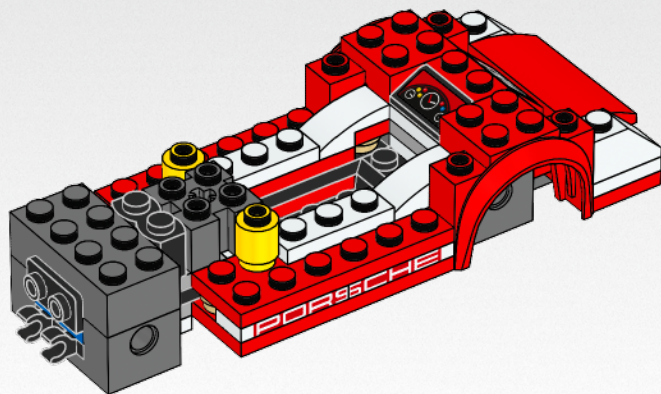



2x



1x

# 15

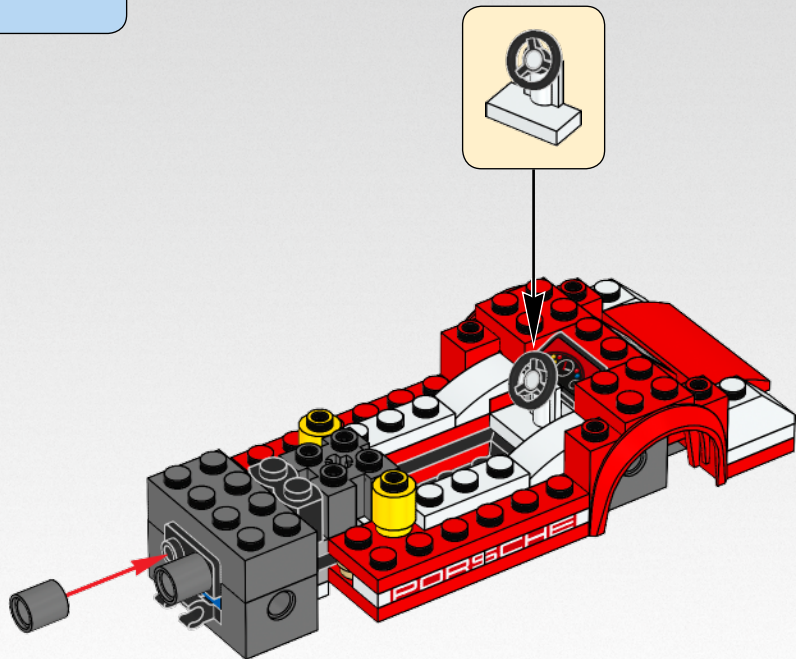



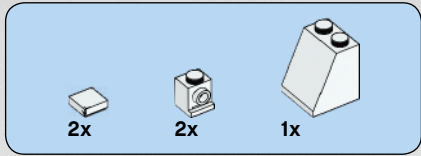

16

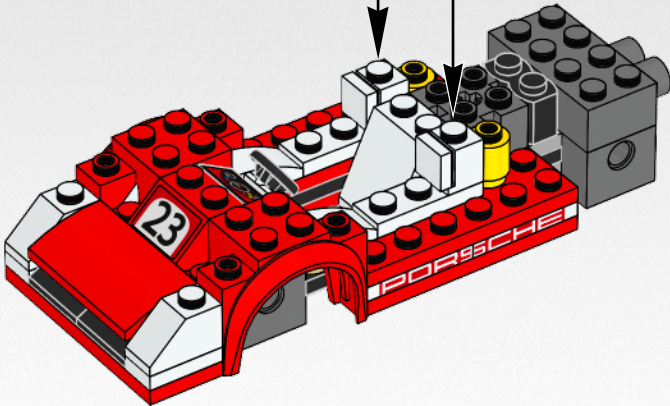
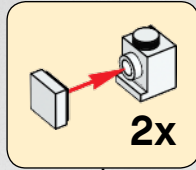

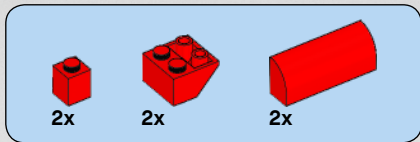

17

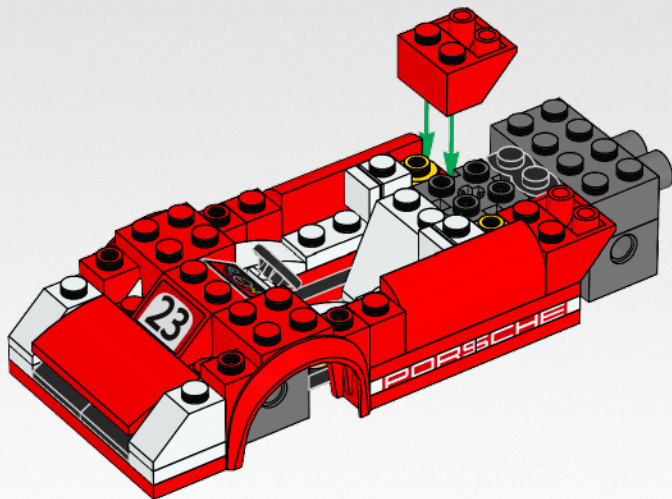



2x



2x

# 18

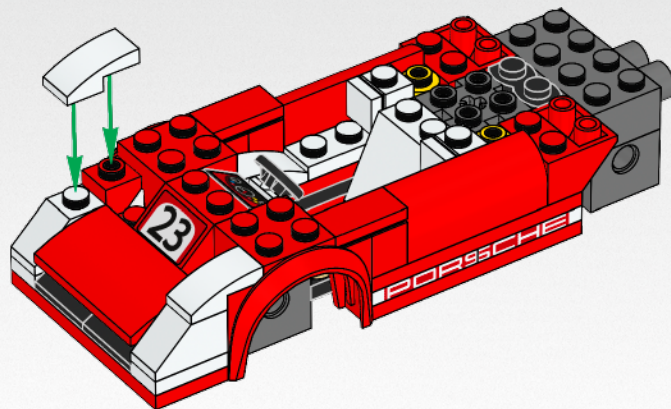

# 19

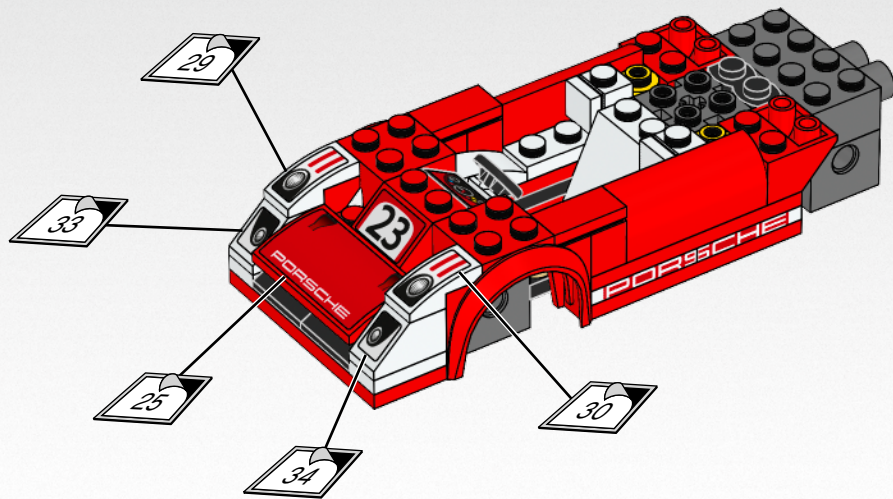



2x



2x

# 20

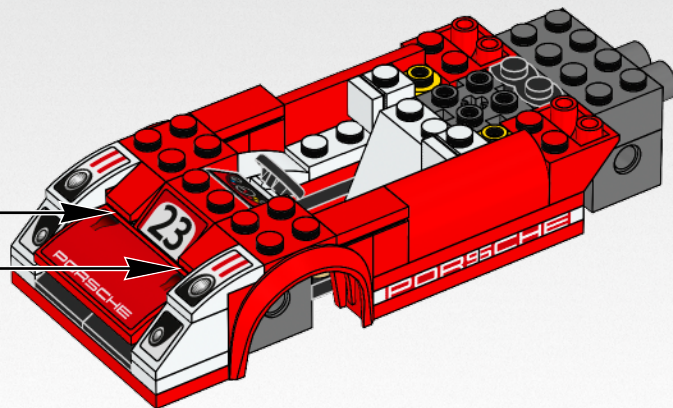
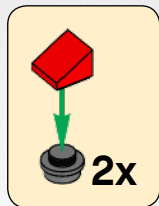

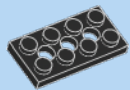

1x

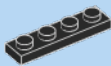

1x

# 21

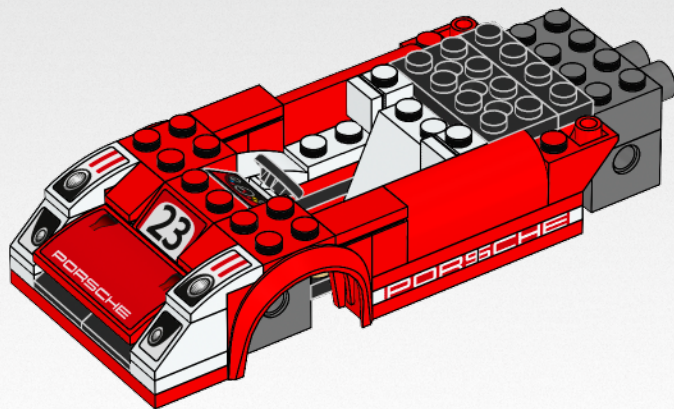

22

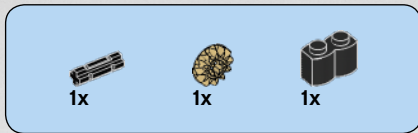

22

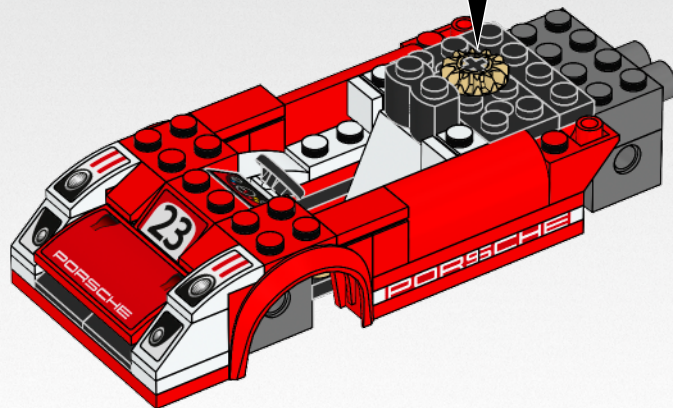
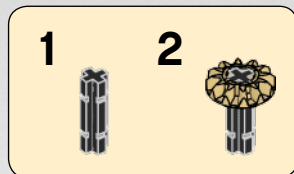

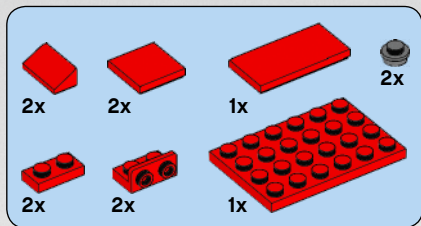

# 23

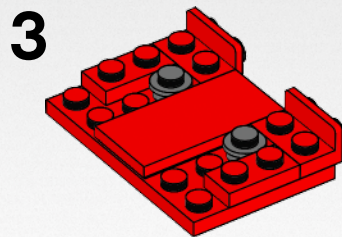
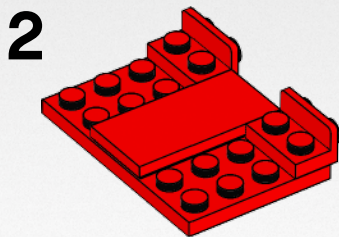
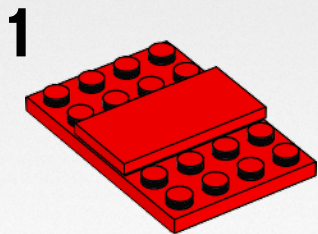



4

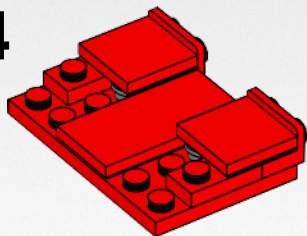

5

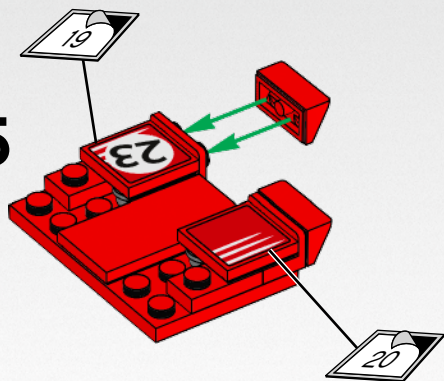

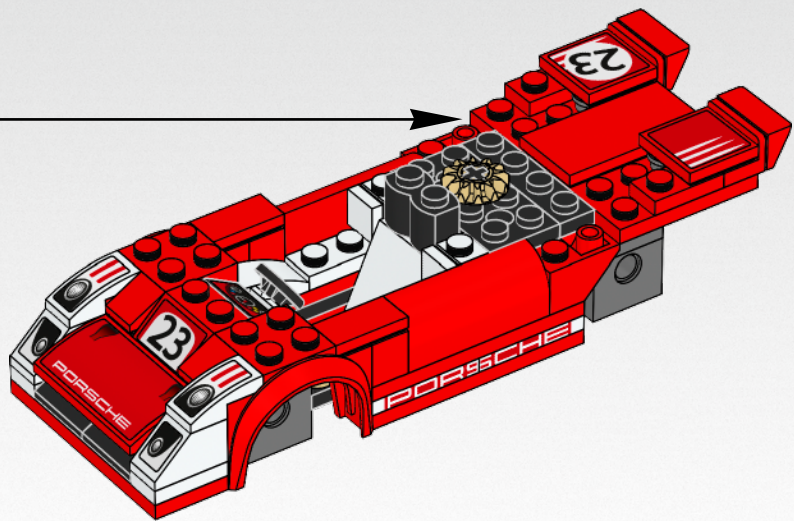

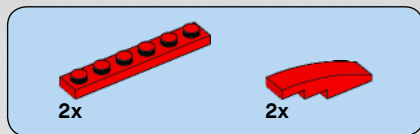

24

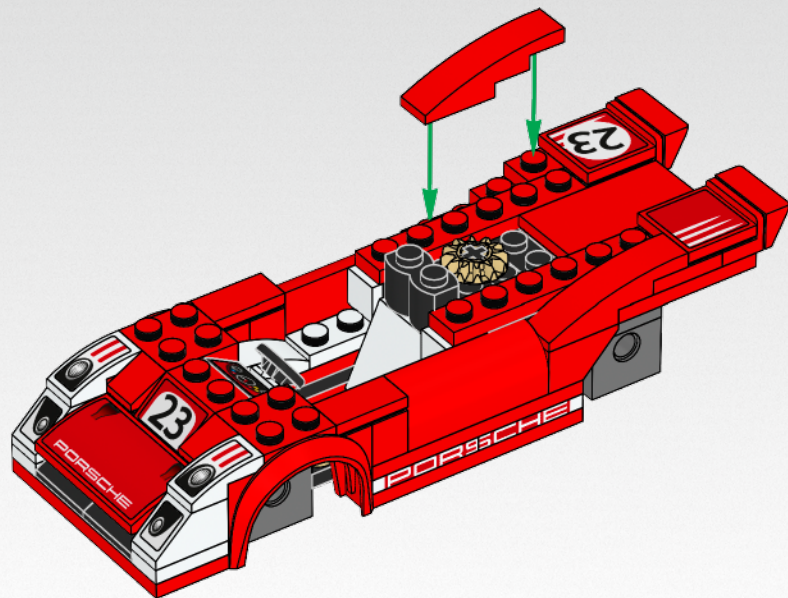

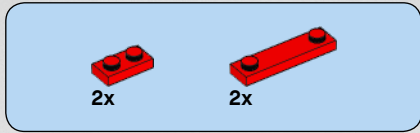

25

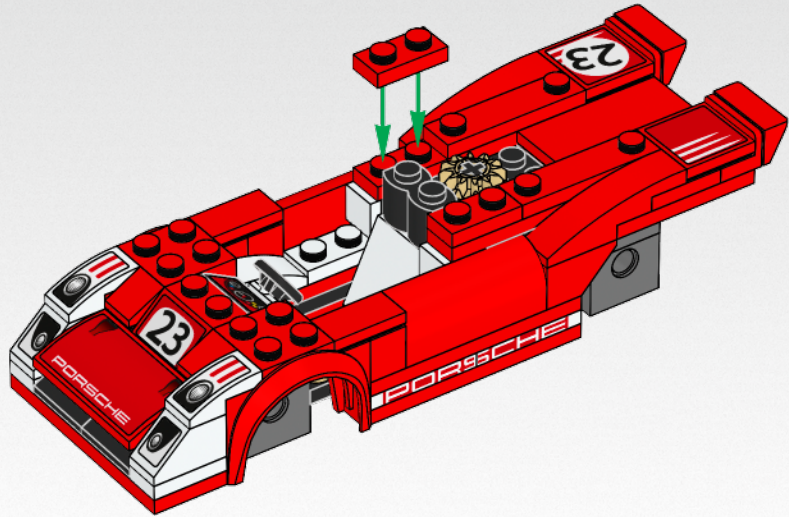

# 26

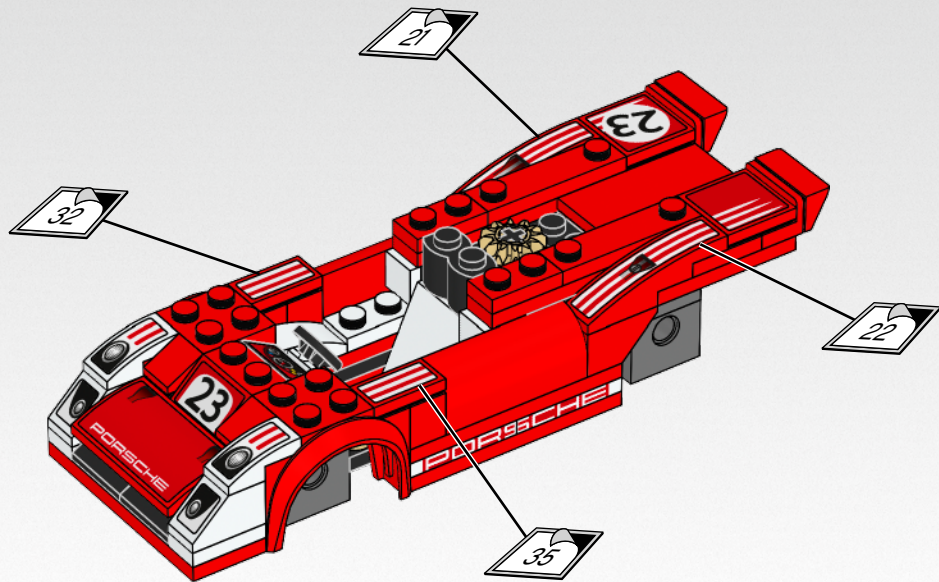

# 27

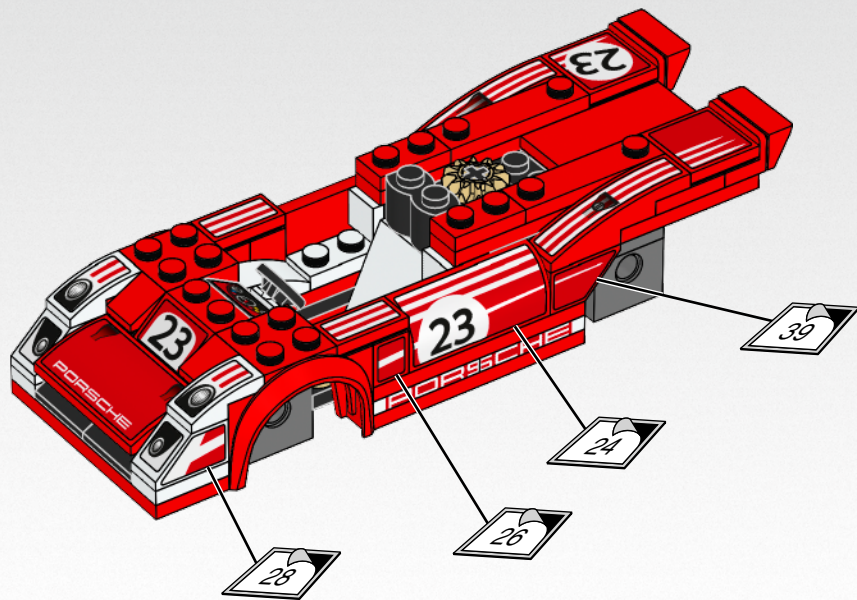

# 28

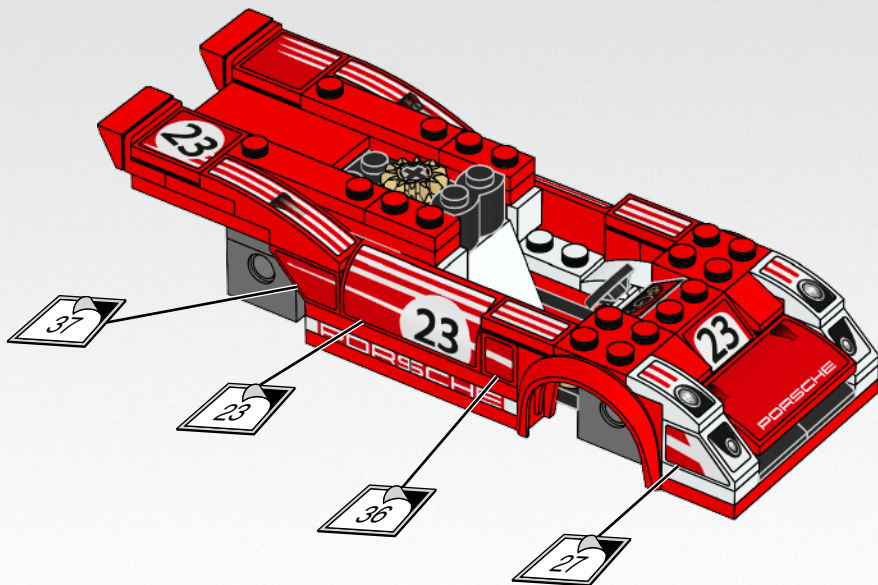
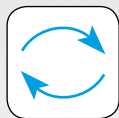

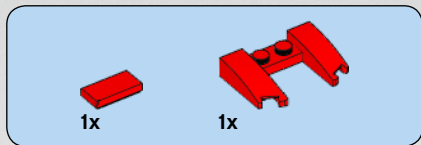

29

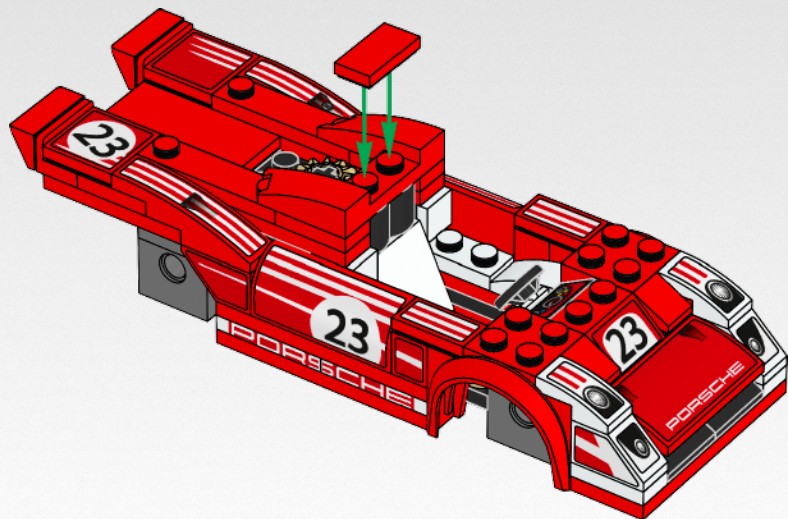



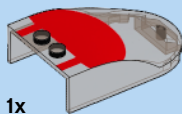

1x

30

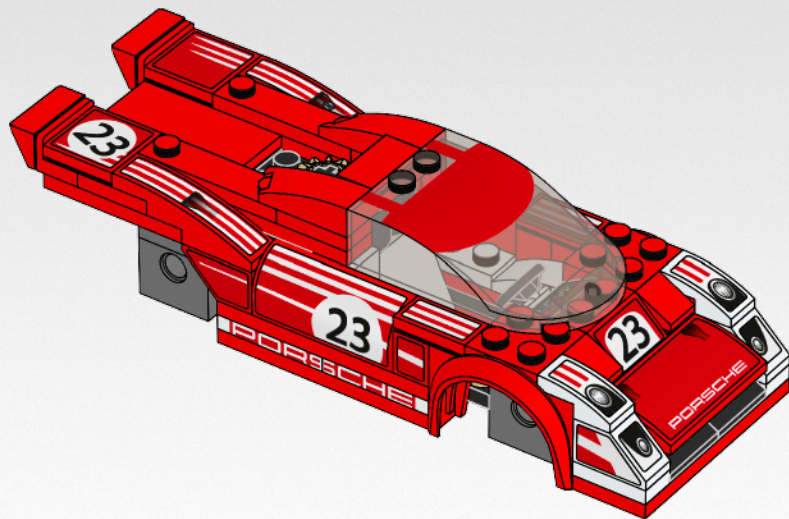



# 31

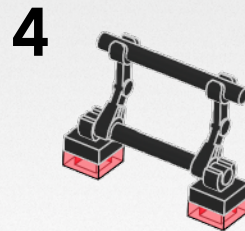
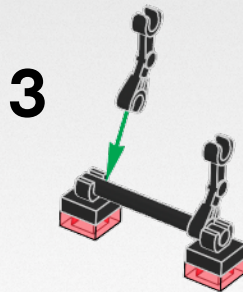
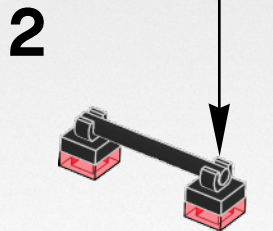
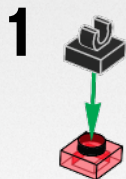

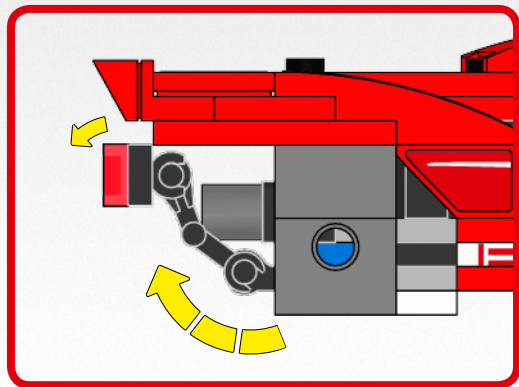
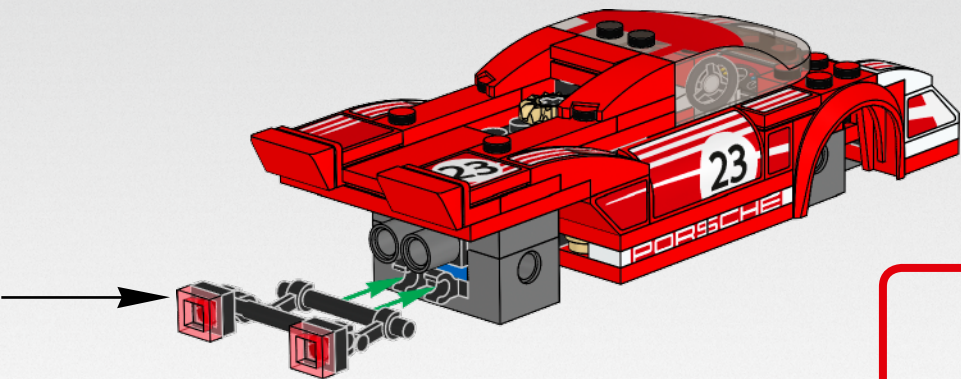

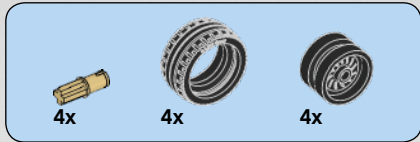

32

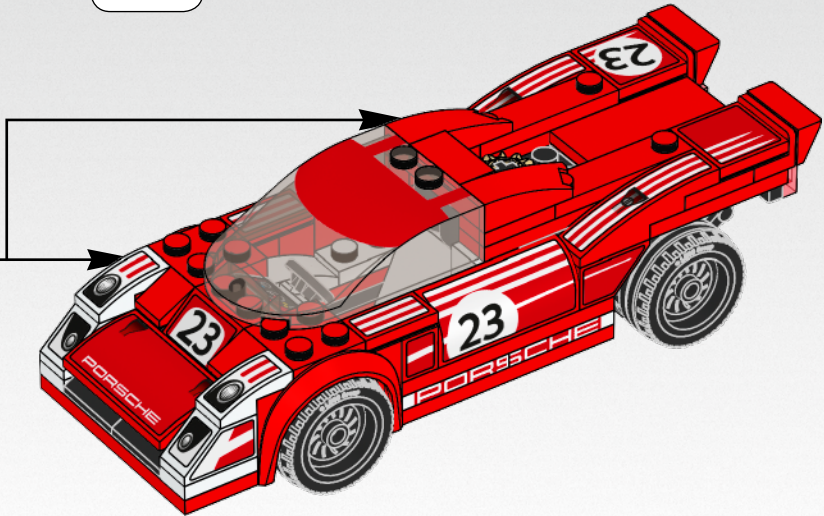
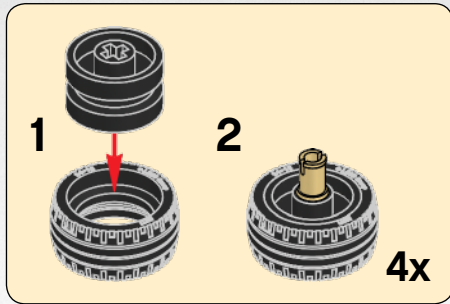

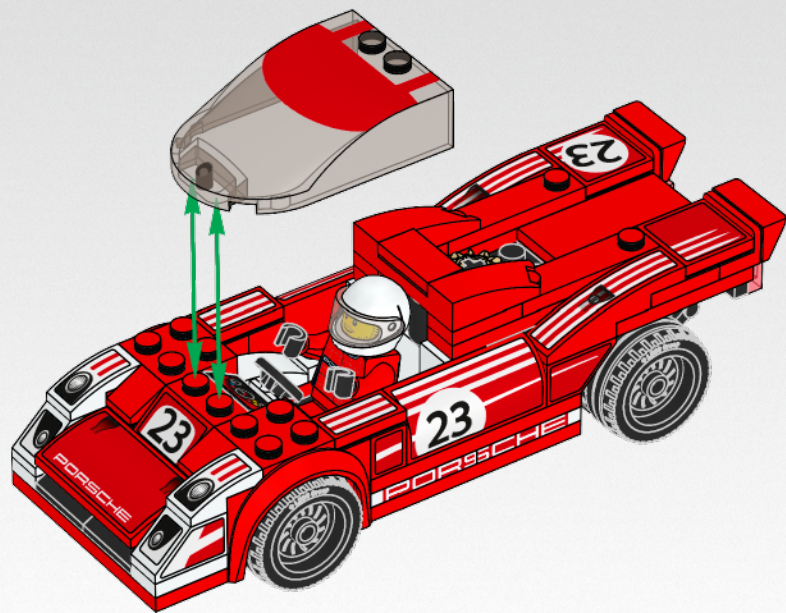

2

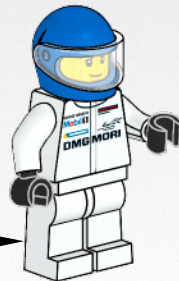
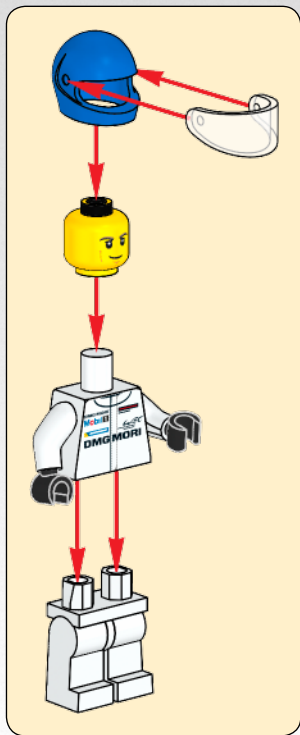
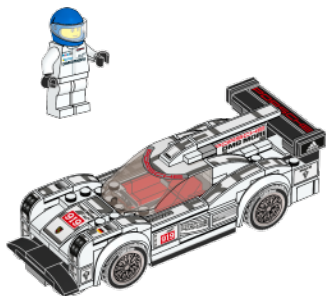
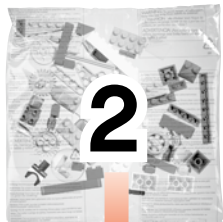

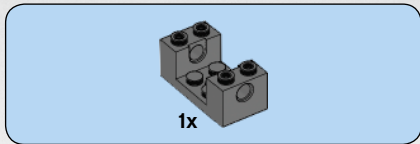
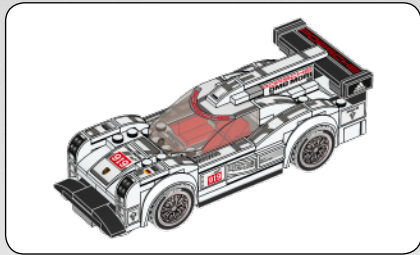

1

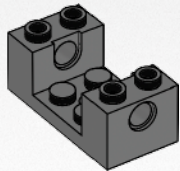

2

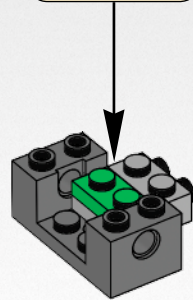
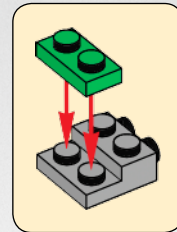



1x

3

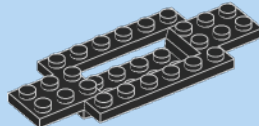
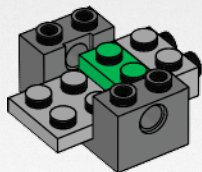

1x

4

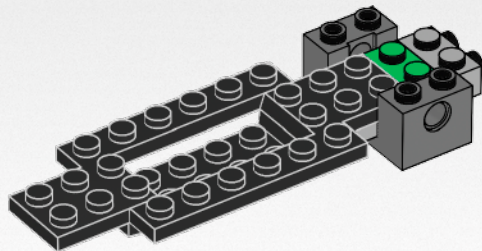



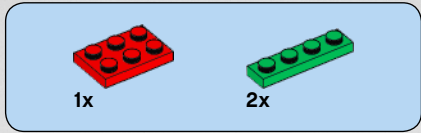

5

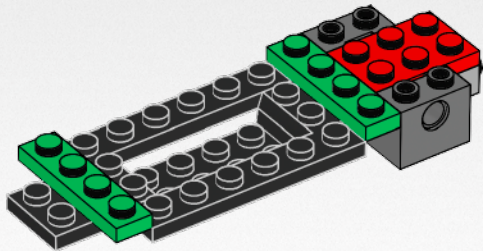



6

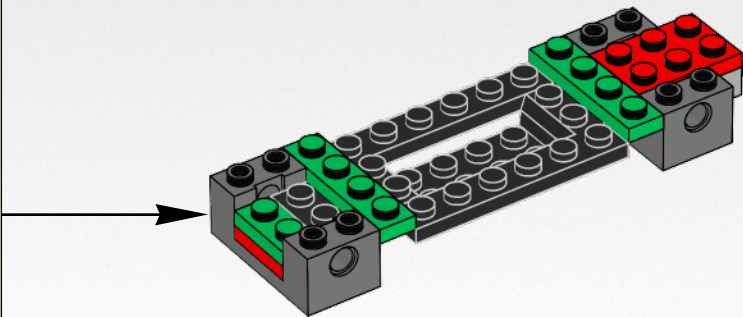
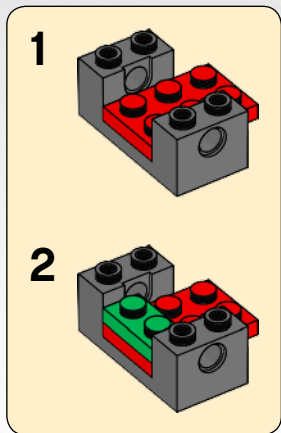

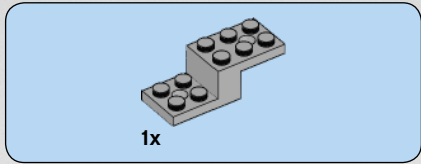

7

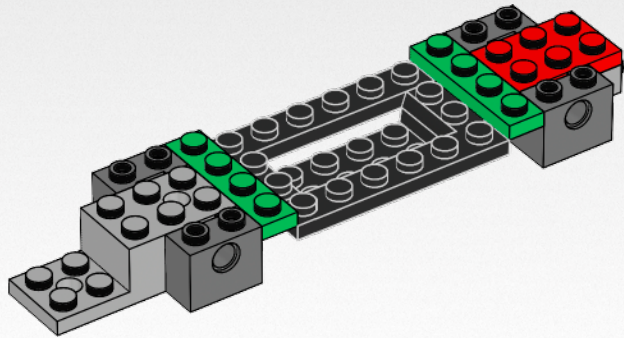

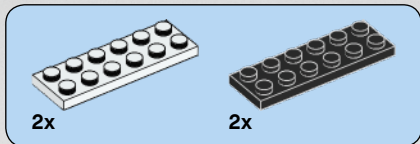

8

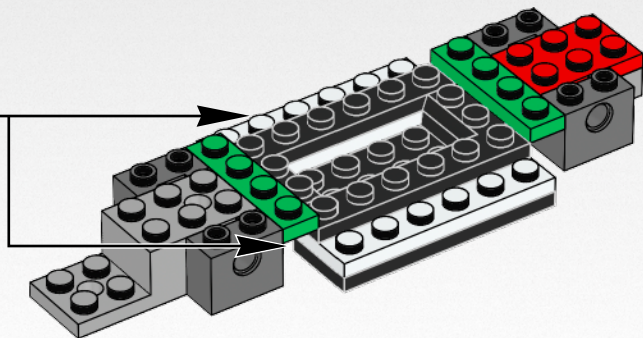
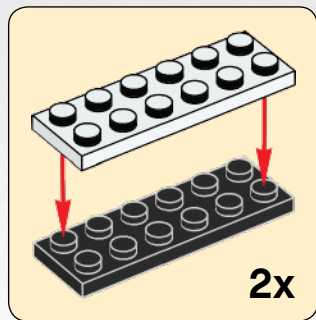



2x



2x

9

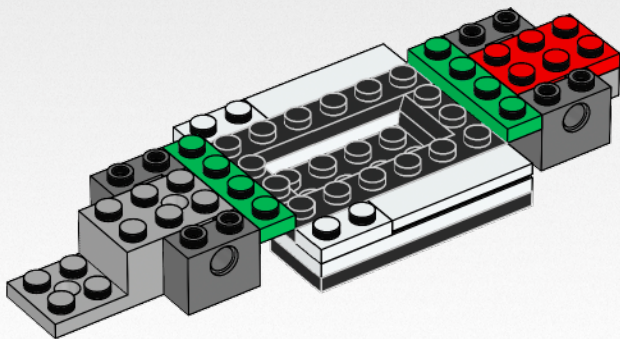

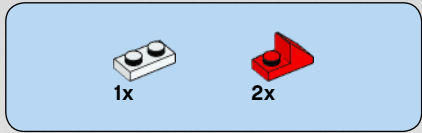

10

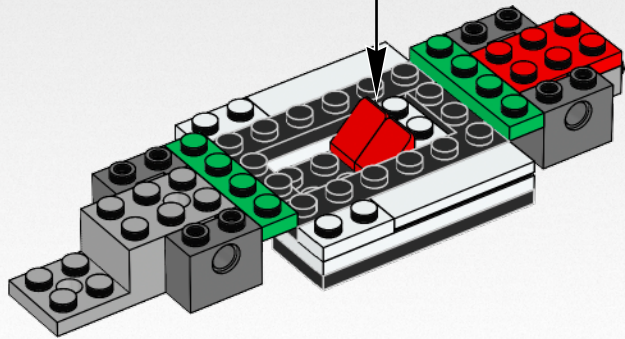
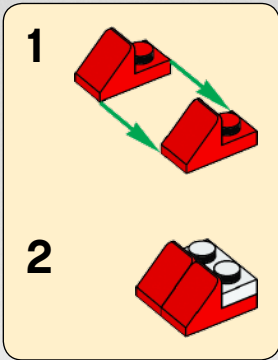



2x

11

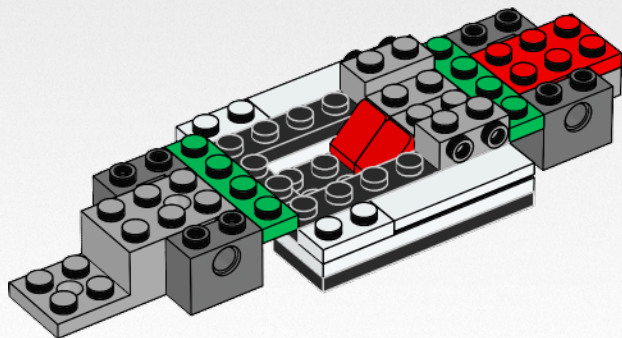



1x



2x

# 12

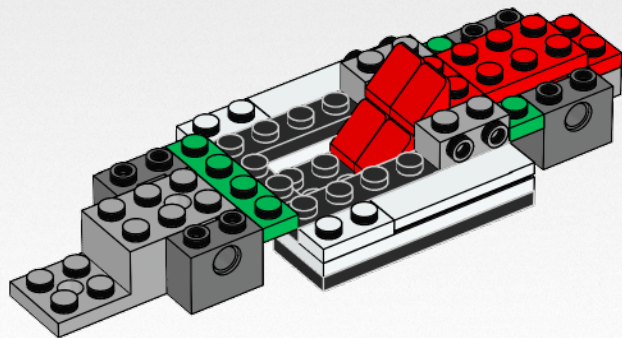



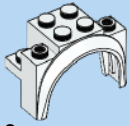

2x

# 13

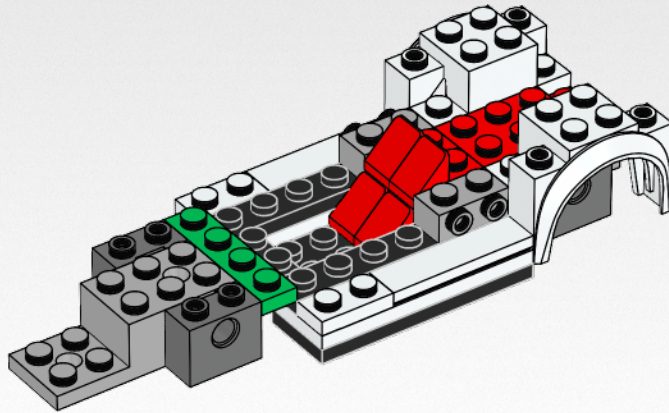

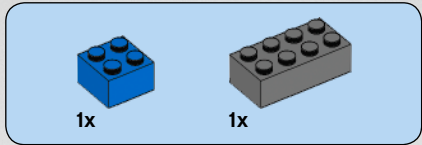

14

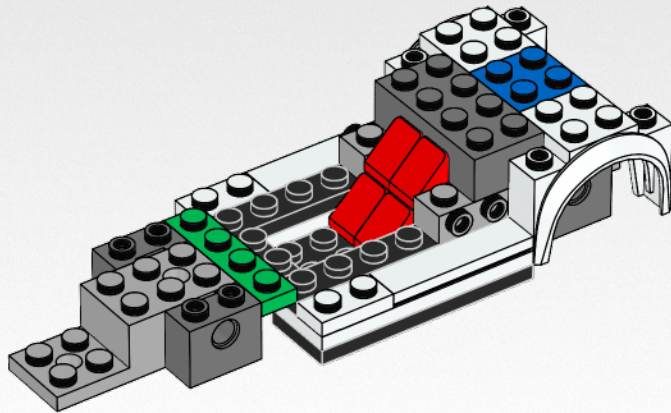

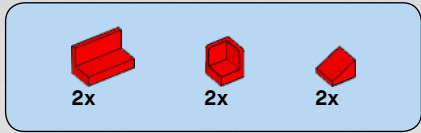

# 15

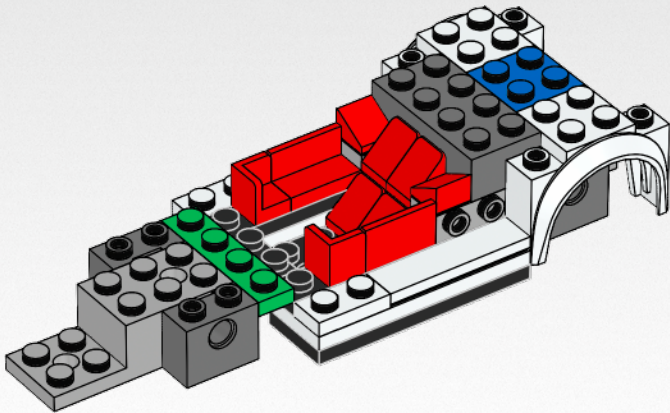

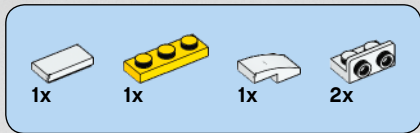

# 16

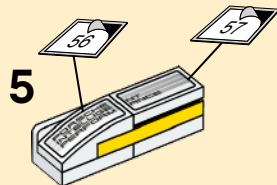
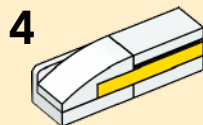
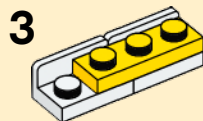
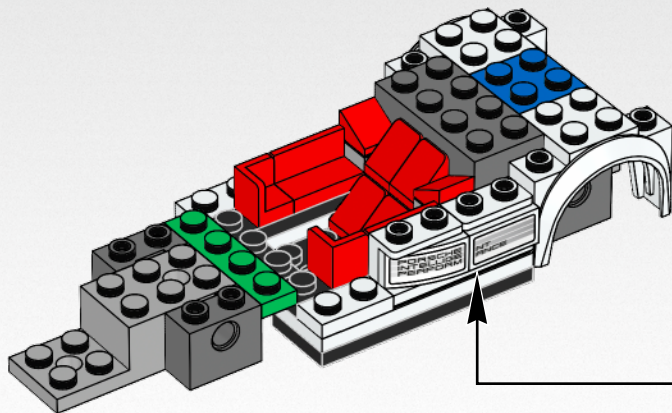

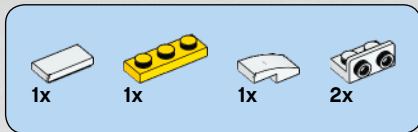

# 17

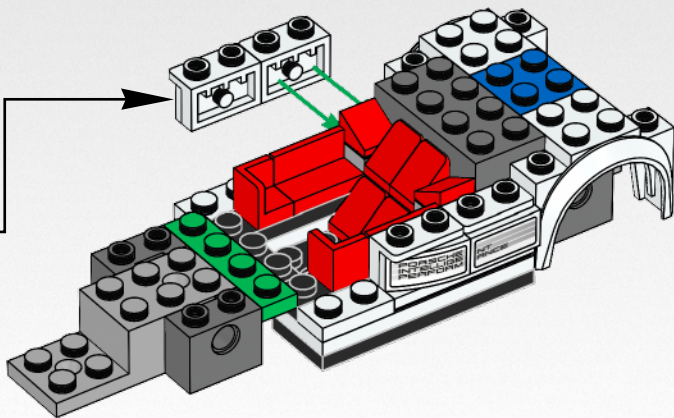
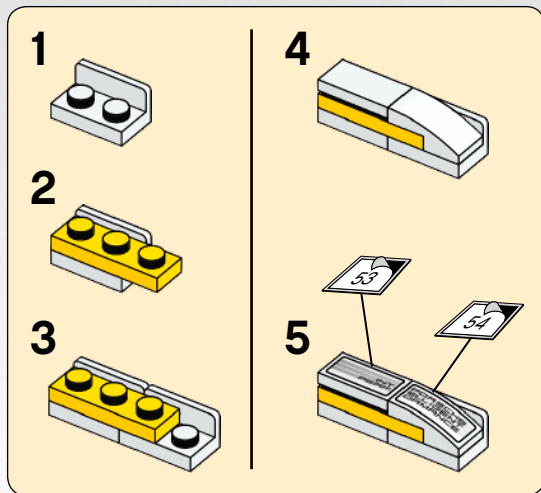



2x



1x

# 18

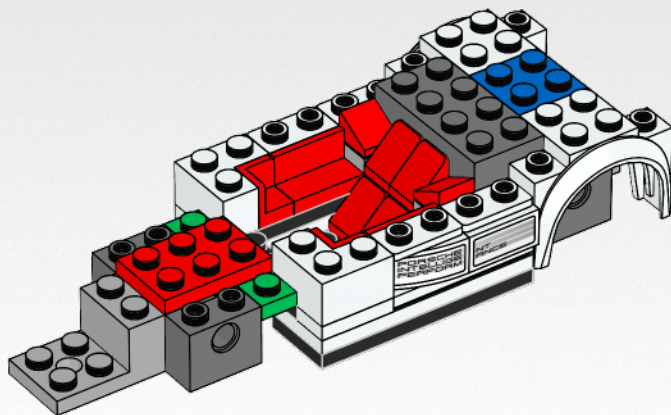

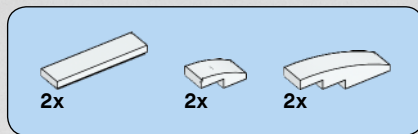

19

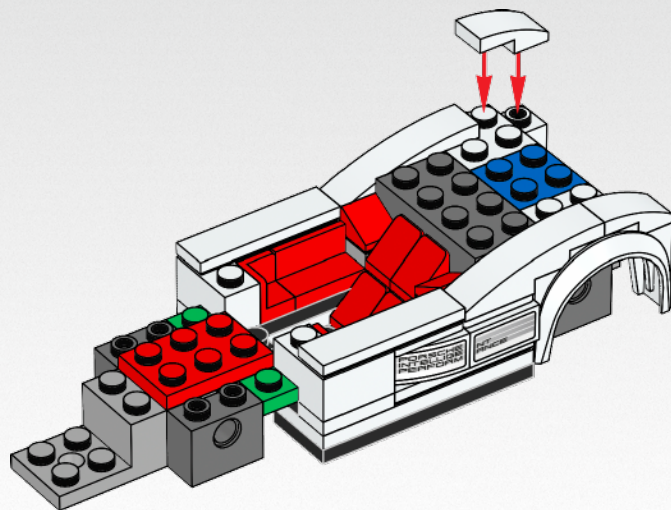

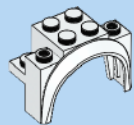

2x

20

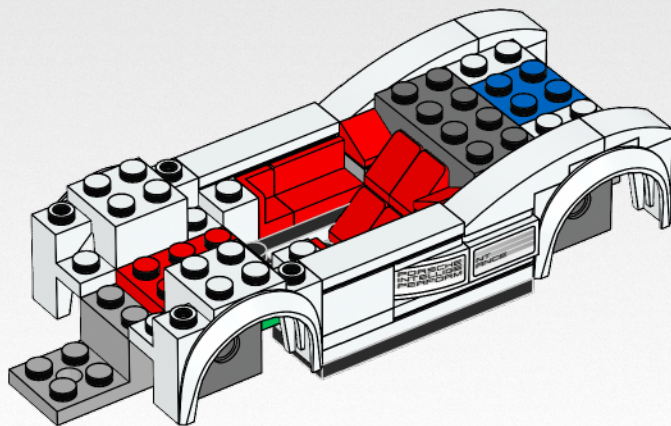





2x



1x



2x

# 21



2x

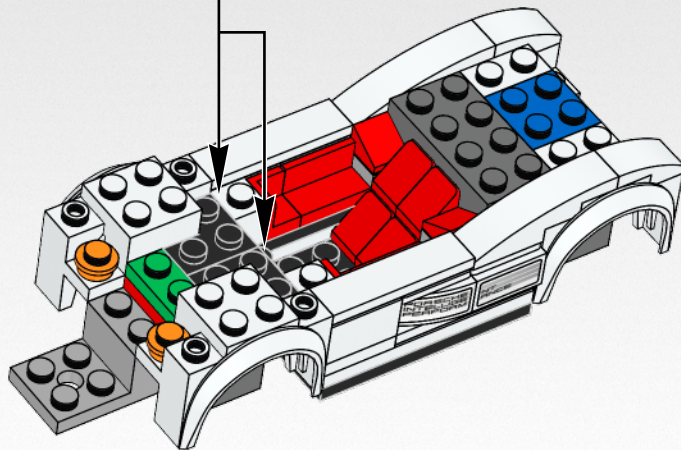

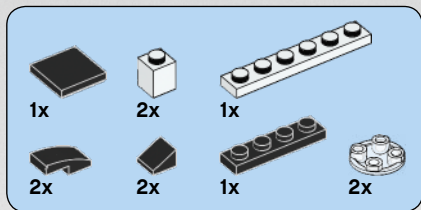

# 22

1

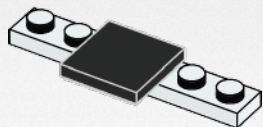

2

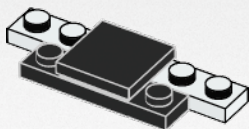

3

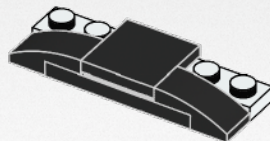

4

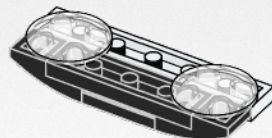

5

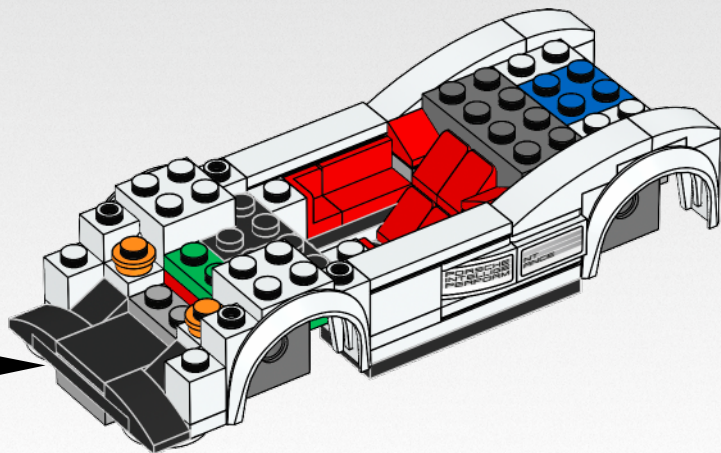
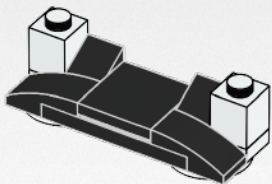



4x



1x

# 23

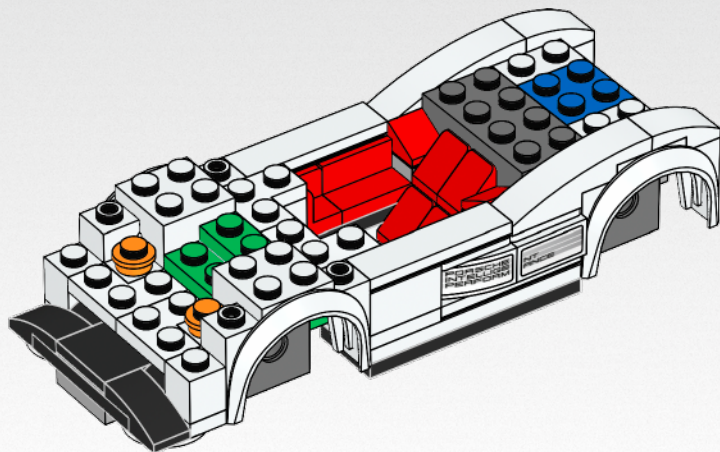



1x



1x

# 24

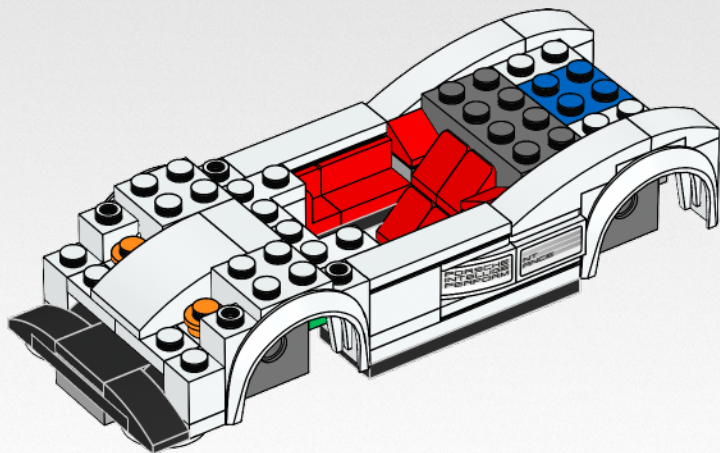



2x

# 25

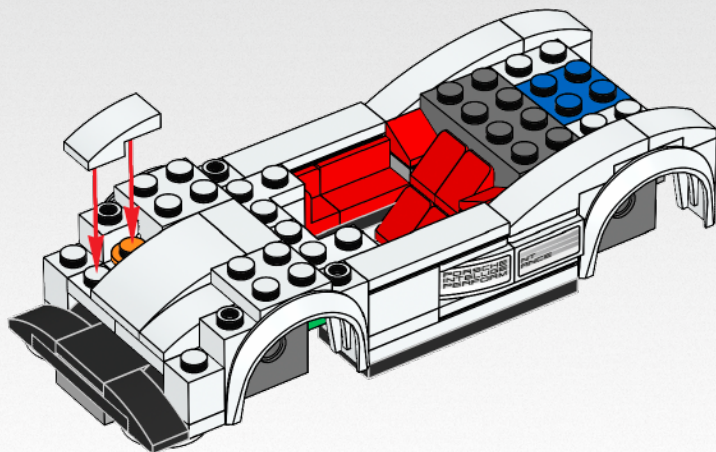



2x

# 26

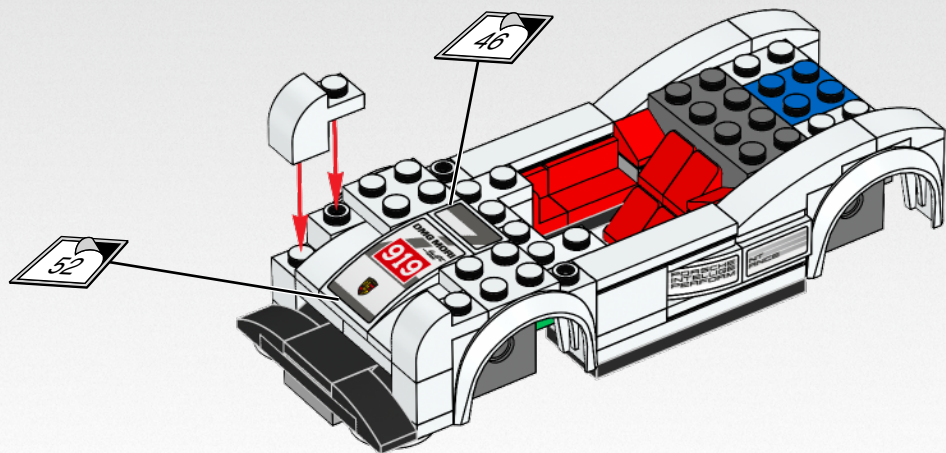



2x



2x

# 27

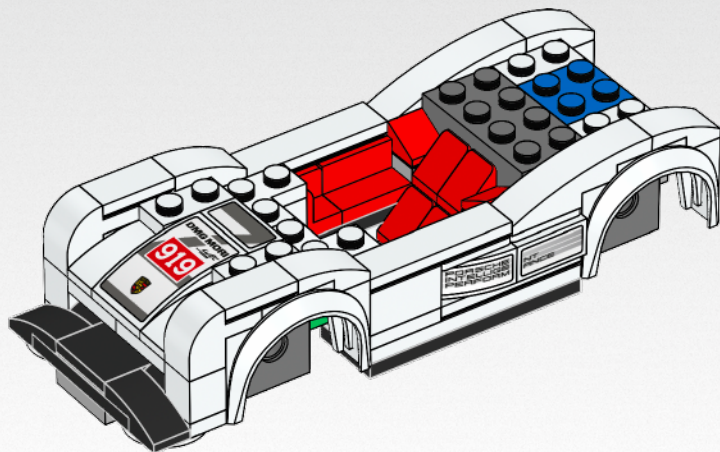



# 28

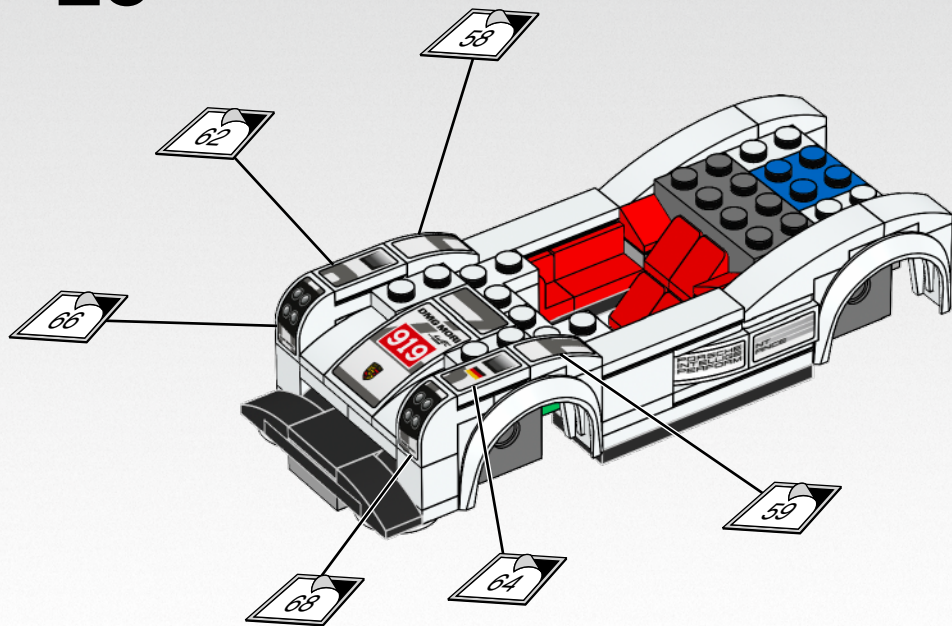

# 29

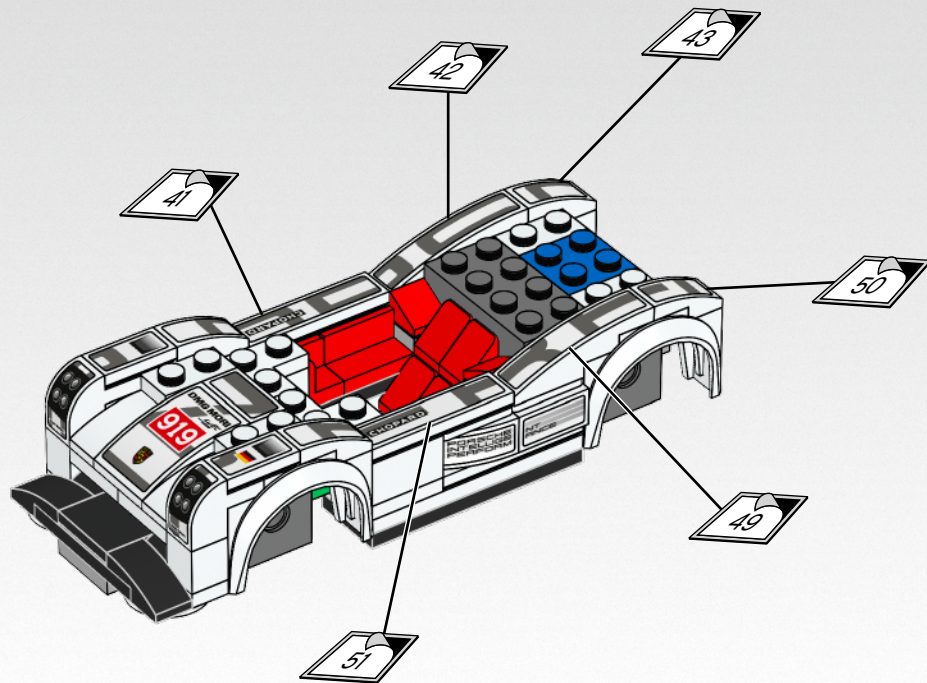

# 30

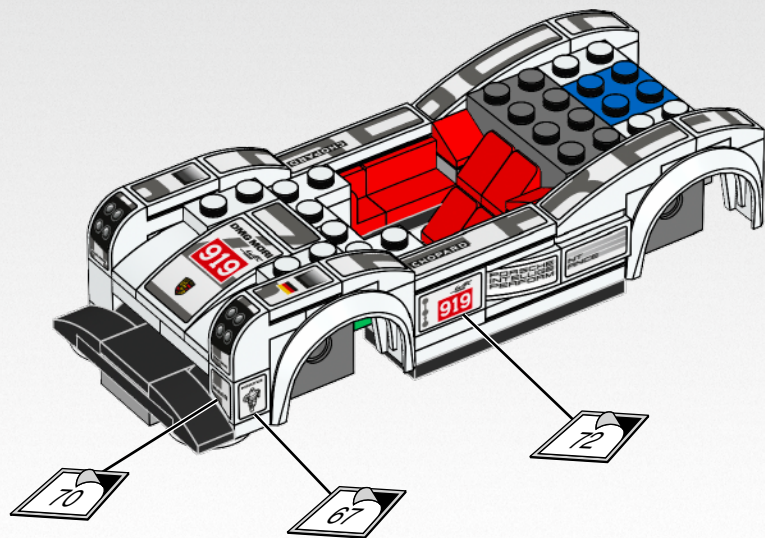

# 31

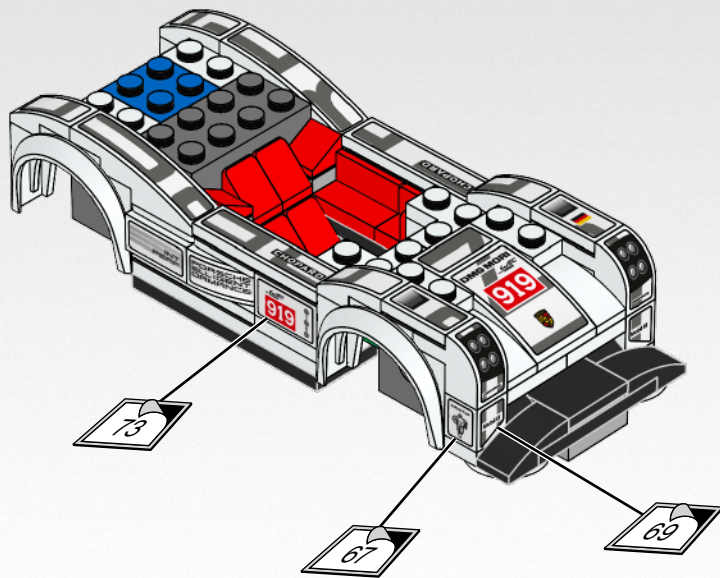
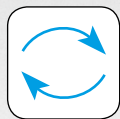

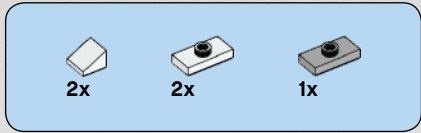

# 32

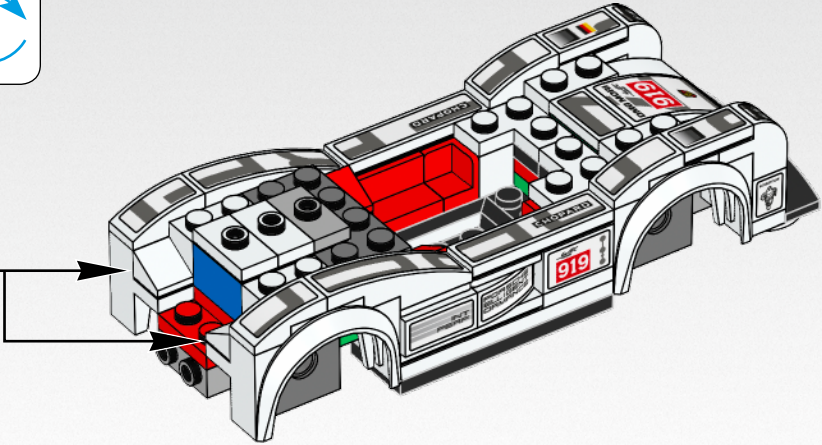
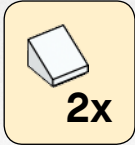

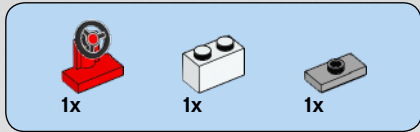

# 33

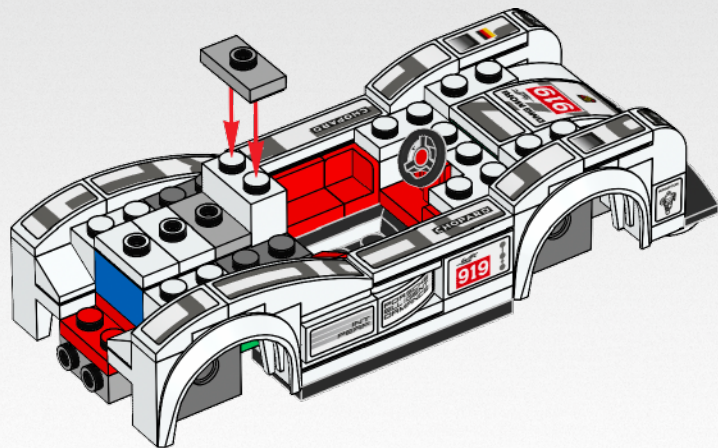



2x



2x

# 34

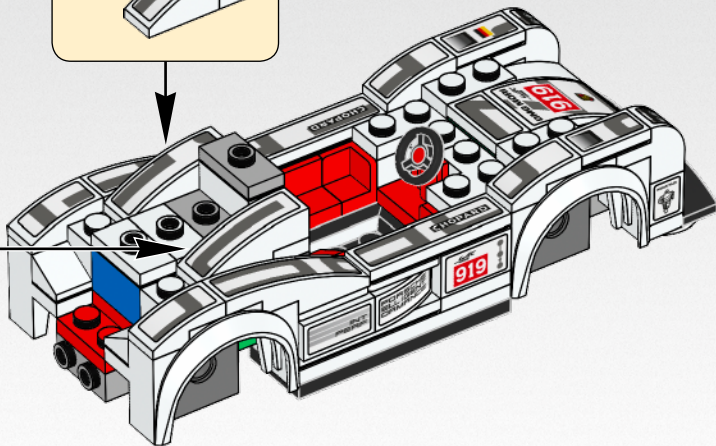
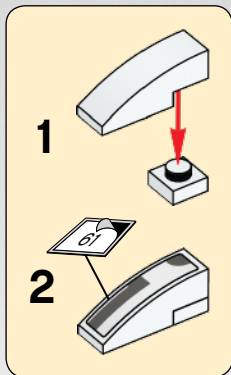
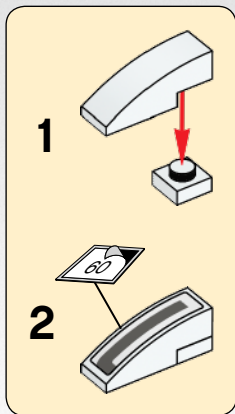

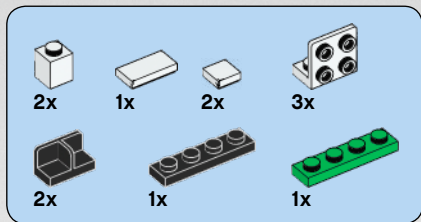

# 35

1

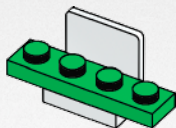

2

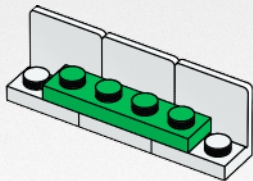

3

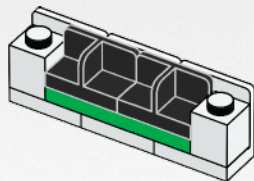

4

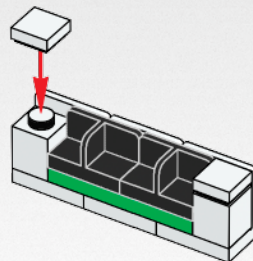



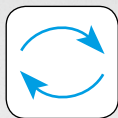

5

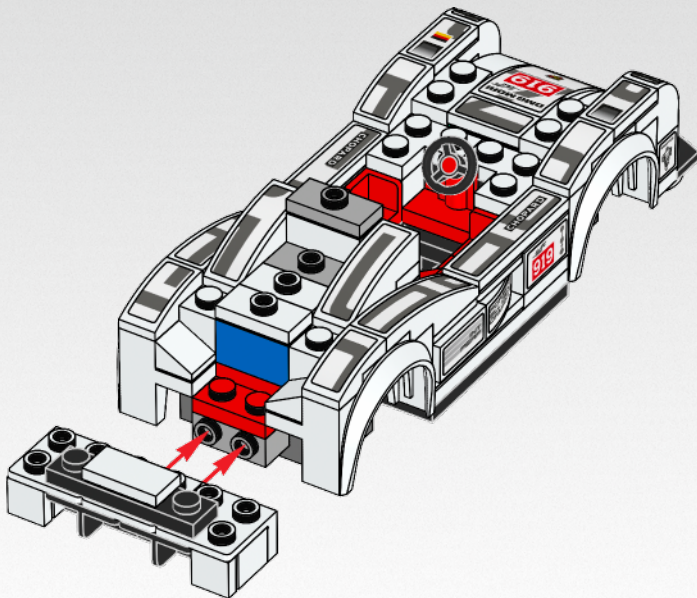
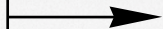
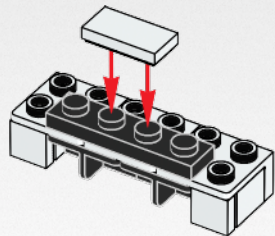



2x



1x



1x

# 36

1

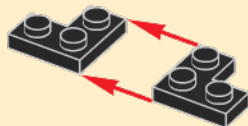

2

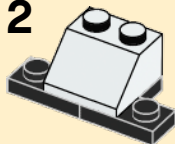

3

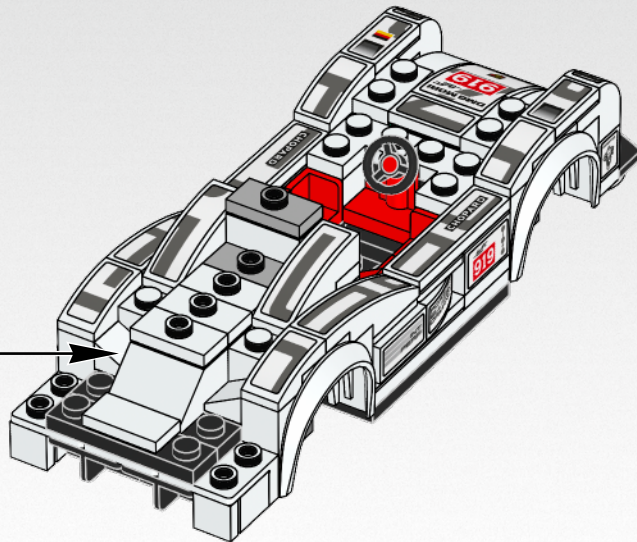
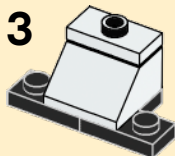



2x



2x

# 37

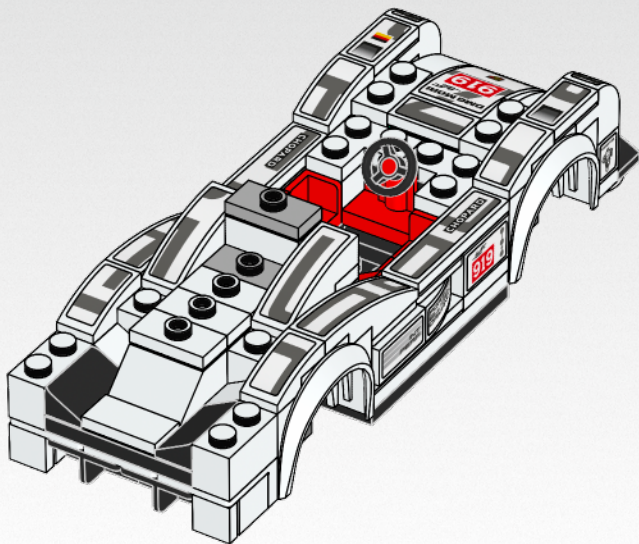

# 38

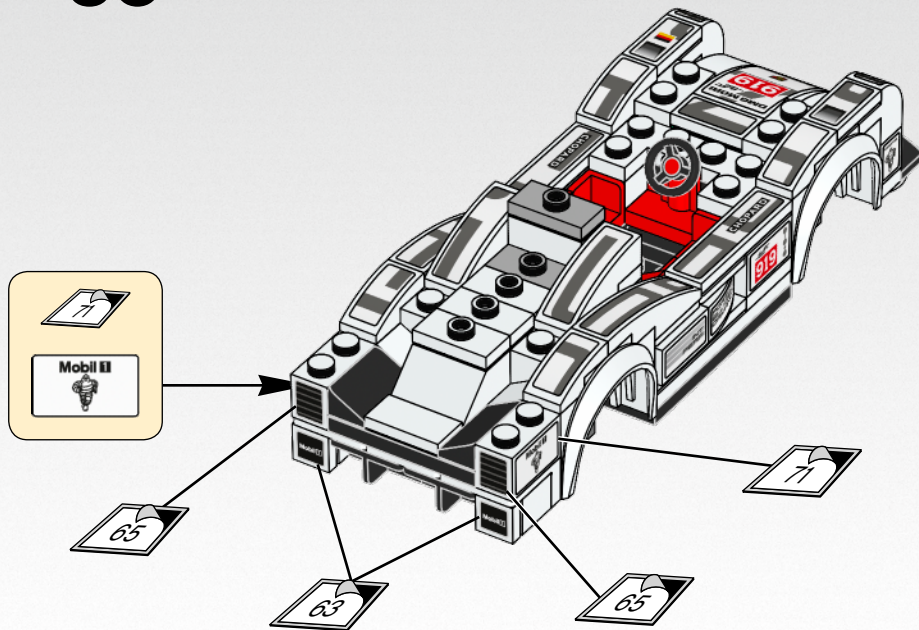

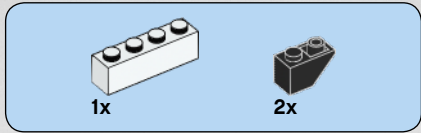

# 39

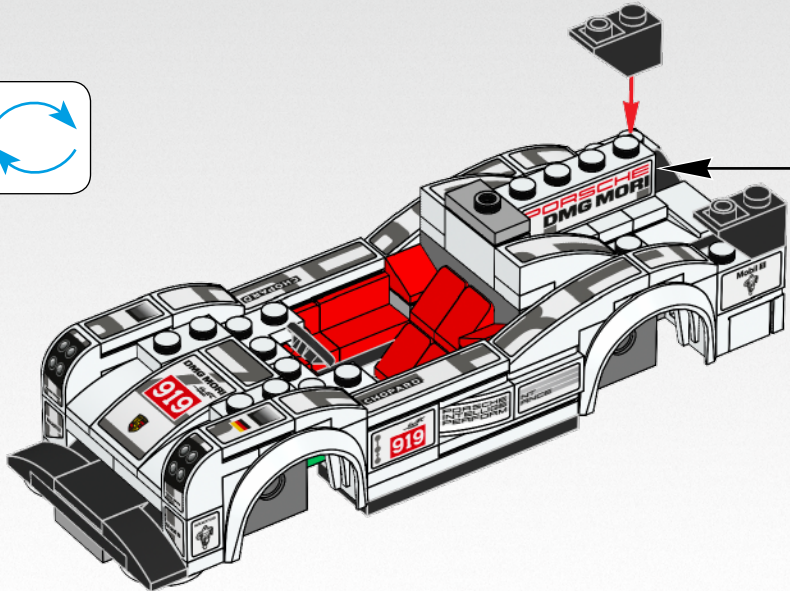
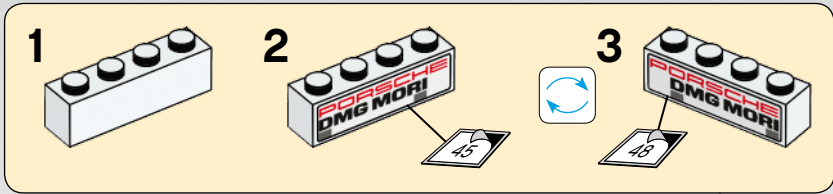

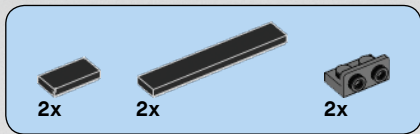

# 40

1

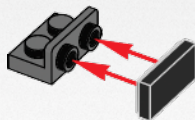

2

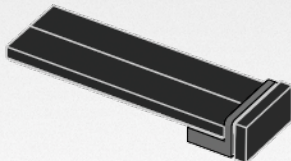

3

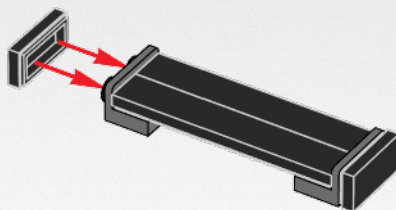

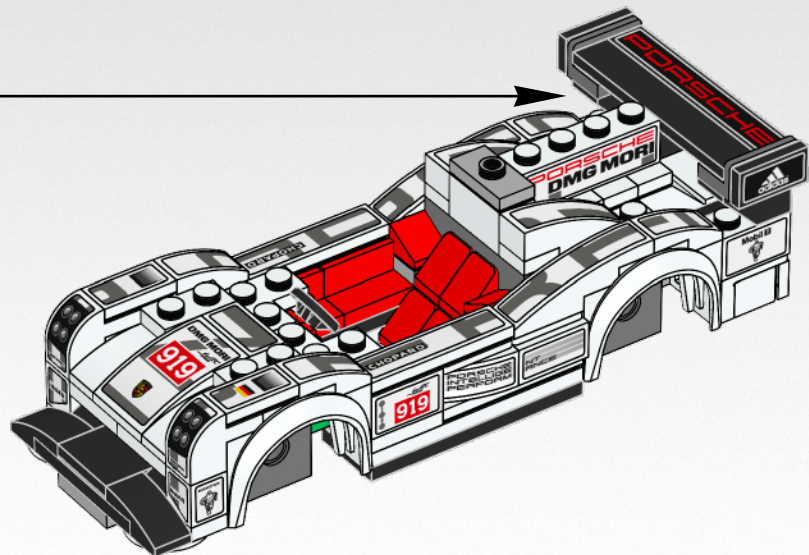
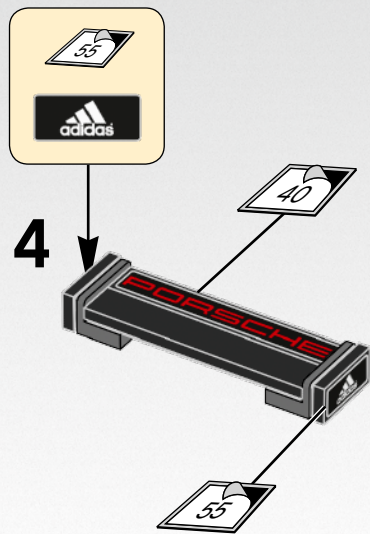

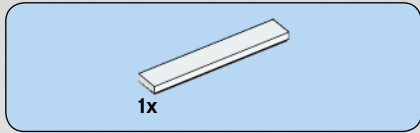

41

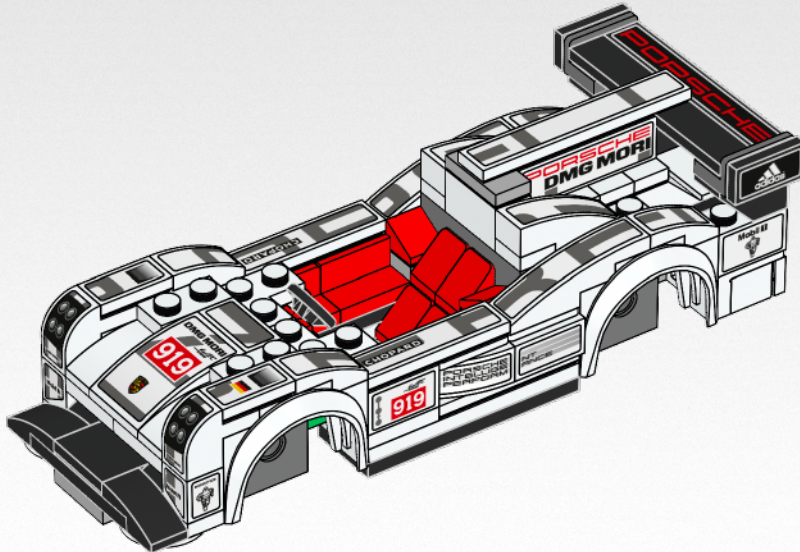
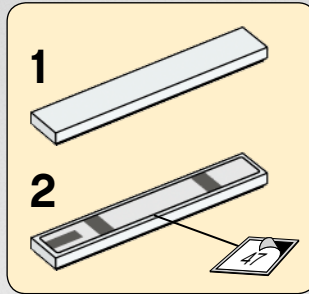



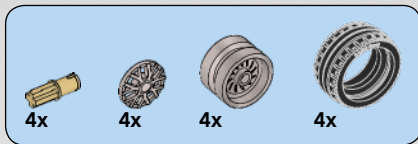

# 42

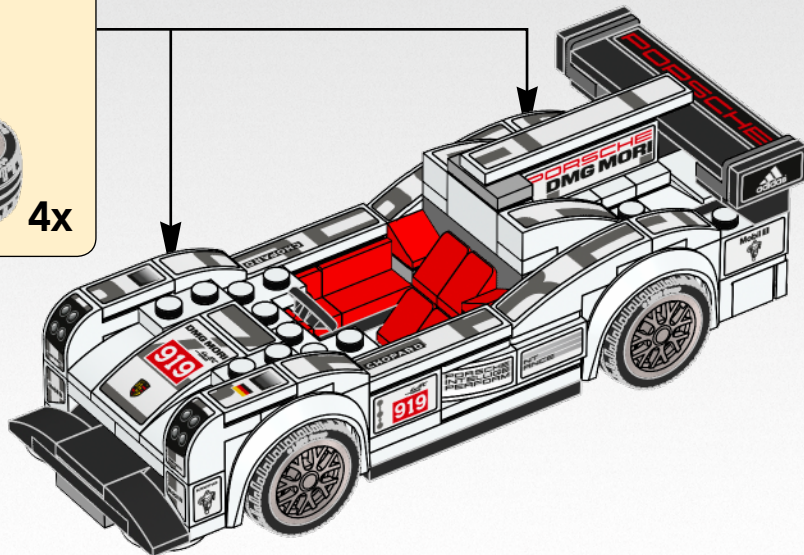
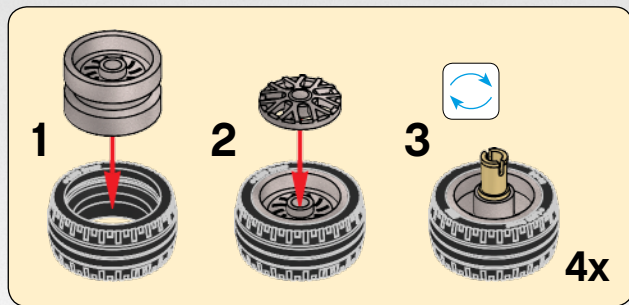

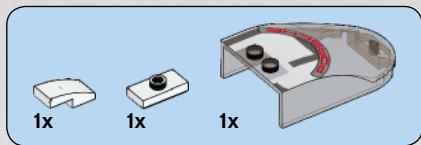

# 43

