



STAR WARS

75144



LEGO.com

About the LEGO® *Star Wars*™ Design Team

LEGO® *Star Wars*™ started in 1999, and we have made new models for the product line every year since then. The LEGO *Star Wars* design team consists of eight model designers and four graphic designers. The team is a mix of brand-new designers with fresh ideas, and experienced LEGO *Star Wars* designers with many models under their belts.

This is an ideal team for creating new, innovative LEGO *Star Wars* models, as well as revising and improving previous LEGO versions of classic and iconic *Star Wars* ships. The focus of our main LEGO *Star Wars* product line is to make cool, fun, and inspiring LEGO *Star Wars* models for children.

For LEGO Direct we have the opportunity to make even bigger, more challenging models with special attention to accuracy and details. These models are fun and exciting to develop, but they are also a huge challenge! We always do our very best, and hope you will enjoy building this one.

Happy building!



Jens Kronvold Frederiksen
Design Director, LEGO *Star Wars*





About the Snowspeeder



© & ™ Lucasfilm Ltd.

The Incom Corporation is best known for its production of the T-65 X-wing Starfighter, but it also produced an airspeeder that would become one of the main vehicles used by the Alliance during the Galactic Civil War to Restore the Republic in 3 ABY. T-47 airspeeders, more commonly known as snowspeeders, were used extensively in the Rebel Alliance stronghold on Hoth, known as Echo Base. Technicians at Echo Base modified the snowspeeder to change the airspeeder, used mainly for industrial cargo transport, into a light, fast vehicle for both patrol and combat. The glacial weather on Hoth also forced the Rebel Alliance to adapt the snowspeeder to function in frigid temperatures for extended lengths of time. Heaters were added near the drive units, deicing nozzles were added to prevent icing

on control surfaces, and Rebel technicians used scavenged Y-wing parts, armor plates, and refitted cockpit modules to further improve the design and defense capabilities.

Due to its small size, the snowspeeder had a crew of just two: a pilot who could handle the speed and maneuverability of the airspeeder, and a gunner to fire the AP/11 dual laser cannons and harpoon gun. Because the ship lacked shields, armor plating was added to the hull, and repulsorlift engines were installed to dramatically increase the speed, enabling the snowspeeder to be fast enough to dodge weapons fire.

Despite the snowspeeder's humble creation and patchwork modifications, snowspeeder pilots were inventive enough to use the vehicle to its full potential. When they realized laser fire was ineffective against more advanced Galactic Empire vehicles, snowspeeder crews used the harpoon gun and tow cables to tie up the massive legs of the Galactic Empire AT-AT walkers and disable or bring them down entirely.

T-47 airspeeders also proved useful to the Rebel Alliance forces in more than just the frigid climate of Hoth. Rebel Alliance technicians modified the multifaceted cargo transport ship into multiple incarnations besides the snowspeeder. The swampspeeder, for example, was rebuilt with flotation gear and watertight seals. Other variants included the sandspeeder, which was customized with advanced air filters to keep out the sand and engine cooling units to combat the scorching desert sun; and skyspeeders, which had pressurized cockpits and more powerful repulsorlift engines for higher altitudes.

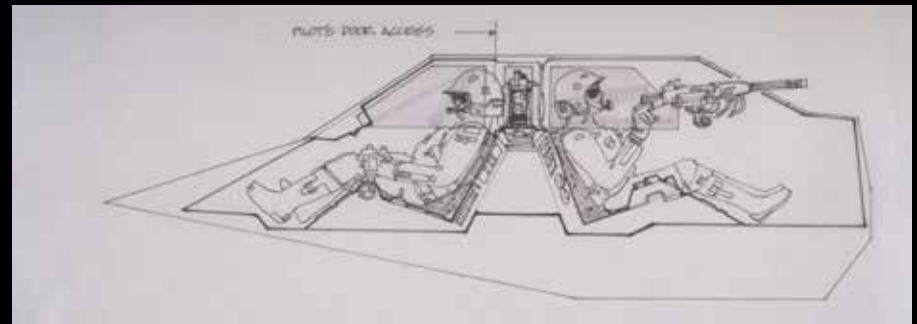

© & ™ Lucasfilm Ltd.

Facts/Specifications

Snowspeeder Facts

Manufacturer.....	Incom Corporation
Model.....	T-47 airspeeder
Class.....	Airspeeder/Repulsorcraft

Technical Specifications - Modified T-47 airspeeder

Length.....	5.3 meters
Maximum speed.....	1,100 km/h
Maximum altitude.....	175 meters
Armaments.....	2 CEC AP/11 double laser cannons Ubrikkian Mo/Dk energy harpoon and tow cable Light repeating blaster cannon
Engine unit.....	Karydee KD49 repulsorlift engines
Crew.....	1 pilot and 1 gunner
Cargo capacity.....	10 kilograms



© & ™ Lucasfilm Ltd.



Meet the Model Designer

Jordan David Scott

Q: How many LEGO® Star Wars™ models have you designed?

A: The UCS snowspeeder will be the fifth LEGO Star Wars model that I have worked on that has been released.

Q: What kind of reference material did you use to begin designing the snowspeeder?

A: First, I looked at the previous UCS snowspeeder that was designed back in 2003 to see what inspiration I could take from that. Second, I had various images and film stills from our Star Wars books and *Star Wars: The Empire Strikes Back* movie.

Q: How was designing the snowspeeder different from your work on other LEGO Star Wars models?

A: I think the main difference is the level of detail that you can put into the UCS models. These larger models allow for more complex building techniques and levels of detail that I personally love building into the models I work on. My favorite detail in the UCS snowspeeder was the use of LEGO minifigure ski blades on the underside to resemble part of the cooling fins. These UCS models are also meant to resemble the real vehicles as accurately as possible. This means difficult angles or features can become quite tricky to recreate; the back window of the cockpit was particularly difficult to build as it slopes in three different directions but also has to support the hinge connection for the cockpit.



Jordan David Scott

Q: The front of the snowspeeder has an easily recognizable, angled bow. Was this a challenge to recreate using LEGO bricks?

A: The angles were very tricky to achieve and this was something I wanted to do differently from the previous UCS snowspeeder. Back in 2003 we did not have as many elements that could achieve this look, and so it was built using angled bricks. Now, thanks to the miniature ball joints, I was able to achieve a more sleek and accurate front.

Q: How did you plan the design for the snowspeeder? Did you use artist sketches or film stills to inspire your design of the model?

A: Most of my inspiration came from film stills and cross-section illustrations in *Star Wars*™ encyclopedias that we have in work, and use a lot for reference.

Q: There are smaller versions of the snowspeeder in the LEGO® Star Wars Battle of Hoth set: how is this larger model similar to those smaller snowspeeders?

A: I think one thing that is similar even though the sizes are so different is the functionality; the UCS model has several functions that are similar to the smaller version: for example, the rotating rear gun and moveable air brakes. These functions make it a more interesting model and building experience.

Q: As a vehicle used for reconnaissance and defense, snowspeeders are equipped with both weapons and speed. How do these elements feature in the final design?

A: The high-speed nature of the snowspeeder is apparent in its compact design, using sharp angles to make it more streamlined; this was something I was very conscious of while designing the model and made the underside less bulky and brick heavy. Another part I wanted to build as accurately as possible were the turbo lasers, which are designed to slant inward so that they will focus fire at a certain point. This was a lot harder to build than I thought it would be. At first glance it might not seem apparent, but they are in fact built on a very slight angle of about 10-15 degrees.



Q: Is there a specific feature of the model that you enjoyed designing the most?

A: I had a lot of fun designing the interior of the cockpit, like the back-to-back seats and all the small controls surrounding them, which were challenging to fit inside such a small space but just added so much detail.

Q: With a rotating rear gun, an opening cockpit, and moveable air breaks, there are many moving parts to this model. How did you create the design to ensure stability?

A: All of the moving parts on the model are fairly small builds, which meant it was easier to stabilize them. I did have some challenges with the cockpit as the two new window elements that I used to create it were very large and heavy and we wanted to ensure you could display it with the cockpit open or closed.



Meet the Graphic Designer

Marie Sertillanges

Q: Are these the first LEGO® Star Wars™ minifigures you've designed?

A: No, my first minifigure design was the last Naboo Pilot from 2015. The minifigures for this set are actually mostly existing designs. We decided to keep them since they are really iconic, while improving them with decorated arms. It was, however, my first time designing minifigure arms.

Q: What do you use to begin designing the decorations for LEGO Star Wars minifigures?

A: My very first step is to gather all the visual references I have for the character and try to build the big picture of their appearance. Then, I choose which LEGO colors I will use for the torso, arms, legs, and hands. The next step is to sketch the general shapes of the design, to translate the look of the character into LEGO style. To finalize the design, I go back and forth from the references to the minifigure sketch until I am satisfied, or until I am out of time!

Q: Minifigures are very small. What are some of the challenges in creating designs that are both detailed and easy to understand?

A: To ensure that the design is full of cool details but still readable, I start with extra simple and big shapes. Having the right composition at any time of the design is essential, and it is easier to achieve when you have fewer elements. From there I will "cut down" these big shapes to more detailed ones, as you would do while sculpting. The hard part is to choose the right details in order to really capture the character's appearance or personality!



Marie Sertillanges

Q: What do you use as reference material for designing the minifigure decos? Film stills? Licensed art?

A: For the old *Star Wars* movies we use mainly film stills or photos from production, directly from LucasFilm. At that time in the film industry, behind the scenes documentation was not as complete as nowadays, which makes it a bit harder for us to collect all the accurate references.

Q: The flight suits worn by the characters in the *Star Wars*™ films are incredibly detailed. How do you choose which details to focus on when designing the art for the minifigures?

A: The design of these pilots was made way before I became a LEGO® graphic designer, but I can speak about my general way of approaching a minifigure. When I design a character, I choose what makes him/her really special, what defines him/her. The layering and materials are important on the Rebel Uniforms, and wrinkles, for example, can be used to show material qualities as well as make a character less orderly or more dynamic. I always bear in mind that you cannot and don't need to draw everything like in real life. Think of looking at reality through a LEGO filter.

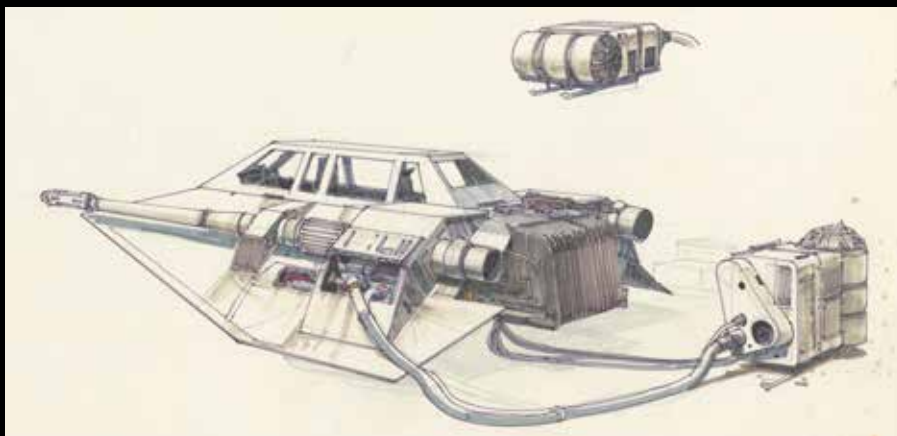

© & ™ Lucasfilm Ltd.



© & ™ Lucasfilm Ltd.

Q: How do these minifigures compare to others you've designed?

A: Most of the minifigures we design are only decorated on the torso, head, and legs. Decorating on the arms is only reserved for special minifigures. I designed both main heroes and secondary characters like Zev Senesca. Compared to the main heroes, these generic characters are more challenging to design because you have to look closer to find what differentiates them from the crowd. To be honest, I prefer working on side characters as they seem plain at first sight but hold unique stories when I dig deeper.



Meet the Art Director

Michael Sion

Q: Have you worked on package design for LEGO® Star Wars™ before?

A: I started working on LEGO *Star Wars* in 2009 and, oddly enough, my first packaging was a set of battle packs with minifigures from the planet Hoth. Now, six years later, I'm back on Hoth with the snowspeeder.

Q: What kind of reference material do you use to begin designing the package art?

A: One of the great things about *Star Wars* is the amount of fan-based material that is out on the web. I like to scan the Internet for a while to immerse myself in the world of *Star Wars*. Usually the model has an iconic scene from the movies that I always try to refer to. Then, while making the packaging, never underestimate the use of making sound effects while creating the packaging fronts.

Q: The snowspeeder is a *Star Wars* vehicle that features predominately in the Battle of Hoth, which takes place in a very snowy environment. How did you ensure that the white vehicle stood out from the white environment?

A: Color, lasers, explosions, and smoke! Explosions have made my life much easier on a number of occasions.

Q: What are the first steps you take when you begin the package design for a new LEGO *Star Wars* set?

A: I always start with the brief to see what the LEGO *Star Wars* product team wants to show. Then I "play study" the model to get a feel for its potential.



Michael Sion

Q: Are there specific techniques you use to depict the features and functions of a particular set on the box art?

A: I invariably struggle with function shots. Luckily, we get the models in a 3D program so we can rotate them instead of having to go right to photography. It's predominately trying to get across the idea of cause and effect: for example, showing a set feature that involves pushing or pulling a section of the model and the resulting action. I also try to use depth of field to deemphasize the parts of the model that are only there for context.

Q: What kind of challenges do you face when designing art that will be specifically used for packaging design? How is package art different from other forms of design work?

A: Sometimes challenges can be unexpected. For example, there are times when a model changes during the design, so it is important for us to be flexible with our whole team. Additionally, because we have LEGO® sets all around the world, once in a while we need to put different translations of words or messages on the packaging, which also alters the design slightly. Our team works well together, however, so any challenges we come across we usually solve quickly, so we are able to produce something amazing to share with LEGO Star Wars™ fans everywhere.

Q: When you create packaging art, is your goal to recreate iconic scenes from the Star Wars film franchise, or are you more focused on displaying the unique qualities of the set?

A: First and foremost is the LEGO model, but I try to stay as authentic to the movies as possible.

Q: Is there a part of the design process that you enjoy most?

A: Beginning any new project is very exciting, and I enjoy the first phases of design the most. Before anything is actually started, all you have is the potential to make something, and that to me is the part of the project that is the most fun. Turning over in your head what the scene can be and how to get it on paper is a creative process that I can have a lot of fun with. Watching something be created from the beginning all the way to the end is a fascinating transformation.



À propos de l'équipe de design LEGO® Star Wars™

LEGO® Star Wars™ a commencé en 1999 et nous avons conçu chaque année depuis de nouveaux modèles pour cette gamme de produits. L'équipe de design LEGO Star Wars est composée de huit créateurs de modèles et de quatre graphistes. Cette équipe est un mélange de nouveaux designers avec des idées originales et de designers LEGO Star Wars expérimentés ayant créé de nombreux modèles.

Il s'agit de l'équipe idéale pour créer de nouveaux modèles LEGO Star Wars innovants et pour améliorer les versions LEGO antérieures des célèbres vaisseaux classiques Star Wars. L'objectif de notre gamme principale de produits LEGO Star Wars est de créer des modèles LEGO Star Wars cool, amusants et stimulants pour les enfants.

Pour LEGO Direct, nous avons la possibilité de créer des modèles encore plus grands et plus complexes, en prêtant une attention particulière à la précision et aux détails. Ces modèles sont amusants et fascinants à concevoir, mais ils constituent aussi un énorme défi ! Nous faisons toujours de notre mieux et nous espérons que tu apprécieras l'expérience de construction.

Bonne construction !



Jens Kronvold Frederiksen
Directeur du design LEGO Star Wars





À propos du Snowspeeder



© & ™ Lucasfilm Ltd.

L'Incom Corporation est surtout connue pour la production du X-wing Starfighter T-65, mais elle a aussi produit un airspeeder qui allait devenir l'un des principaux véhicules utilisés par l'Alliance pendant la guerre civile galactique pour restaurer la République, en 3 ap.BY. Les airspeeders T-47, plus couramment connus sous le nom de snowspeeders, étaient largement utilisés dans la forteresse de l'Alliance rebelle sur Hoth, appelée la Base Echo. Les techniciens de la Base Echo ont modifié le snowspeeder afin de transformer cet airspeeder, utilisé principalement pour le transport de marchandises, en véhicule léger et rapide pour la patrouille et le combat. Le climat glacial sur Hoth a aussi obligé l'Alliance rebelle à adapter le snowspeeder pour qu'il fonctionne dans des températures extrêmement froides pendant de longues périodes. Des appareils de chauffage furent placés près des unités de propulsion, des buses de dégivrage furent ajoutées pour empêcher la

formation de glace sur les surfaces de contrôle, et les techniciens rebelles utilisèrent aussi des pièces de Y-wing récupérées, des plaques de blindage et des modules de cabine adaptés pour améliorer le design et les capacités de défense.

En raison de ses dimensions réduites, le snowspeeder avait un équipage de seulement 2 membres : un pilote qui pouvait maîtriser la vitesse et la maniabilité de l'airspeeder et un artilleur pour tirer avec les doubles canons laser AP/11 et le fusil harpon. Le vaisseau étant dépourvu de boucliers, des plaques de blindage furent ajoutées au fuselage, et des moteurs à répulsion furent installés pour augmenter la vitesse de façon spectaculaire, permettant au snowspeeder d'être assez rapide pour éviter les tirs.

Malgré la création humble du snowspeeder et ses modifications disparates, les pilotes du snowspeeder furent assez inventifs pour utiliser tout le potentiel du vaisseau. Lorsqu'ils réalisèrent que le tir laser était inefficace contre les véhicules plus perfectionnés de l'Empire galactique, les membres de l'équipage du snowspeeder utilisèrent le fusil à harpon et les câbles de remorquage pour attacher les énormes pattes des véhicules AT-AT de l'Empire galactique et les désactiver ou les neutraliser complètement.

Les airspeeders T-47 se sont aussi révélés utiles pour les forces de l'Alliance rebelle ailleurs que dans le climat glacé de Hoth. En effet, les techniciens de l'Alliance rebelle ont transformé le vaisseau de transport à multiples facettes en de multiples incarnations, en plus du snowspeeder. Il y a eu, par exemple, le swampspeeder qui a été reconstruit avec des équipements de flottaison et des joints étanches. Les autres variantes incluaient le sandspeeder, qui a été adapté avec des filtres à air de pointe pour empêcher le sable d'entrer et des unités de refroidissement du moteur pour lutter contre le soleil brûlant du désert, et les skyspeeders, qui avaient des cabines pressurisées et des moteurs à répulsion plus puissants pour des altitudes plus élevées.

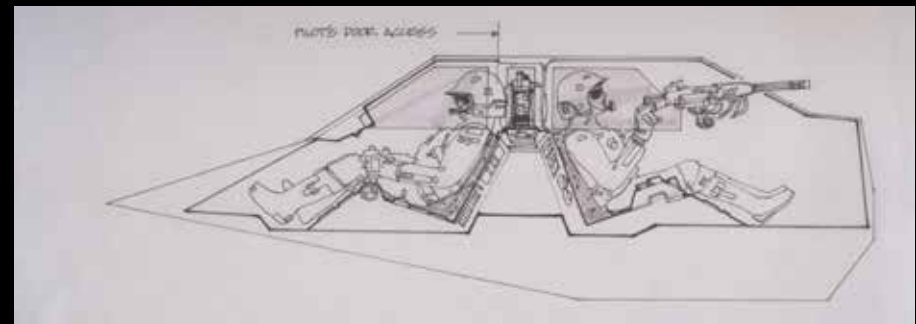

© & ™ Lucasfilm Ltd.

Informations/caractéristiques

Informations sur le snowspeeder

Fabricant.....	Incom Corporation
Modèle.....	Airspeeder T-47
Classe.....	Airspeeder/Vaisseau à répulsion

Caractéristiques techniques : T-47 airspeeder modifié

Longueur.....	5,3 mètres
Vitesse maximale.....	1 100 km/h
Altitude maximale.....	175 mètres
Armement.....	2 doubles canons laser CEC AP/11 Harpon à énergie Ubrikkian Mo/Dk et câble de remorquage Canon léger à répétition
Moteurs.....	Moteurs à répulsion Karydee KD49
Équipage.....	1 pilote et 1 artilleur
Capacité cargo.....	10 kilogrammes



© & ™ Lucasfilm Ltd.

Rencontre le designer du modèle

Jordan David Scott

Q : Combien de modèles LEGO® Star Wars™ as-tu conçus ?

R : Le snowspeeder de la série de collection suprême est le cinquième modèle LEGO Star Wars lancé sur lequel j'ai travaillé.

Q : Quel type de matériel de référence as-tu utilisé pour commencer à concevoir le snowspeeder ?

R : J'ai d'abord regardé le précédent snowspeeder qui a été conçu en 2003 pour voir comment je pouvais m'en inspirer. Ensuite, j'avais plusieurs images et photos des films dans nos livres Star Wars et le film Star Wars : L'Empire contre-attaque.

Q : En quoi la conception du snowspeeder était-elle différente de ton travail sur d'autres modèles LEGO Star Wars ?

R : Je pense que la principale différence était le niveau de détails que l'on peut mettre dans les modèles de la série de collection suprême. Ces modèles plus grands permettent des techniques de construction plus complexes et des niveaux de détail que j'adore intégrer dans les modèles sur lesquels je travaille. Mon détail préféré dans le snowspeeder a été l'utilisation de lames de ski LEGO miniatures sur le dessous, qui ressemblent à une partie des ailerons de refroidissement. Ces modèles de collection sont aussi conçus pour ressembler autant que possible aux vrais véhicules. Ceci signifie que certains angles ou caractéristiques peuvent devenir assez difficiles à recréer : la fenêtre arrière de la cabine a été particulièrement difficile à construire car elle est inclinée dans trois directions différentes mais doit aussi soutenir la charnière de la cabine.



Jordan David Scott

Q : L'avant du snowspeeder a une proue à angle facilement reconnaissable. Était-ce un défi de la recréer en utilisant les briques LEGO ?

R : Les angles étaient très compliqués à obtenir et c'était quelque chose que je souhaitais faire différemment du snowspeeder précédent. En 2003, nous n'avions pas autant d'éléments pour obtenir cet aspect, il fut donc construit avec des briques à angle. Maintenant, grâce aux joints à boule miniature, j'ai pu obtenir un avant plus élancé et plus fidèle.

Q : Comment as-tu planifié la création du snowspeeder ? As-tu utilisé des esquisses ou des photos du film pour t'aider dans la création de ce modèle ?

R : Je me suis principalement inspiré des photos du film et des illustrations transversales des encyclopédies *Star Wars*™ que nous avons et que nous utilisons beaucoup comme référence.

Q : Il y a des versions plus petites du snowspeeder dans l'ensemble de la bataille de Hoth LEGO® Star Wars. En quoi ce modèle plus grand est-il similaire aux snowspeeders plus petits ?

R : Je pense qu'une chose similaire, même si les dimensions sont si différentes, est la fonctionnalité : le modèle de la série de collection suprême a plusieurs fonctions qui sont semblables à la version plus petite, par exemple le fusil arrière rotatif et les aérofreins mobiles. Ces fonctions en font un modèle et une expérience de construction plus intéressants.

Q : En tant que véhicule utilisé pour la reconnaissance et la défense, les snowspeeders sont équipés d'armes et conçus pour la vitesse. Comment ces éléments sont-ils présents dans le modèle final ?

R : La nature ultra rapide du snowspeeder est apparente dans son design compact, en utilisant des angles aigus pour le rendre plus profilé. J'en étais très conscient pendant la création du modèle, en rendant le dessous moins volumineux et avec moins de briques. Une autre partie que je voulais construire aussi fidèlement que possible était les turbo lasers, qui sont conçus de façon à s'incliner vers l'intérieur pour viser et tirer. Ceci a été beaucoup plus difficile à construire que je ne le pensais et ce n'est peut-être pas évident au premier coup d'œil, mais ils sont en fait construits sur un angle très réduit d'environ 10 à 15 degrés.



Q : Y a-t-il une fonction spécifique du modèle que tu as préféré créer ?

R : Je me suis beaucoup amusé à créer l'intérieur de la cabine, avec les sièges dos-à-dos et toutes les petites commandes qui les entourent, qui étaient difficiles à placer dans un espace si réduit, mais ajoutaient beaucoup de détails.

Q : Avec un fusil arrière rotatif, une cabine qui s'ouvre et des aérofreins mobiles, il y a de nombreuses parties qui bougent dans ce modèle. Comment l'as-tu conçu pour assurer sa stabilité ?

R : Toutes les parties mobiles du modèle sont des constructions assez petites, ce qui signifie qu'il était plus facile de les stabiliser. J'ai rencontré quelques défis avec la cabine, car les deux nouveaux éléments de fenêtre utilisés pour la créer étaient très grands et lourds et nous voulions nous assurer qu'on pouvait exposer le modèle avec la cabine ouverte ou fermée.

Rencontre la graphiste

Marie Sertillanges

Q : Ces figurines sont-elles les premières figurines LEGO® Star Wars™ que tu as créées ?

R : Non, ma première création de figurine était le dernier pilote Naboo de 2015. Les figurines de cet ensemble sont principalement des modèles qui existaient déjà. Nous avons décidé de les garder car elles sont vraiment célèbres, tout en les améliorant avec des bras décorés. C'était cependant la première fois que je créais des bras de figurine.

Q : Qu'utilises-tu pour commencer à créer les décorations des figurines LEGO Star Wars ?

R : Ma première étape est de rassembler toutes les références que j'ai pour le personnage et d'essayer de concevoir son aspect général. Puis, je choisis les couleurs LEGO que je vais utiliser pour le torse, les bras, les jambes et les mains. La prochaine étape est de dessiner les formes générales et de traduire l'aspect du personnage en style LEGO. Pour finaliser la conception, je vais et viens entre les références et la figurine jusqu'à ce que je sois satisfaite, ou que je n'aie plus de temps !

Q : Les figurines sont très petites, quels sont les défis que pose la conception de designs à la fois détaillés, mais faciles à comprendre ?

R : Pour que le design soit plein de détails très cool mais toujours lisible, je commence avec de grandes formes extra simples. Avoir la bonne composition à tout moment de la conception est essentiel et c'est plus facile à obtenir avec peu d'éléments. Je vais ensuite « retravailler » ces grandes formes en formes plus petites, comme on le ferait avec une sculpture. La partie complexe est de choisir les bons détails afin de capturer réellement l'aspect et la personnalité du personnage !



Marie Sertillanges

Q : Qu'utilises-tu comme référence pour créer les décorations des figurines ? Des photos des films ? Des images sous licence ?

R : Pour les films *Star Wars* les plus anciens, nous utilisons principalement des photos du film ou de la production, venant directement de LucasFilm. À cette époque de l'industrie cinématographique, la documentation en coulisses n'était pas aussi complète qu'aujourd'hui, il est donc un peu plus difficile pour nous de collecter toutes les références précises.

Q : Les combinaisons de vol portées par les personnages des films *Star Wars*™ sont incroyablement détaillées. Comment choisis-tu les détails sur lesquels te concentrer lorsque tu crées les décorations pour les figurines ?

R : La conception de ces pilotes a été faite bien longtemps avant que je ne devienne une graphiste LEGO®, mais je peux parler de ma façon générale d'approcher une figurine. Lorsque je crée un personnage, je choisis ce qui le rend vraiment spécial, ce qui le définit. La superposition et les matériaux sont importants sur les uniformes rebelles, et des plis, par exemple, peuvent être utilisés pour montrer les qualités du matériau et pour rendre le personnage moins ordonné ou plus dynamique. Je pense toujours au fait qu'on ne peut pas et qu'on ne doit pas tout dessiner comme dans la vie

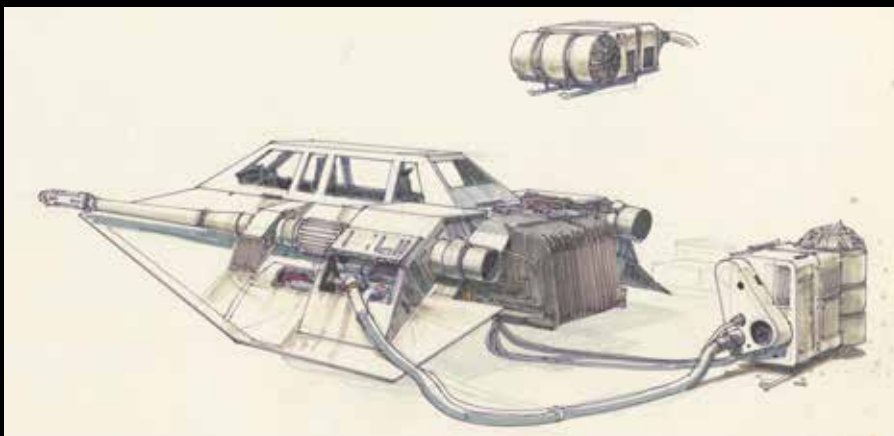

© & ™ Lucasfilm Ltd.



© & ™ Lucasfilm Ltd.

réelle. Je pense à regarder la réalité avec un filtre LEGO.

Q : Comment ces figurines se comparent-elles à d'autres que tu as conçues ?

R : La plupart des figurines que nous concevons sont seulement décorées sur le torse, la tête et les jambes. La décoration des bras est réservée uniquement aux figurines spéciales. J'ai conçu des héros principaux et des personnages secondaires comme Zev Senesca. Comparés aux héros principaux, ces personnages génériques sont plus compliqués à concevoir car il faut les étudier de plus près pour trouver ce qui les différencie. Pour être honnête, je préfère travailler sur les personnages secondaires car ils semblent banals au début, mais ont des histoires uniques quand on creuse plus profondément.

Rencontre le directeur artistique

Michael Sion

Q : As-tu déjà travaillé sur la création d'un emballage pour LEGO® Star Wars™ ?

R : J'ai commencé à travailler pour LEGO Star Wars en 2009 et bizarrement, mon premier emballage a été un assortiment d'ensembles de combat avec des figurines de la planète Hoth. Six ans plus tard, je suis de retour sur Hoth avec le snowspeeder.

Q : Quel type de matériel de référence as-tu utilisé pour commencer à concevoir l'emballage ?

R : L'une des choses géniales à propos de *Star Wars* est la quantité de matériel de fans sur Internet. J'aime passer un moment à naviguer sur Internet pour me plonger dans le monde de *Star Wars*. Le modèle apparaît généralement dans une scène célèbre des films à laquelle j'essaie toujours de me référer. Puis, pendant la création de l'emballage, il ne faut jamais sous-estimer l'utilité de faire des effets sonores en créant le devant de l'emballage.

Q : Le snowspeeder est un véhicule Star Wars très présent dans la bataille de Hoth, qui a lieu dans un environnement enneigé. Comment as-tu fait pour que ce véhicule blanc se détache sur le fond blanc ?

R : De la couleur, des lasers, des explosions et de la fumée ! Les explosions m'ont facilité la vie à plusieurs occasions.

Q : Quelles sont les premières étapes que tu accomplis lorsque tu commences la création de l'emballage pour un nouvel ensemble LEGO Star Wars ?

R : Je commence toujours avec la présentation pour voir ce que l'équipe de produits LEGO Star Wars veut montrer. Puis « j'étudie le modèle en jouant » pour avoir une idée de son potentiel.



Michael Sion

Q : Y a-t-il des techniques spécifiques que tu utilises pour décrire sur la boîte les caractéristiques et les fonctions d'un ensemble particulier ?

R : J'ai toujours du mal avec les images des fonctions. Heureusement, nous avons les modèles dans un programme en 3D, nous pouvons donc les faire tourner au lieu d'avoir recours à la photographie. Il s'agit principalement d'essayer de donner une idée de cause à effet, par exemple montrer une fonction de l'ensemble qui implique de pousser ou de tirer une section du modèle et l'action qui en résulte. J'essaie aussi d'utiliser la profondeur de champ pour moins insister sur les parties du modèle qui ne sont là que pour le contexte.

Q : Quel type de défis affrontes-tu lorsque tu crées des illustrations qui seront utilisées spécialement pour la création de l’emballage ? En quoi les illustrations de l’emballage sont-elles différentes du reste du travail de design ?

R : Les défis sont parfois inattendus, par exemple, il arrive qu’un modèle change pendant sa création, il est donc important pour nous d’être flexible avec toute notre équipe. De plus, comme nous avons des ensembles LEGO® dans le monde entier, nous devons parfois mettre différentes traductions de mots ou de messages sur l’emballage, ce qui modifie aussi légèrement le design. Mais notre équipe travaille bien ensemble, nous résolvons donc les défis rapidement en général, pour être capables de produire quelque chose de génial à partager avec les fans LEGO *Star Wars*™ du monde entier.

Q : Lorsque tu crées les illustrations de l’emballage, ton but est-il de recréer des scènes célèbres de la saga de films *Star Wars*, ou plutôt de montrer les qualités uniques de l’ensemble ?

R : Le modèle LEGO vient en premier, mais j’essaie de rester aussi fidèle que possible aux films.

Q : Y a-t-il une partie du processus de design que tu apprécies davantage ?

R : Le début d’un nouveau projet est passionnant et ce sont les premières phases du design que je préfère. Avant de commencer quoi que ce soit, on n’a que le potentiel de faire quelque chose, et ceci est pour moi la partie la plus amusante du projet. Réfléchir à quelle scène choisir et comment la mettre sur papier est un processus créatif qui peut être très amusant, et assister à une création du début à la fin est une transformation fascinante.



Acerca del equipo de diseño de LEGO® Star Wars™

La línea LEGO® Star Wars™ se lanzó en 1999 y ha recibido nuevos modelos todos los años desde entonces. El equipo de diseño de LEGO Star Wars se compone de ocho diseñadores de modelos y cuatro diseñadores gráficos. El grupo combina nuevos diseñadores con ideas frescas y diseñadores con mucha experiencia en el universo LEGO Star Wars y un gran número de modelos a sus espaldas.

Es un equipo ideal para la creación de nuevos e ingeniosos modelos LEGO Star Wars y la revisión y mejora de las antiguas versiones LEGO de las naves más clásicas y emblemáticas. El principal objetivo de la línea LEGO Star Wars es hacer llegar a los niños modelos divertidos, modernos e inspiradores basados en este universo.

Para LEGO Direct, es una magnífica oportunidad de crear modelos más grandes y complejos, prestando especial atención a la precisión y los detalles. Son modelos divertidos y emocionantes de desarrollar, ¡pero también muy desafiantes! Siempre nos esforzamos al máximo para que disfrutes de la experiencia.

¡Feliz construcción!



Jens Kronvold Frederiksen
Director de diseño, LEGO Star Wars





Acerca del Snowspeeder



© & ™ Lucasfilm Ltd.

Aunque la fama de Incom Corporation procede especialmente del caza estelar T-65 X-Wing, la compañía fabricó también un aerodeslizador que marcaría el destino de la Alianza durante la Guerra Civil Galáctica por la restauración de la República, que tuvo lugar en el año 3 ABY. El aerodeslizador T-47, más conocido como Snowspeeder, componía buena parte de la flota de la Alianza Rebelde en su fortaleza de Hoth, conocida como base Echo. Los técnicos de la base Echo modificaron el Snowspeeder, diseñado principalmente para el transporte industrial de carga, con el fin de convertirlo en un vehículo ligero y rápido que sirviese tanto para misiones de patrulla como para el combate. El clima glacial de Hoth obligó también a la Alianza Rebelde a adaptar el Snowspeeder para que operase a gélidas temperaturas durante largos períodos de tiempo. Se agregaron calefactores cerca de

las unidades propulsoras, boquillas descongelantes para impedir la formación de hielo en las superficies de control y piezas de cazas Y-Wing desarmados, placas de blindaje y módulos de cabina adaptados para mejorar su diseño y carácter defensivo.

Debido al reducido tamaño del Snowspeeder, su tripulación era de tan sólo dos personas: un piloto, responsable de controlar la velocidad y el rumbo del aerodeslizador, y un artillero, cuya misión era disparar los cañones láser dobles AP/11 y el arpón. Para suplir la falta de escudos de la nave, se agregaron placas blindadas al casco y se instalaron repulsores que aumentaron notablemente su velocidad, permitiendo al piloto esquivar los disparos del enemigo.

A pesar de sus humildes orígenes y numerosas modificaciones, el ingenio de los pilotos asignados a los Snowspeeder les permitió sacar el máximo partido de la nave. Cuando se dieron cuenta de que las armas láser no eran eficaces contra los avanzados vehículos del Imperio Galáctico, decidieron usar un arpón y gruesos cables de gran resistencia para enredar las gigantescas patas de los caminantes AT-AT e impedir que avanzasen, e incluso acabar con ellos definitivamente.

La Alianza Rebelde hizo buen uso de los aerodeslizadores T-47 más allá del gélido clima de Hoth. Los técnicos rebeldes modificaron varias veces la versátil nave de transporte de carga para cumplir otras funciones, además de las que caracterizaban al Snowspeeder. El Swampspeeder, por ejemplo, incorporaba una unidad de flotación y sellos herméticos. Otras variantes fueron el Sandspeeder, que se dotó de avanzados filtros de aire para impedir la penetración de arena y unidades de refrigeración para proteger los motores del abrasador sol del desierto; y el Skyspeeder, que contaba con cabina presurizada y repulsores más potentes para alcanzar mayor altura.

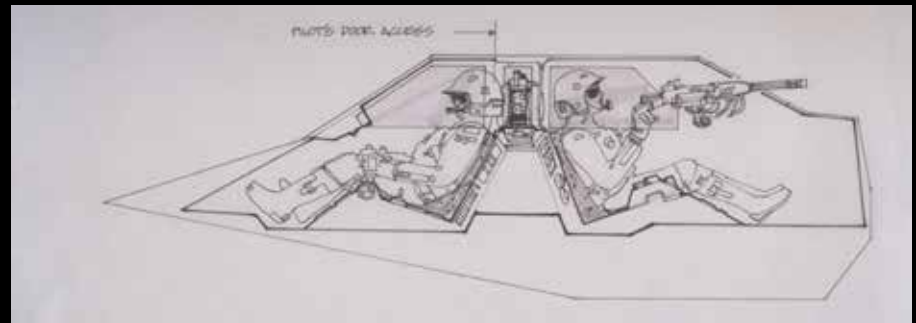

© & ™ Lucasfilm Ltd.

Datos/especificaciones

Datos sobre el Snowspeeder

Fabricante.....	Incom Corporation
Modelo.....	Aerodeslizador T-47
Clase.....	Aerodeslizador/nave repulsora

Especificaciones técnicas: aerodeslizador T-47 modificado

Longitud.....	5,3 m
Velocidad máxima.....	1.100 km/h
Altitud máxima.....	175 m
Armamento.....	2 cañones láser dobles CEC AP/11 Arpón de energía Ubrikkian Mo/Dk y cable de gran resistencia Cañón bláster de repetición ligero
Motor.....	Repulsores Karydee KD49
Tripulación.....	1 piloto y 1 artillero
Capacidad de la bodega.....	10 kg



© & ™ Lucasfilm Ltd.



Conoce al diseñador del modelo

Jordan David Scott

P: ¿Cuántos modelos LEGO® Star Wars™ has diseñado?

R: De todos los modelos LEGO Star Wars en los que he trabajado, el set UCS del Snowspeeder será el quinto que se ha comercializado.

P: ¿Qué tipo de materiales de referencia usaste para empezar a diseñar el Snowspeeder?

R: Lo primero que hice fue dar un vistazo al anterior set UCS del Snowspeeder, diseñado en 2003, para determinar qué podía conservar. También usé varias fotografías que encontré en nuestros libros sobre Star Wars y fotogramas de «Star Wars: El Imperio contraataca».

P: ¿En qué se diferencia el Snowspeeder de los demás modelos LEGO Star Wars en cuanto a diseño?

R: Creo que la principal diferencia reside en el nivel de detalle que puede incluir un modelo UCS. Al ser más grandes, estos modelos admiten técnicas de construcción más complejas y niveles de detalle que, personalmente, disfruto incorporando a los modelos en los que trabajo. Mi detalle favorito del set UCS del Snowspeeder es el uso de esquís LEGO a escala de minifigura en la superficie inferior para recrear las aletas de refrigeración. Los modelos UCS deben verse lo máximo posible como los vehículos reales que representan. Los ángulos extraños y las funciones complejas pueden ser difíciles de lograr; tuve que esforzarme bastante al construir la ventanilla trasera, ya que desciende en tres direcciones distintas y, al mismo tiempo, debe soportar la bisagra de la cabina.



Jordan David Scott

P: La parte delantera del Snowspeeder posee un arco en ángulo fácilmente reconocible. ¿Fue un desafío recrearlo usando bricks LEGO?

R: Los ángulos siempre son difíciles de reproducir y, concretamente, esta era una de las cosas del anterior set UCS del Snowspeeder que no quería mantener. En 2003 no teníamos elementos para conseguir este aspecto, así que esta parte se construyó usando bricks en ángulo. Sin embargo, gracias a las uniones de rótula en miniatura de las que hoy disponemos, logré hacer el extremo delantero más aerodinámico y preciso.

P: ¿Cómo planificaste el diseño del Snowspeeder? ¿Usaste bocetos o fotogramas de las películas como base para diseñar el modelo?

R: La mayor parte de las ideas salieron de las películas y los esquemas que incluyen las enciclopedias de *Star Wars*™ que tenemos y usamos con frecuencia como referencia.

P: Existen versiones más pequeñas del Snowspeeder en el set LEGO® Star Wars dedicado a la batalla de Hoth; ¿en qué se parece esta versión a sus hermanos menores?

R: Una de las cosas que tienen en común a pesar de poseer tamaños tan diferentes es la gran cantidad de funciones que incorporan; el modelo UCS posee funciones similares a las que poseen los modelos más pequeños, como el cañón trasero giratorio y los aerofrenos móviles. Ambas funciones hacen más interesante el propio modelo y la experiencia de construcción.

P: Al ser vehículos dedicados al reconocimiento y la defensa, los Snowspeeders estaban equipados con armas y motores de gran potencia. ¿Cómo influyeron estos dos aspectos en el diseño final?

R: La veloz naturaleza del Snowspeeder se percibe a través de su compacto diseño, que emplea ángulos agudos para hacerlo más aerodinámico; es algo de lo que fui muy consciente durante el diseño del modelo y que traté de lograr despejando de bricks la superficie inferior. Otra cosa que quería construir con la máxima precisión posible eran los turboláseres, que están ligeramente inclinados hacia dentro para concentrar los disparos en un cierto punto. Fue mucho más difícil de conseguir de lo que pensaba y, aunque a primera vista no se aprecie, es cierto que forman un ligero ángulo de unos 10-15 grados.



P: ¿Existe alguna característica específica del modelo con la que hayas disfrutado particularmente durante el diseño?

R: Me divertí mucho diseñando el interior de la cabina, con los respaldos de los asientos enfrentados y todos los controles que los rodean. Fue un desafío que cupieran en un espacio tan pequeño, pero aportan un gran nivel de detalle.

P: El cañón trasero giratorio, la cabina abatible, los aerofrenos móviles... este modelo cuenta con muchas funciones móviles. ¿Cómo te aseguraste de que fuera estable?

R: Las partes móviles del modelo son modelos secundarios bastante pequeños, así que fue fácil estabilizarlos. Tuve algunos problemas con la cabina, ya que las dos nuevas ventanas que usé para crearla eran muy grandes y pesadas, y queríamos estar seguros de que el modelo se pudiera exponer con la cabina abierta o cerrada.



Conoce al diseñador gráfico

Marie Sertillanges

P: ¿Son estas las primeras minifiguras LEGO® Star Wars™ que has diseñado?

R: No; la primera minifigura que diseñé fue el último piloto de Naboo, de 2015. En realidad, las minifiguras de este set se basan en gran medida en diseños anteriores. Decidimos no alterarlas porque son realmente emblemáticas, pero las mejoramos incluyendo brazos decorados. Sí que fueron, no obstante, los primeros brazos de minifigura que diseñé.

P: ¿En qué te inspiras al diseñar una minifigura LEGO Star Wars?

R: Lo primero que hago es recopilar todas las referencias visuales que tengo e intentar hacerme una idea general del aspecto. Entonces escojo los colores LEGO que usaré para el torso, los brazos, las piernas y las manos. El siguiente paso es dibujar las formas generales del diseño, para traducir el aspecto del personaje al lenguaje visual de LEGO. Por último, comparo las referencias y el boceto de la minifigura hasta que estoy satisfecha... ¡o hasta que el tiempo se agota!

P: Las minifiguras son muy pequeñas; ¿a qué desafíos te enfrentas al crear diseños que sean detallados y, al mismo tiempo, fáciles de comprender?

R: Para asegurarme de incluir el máximo nivel de detalle en el diseño sin hacerlo demasiado complicado, comienzo con formas grandes y muy sencillas. Mantener una composición adecuada en todo momento durante el diseño es fundamental, y es más fácil conseguirlo con pocos elementos. A partir de ahí, voy dividiendo las formas grandes en otras más detalladas, como hace un escultor cuando esculpe una estatua. ¡La parte más difícil es elegir los detalles en el orden correcto para capturar el aspecto genuino del personaje o su verdadera personalidad!



Marie Sertillanges

P: ¿Qué materiales de referencia usas para diseñar la decoración de las minifiguras? ¿Fotogramas de las películas? ¿Material artístico oficial?

R: En el caso de las primeras películas de *Star Wars*, usamos fotogramas o fotografías que nos proporciona directamente LucasFilm. En aquella época, el proceso de producción tras las cámaras no se documentaba tanto como hoy, y eso nos impide conseguir referencias precisas.

P: Los trajes de los personajes de las películas de *Star Wars*™ cuentan con numerosos detalles. ¿Cómo decides en qué detalles concentrarte al diseñar las minifiguras?

R: El diseño de estos pilotos se llevó a cabo mucho antes de que yo llegase a LEGO® como diseñadora gráfica, pero hablaré de mi forma de plantear una minifigura. Cuando diseño un personaje, elijo lo que lo hace realmente especial... aquello que lo define. Los tejidos y materiales de los uniformes rebeldes son muy importantes; las arrugas, por ejemplo, se pueden usar para transmitir la calidad de un material o para que el personaje parezca menos disciplinado o más dinámico. Siempre tengo en cuenta que no se puede ni es necesario dibujarlo todo como en la vida real. Hay que ver la realidad a través de un filtro LEGO.

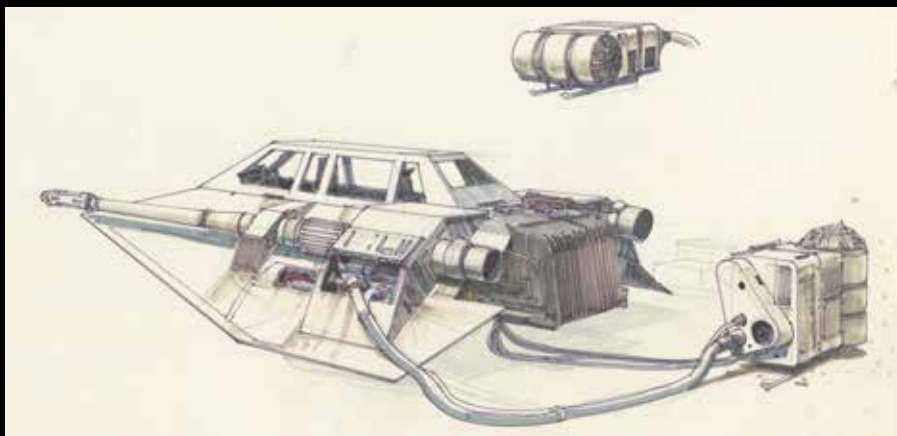

© & ™ Lucasfilm Ltd.



© & ™ Lucasfilm Ltd.

P: ¿En qué se diferencian estas minifiguras de las demás que has diseñado?

R: La mayoría de las minifiguras que diseñamos sólo llevan decoración en el torso, la cabeza y las piernas. Los brazos decorados se reservan para las minifiguras especiales. He diseñado tanto héroes protagonistas como personajes secundarios, como Zev Senesca. En comparación con los héroes protagonistas, los personajes genéricos son más difíciles de diseñar porque hay que determinar qué los diferencia de la multitud. Para ser honesta, prefiero trabajar con personajes secundarios; al principio se ven normales, pero siempre esconden grandes historias cuando los conoces en profundidad.

Conoce al director artístico

Michael Sion

P: ¿Habías trabajado antes en la caja de un set LEGO® Star Wars™?

R: Comencé a trabajar con LEGO Star Wars en 2009 y, curiosamente, la primera caja que diseñé fue para un set de combate con minifiguras del planeta Hoth. Hoy, seis años más tarde, vuelvo a Hoth con el Snowspeeder.

P: ¿En qué materiales de referencia te basas cuando empiezas a diseñar una caja?

R: Es increíble la cantidad de cosas que hacen los fans de Star Wars y publican después en la web. Me gusta explorar un poco en Internet para sumergirme en el mundo de Star Wars. Normalmente, el modelo aparece en una escena emblemática de alguna de las películas e intento hacer referencia a ella. Tampoco debe subestimarse el efecto positivo de imitar los ruidos de la batalla durante la creación de la portada de una caja.

P: El Snowspeeder es un vehículo cuya principal aparición tiene lugar en la batalla de Hoth, en un ambiente terriblemente frío. ¿Cómo te aseguraste de que un vehículo de color blanco destacase en un entorno tan blanco?

R: ¡Usando colores, láseres, explosiones y humo! Las explosiones me han facilitado mucho las cosas varias veces.

P: ¿Qué es lo primero que sueles hacer cuando empiezas a diseñar la caja de un set LEGO Star Wars?

R: Siempre empiezo leyendo las especificaciones para tener claro qué es lo que quiere enseñar el equipo de LEGO Star Wars. Después estudio el modelo jugando con él para conocer su potencial.



Michael Sion

P: ¿Usas alguna técnica específica para representar las características y funciones de un set en la caja?

R: Representar las funciones siempre es complicado. Por suerte, tenemos los modelos en 3D, así que podemos girarlos por software, sin necesidad de fotografiarlos directamente. Lo principal es transmitir el concepto de causa y efecto, por ejemplo, mostrando una función del set que implique empujar una sección del modelo o tirar de ella y la acción resultante. También trato de usar la profundidad de campo para quitar importancia a partes del modelo que sólo están ahí para aportar contexto.

P: ¿A qué desafíos te enfrentas cuando diseñas específicamente para una caja? ¿En qué se diferencia el diseño de una caja de otras tareas de diseño?

R: En ocasiones son desafíos inesperados. Por ejemplo, algunas veces un modelo cambia durante el diseño, así que es importante que todo el equipo sea flexible en este sentido. Por otra parte, como los sets LEGO® se comercializan por todo el mundo, de vez en cuando tenemos que alterar un poco el diseño para incluir la traducción de una palabra o un mensaje en la caja. Nuestros equipos colaboran muy bien, así que solemos superar rápidamente cualquier desafío para tener algo asombroso que compartir con los fans de LEGO Star Wars™ de todo el mundo cuanto antes.

P: Al diseñar una caja, ¿sueles concentrarte más en recrear las escenas más emblemáticas de la saga Star Wars, o prefieres mostrar las características exclusivas del set?

R: Lo primero y más importante es el modelo LEGO, pero trato de ser tan fiel como puedo a las películas.

P: ¿Hay alguna parte del proceso de diseño con la que disfrutes particularmente?

R: Todos los proyectos nuevos son emocionantes, y las primeras fases son las que más me gustan. Antes de ponerte manos a la obra, lo único que tienes es la posibilidad de hacer algo; para mí, esa es la parte más divertida del proyecto. Pensar en cómo puede ser la escena y trasladar la idea al papel es un proceso creativo que me divierte mucho. Además, contemplar la creación de algo desde el principio hasta el final es una experiencia realmente fascinante.



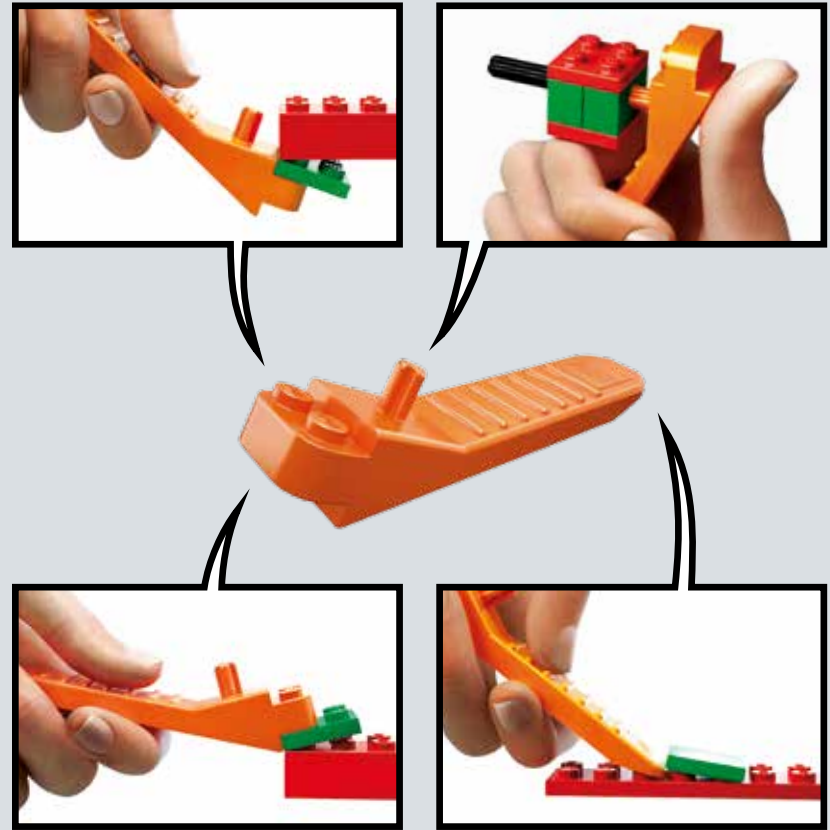

LEGO.com/brickseparator



1

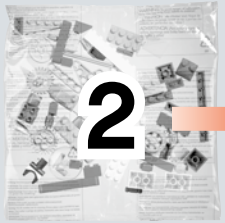

2

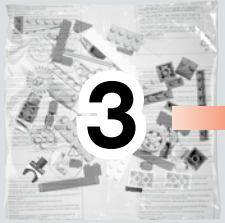
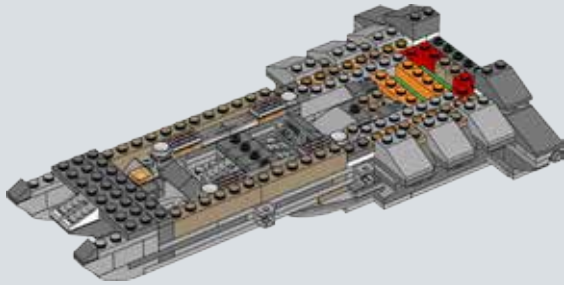

3

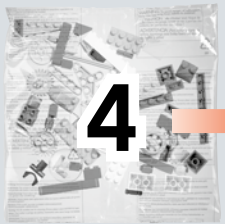
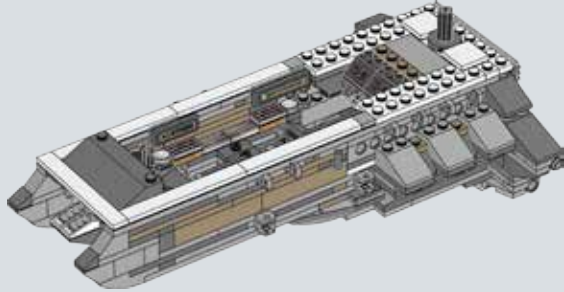

4

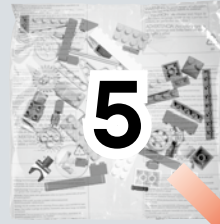
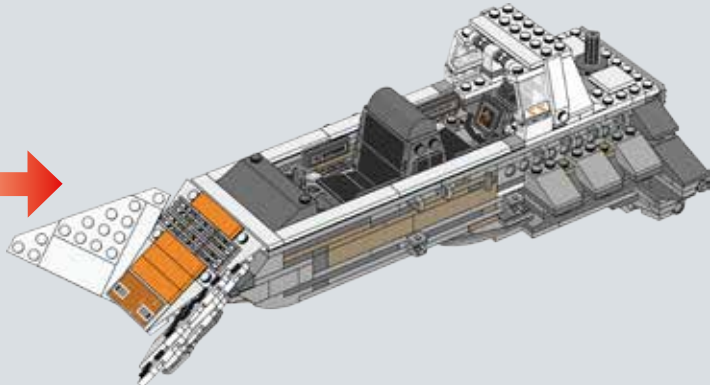

5

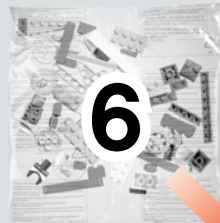
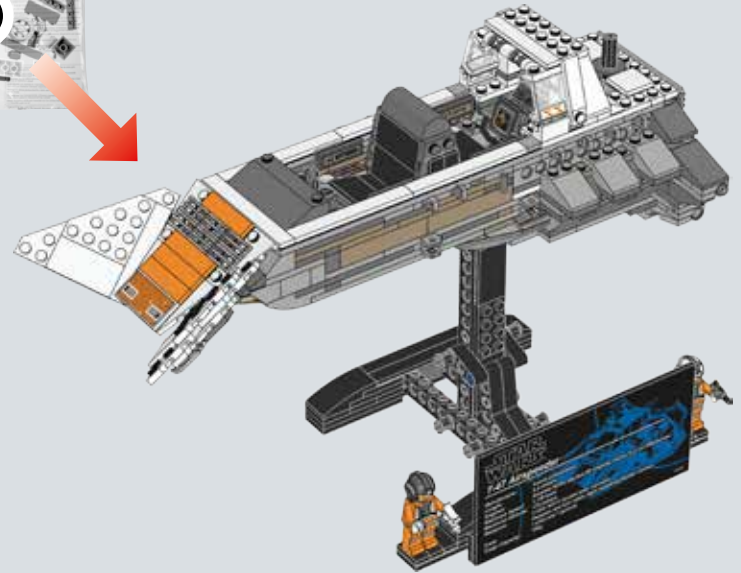

6

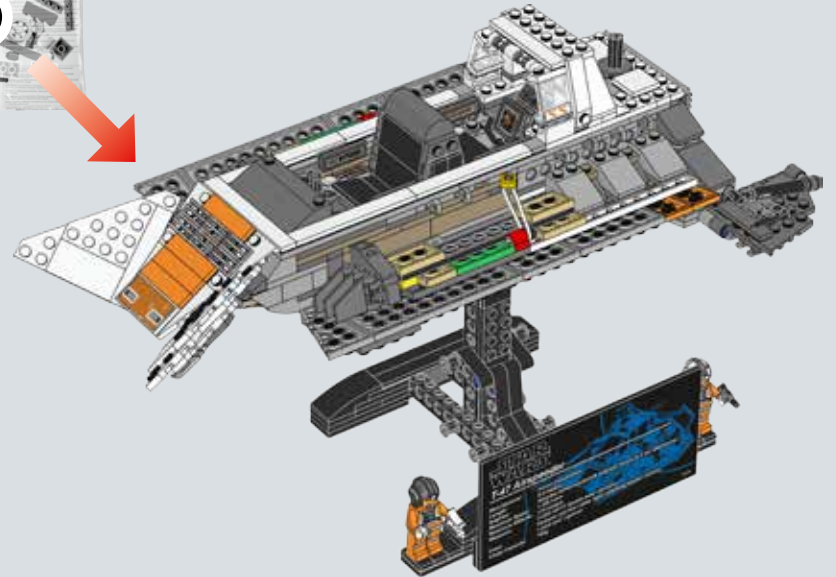

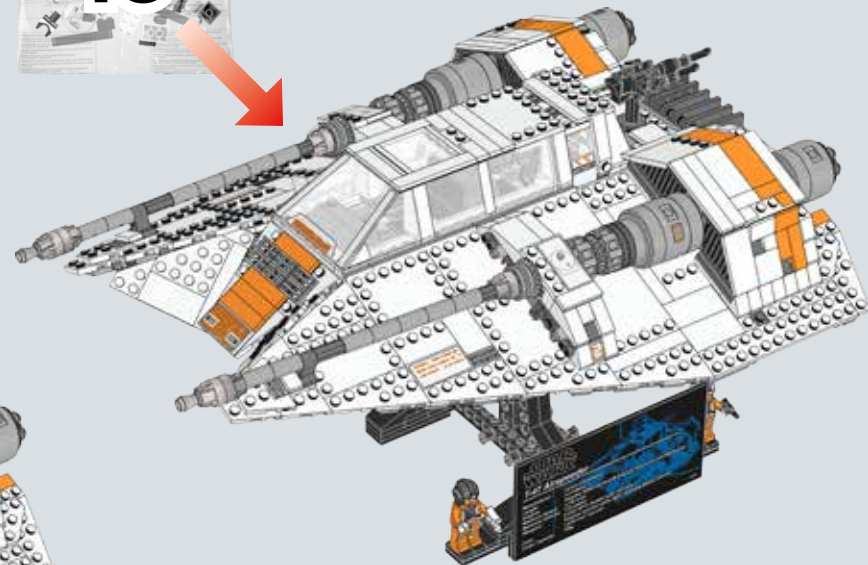
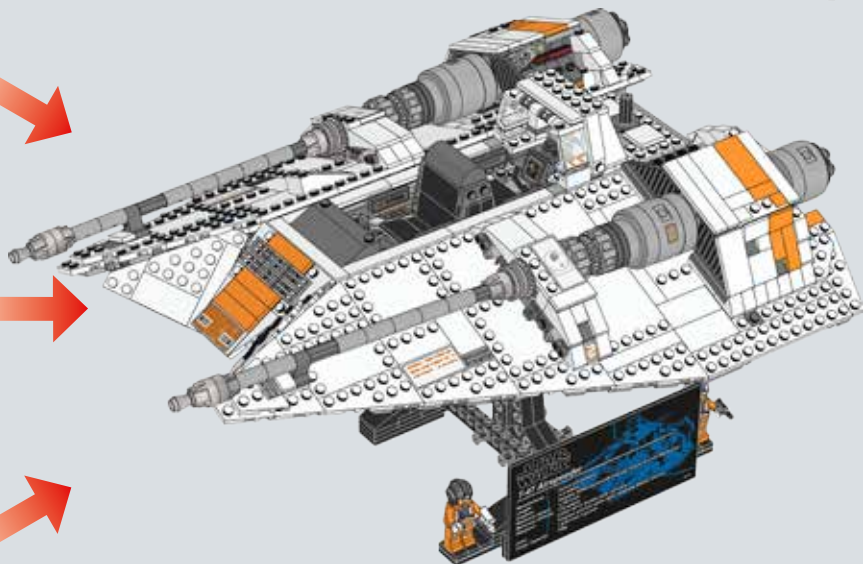
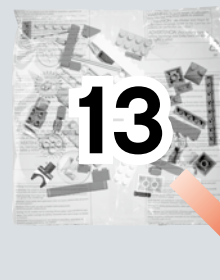
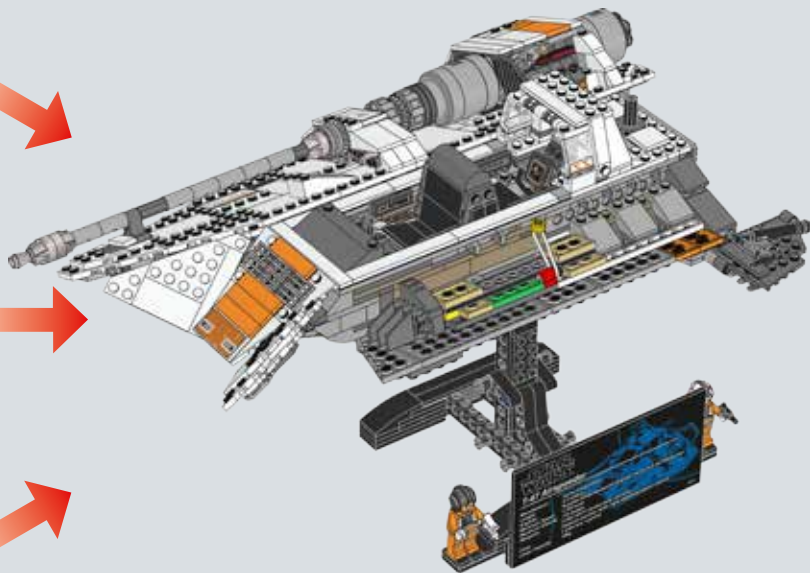
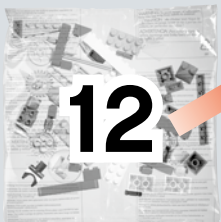
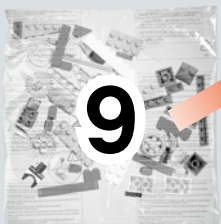
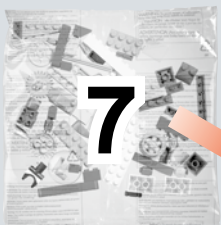



4x

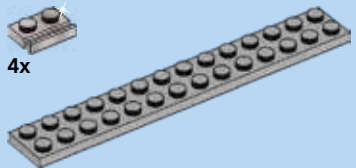

1x

1

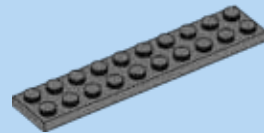
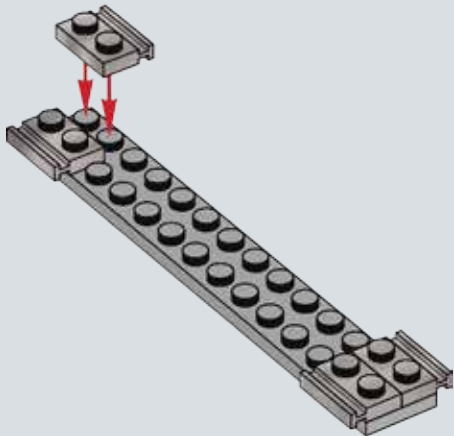

2x

2

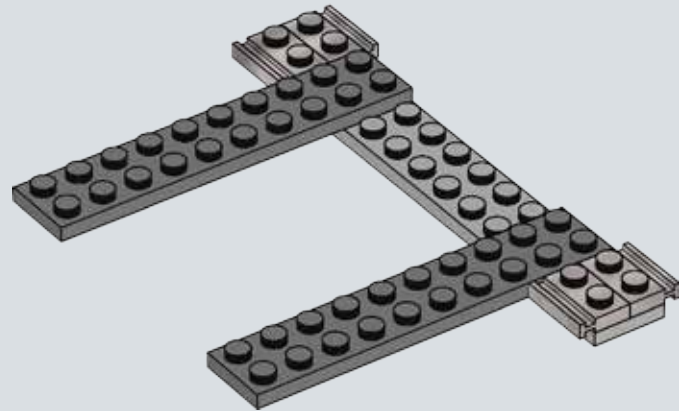

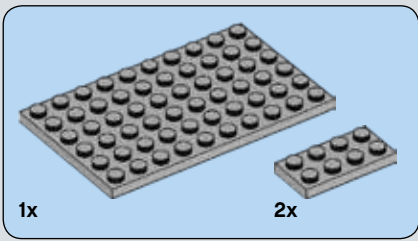

3

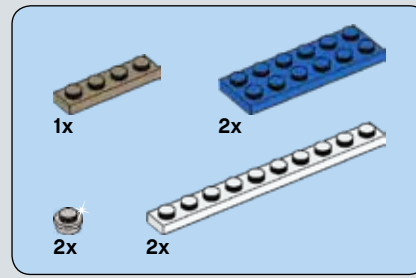
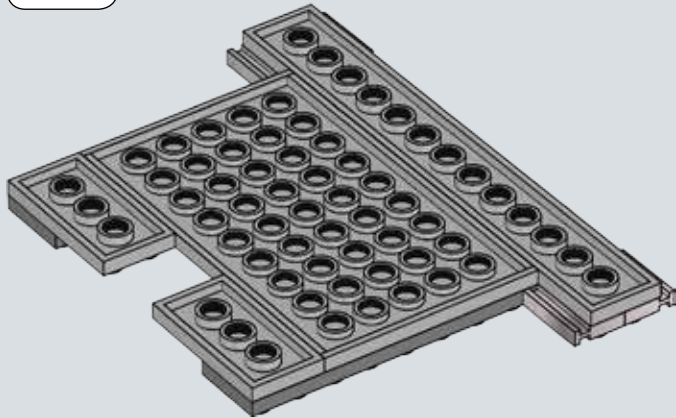

4

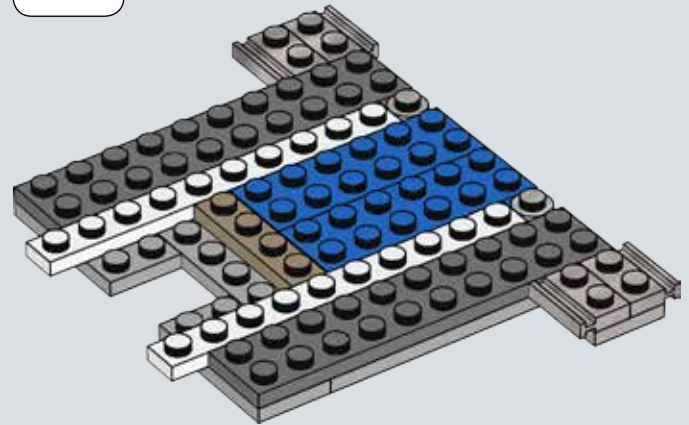
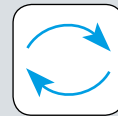

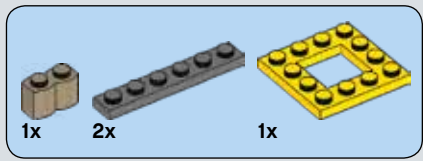

5

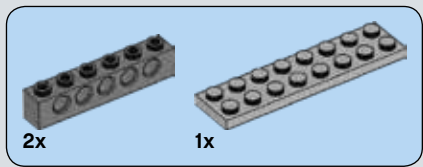
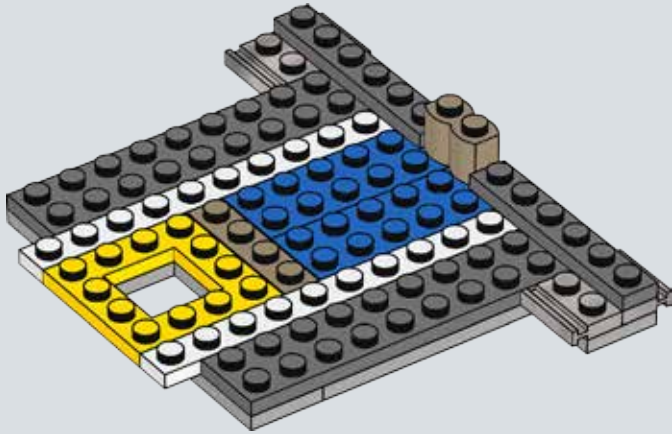

6

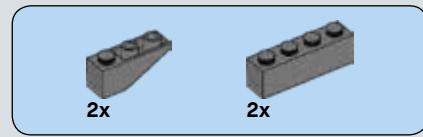
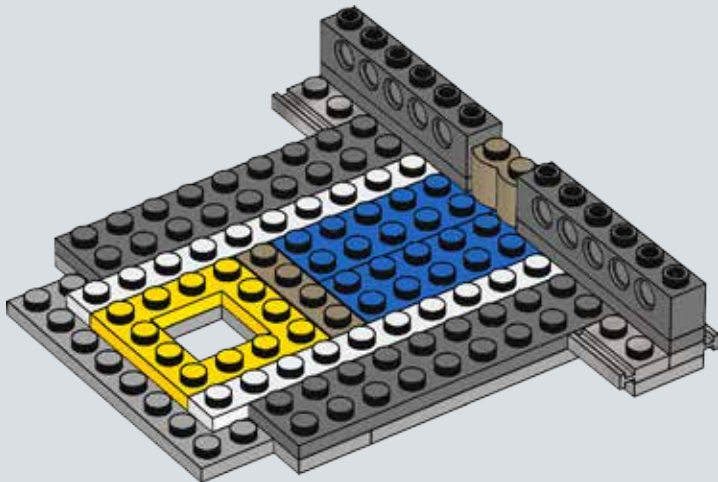

7

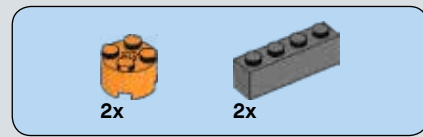
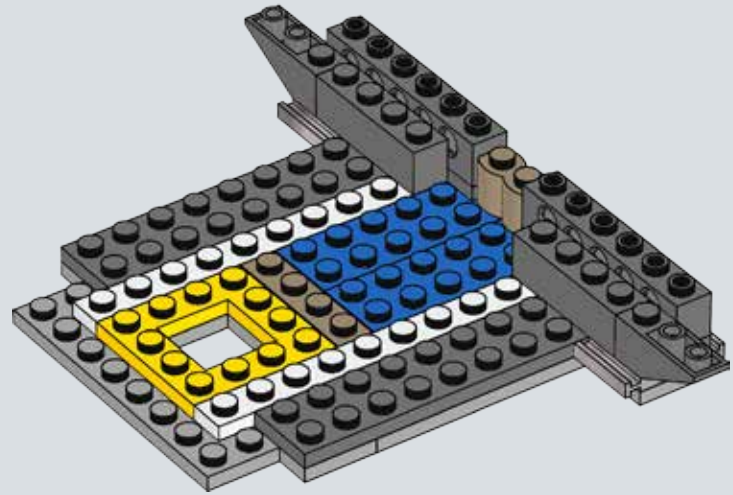

8

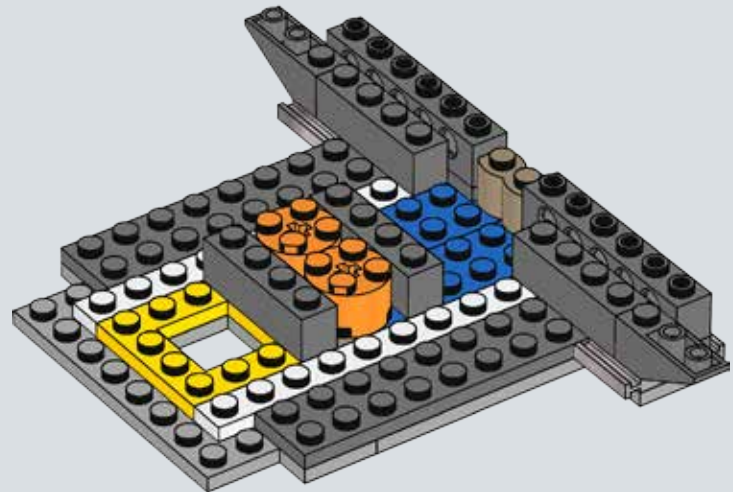

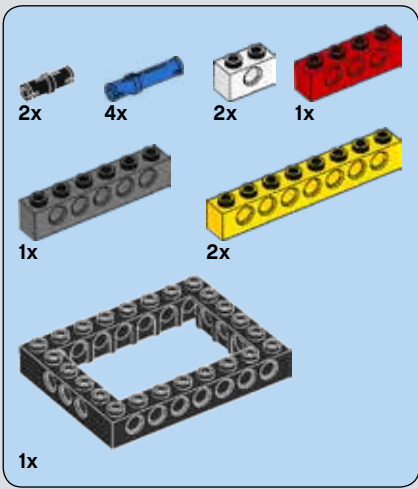

9

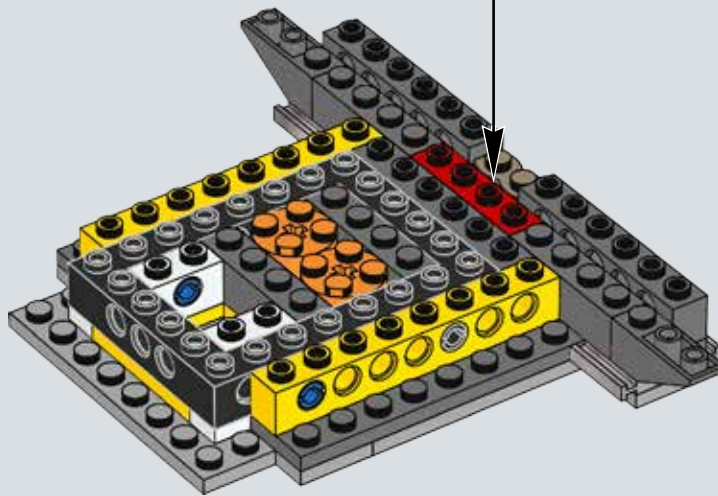
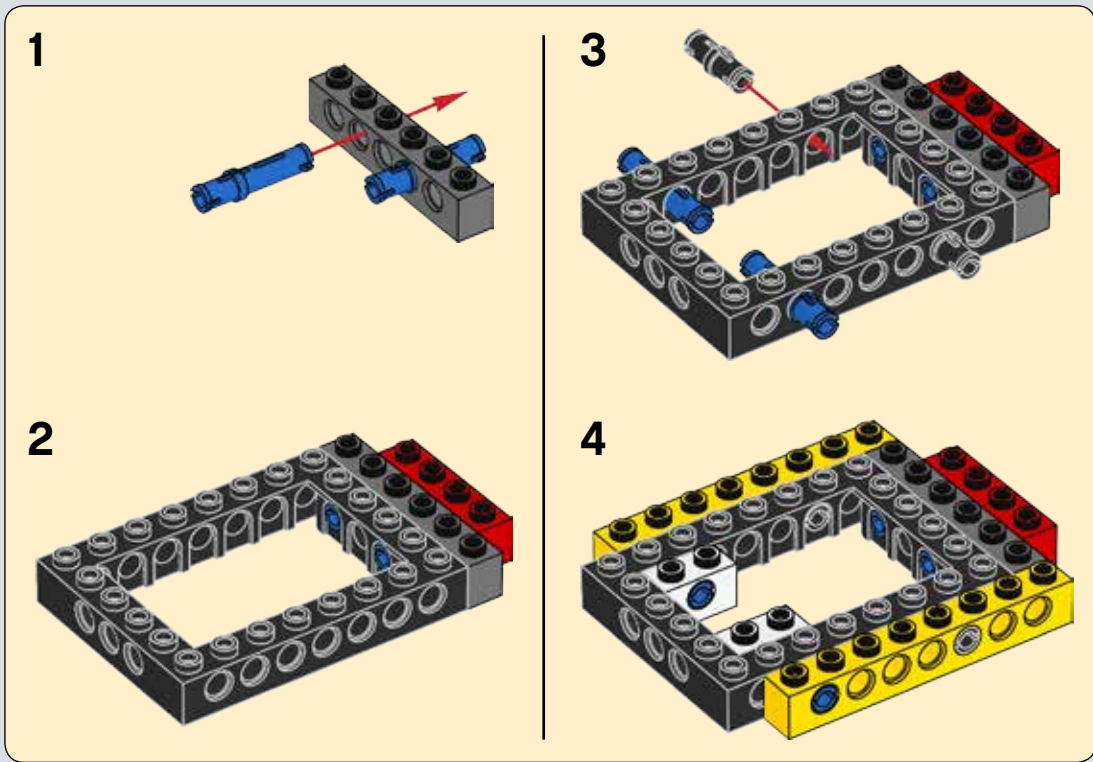



6x

10

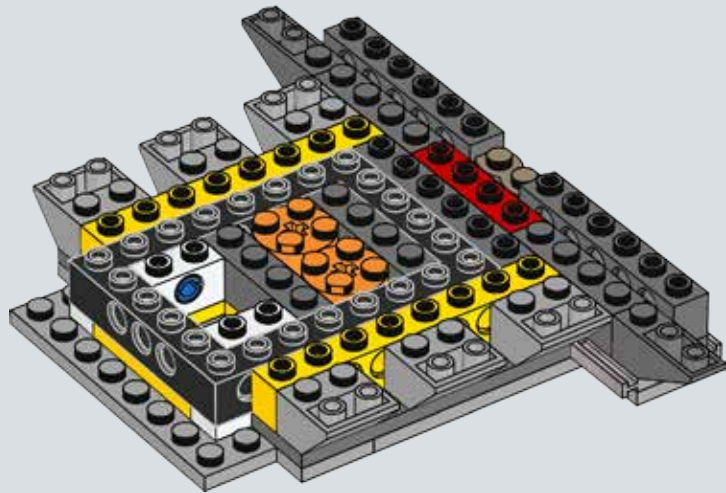

4x



4x

11

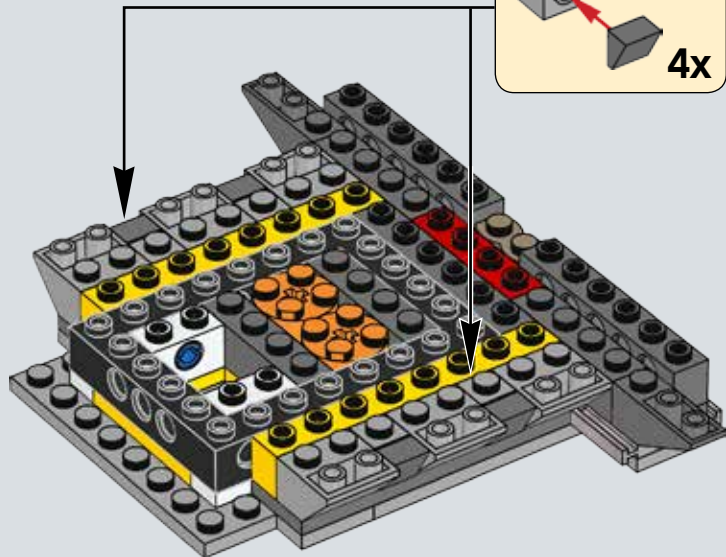

2x



1x

12

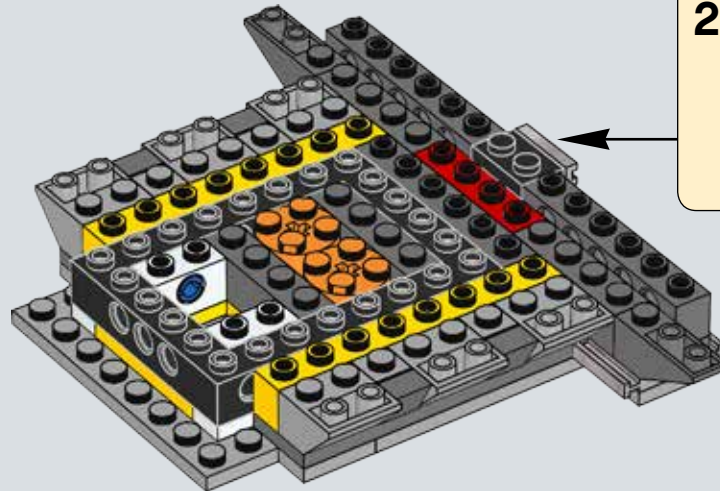

1



2

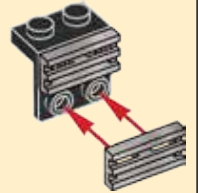

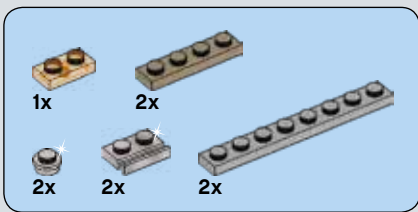

13

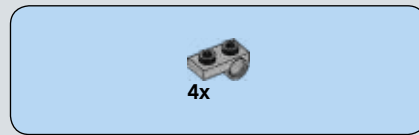
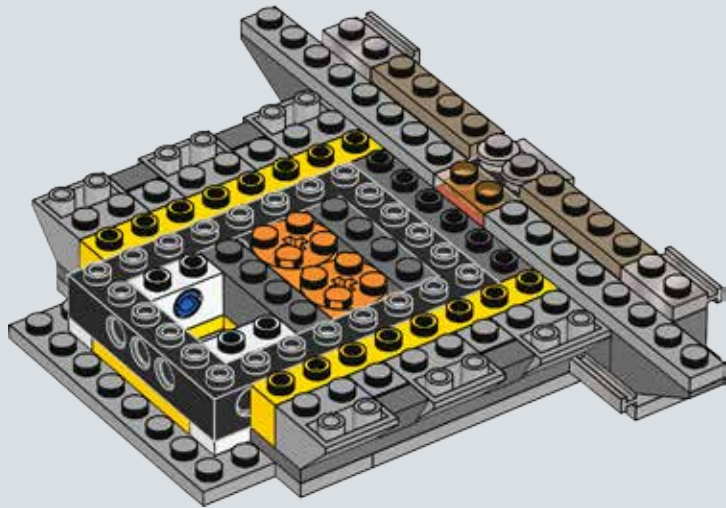

14

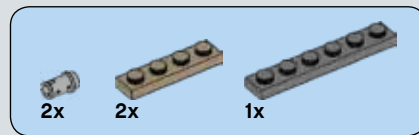
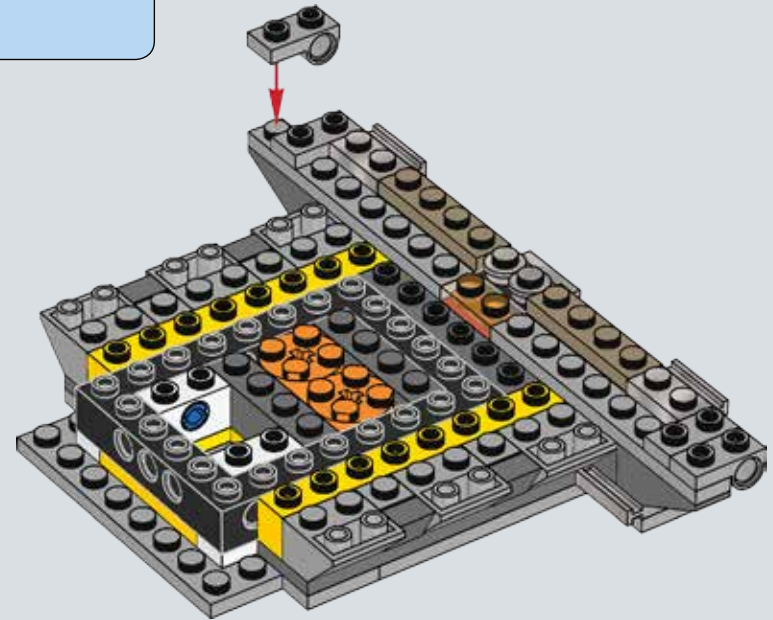

15

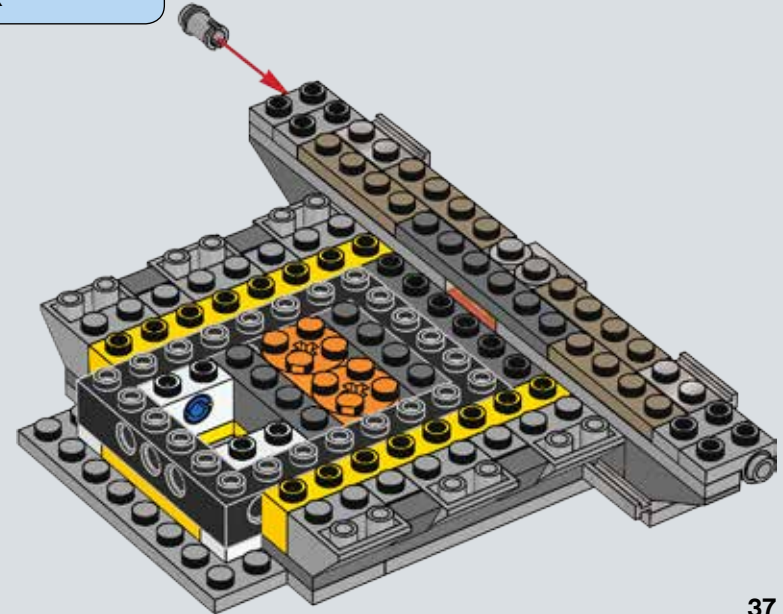

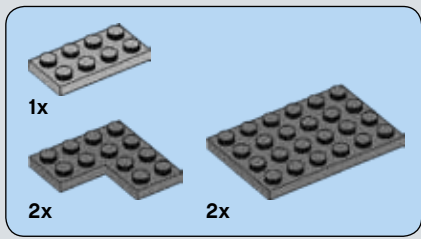

16

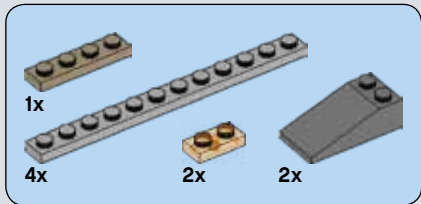
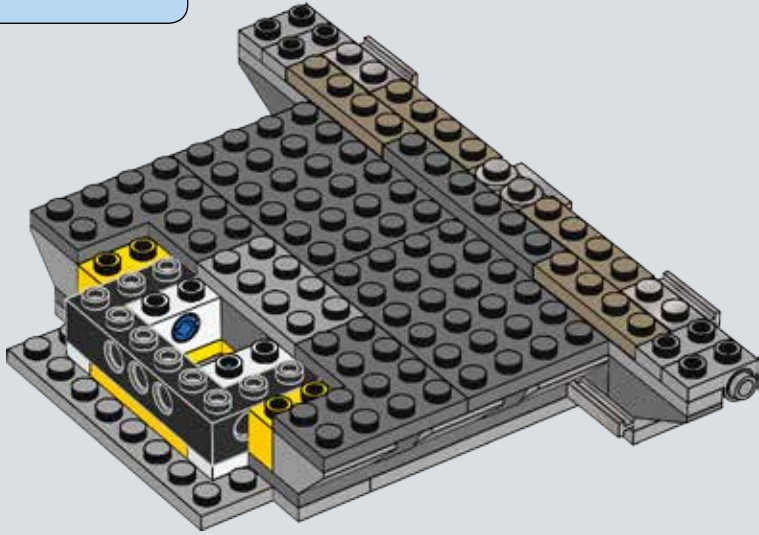

17

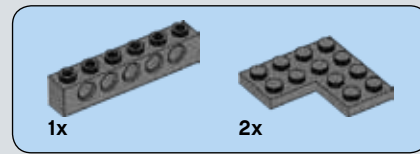
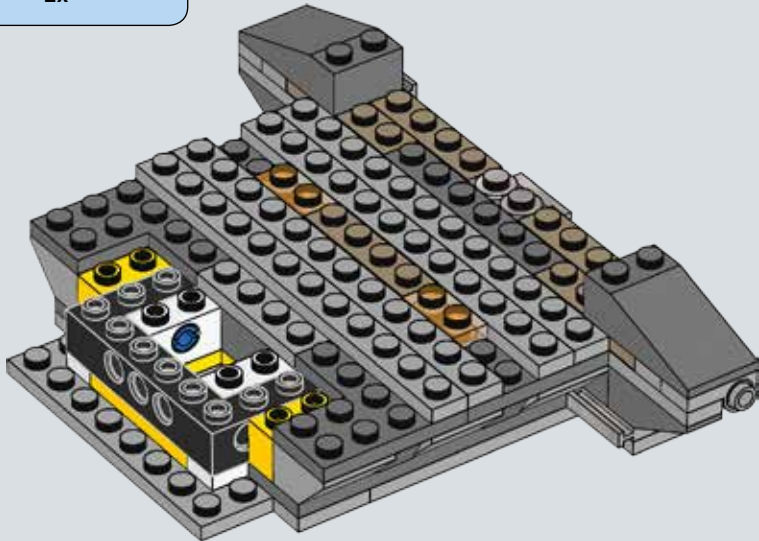

18

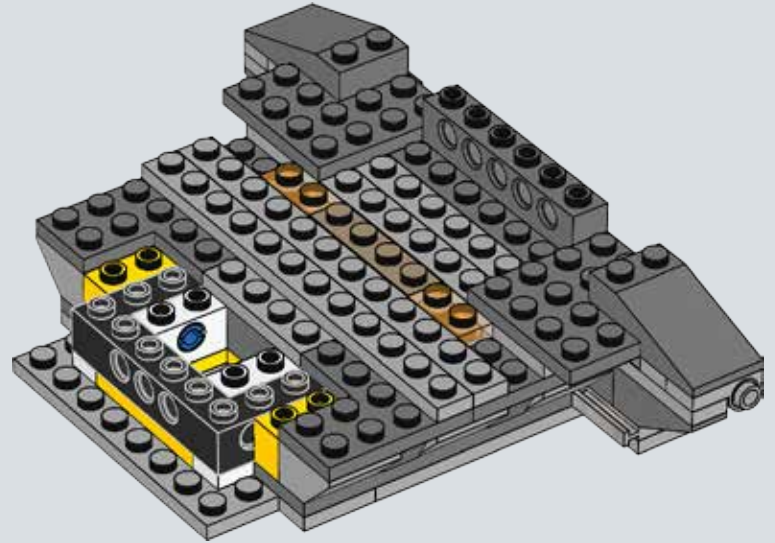

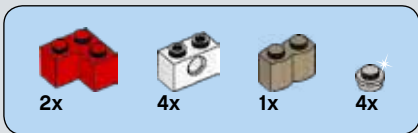

19

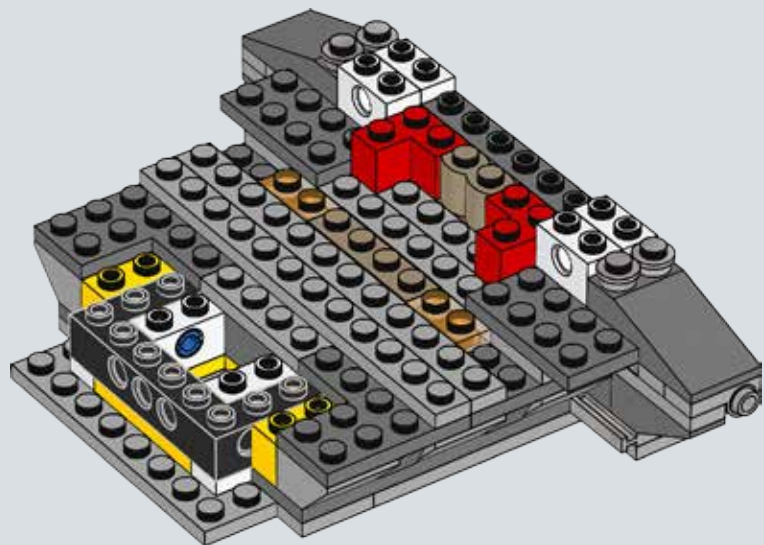

20

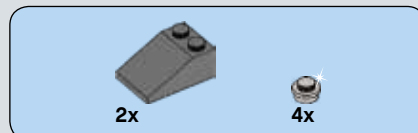
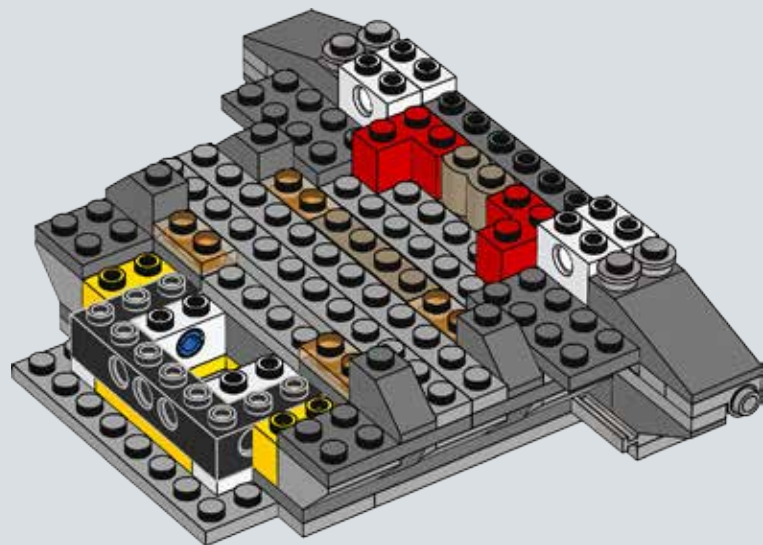

21

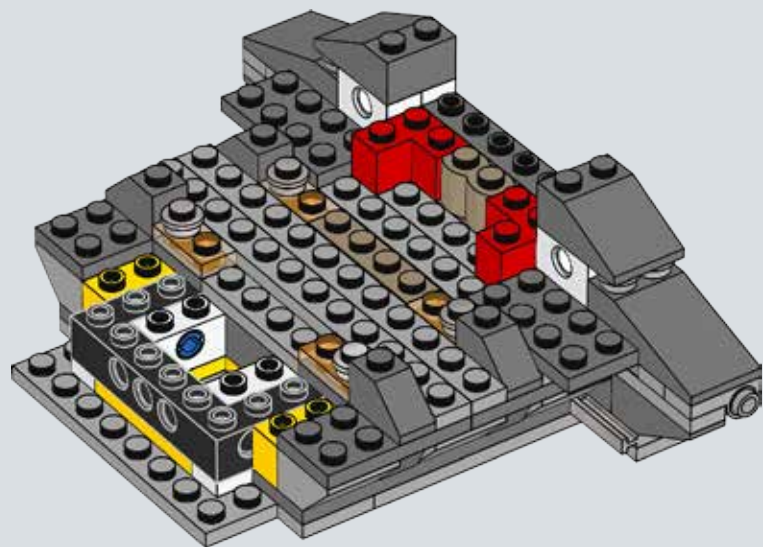

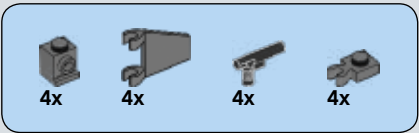

22

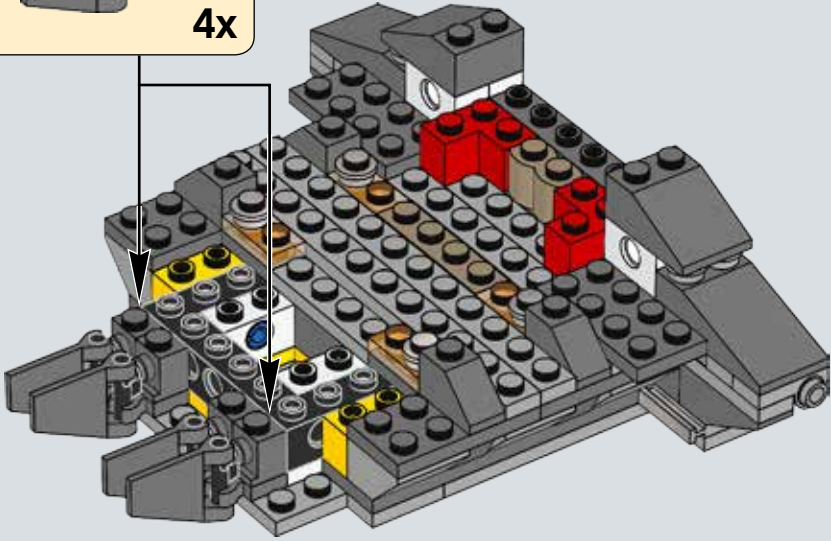
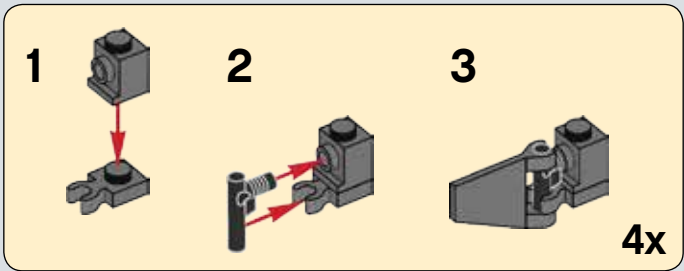

23

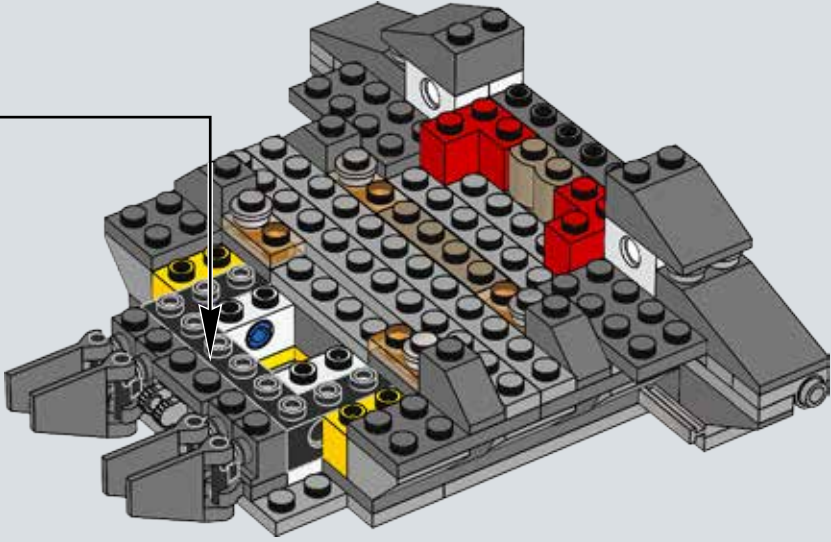
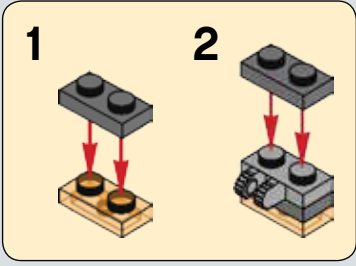

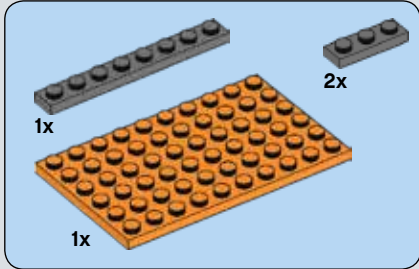
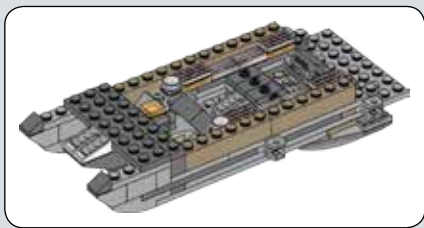
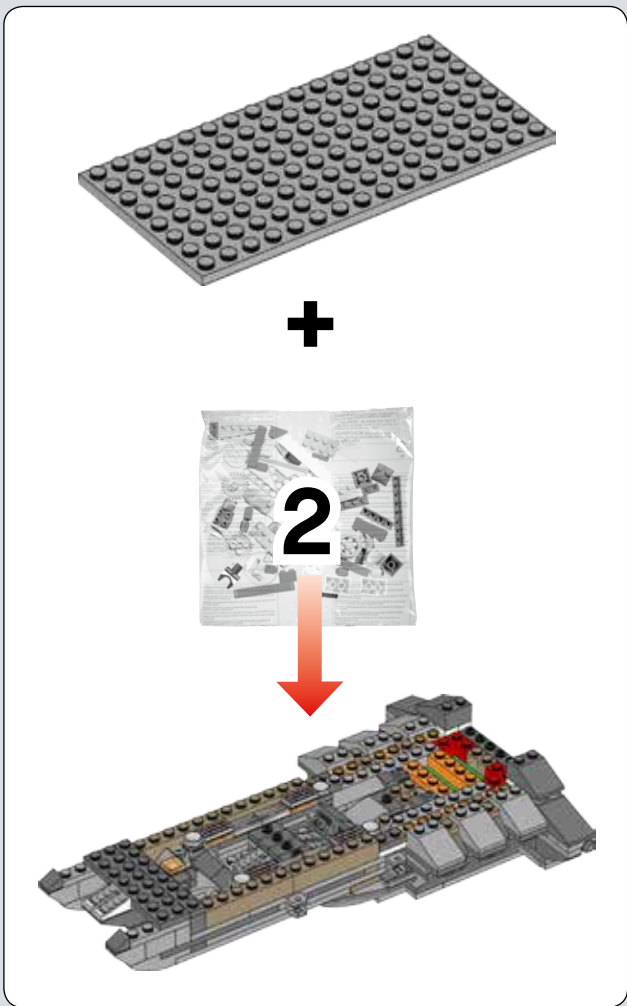

24

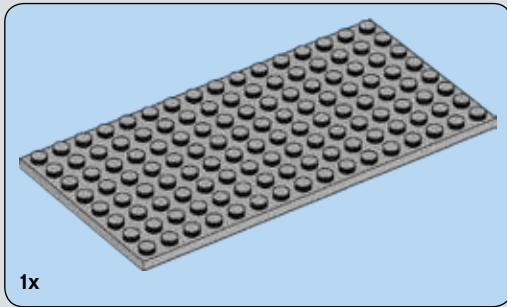
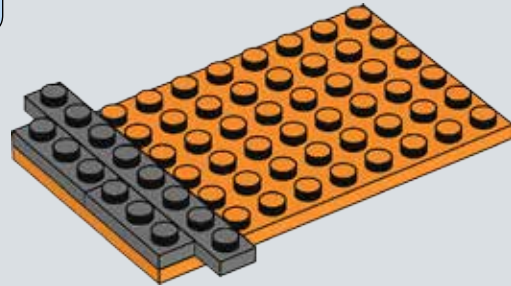

25

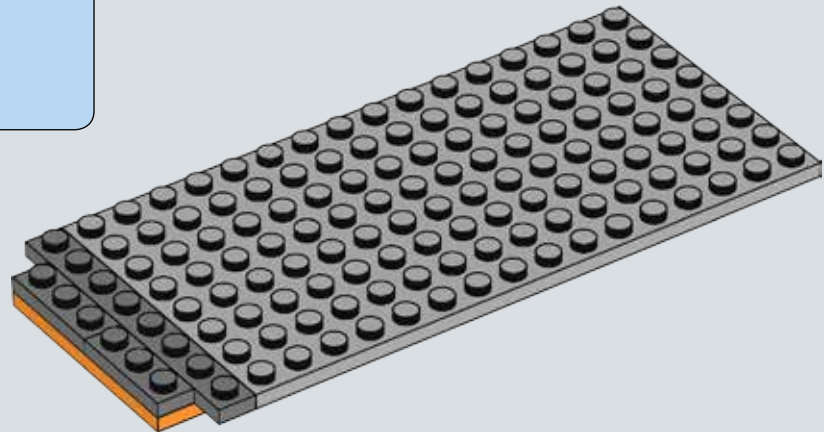

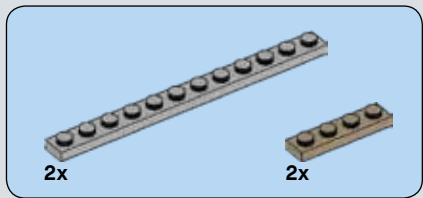

26

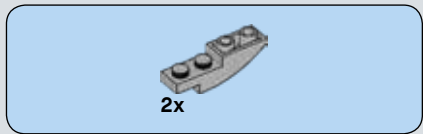
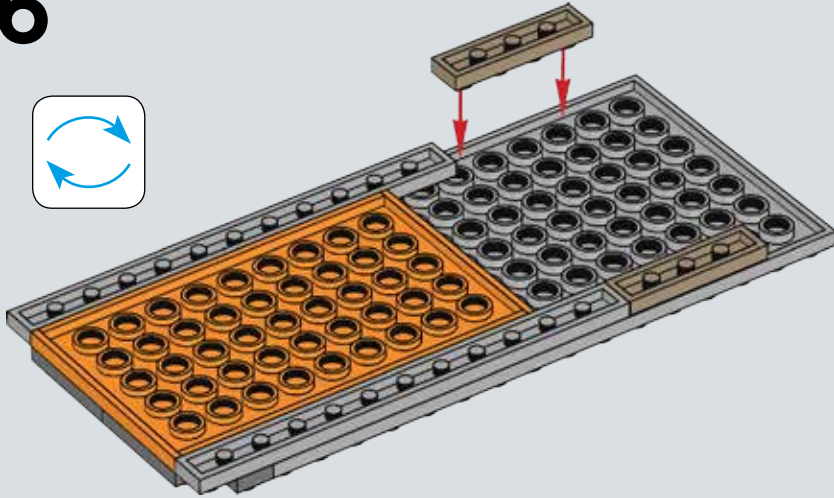

27

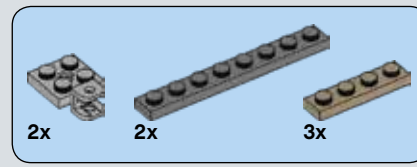
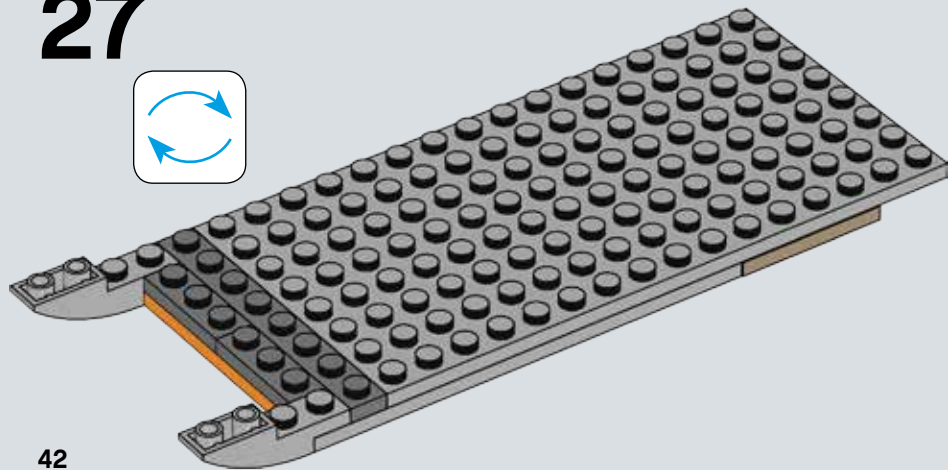
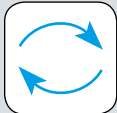

28

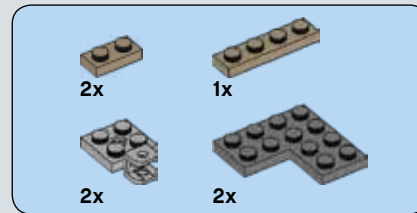
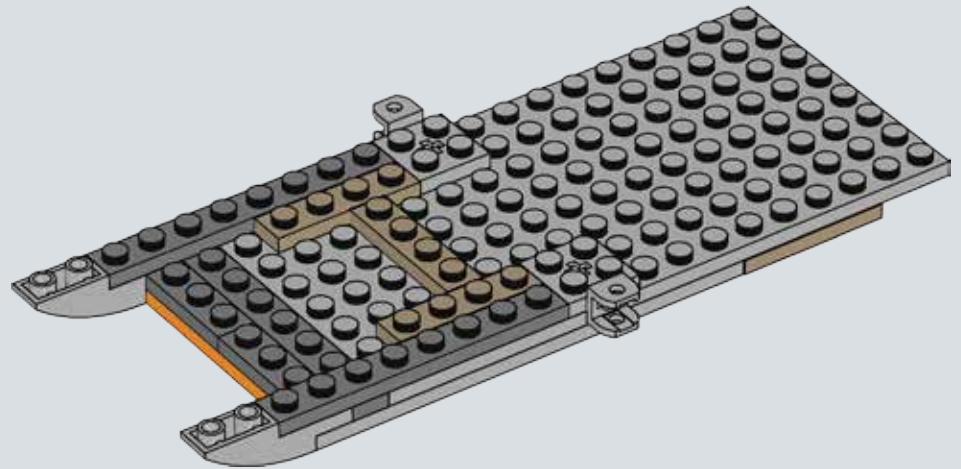

29

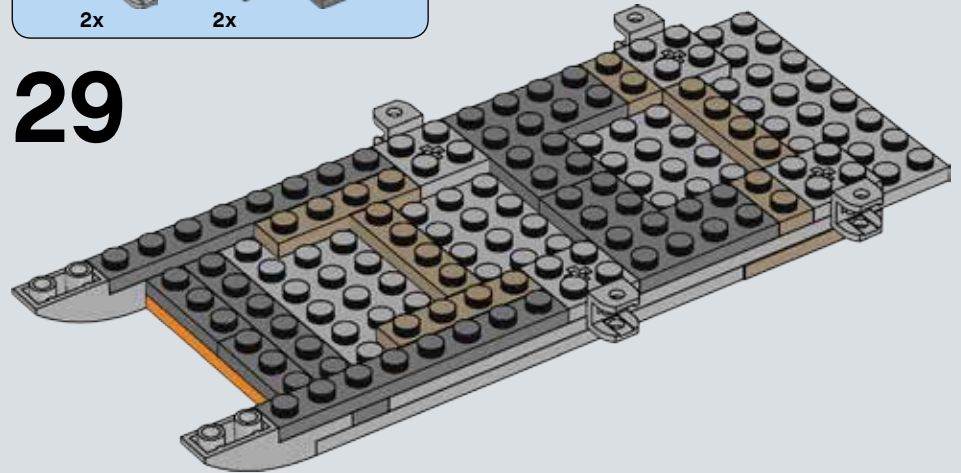

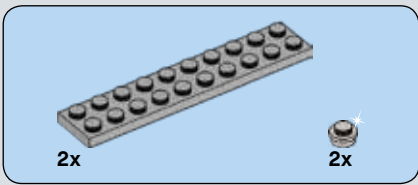

30

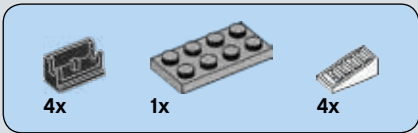
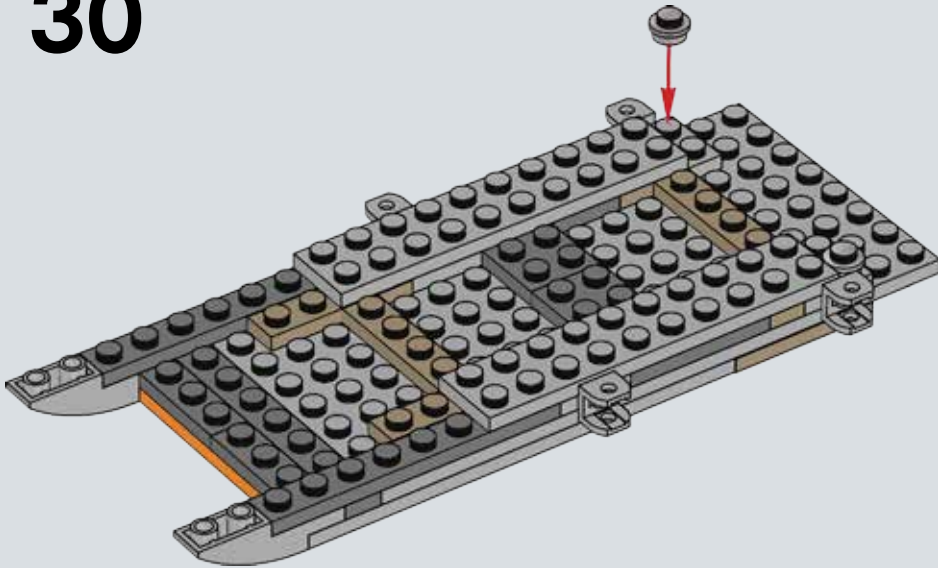

31

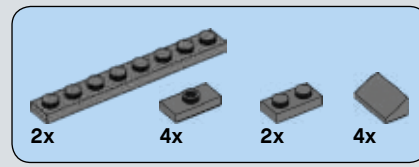
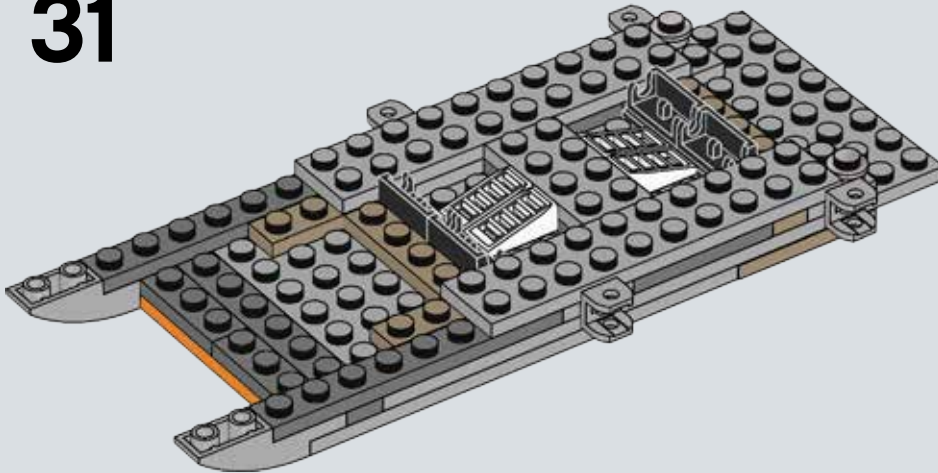

32

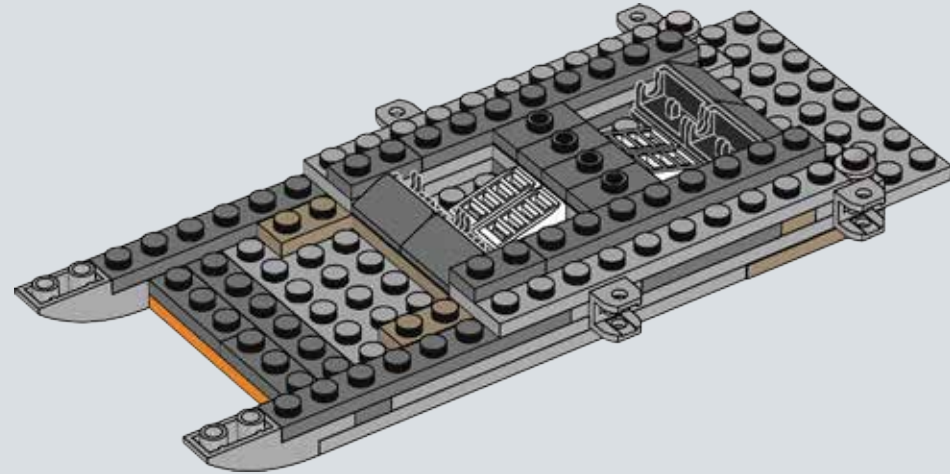

33

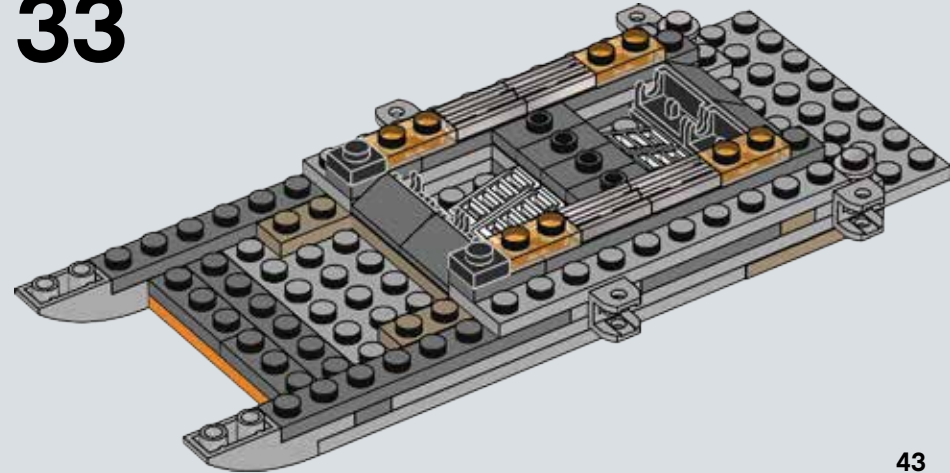



34

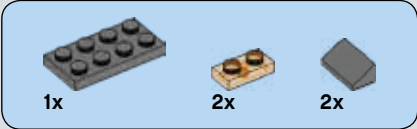
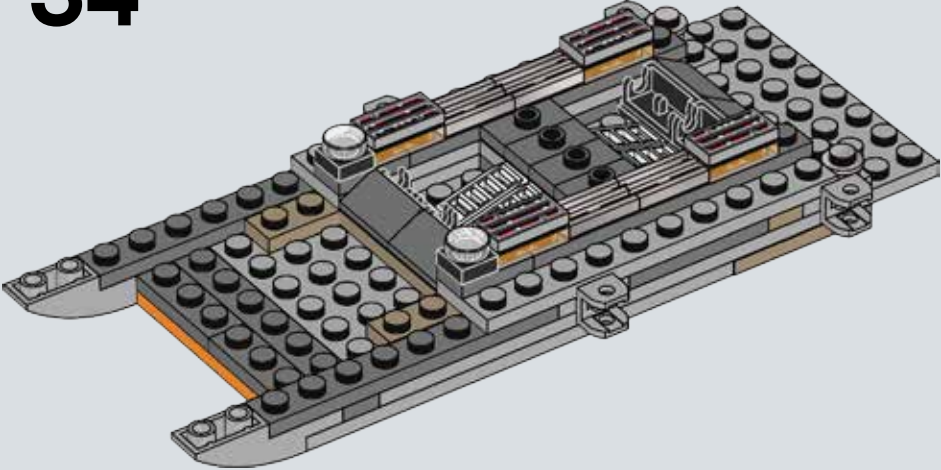

35

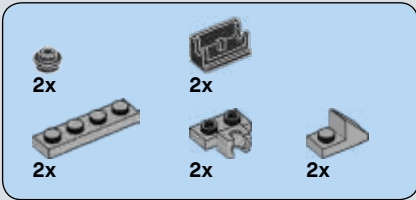
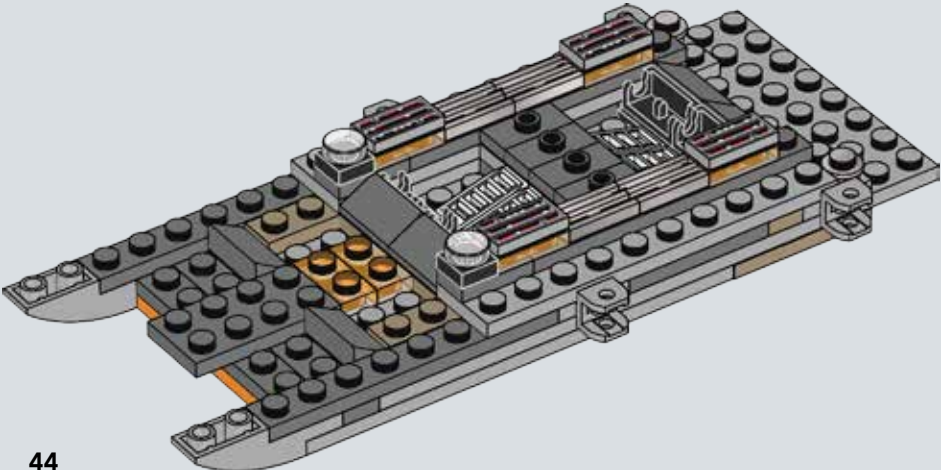

36

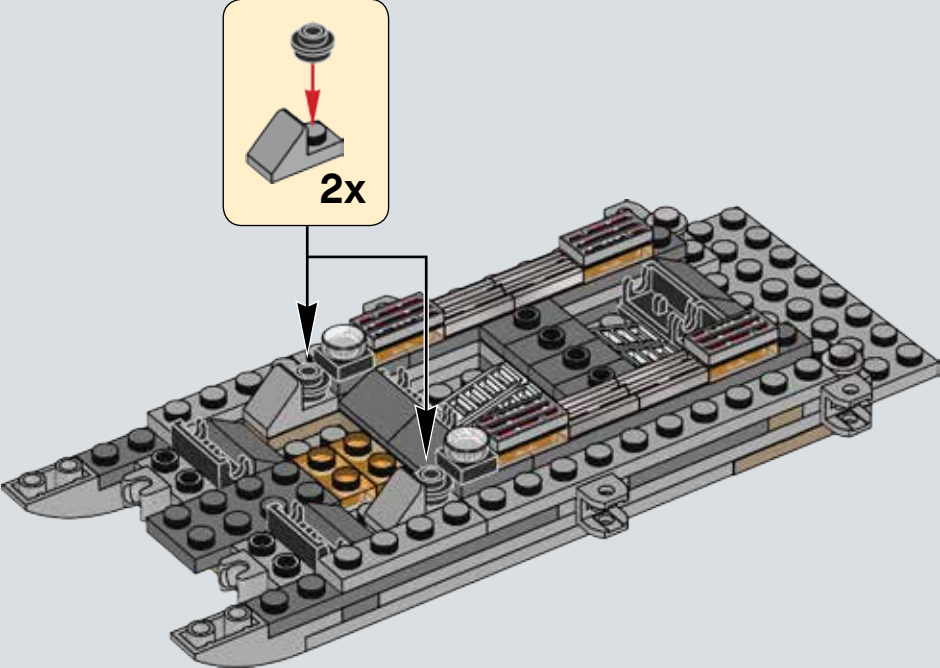

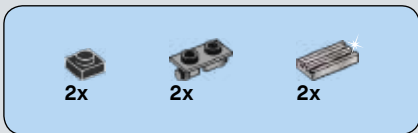

37

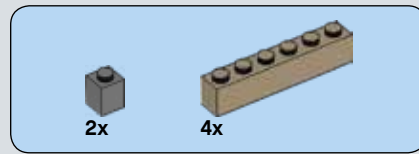
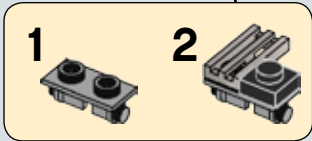
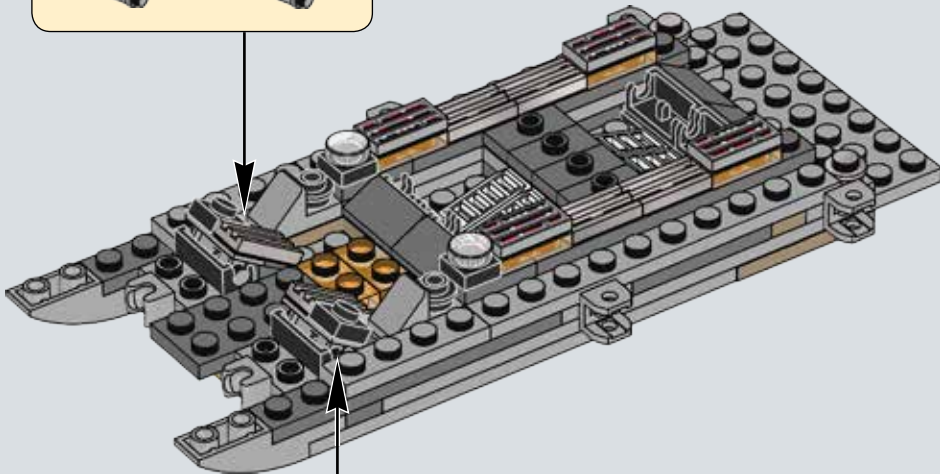
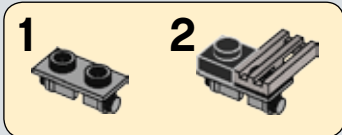

38

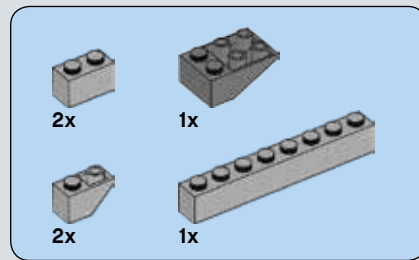
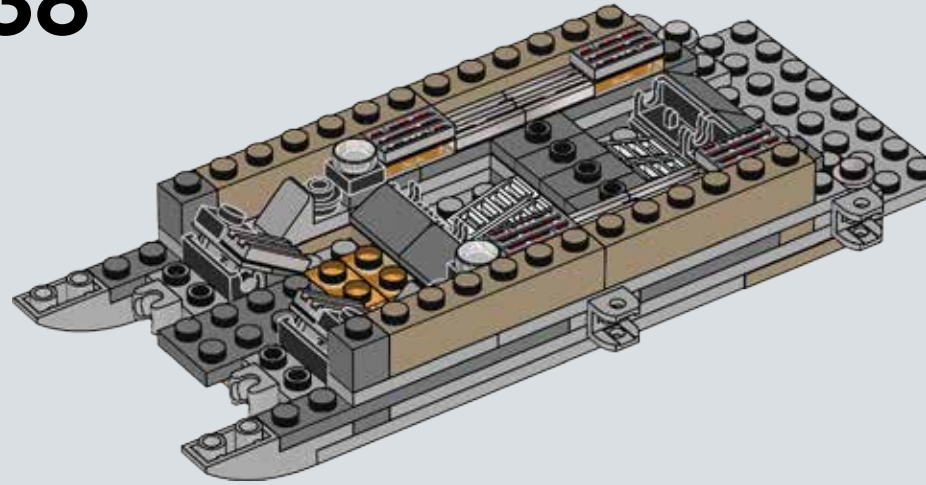

39

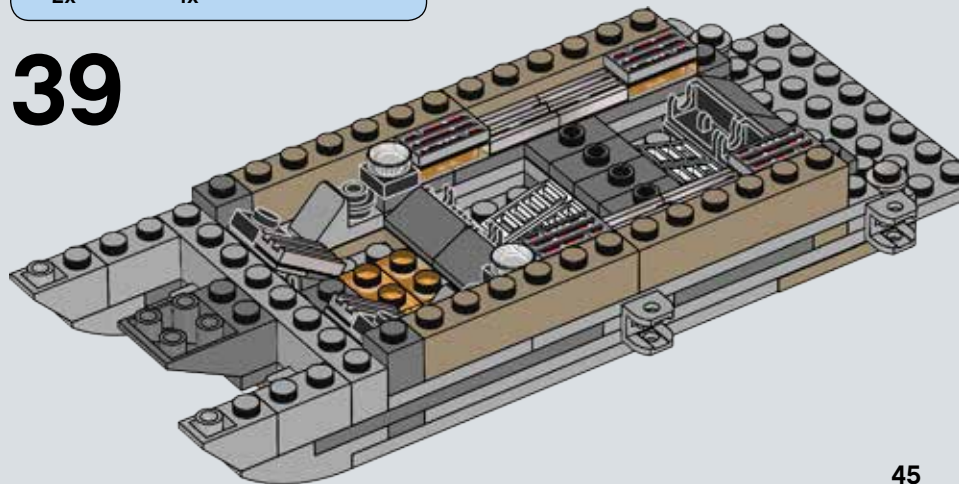



40

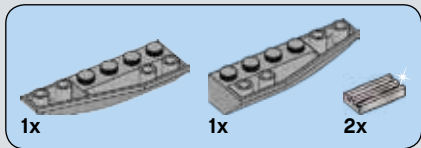
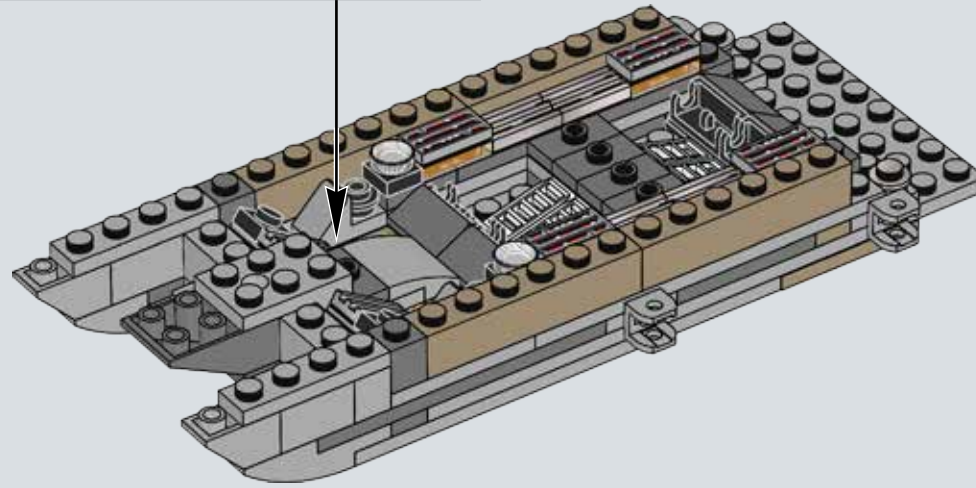
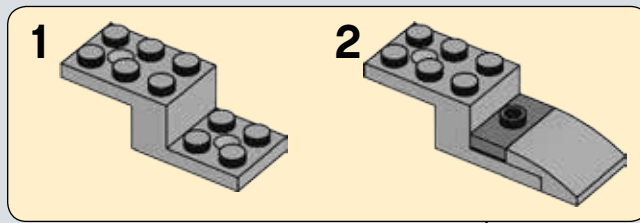

41

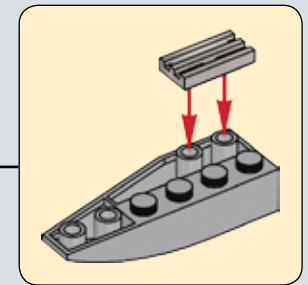
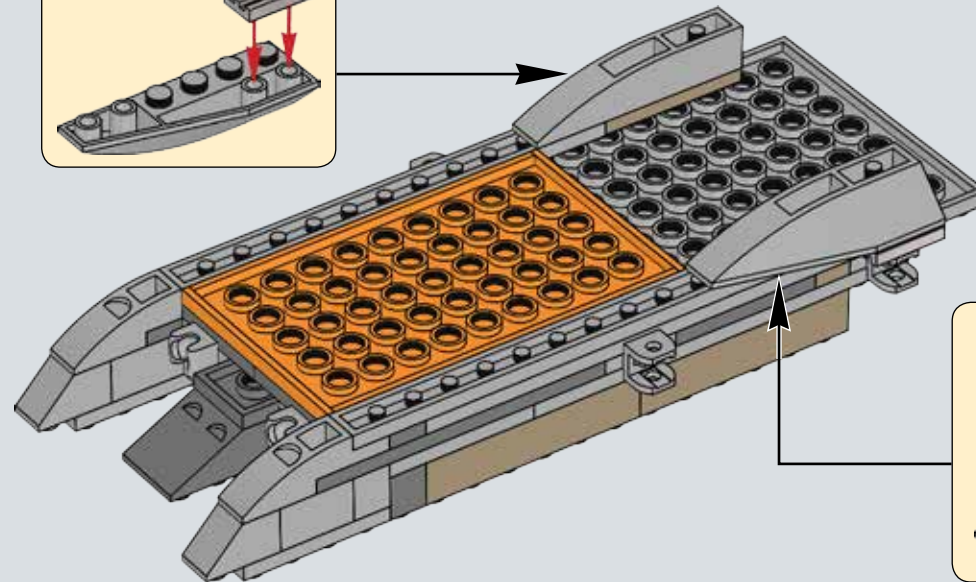
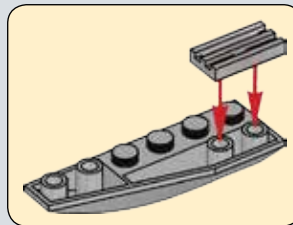
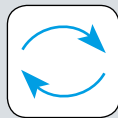

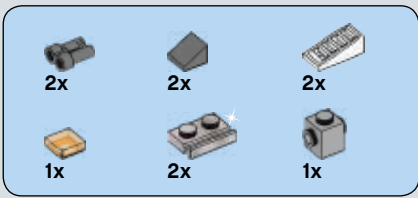

42

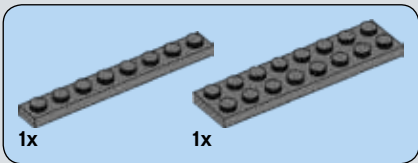
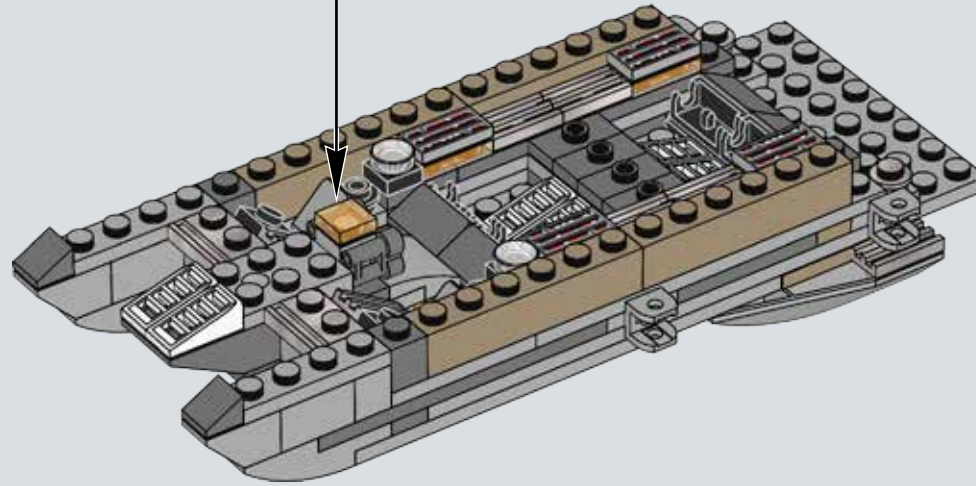
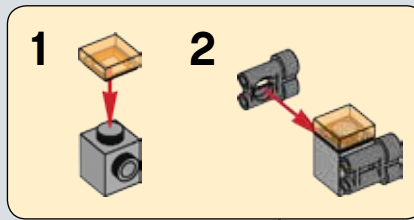
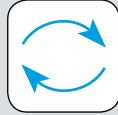

43

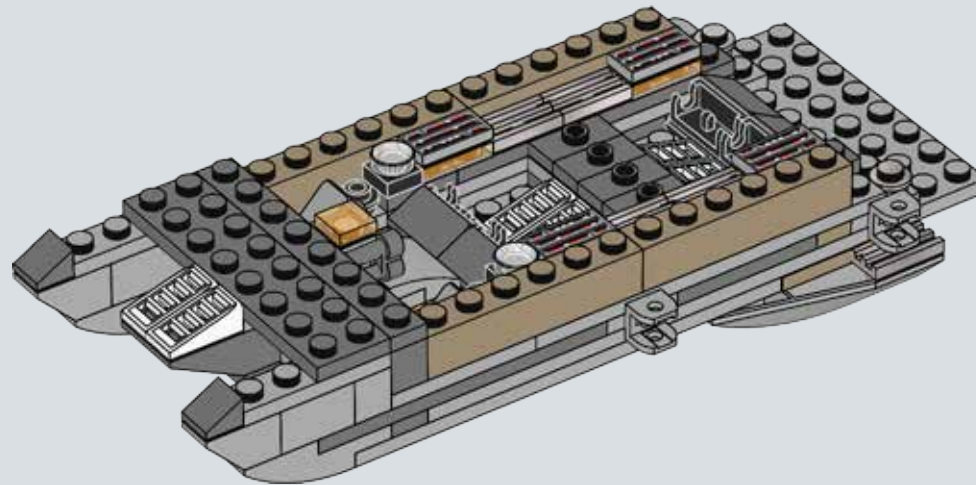

44

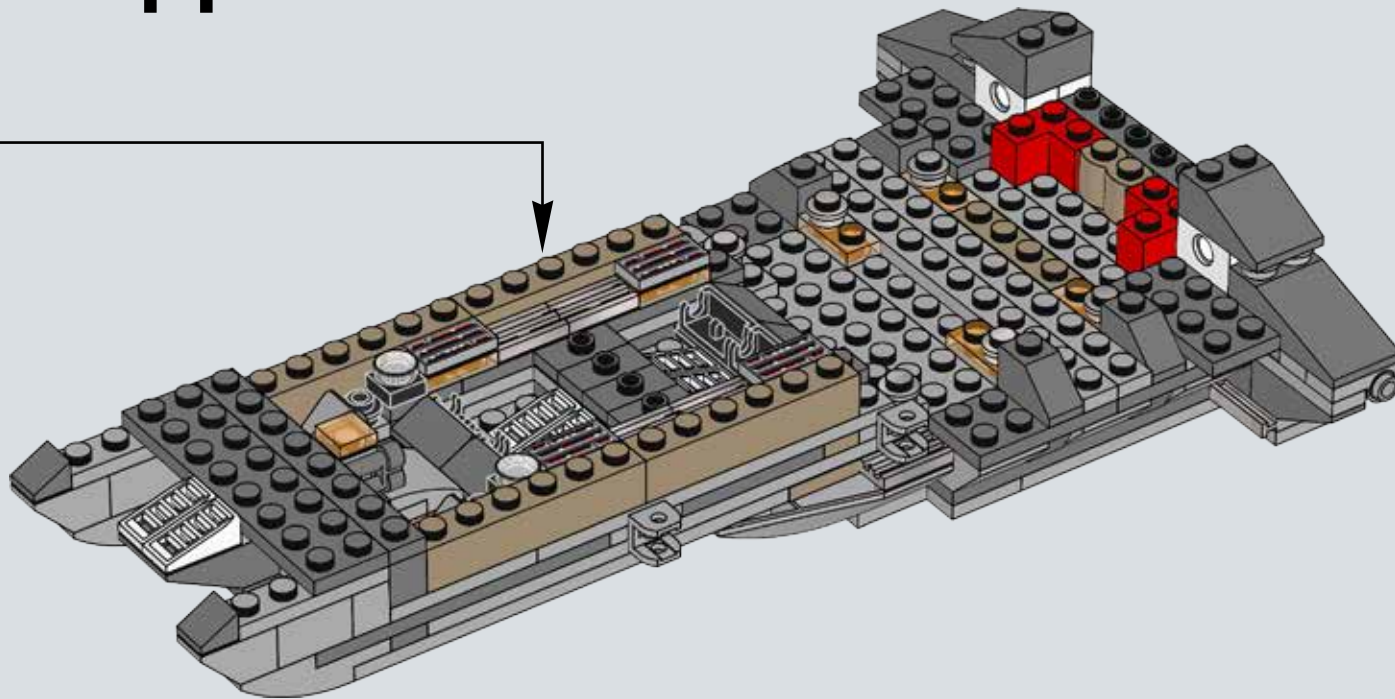

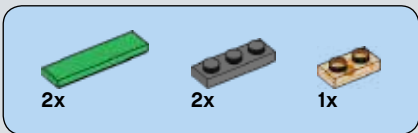

45

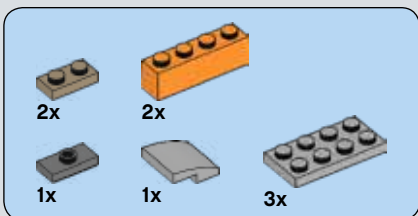
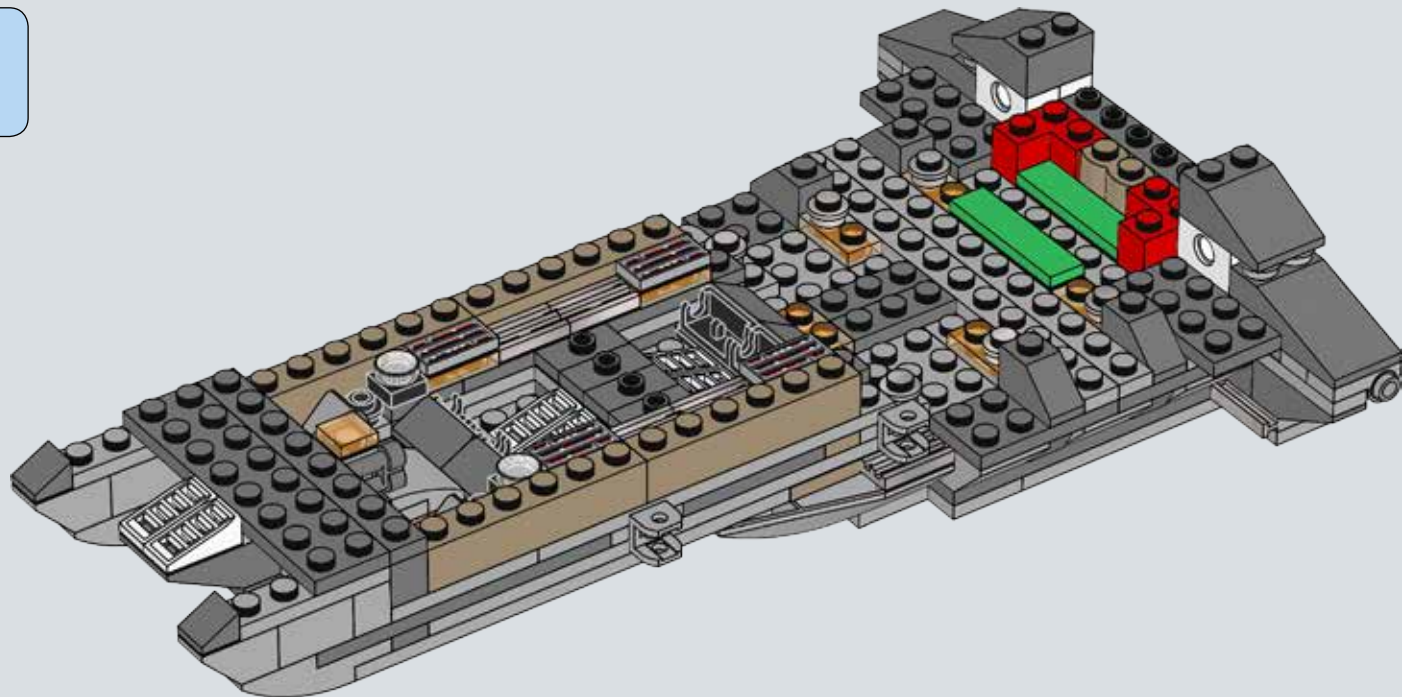

46

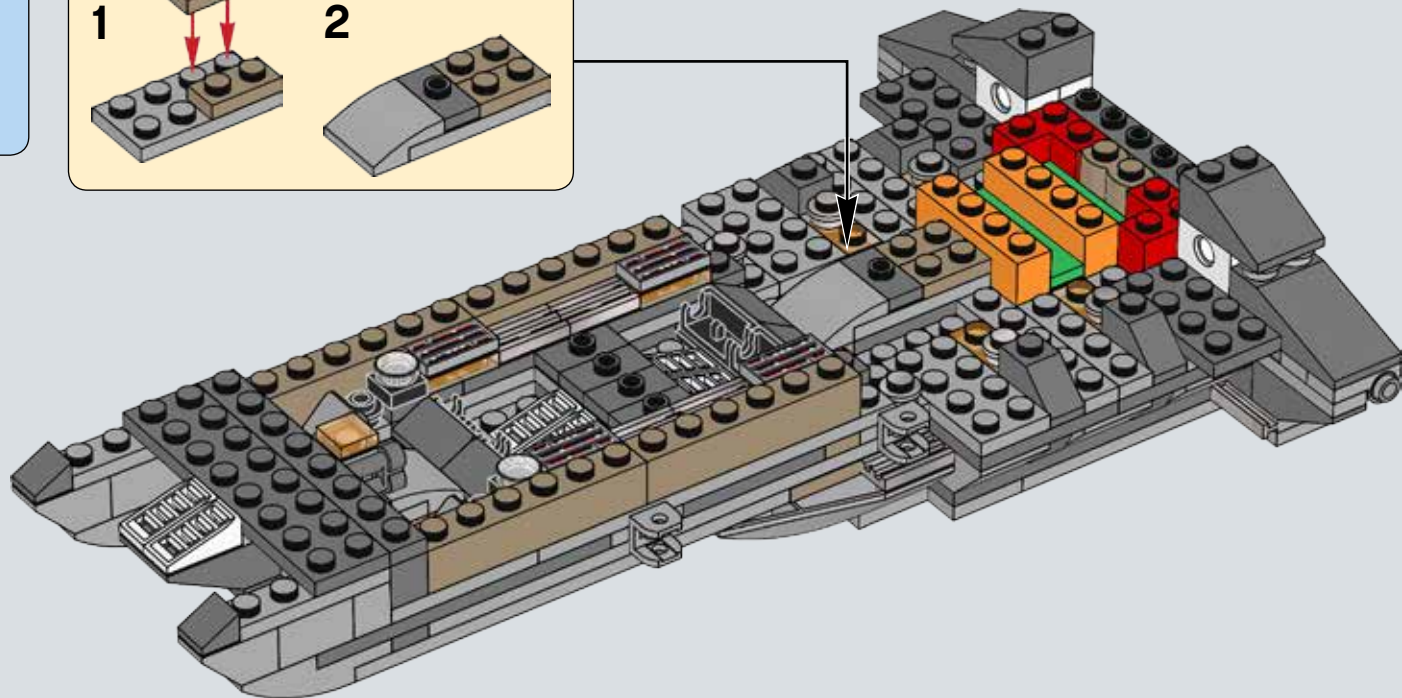
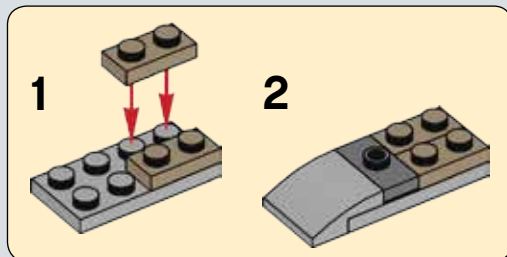

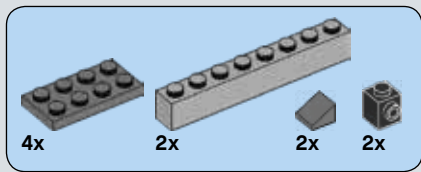

47

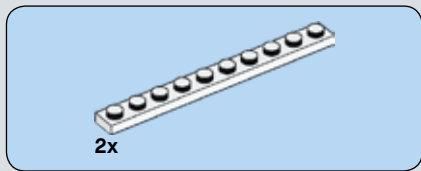
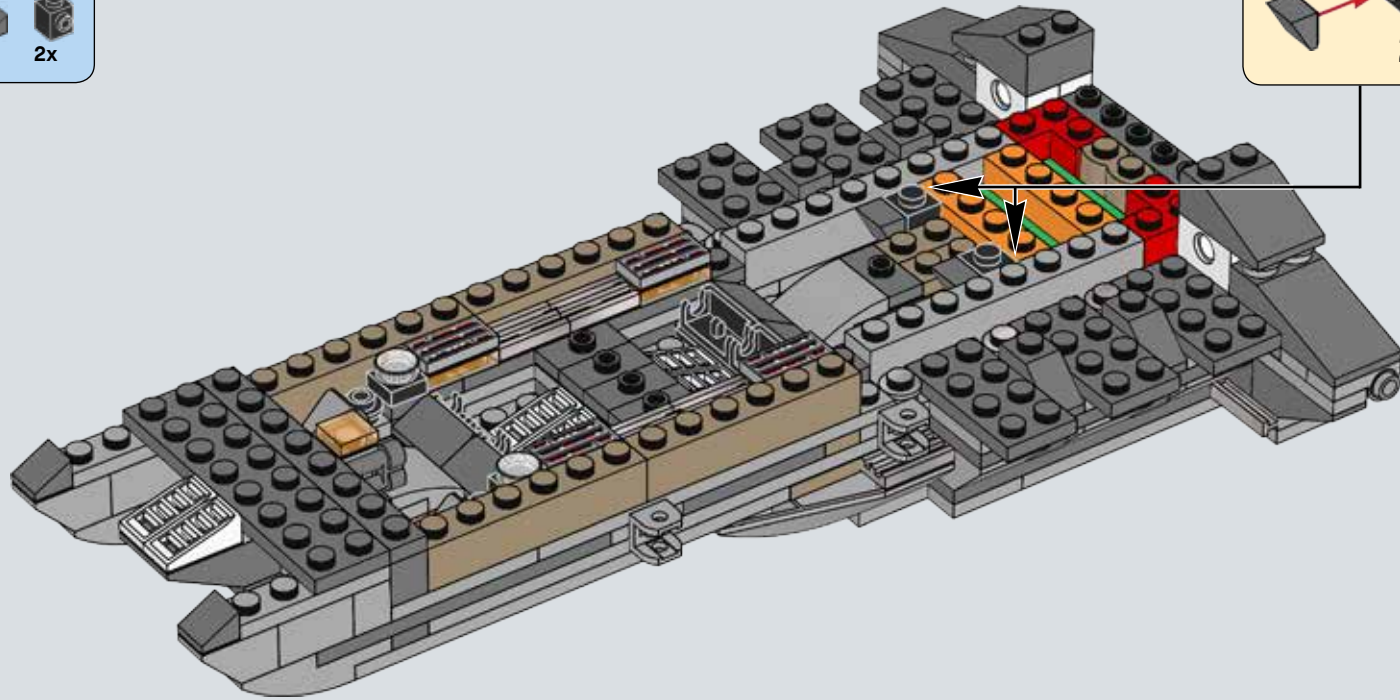

48

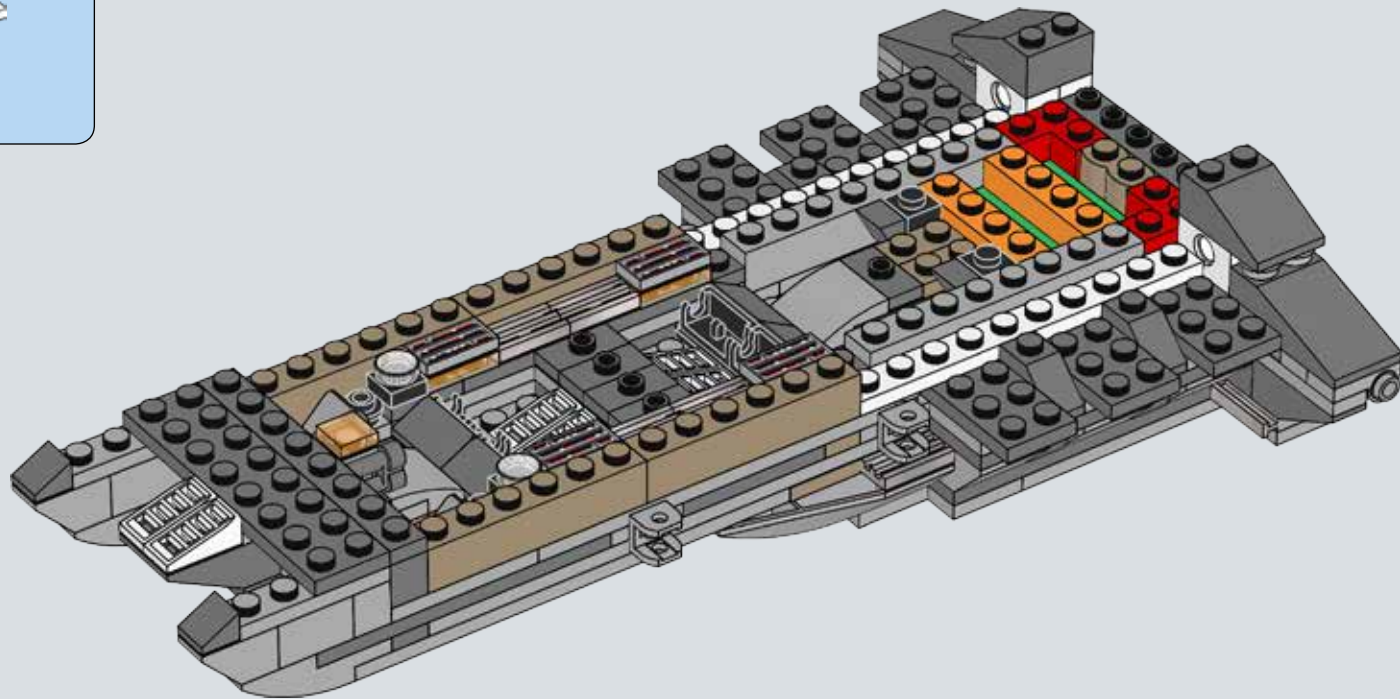



49

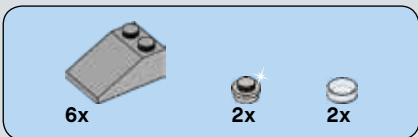
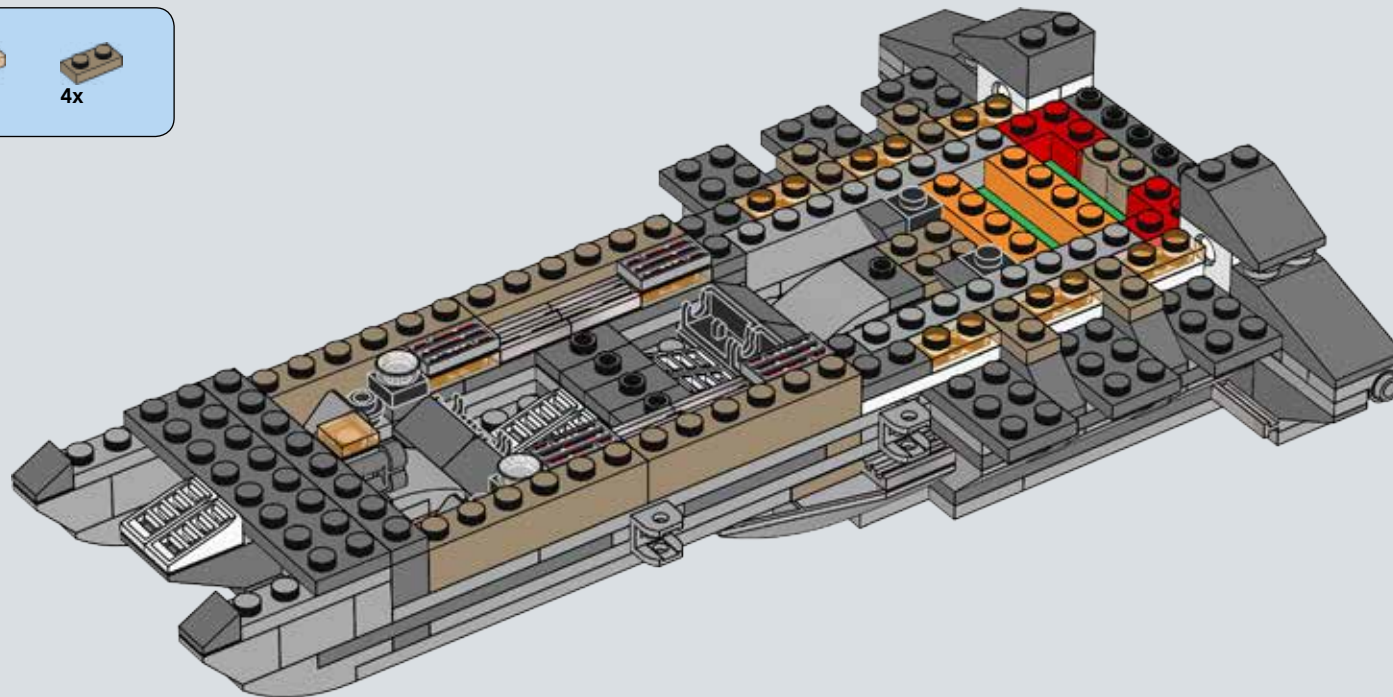

50

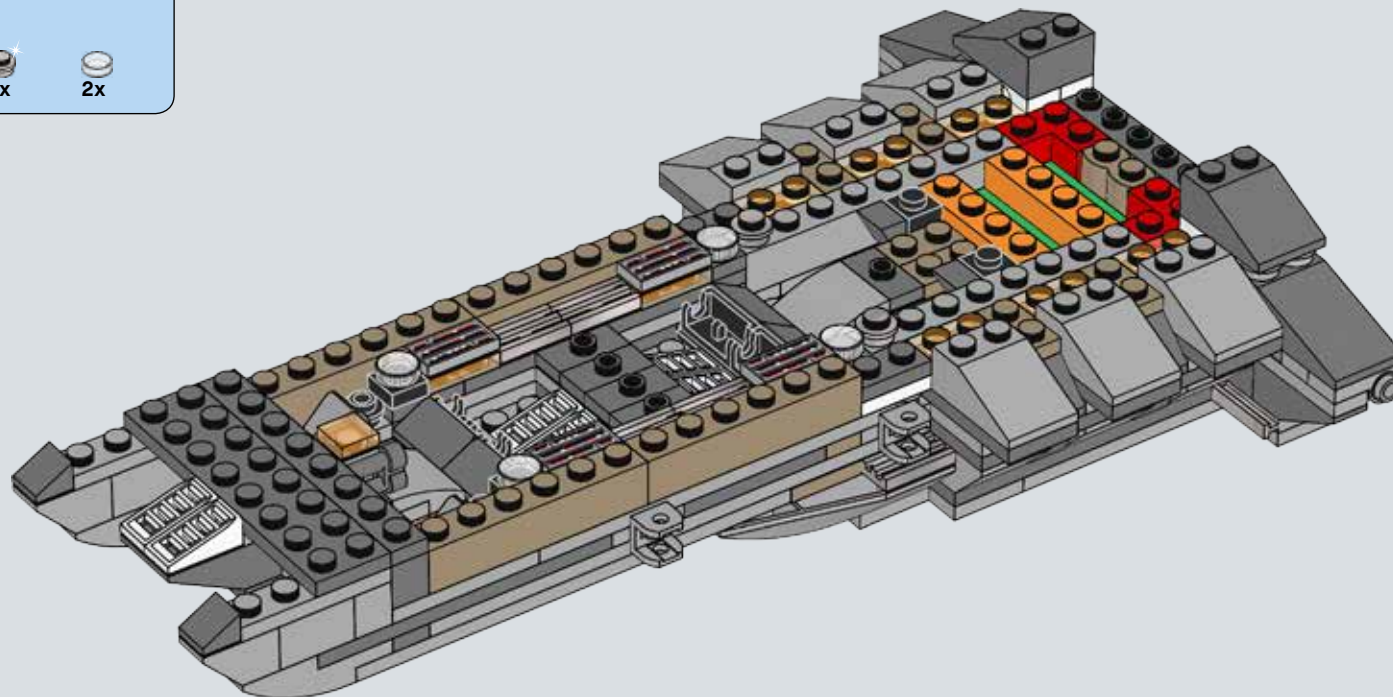

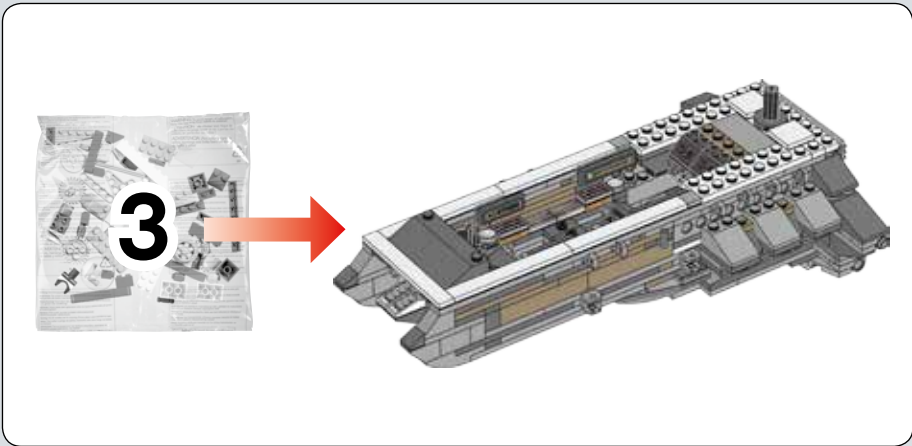

51

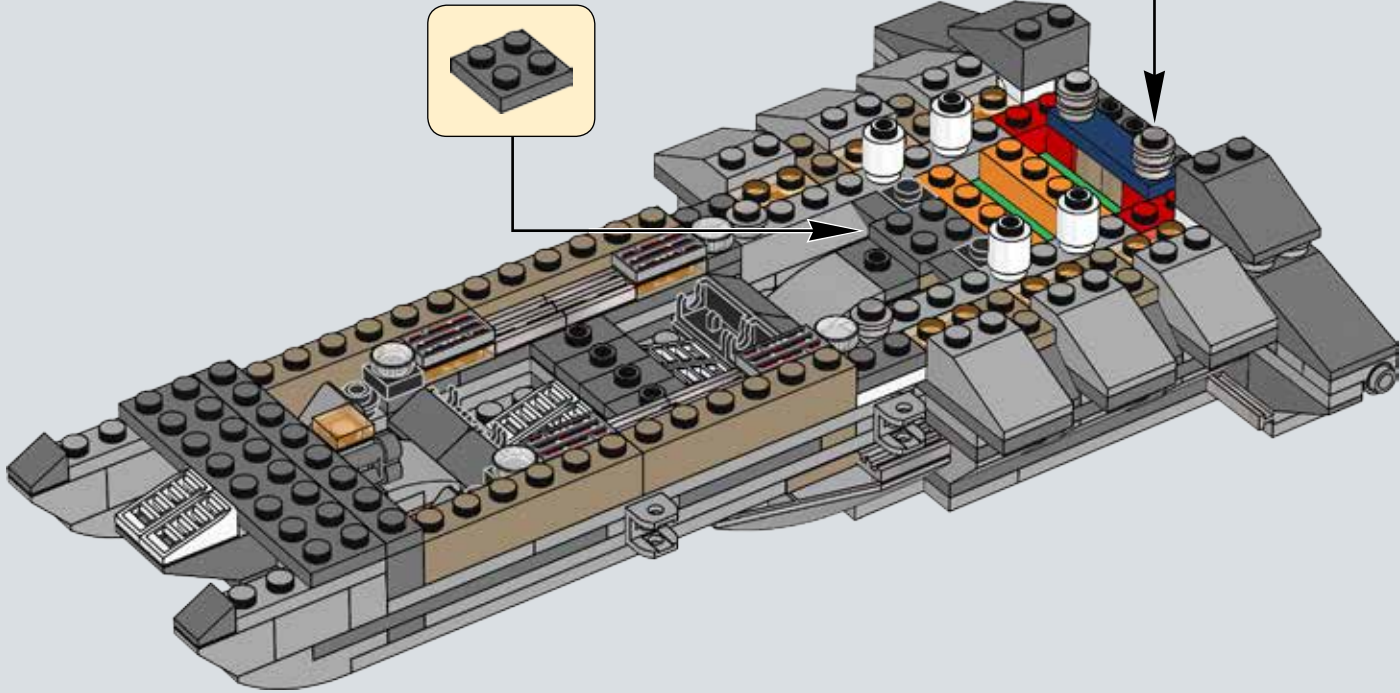
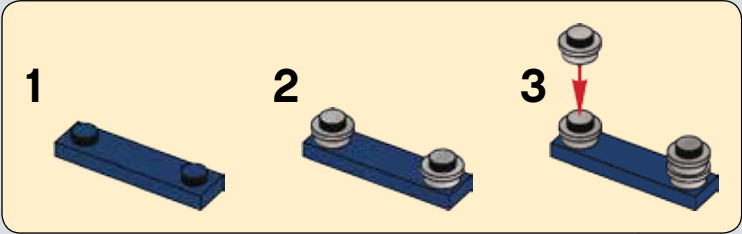

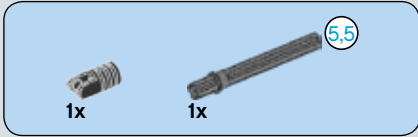
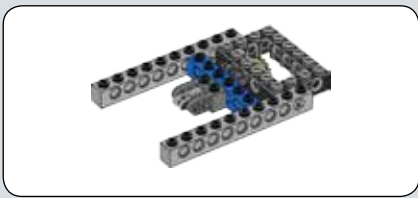

52

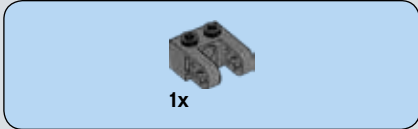
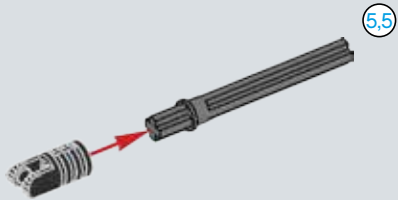

53

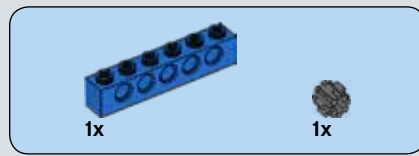
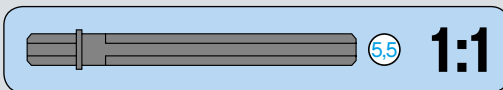
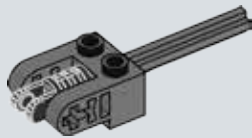

54

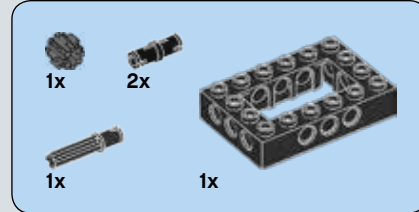
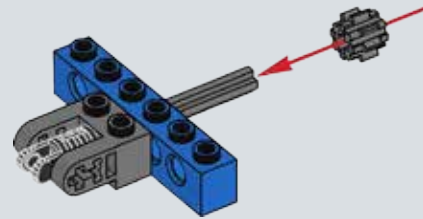

55

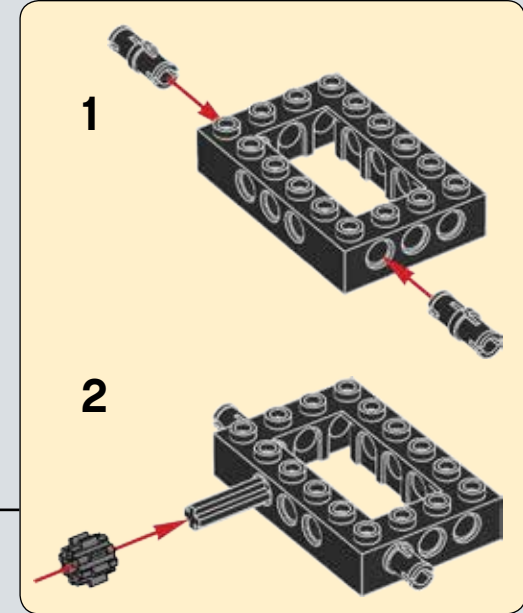
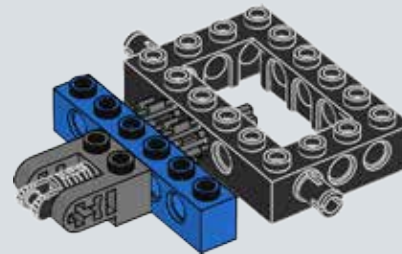



1x

56

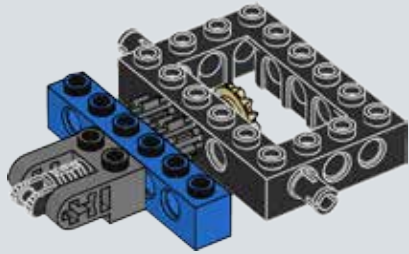

2x

57

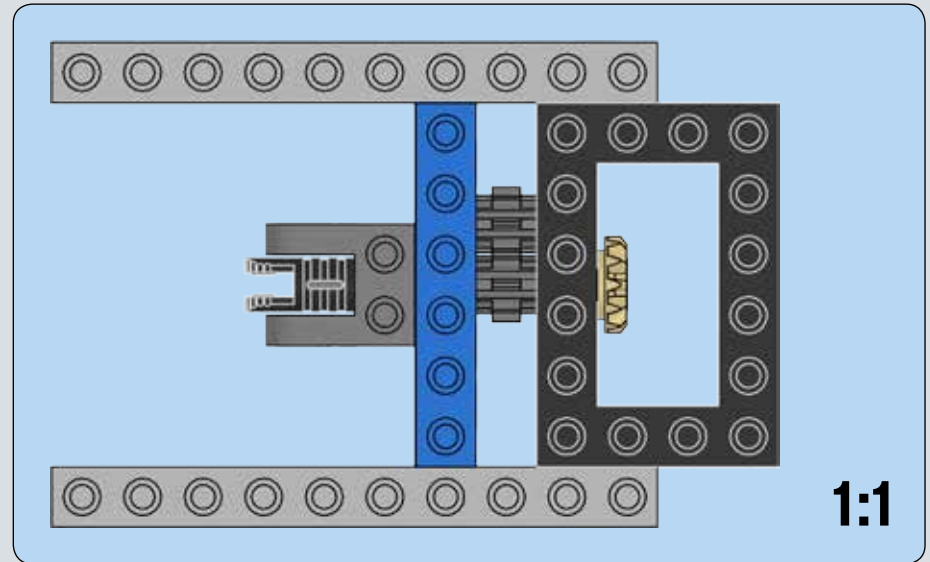
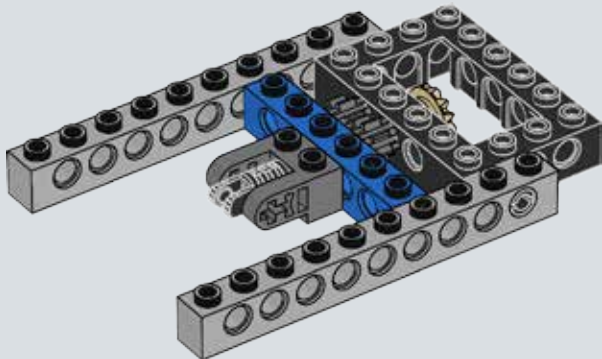

58

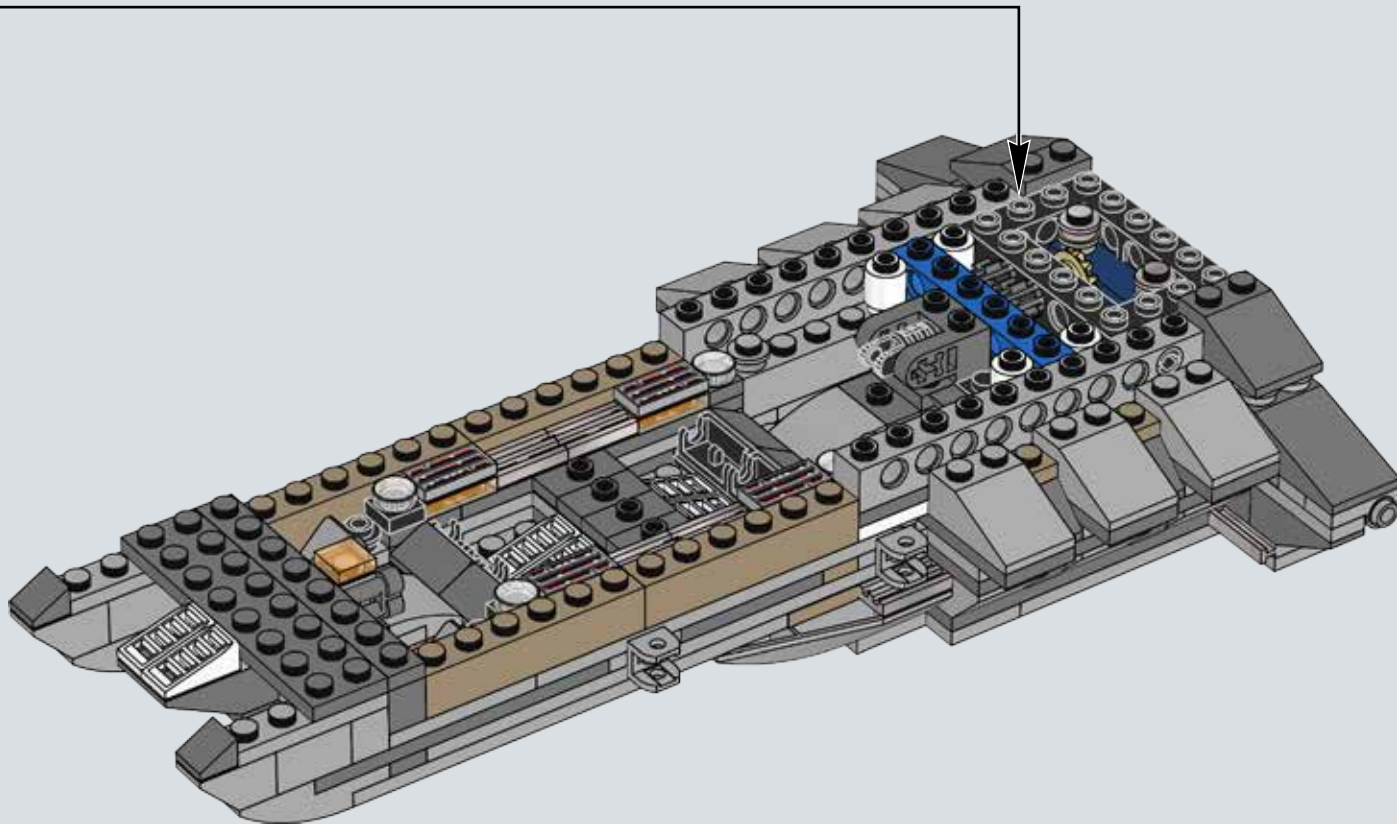



2x

59

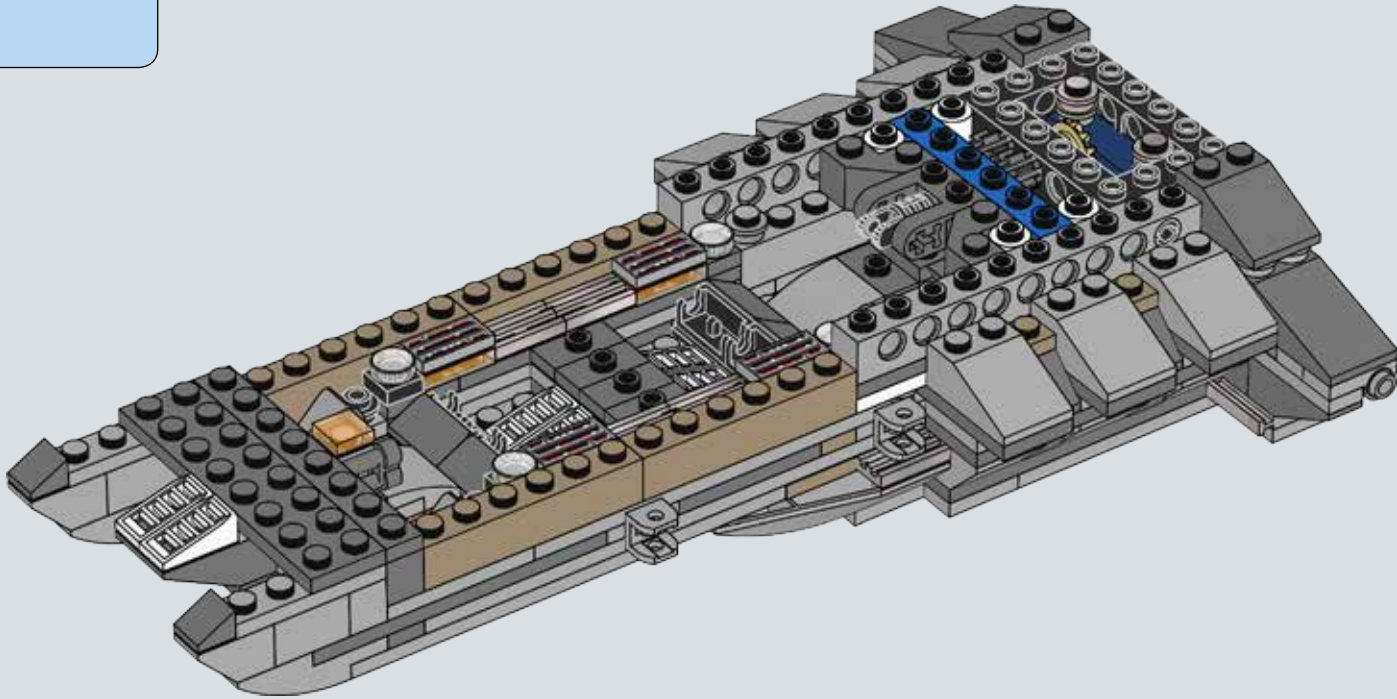

1x



2x

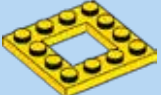

1x

60

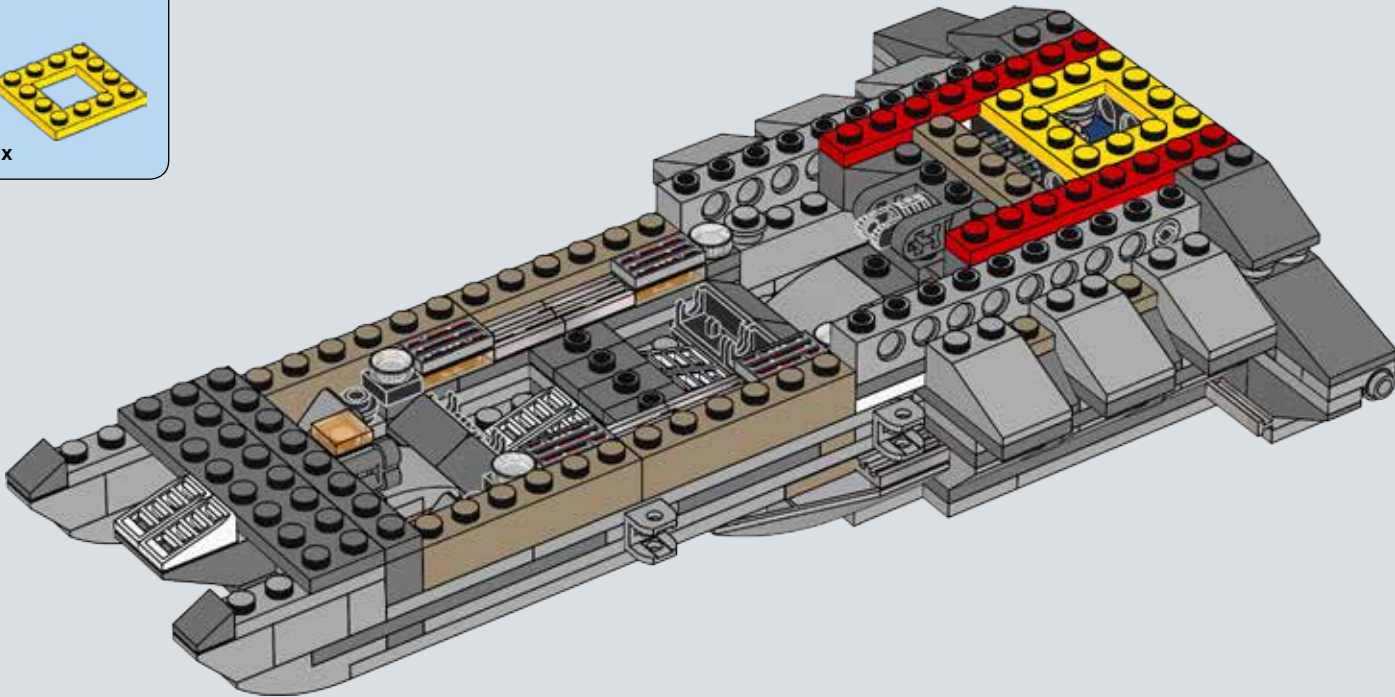

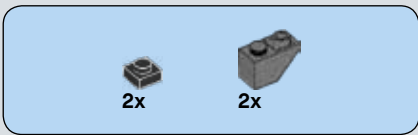

61

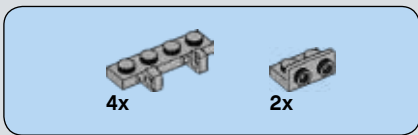
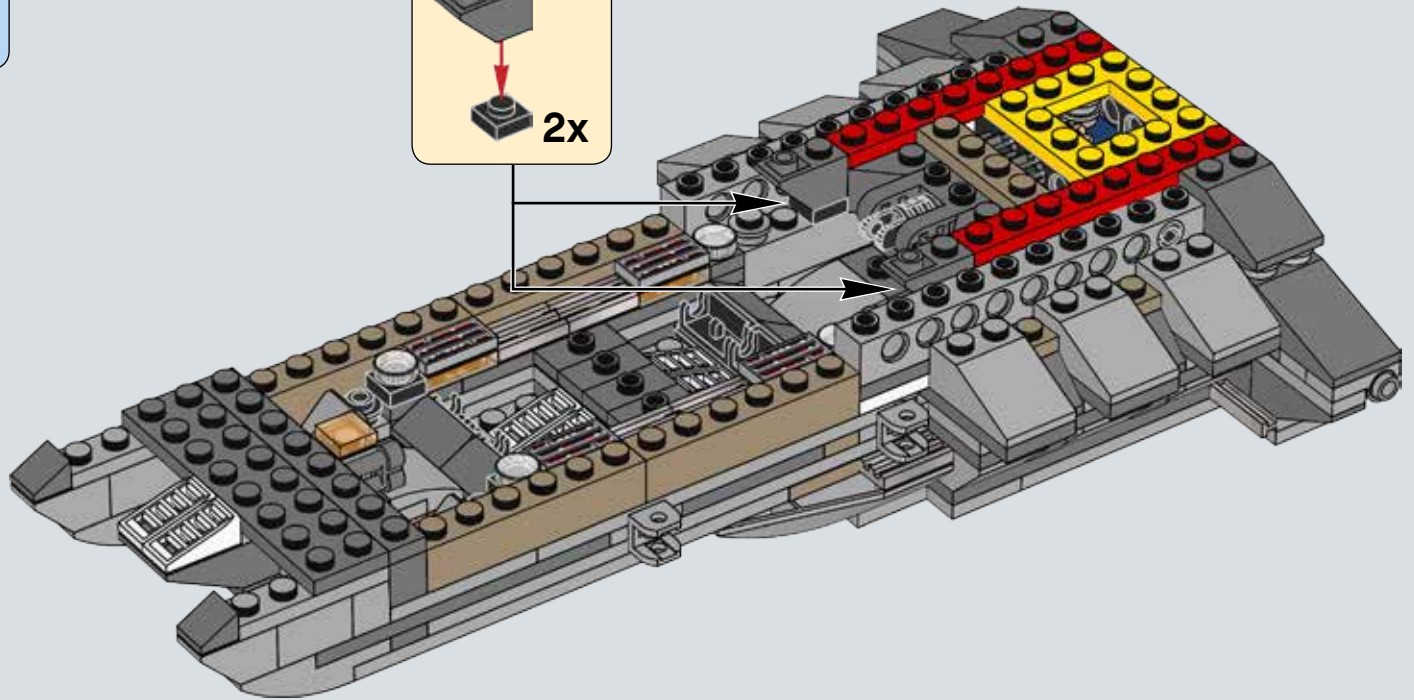
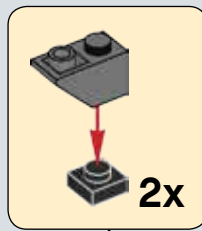

62

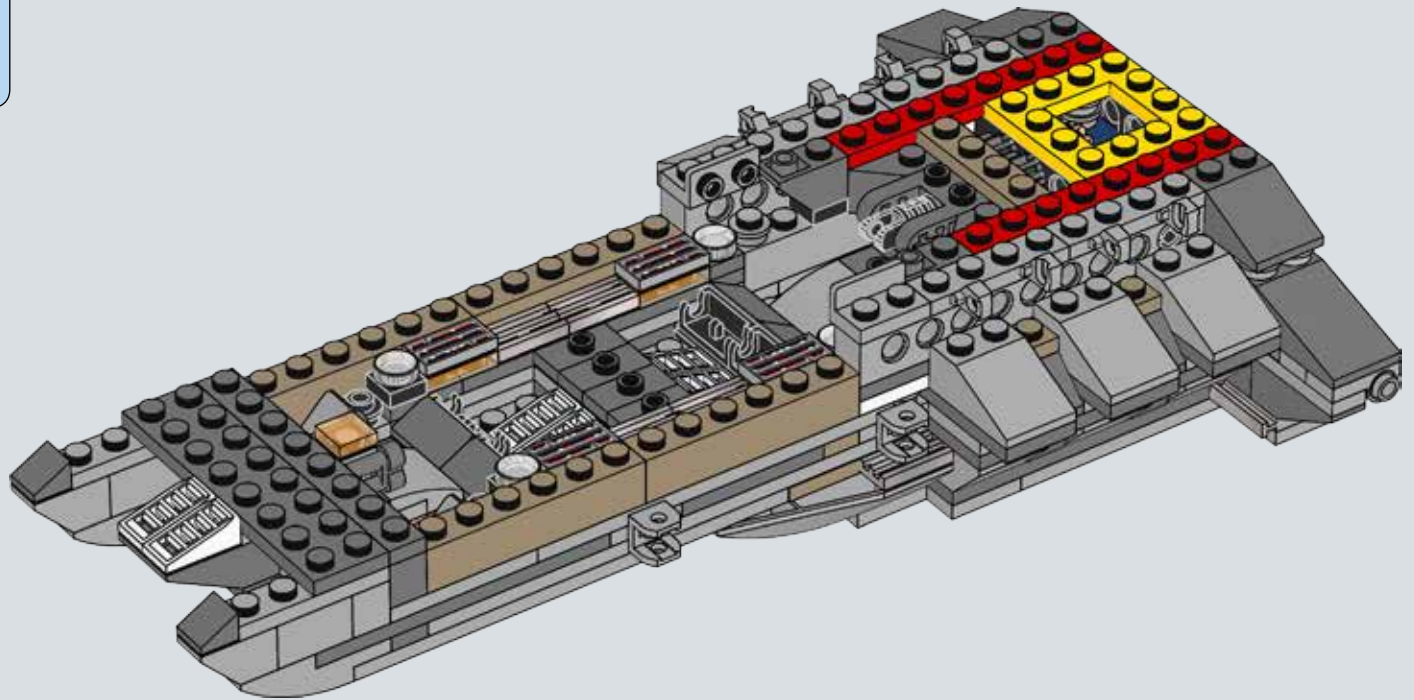

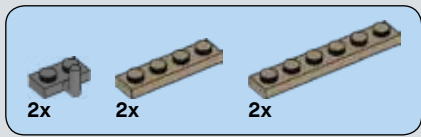

63

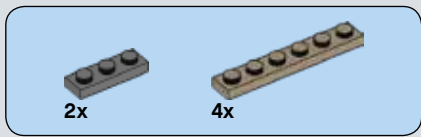
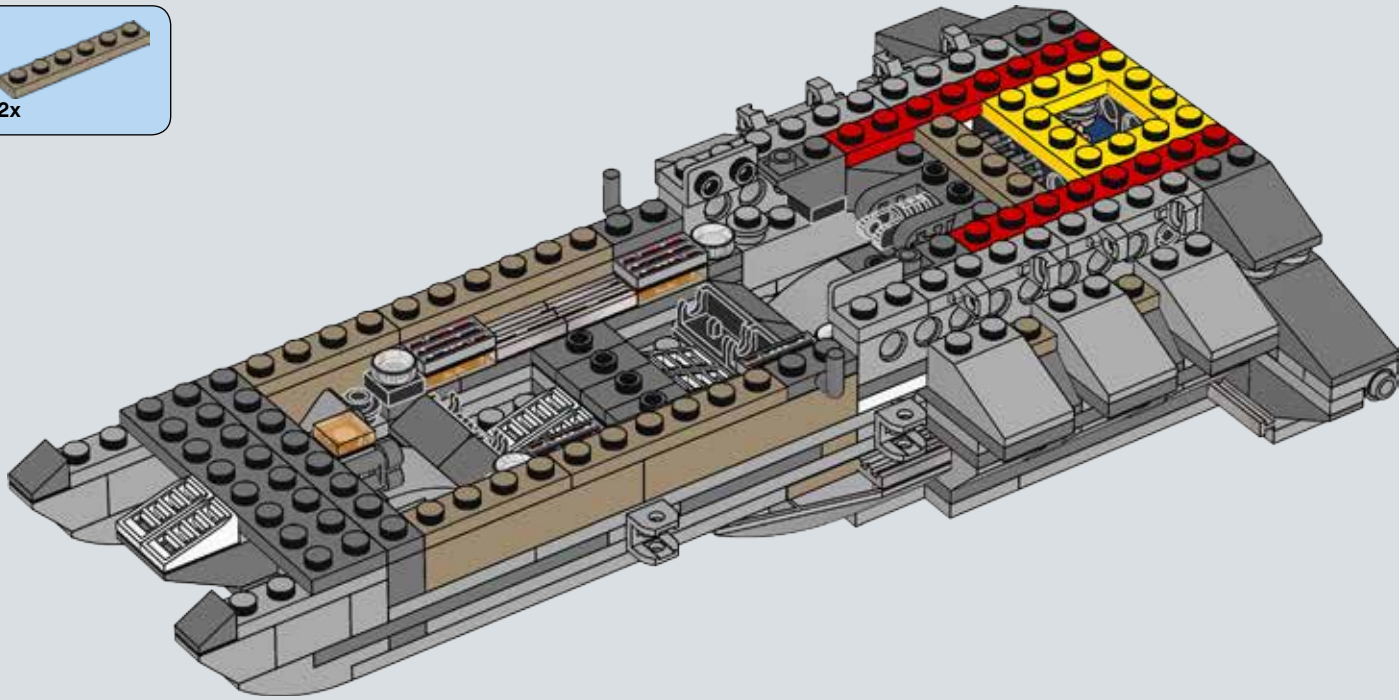

64

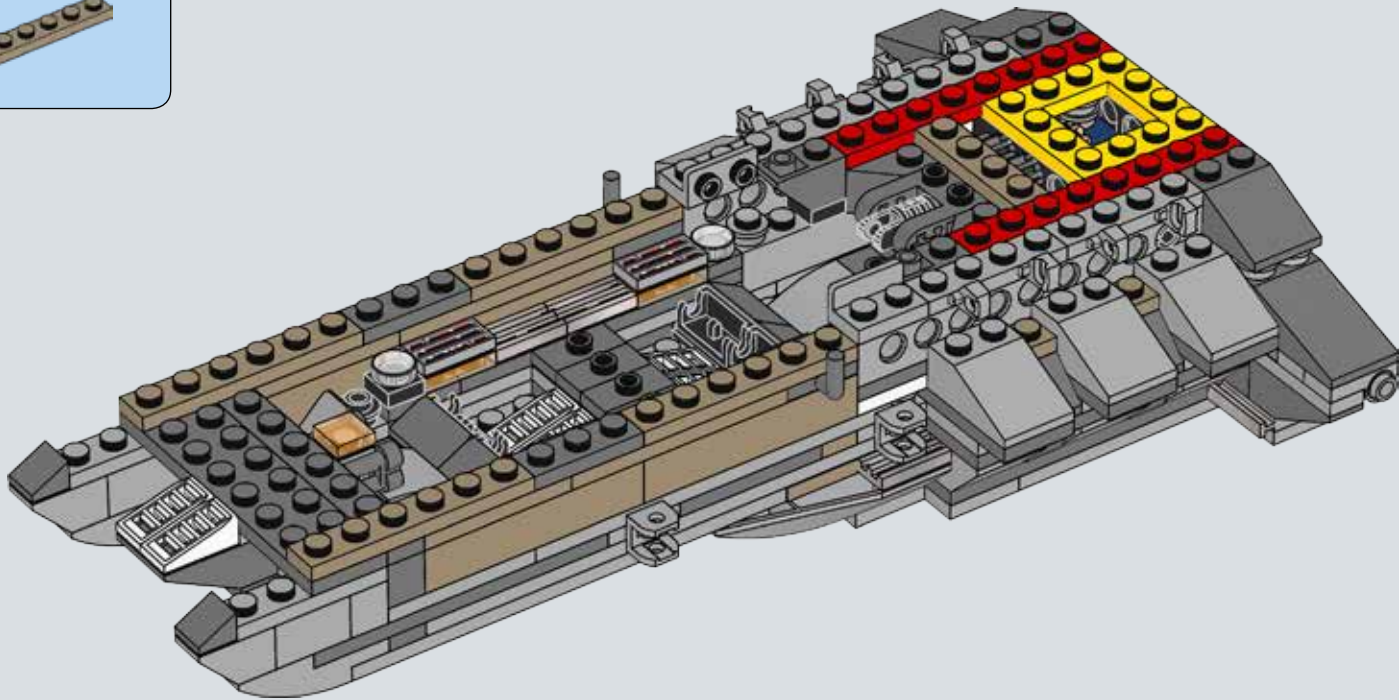

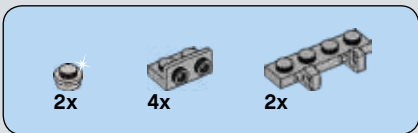

65

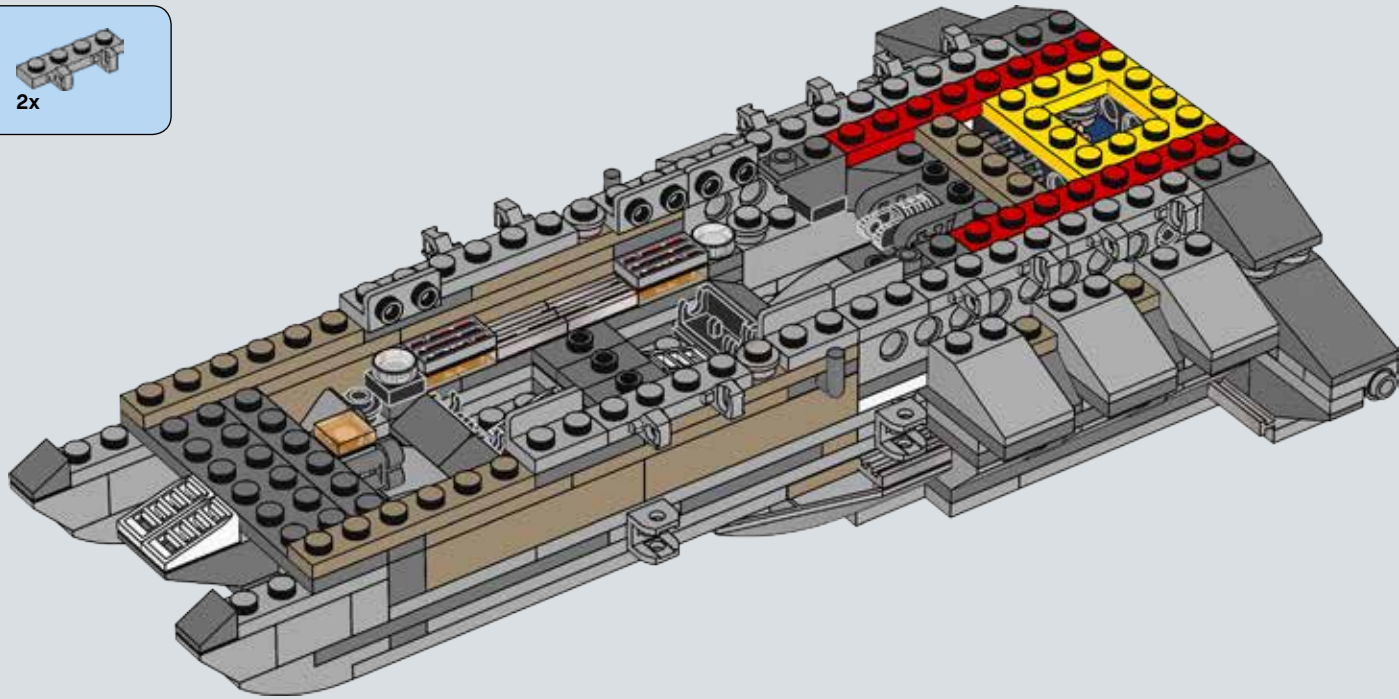

66

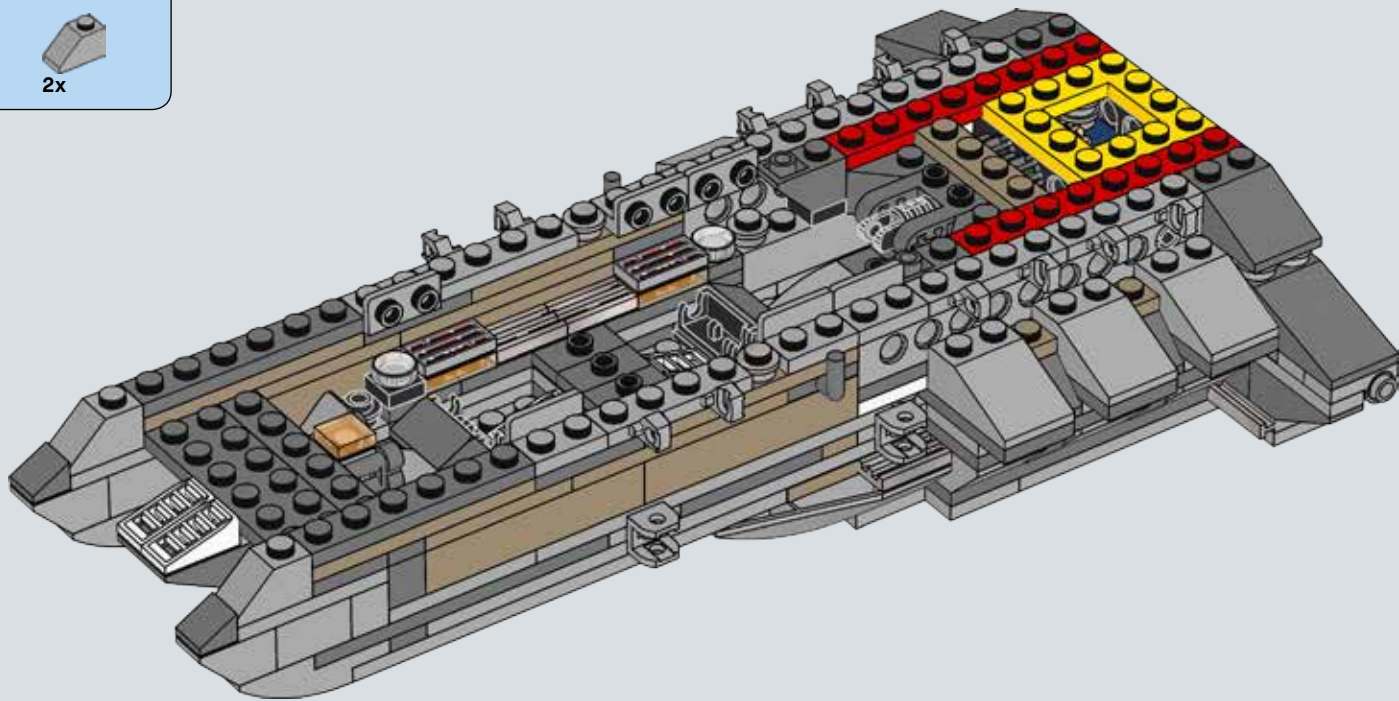



67

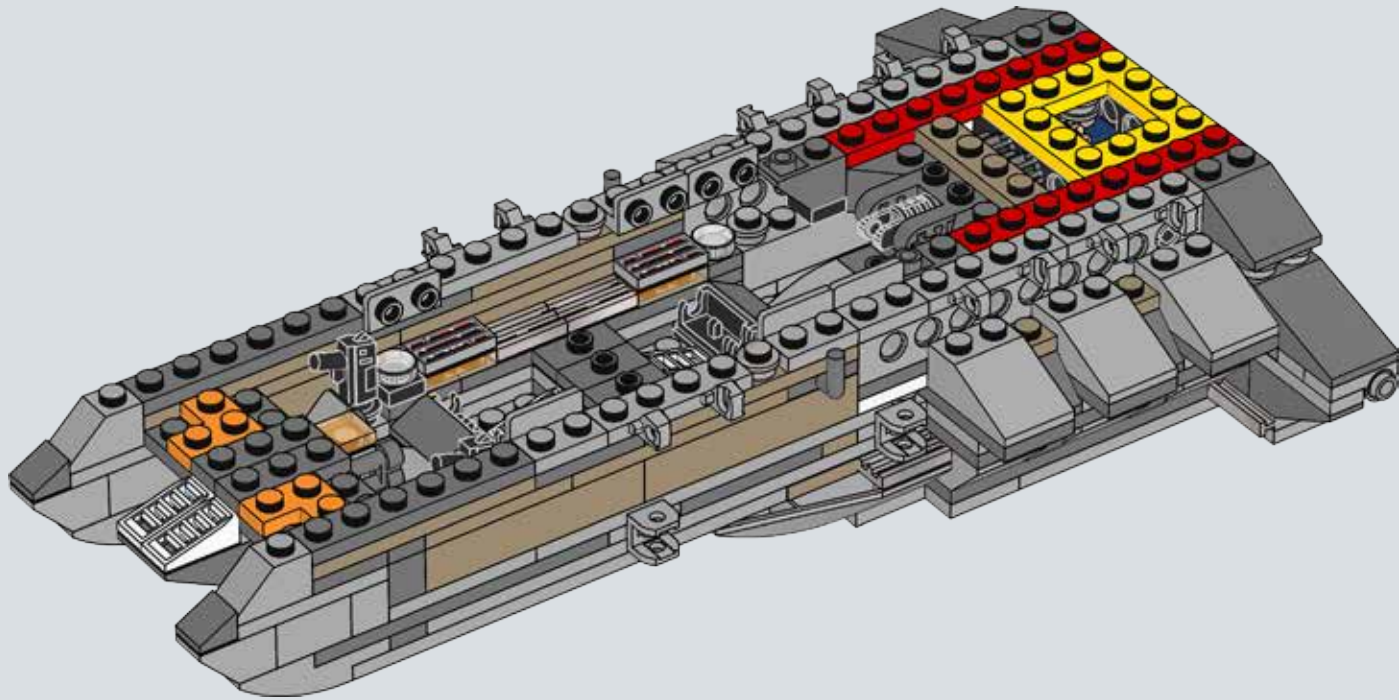



68

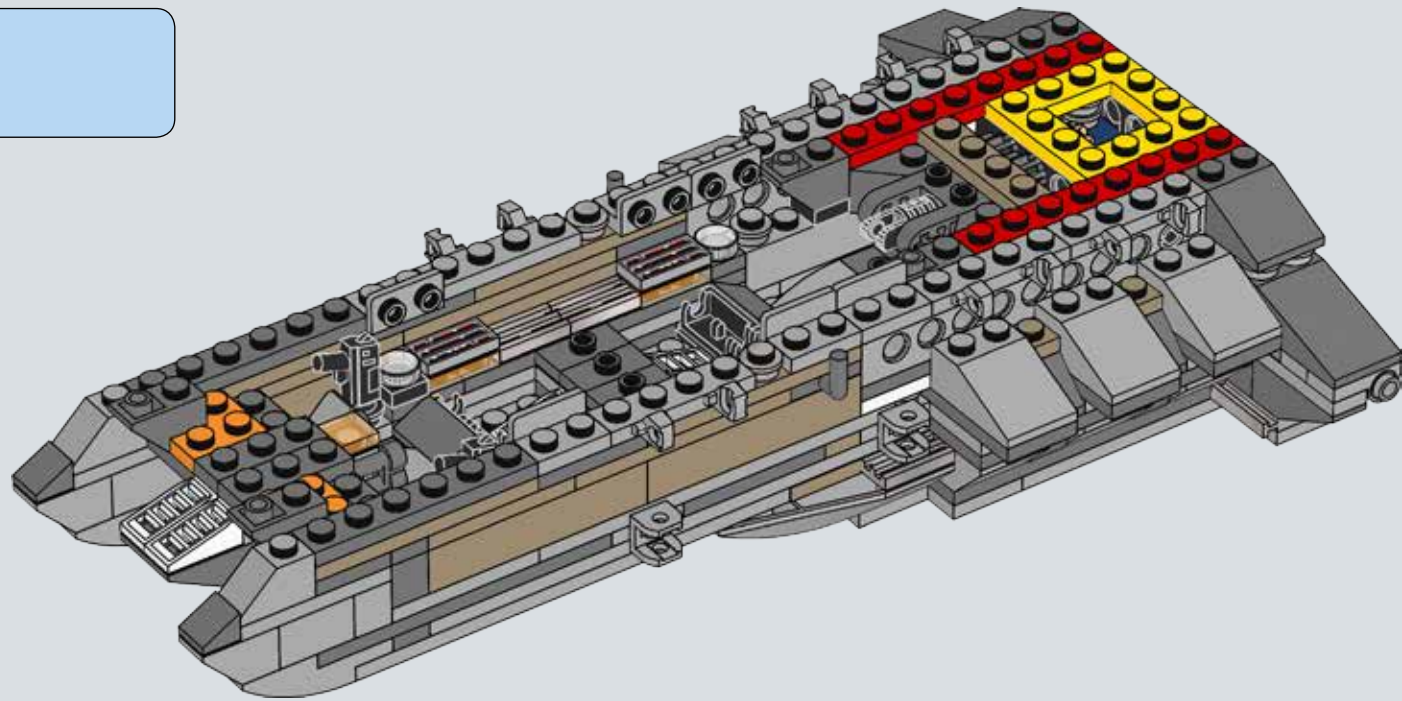

69

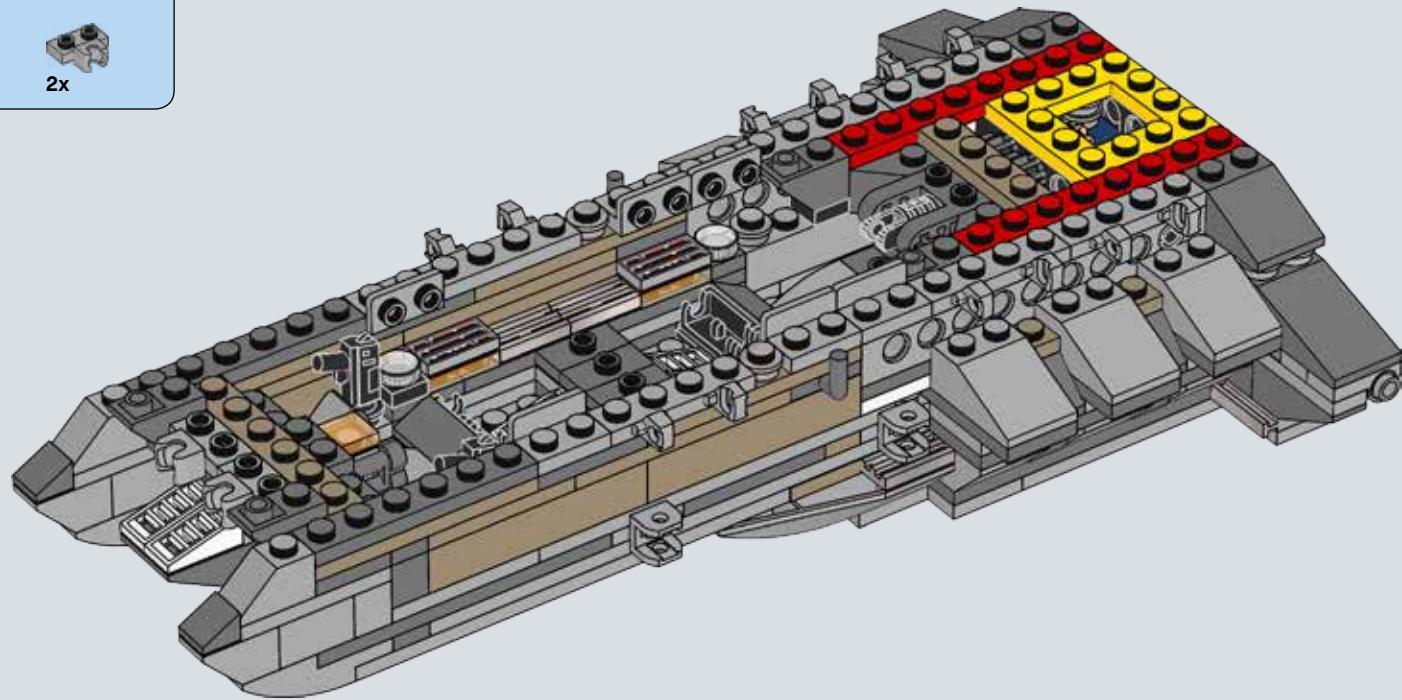

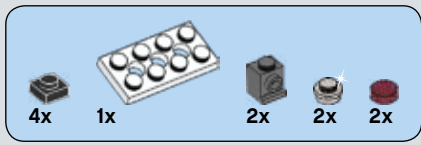

70

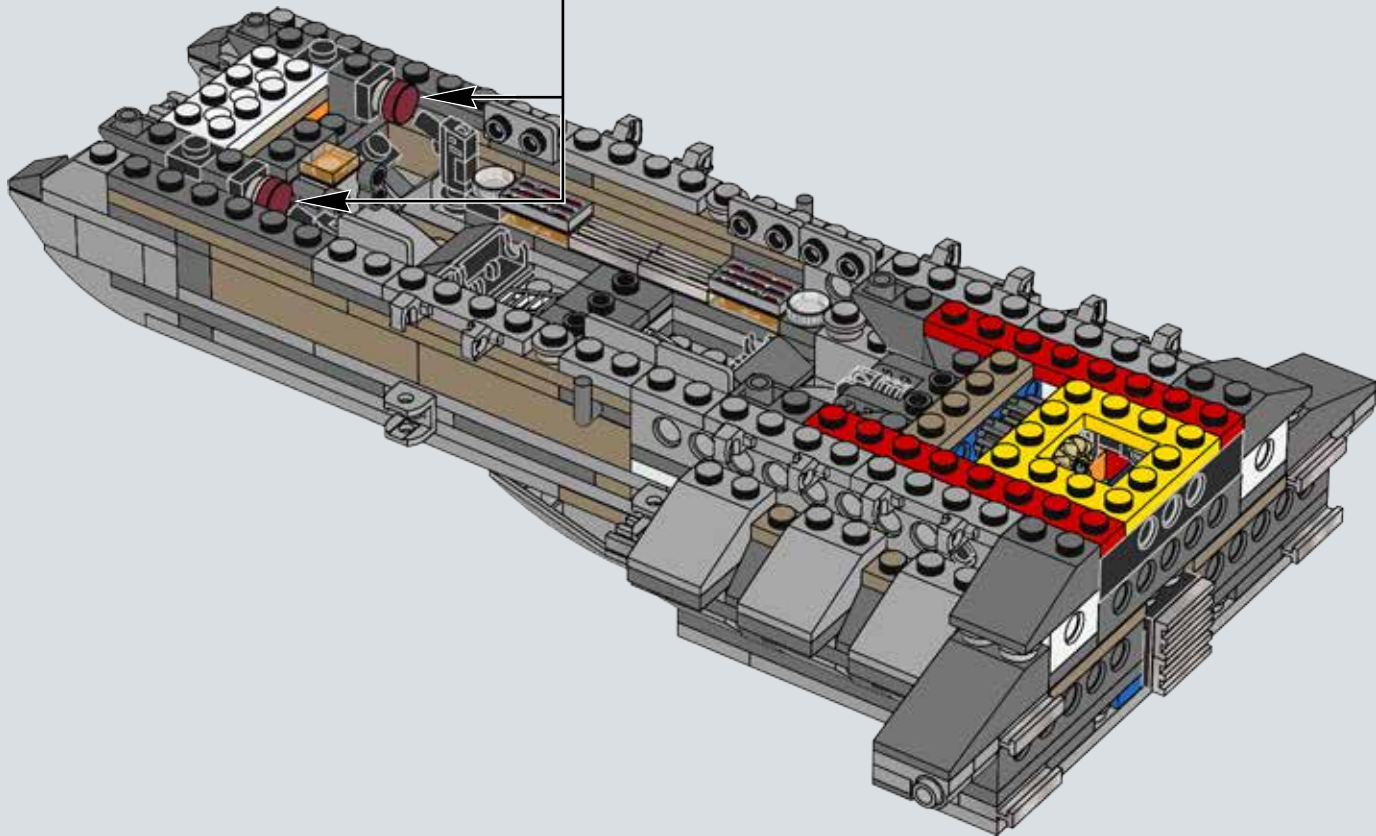
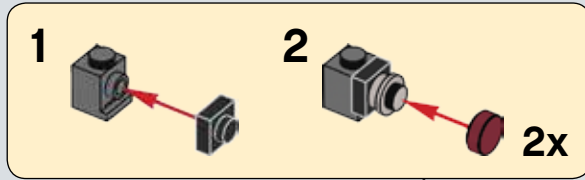



71

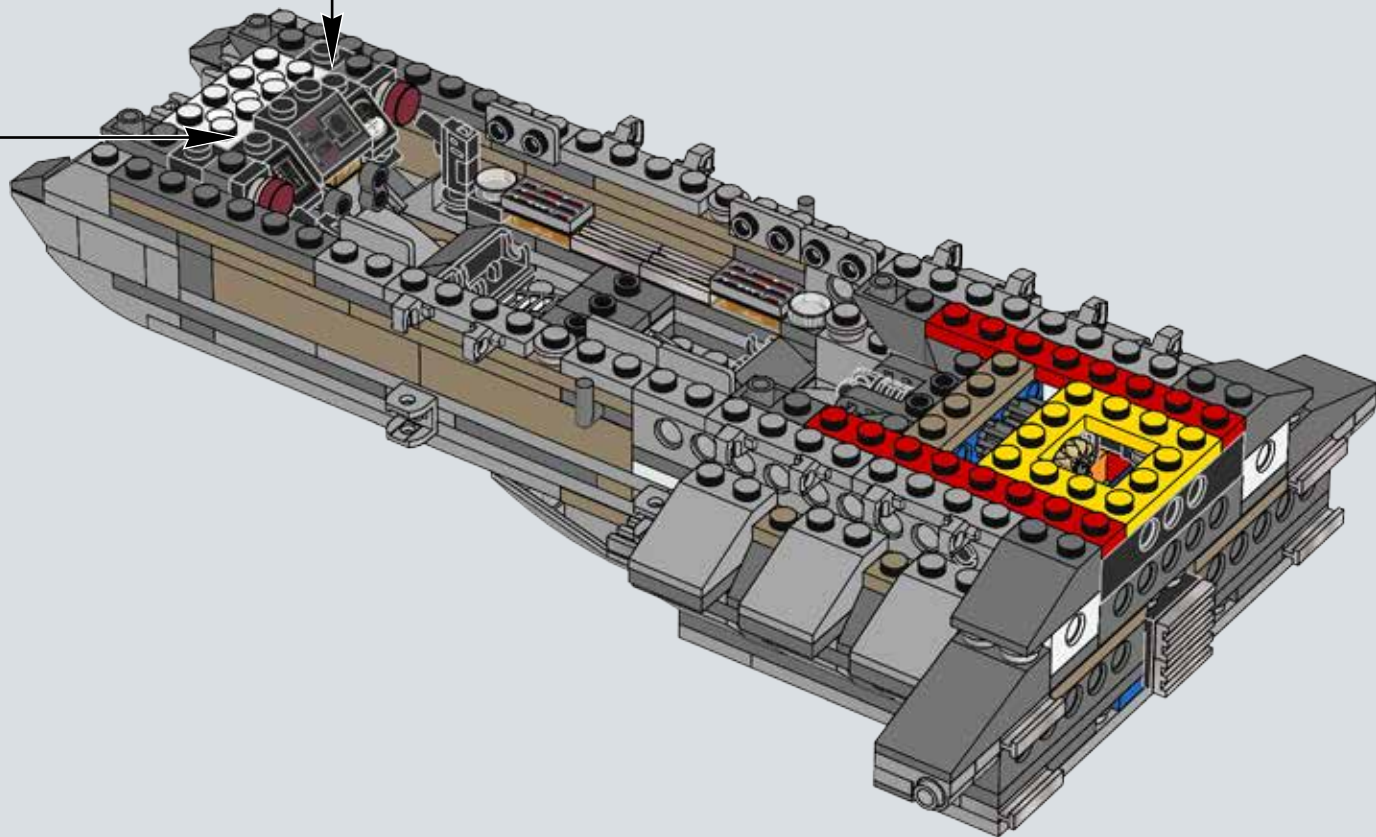
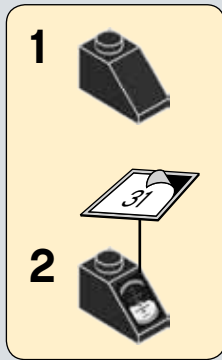
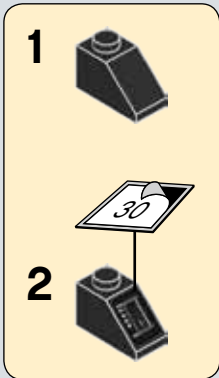



3x

72

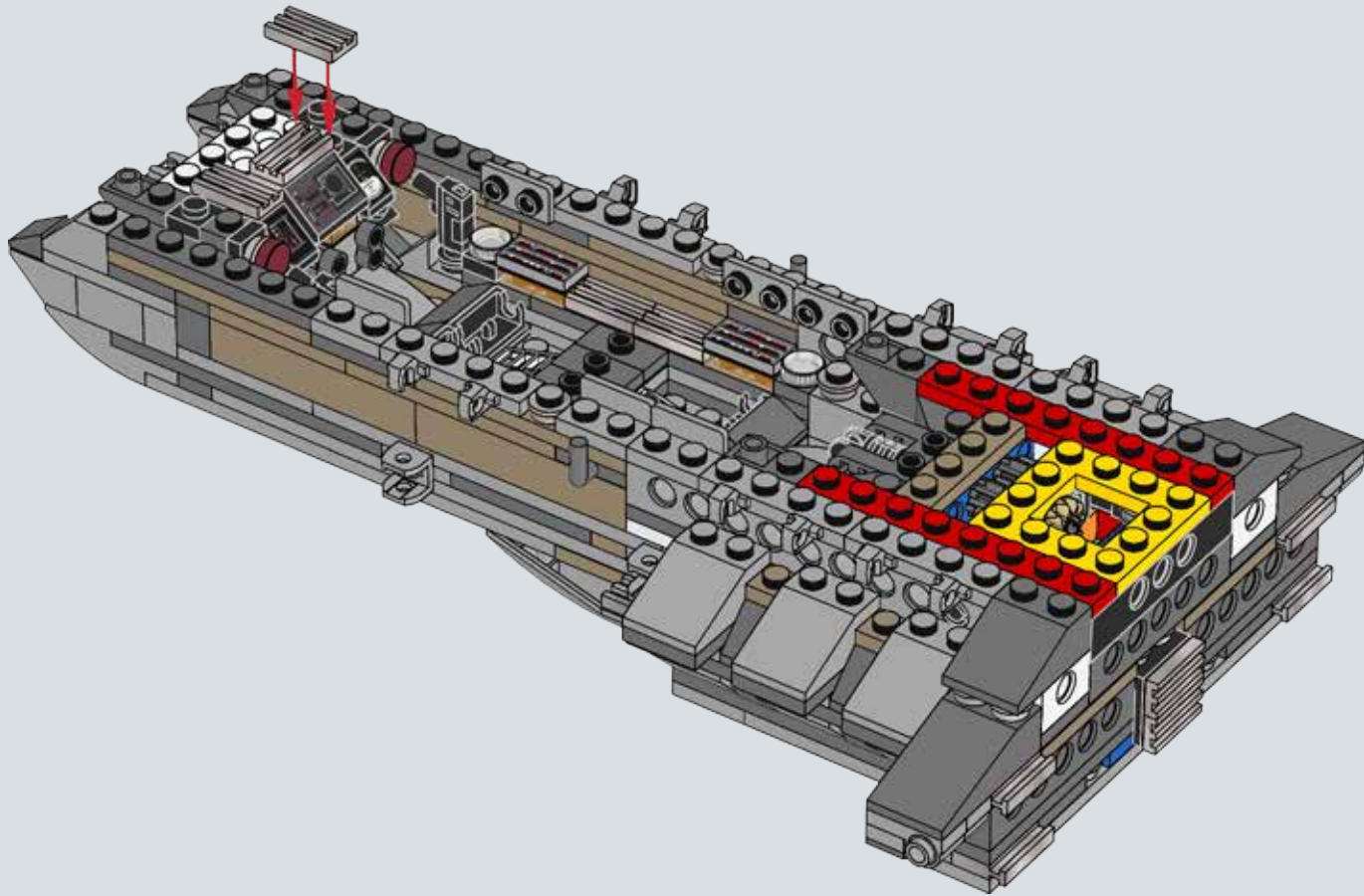



73

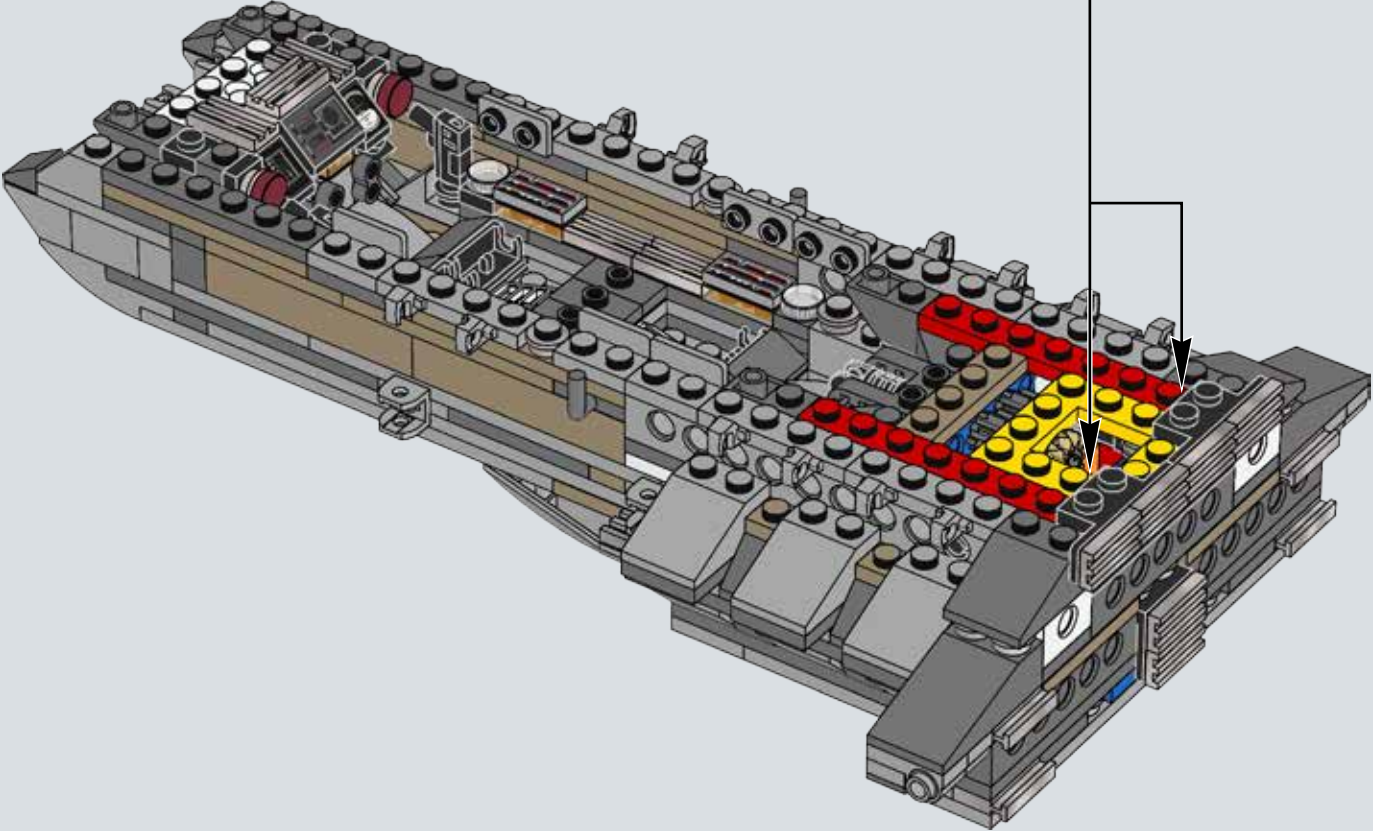
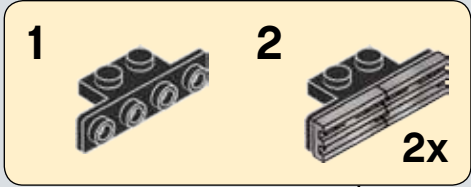

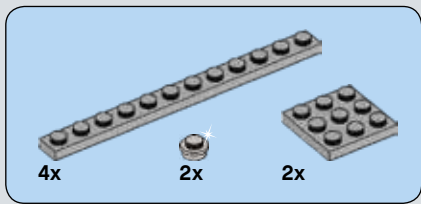

74

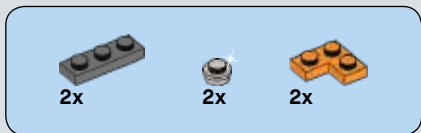
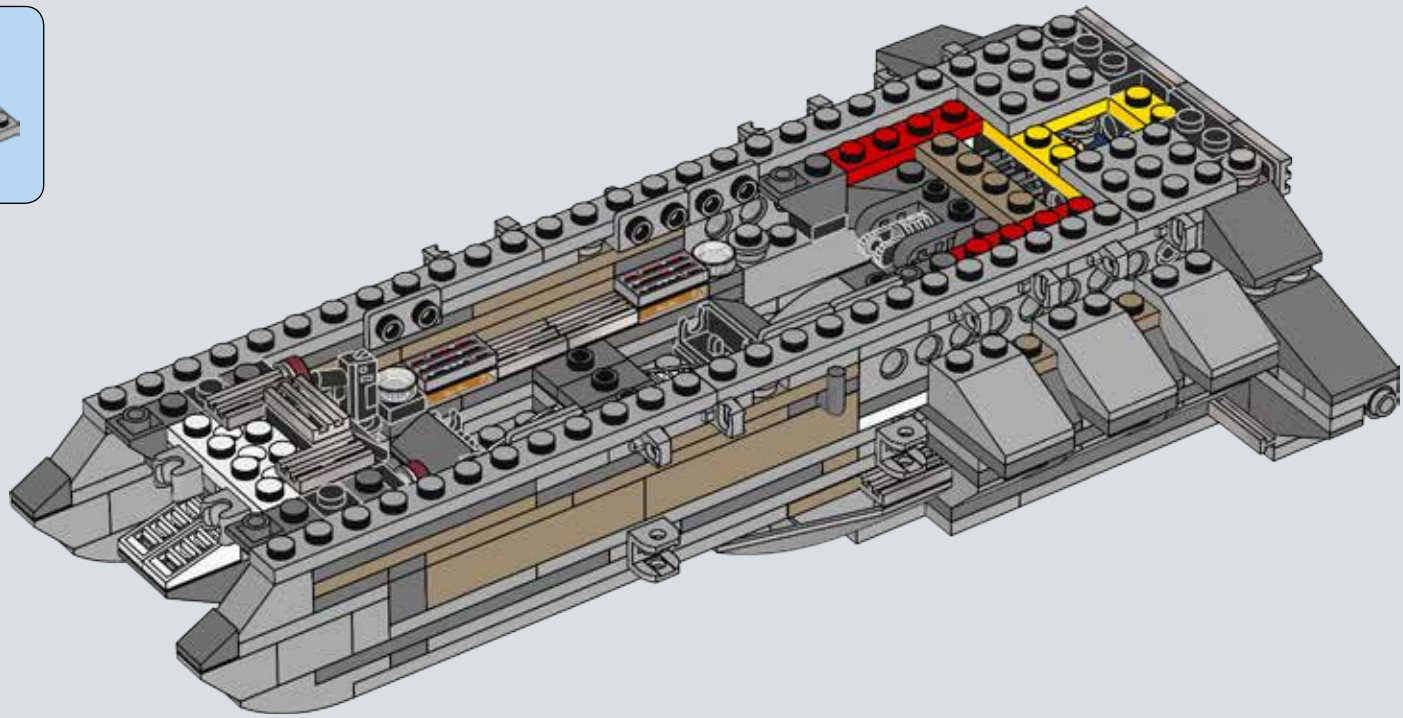

75

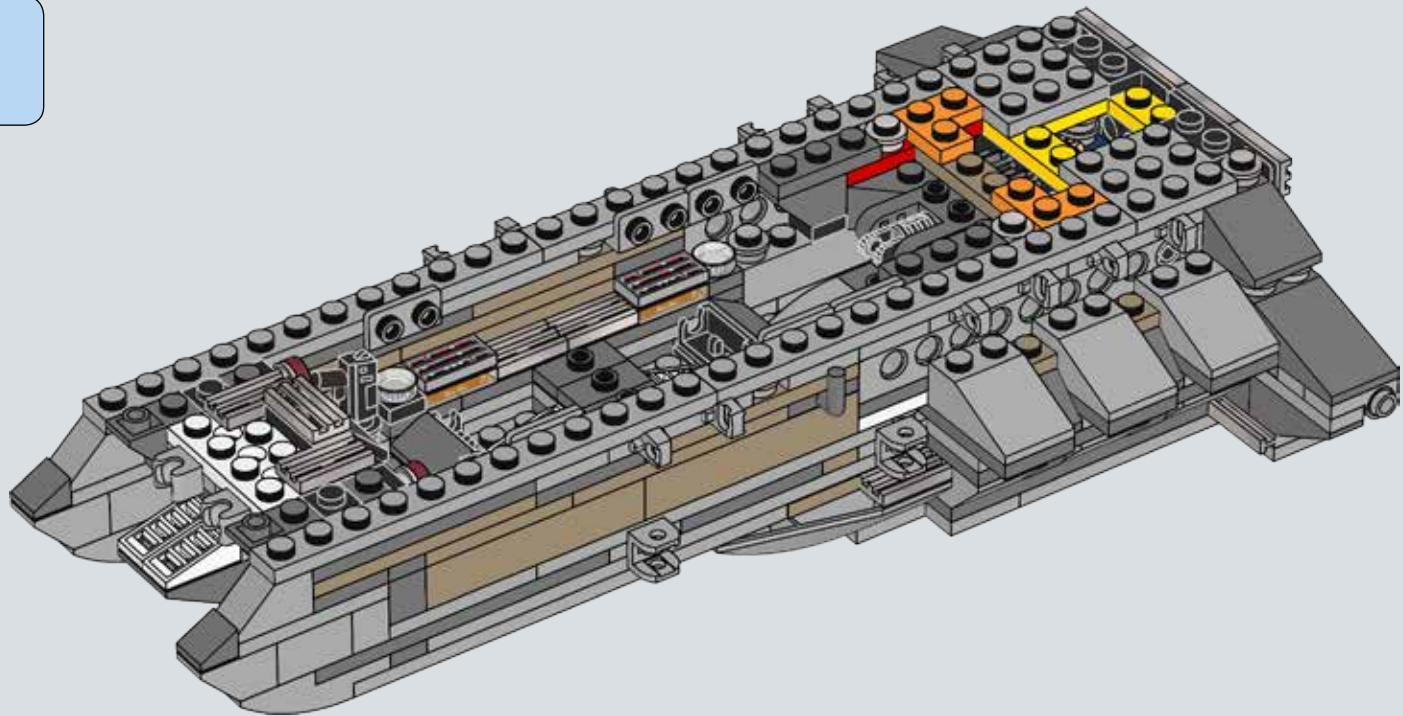



76

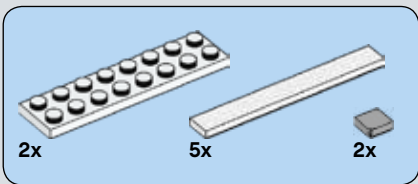
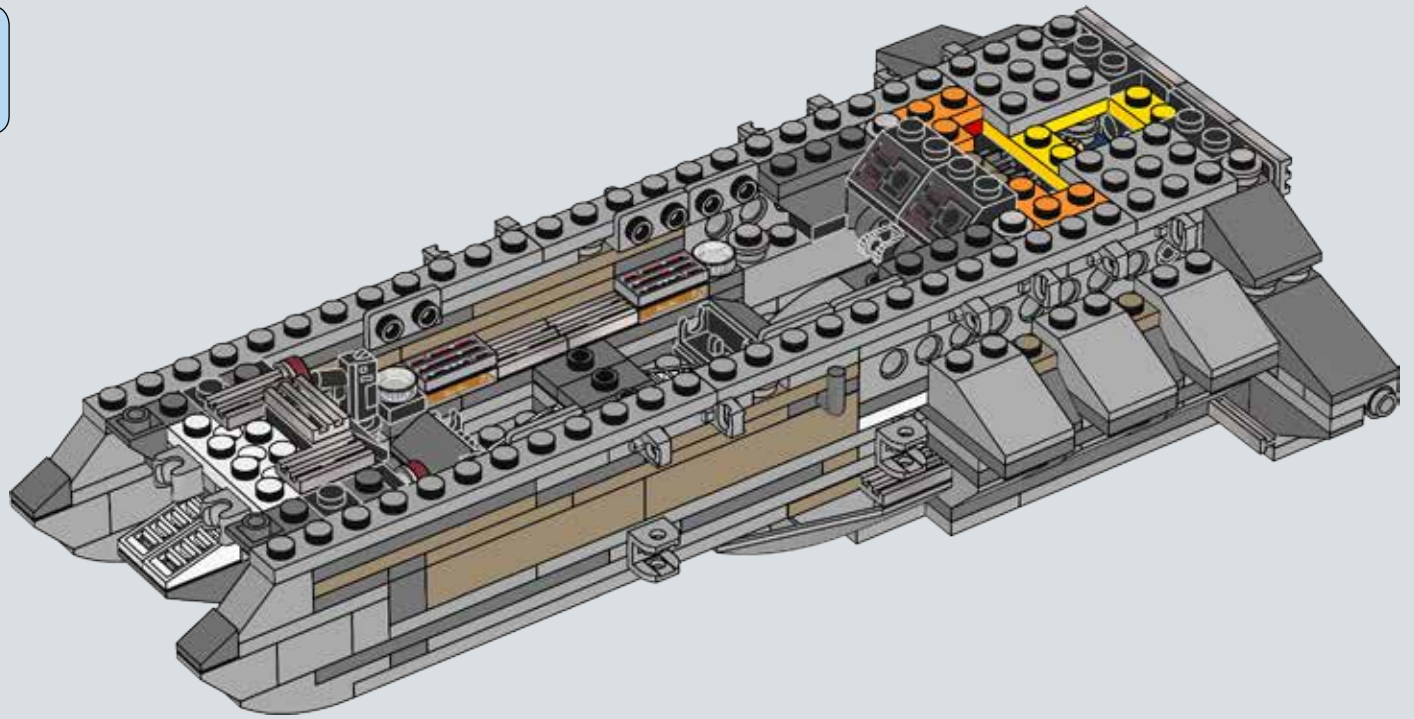

77

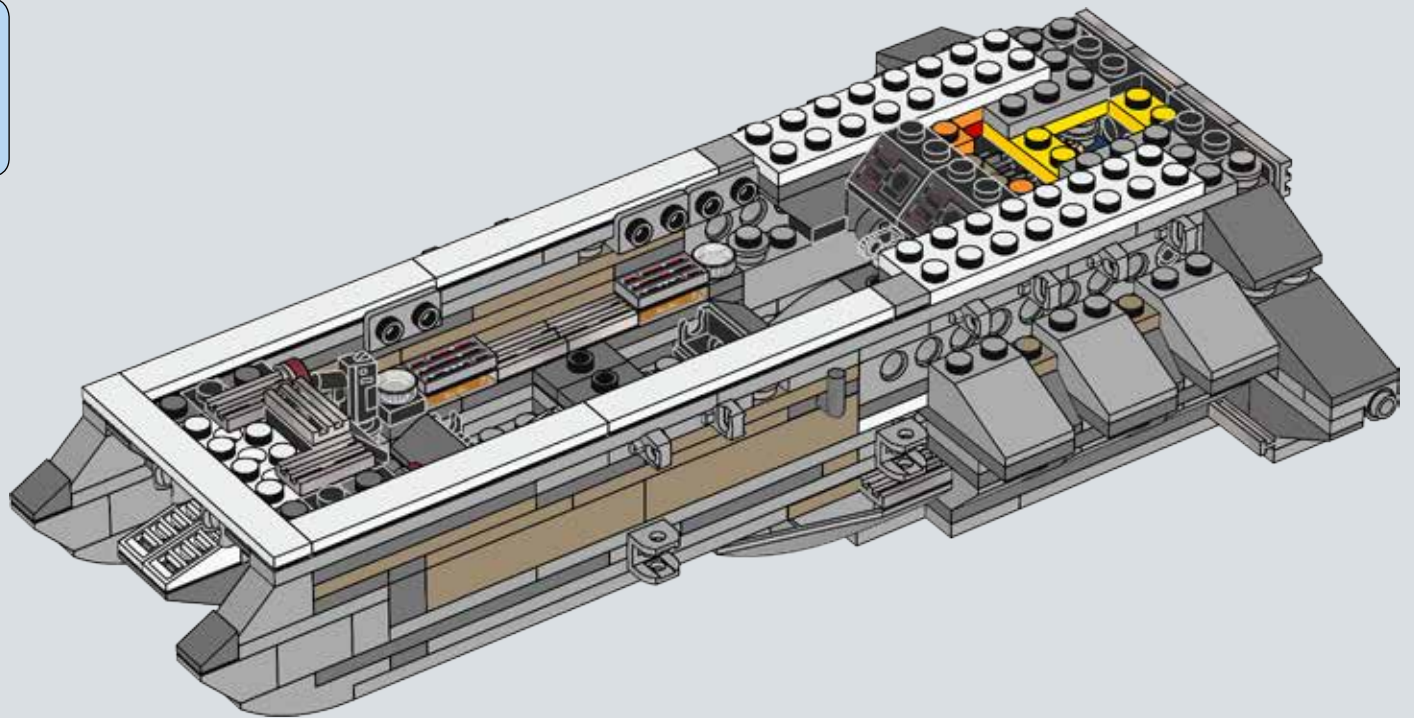

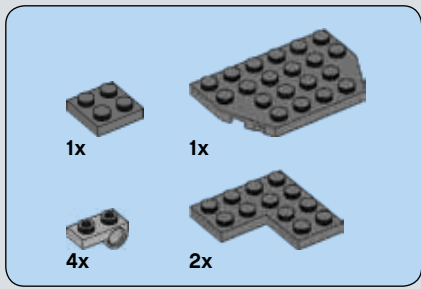

78

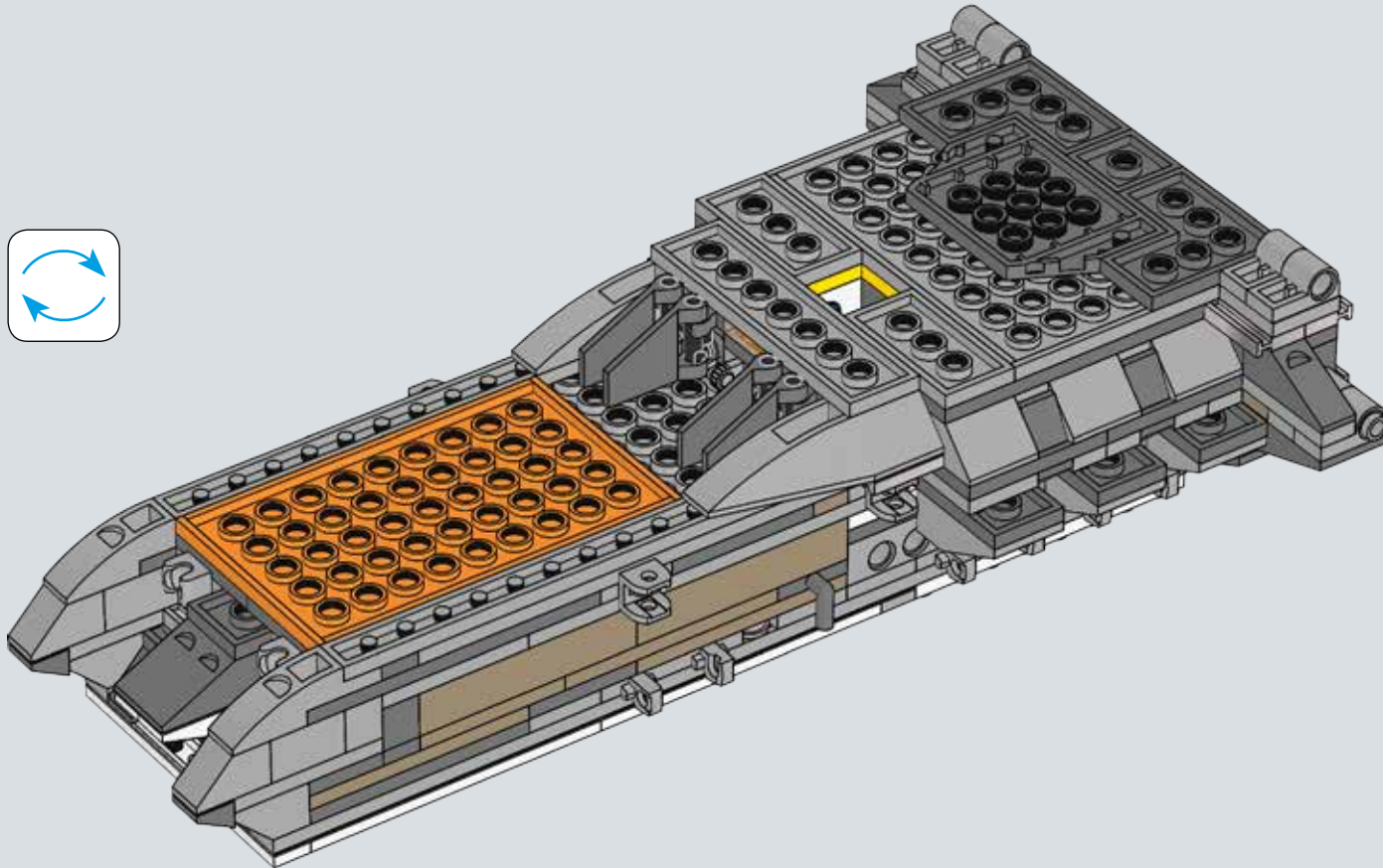

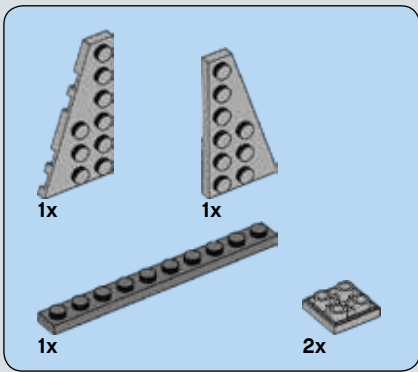

79

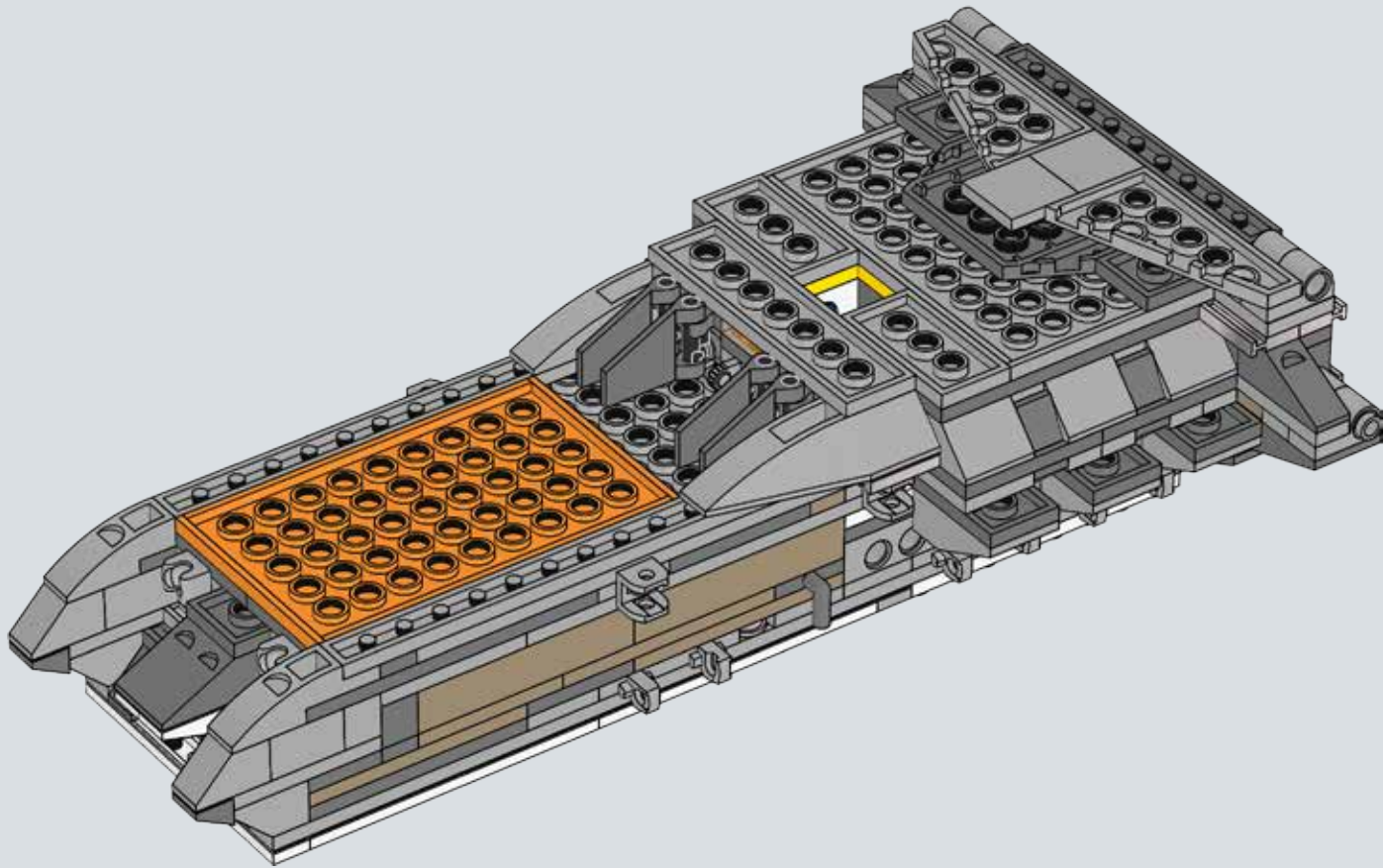



8x

80

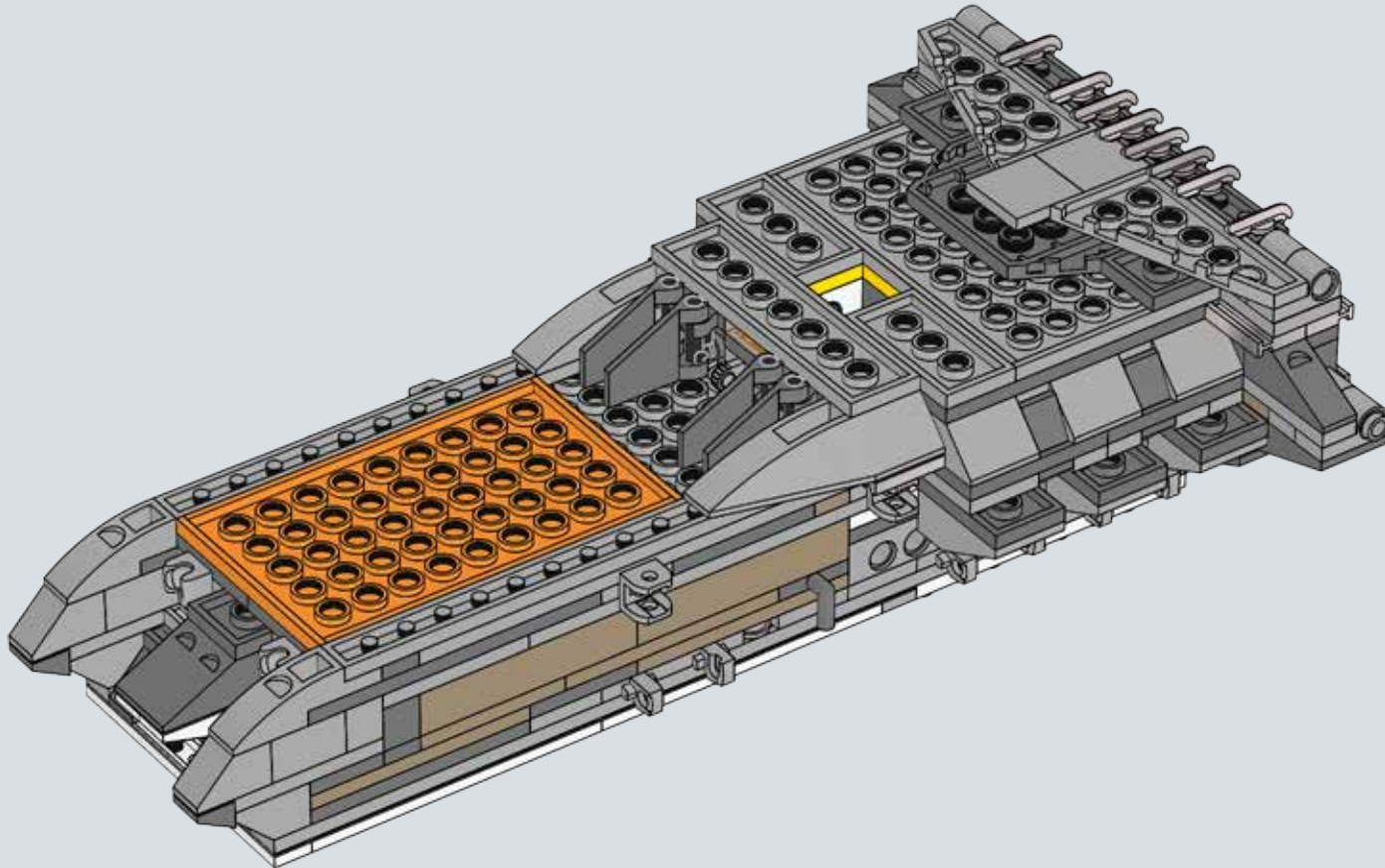



81

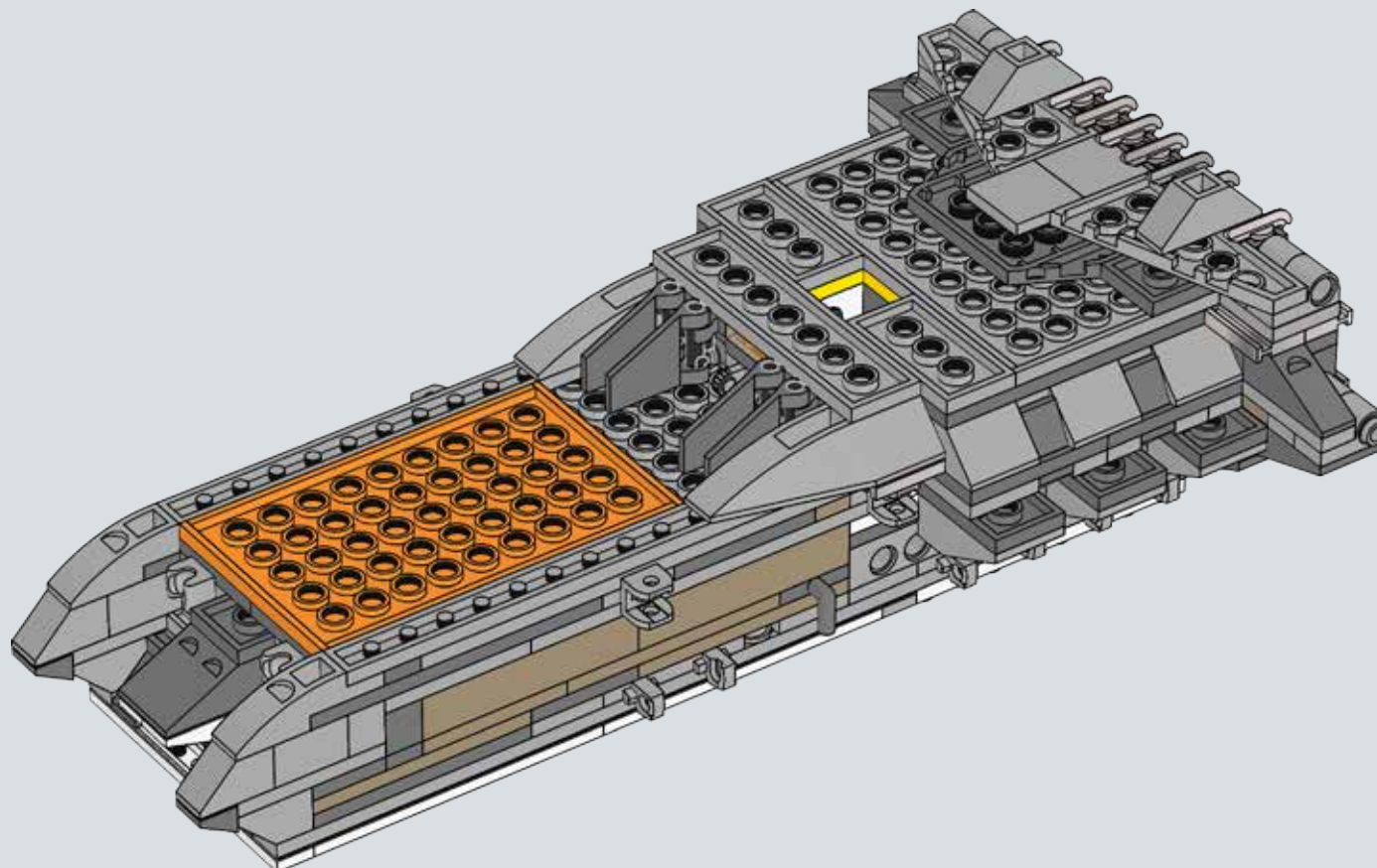

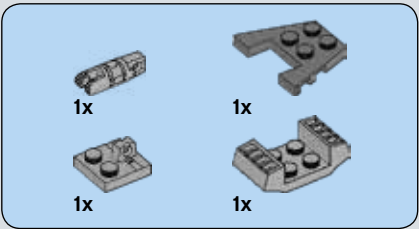

82

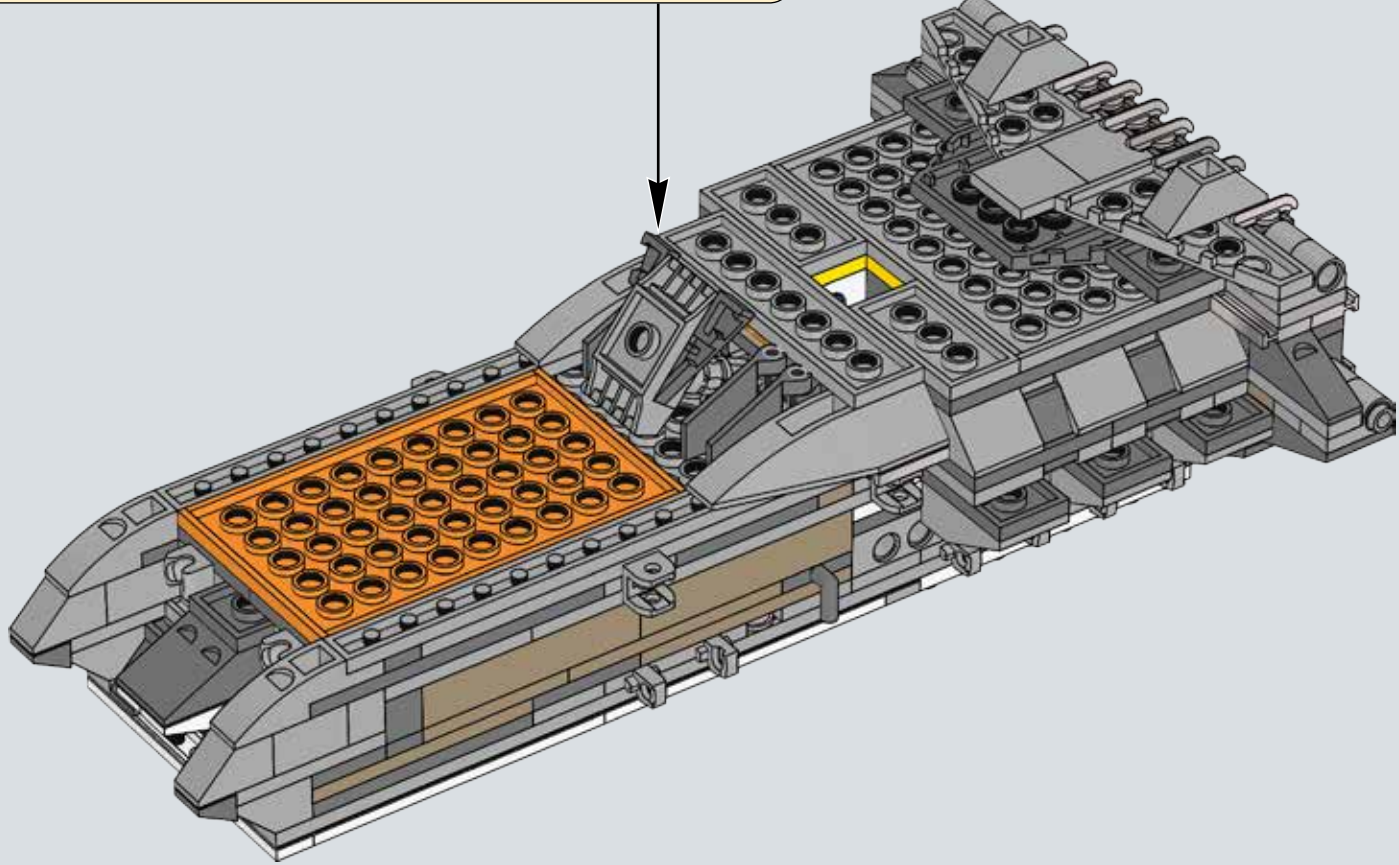
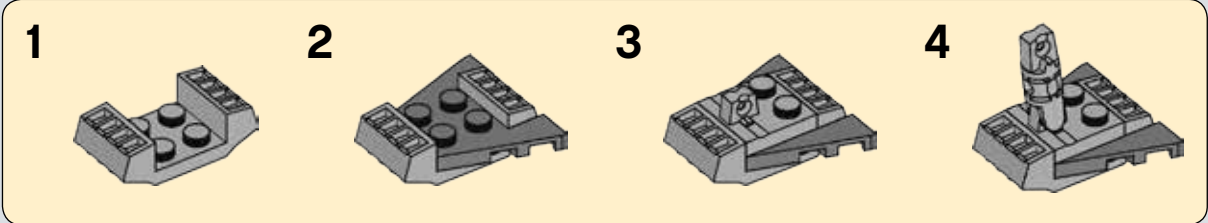

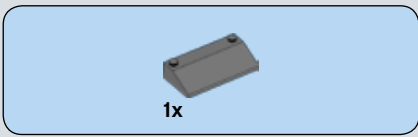

83

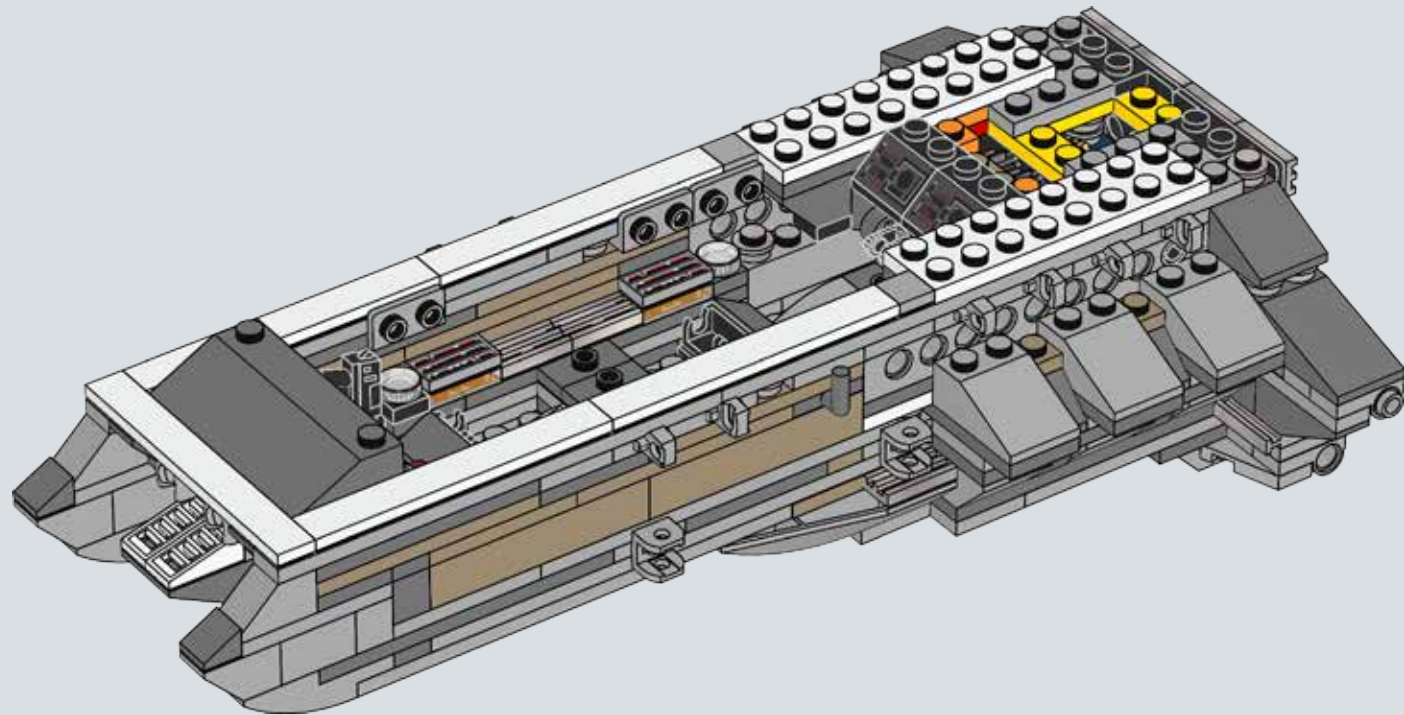
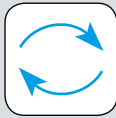

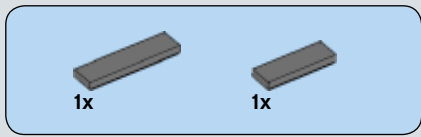

84

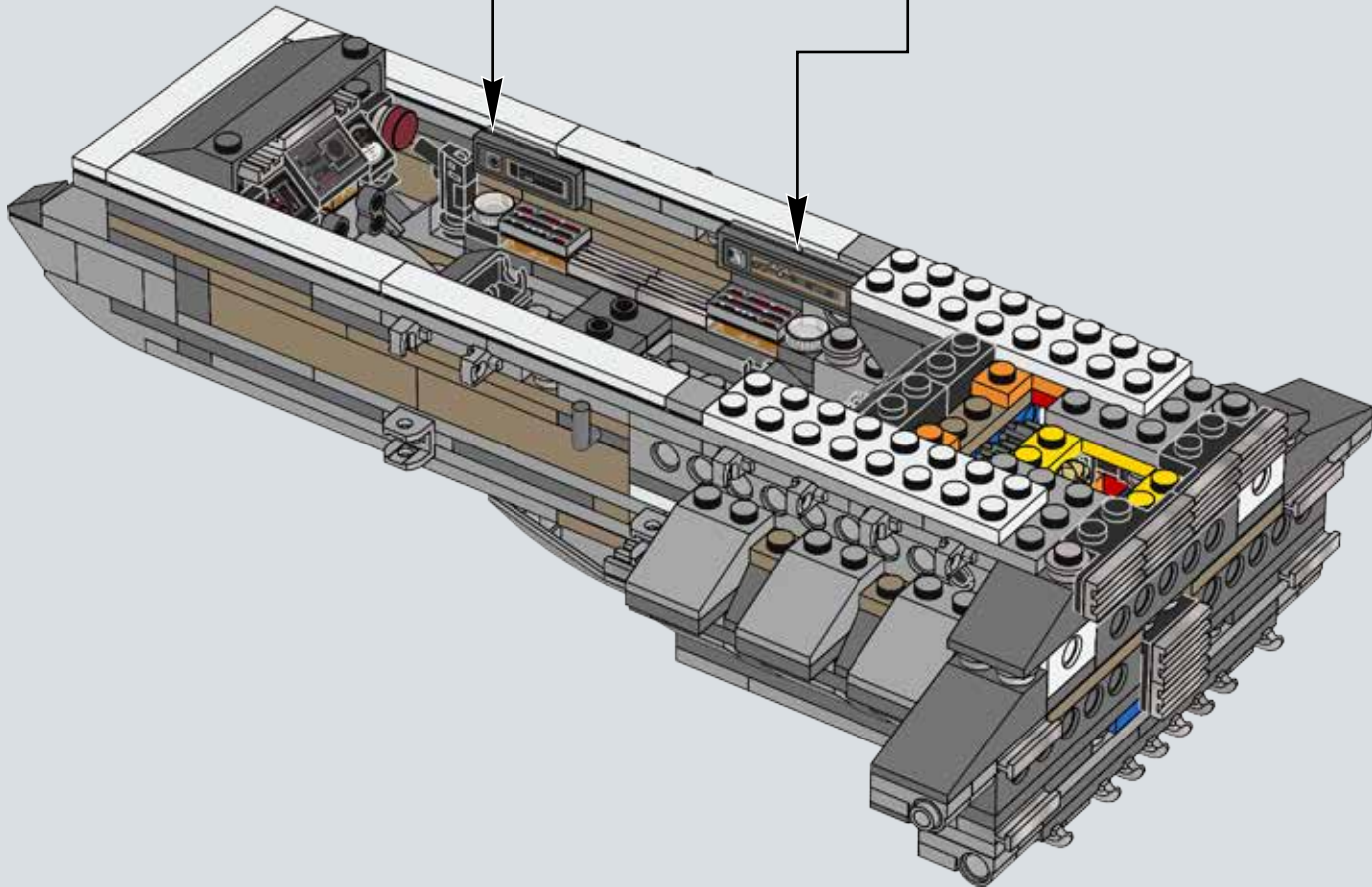
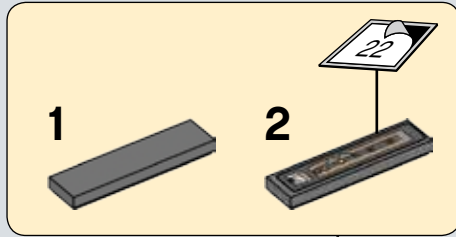
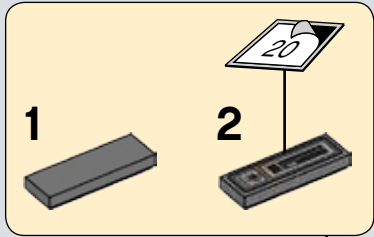

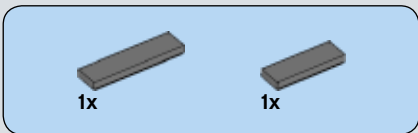

85

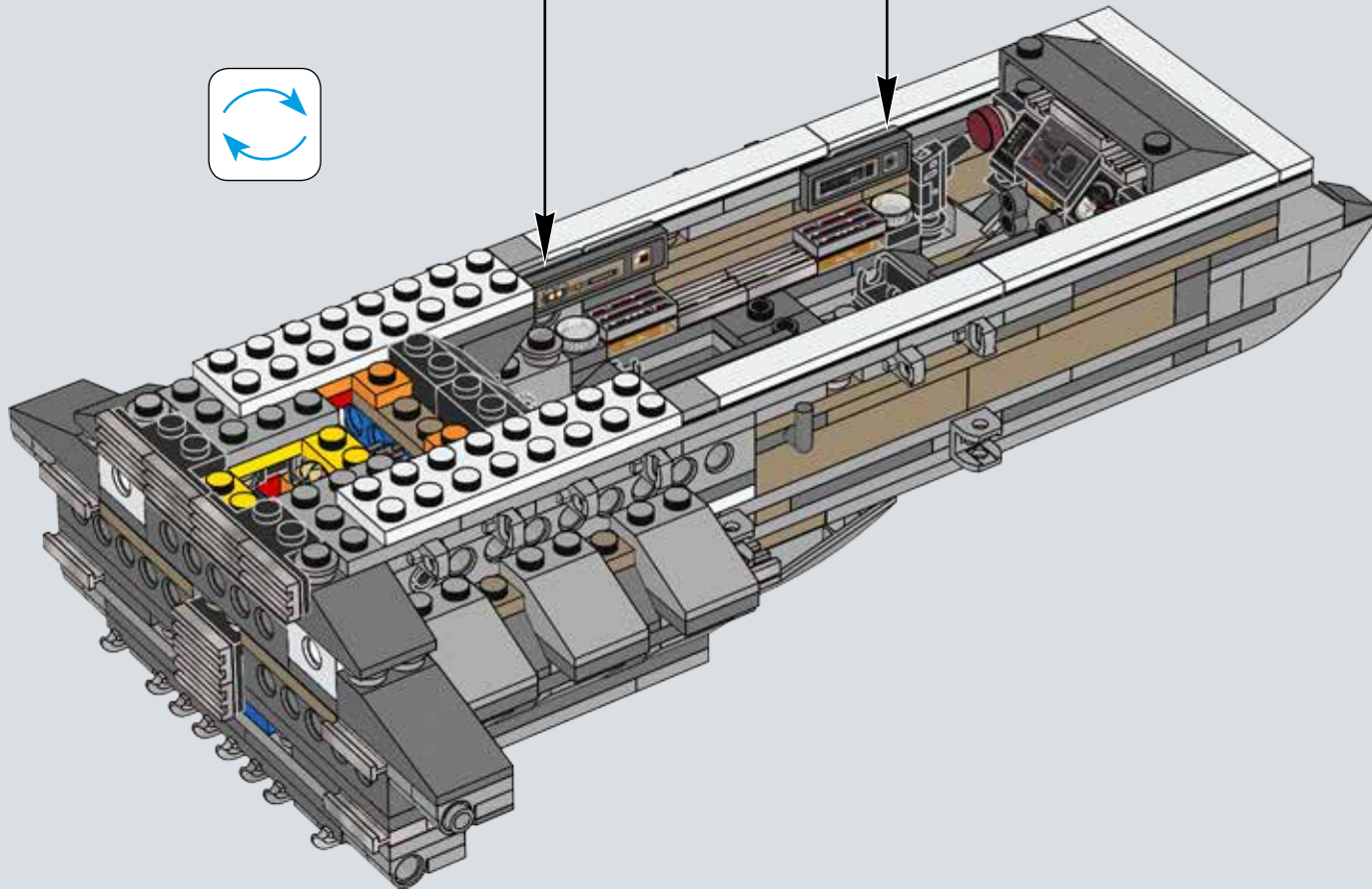
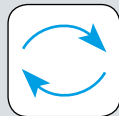
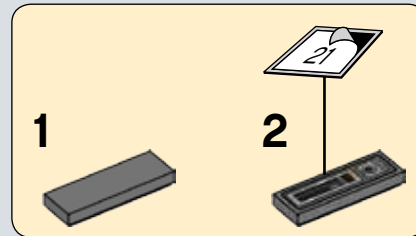
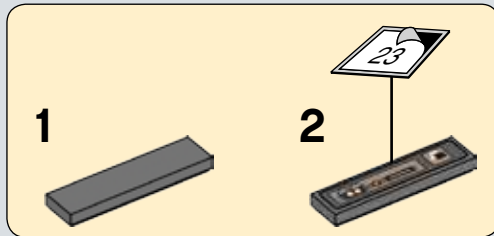

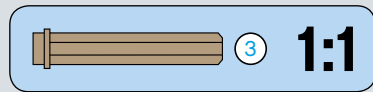

86

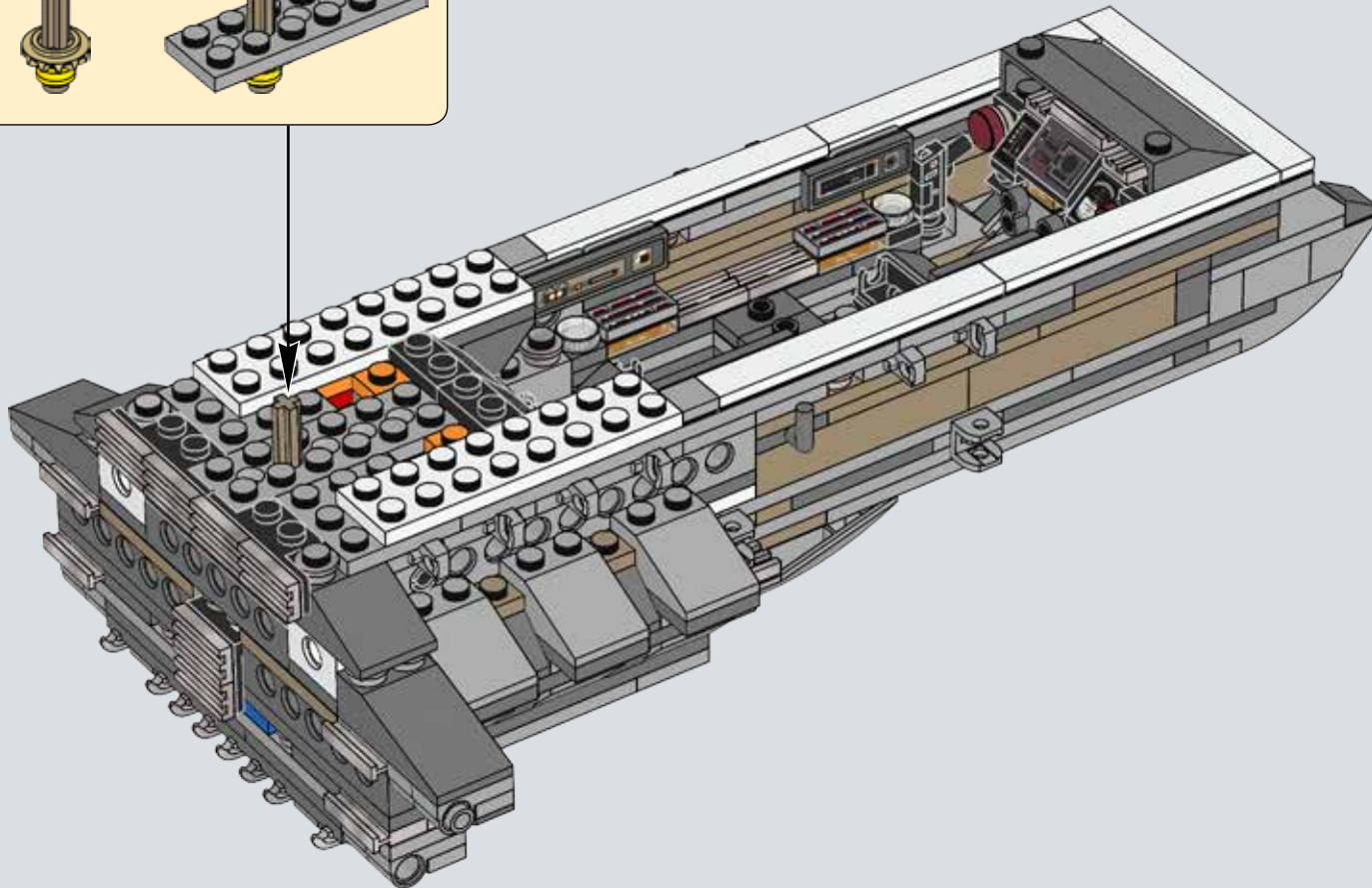
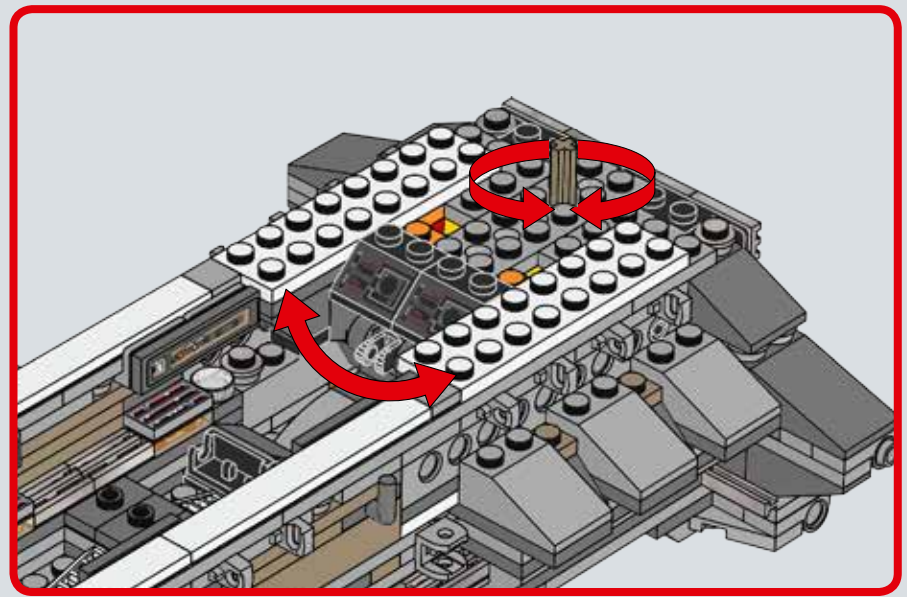

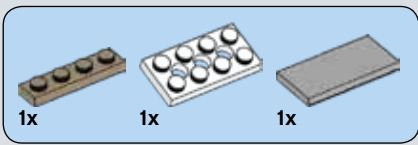

87

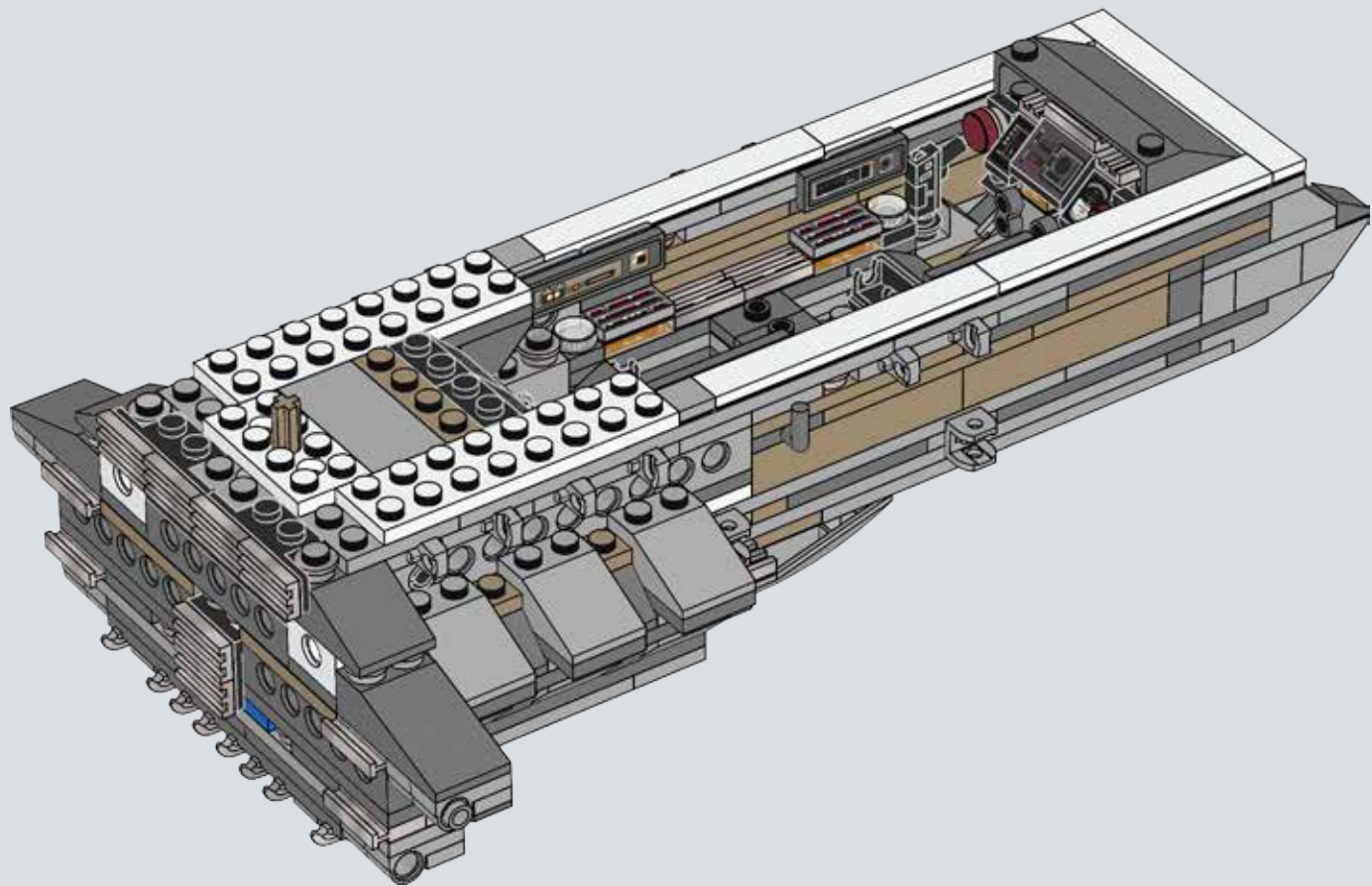

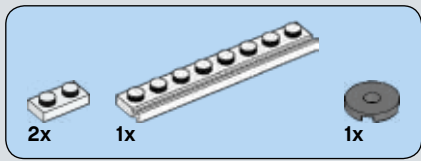

88

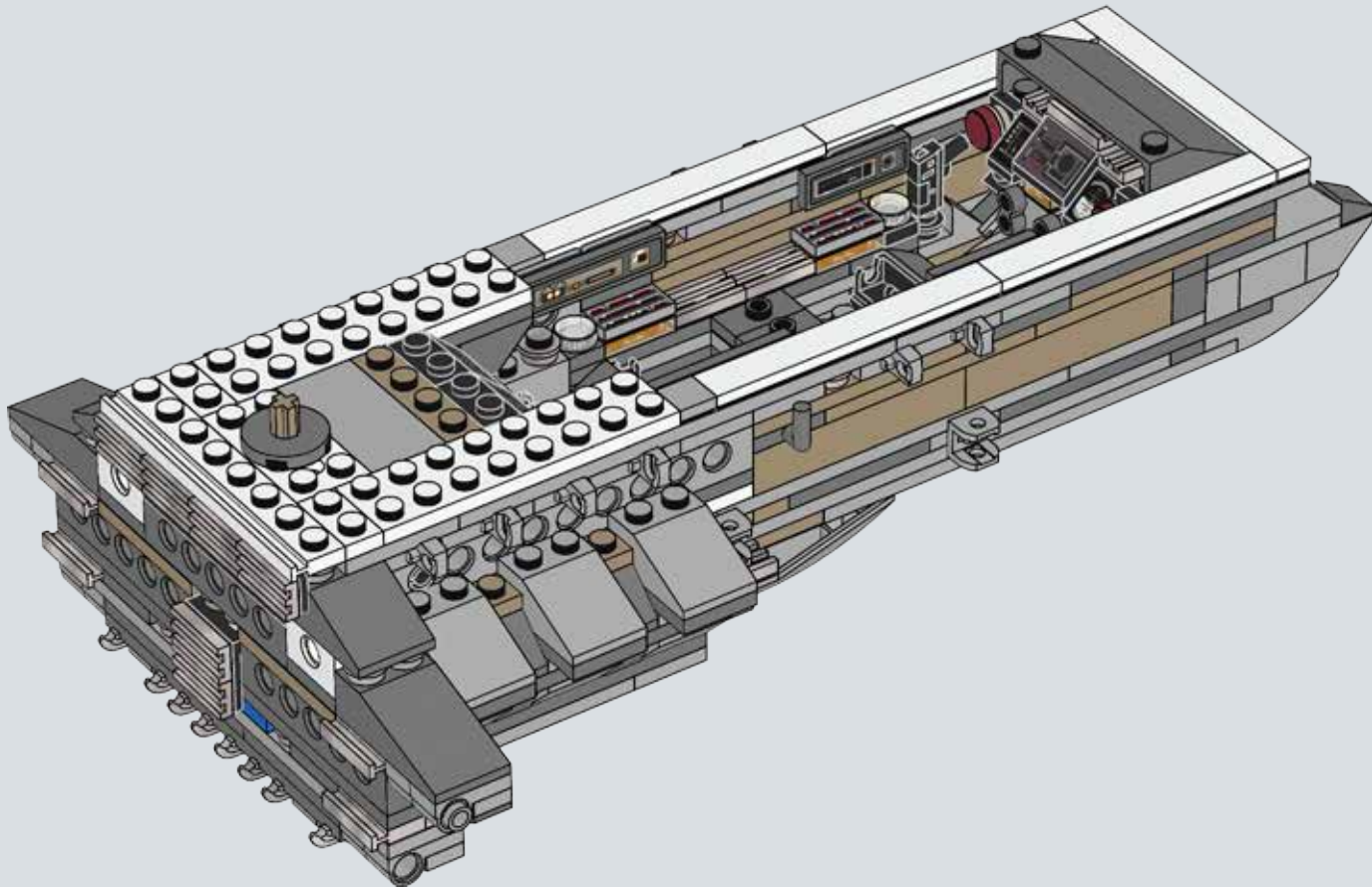



89

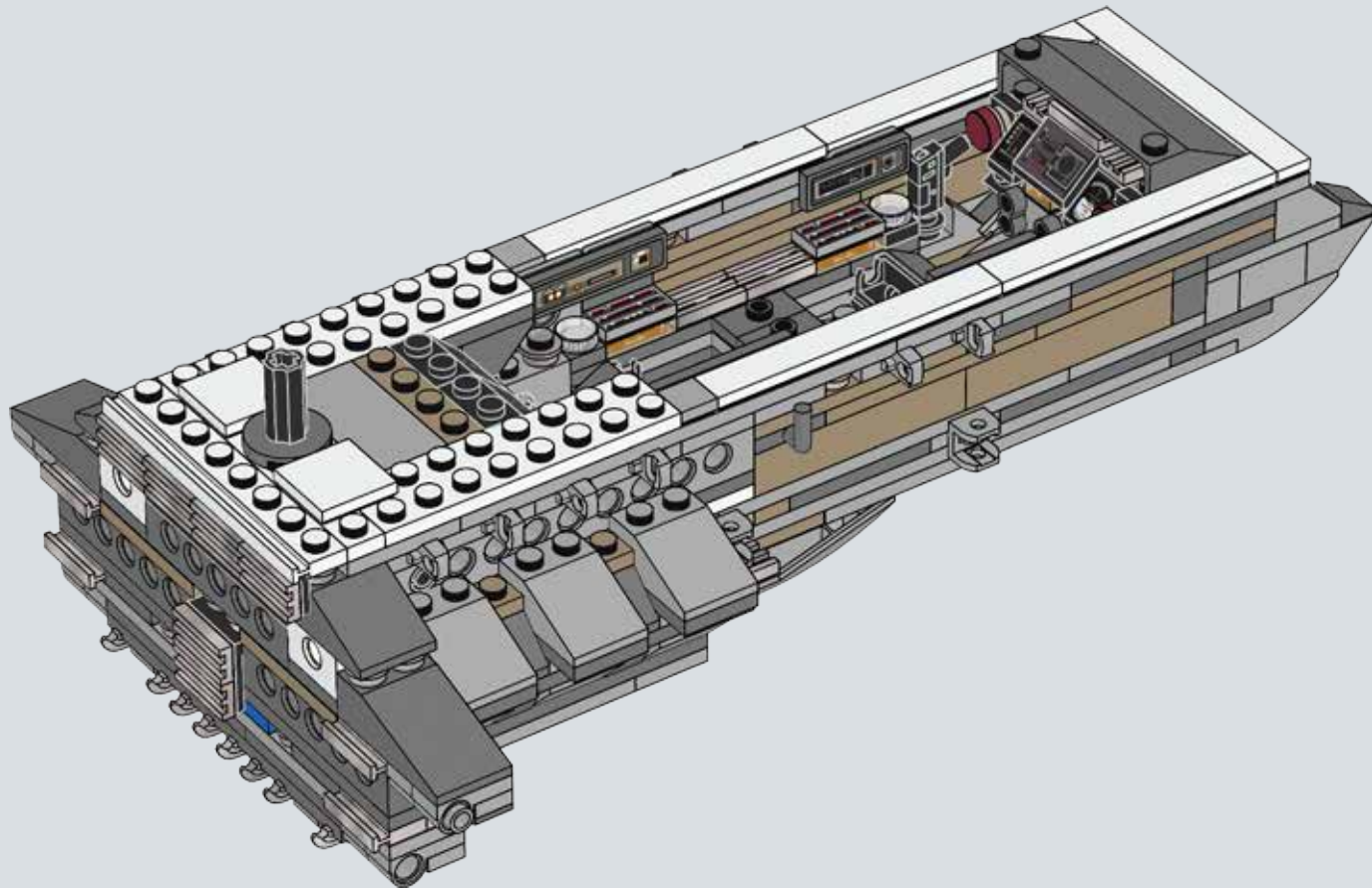

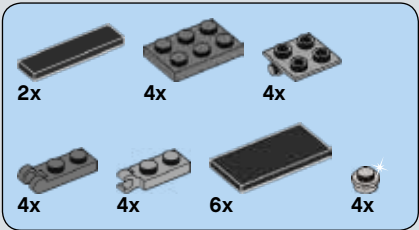
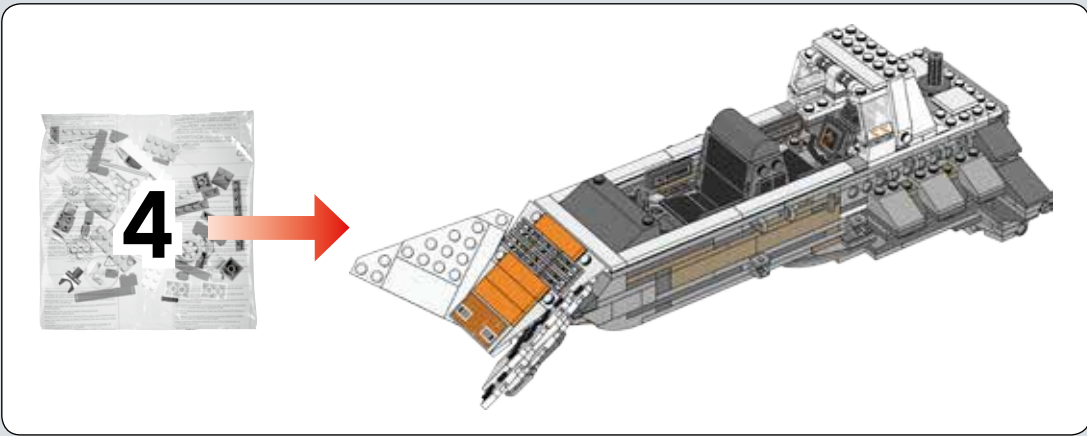

90

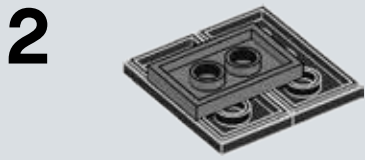
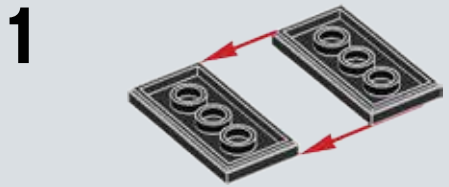

3

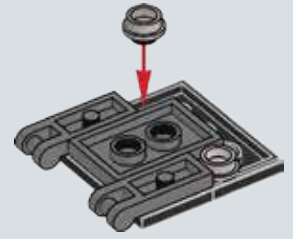

4

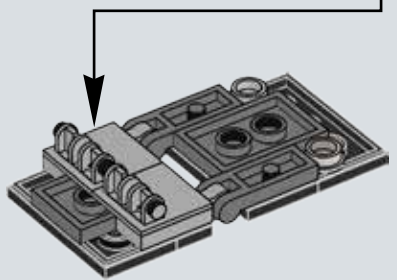
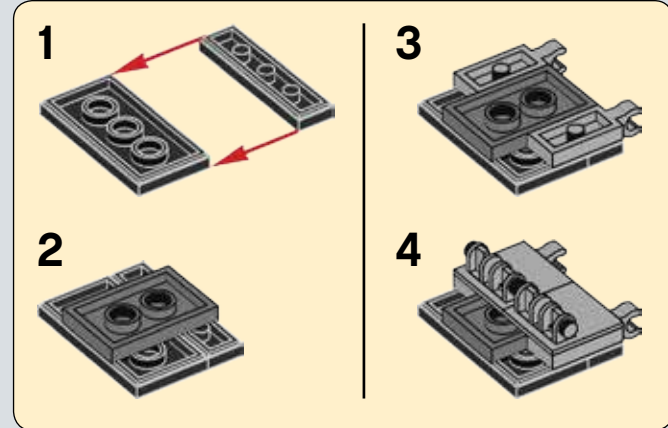

5

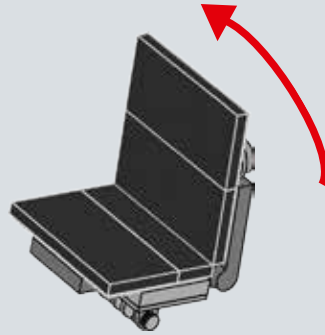
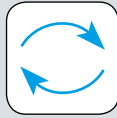

2x

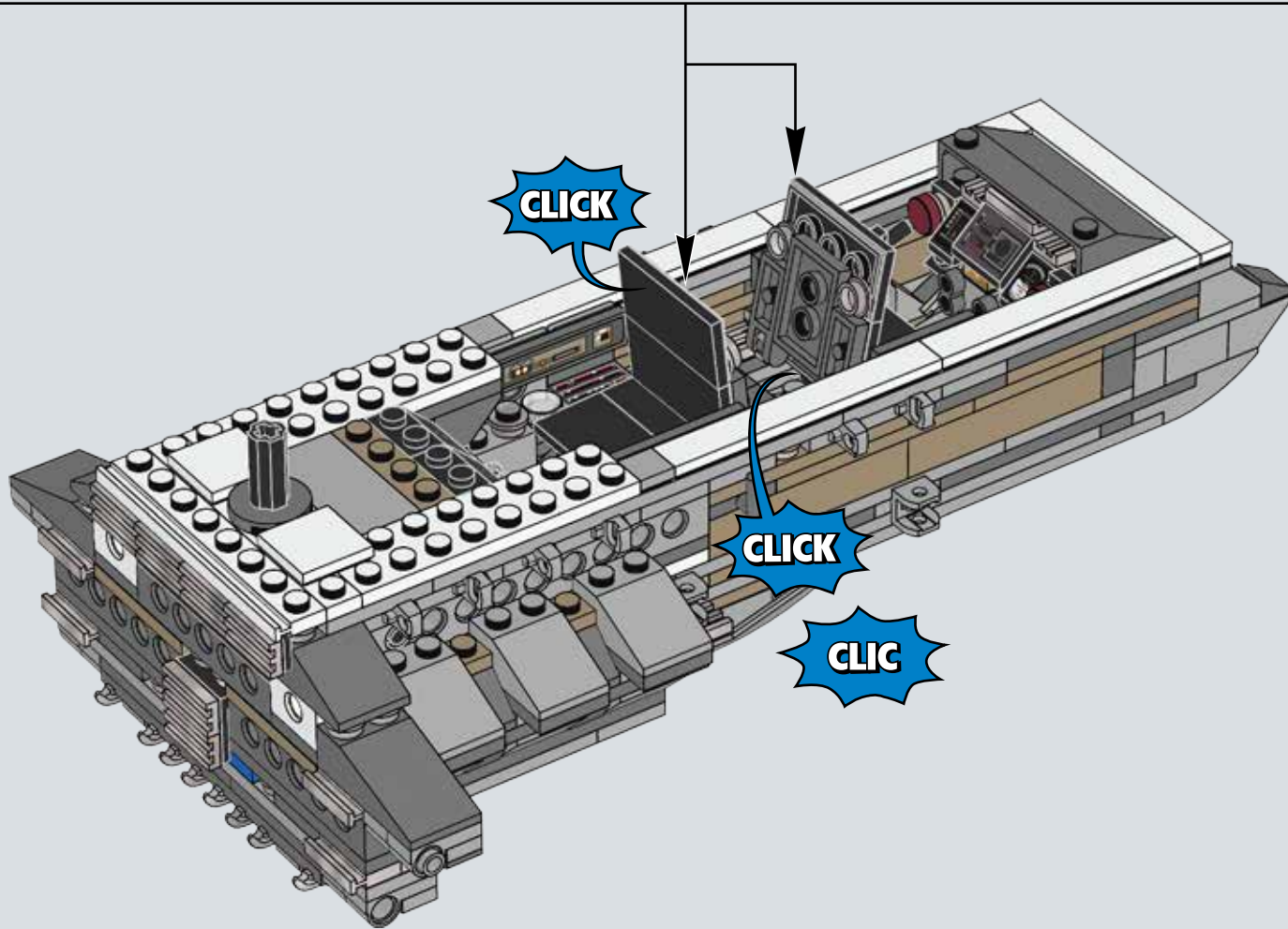

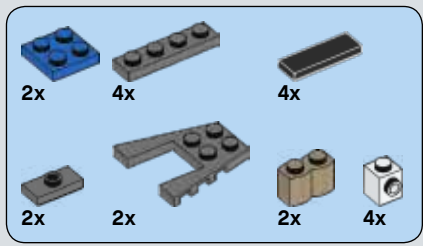

91

1

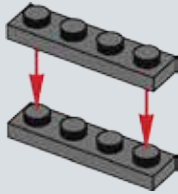

2

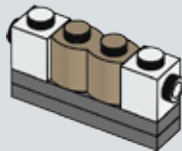

3

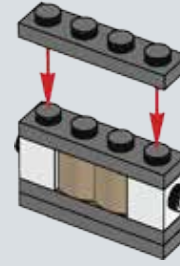

4

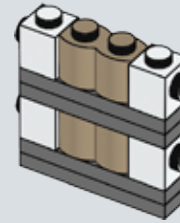

5

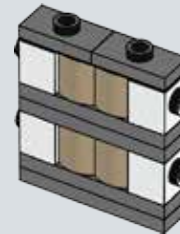

6

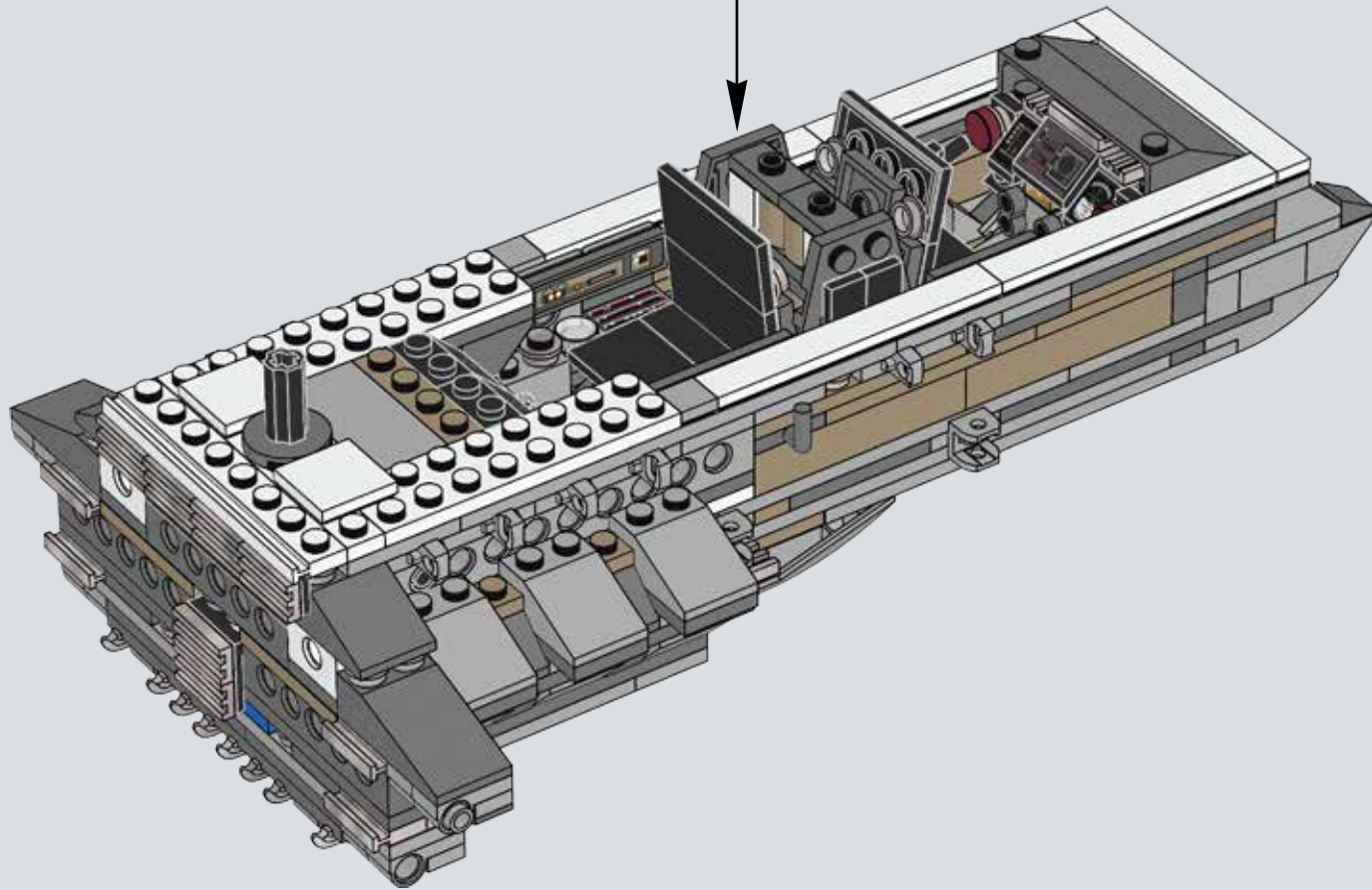
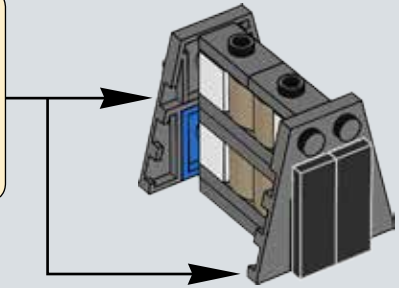
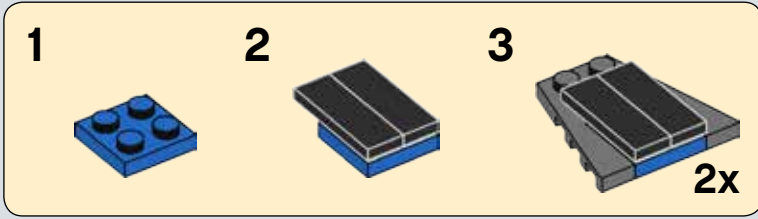

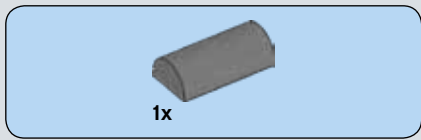

92

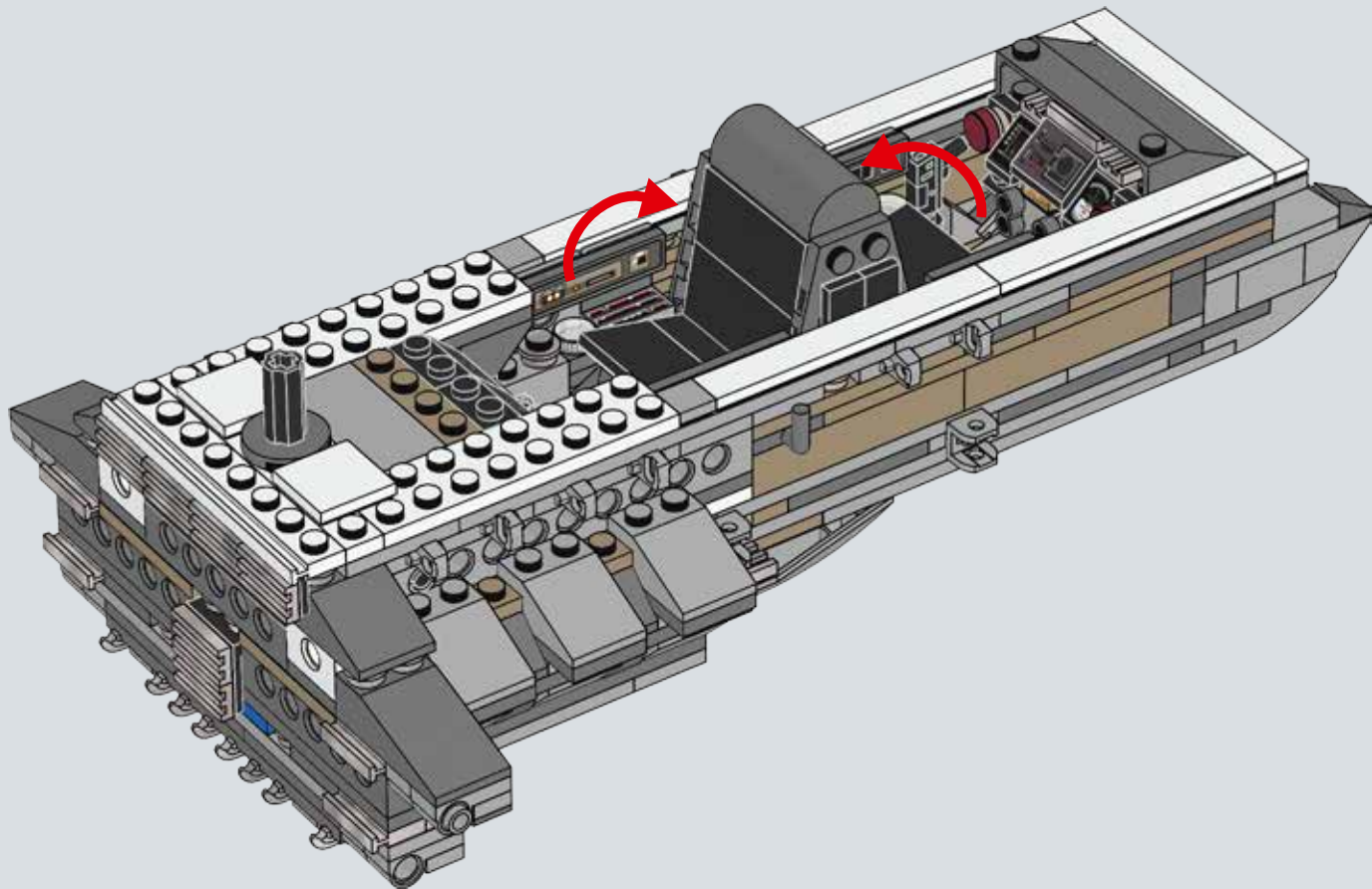

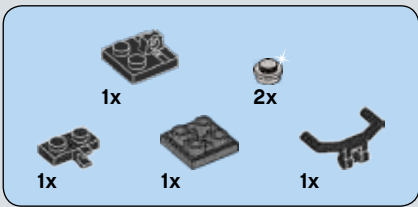

93

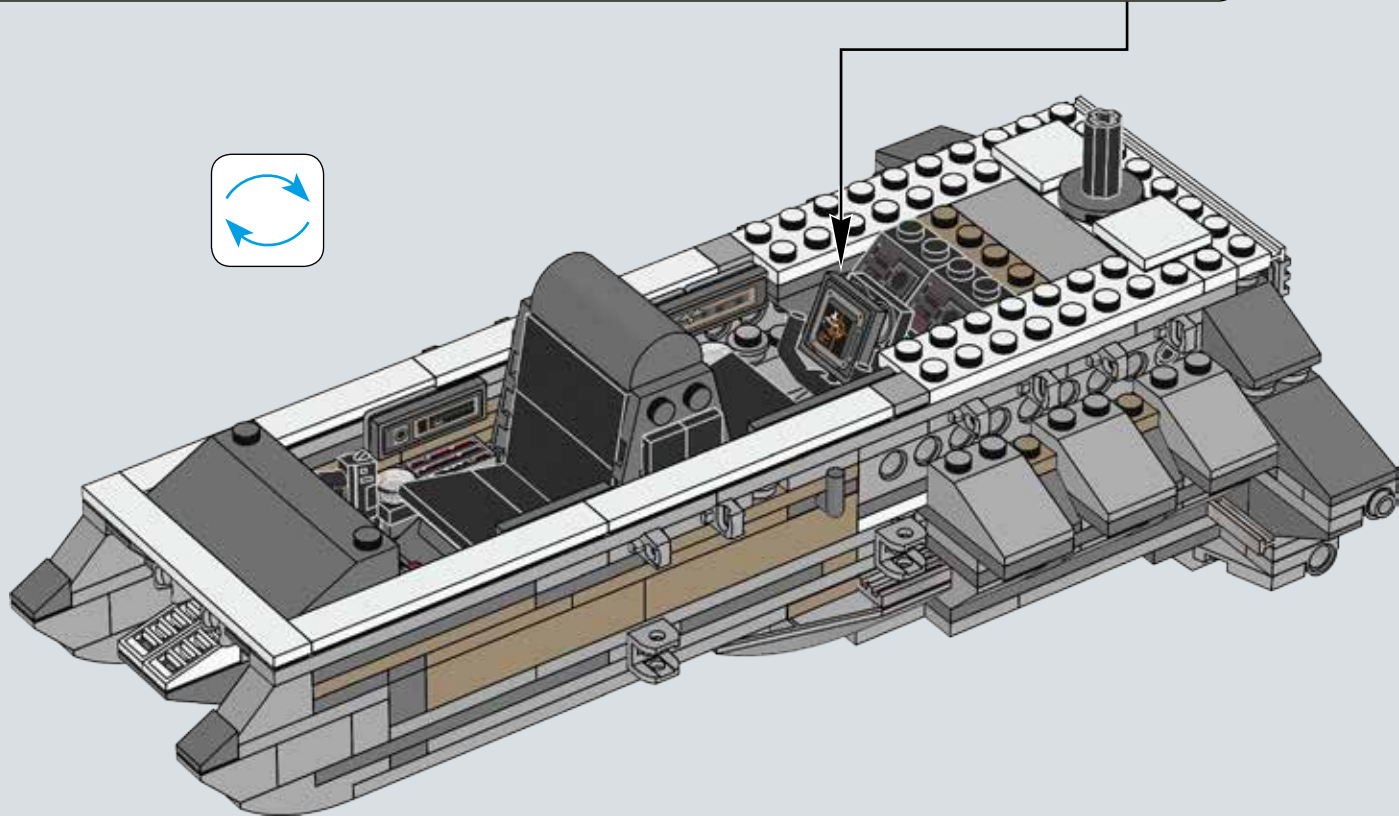
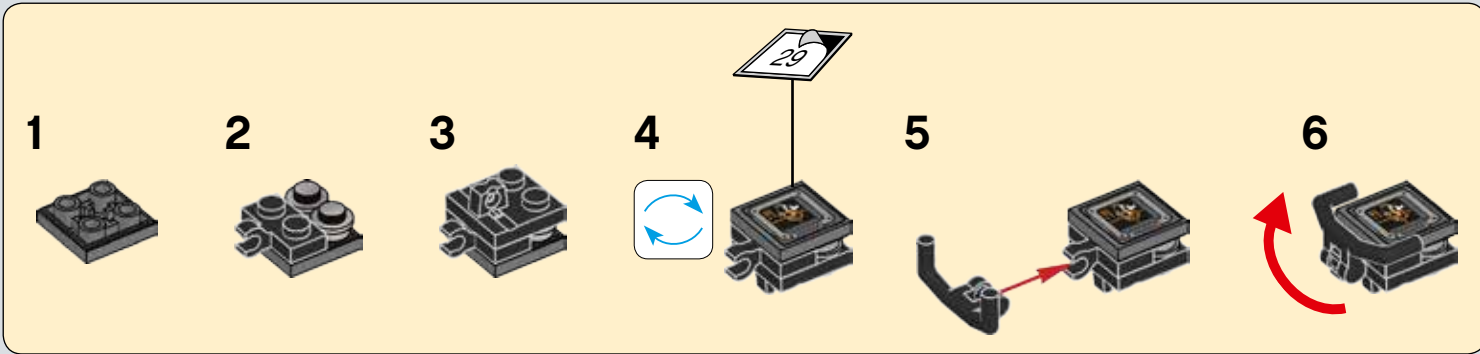

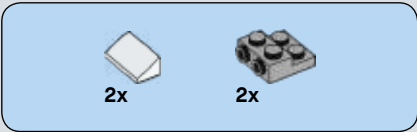

94

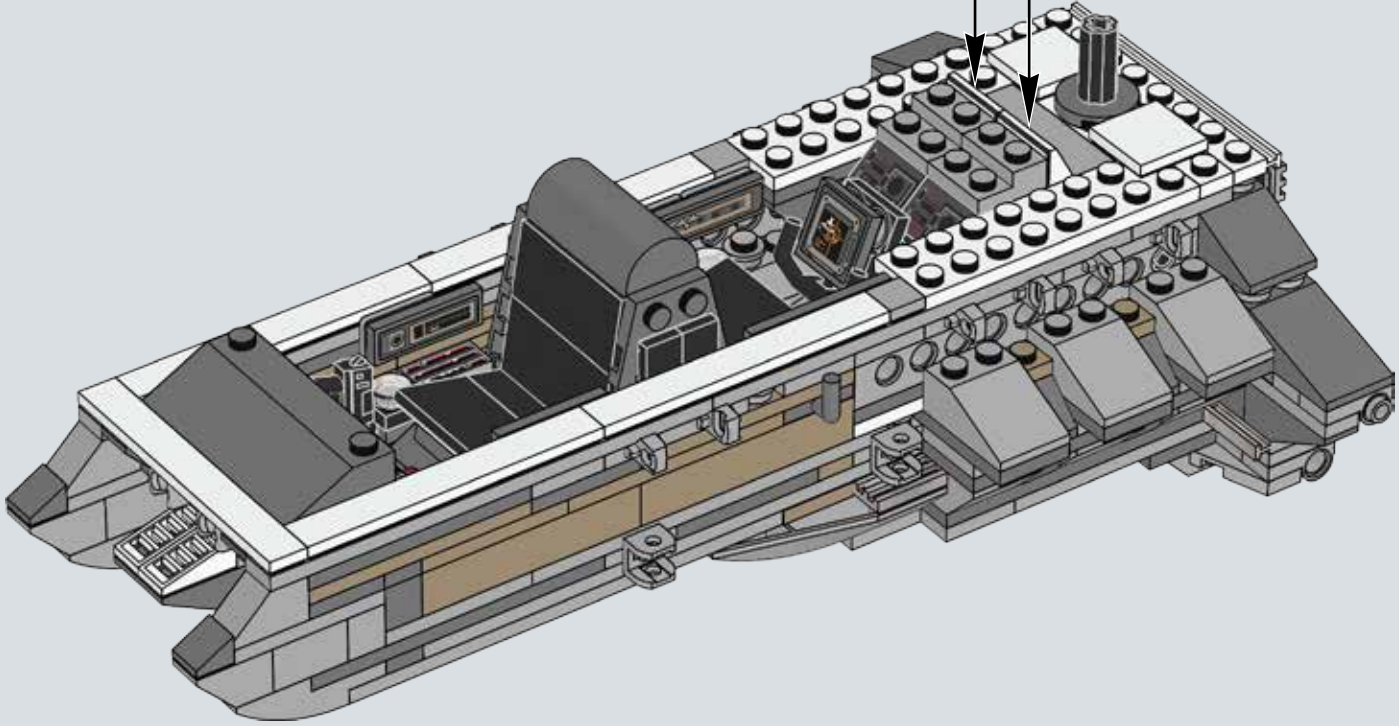
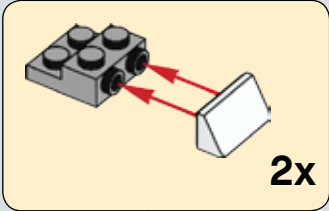



95

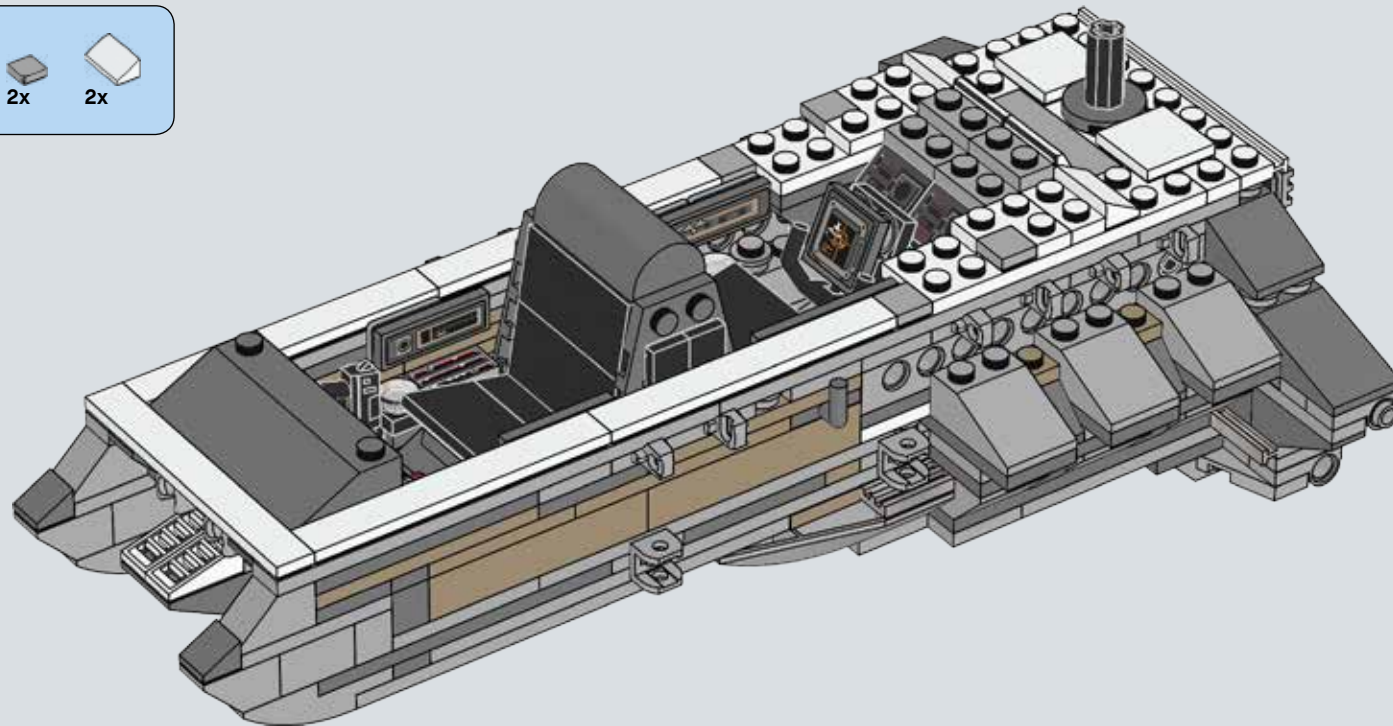

96

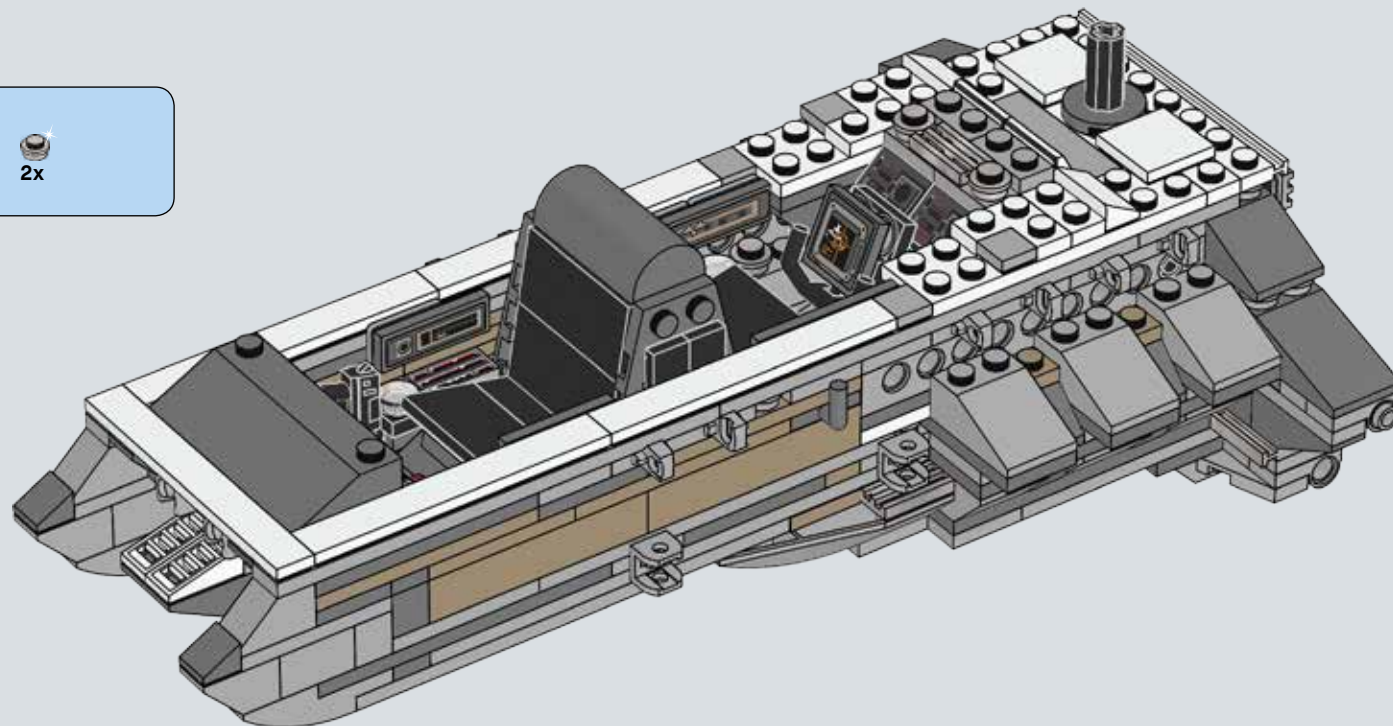



2x

97

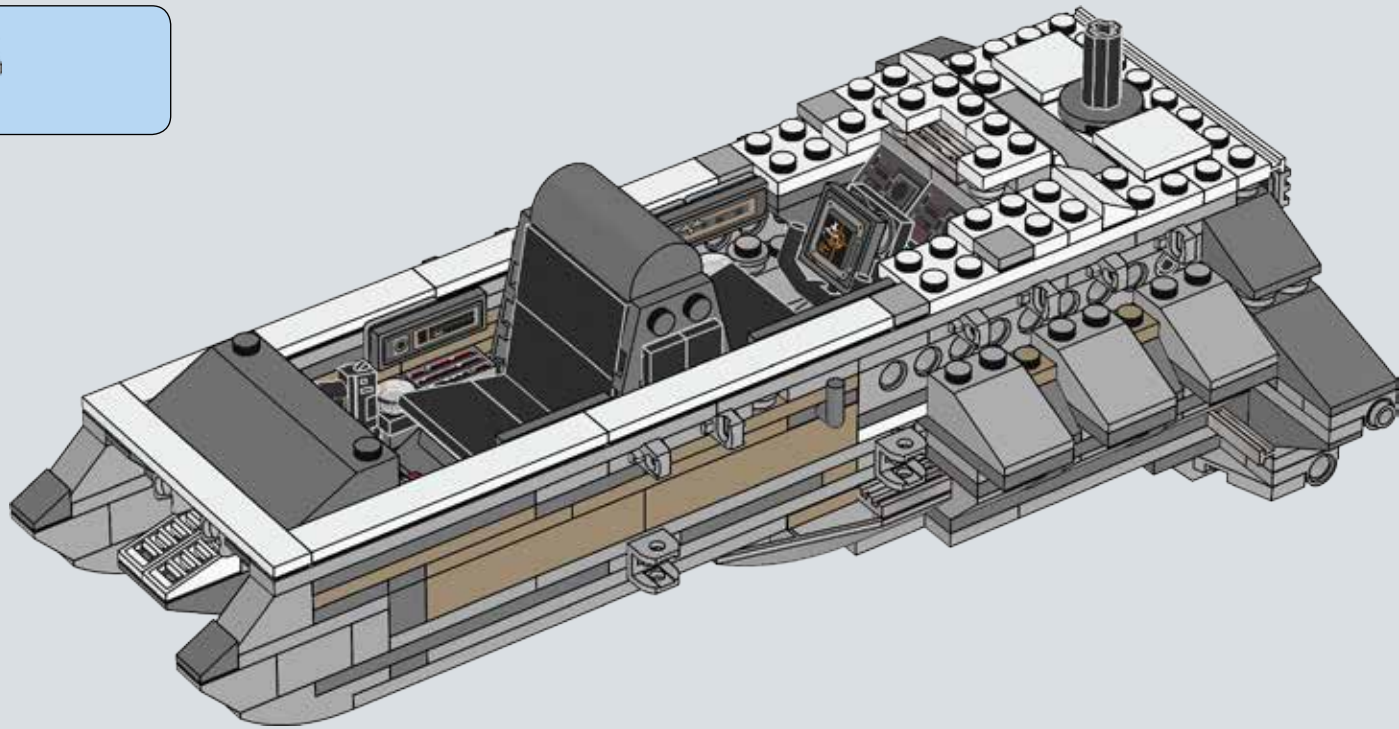

1x



2x

98

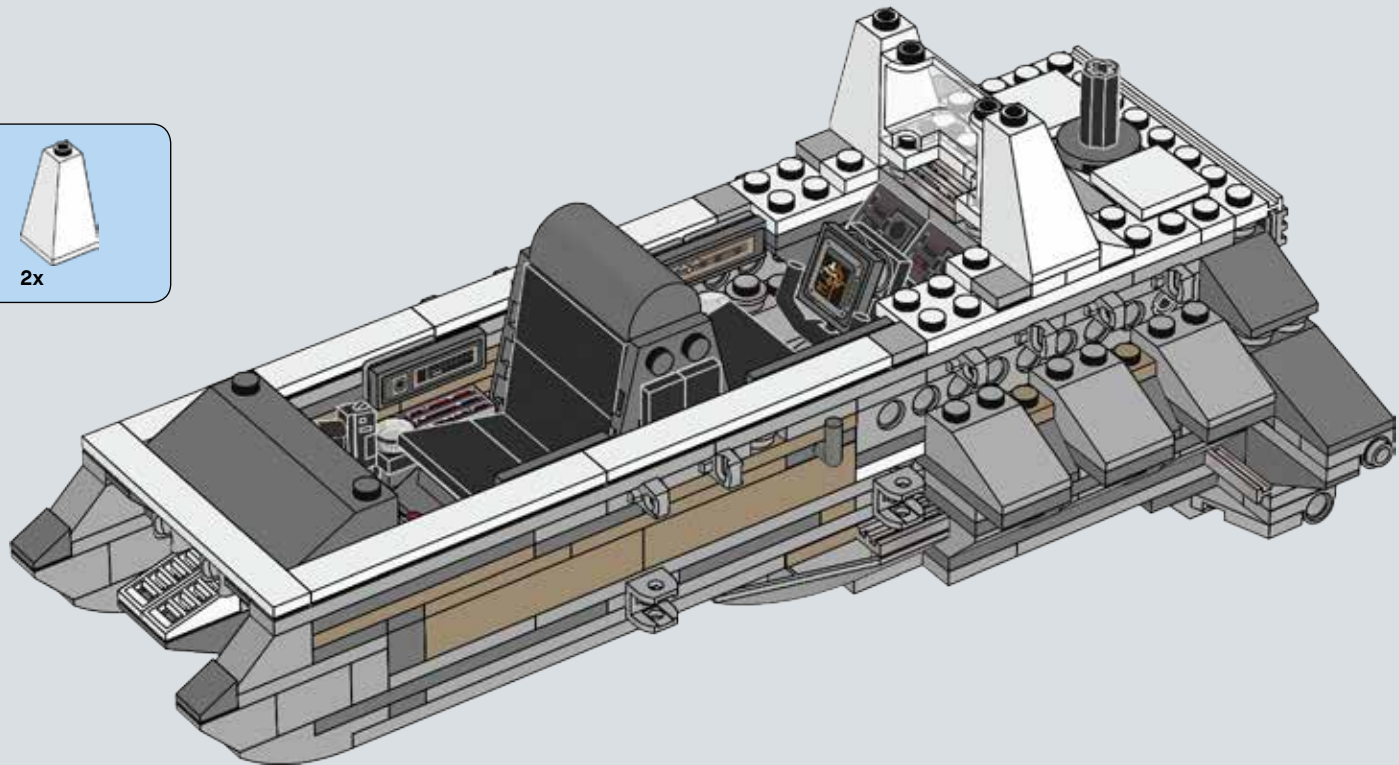

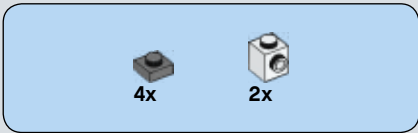

99

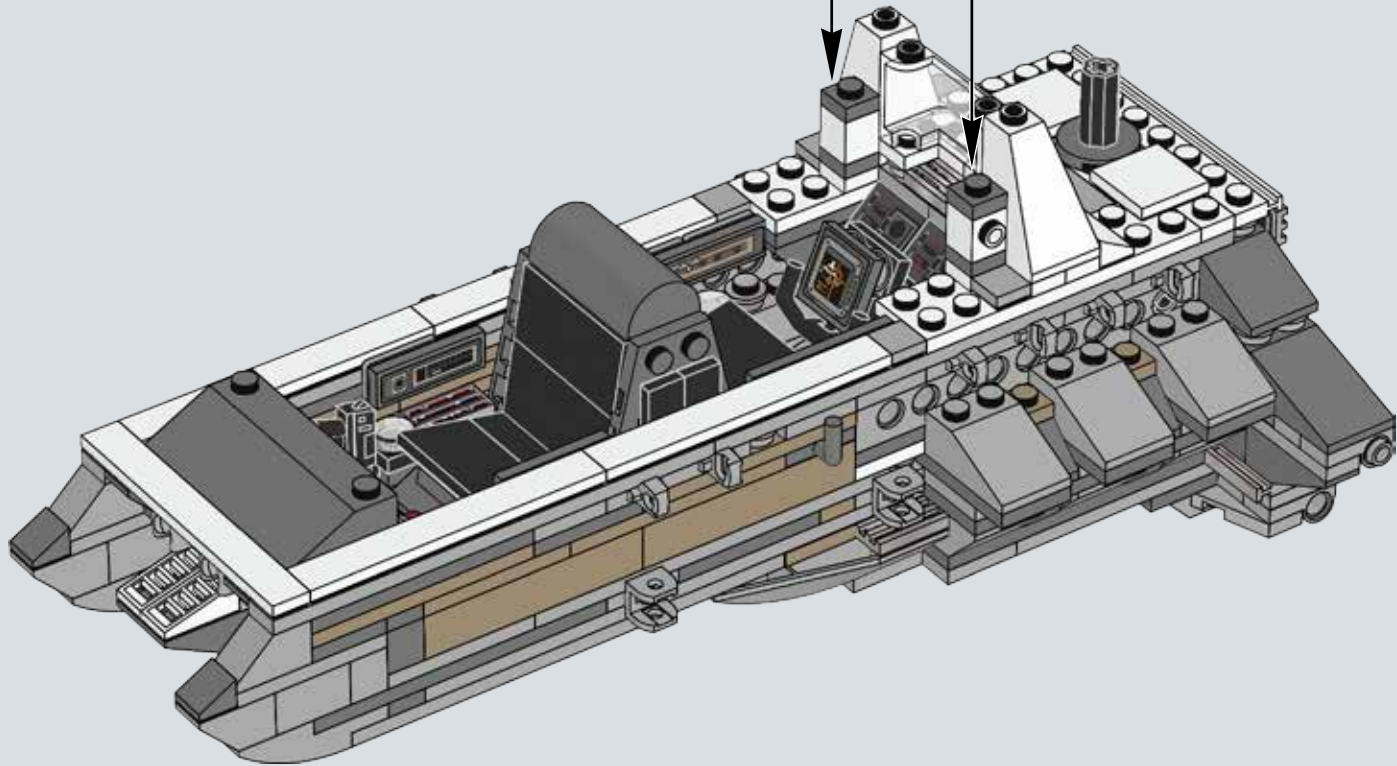
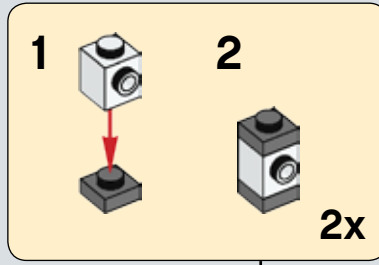

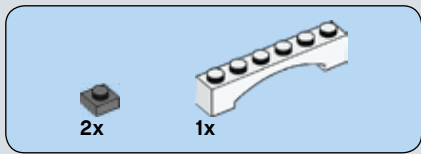

100

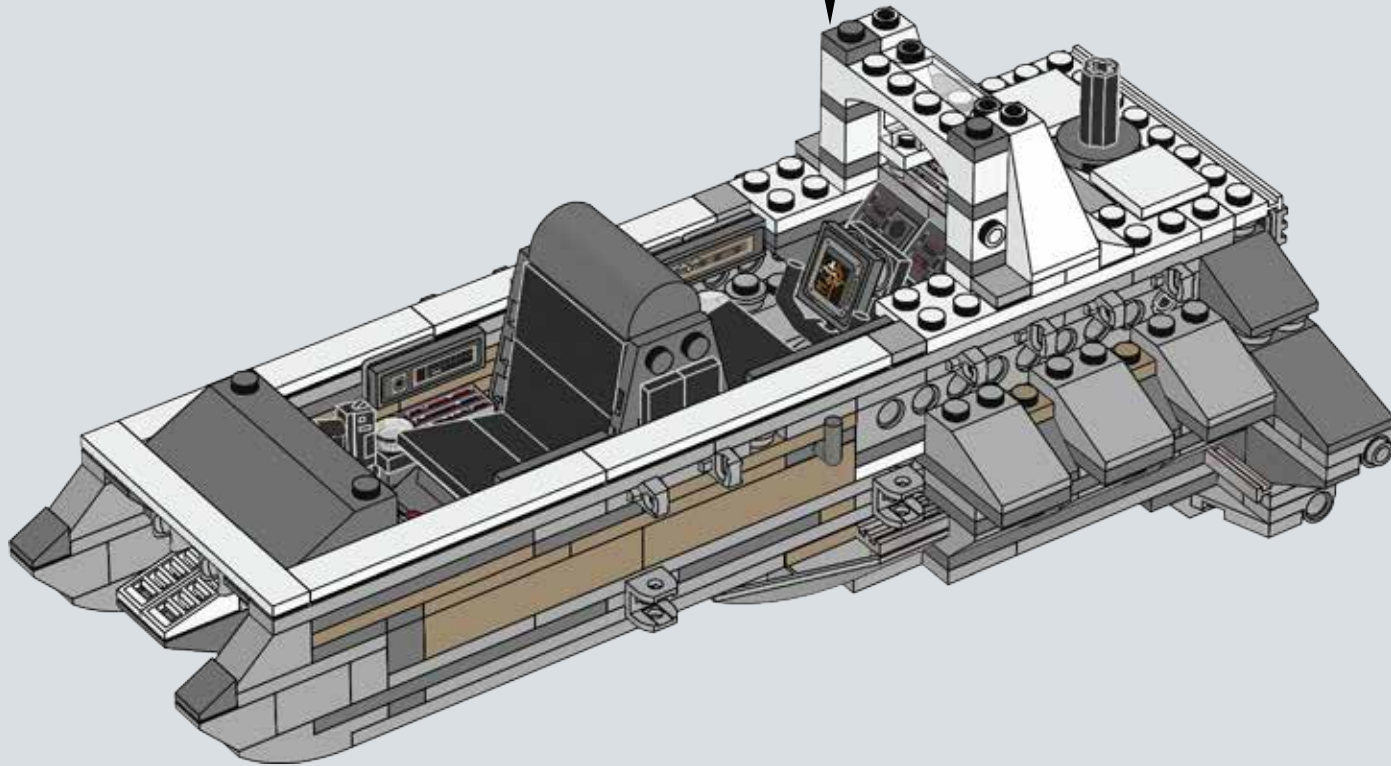
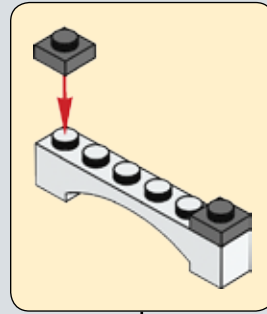

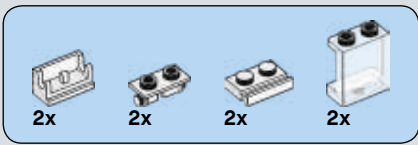

101

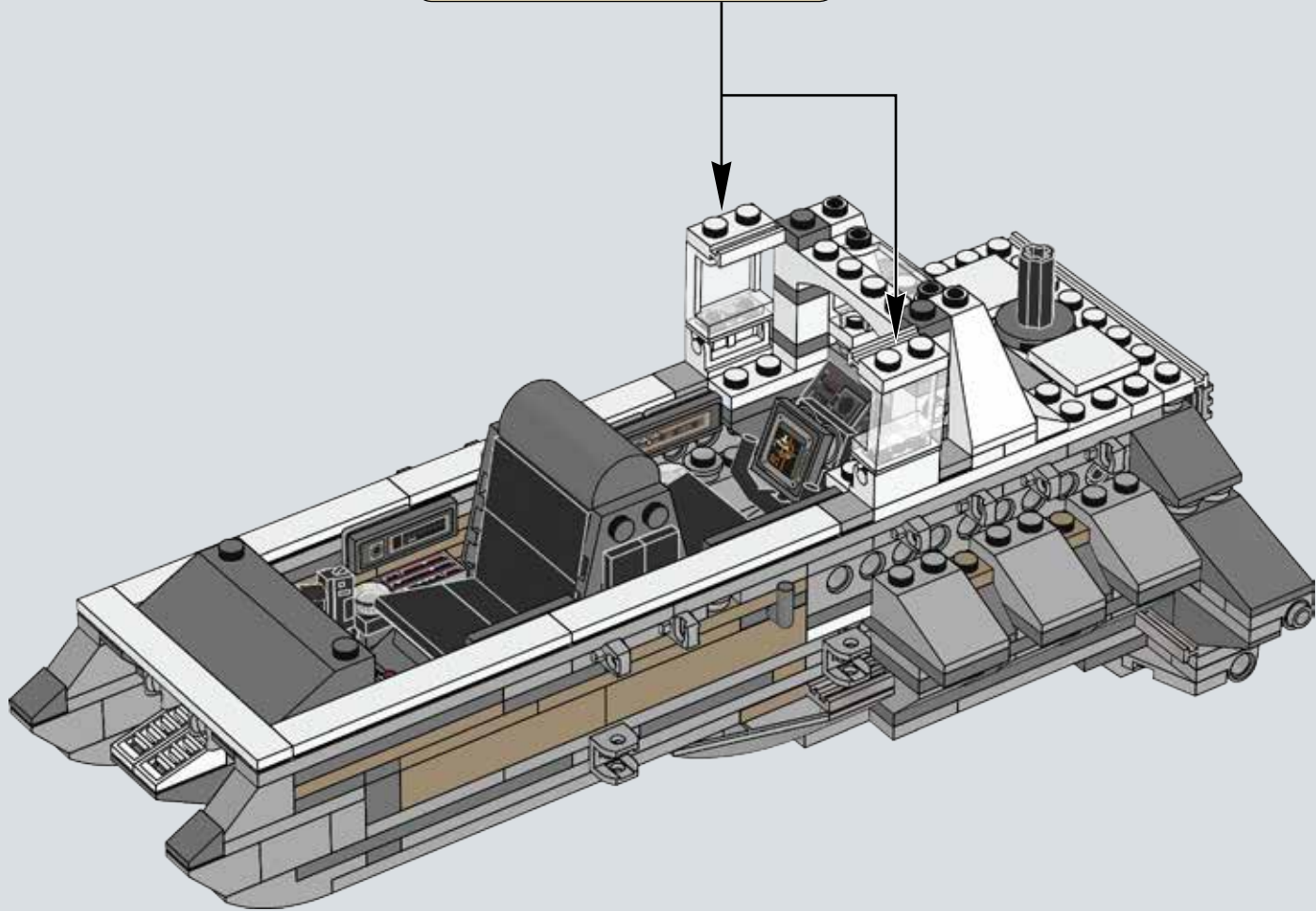
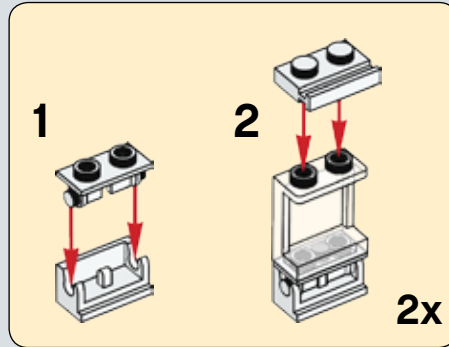

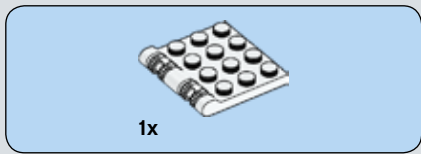

102

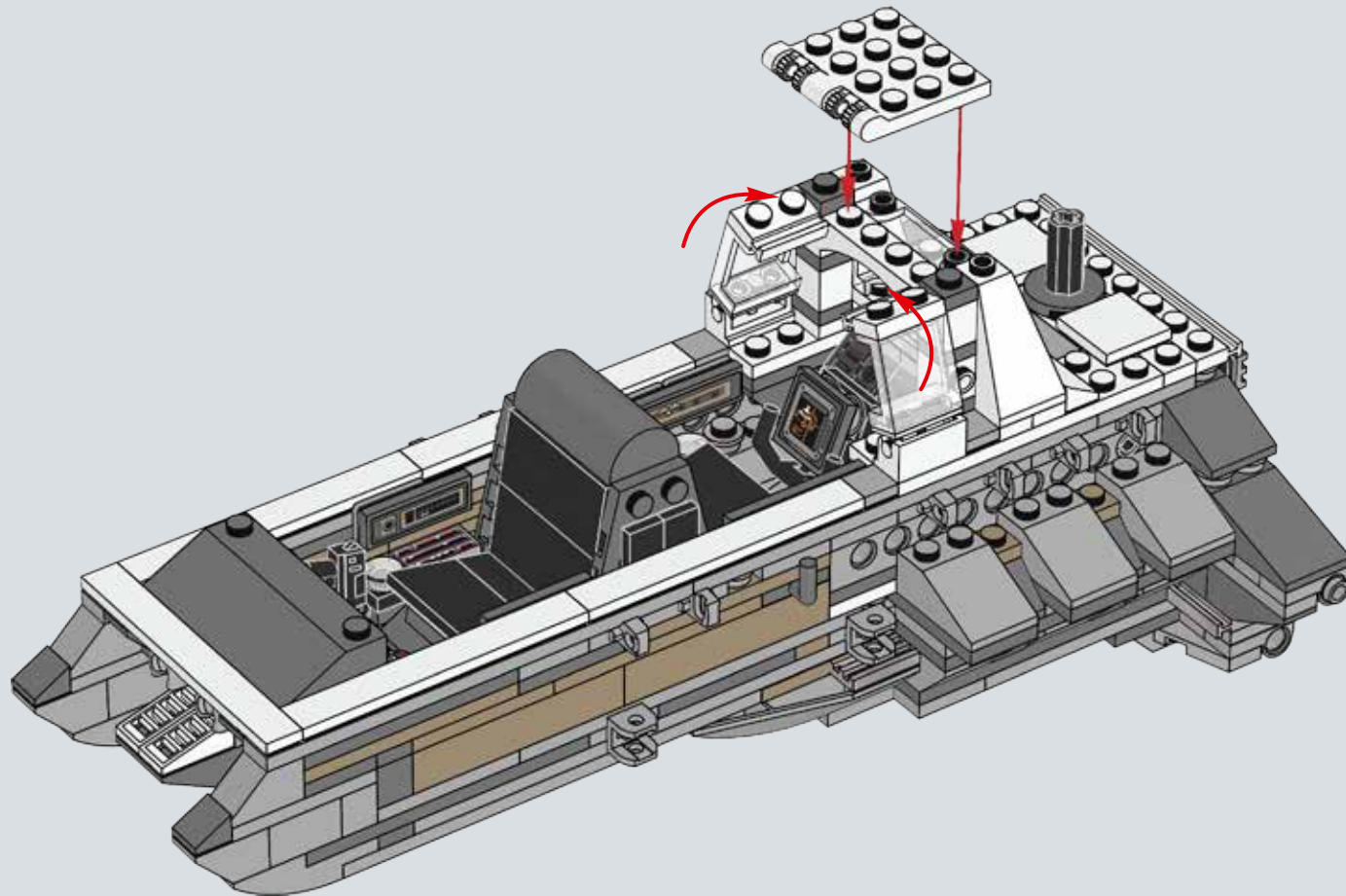

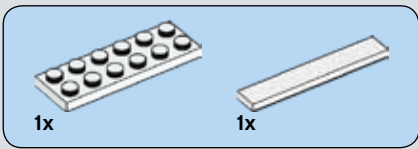

103

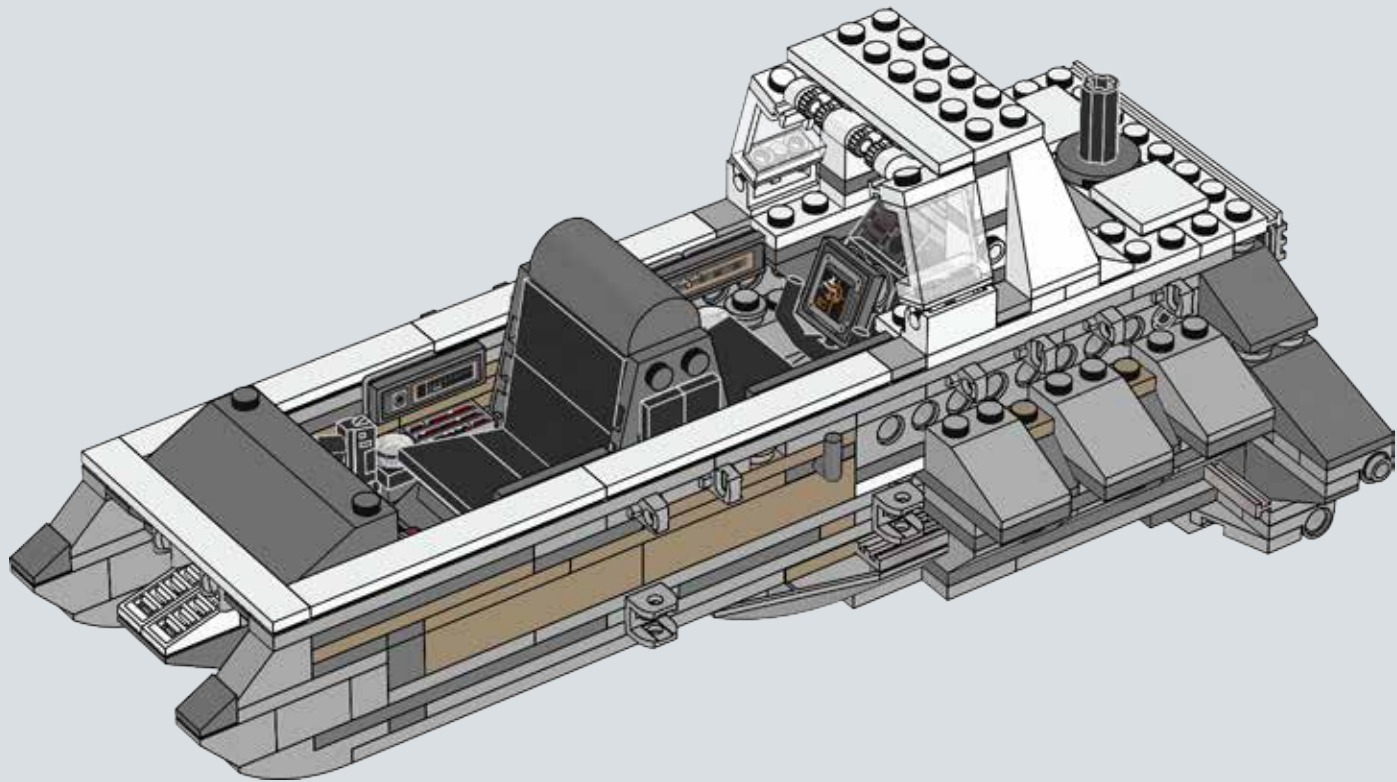

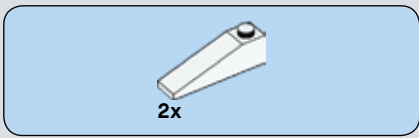

104

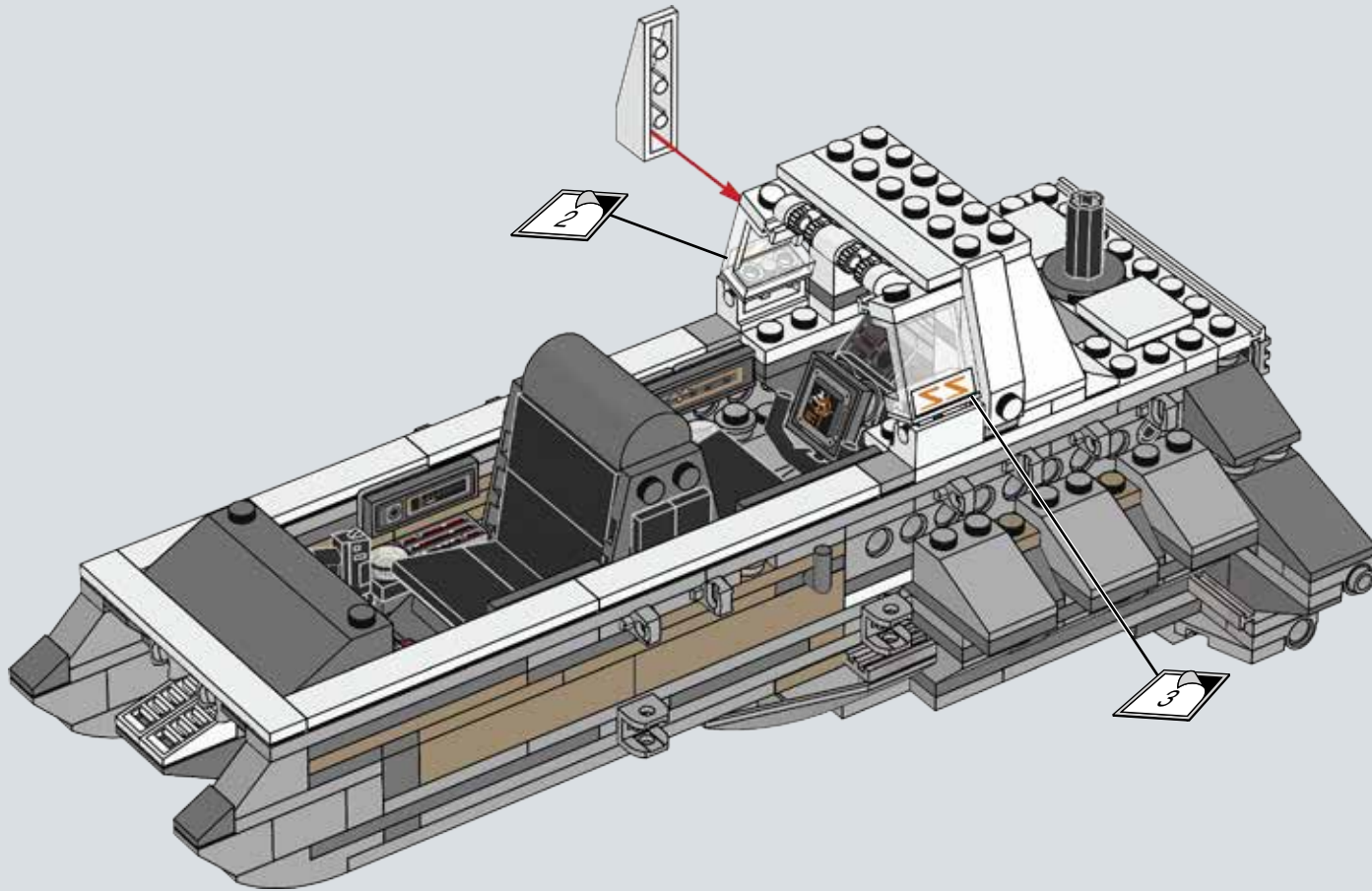

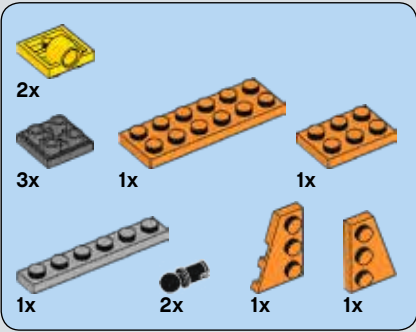

105

1



2

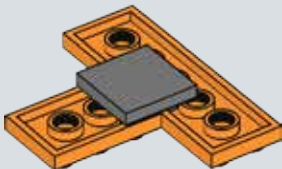

3

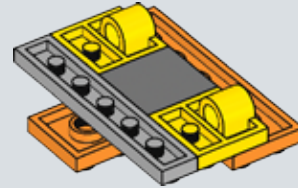

4

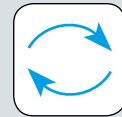
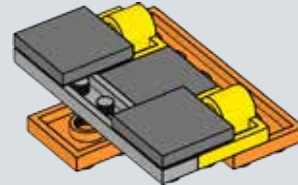

5

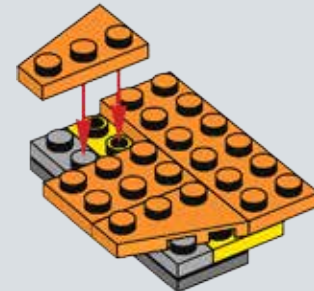

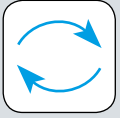

6

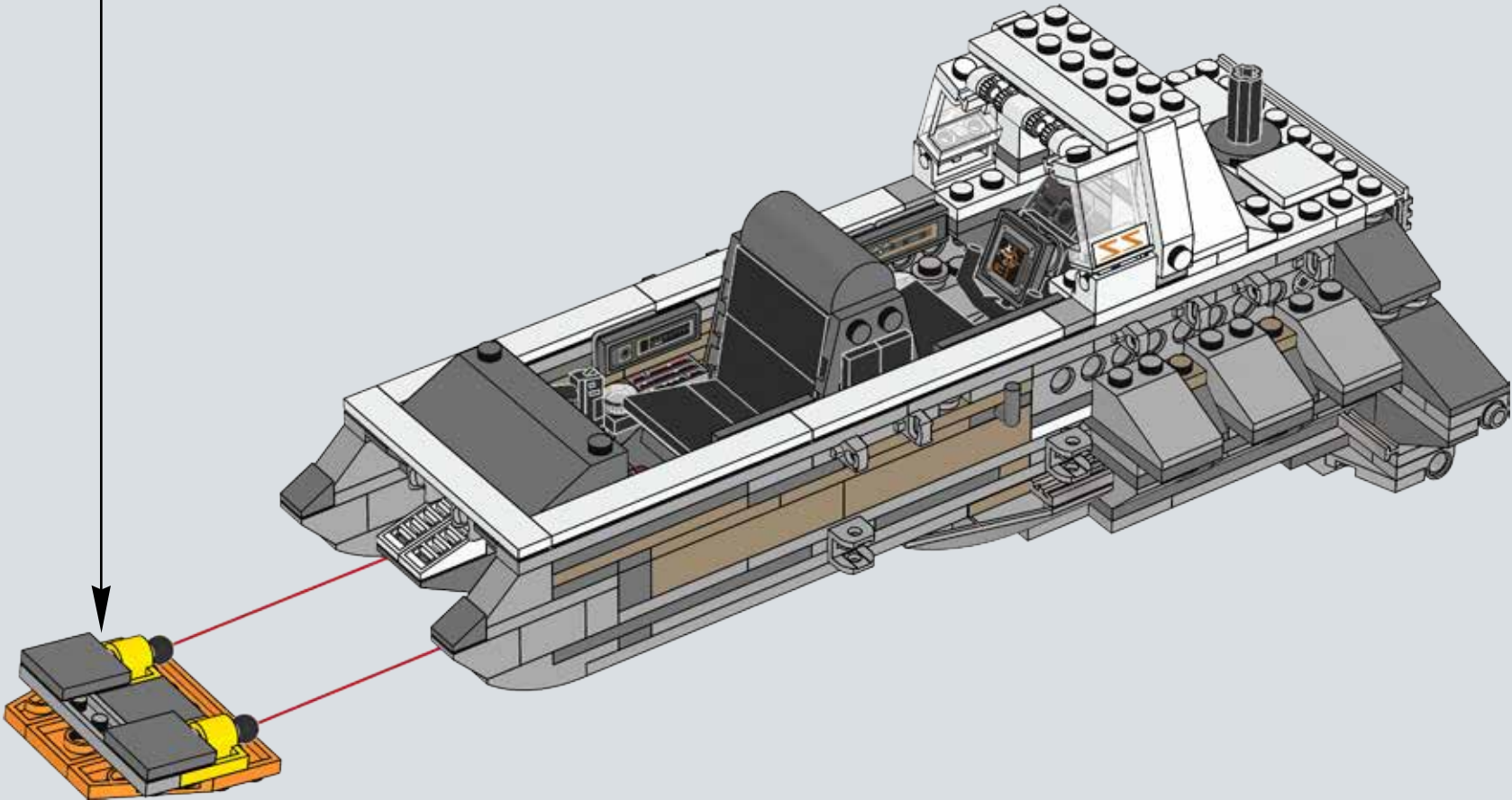
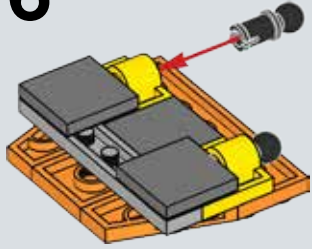

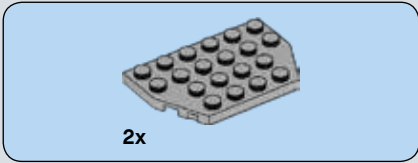

106

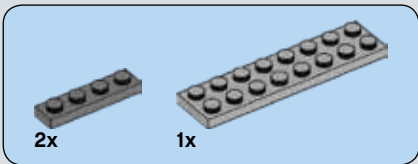
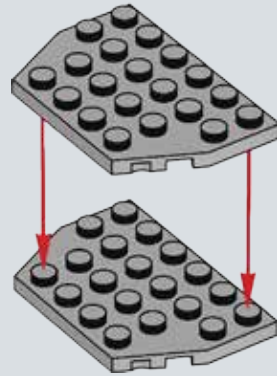

107

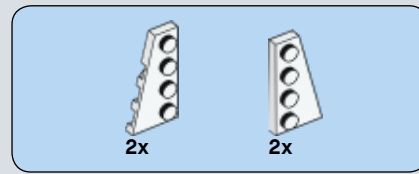
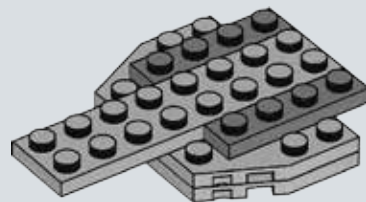

108

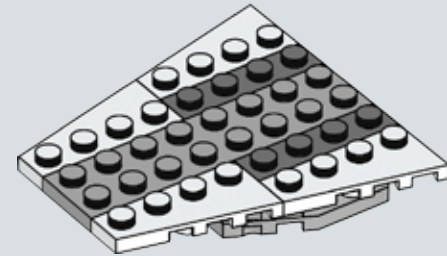

109

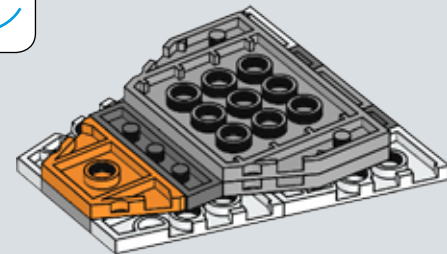
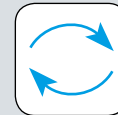



1x

110

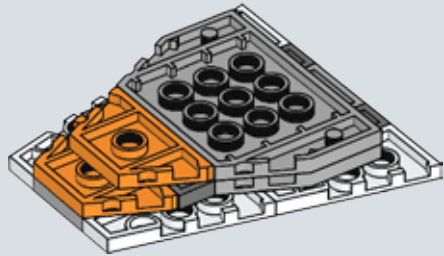

1x

112

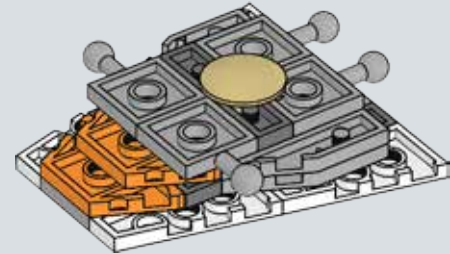

1x



4x

111

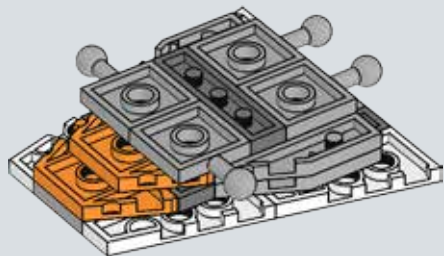

1x



6x

113

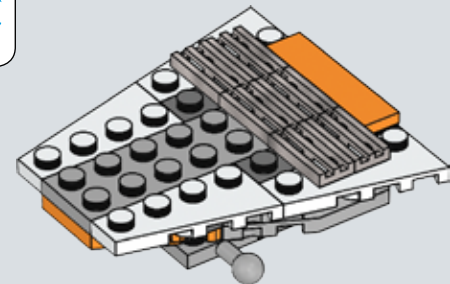
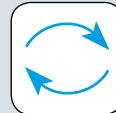

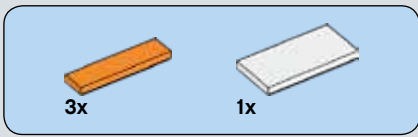

114

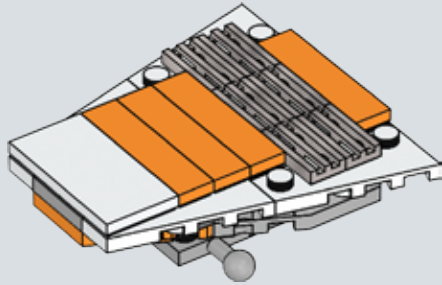

115

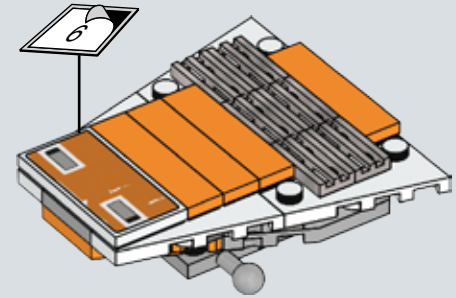

116

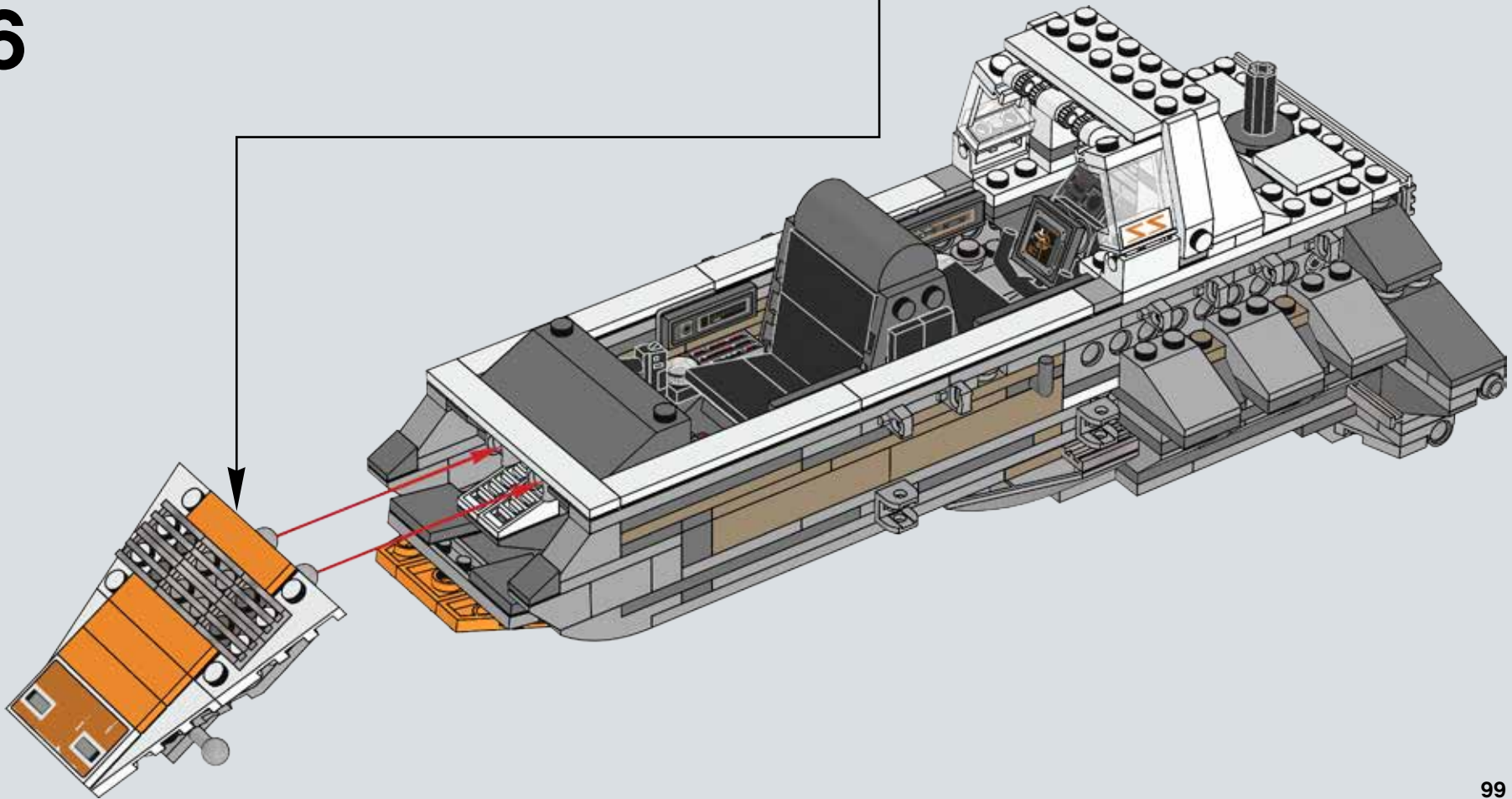

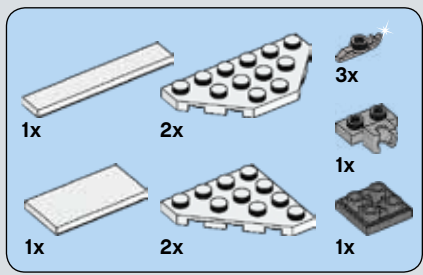

117

1

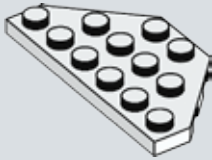

2

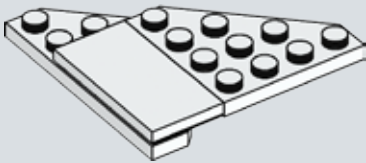

3

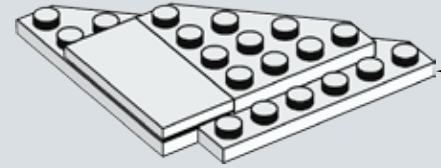

4

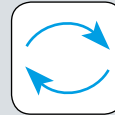
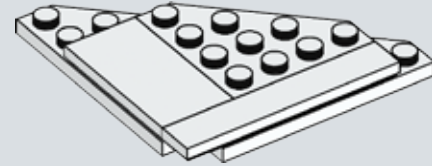

5

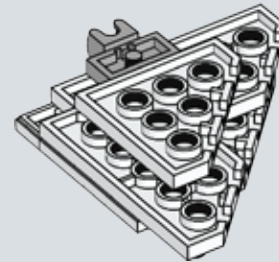

6

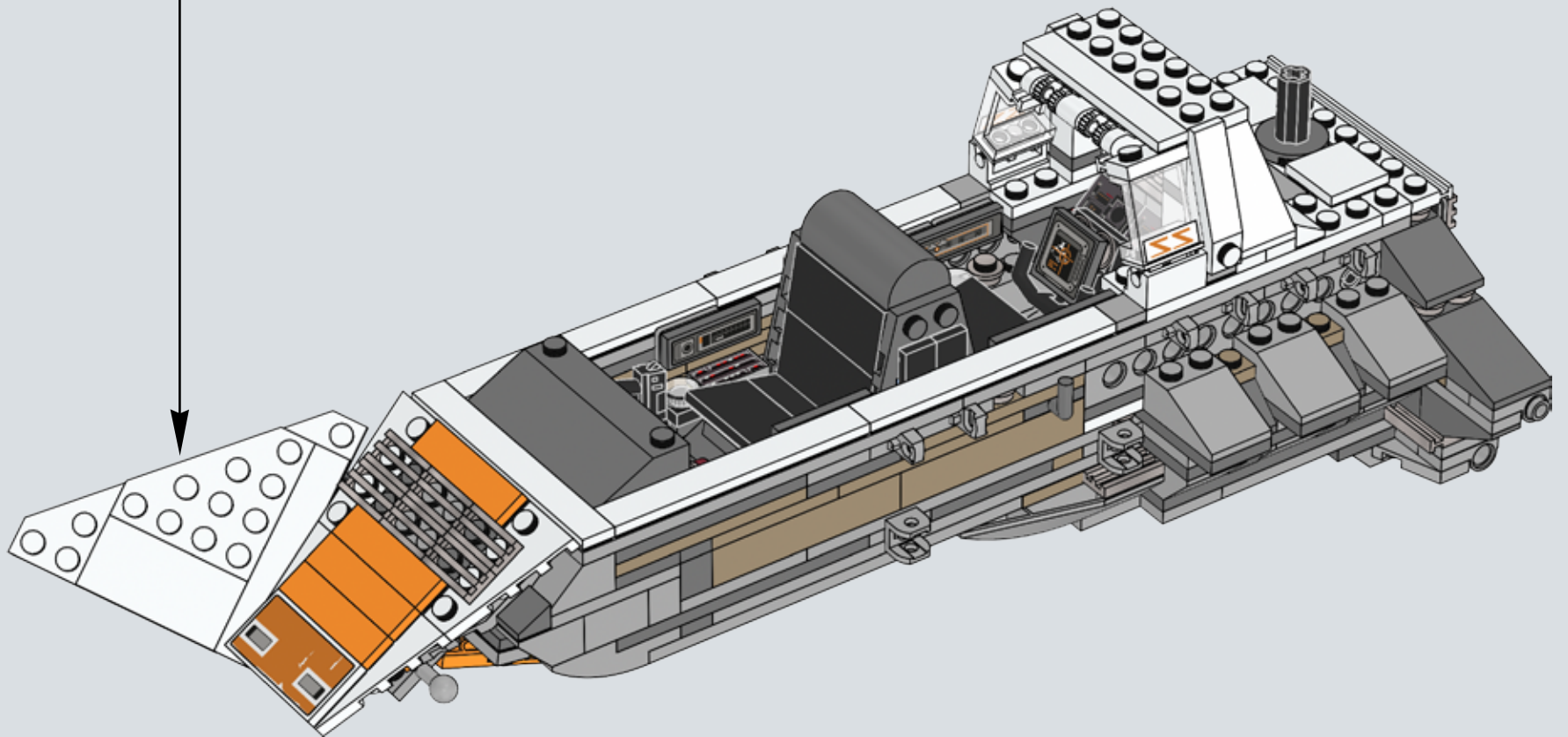
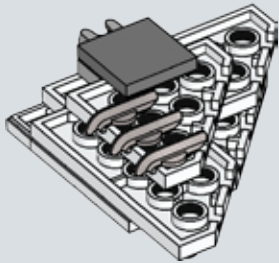

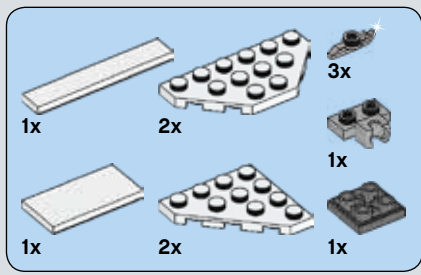

118

1

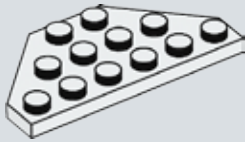

2

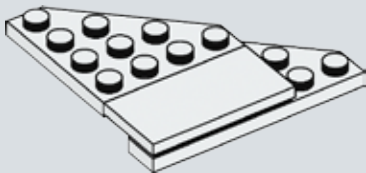

3

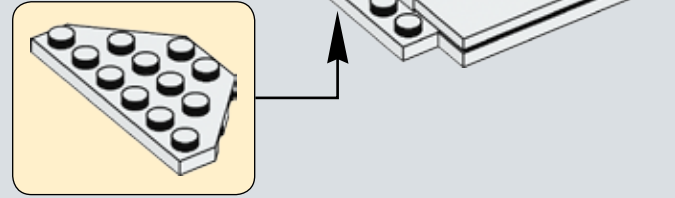

4

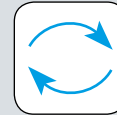
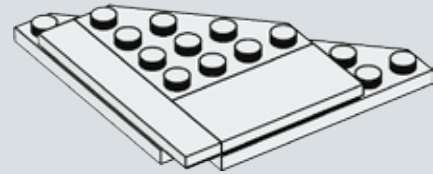

5

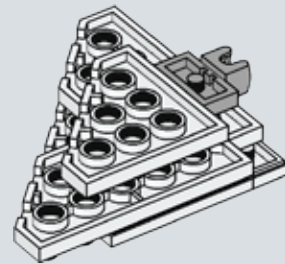

6

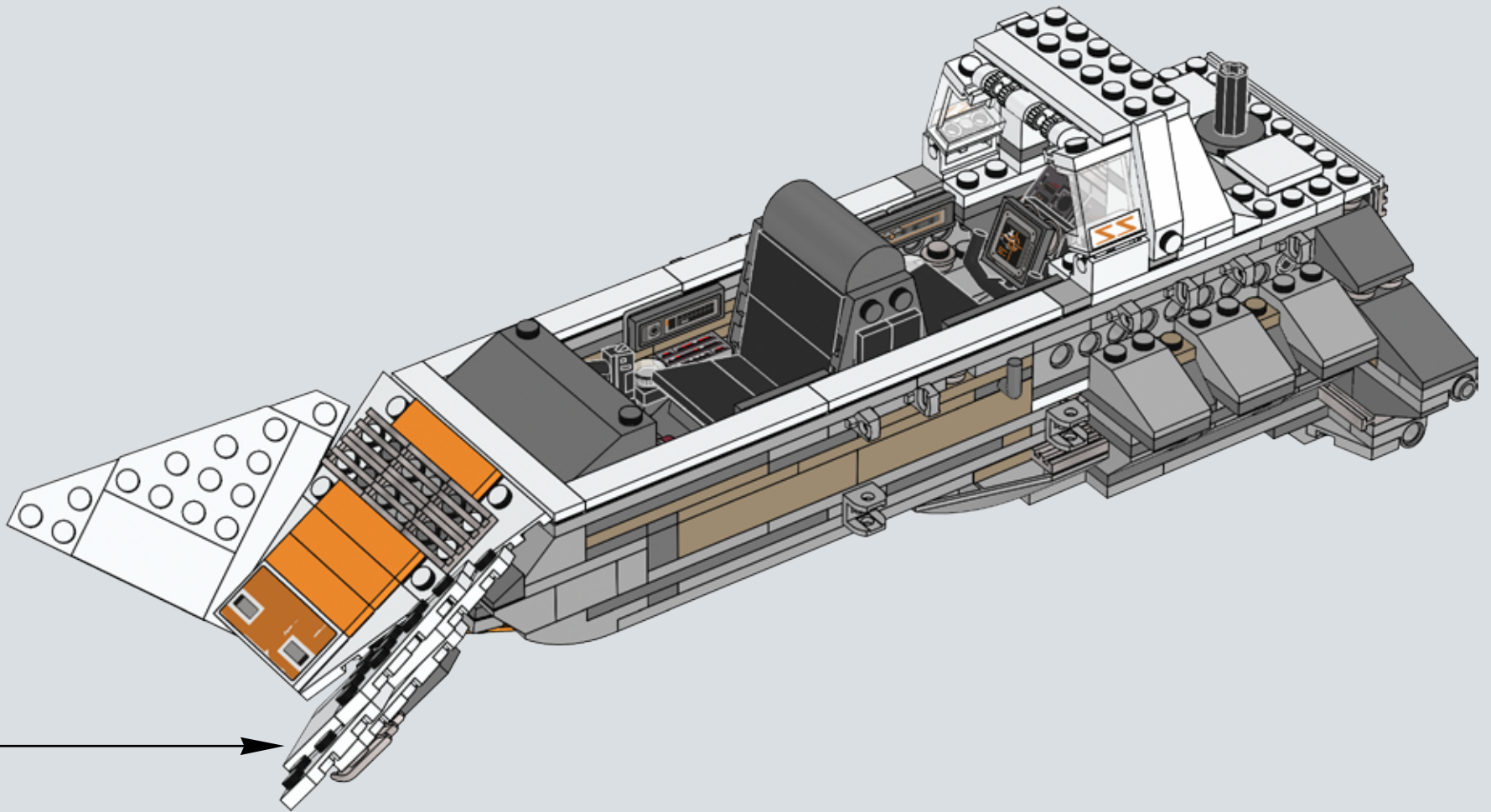
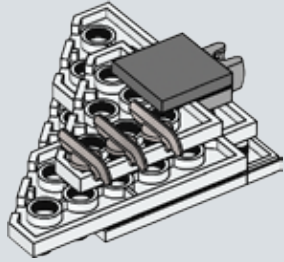



+

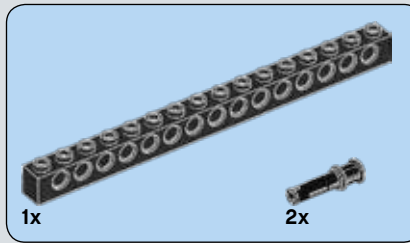
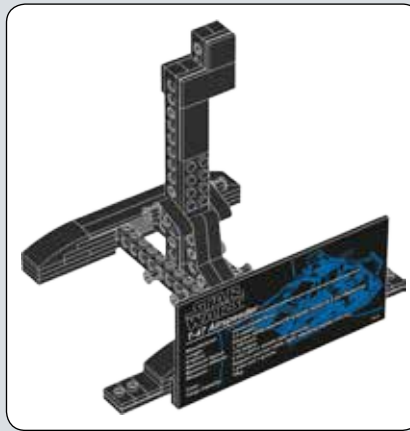

119

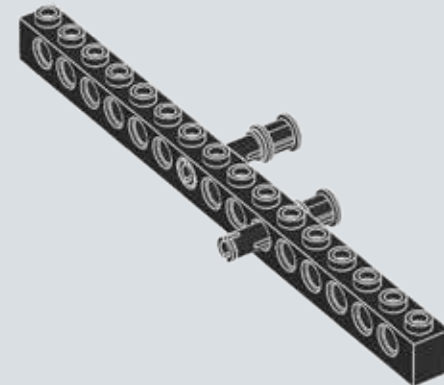

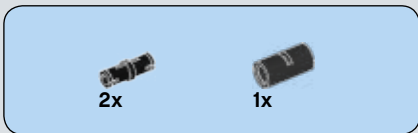

120

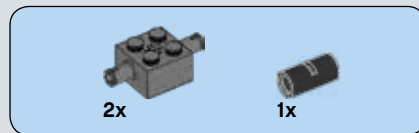
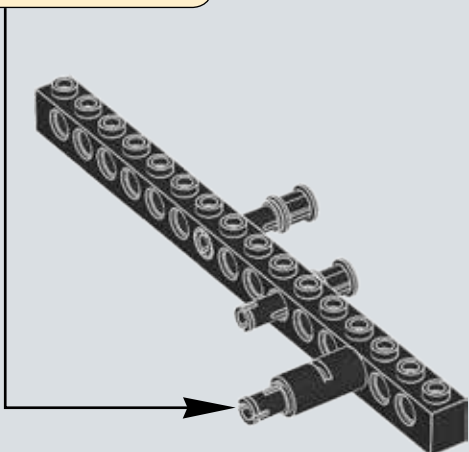
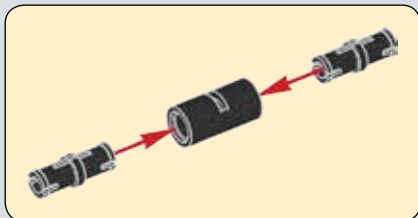

121

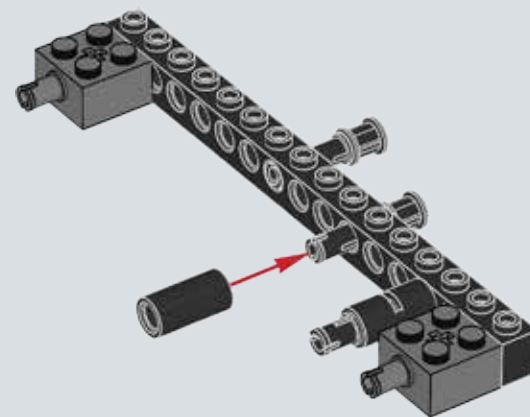

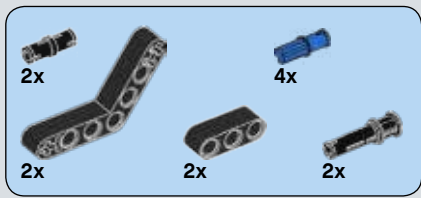

122

1



2



3

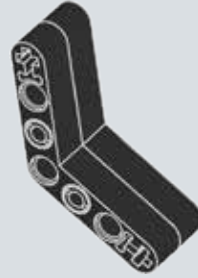

4

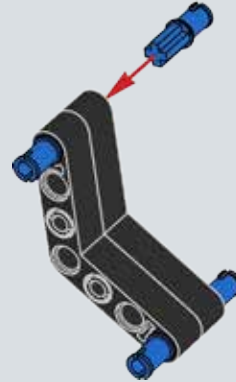

5

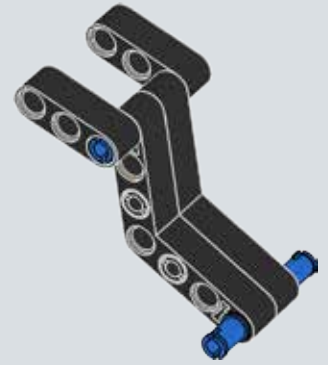

6

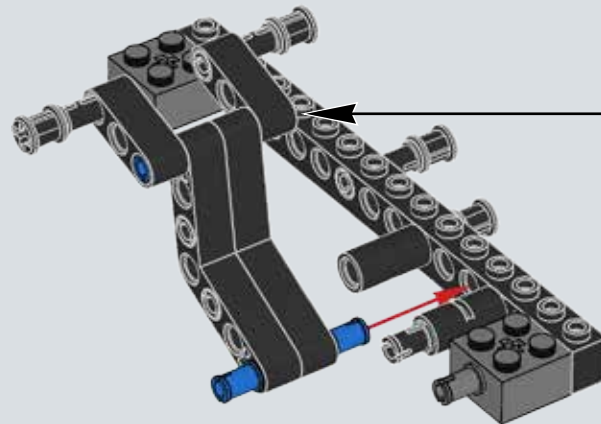
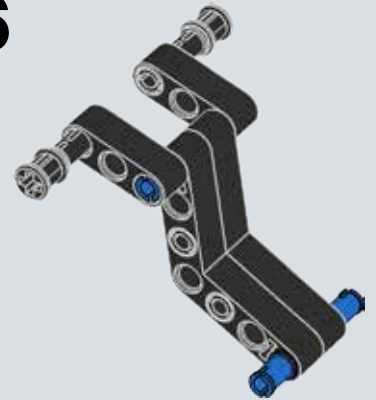

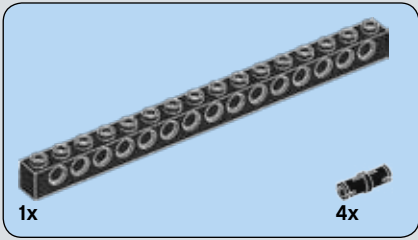
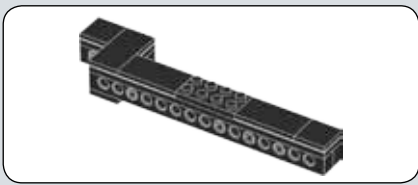

123

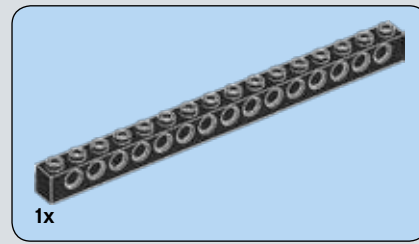
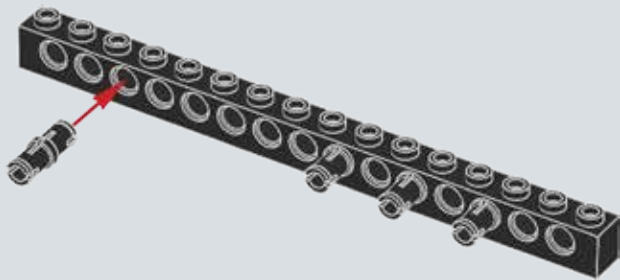

124

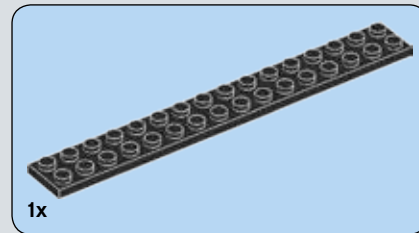
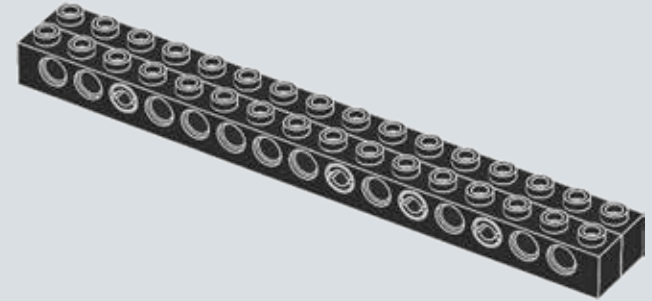

125

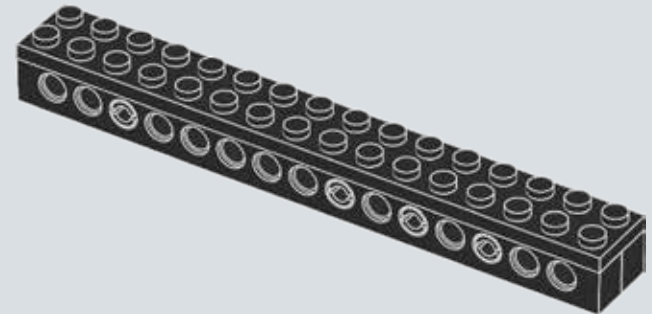

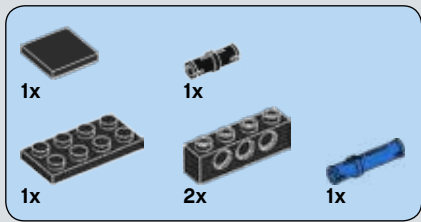

126

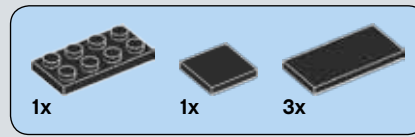
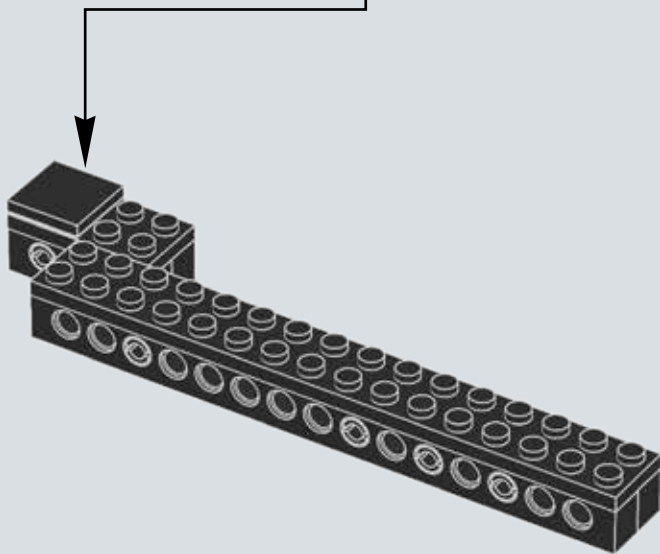
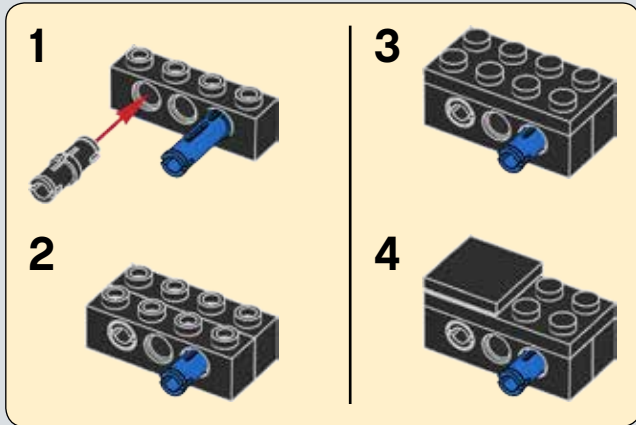

127

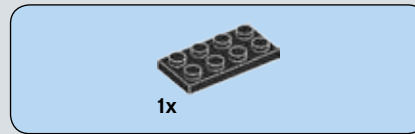
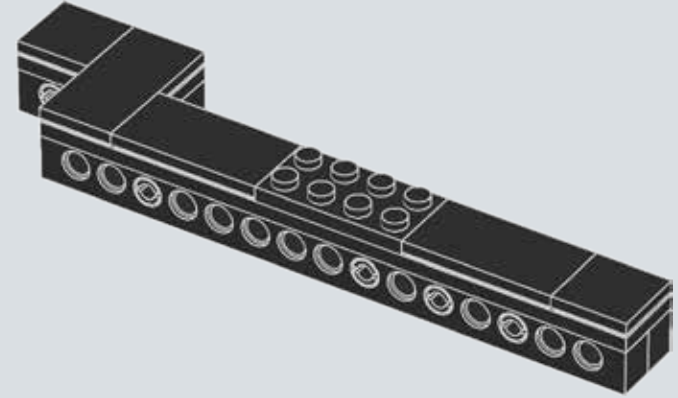

128

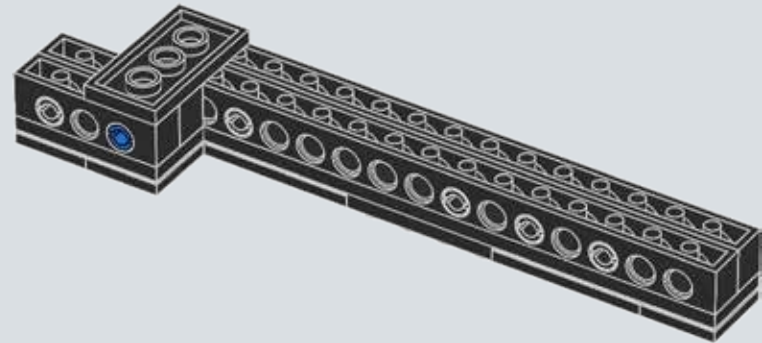
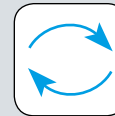

129

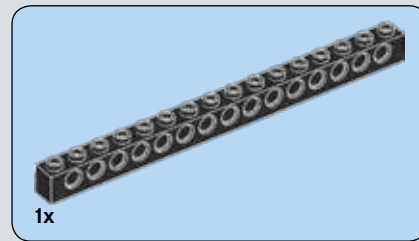
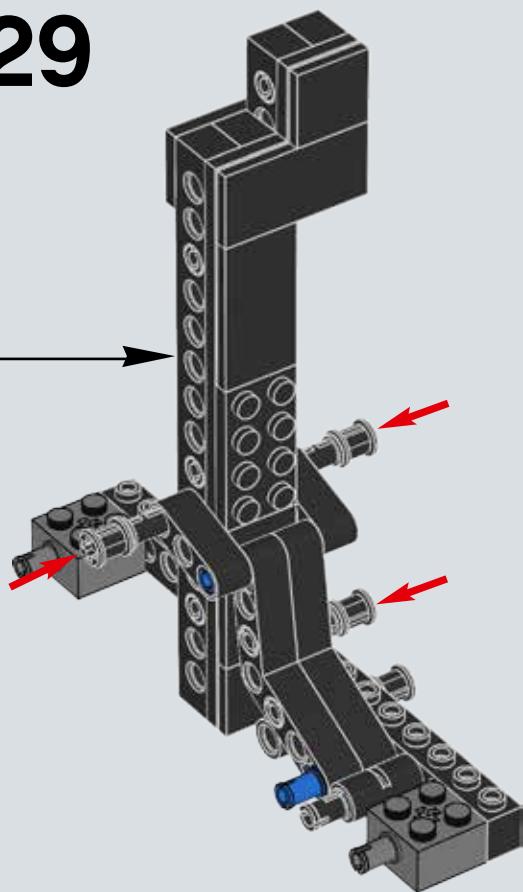

130

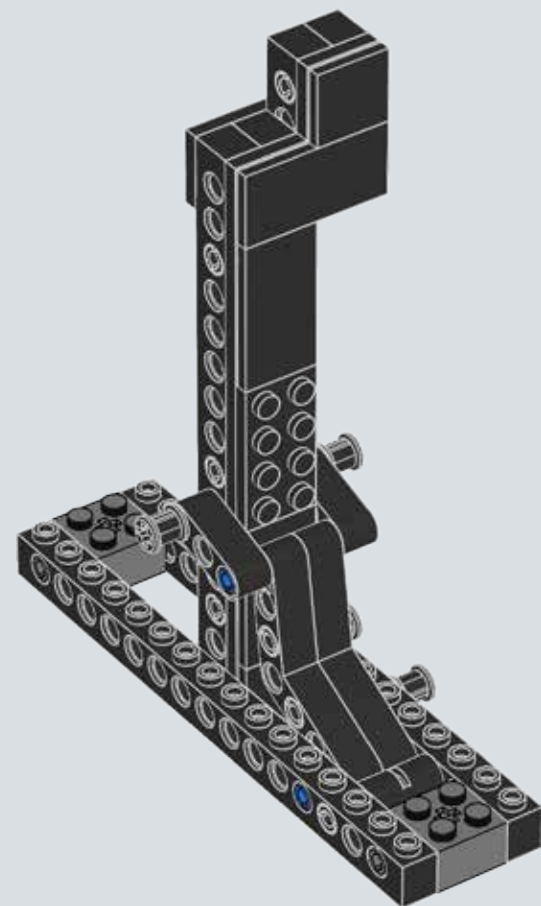



2x

131

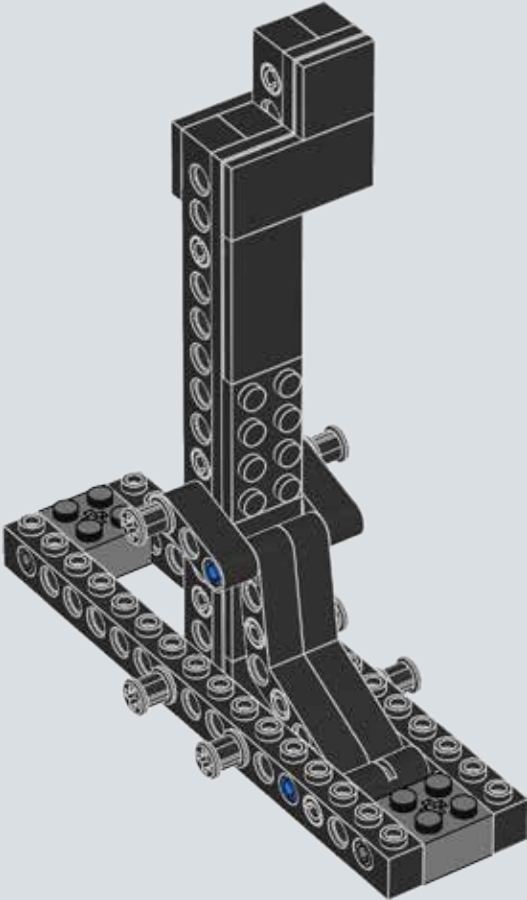

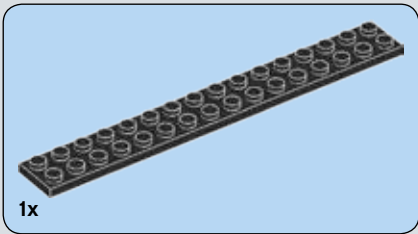
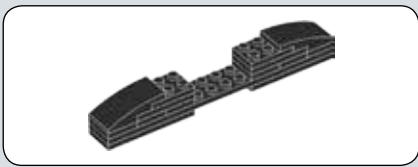

132

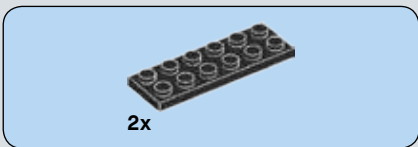
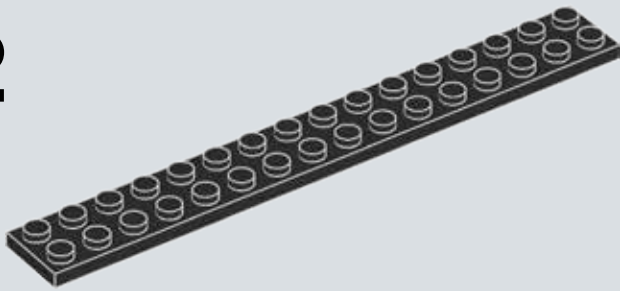

133

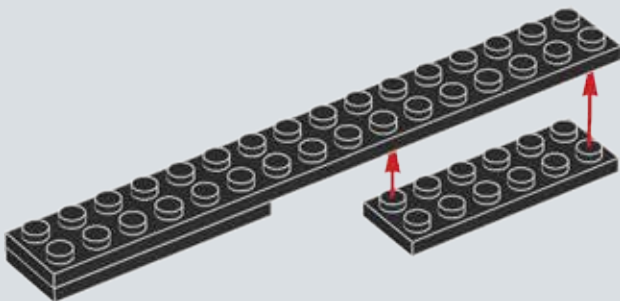

134

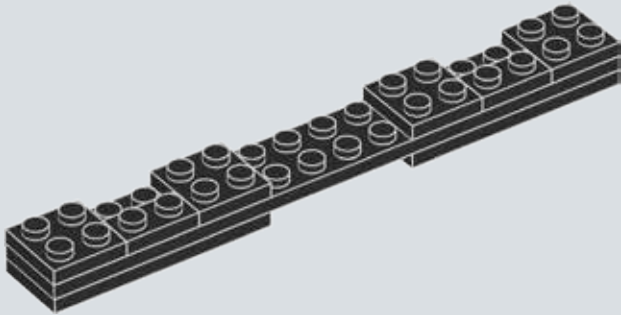

135

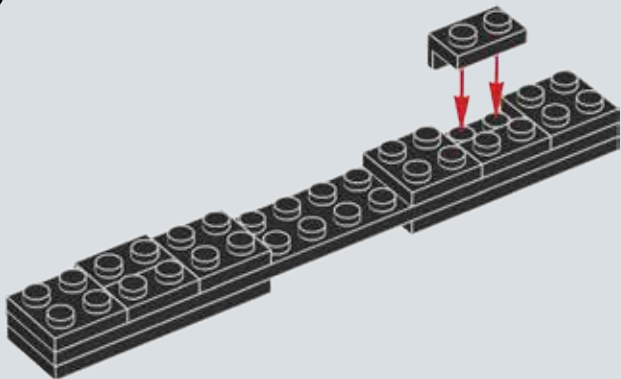

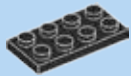

2x

136

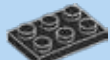
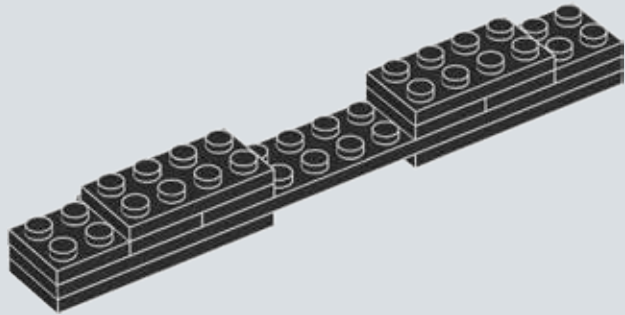

2x

137

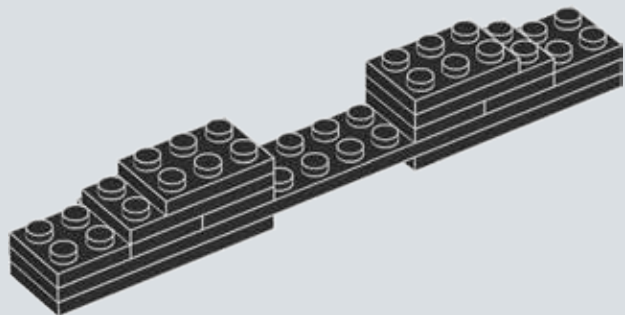

2x

138

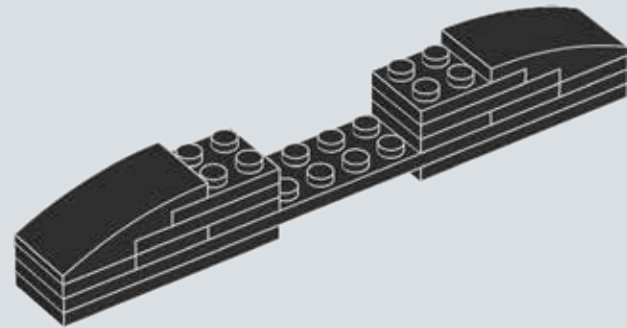

139

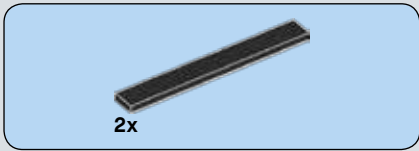
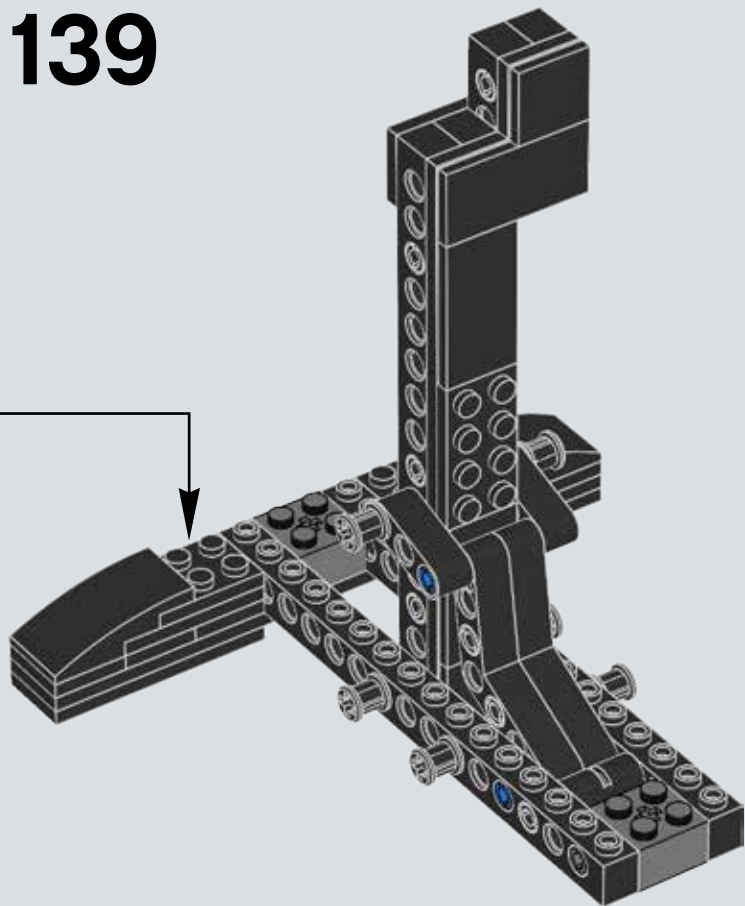

140

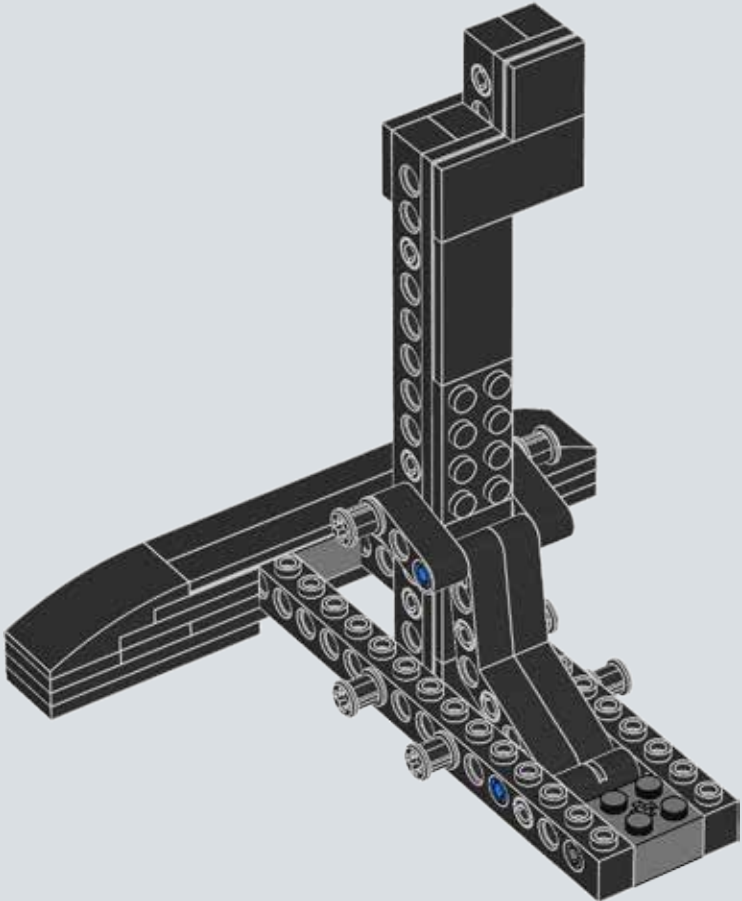

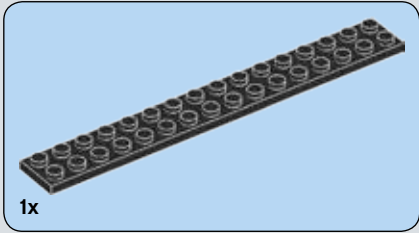
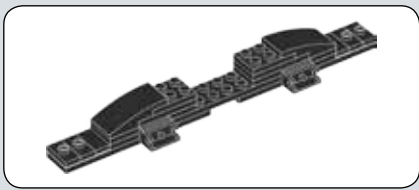

141

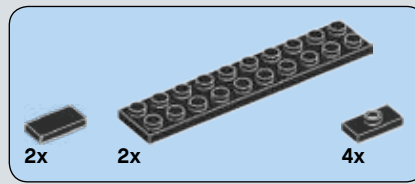
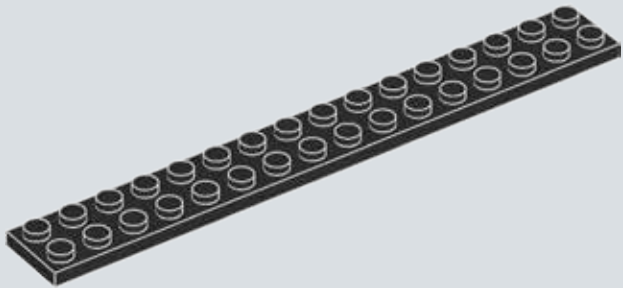

142

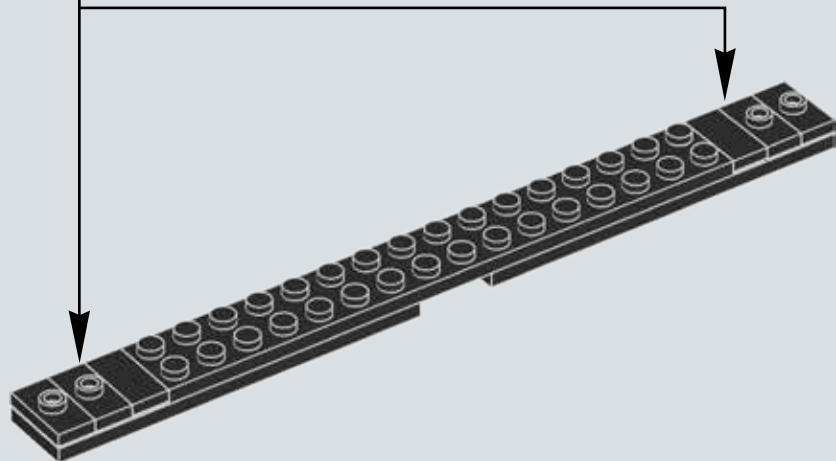
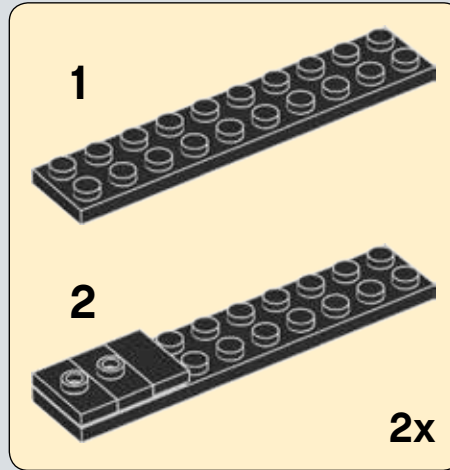



143

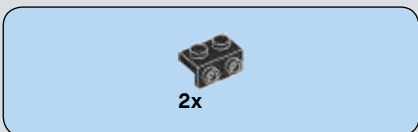
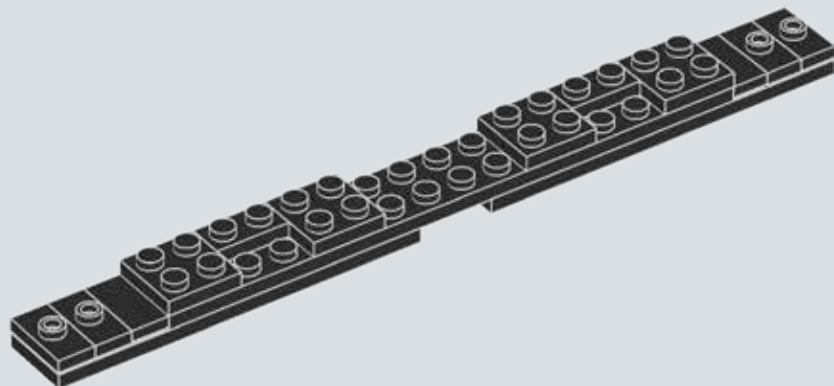

144

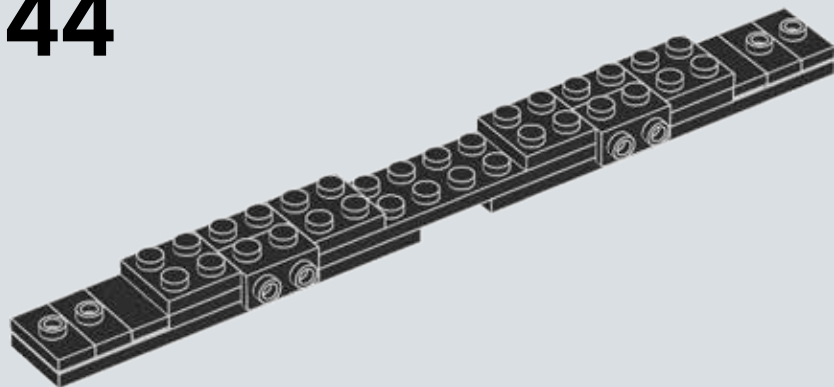

145

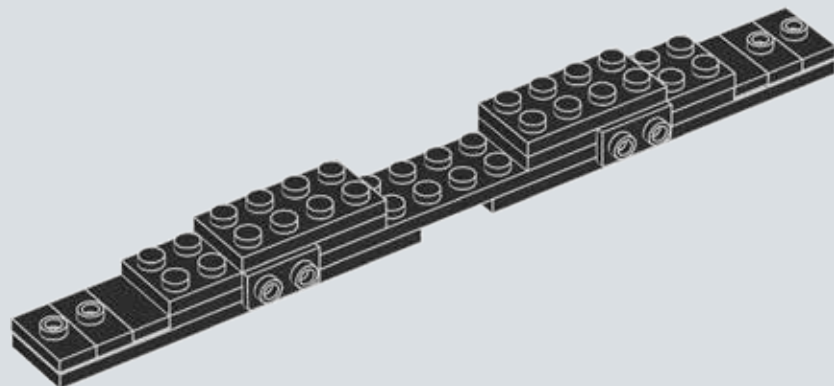

146

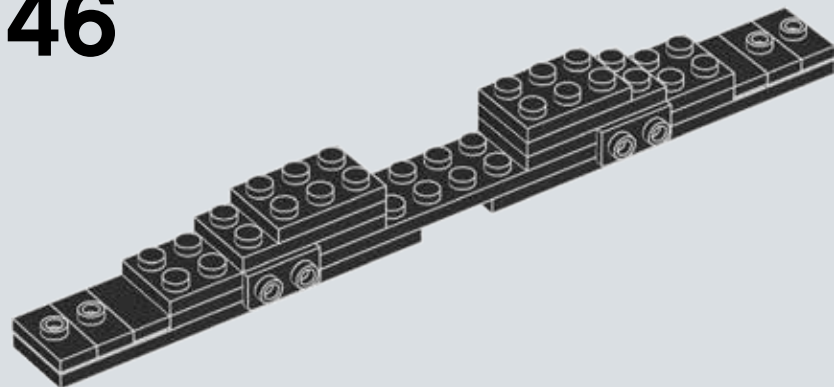

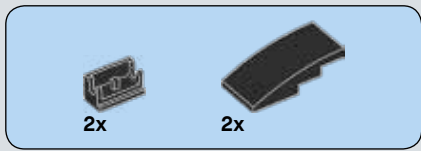

147

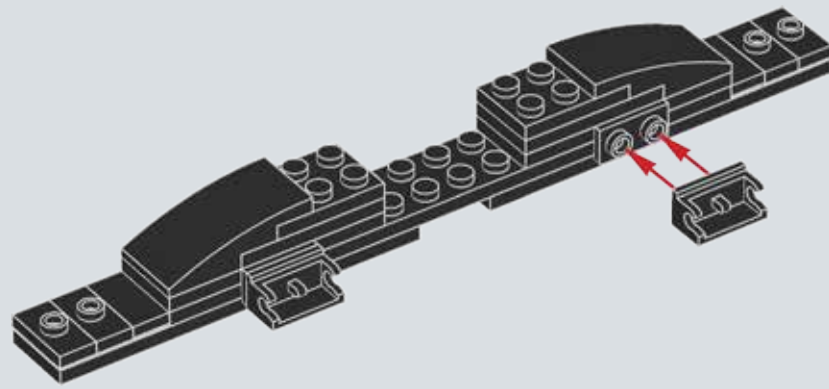

148

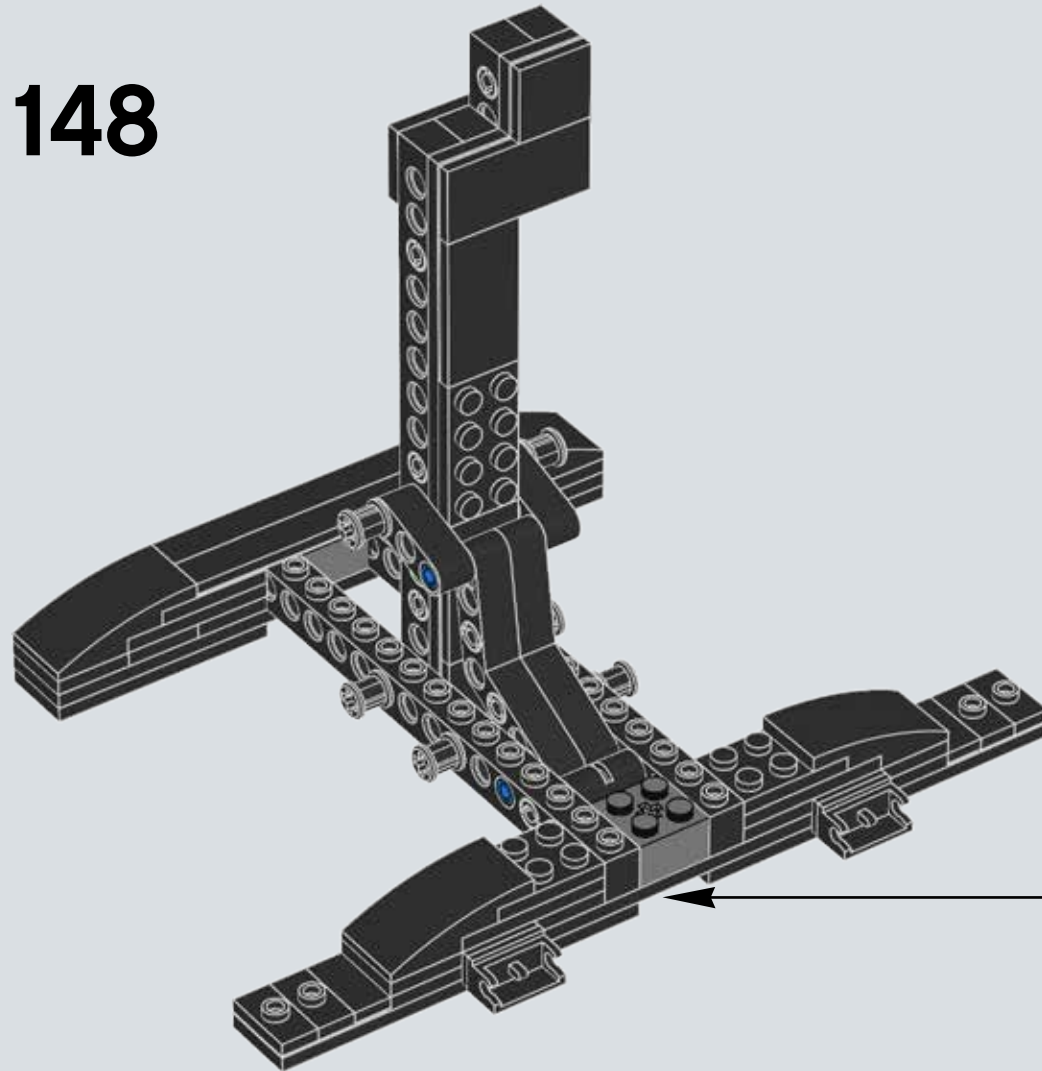

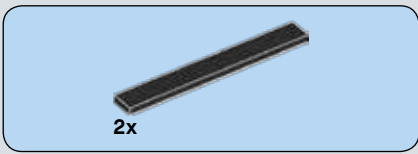

149

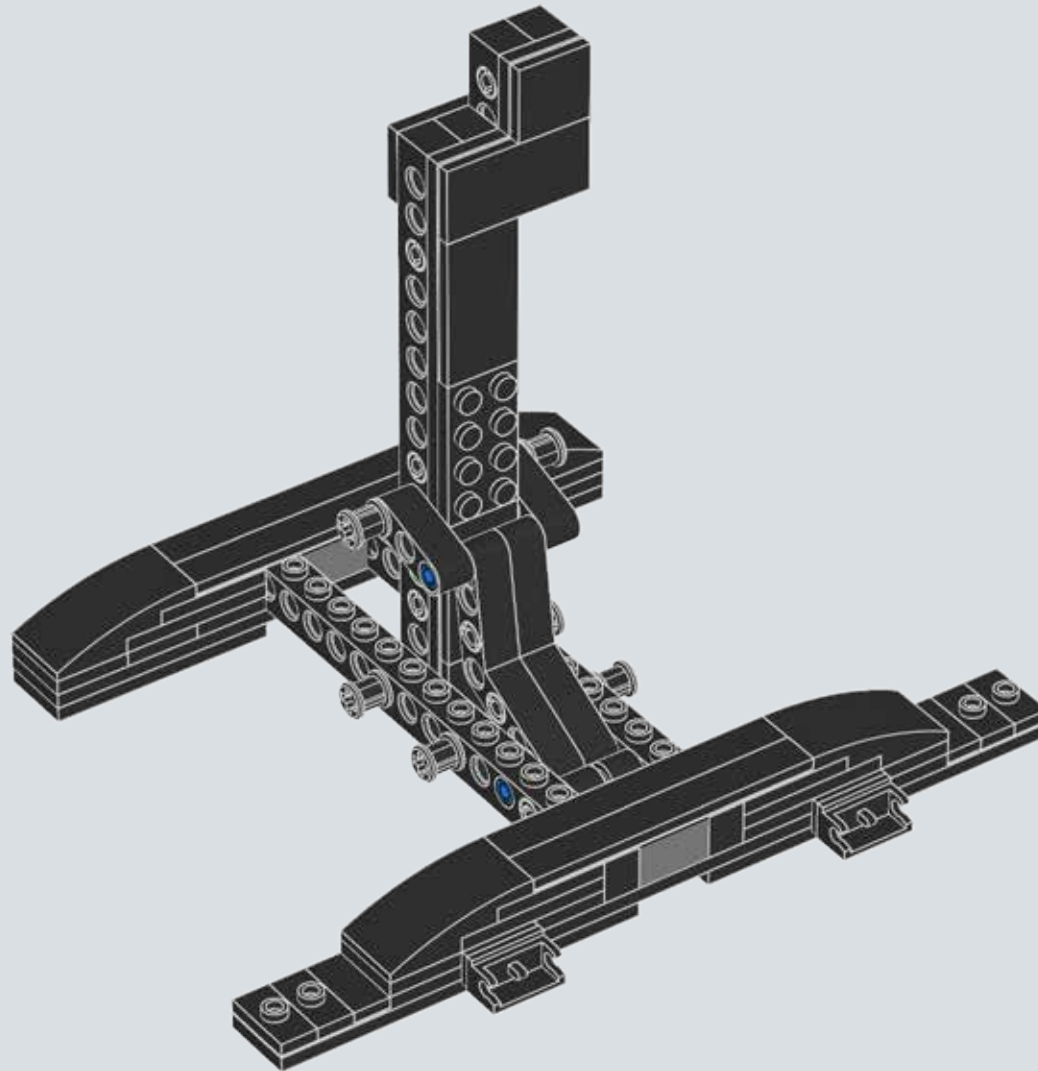

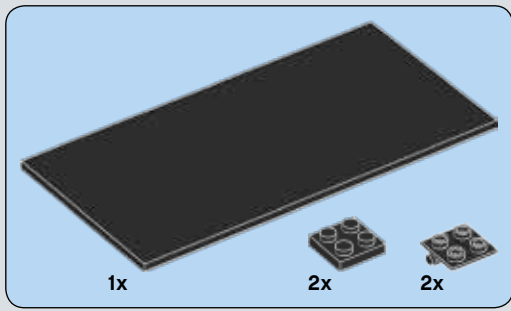

150

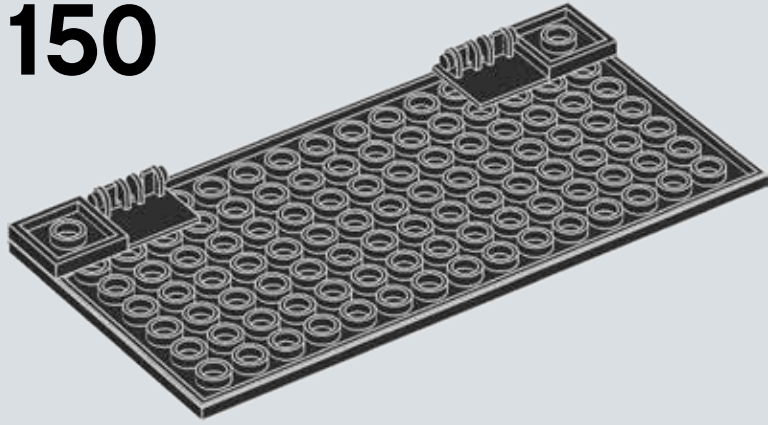

151

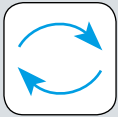

152

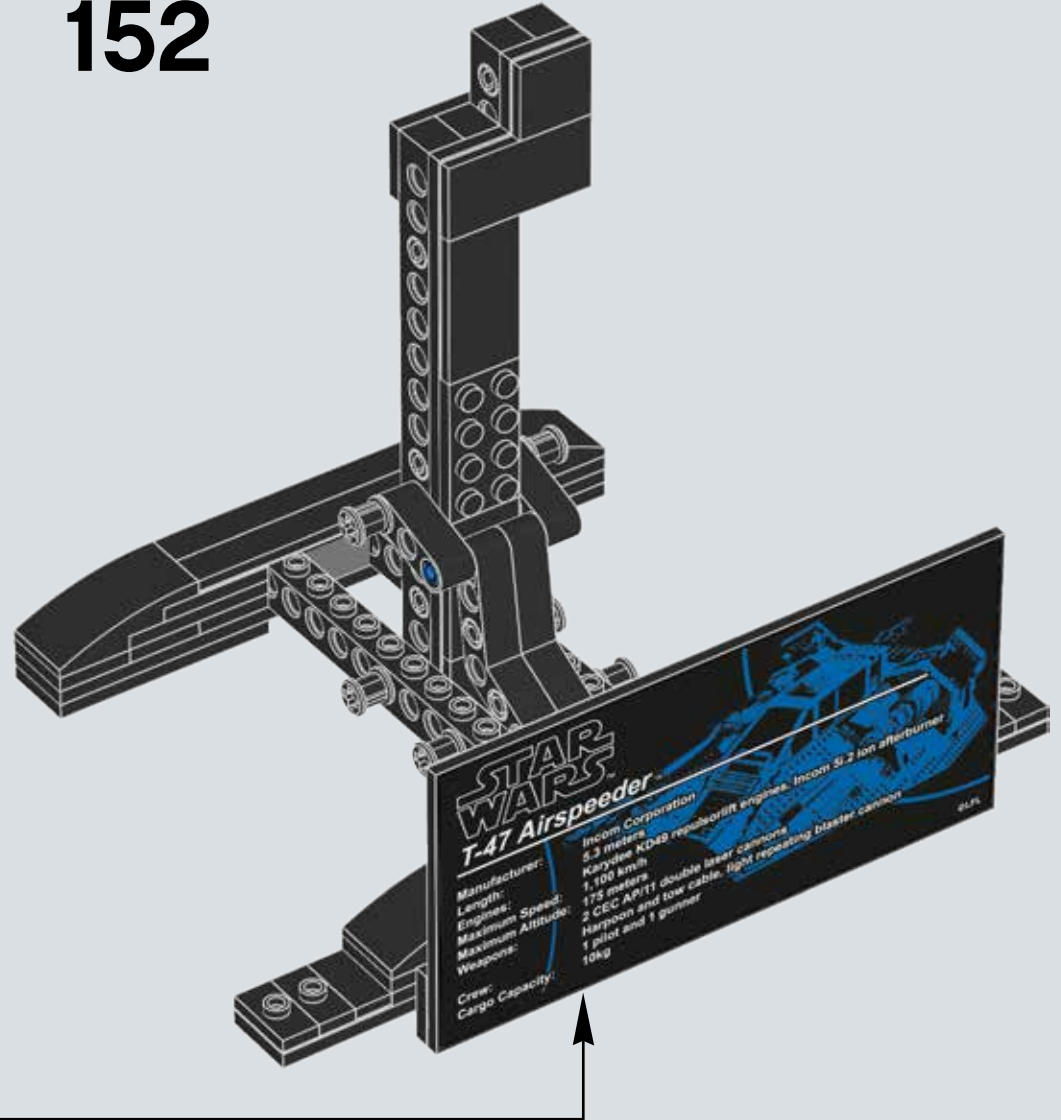

153

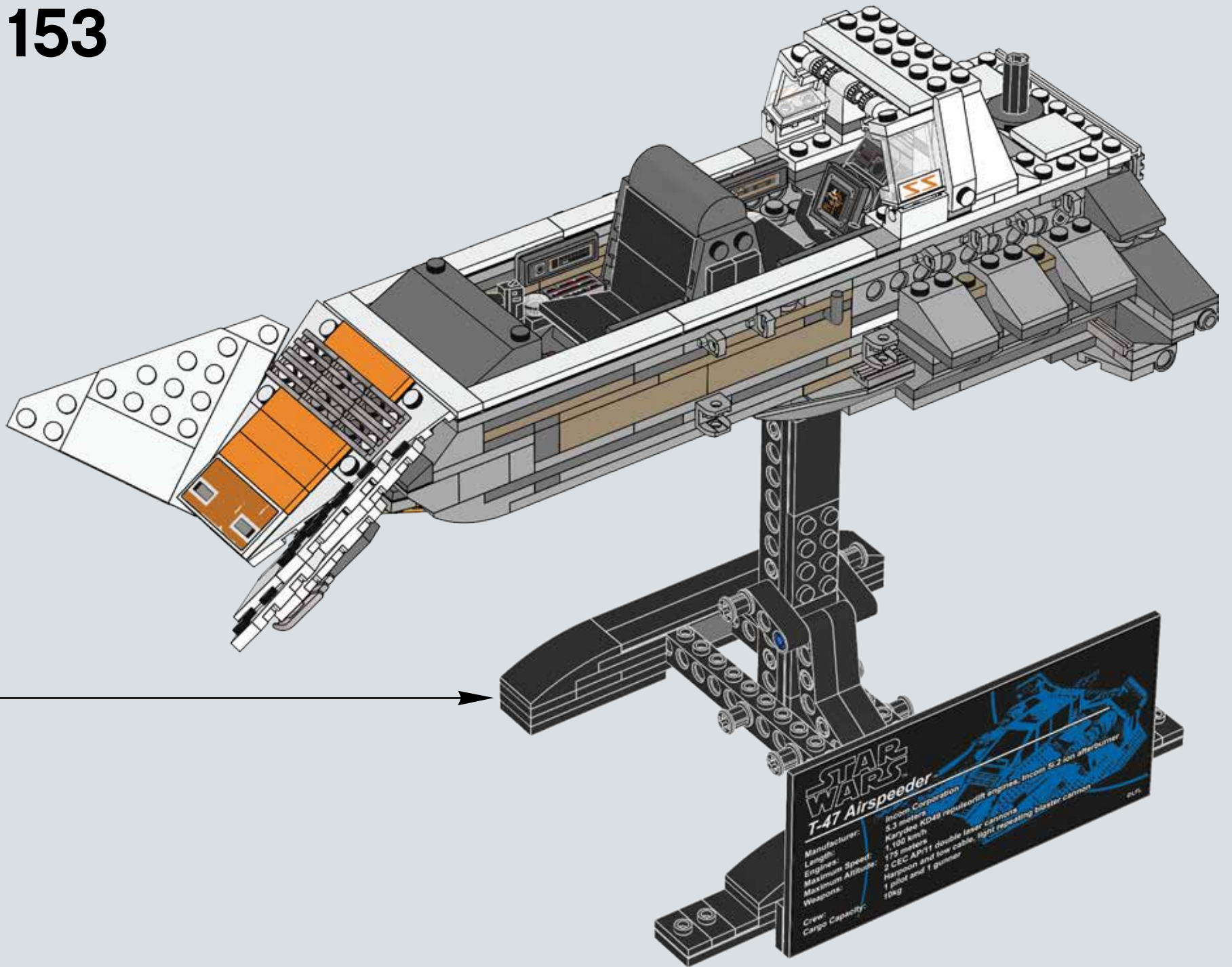

154

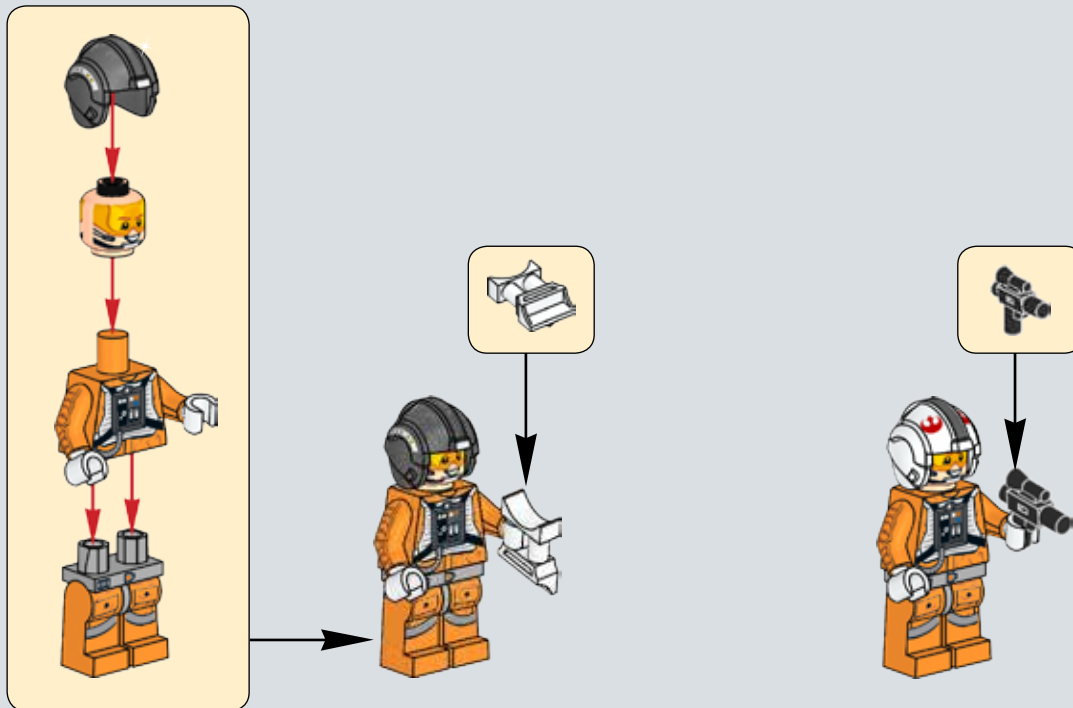

155

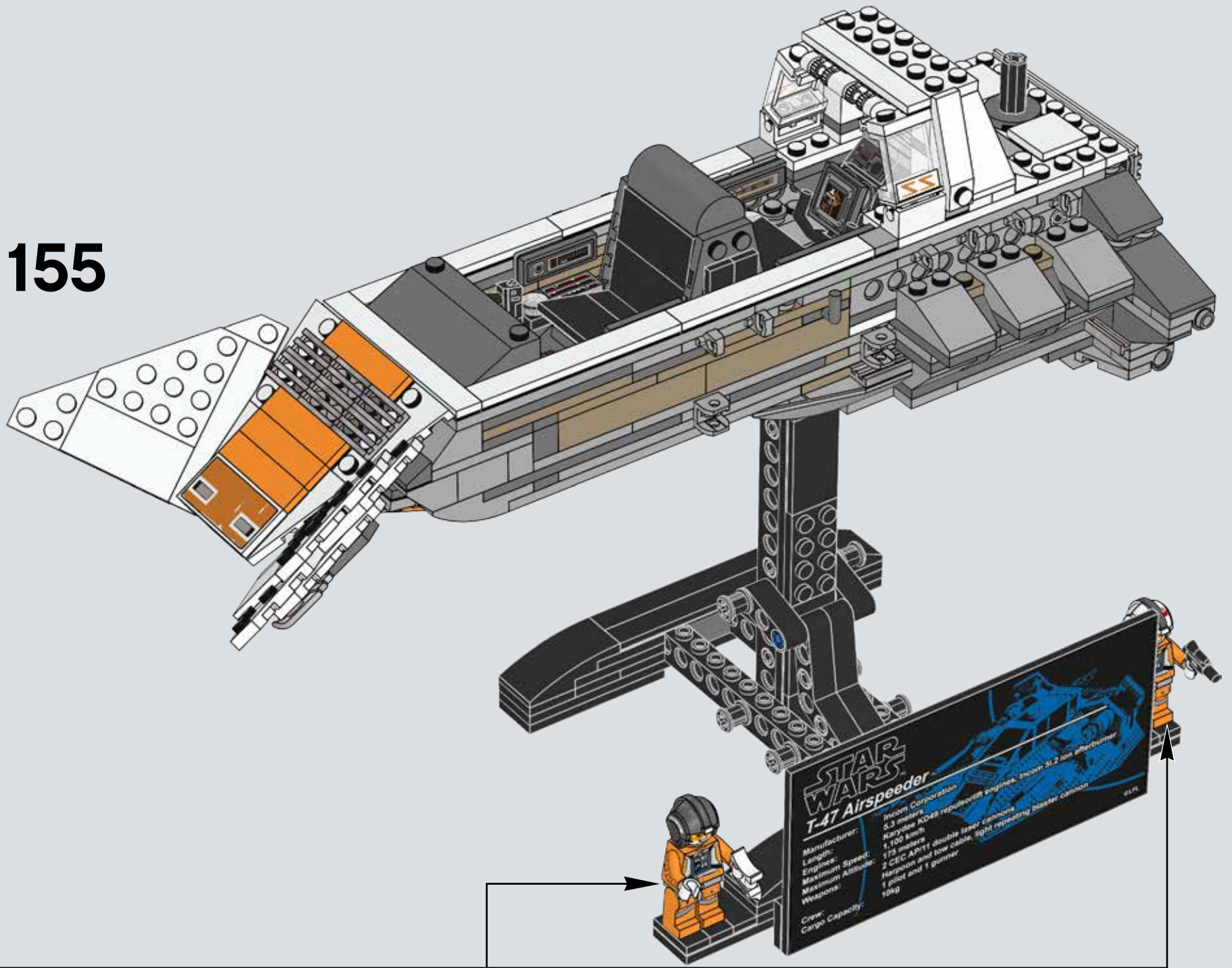

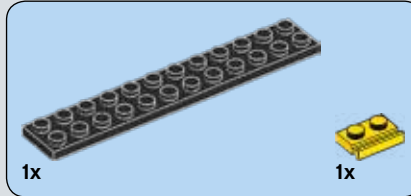
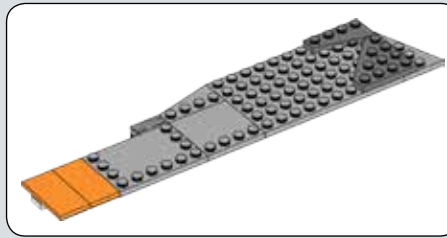
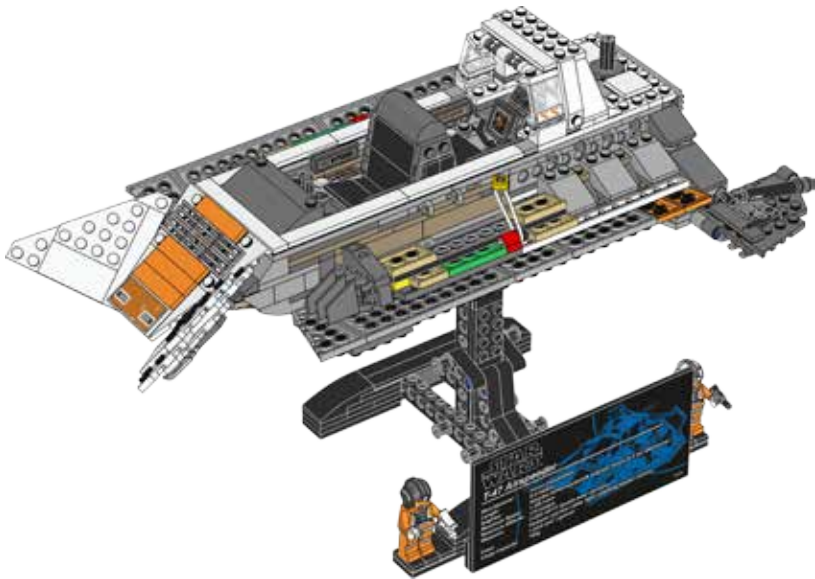

156

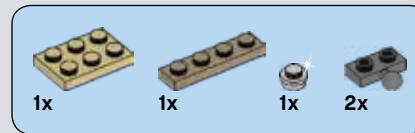
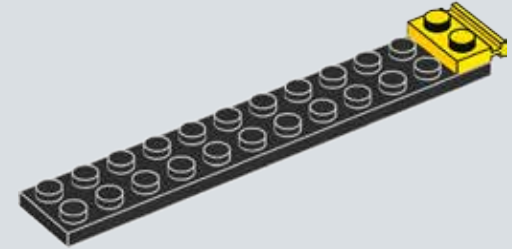

157

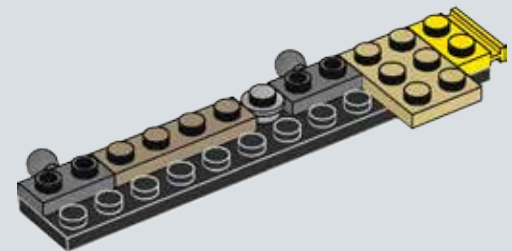



158

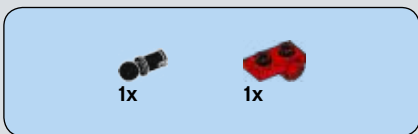
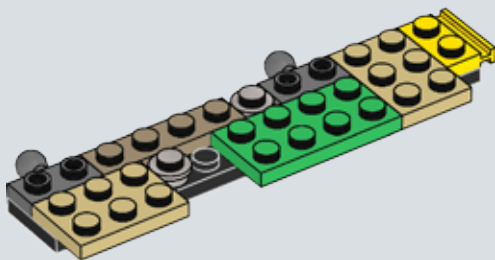

159

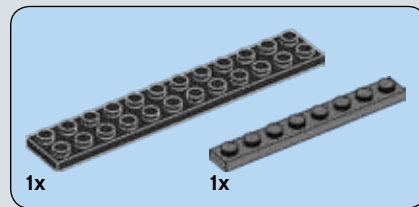
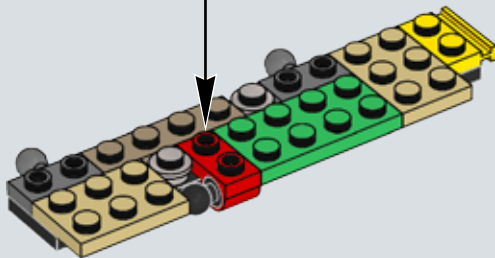
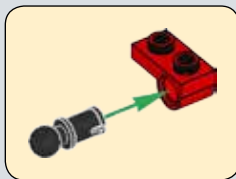

160

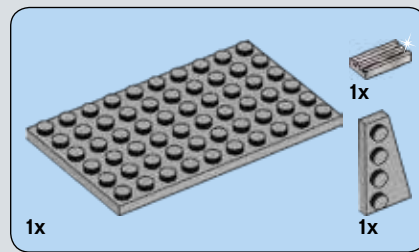
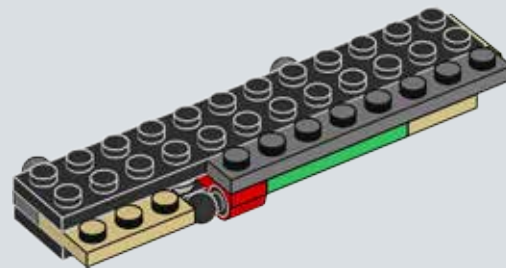

161

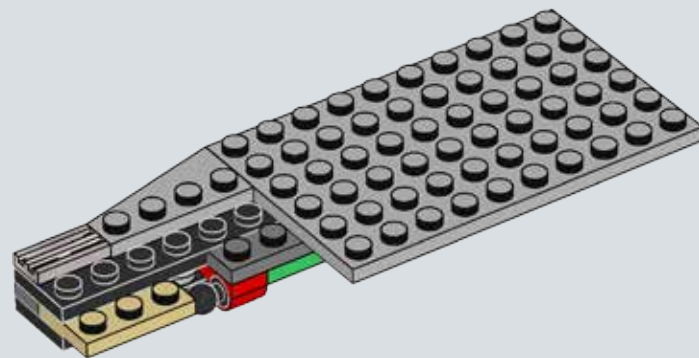

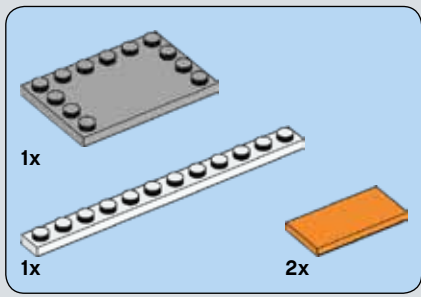

162

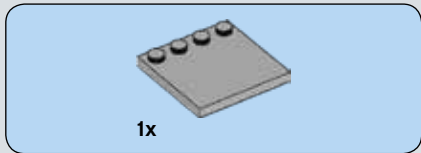
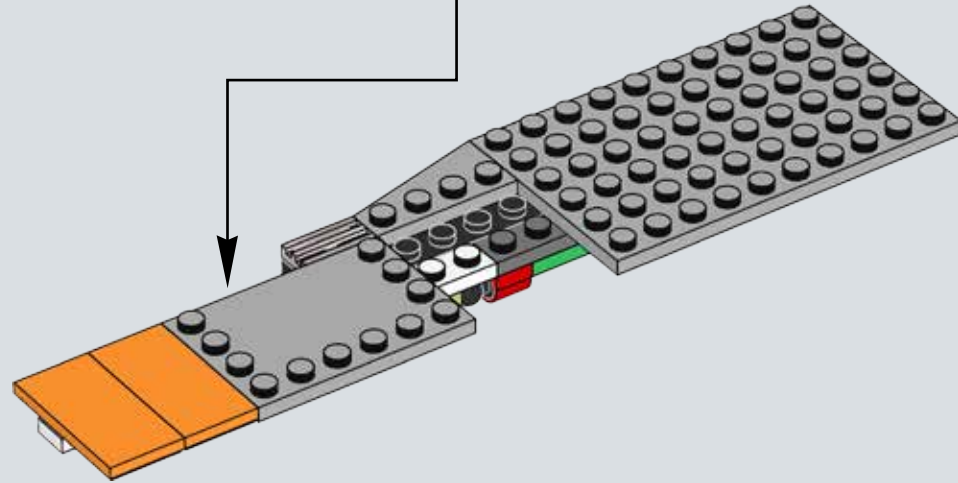
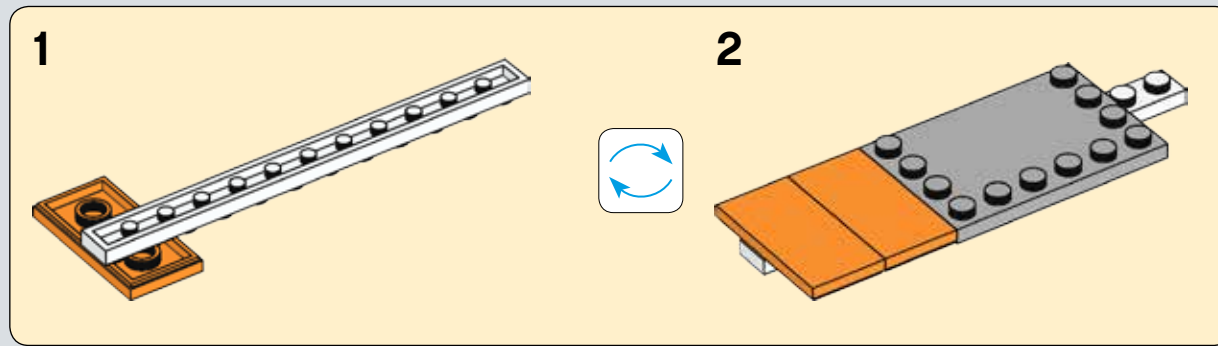

163

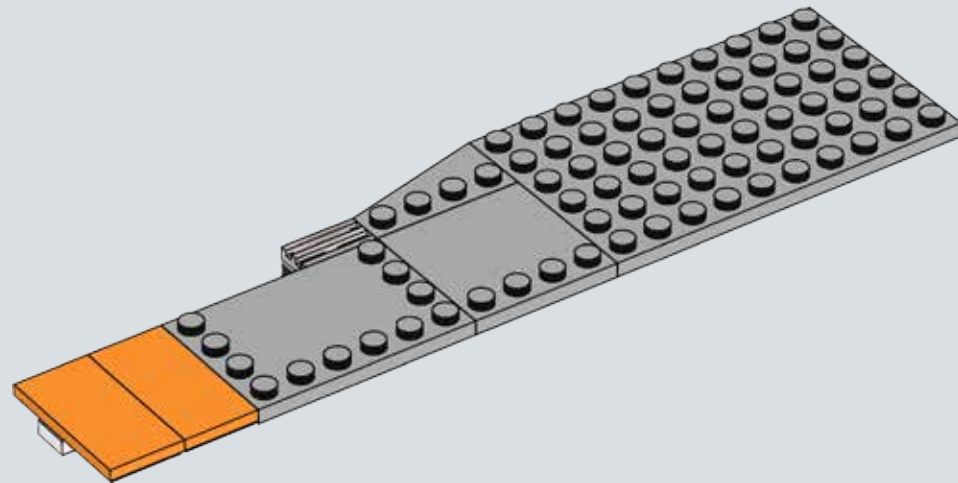

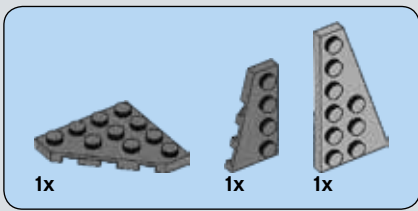

164

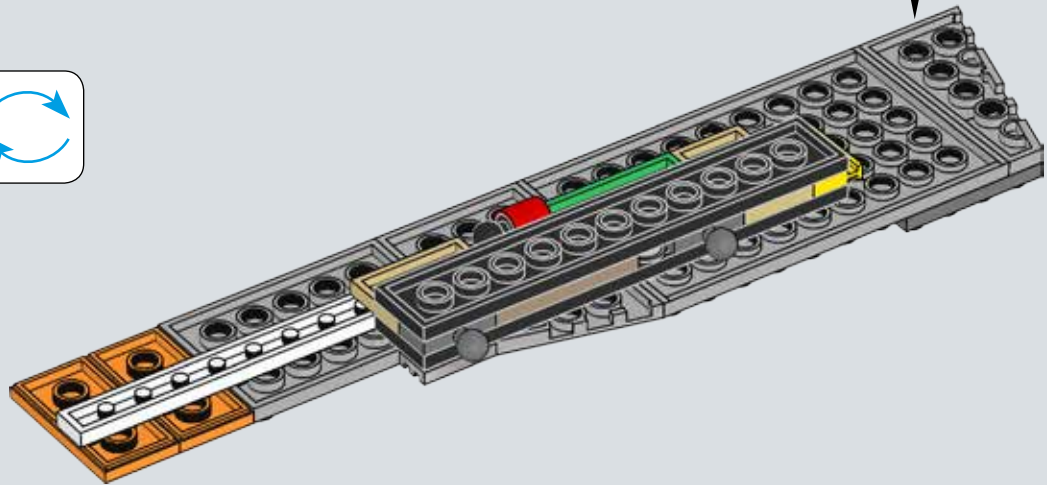
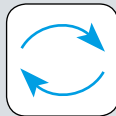
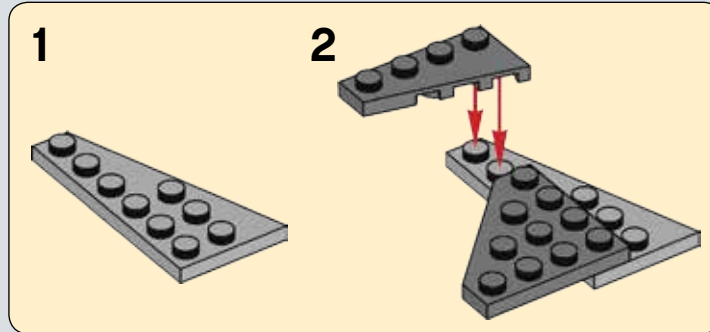

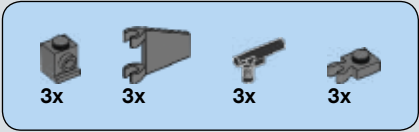

165

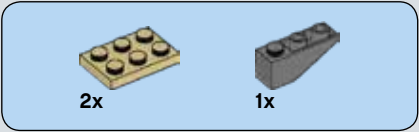
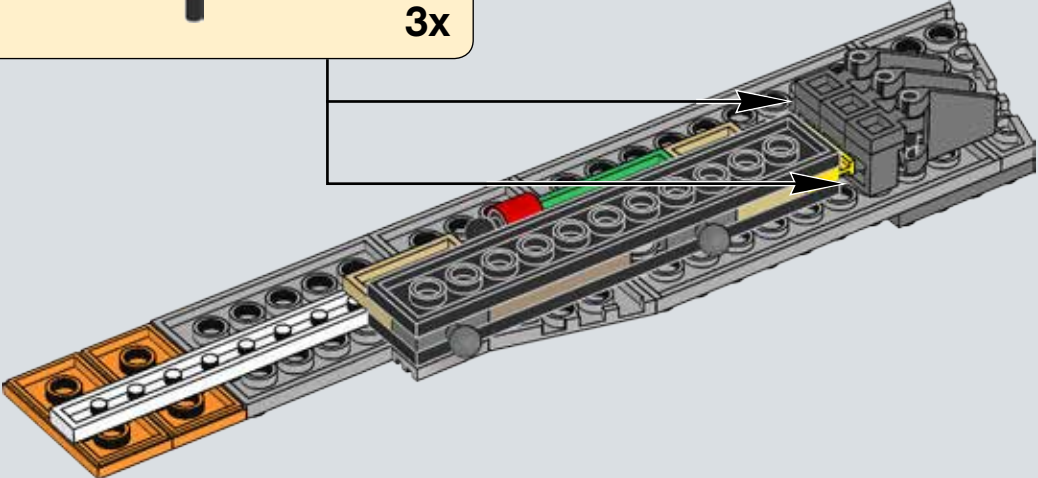
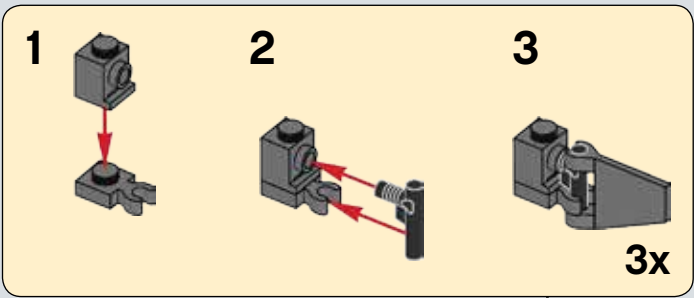

166

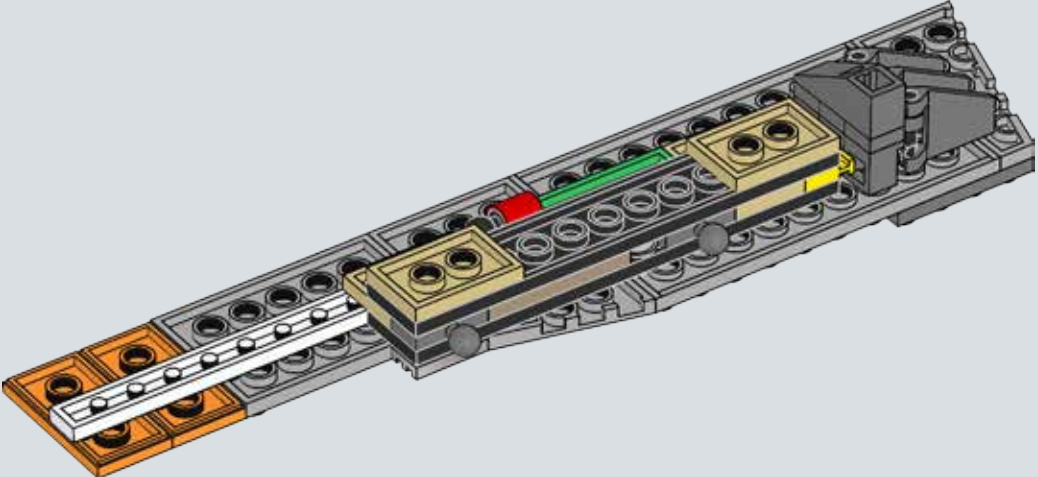

167

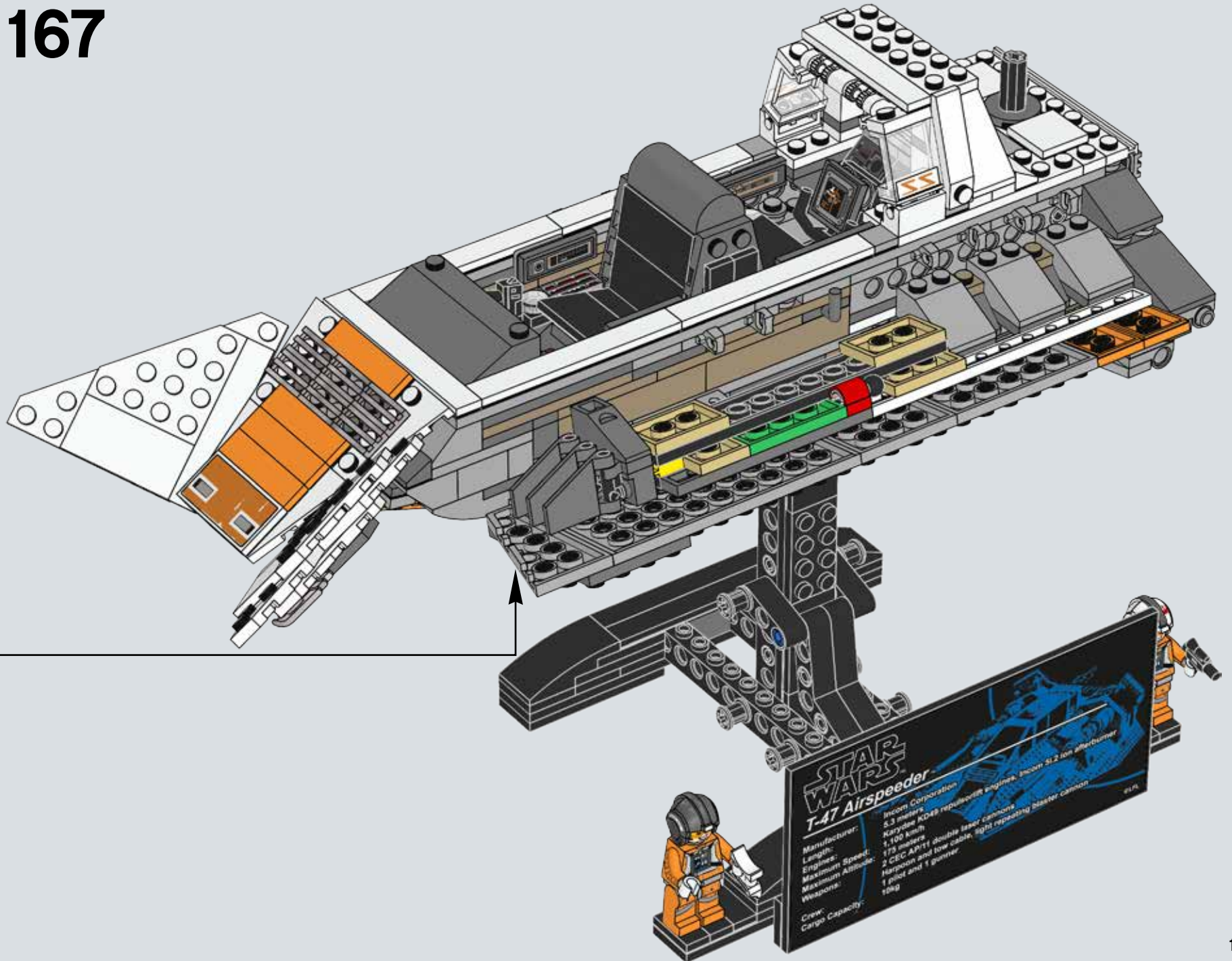

1x  1x 

168

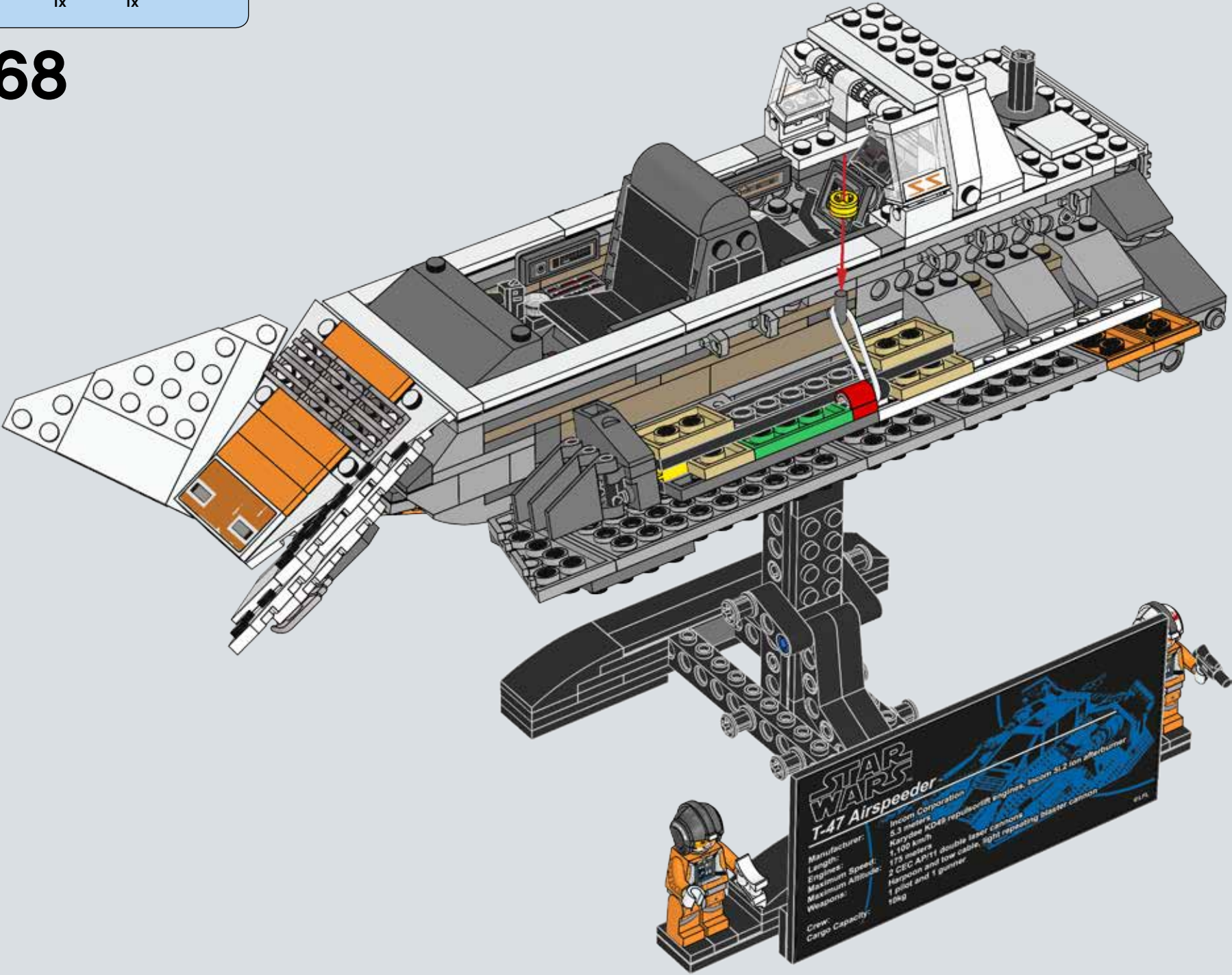

STAR WARS
T-47 Airspeeder

Manufacturer:	Incom Corporation
Length:	5.3 meters
Engines:	Karydee KD49 repulsorlift engines, Incom SL2 ion afterburner
Maximum Speed:	1,100 km/h
Maximum Altitude:	170 meters
Weapons:	2 GEC AP/11 double laser cannons Harpoon and tow cable, light repeating blaster cannon
Crew:	1 pilot and 1 gunner
Cargo Capacity:	10kg

© LFL

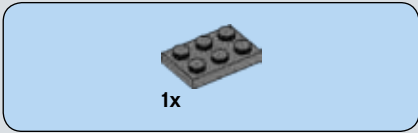

169

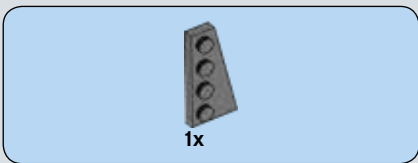
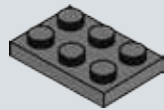

170

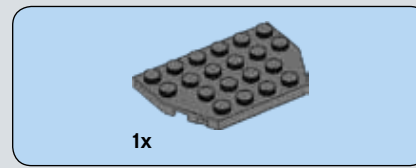
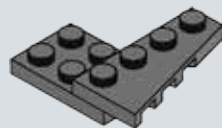

171

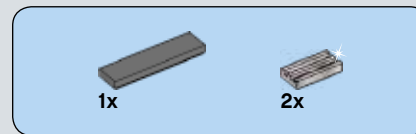
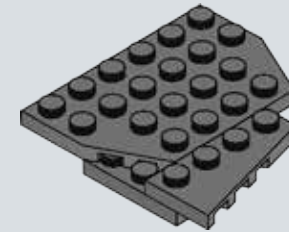

172

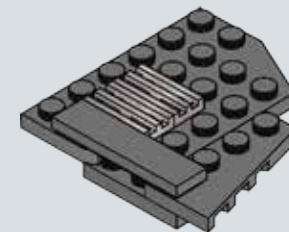

3x

173



174

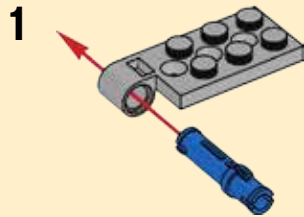
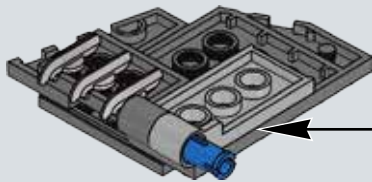

1x



1x

175

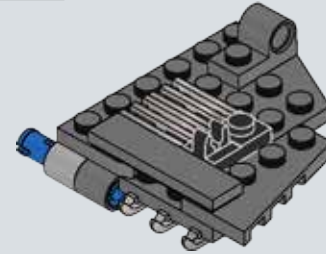
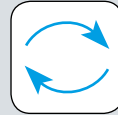

1x

1x

1x

176

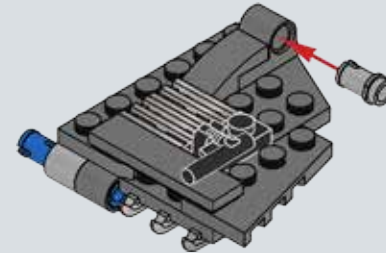

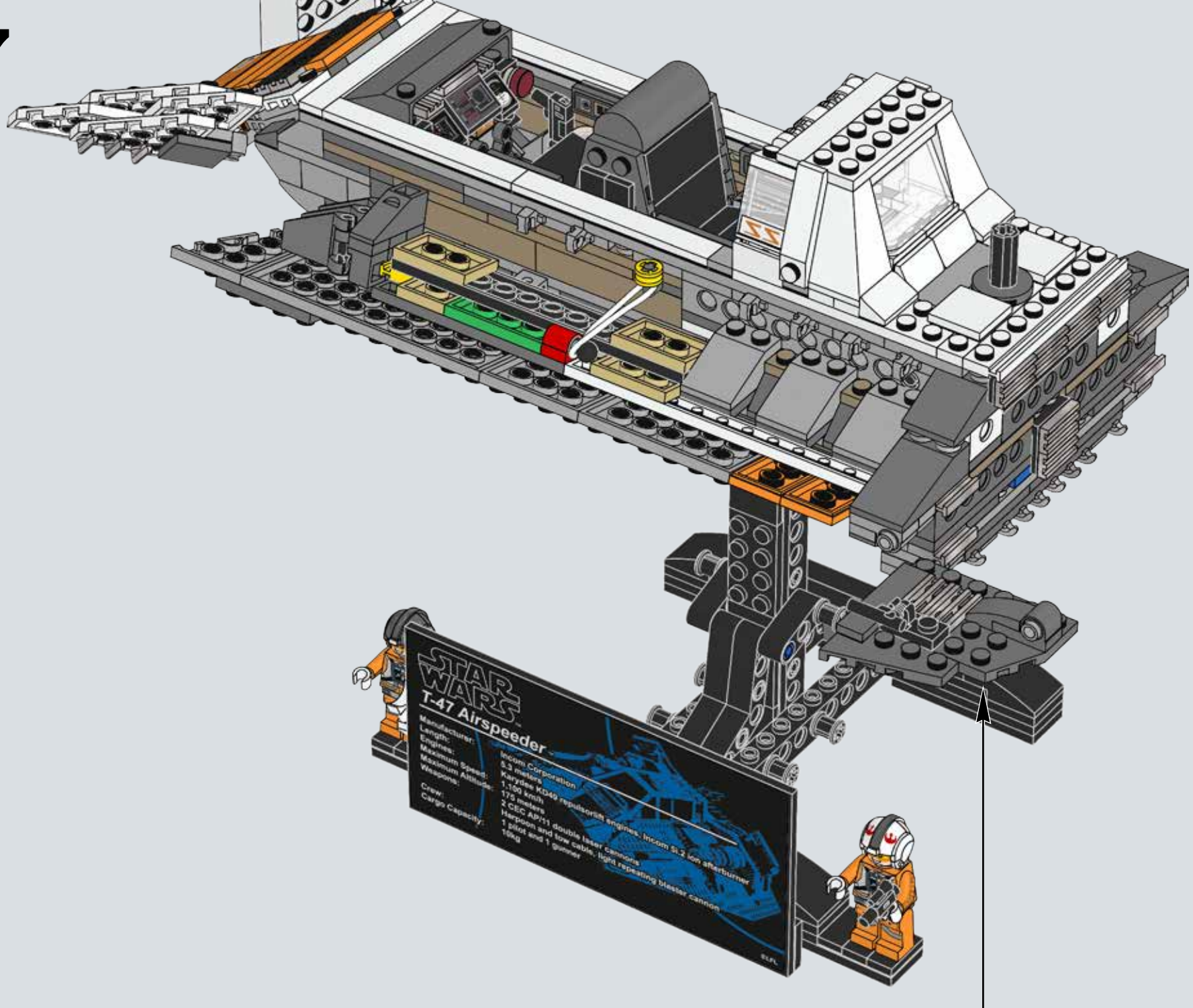

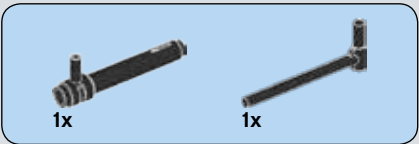

178

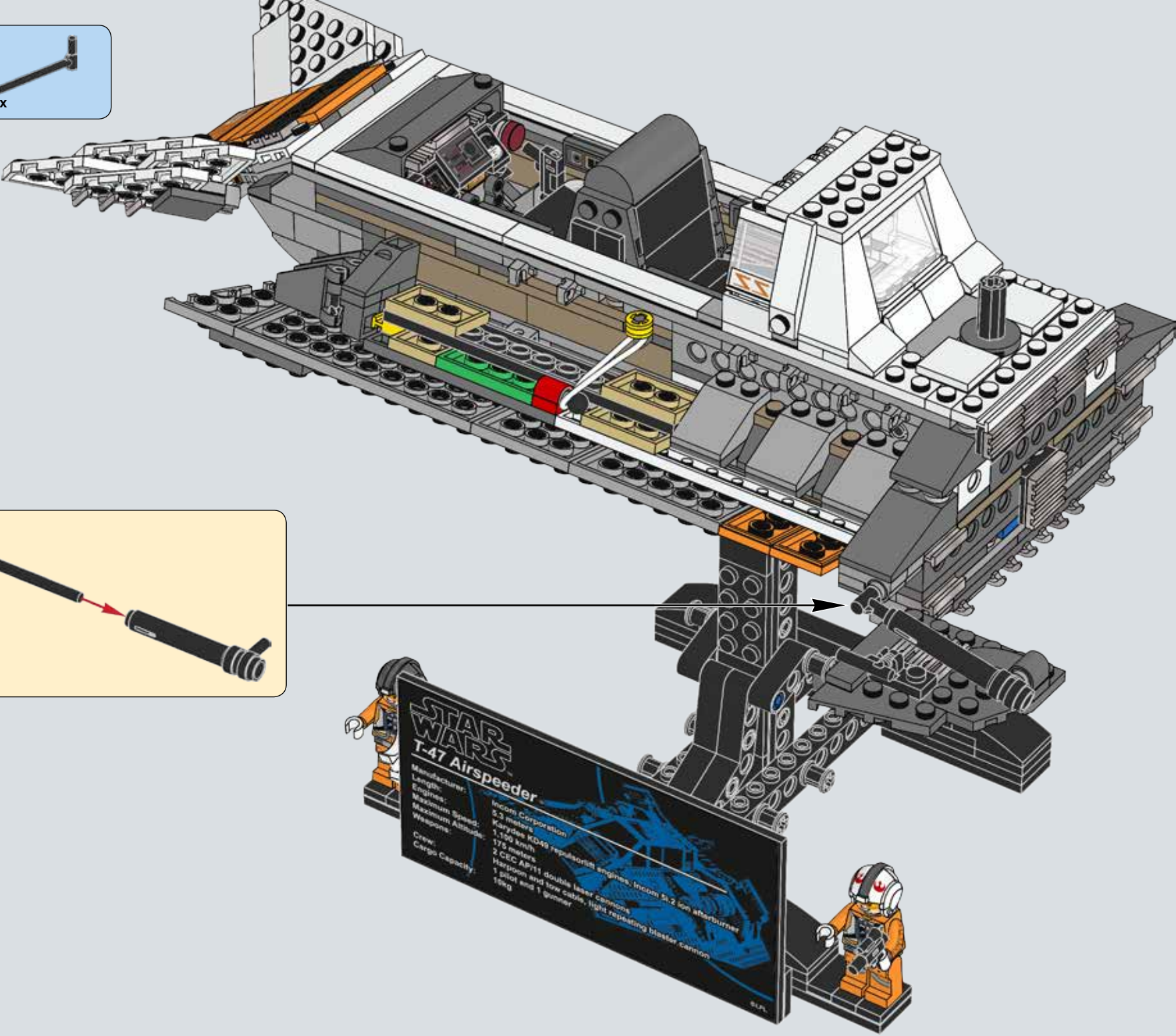

STAR WARS
T-47 Airspeeder

Manufacturer:	Incom Corporation
Length:	5.3 meters
Maximum Speed:	Karydek KD40 repulsorjet engines, Incom S1-2 ion afterburner
Maximum Altitude:	1,100 kmh
Weapons:	174 meters
Crew:	2 CEC AP11 double laser cannons
Cargo Capacity:	Harpoon and tow cable, light repeating blaster cannon
	1 pilot and 1 gunner
	16kg

S.P.A.

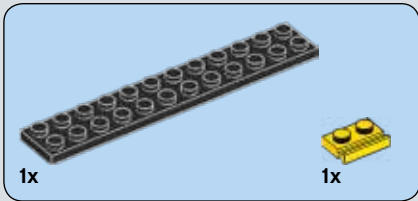
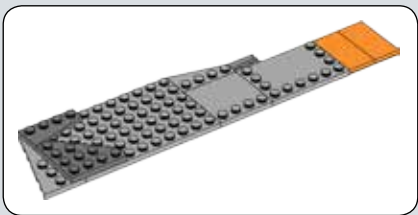

179

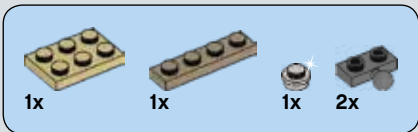
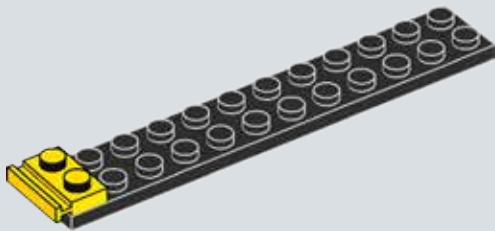

180

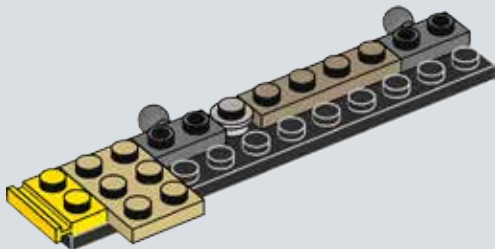

181

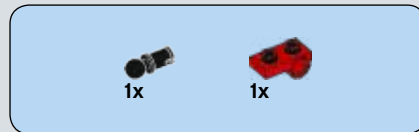
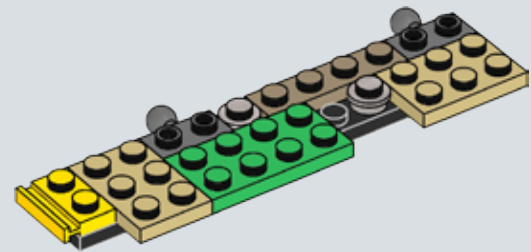

182

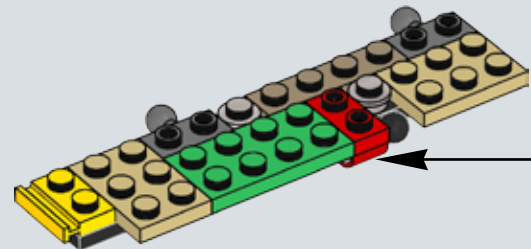
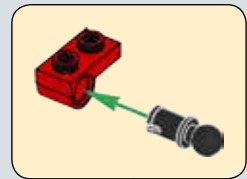

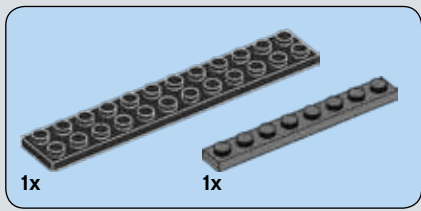

183

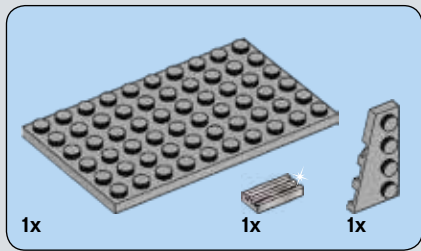
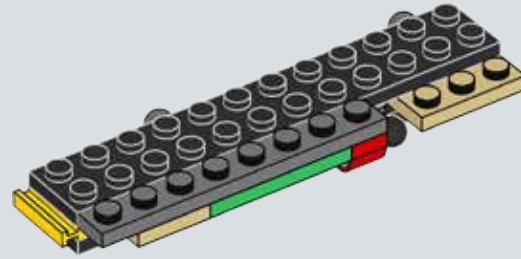

184

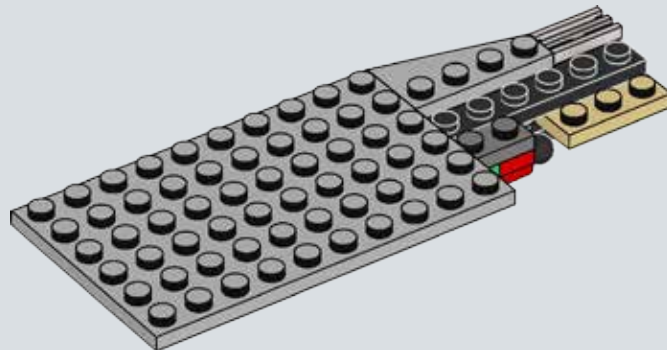

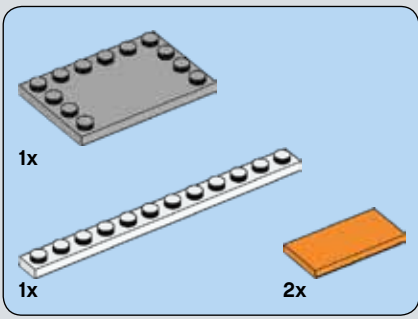

185

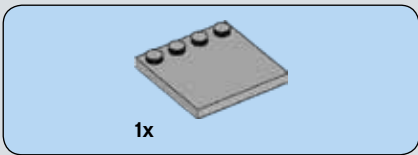
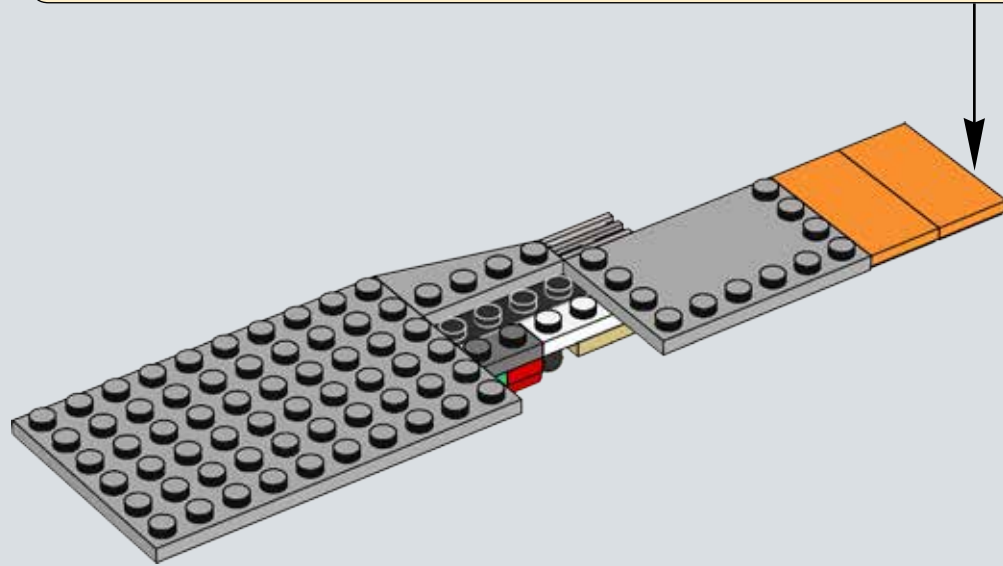
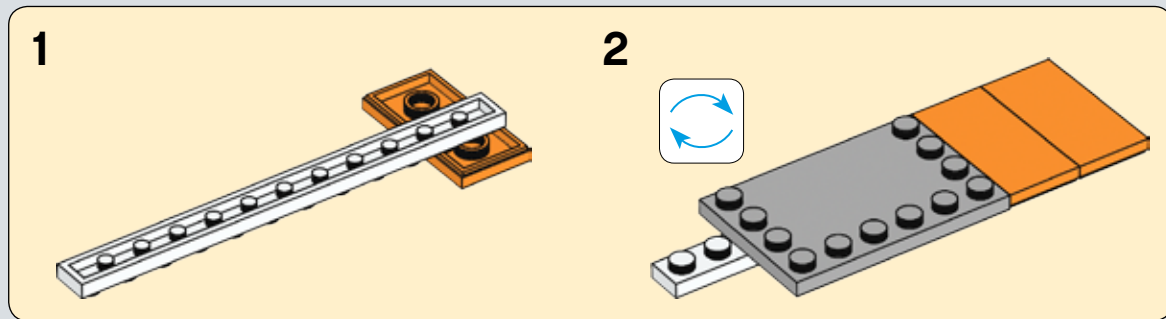

186

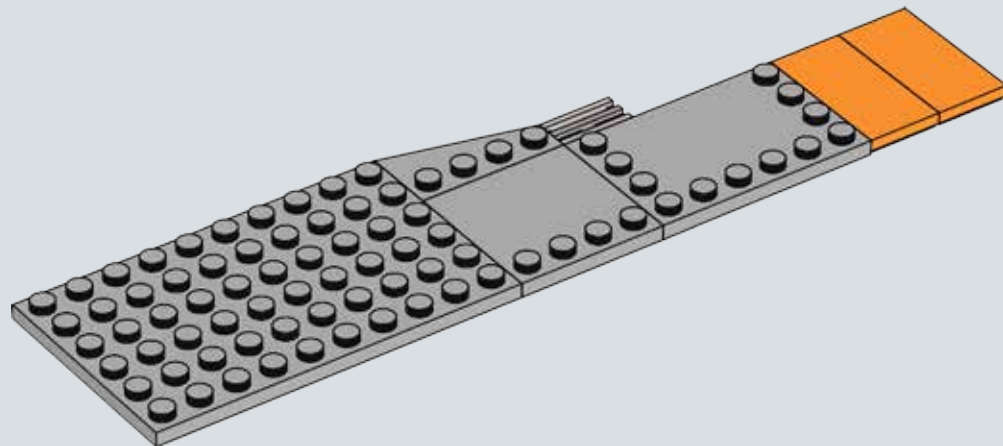

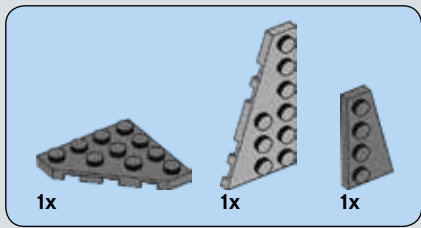

187

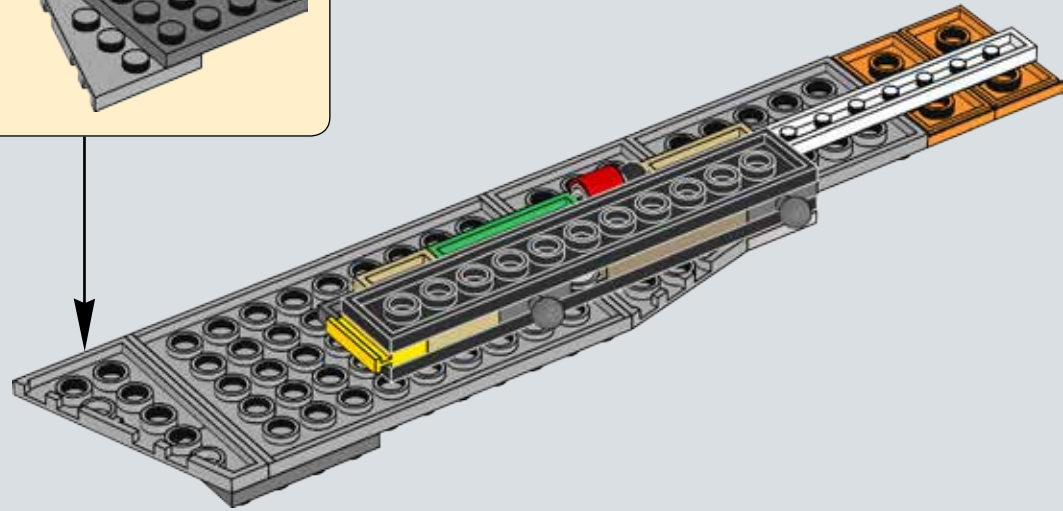
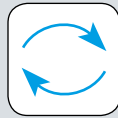
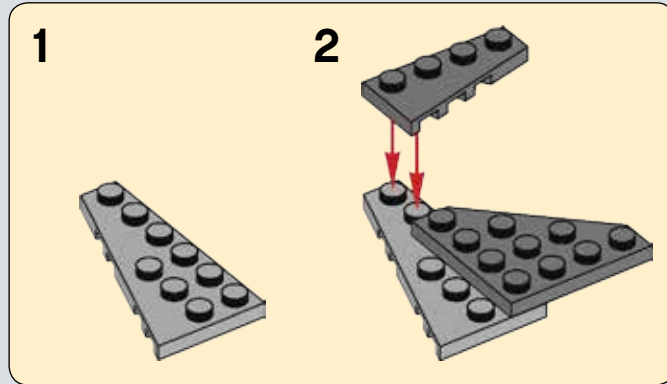

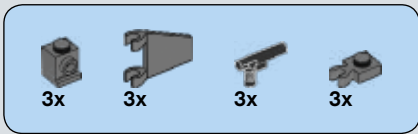

188

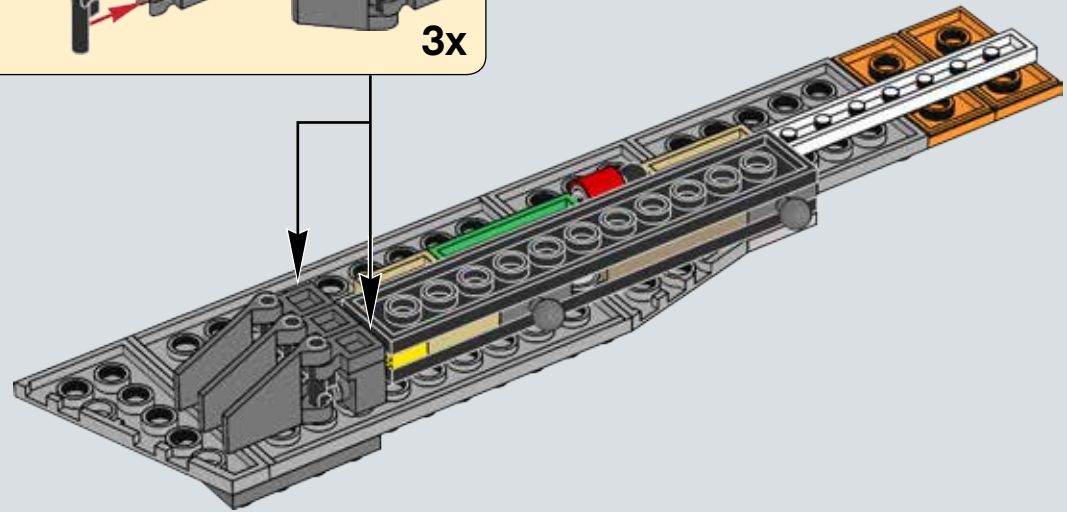
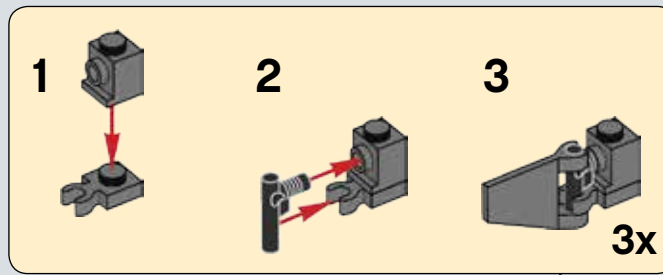

189

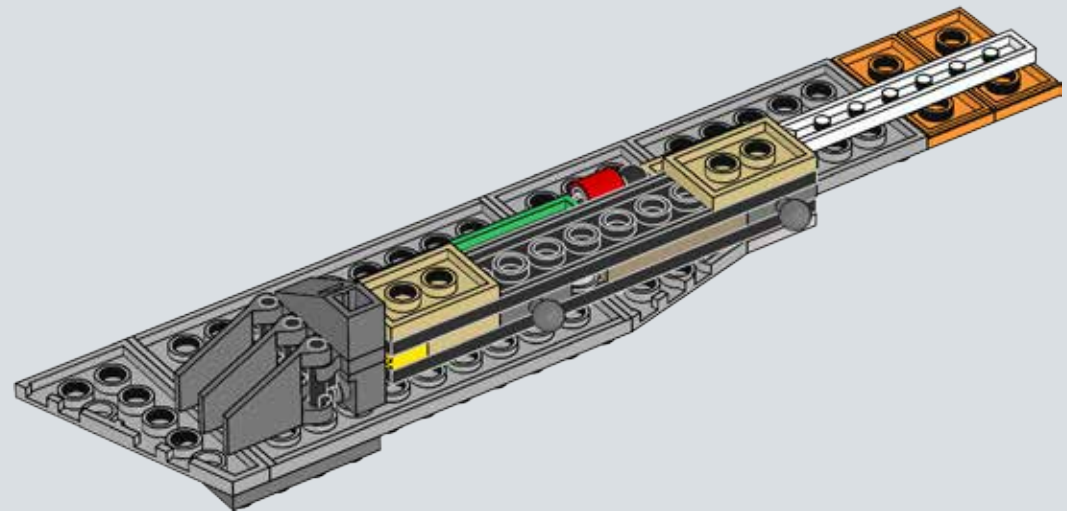

190

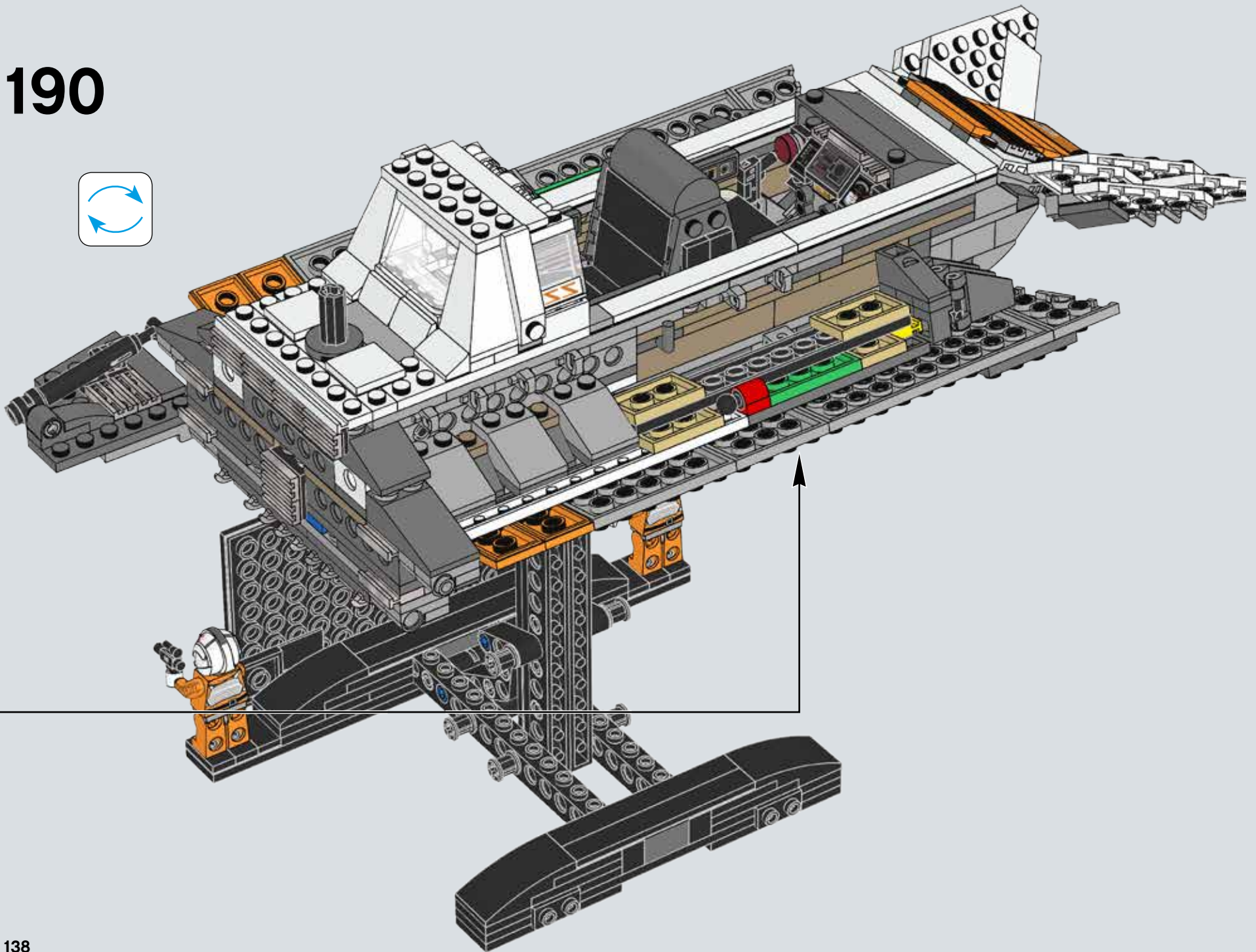

1x  1x 

191

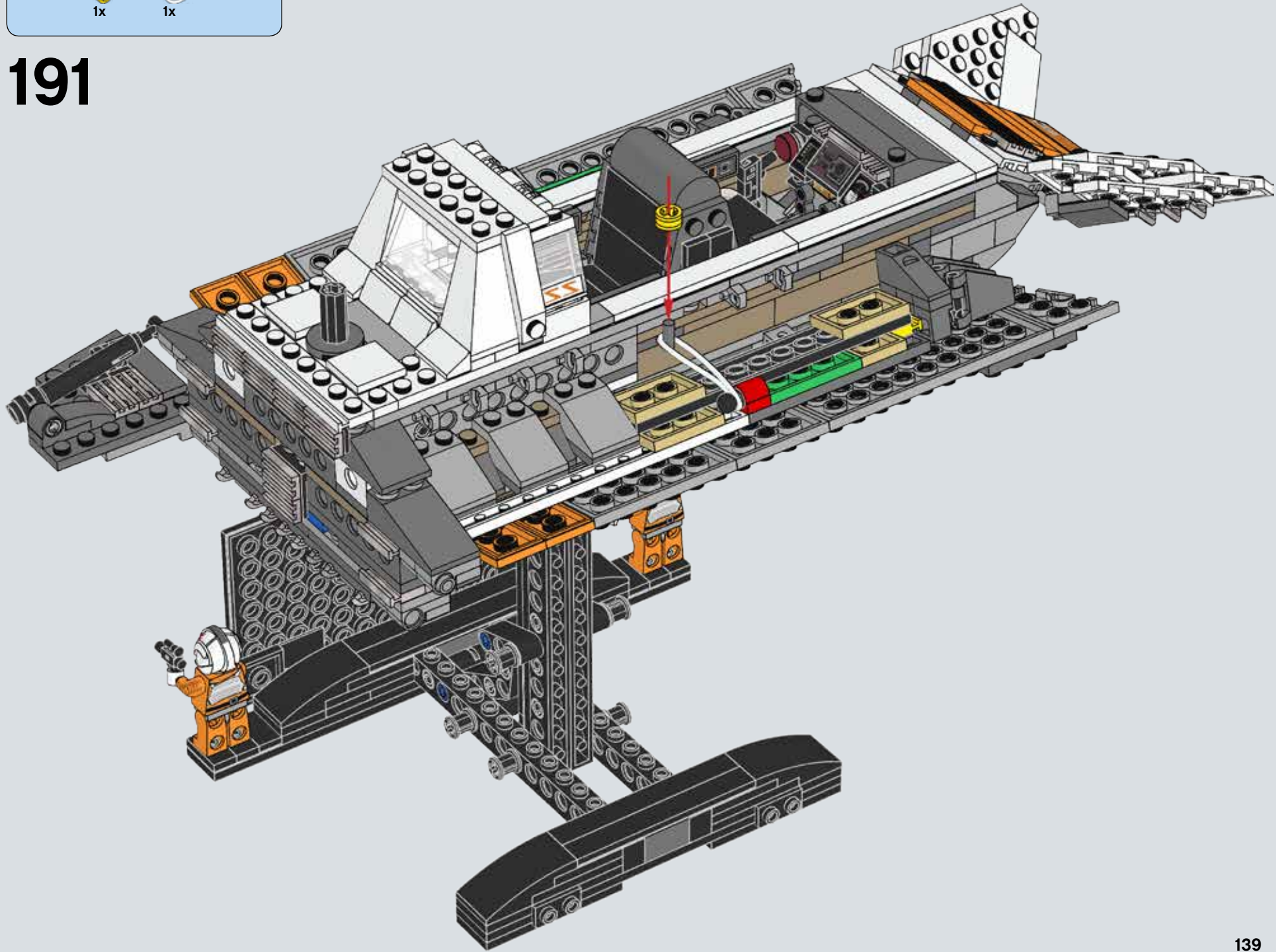



192

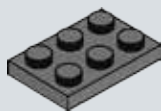

193

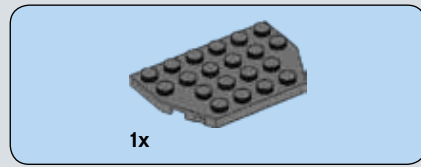
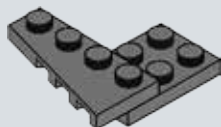

194

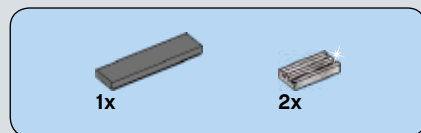
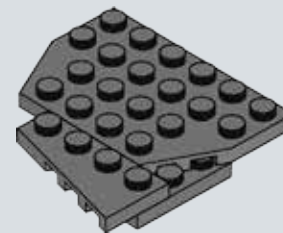

195

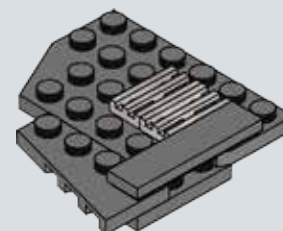

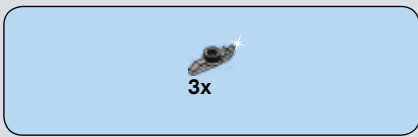

196

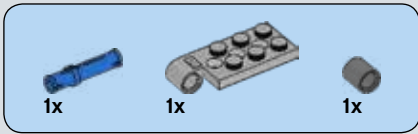
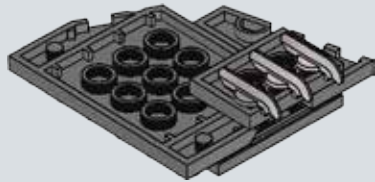
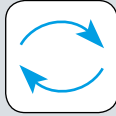

197

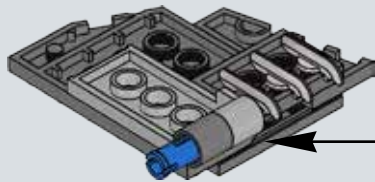
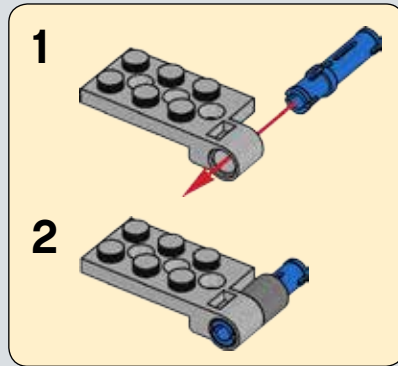

198

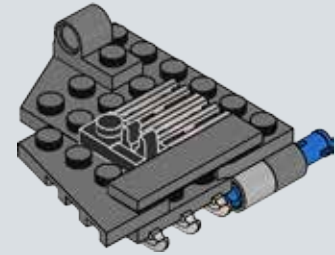
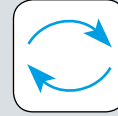

199

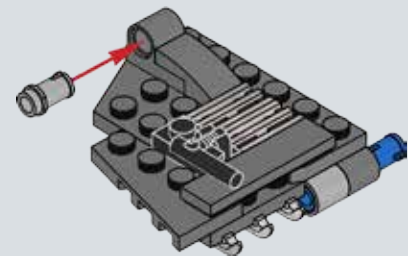

200

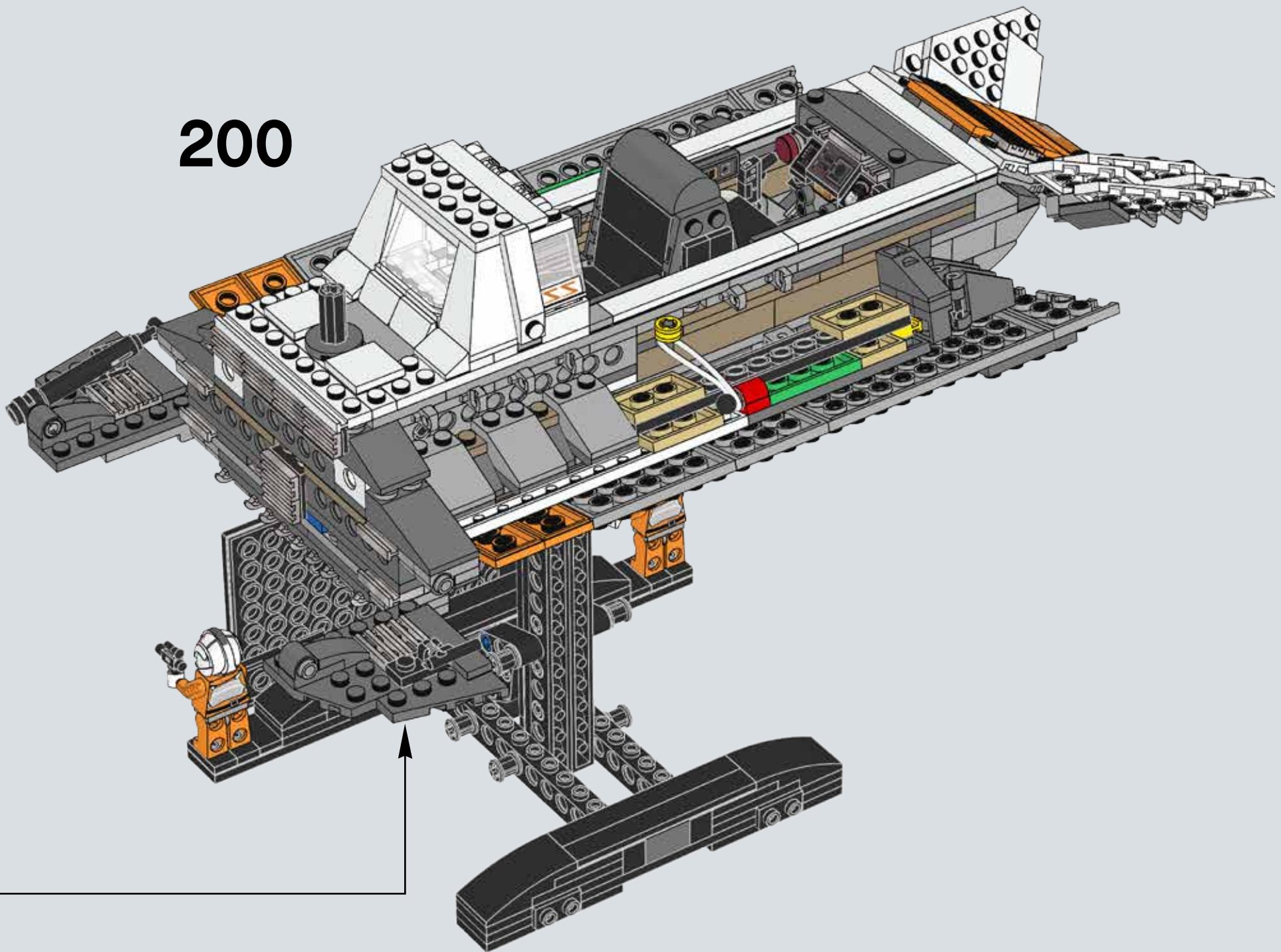

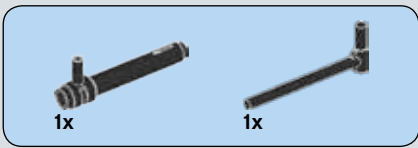

201

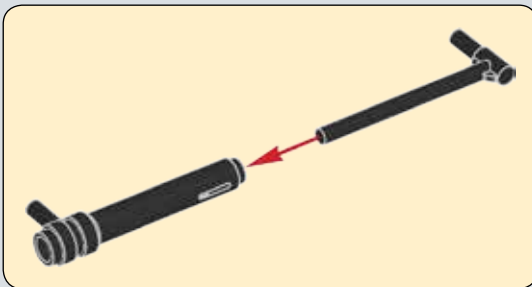
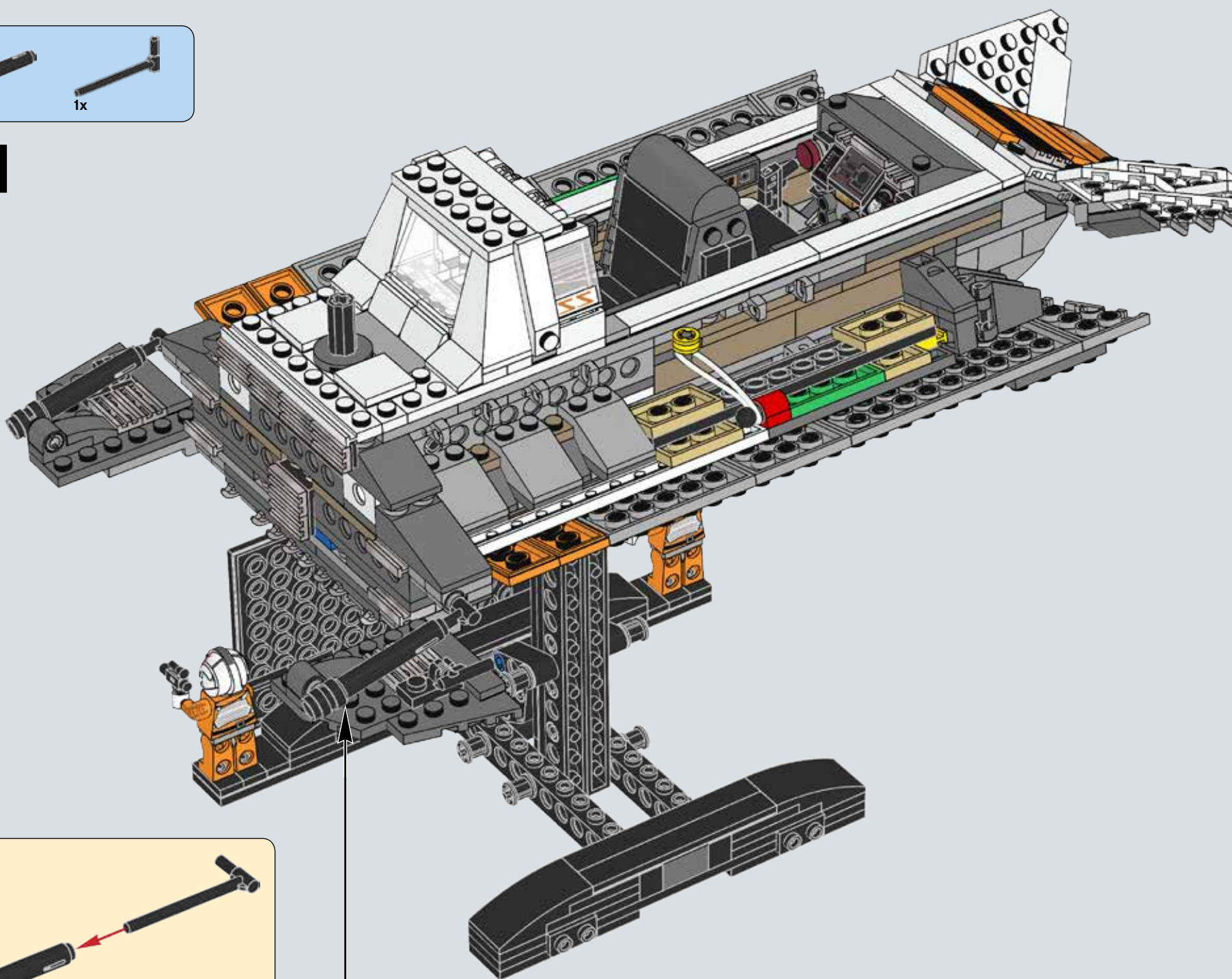

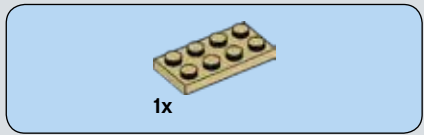
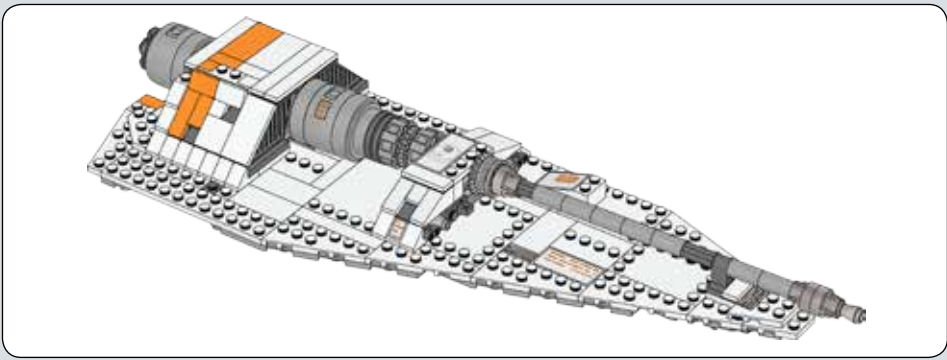

203

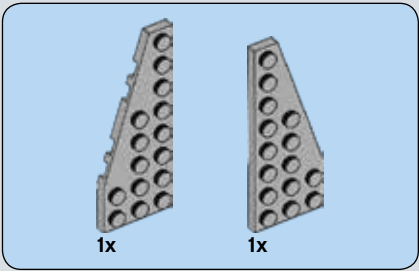
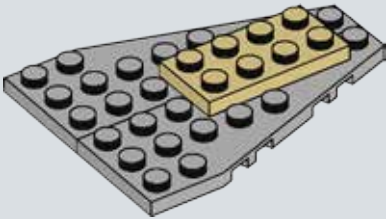
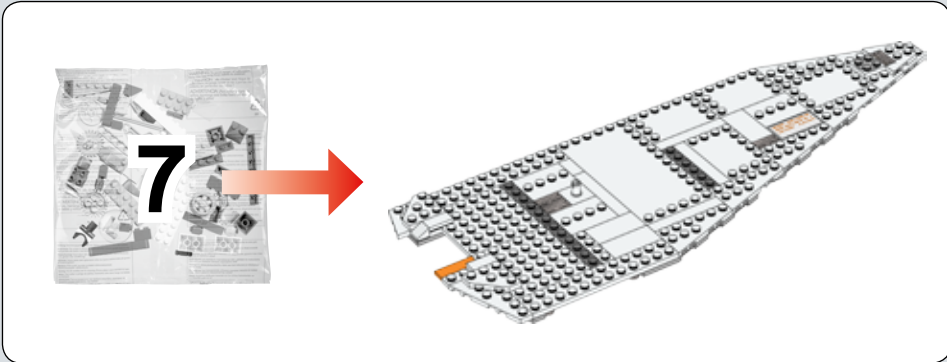

202

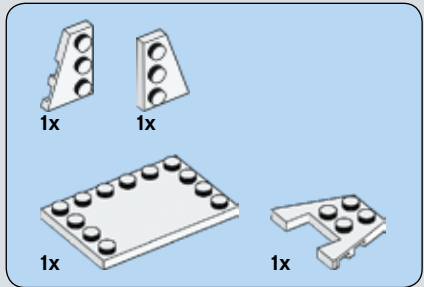
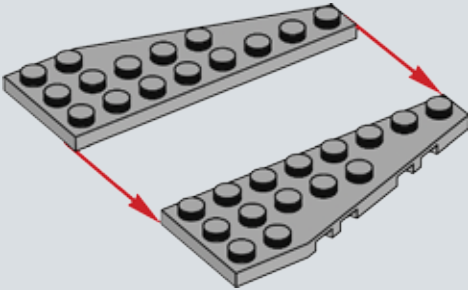

204

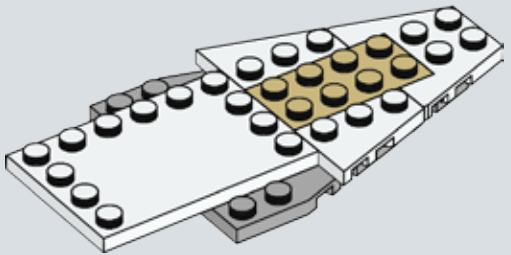

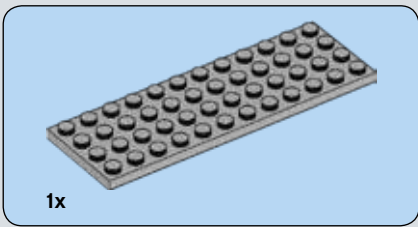

205

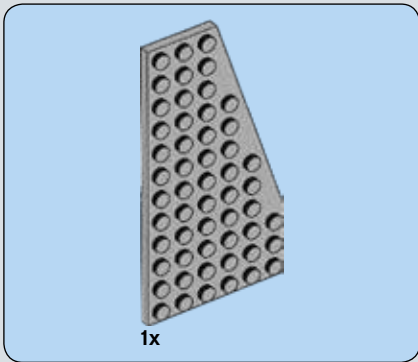
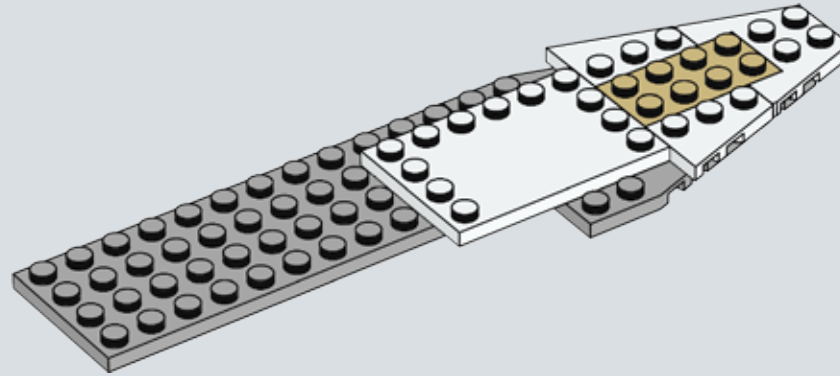

206

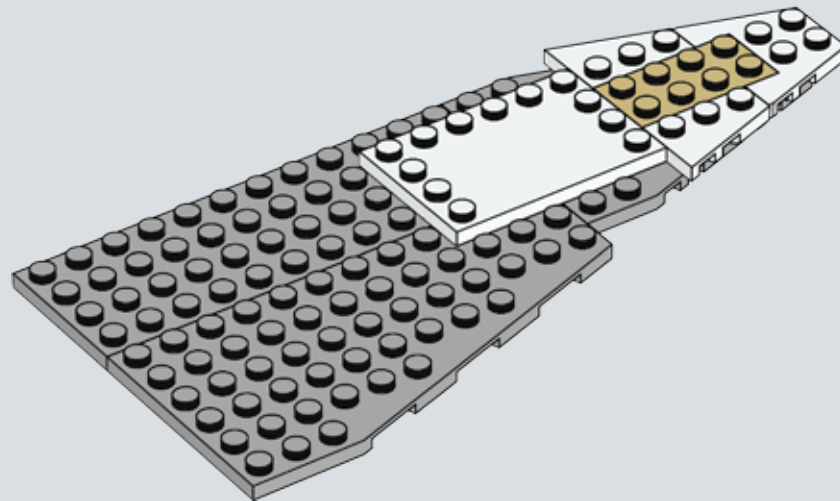

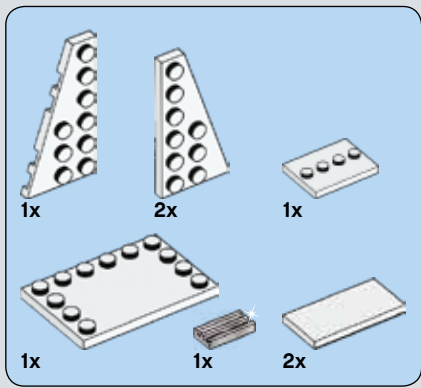

207

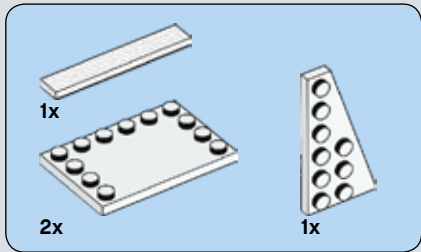
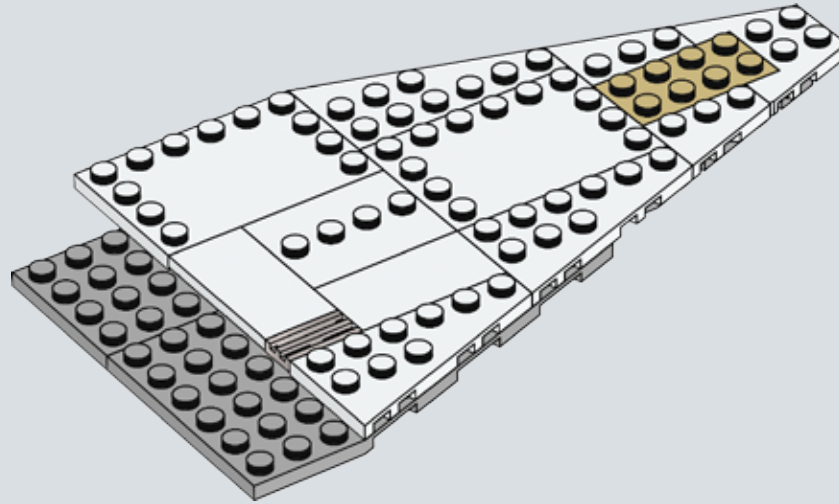

208

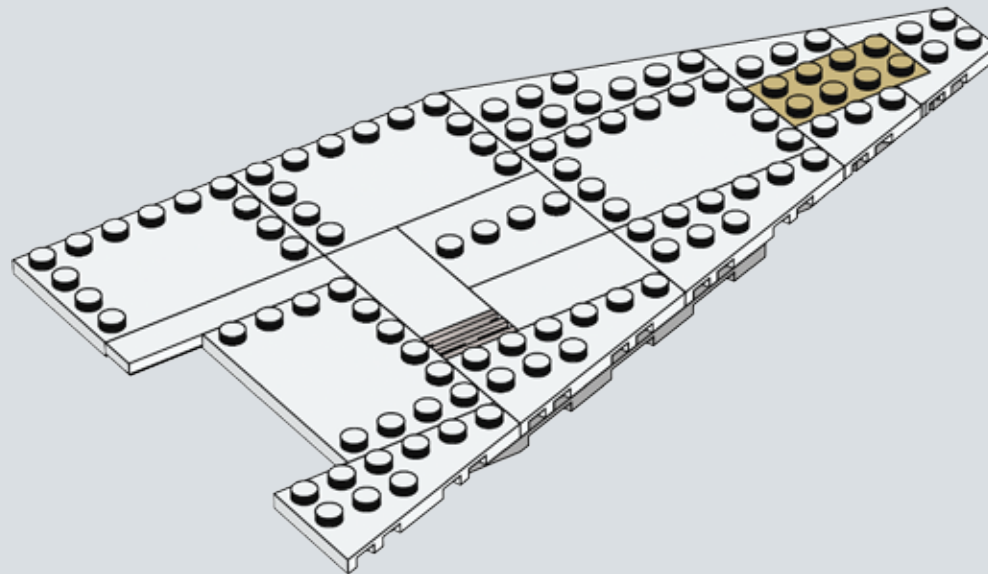

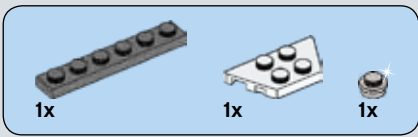

209

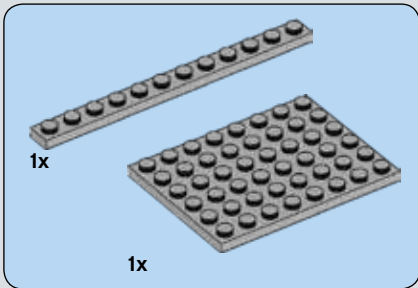
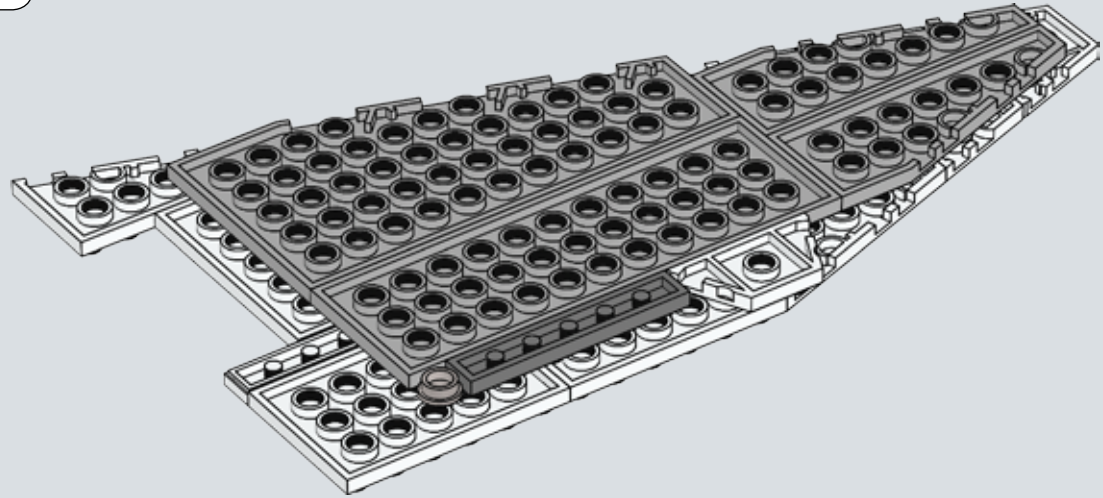
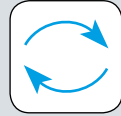

210

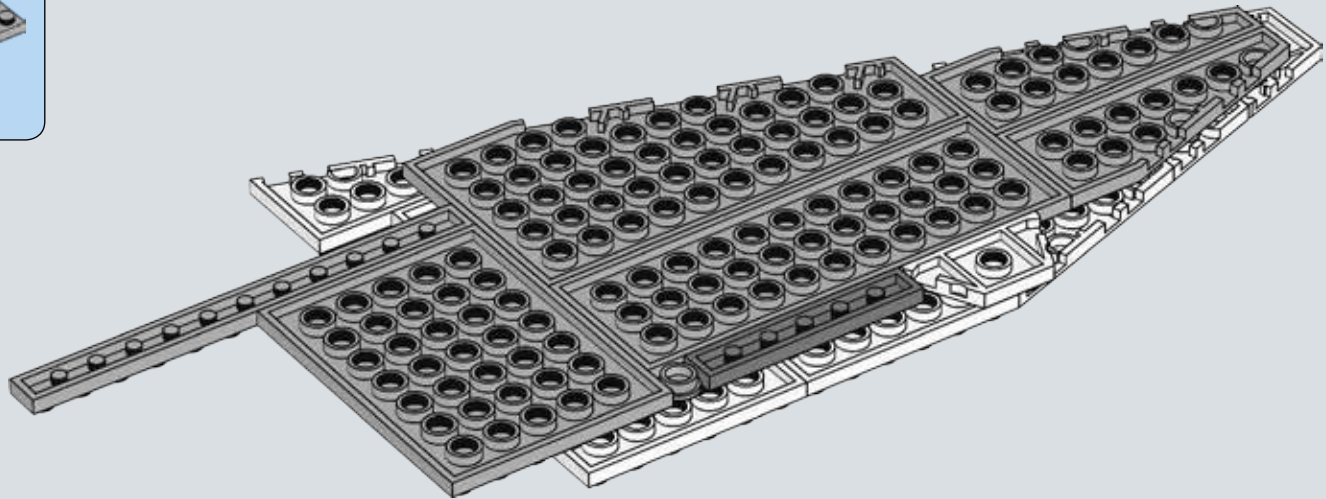

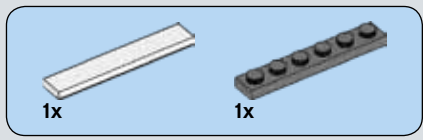

211

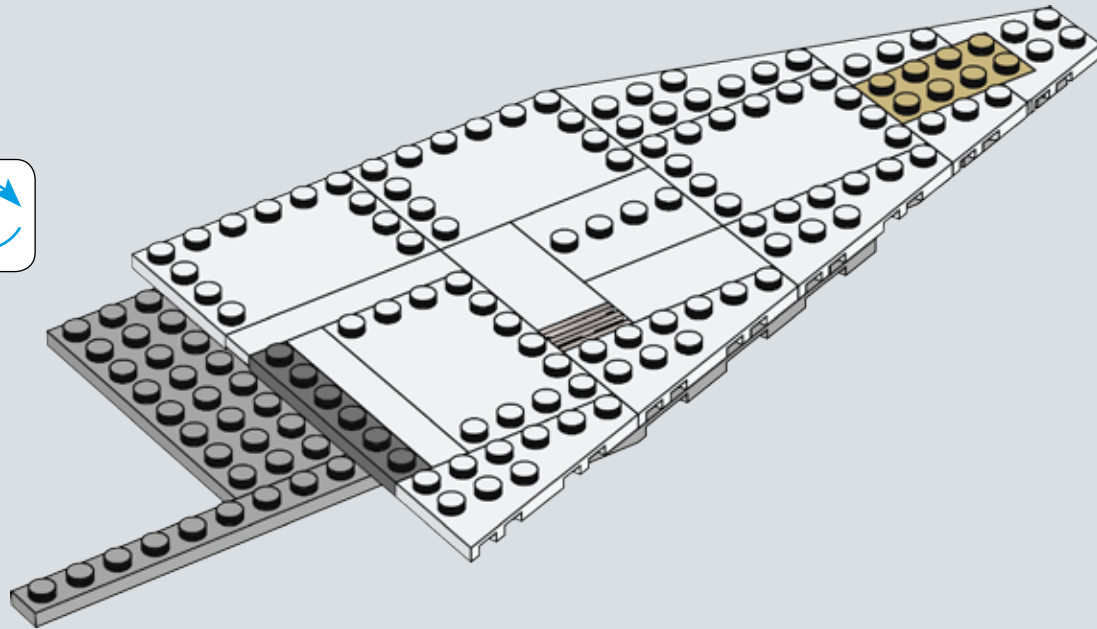
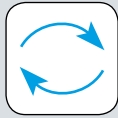

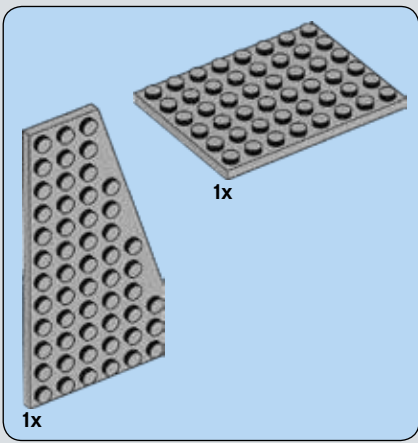

212

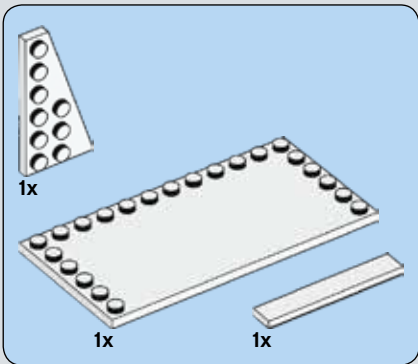
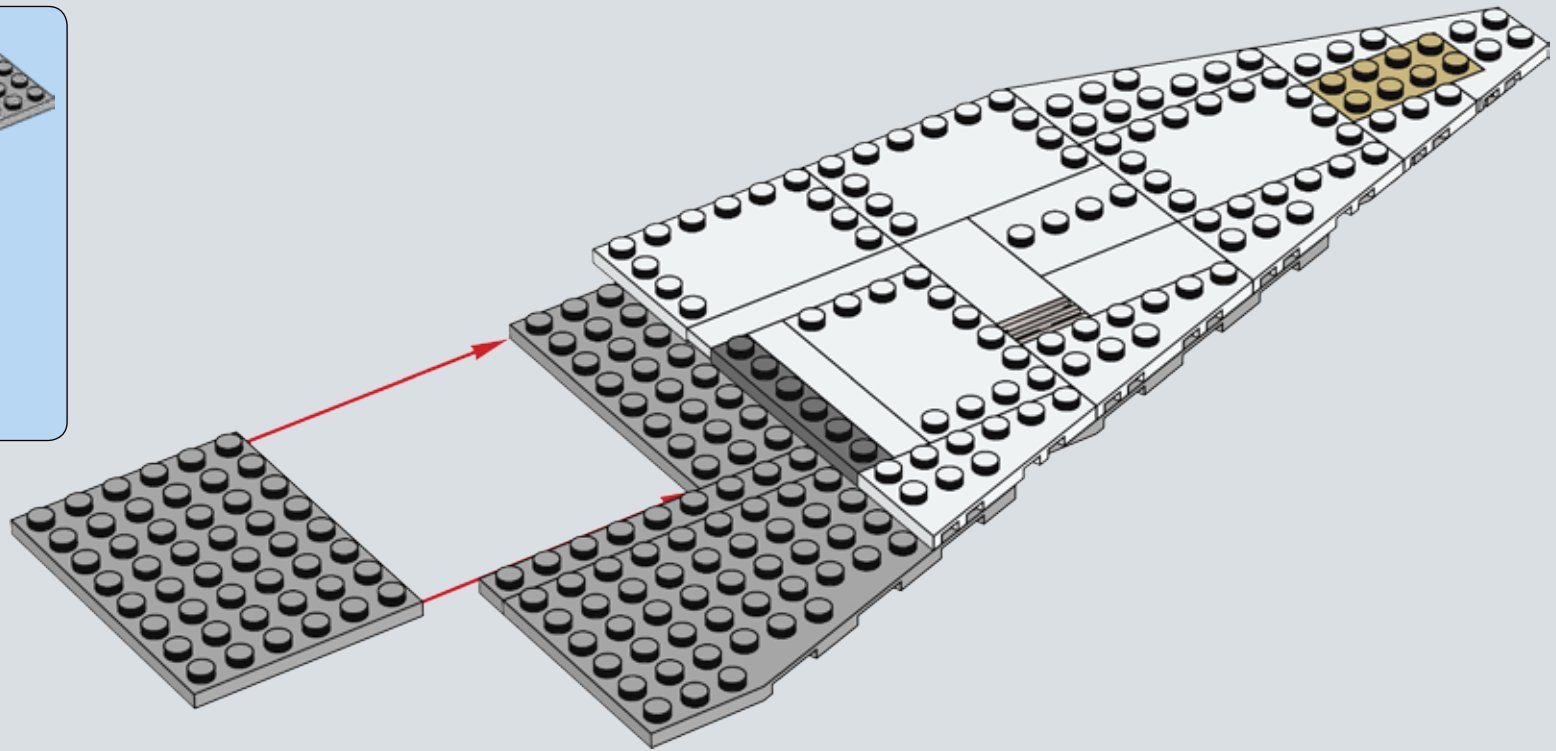

213

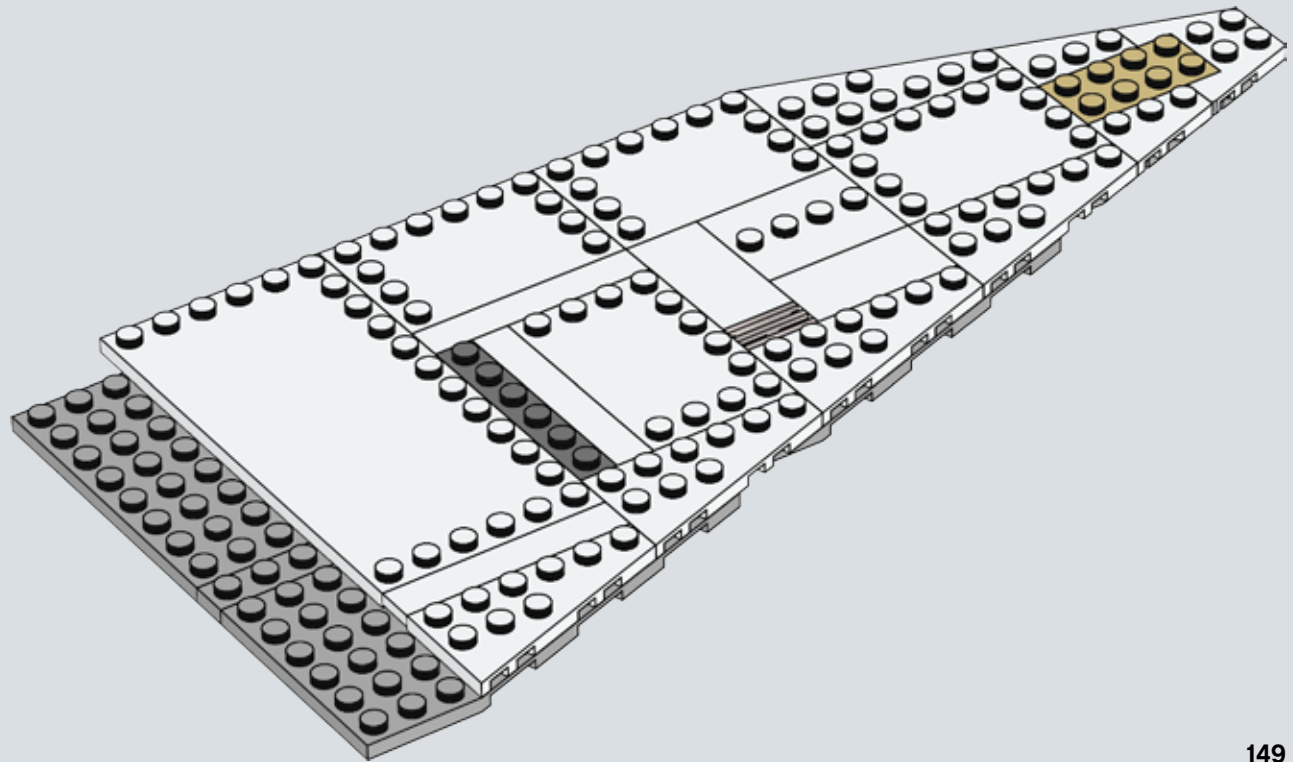

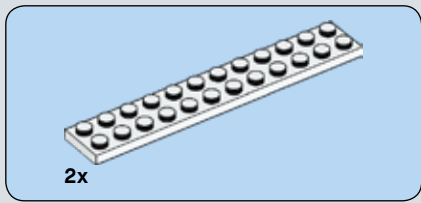

214

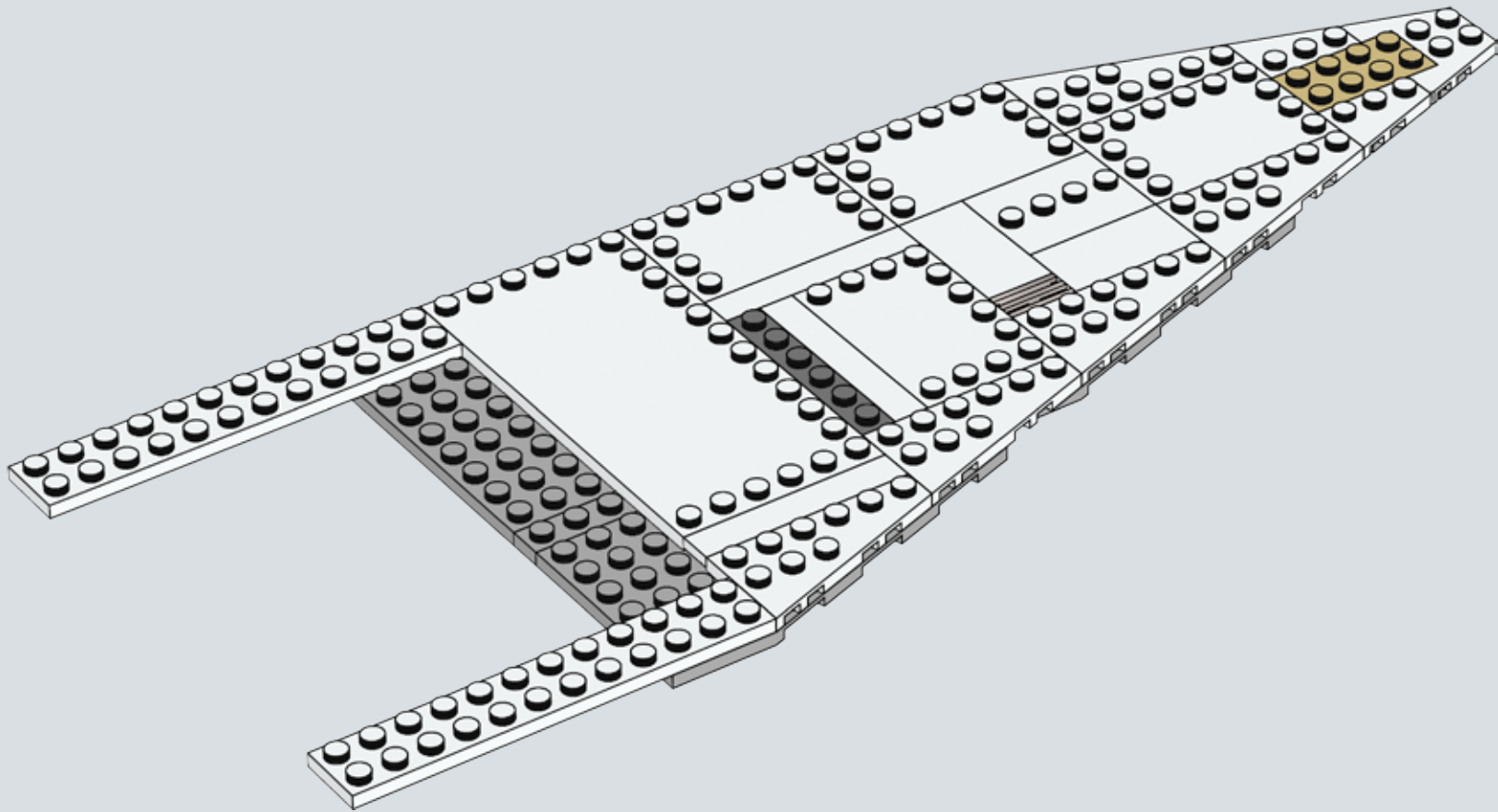

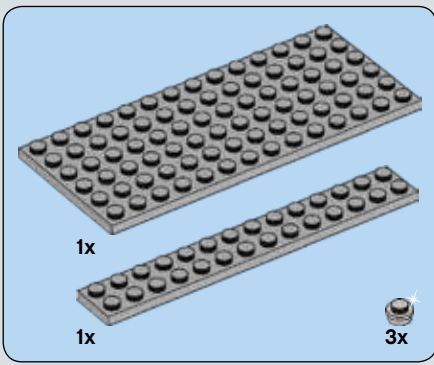

215

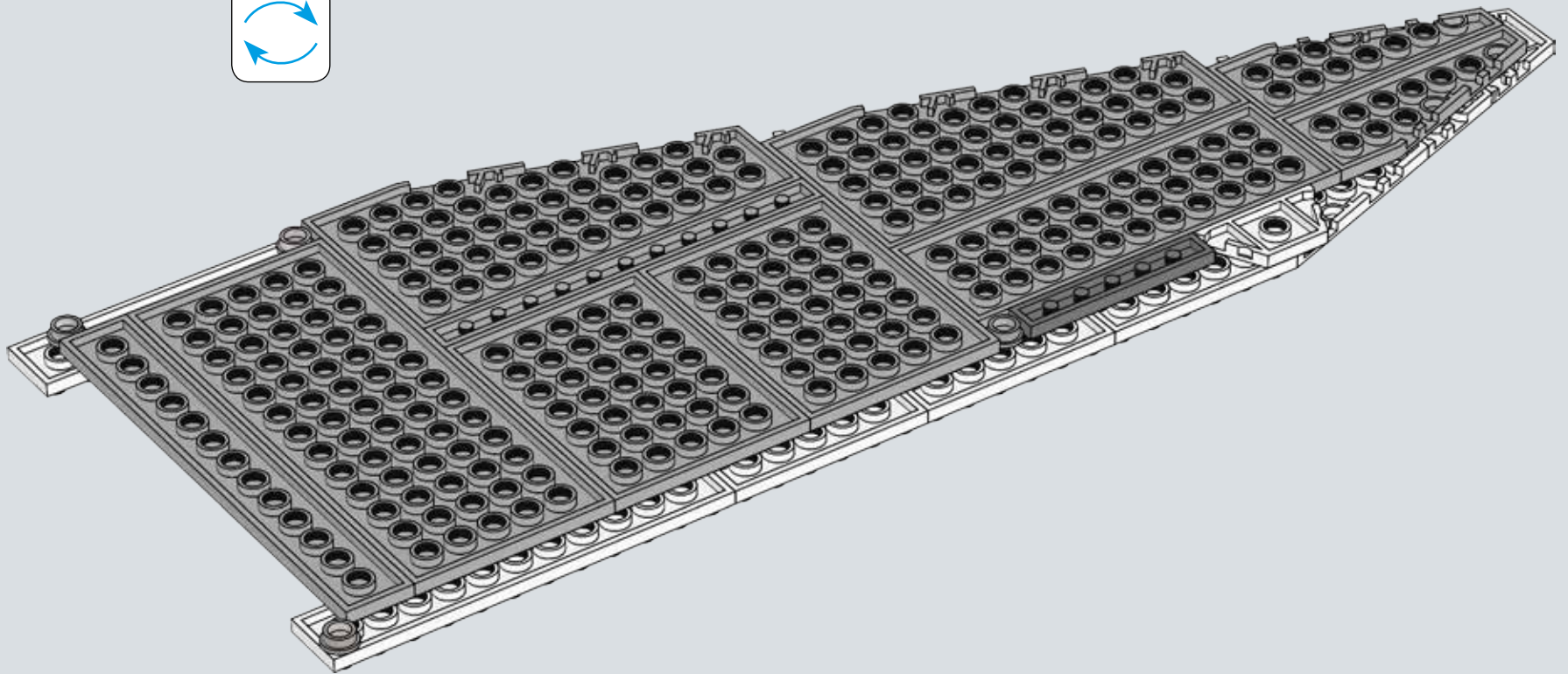
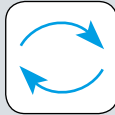

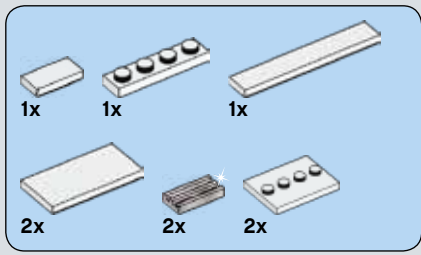

216

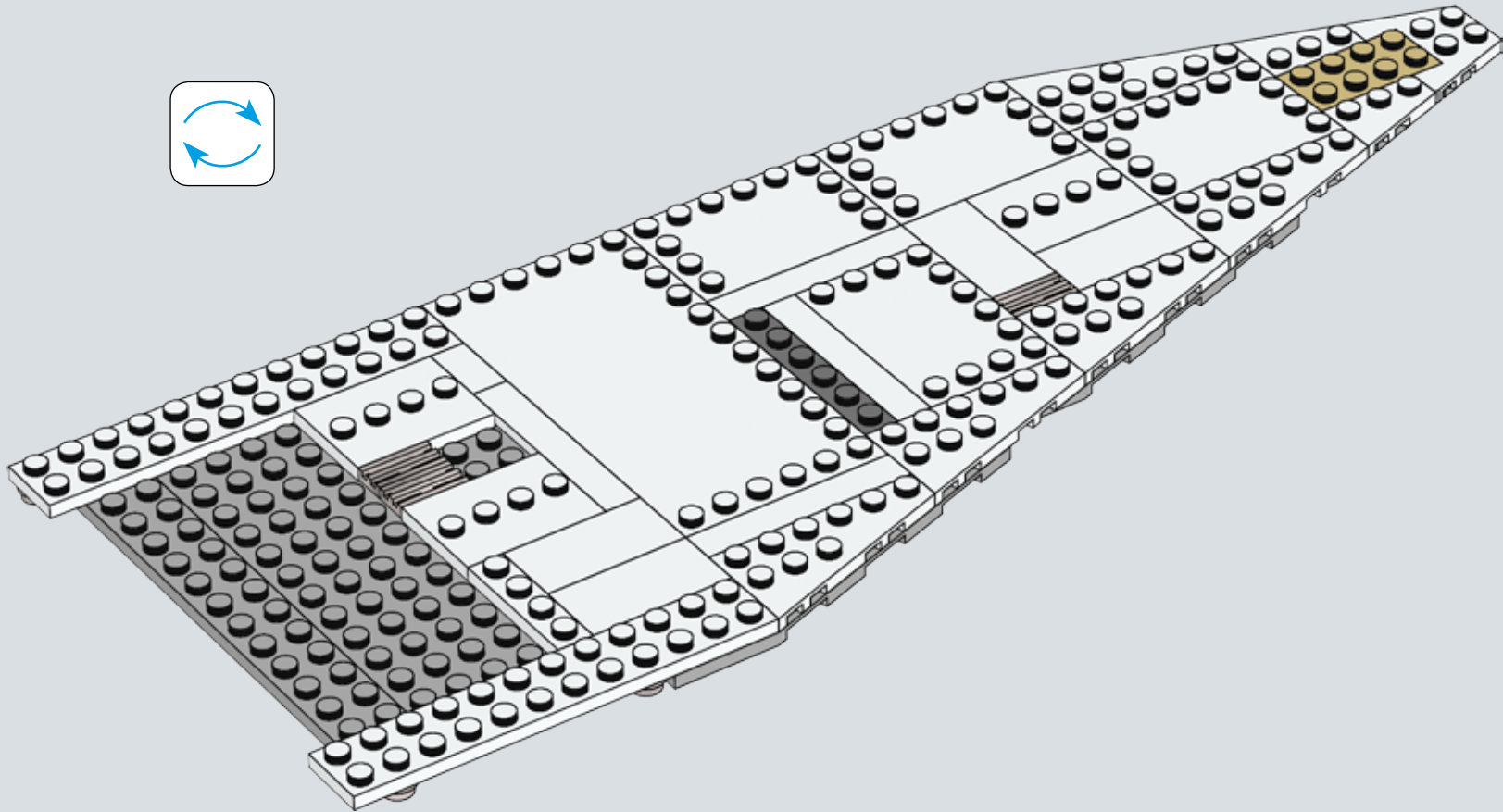

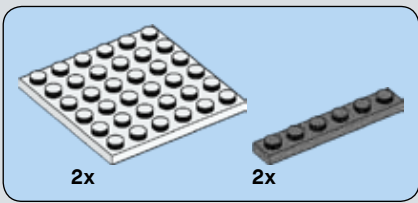

217

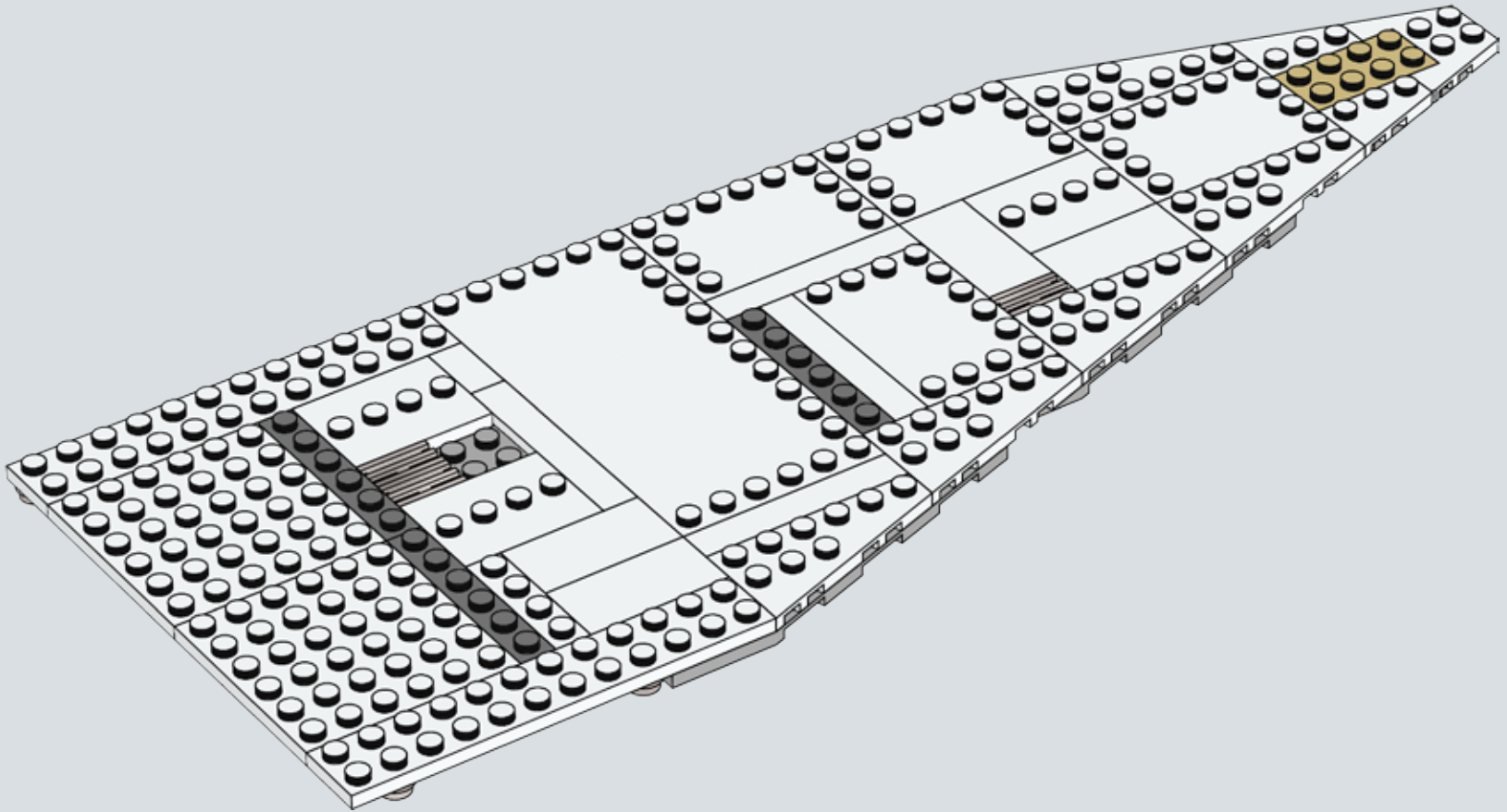

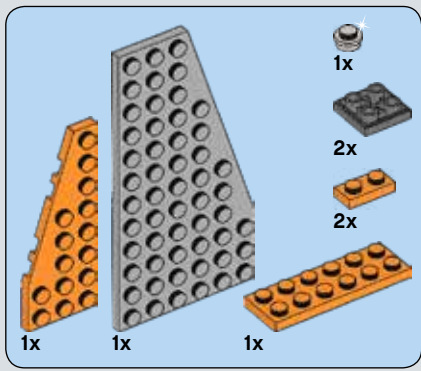

218

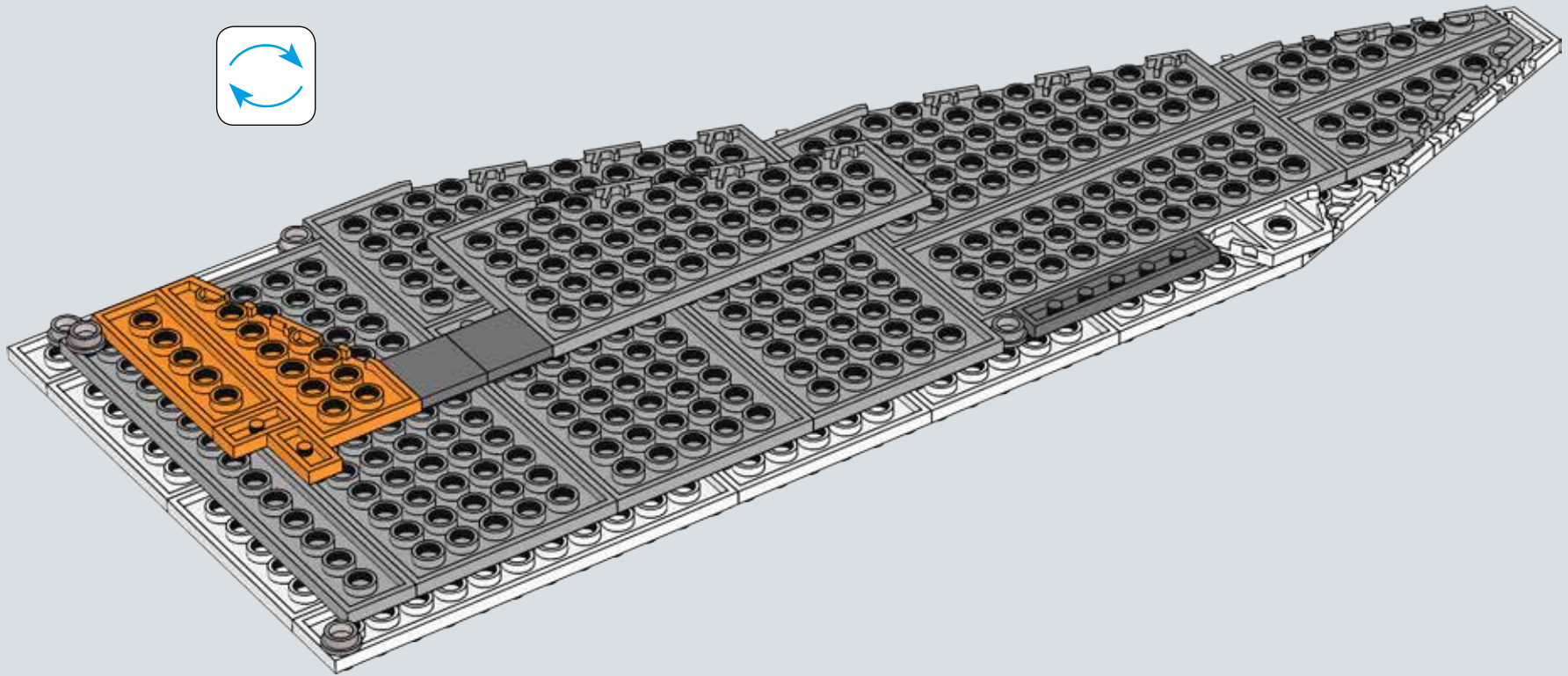
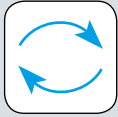

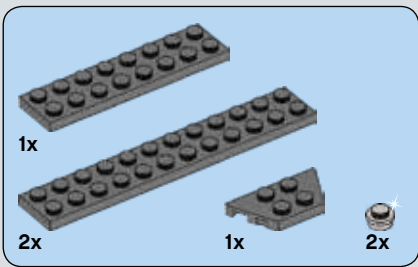

219

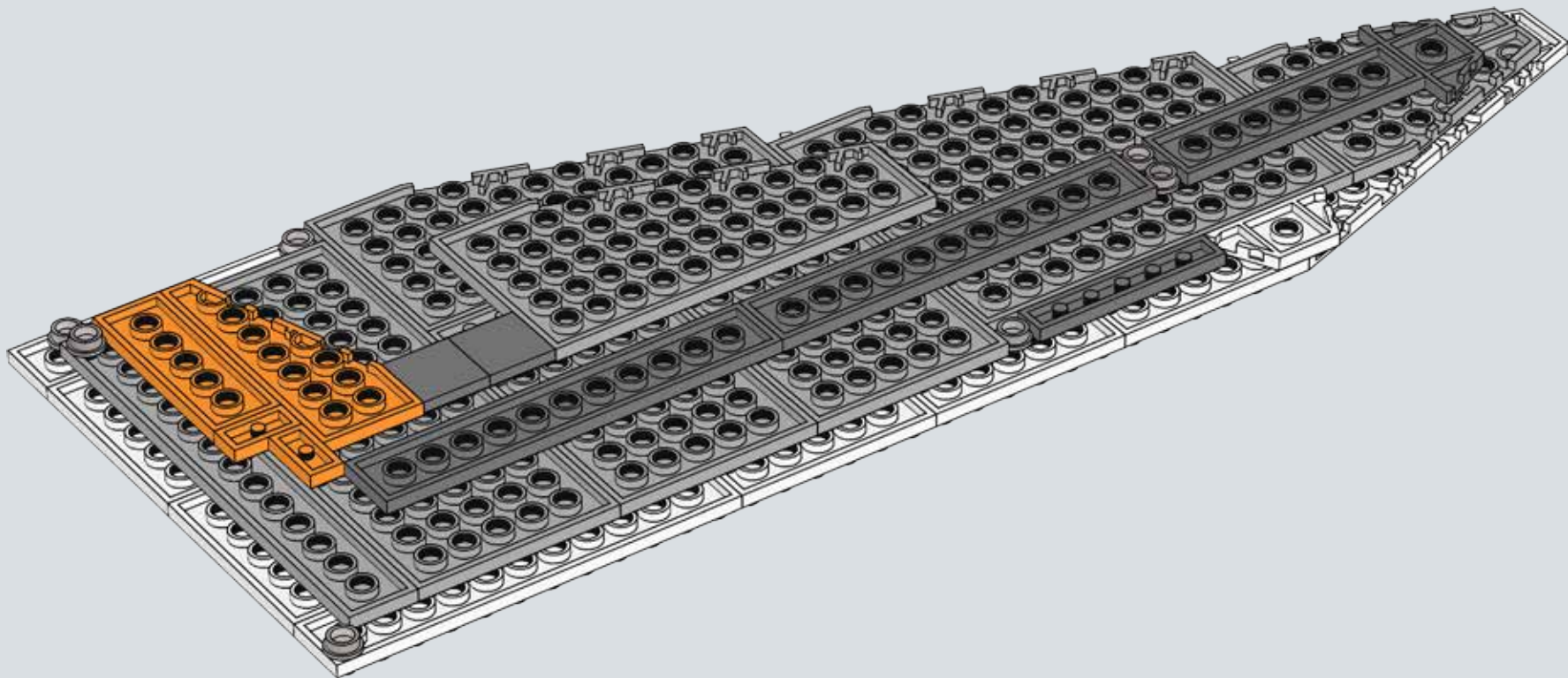

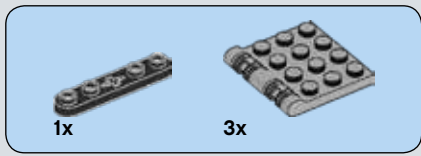

220

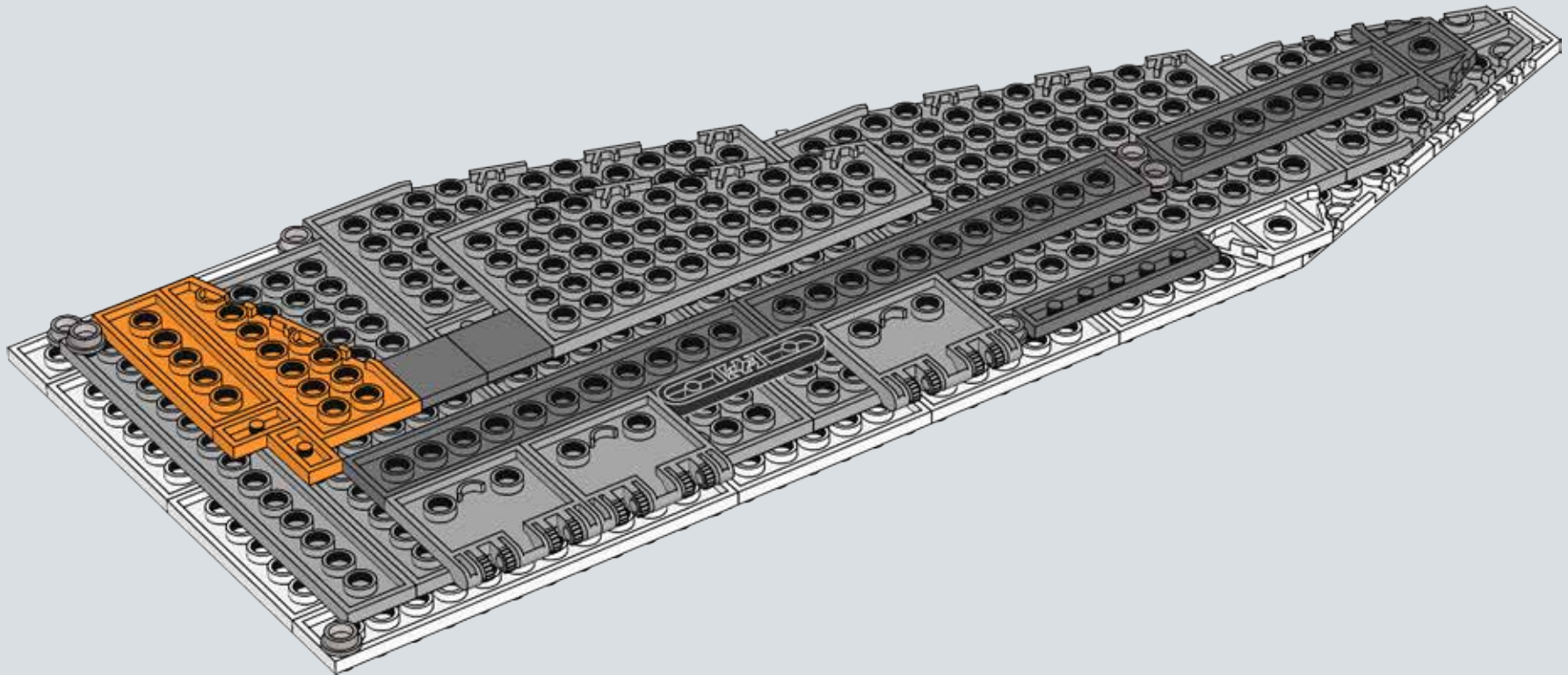

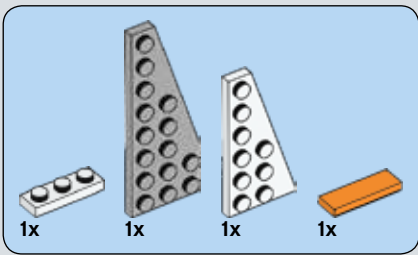

221

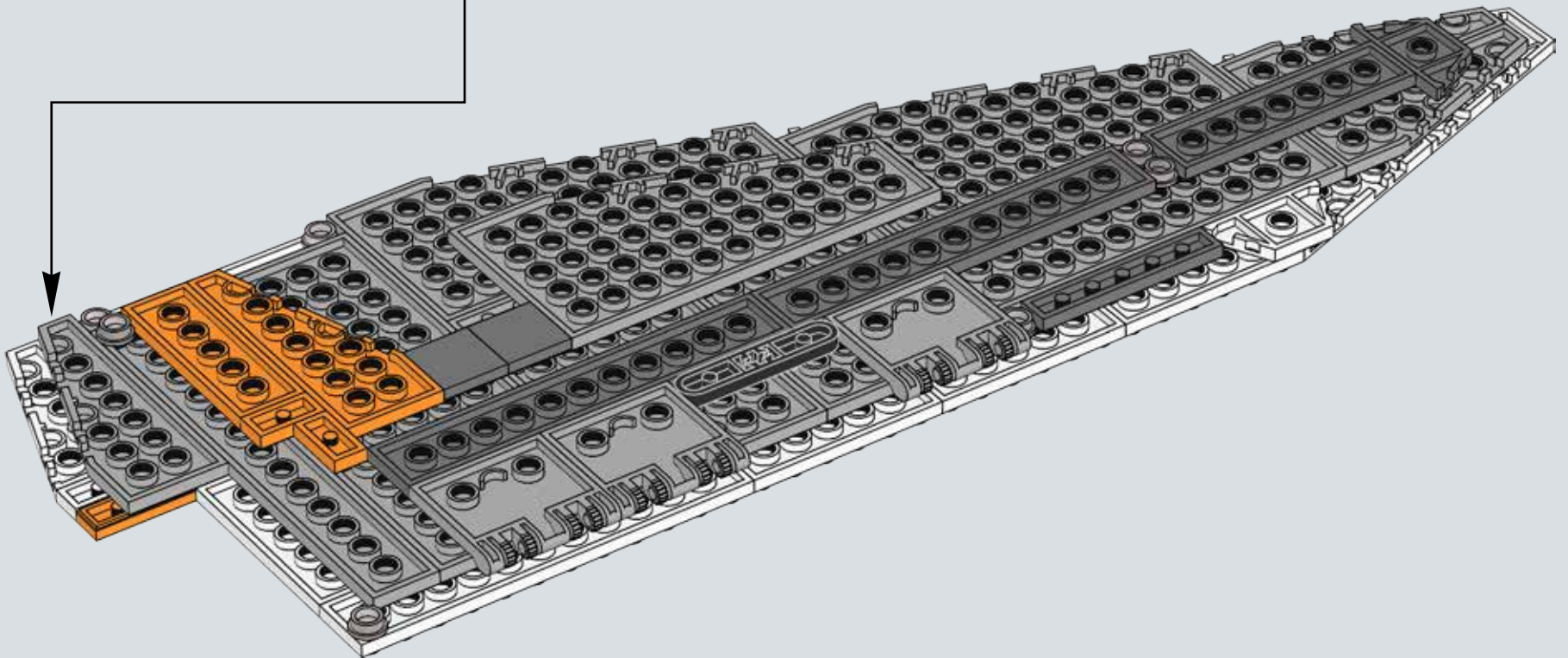
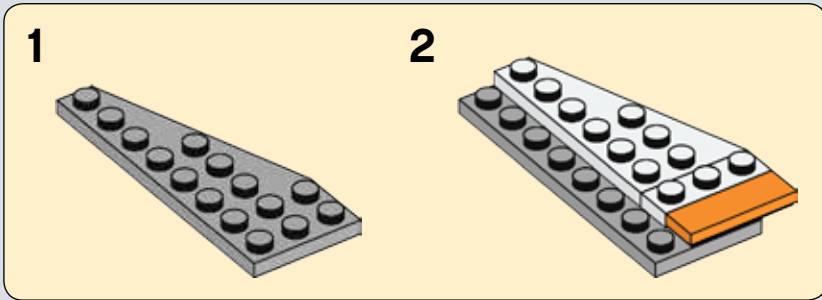

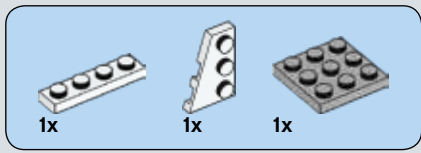

222

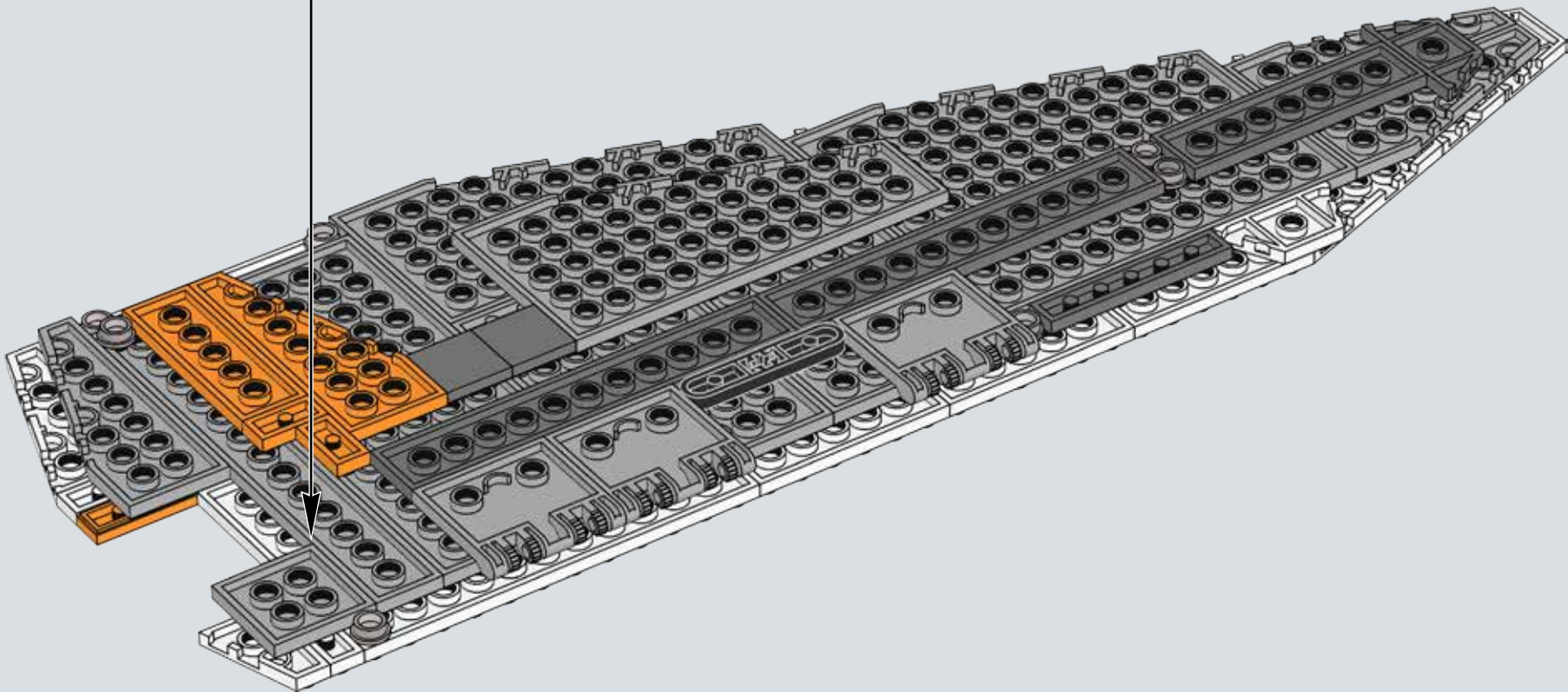
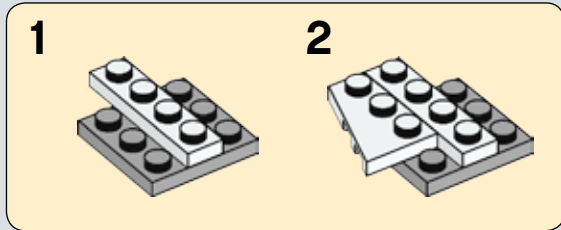



223

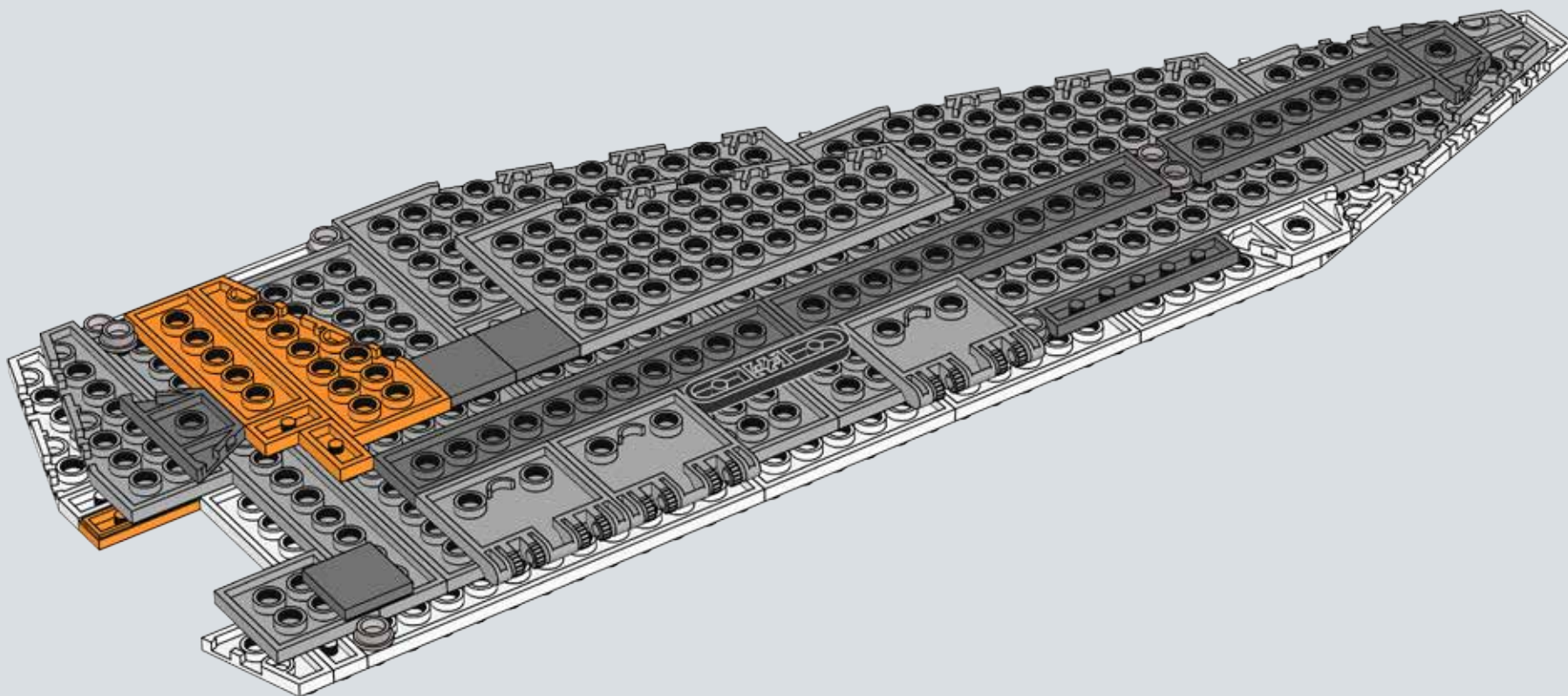



224

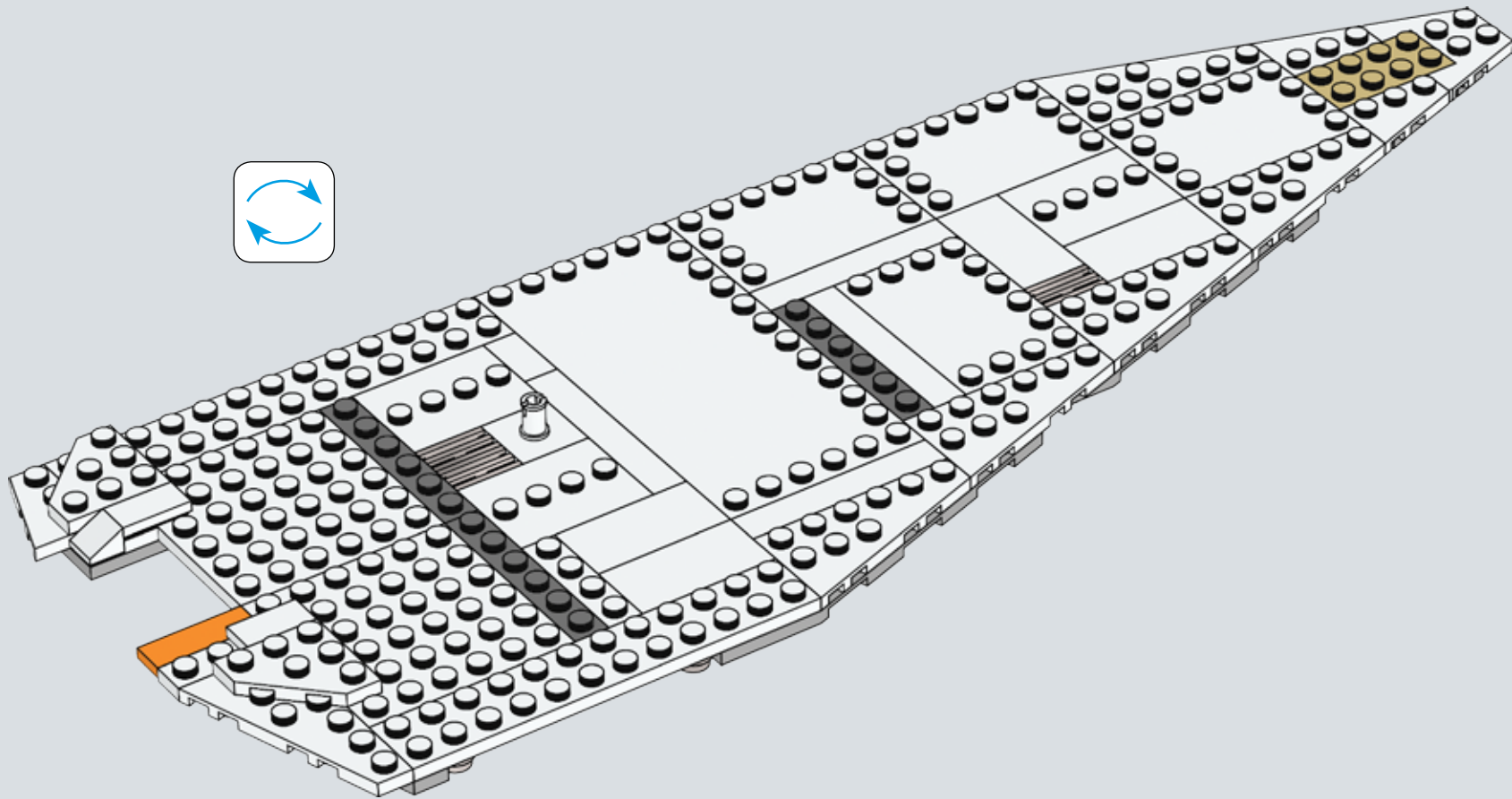
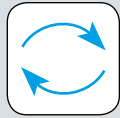

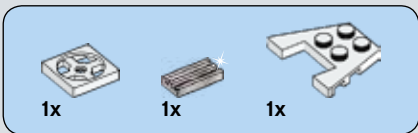

225

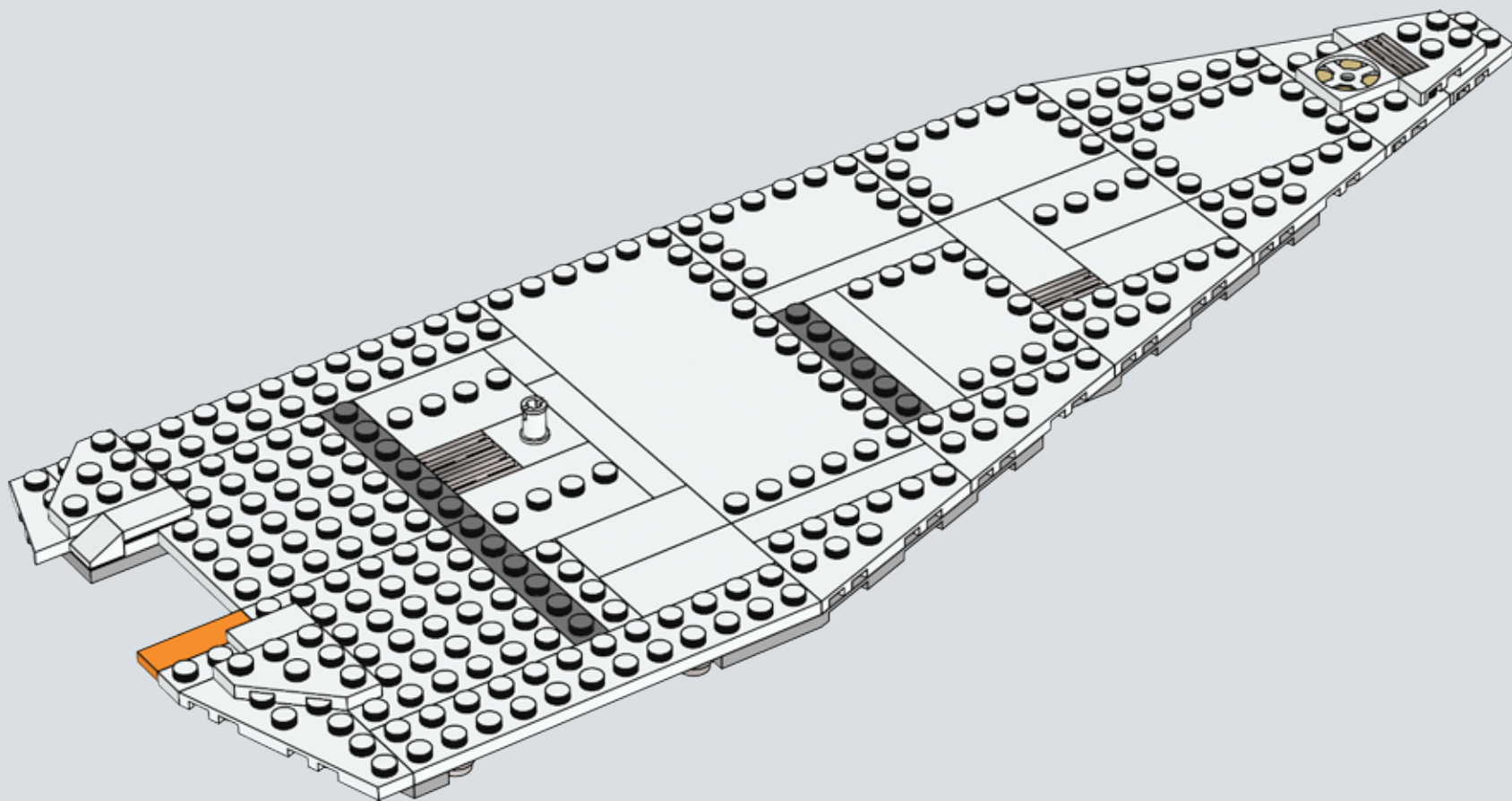



1x

226

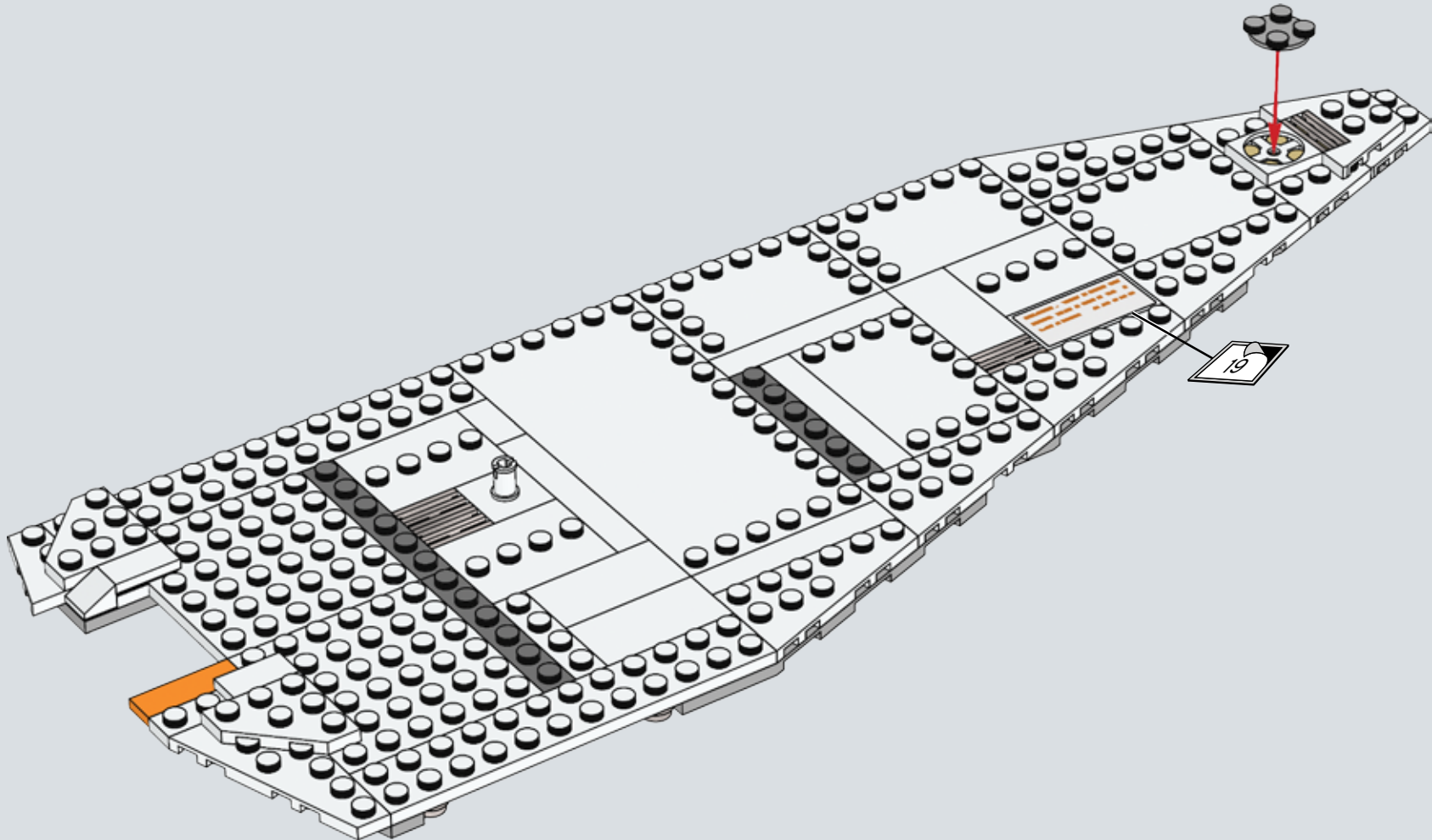

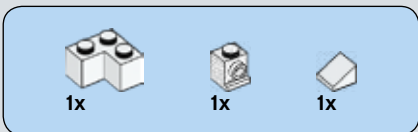
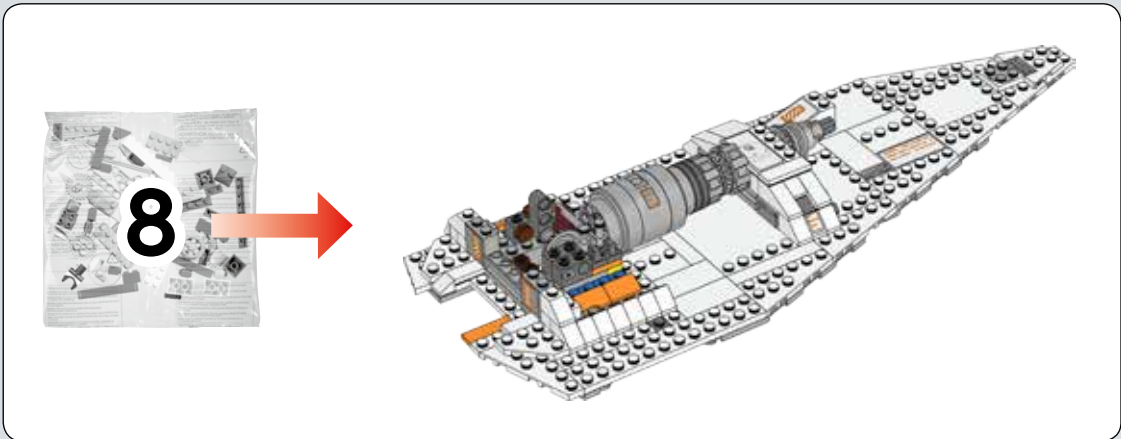

227

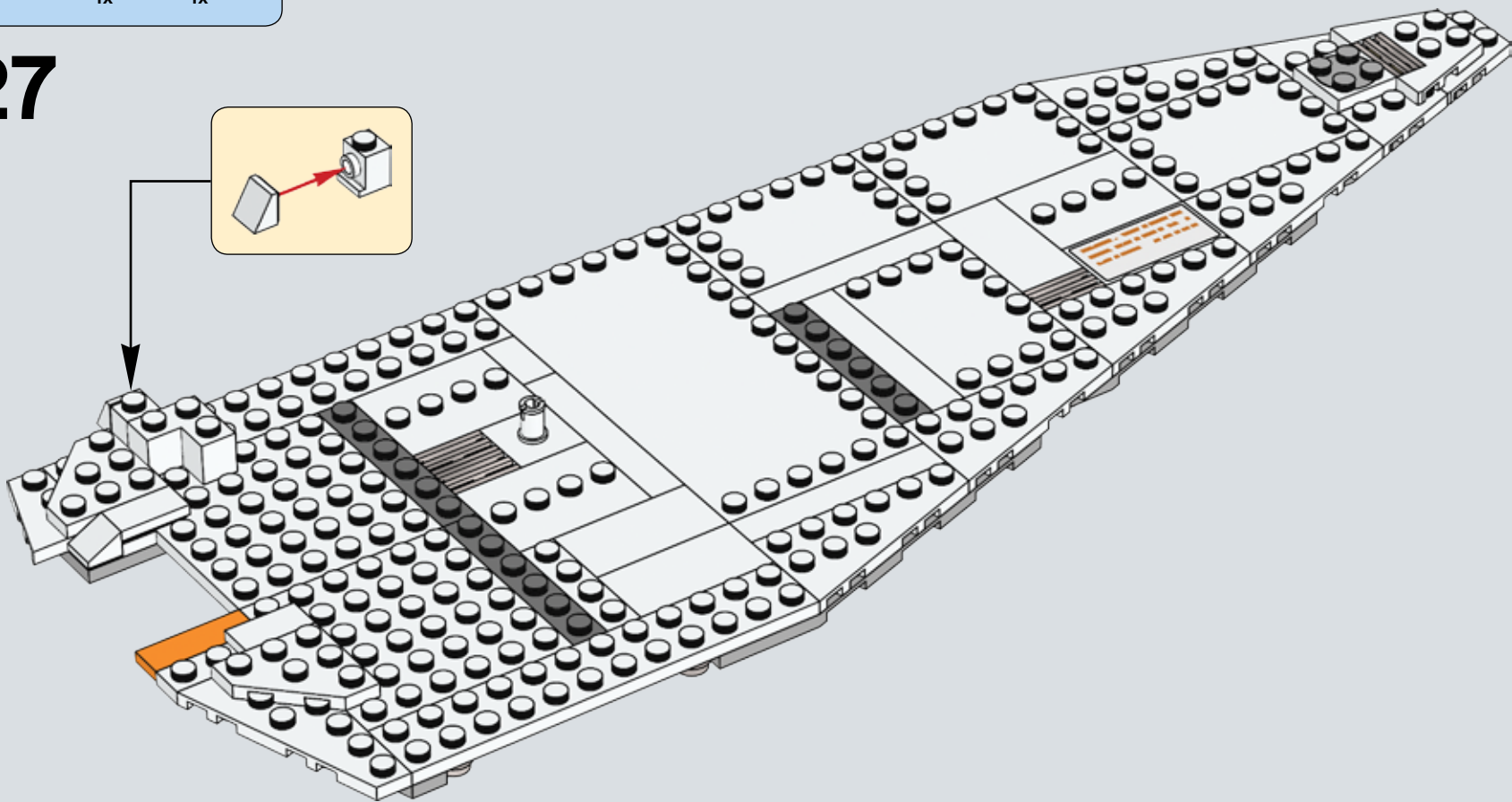

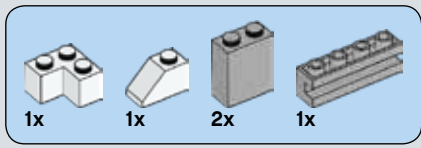

228

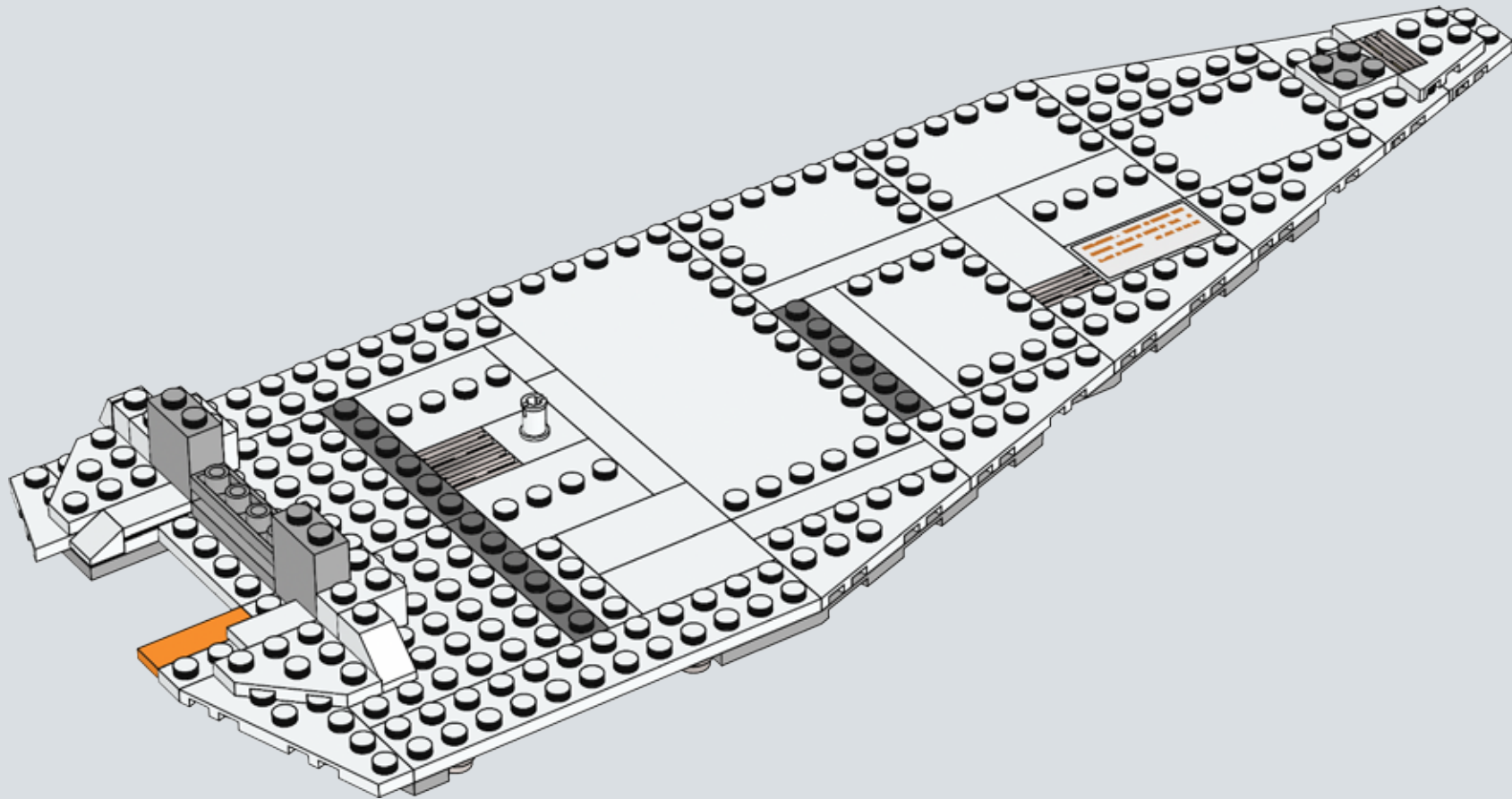



229

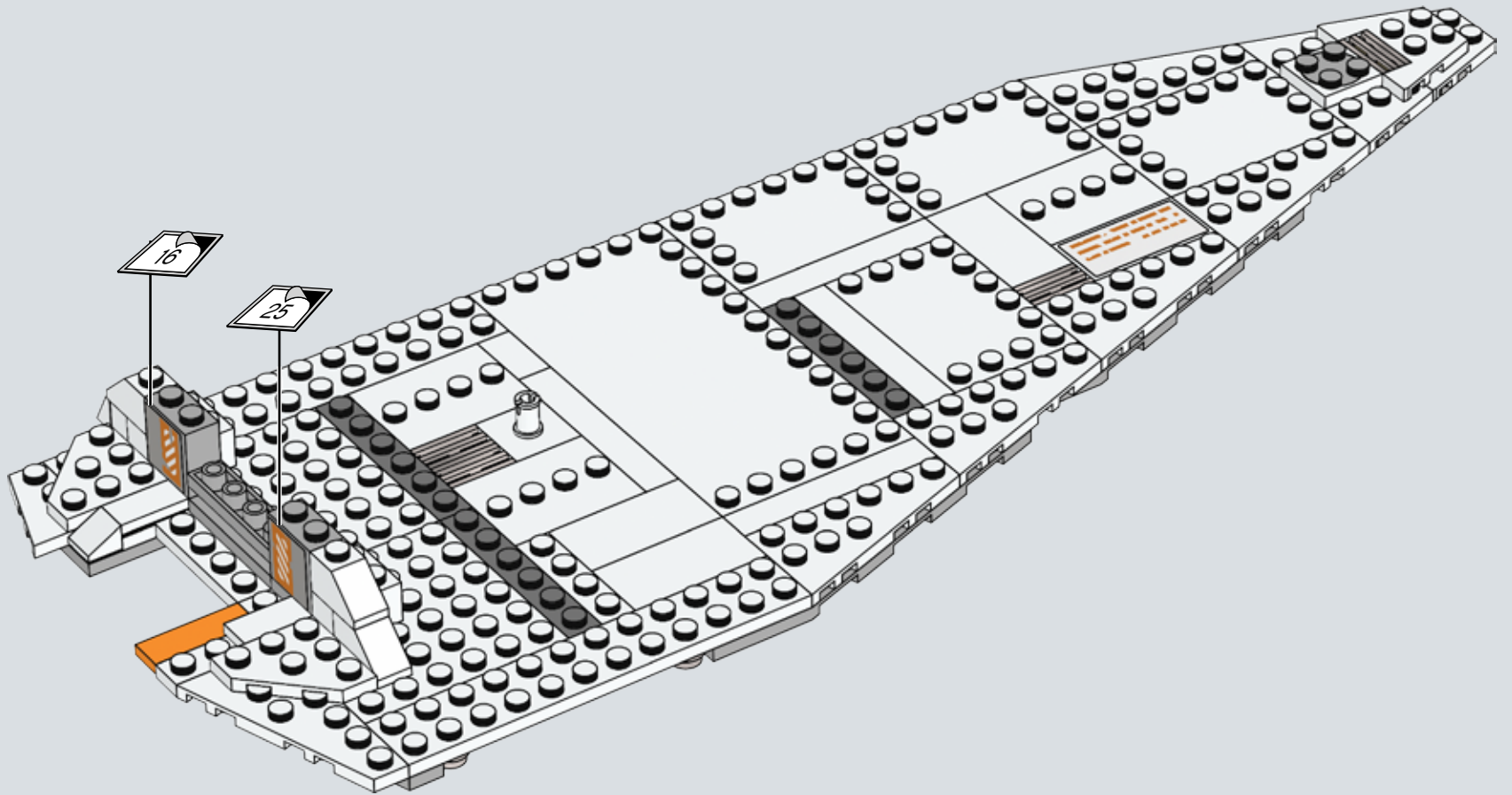



230

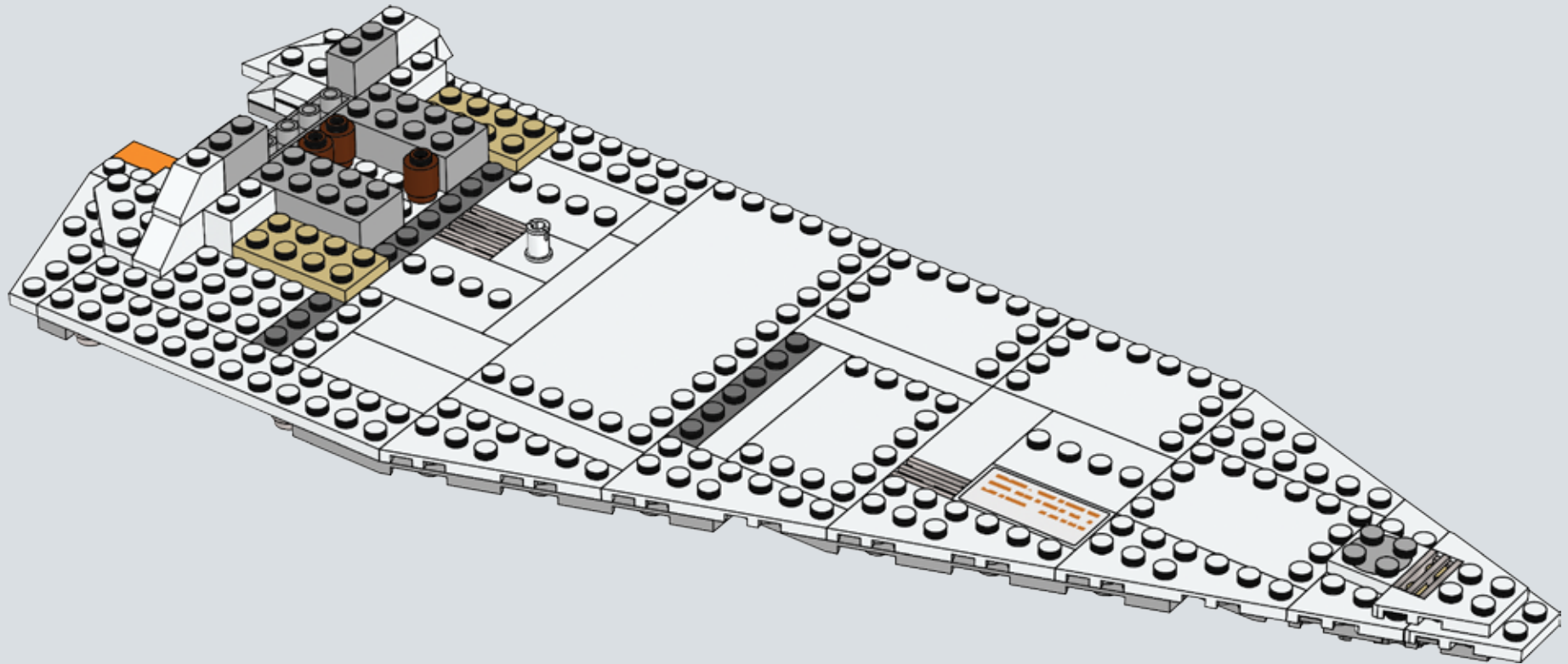



231

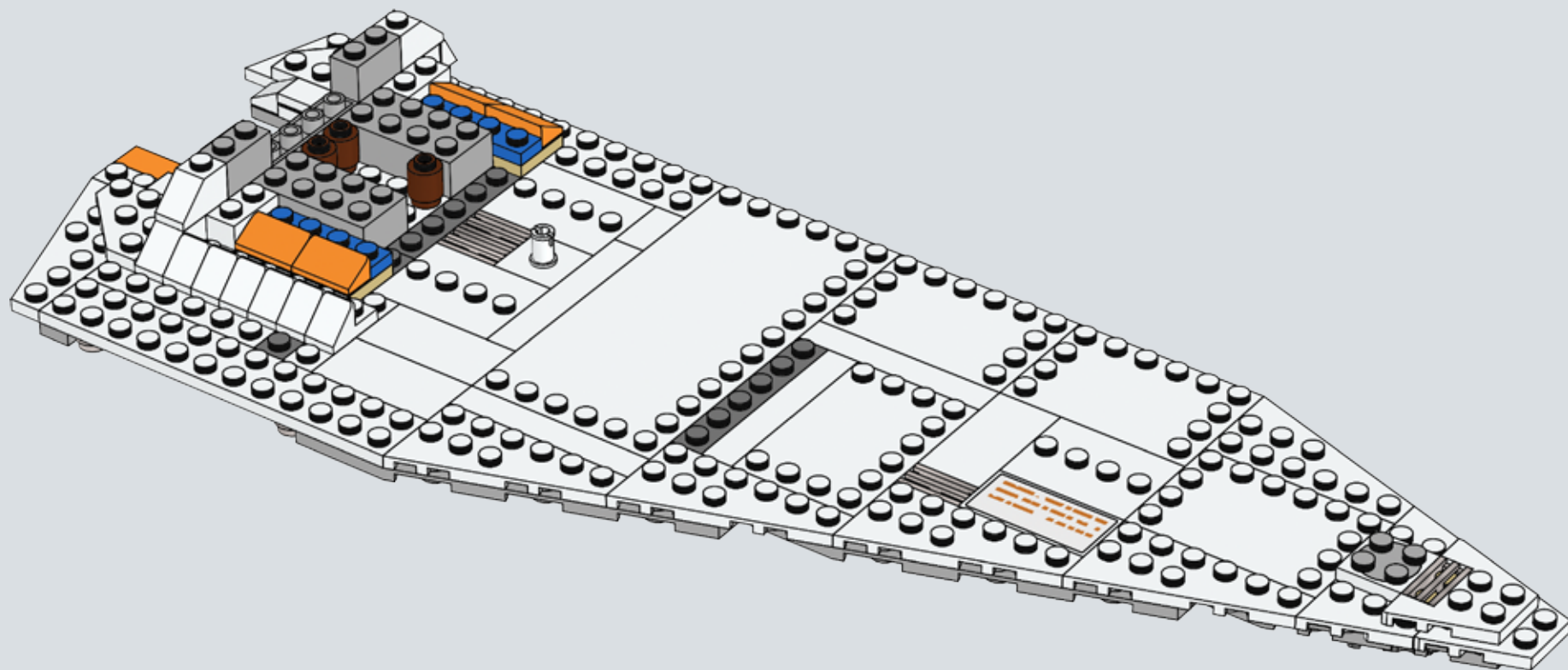

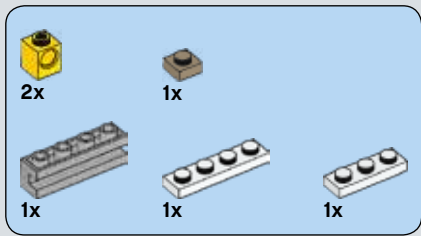

232

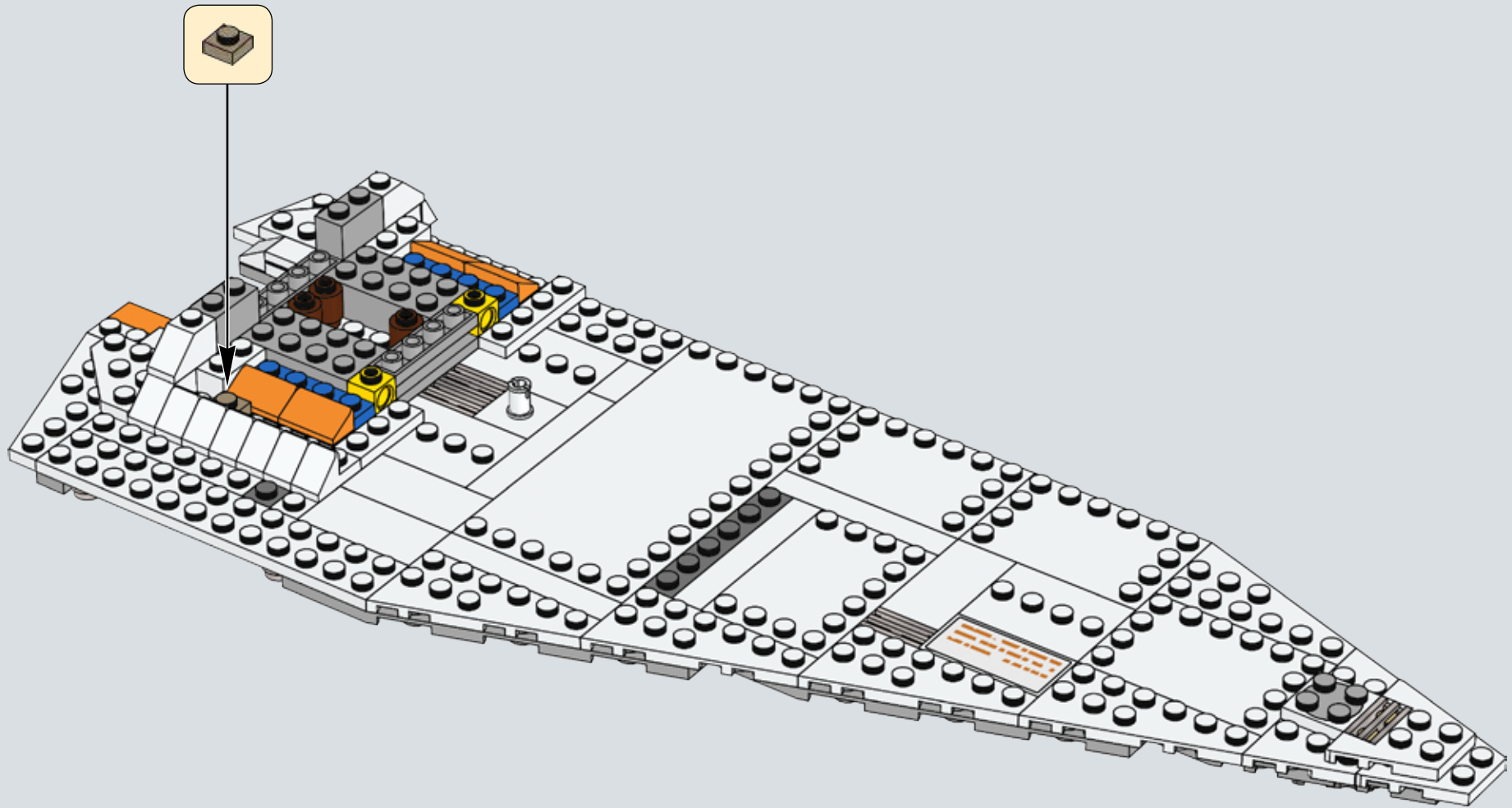



233

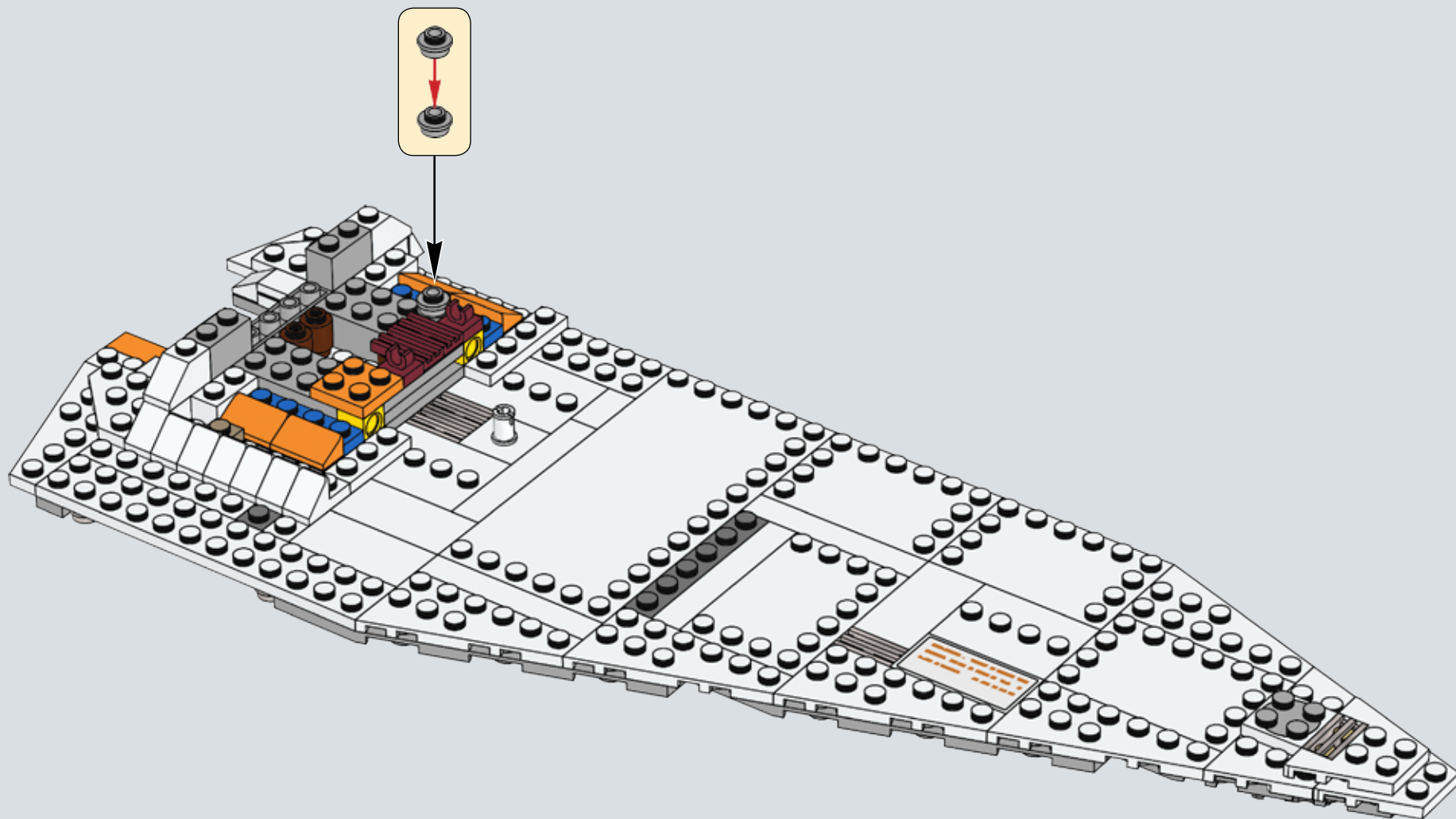



2x

234

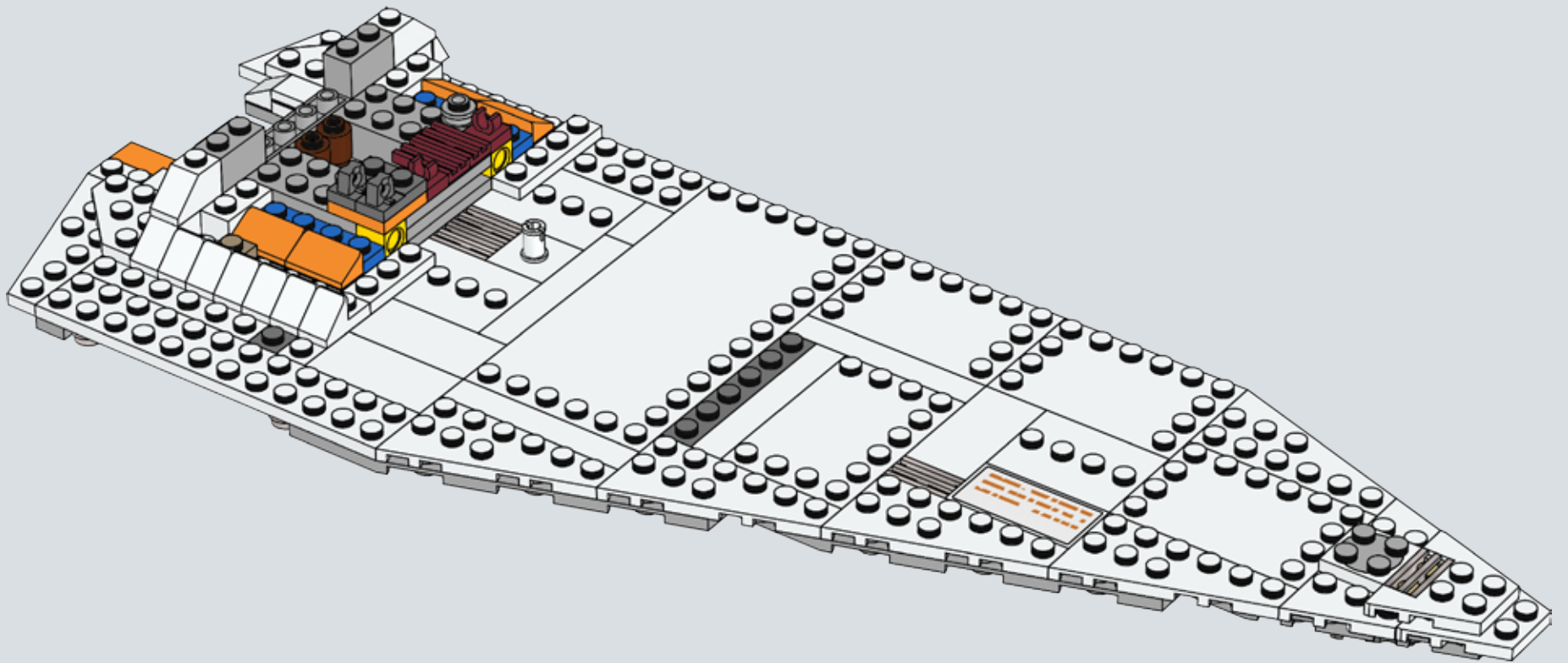

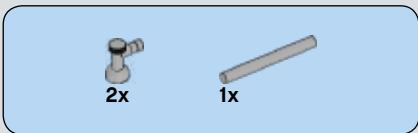

235

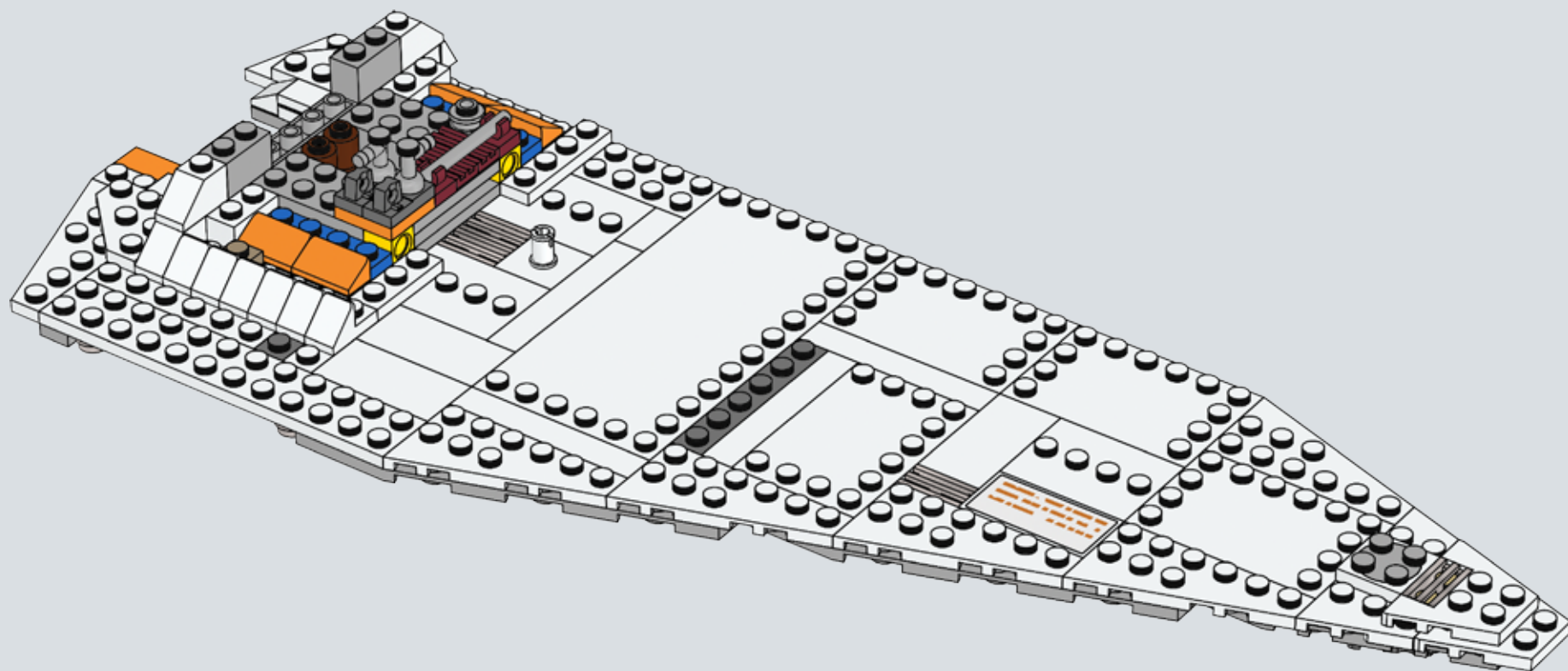

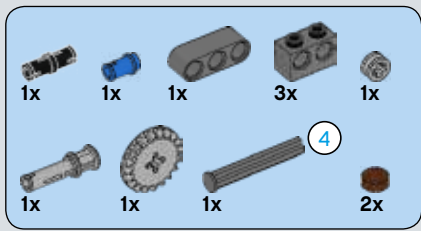

236

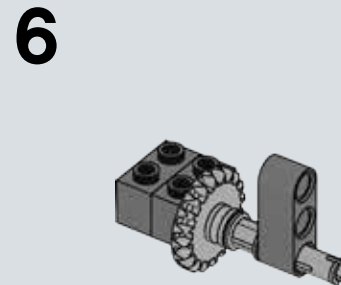
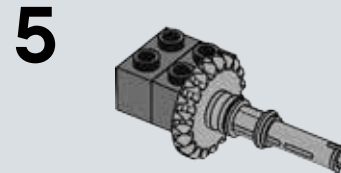
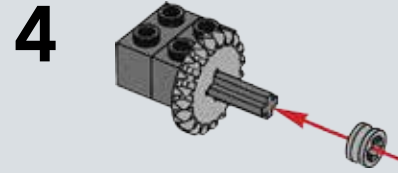
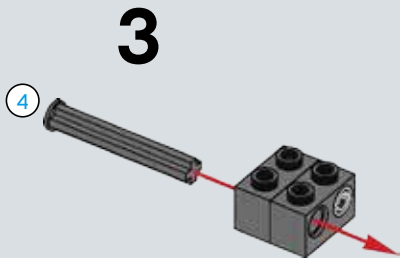
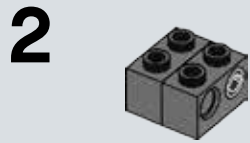
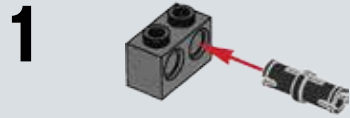

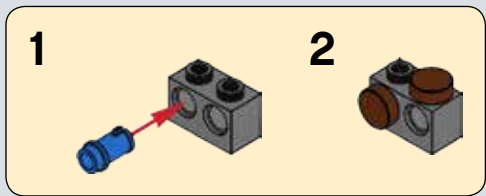

7

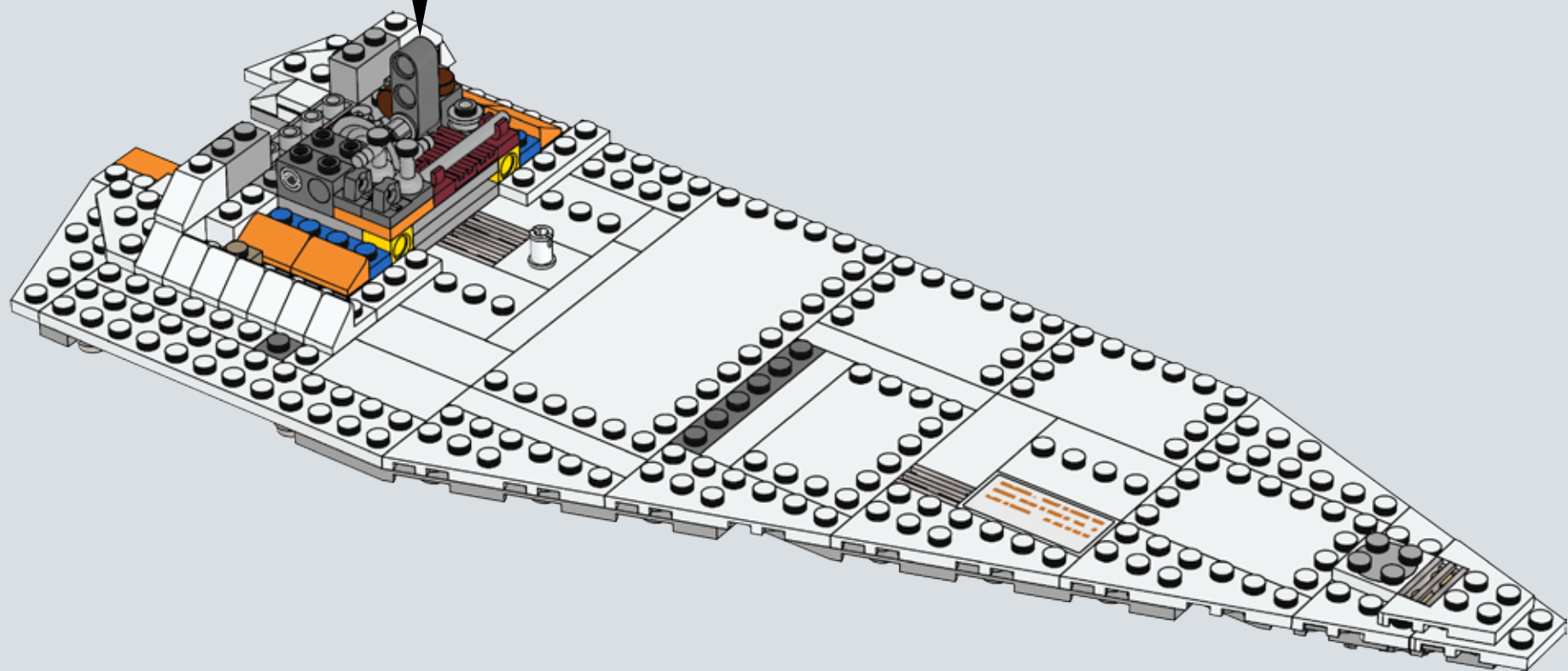
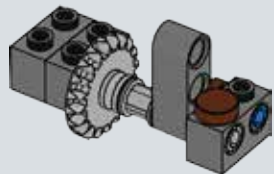

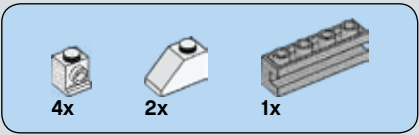

237

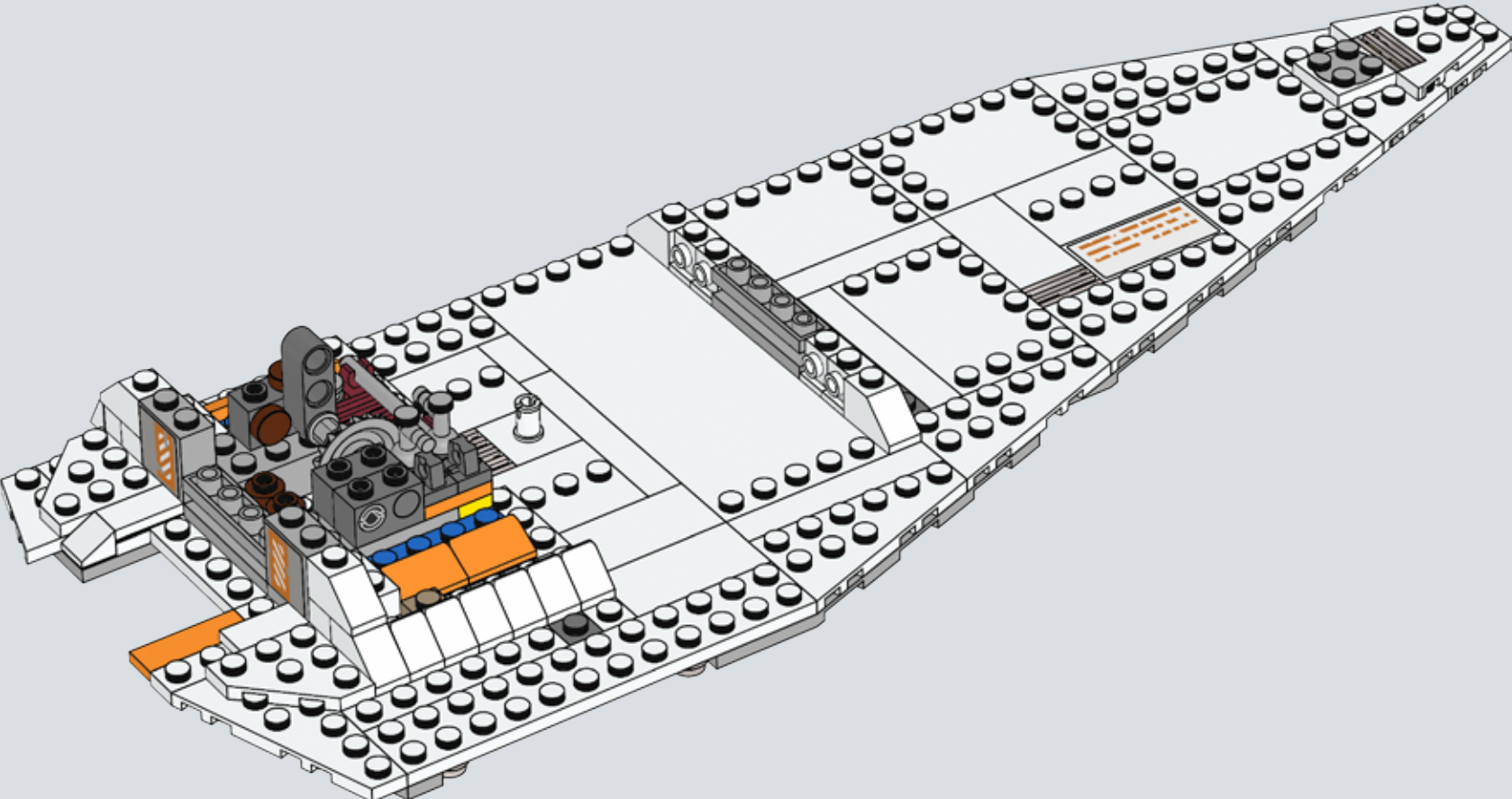

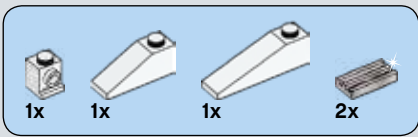

238

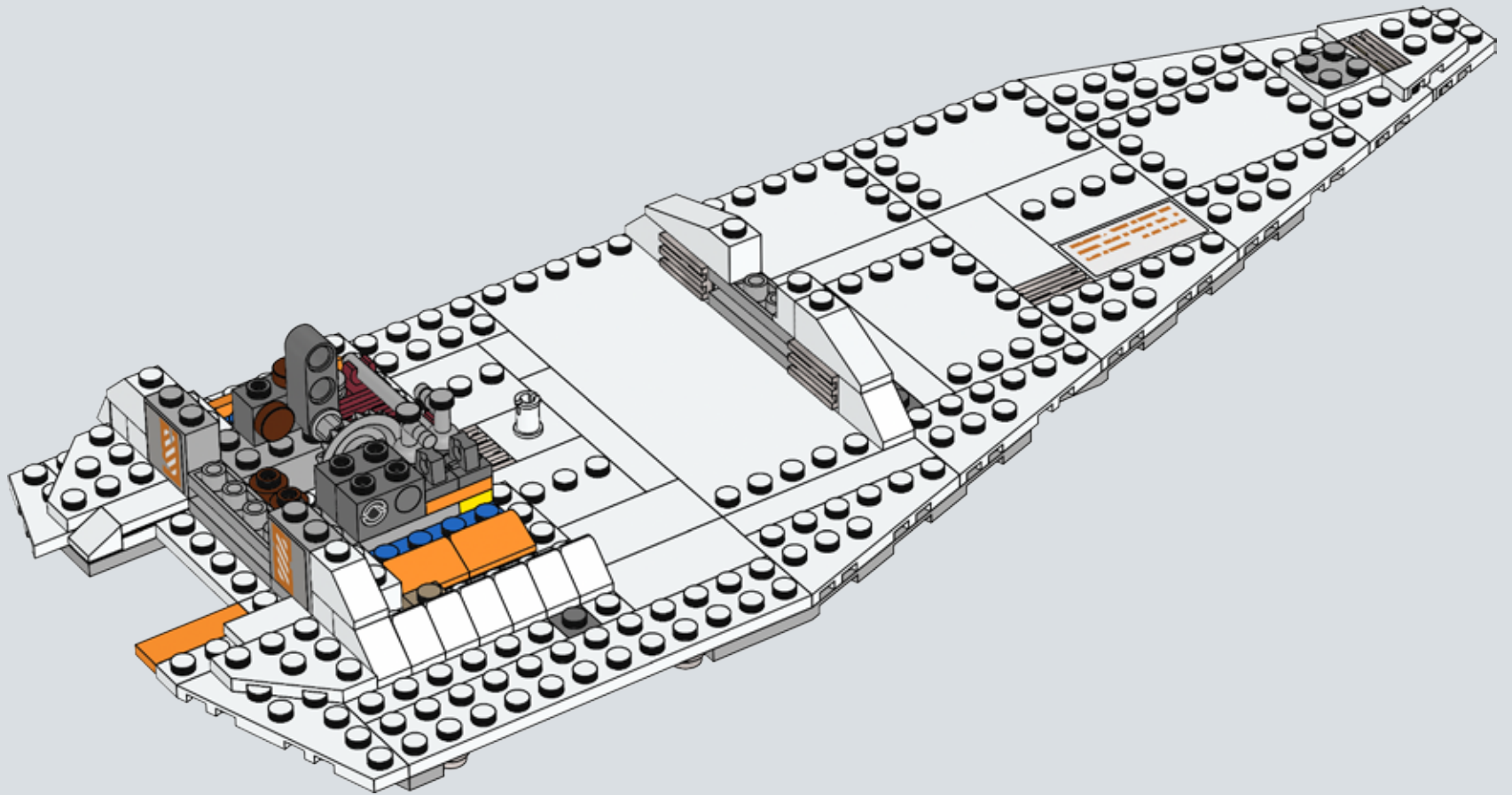



239

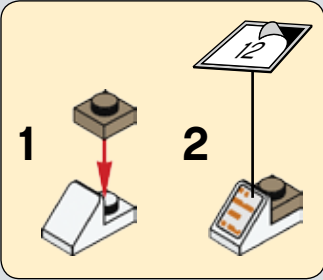
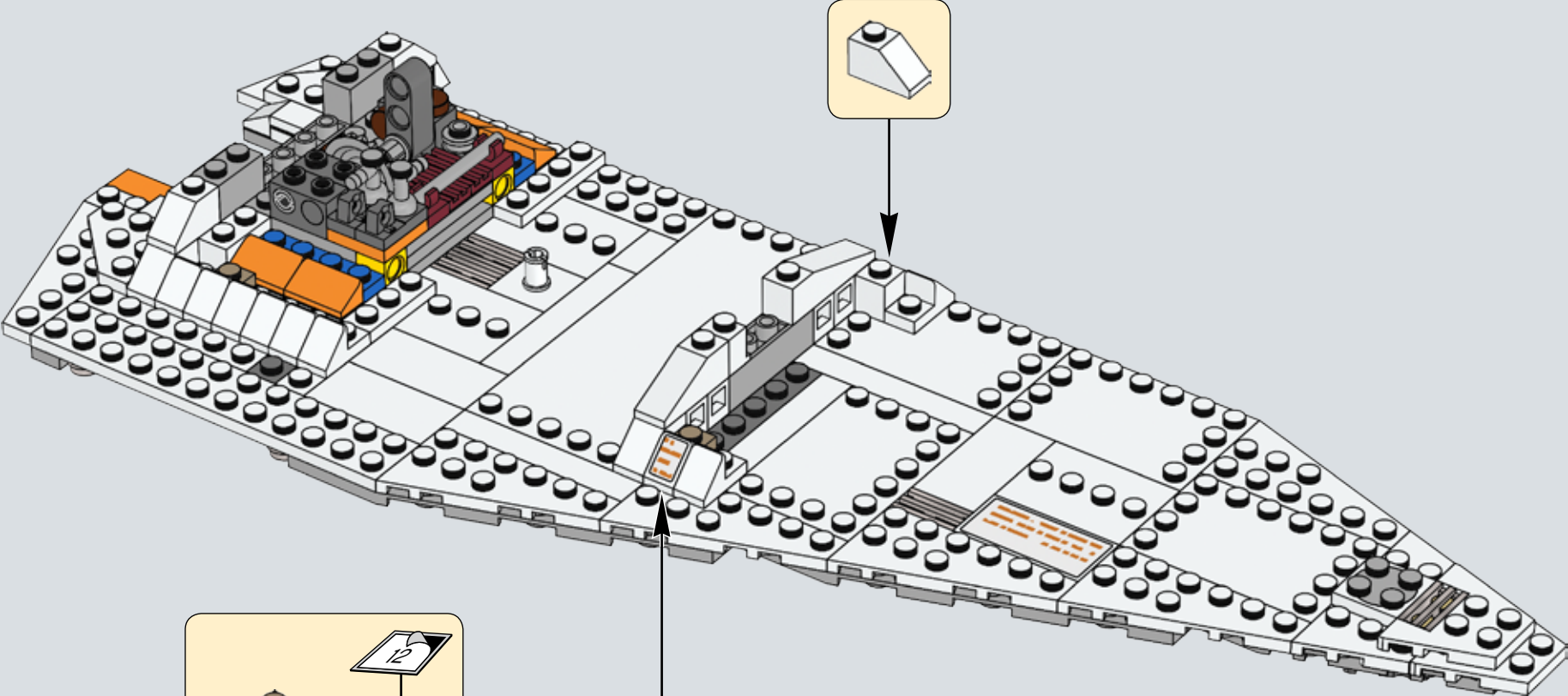

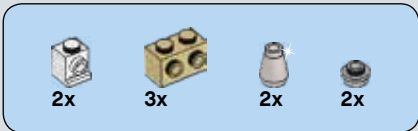

240

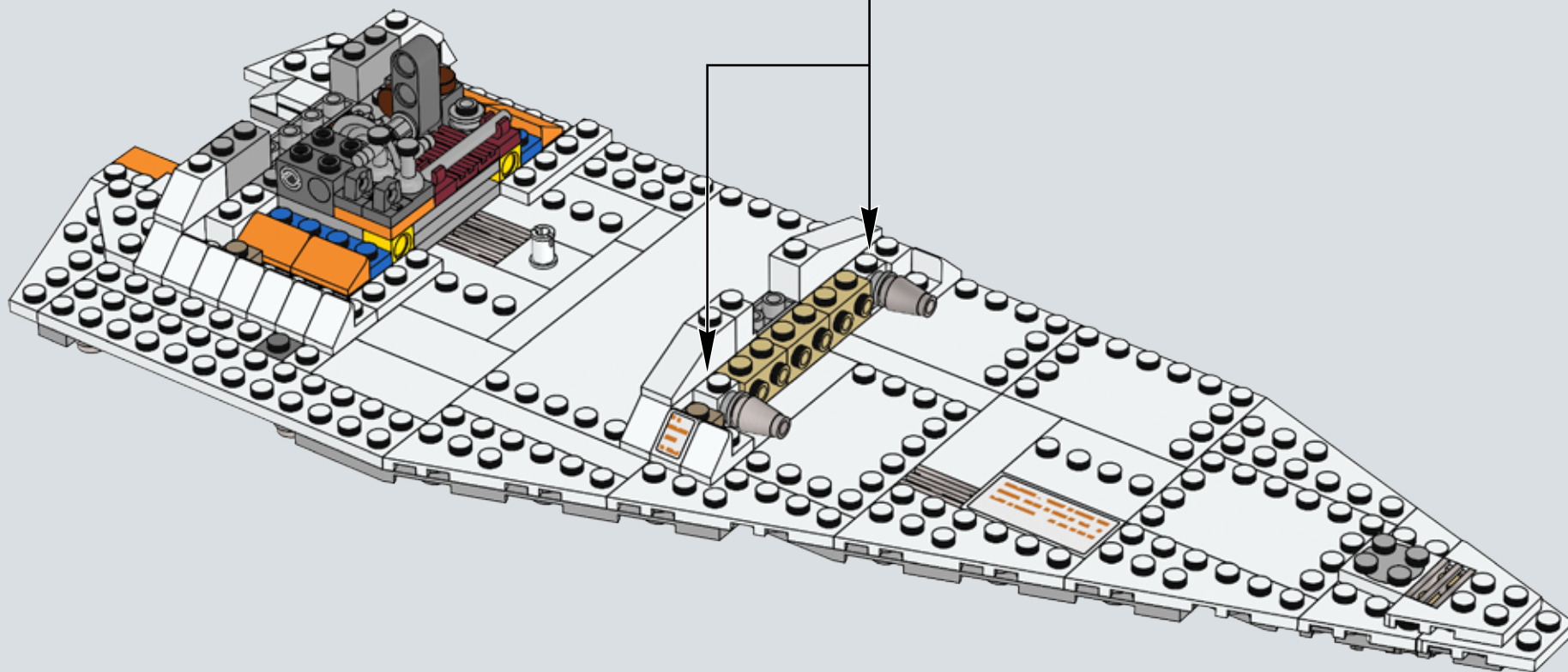
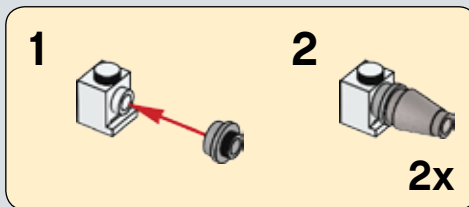



241

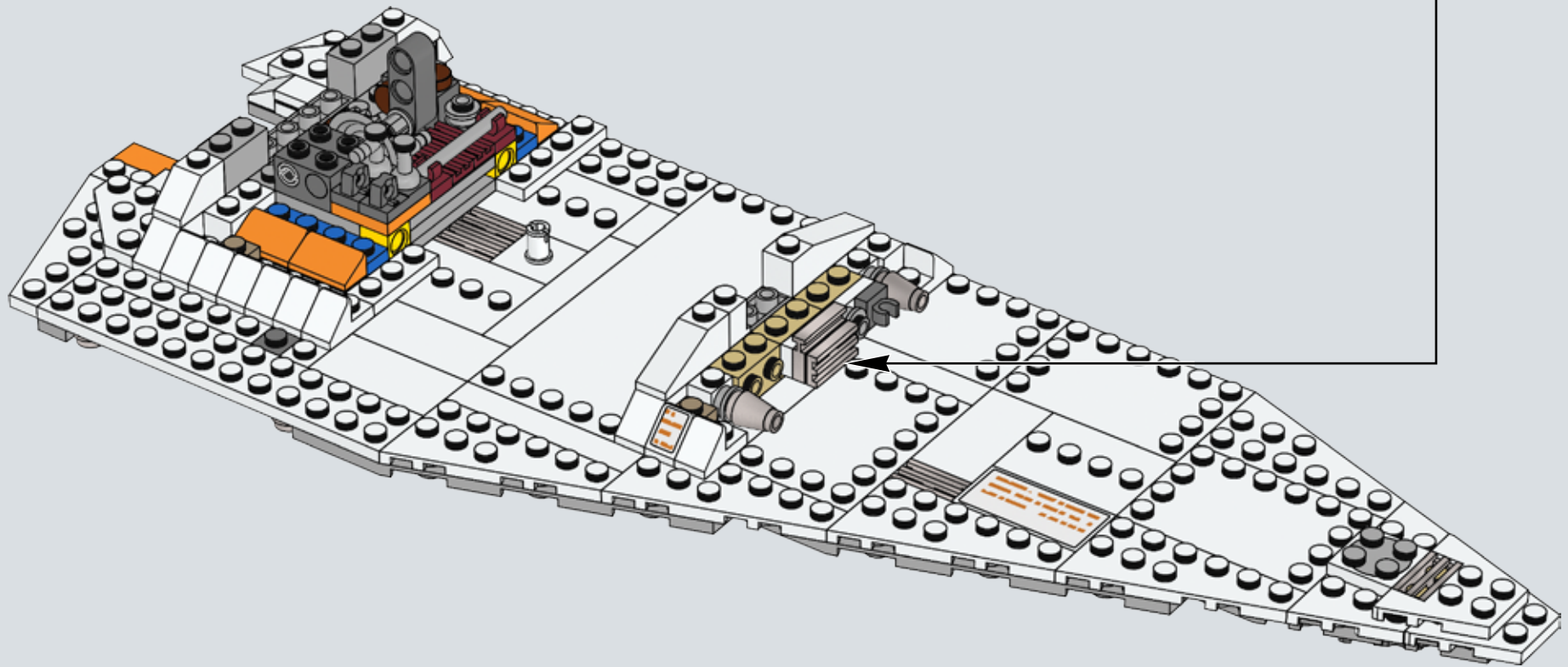
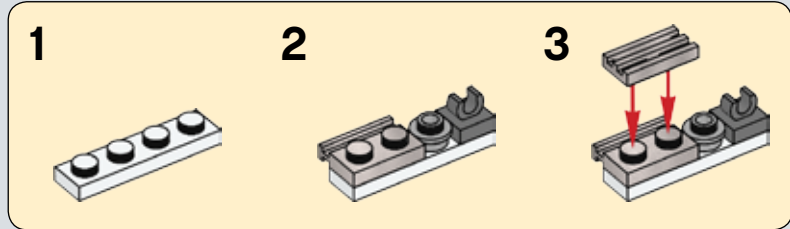



2x



1x

242

1

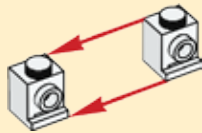

2

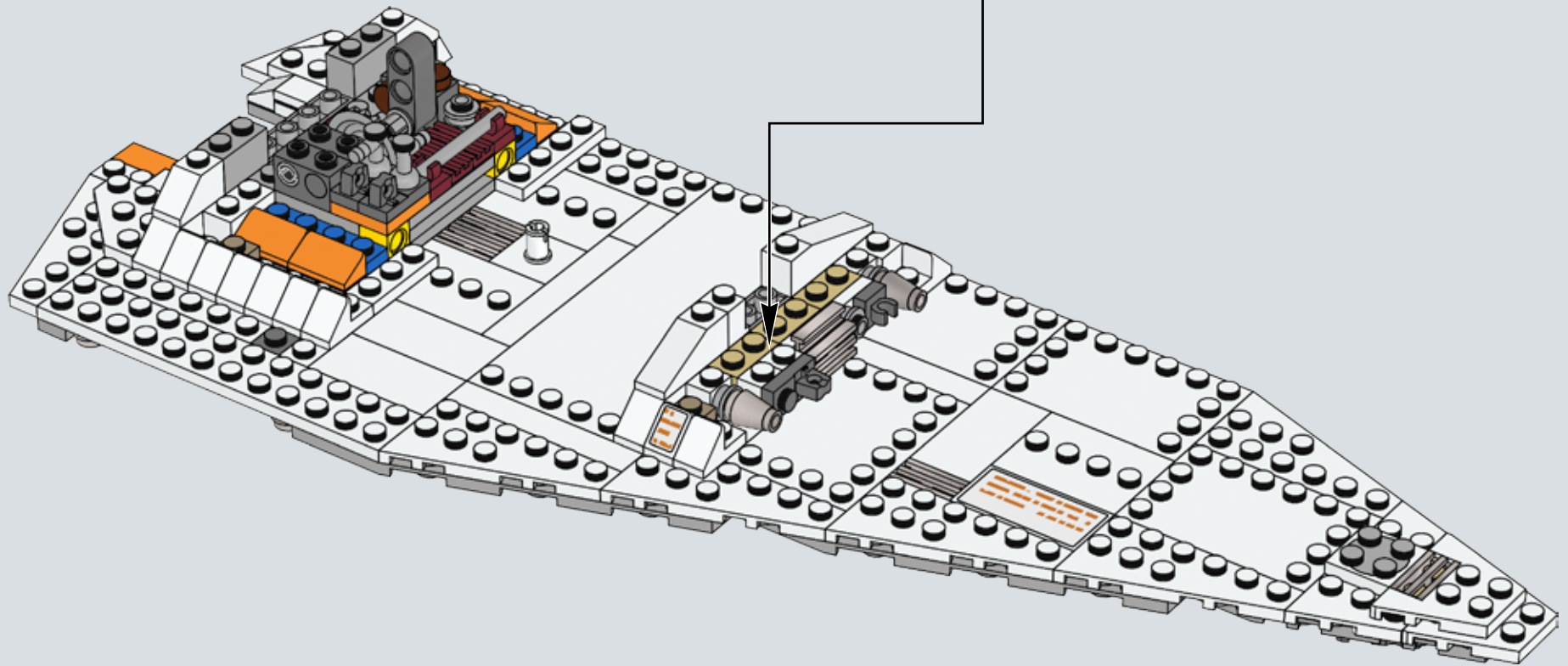

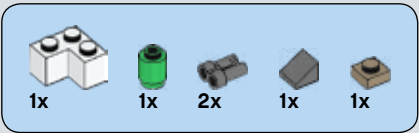

243

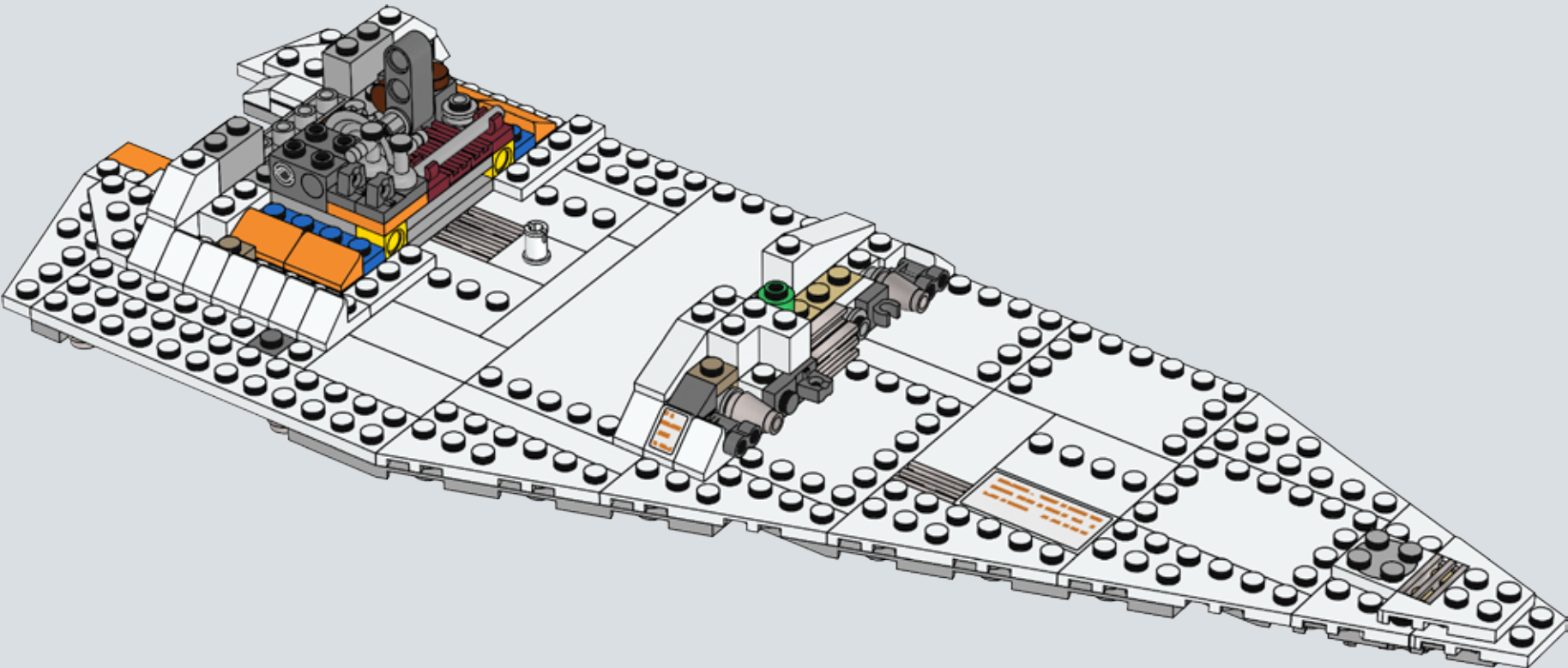

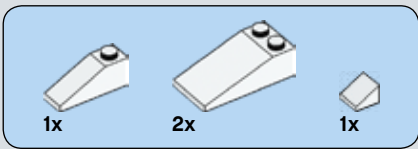

244

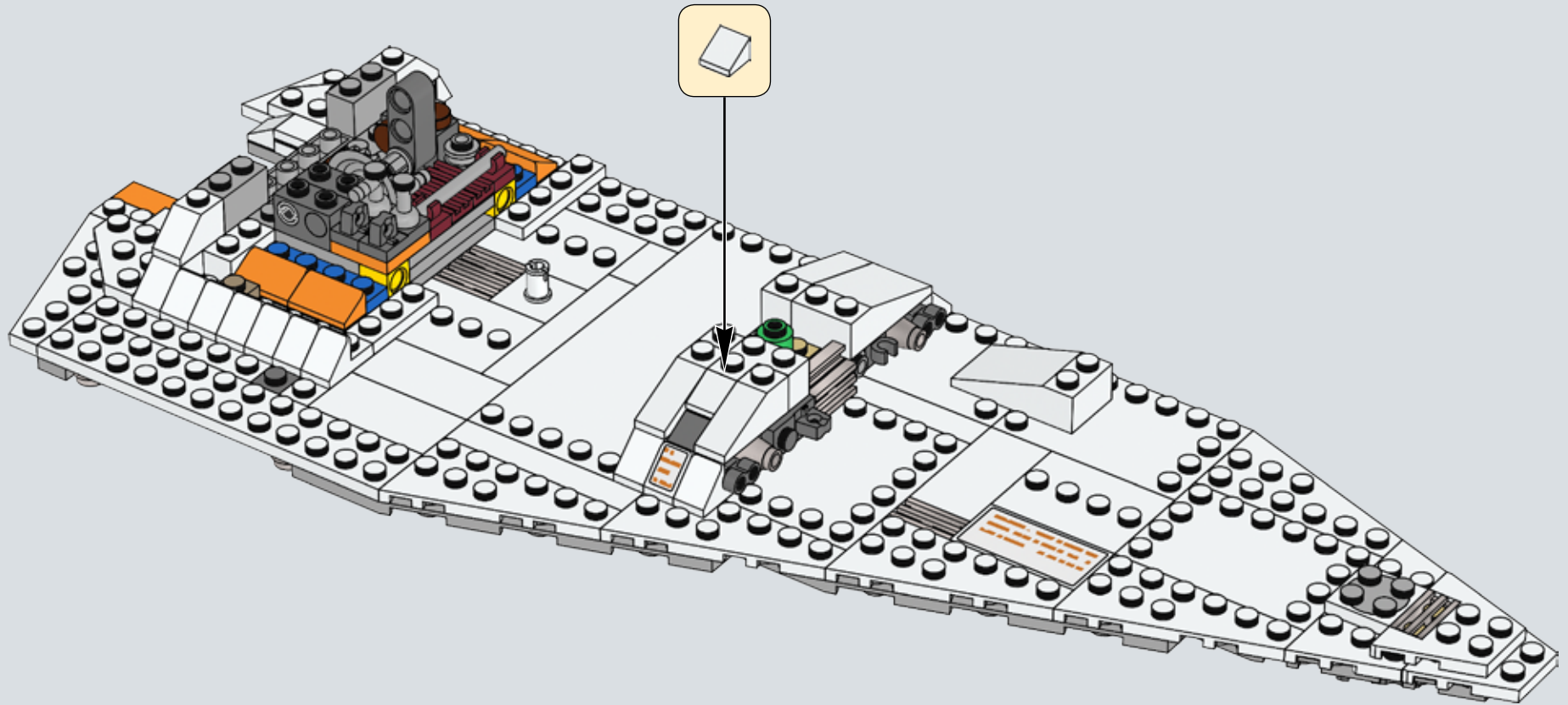

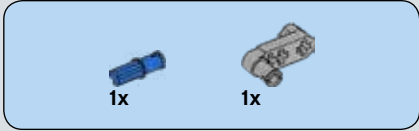
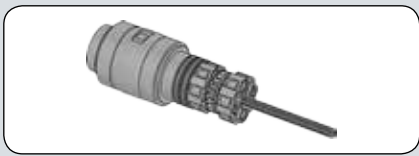

245

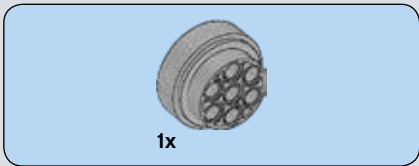
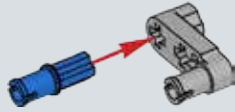

246

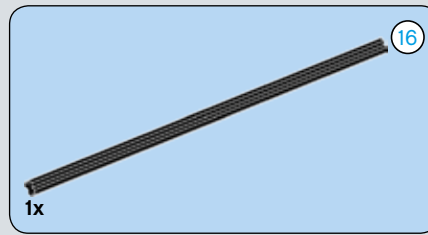
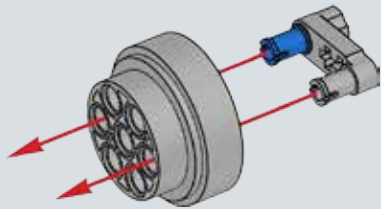

247

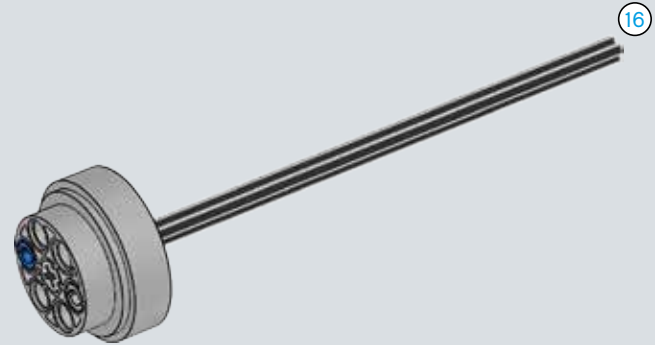

248

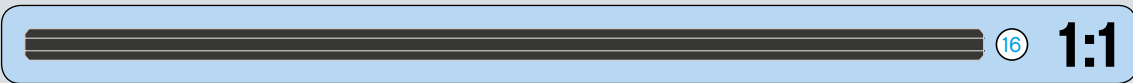
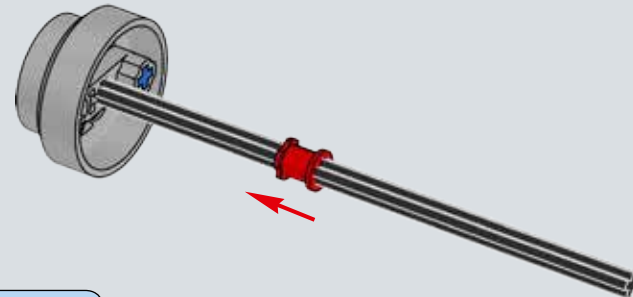

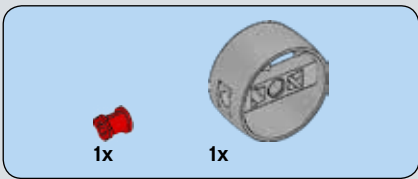

249

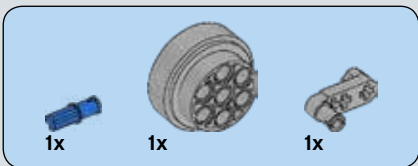
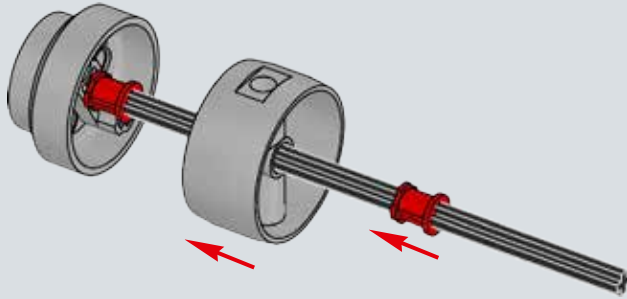

250

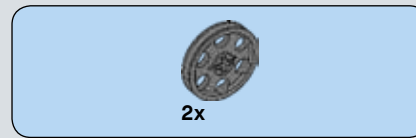
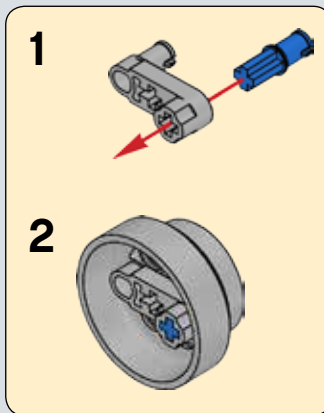
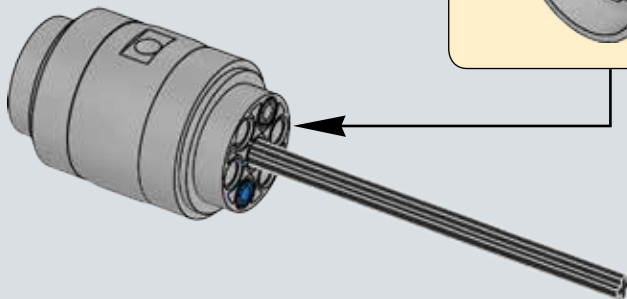

251

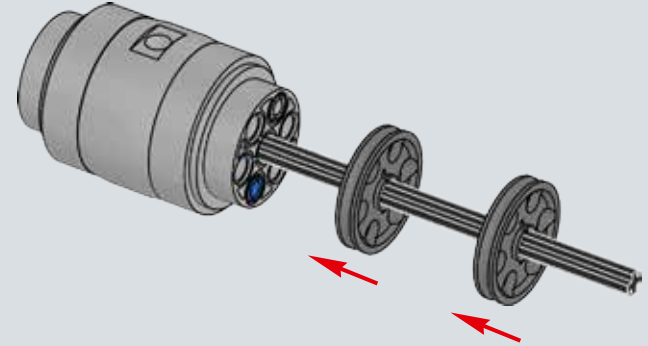

252

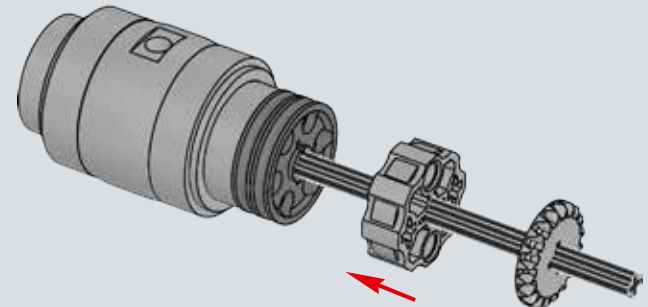

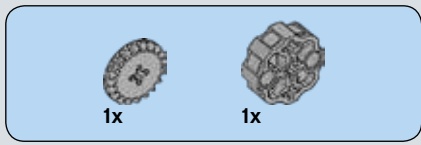

253

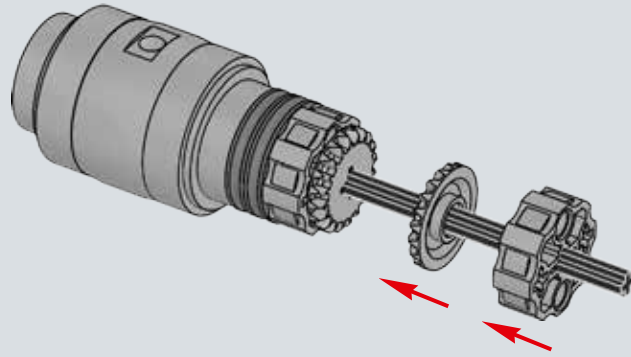

254

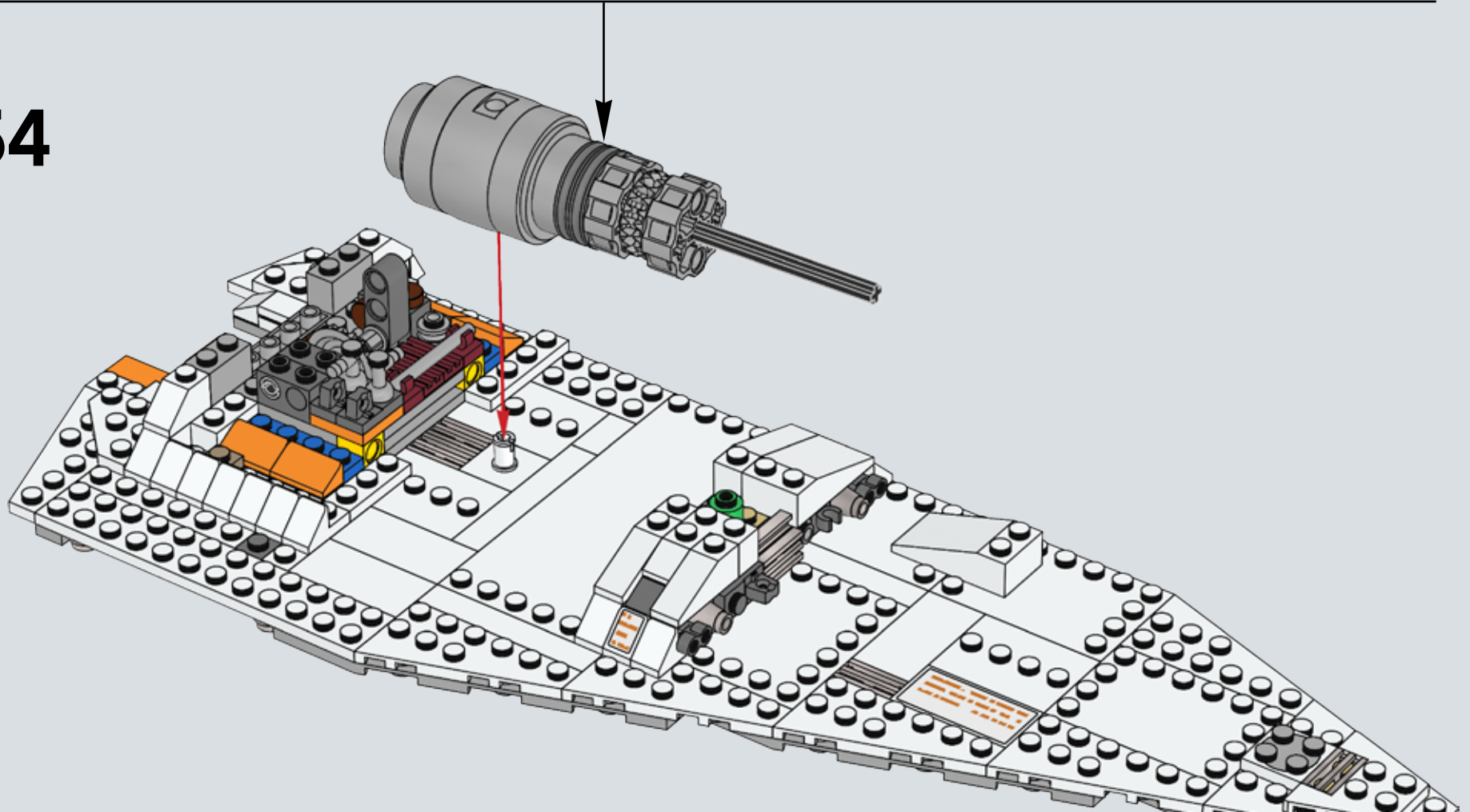

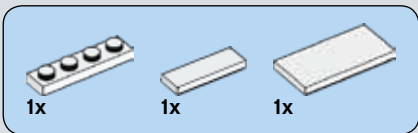

255

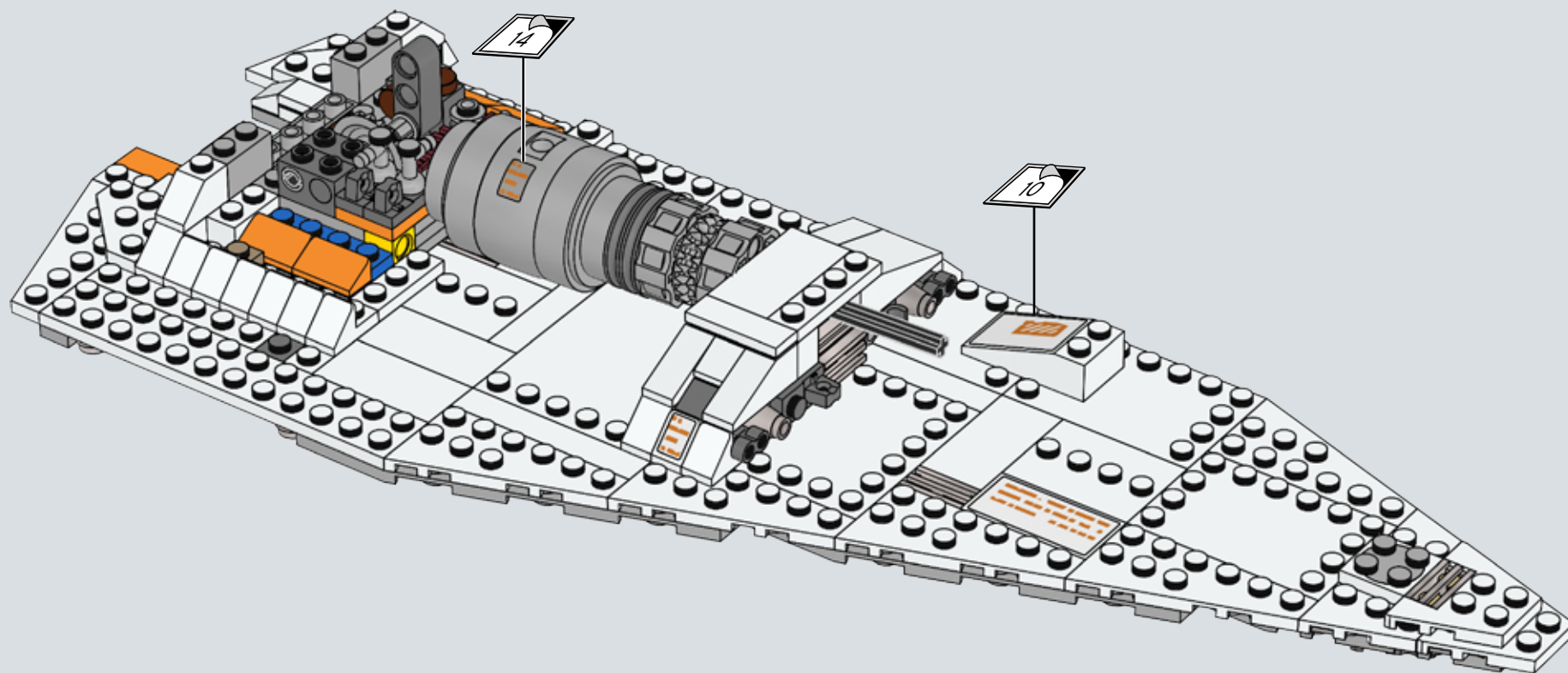



1x



1x

256

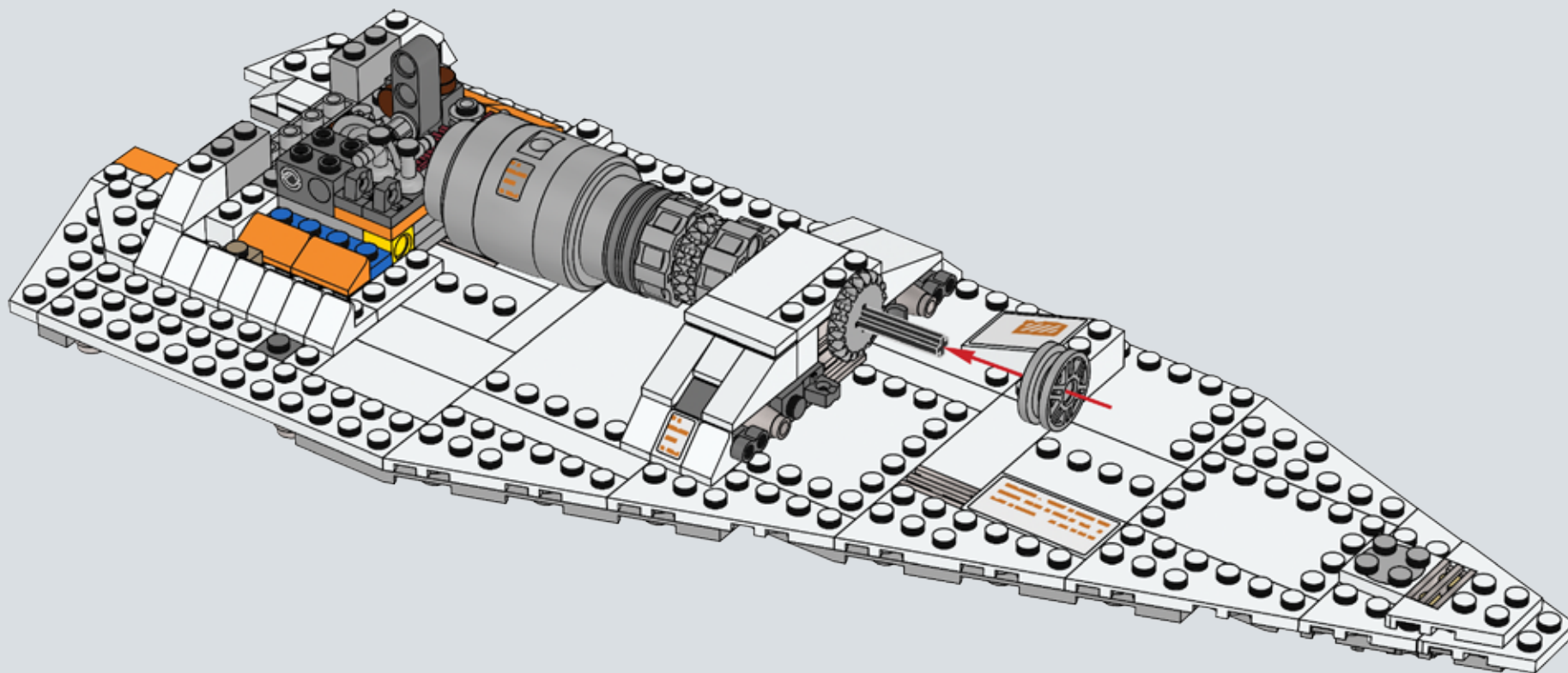



257

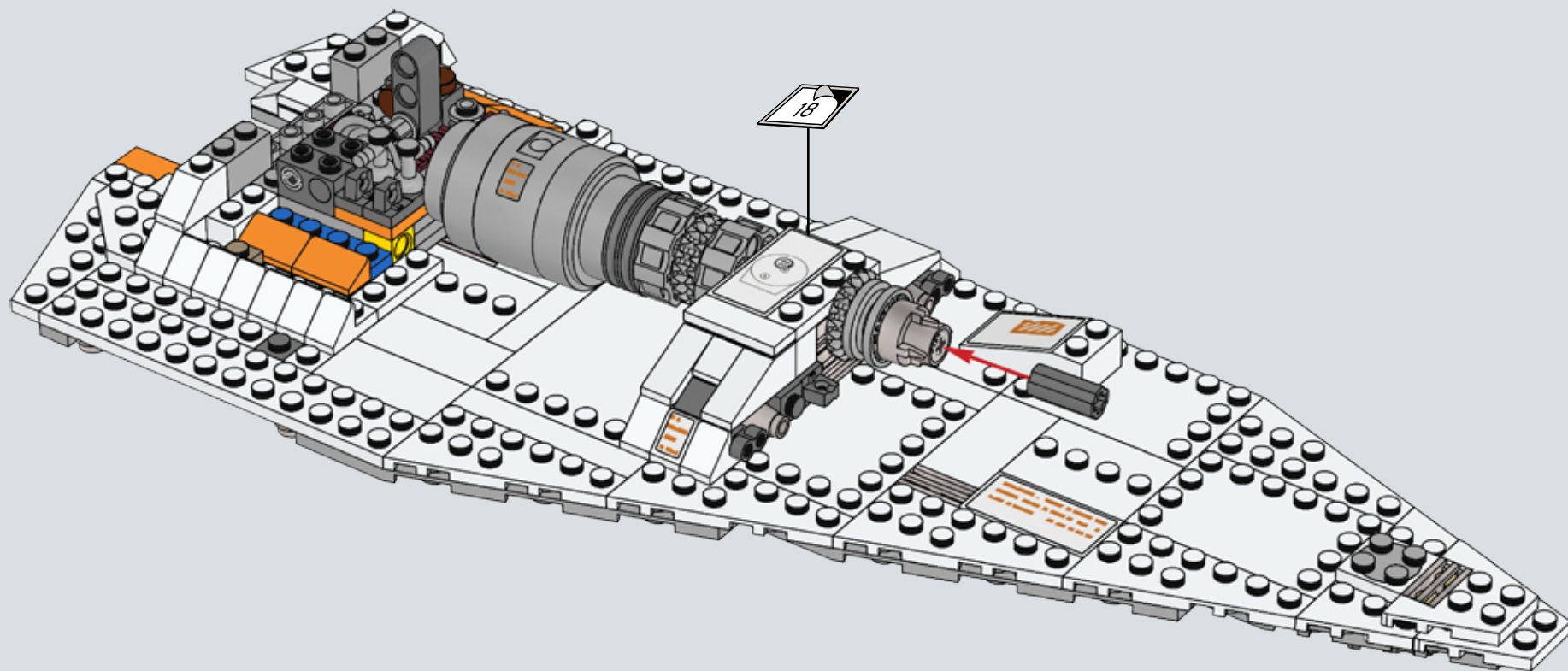

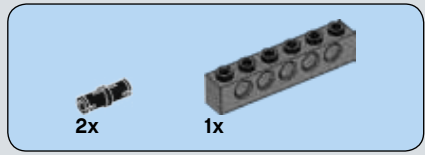
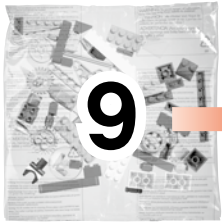

258

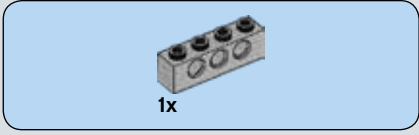
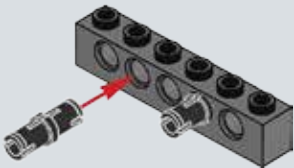

259

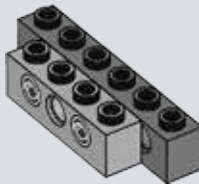

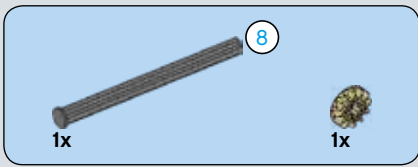

260

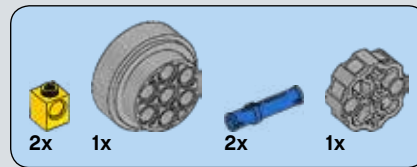
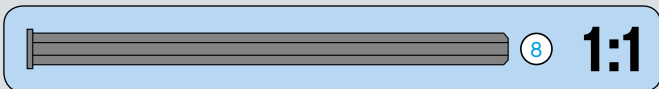
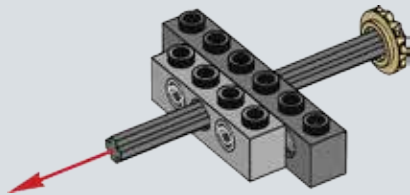
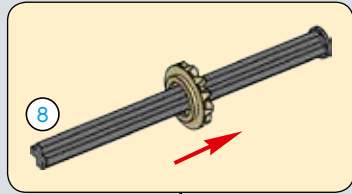

261

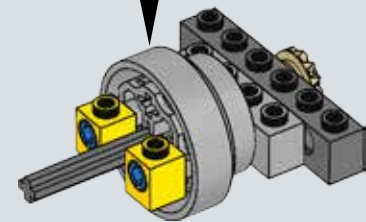
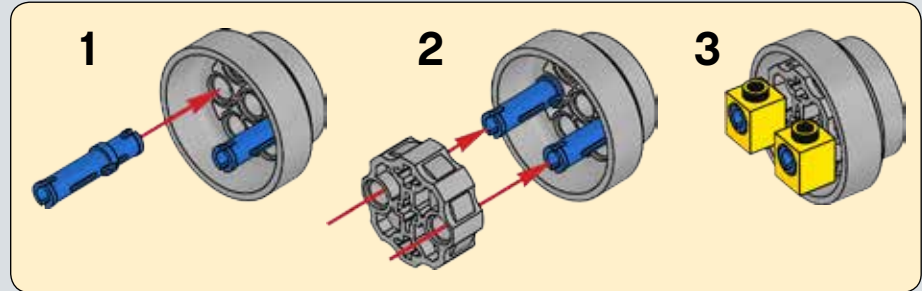

262

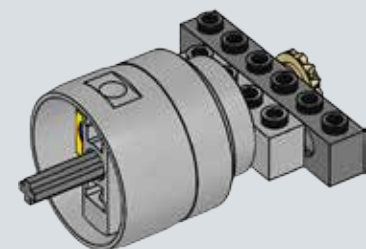

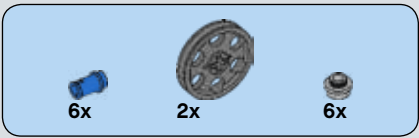

263

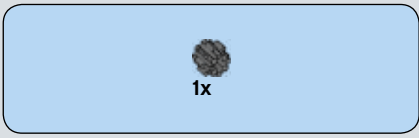
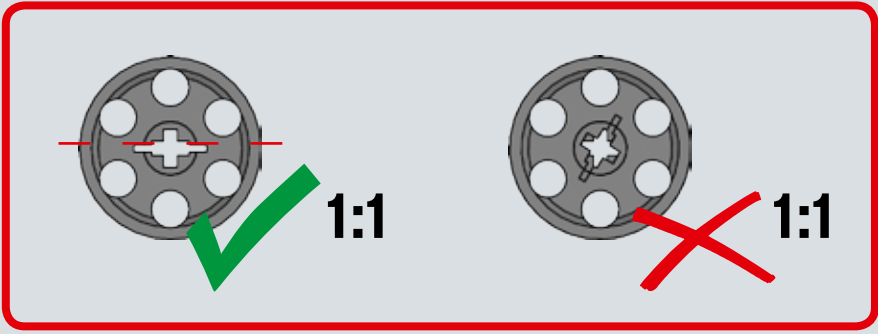
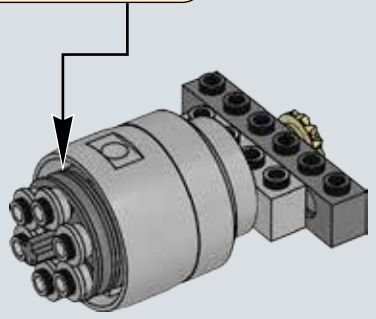
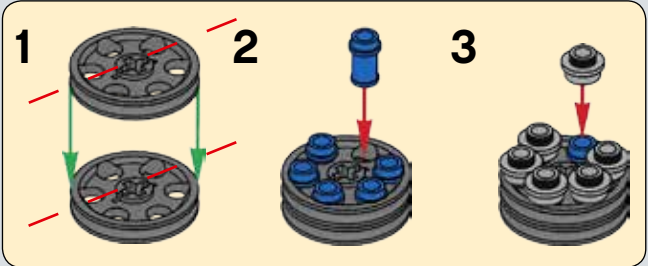

264

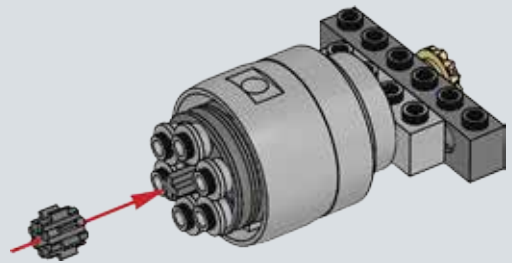

265

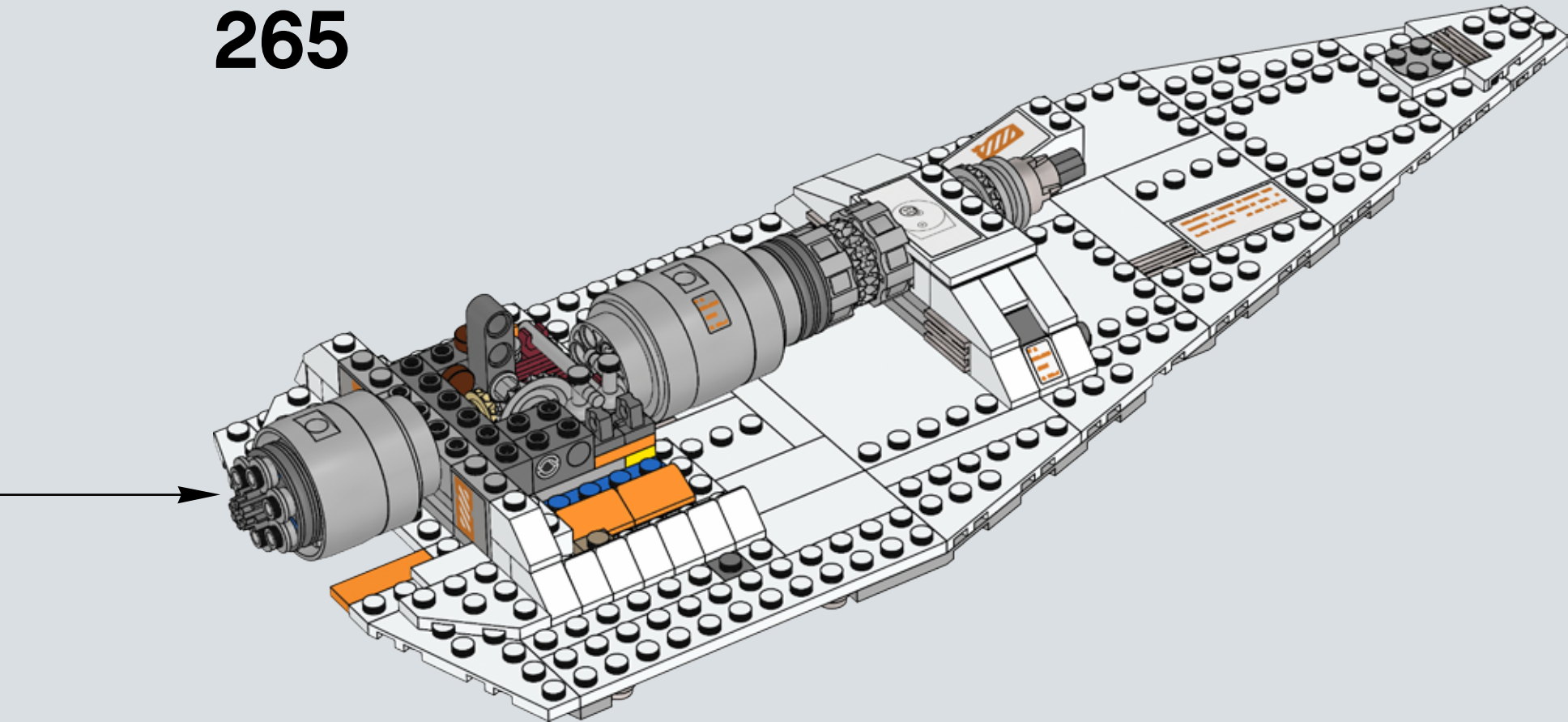



266

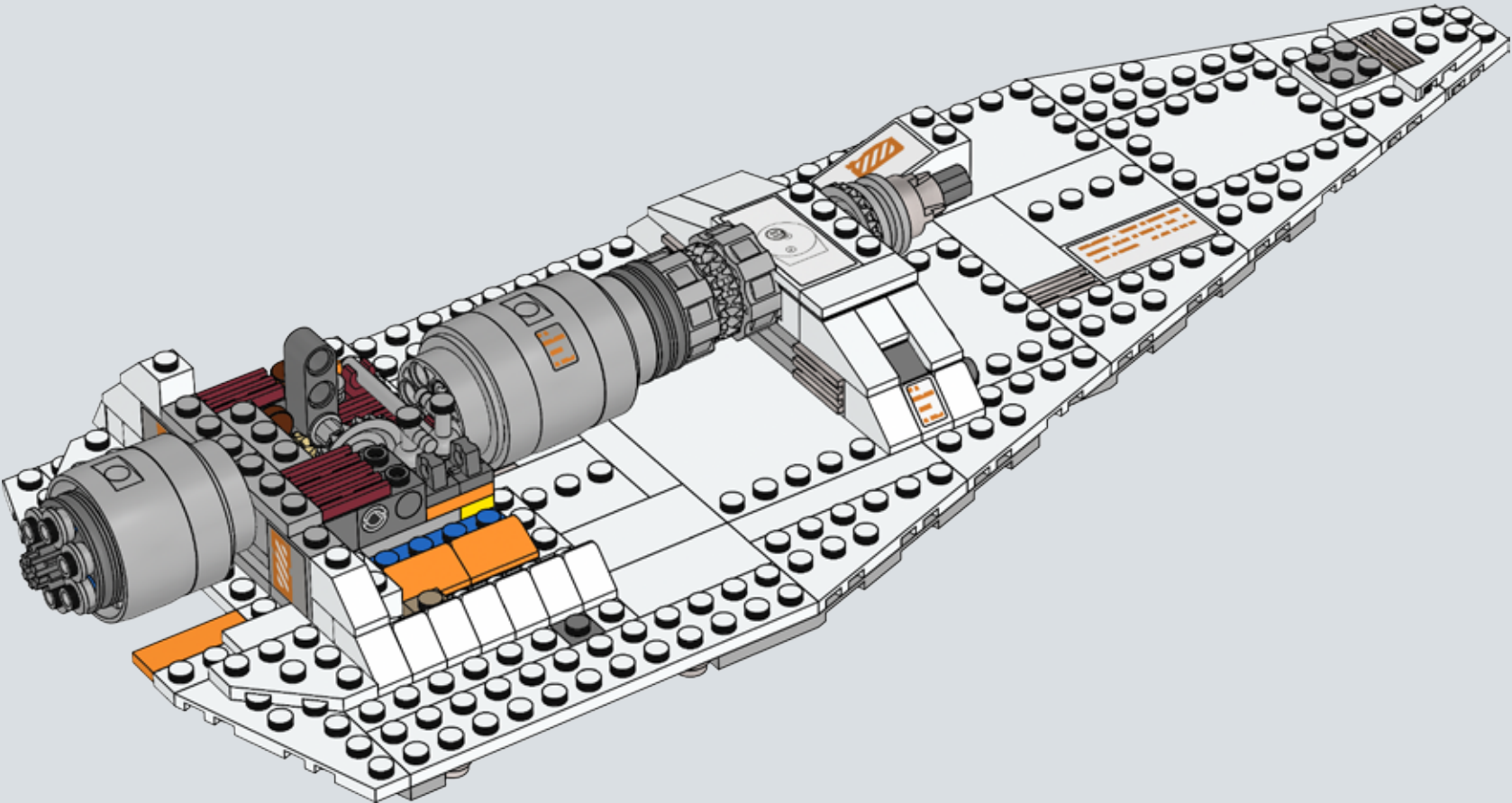



267

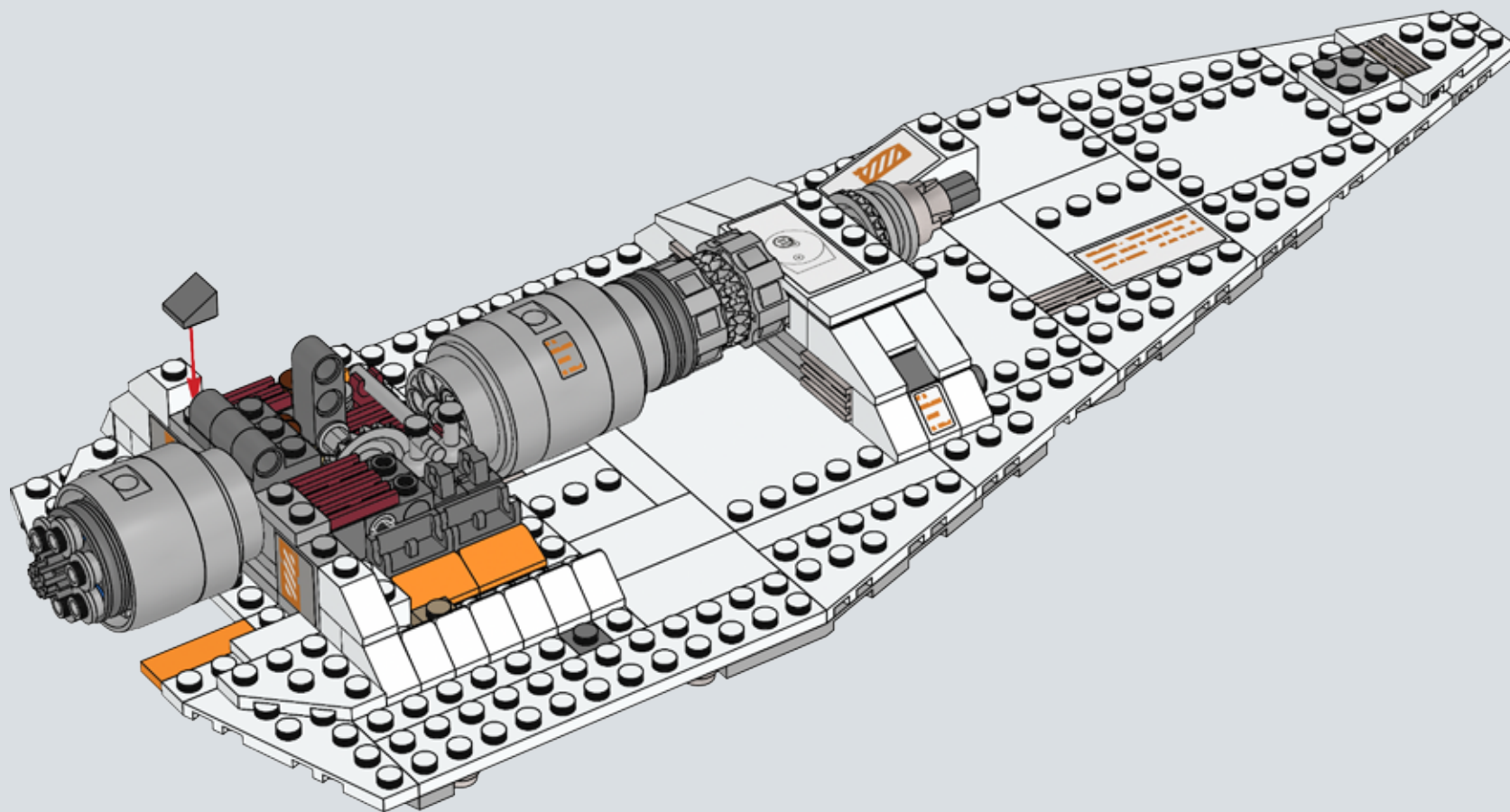



268

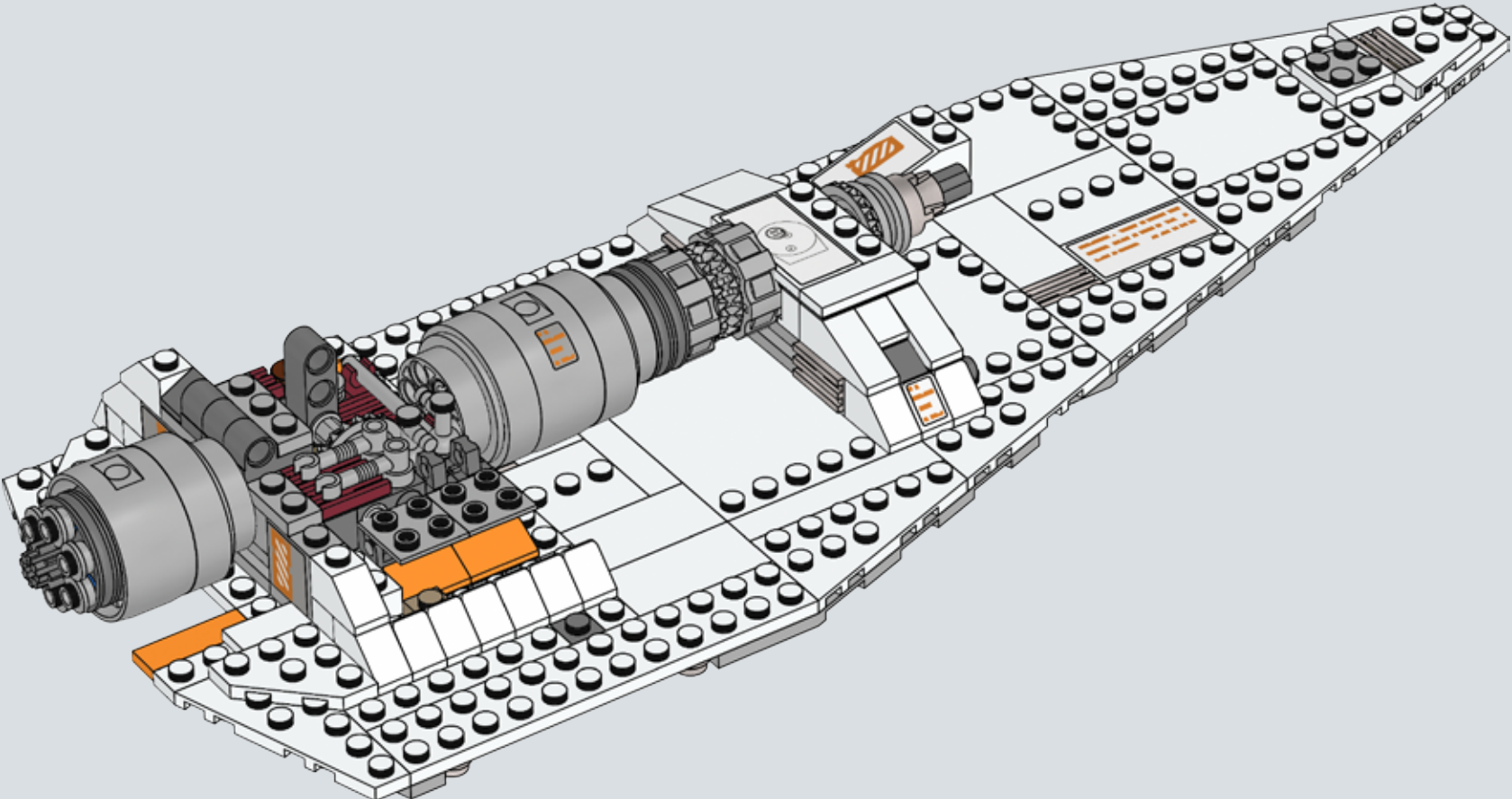



269

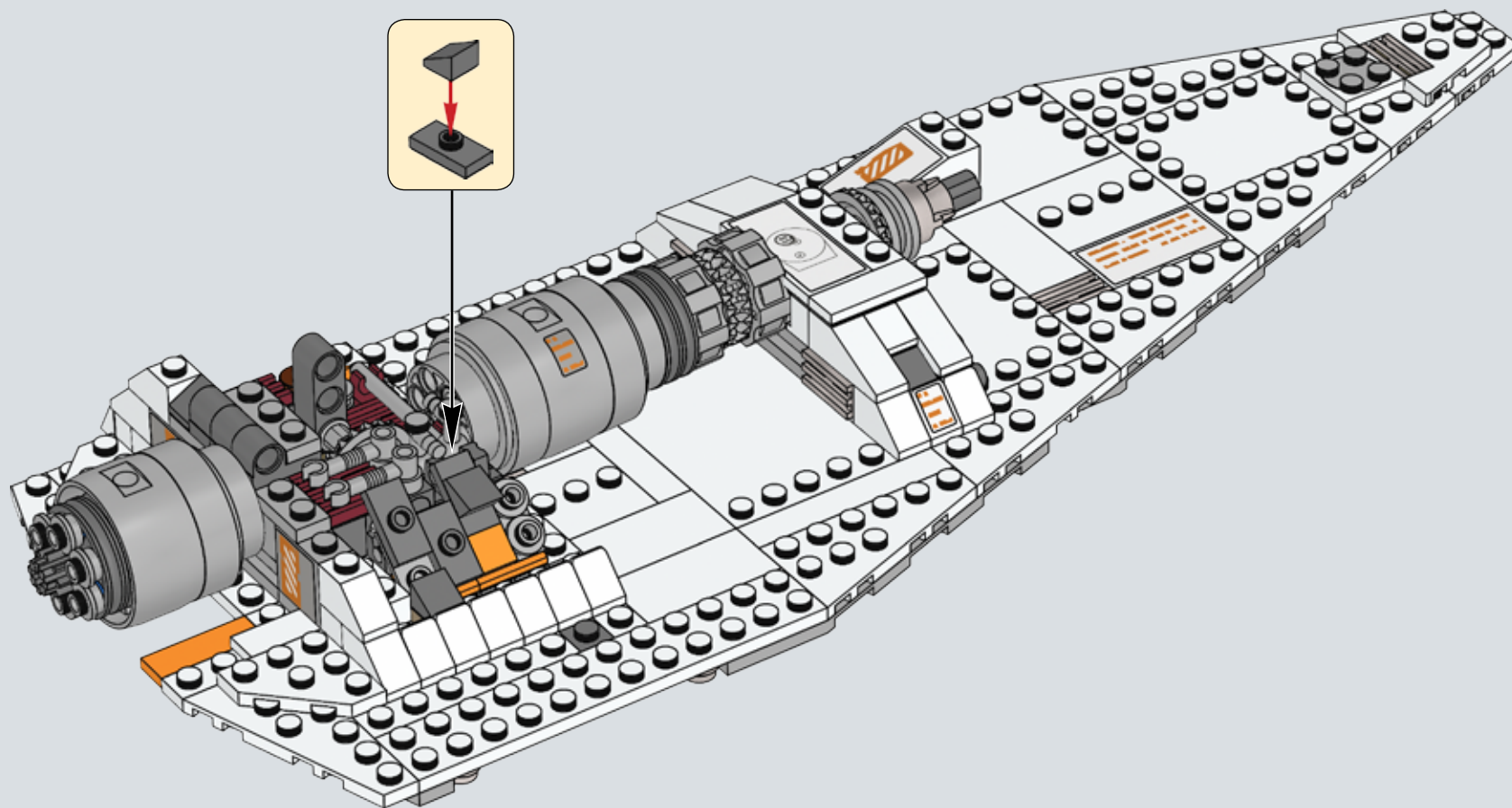



270

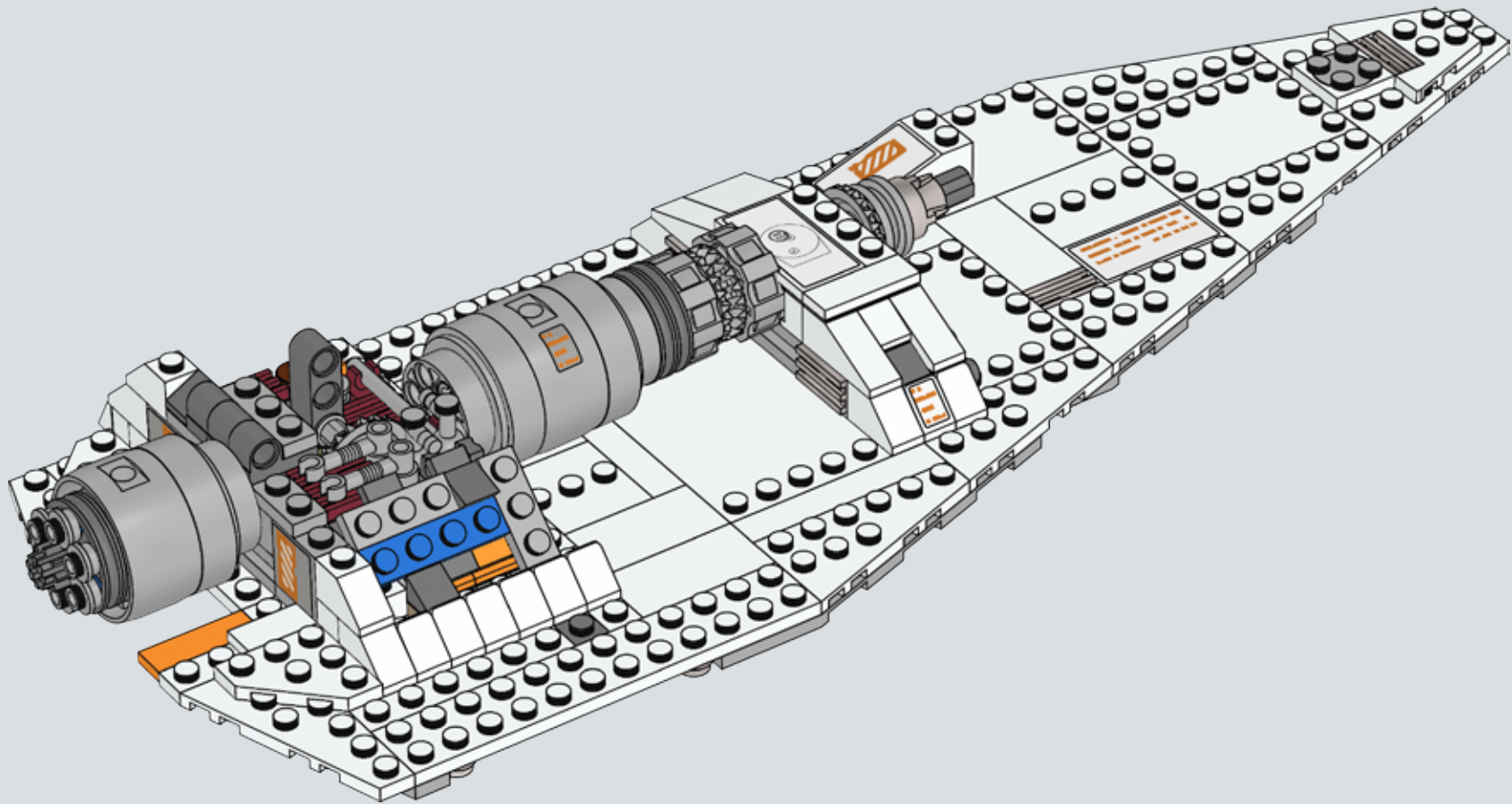

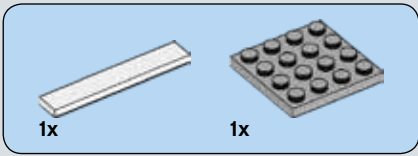
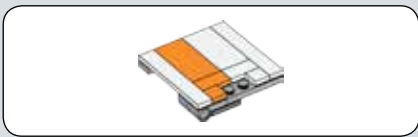

271

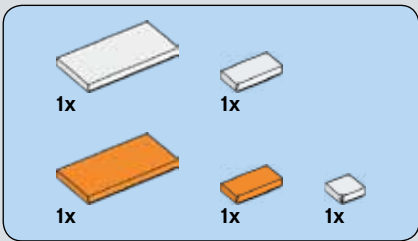
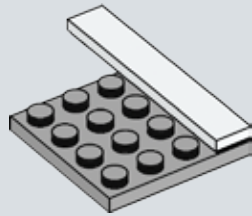

272

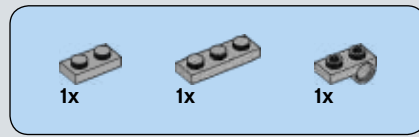
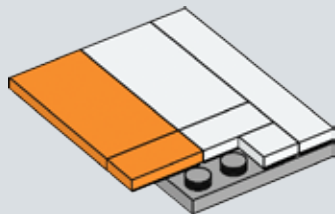

273

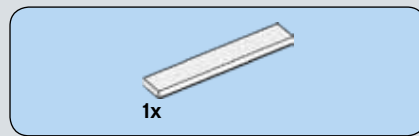
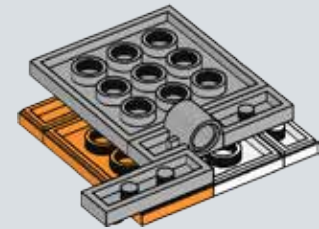
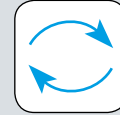

274

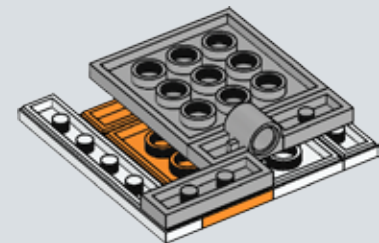



2x

275

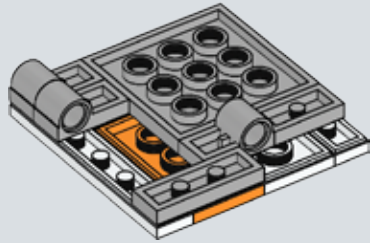

1x



1x

276

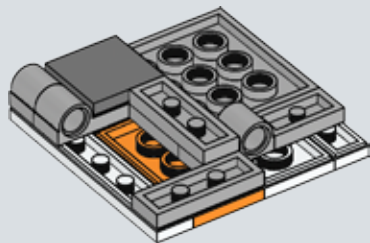

1x

277

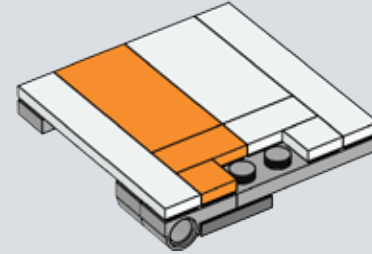

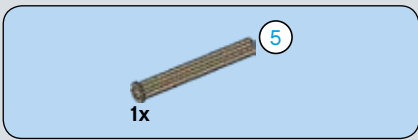

278

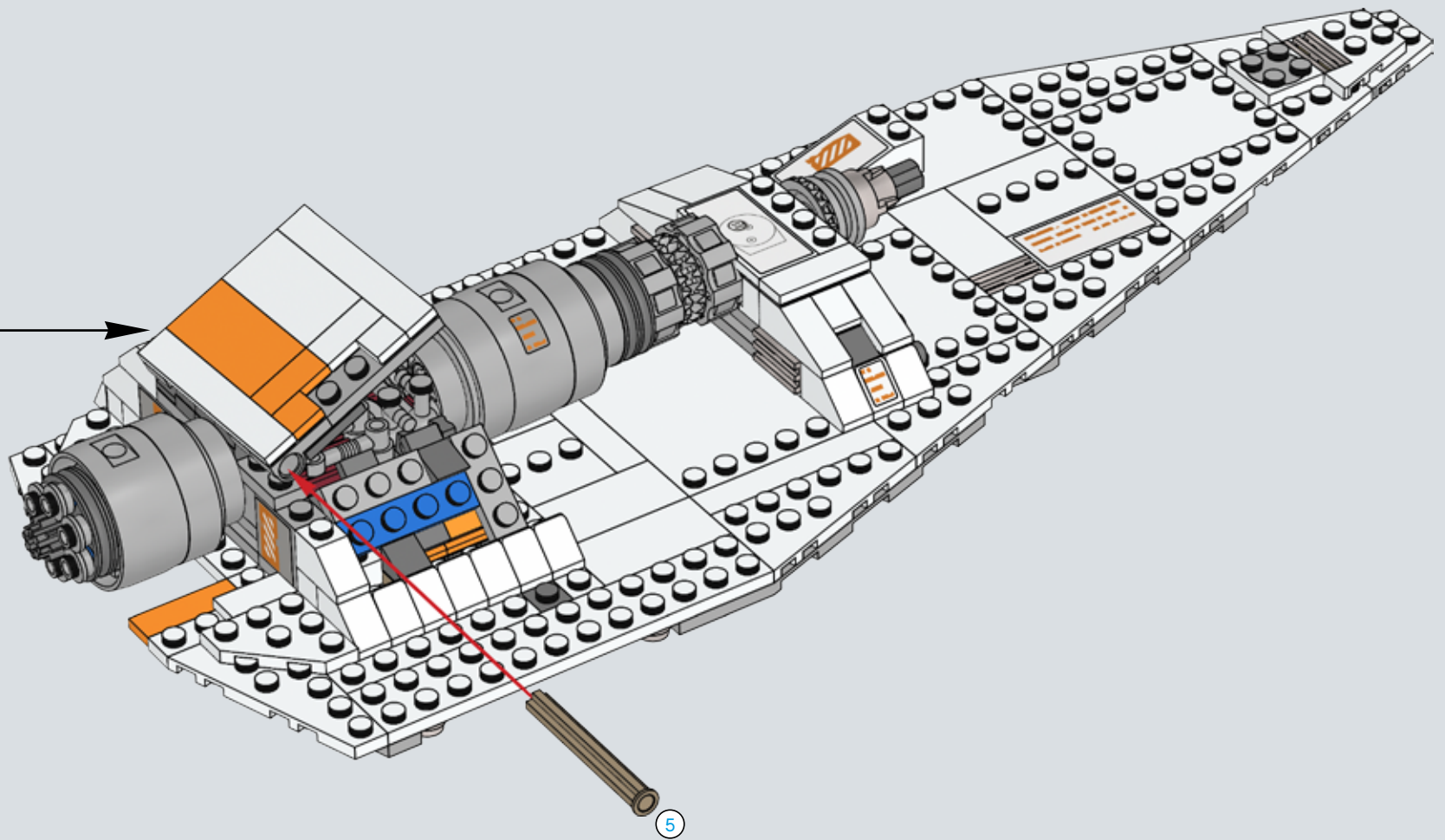



1x

279

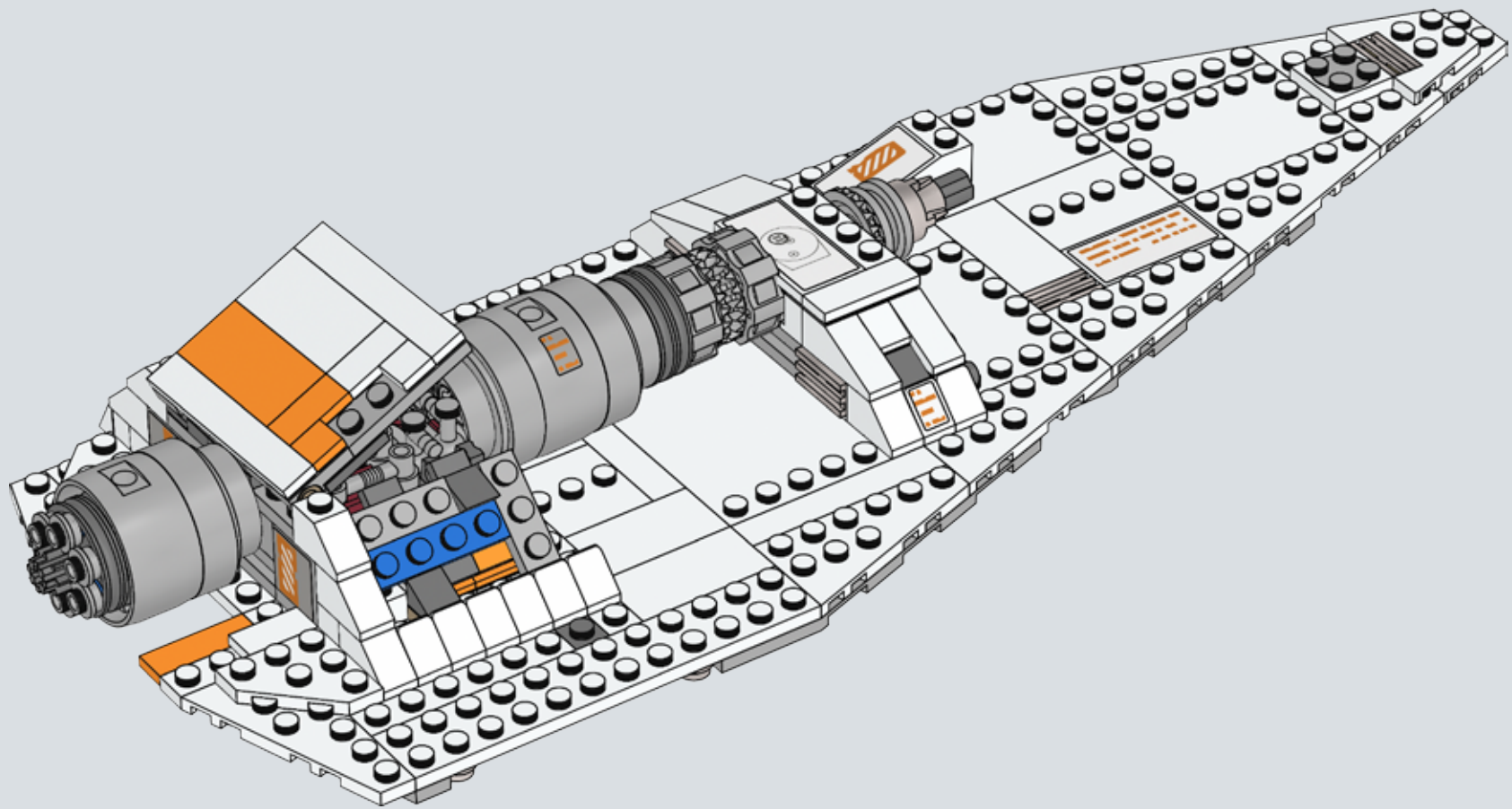

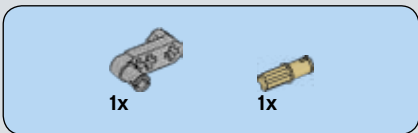

280

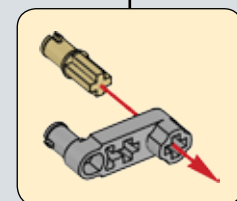
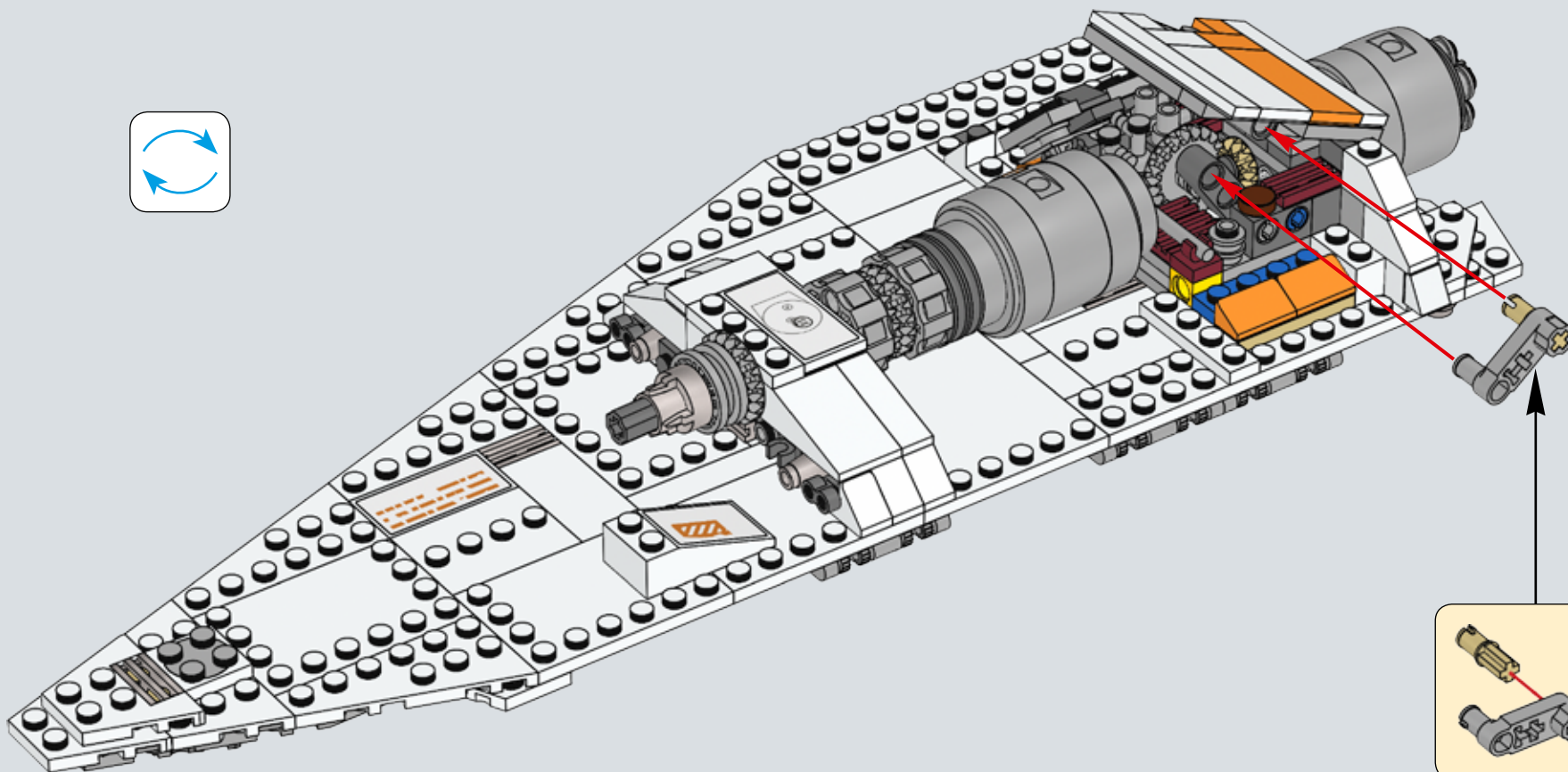
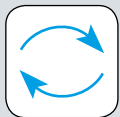

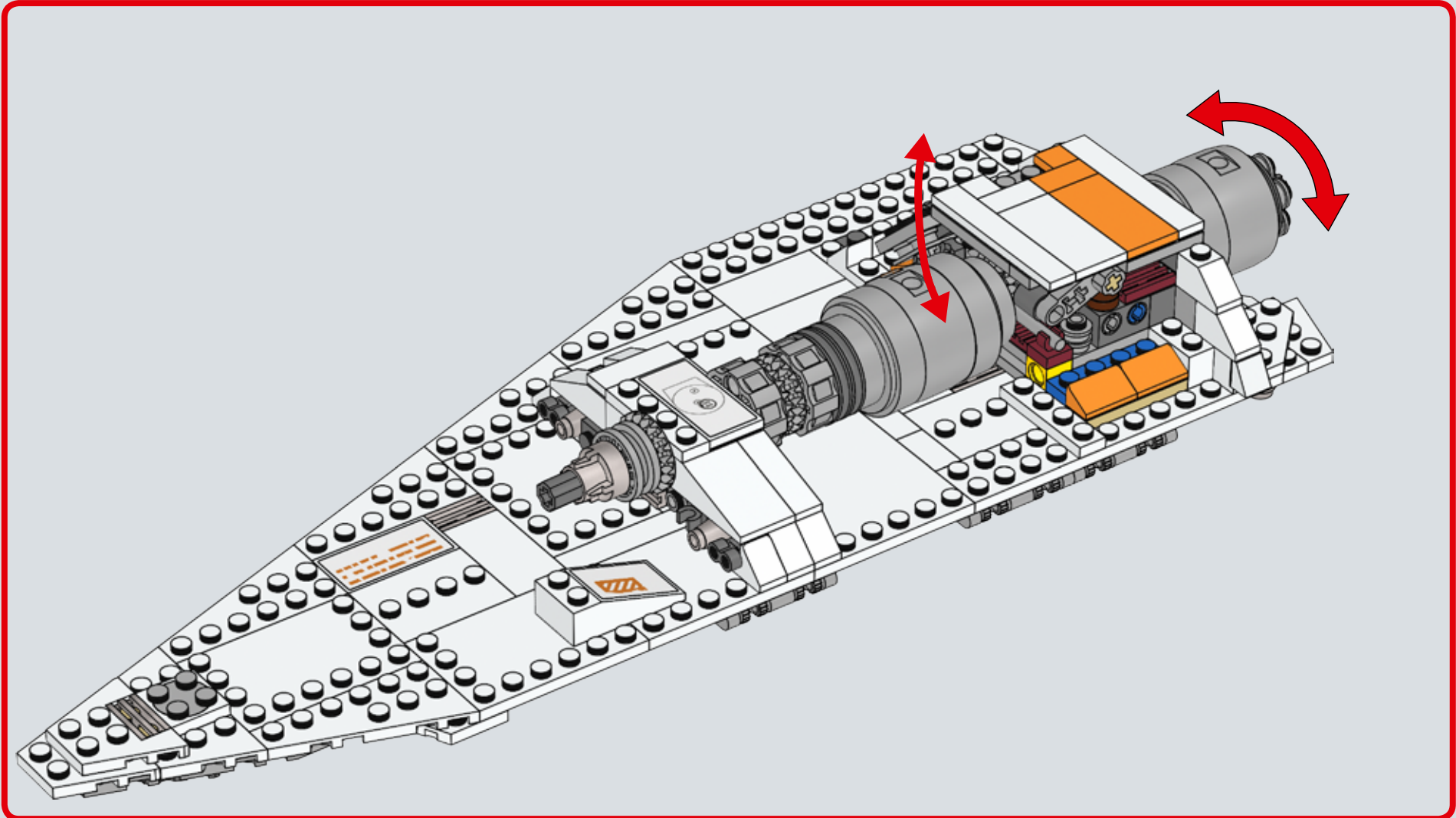



281

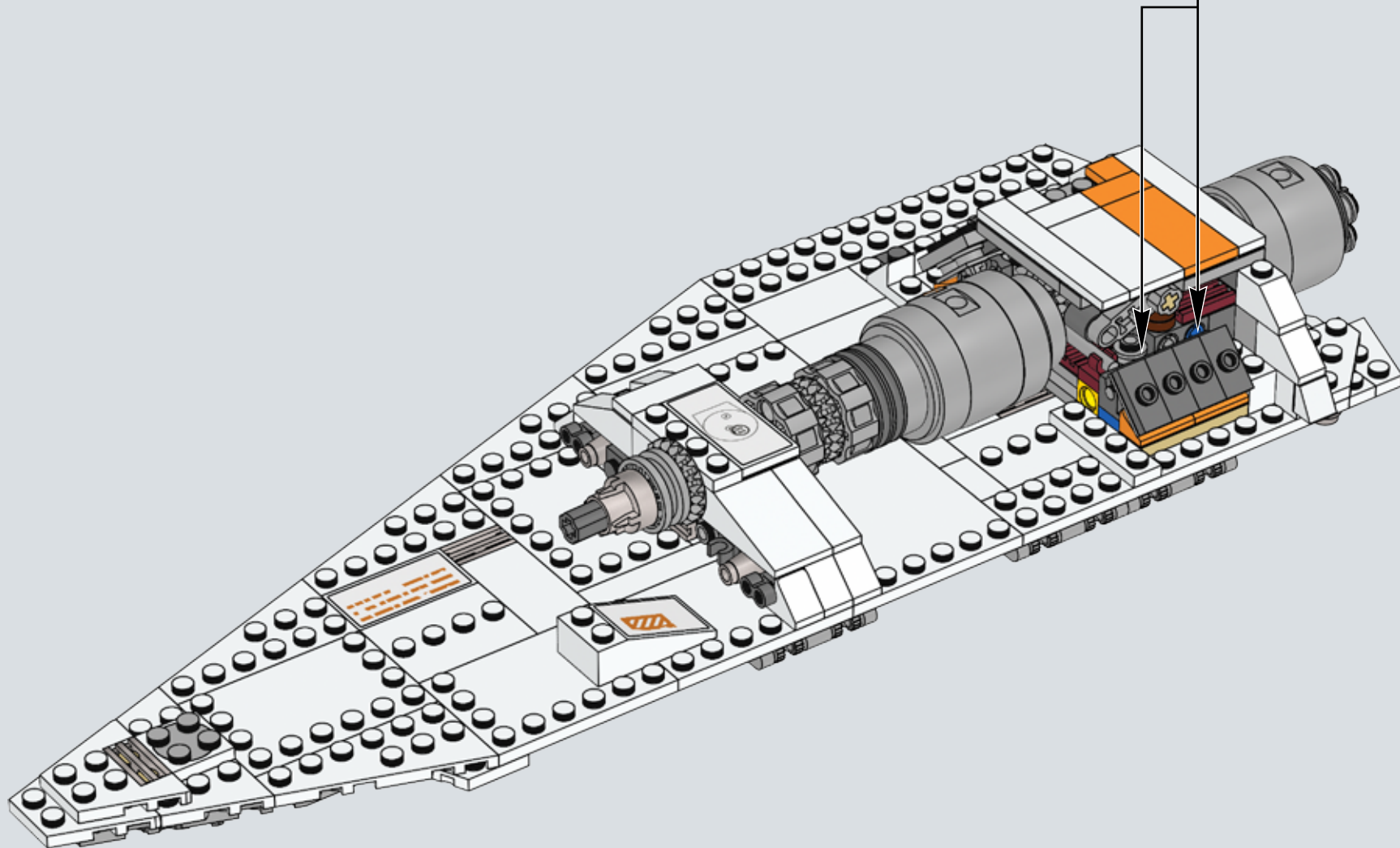
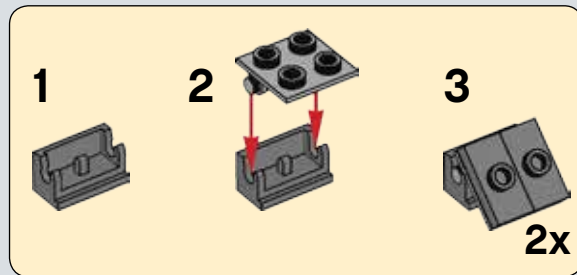

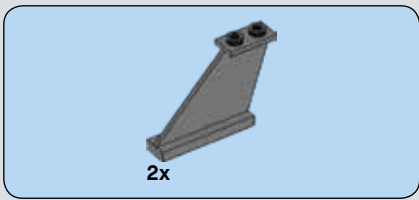

282

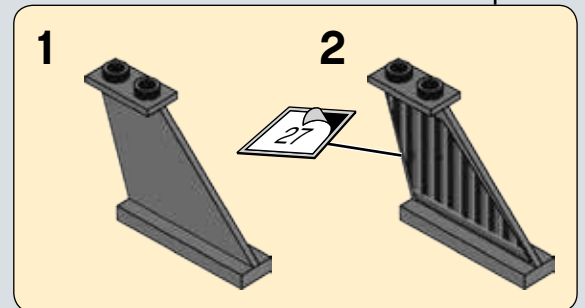
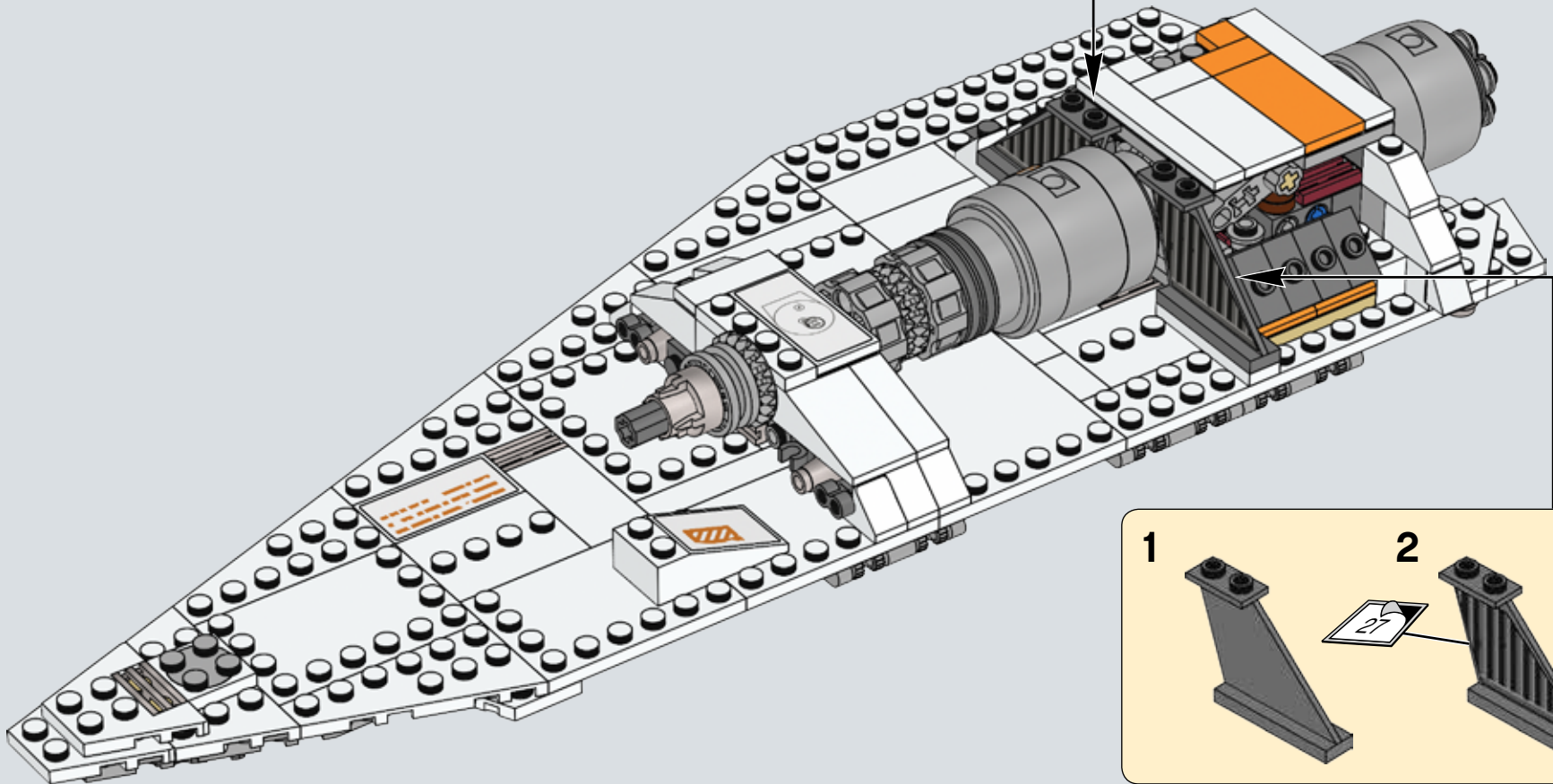
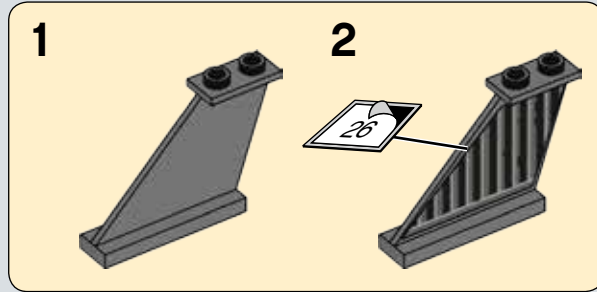



283

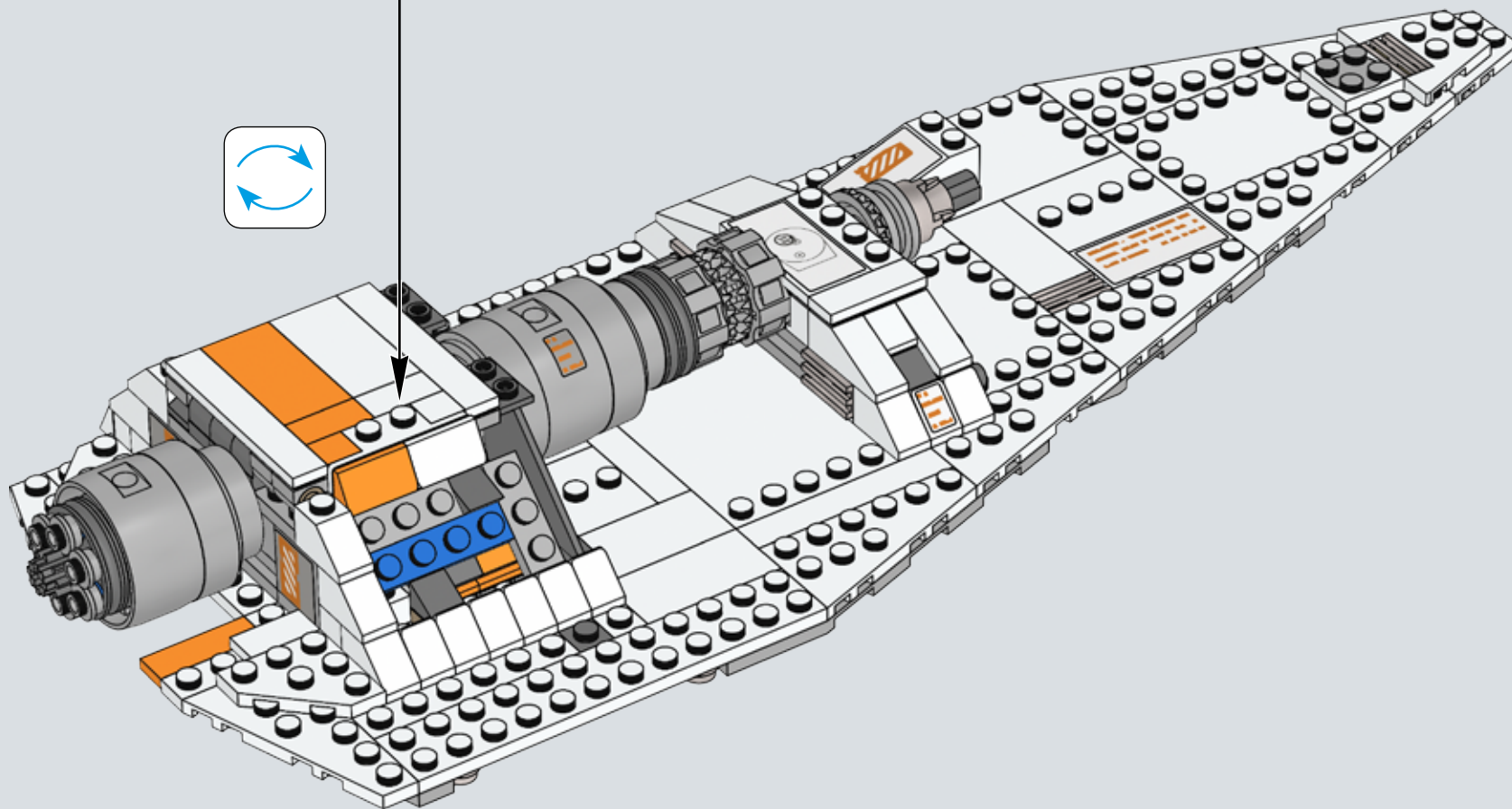
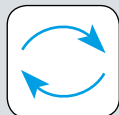
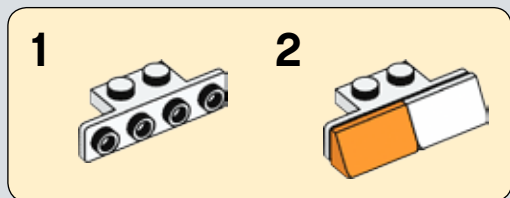

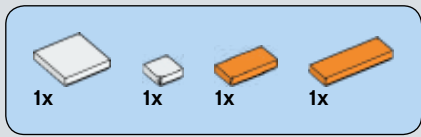

284

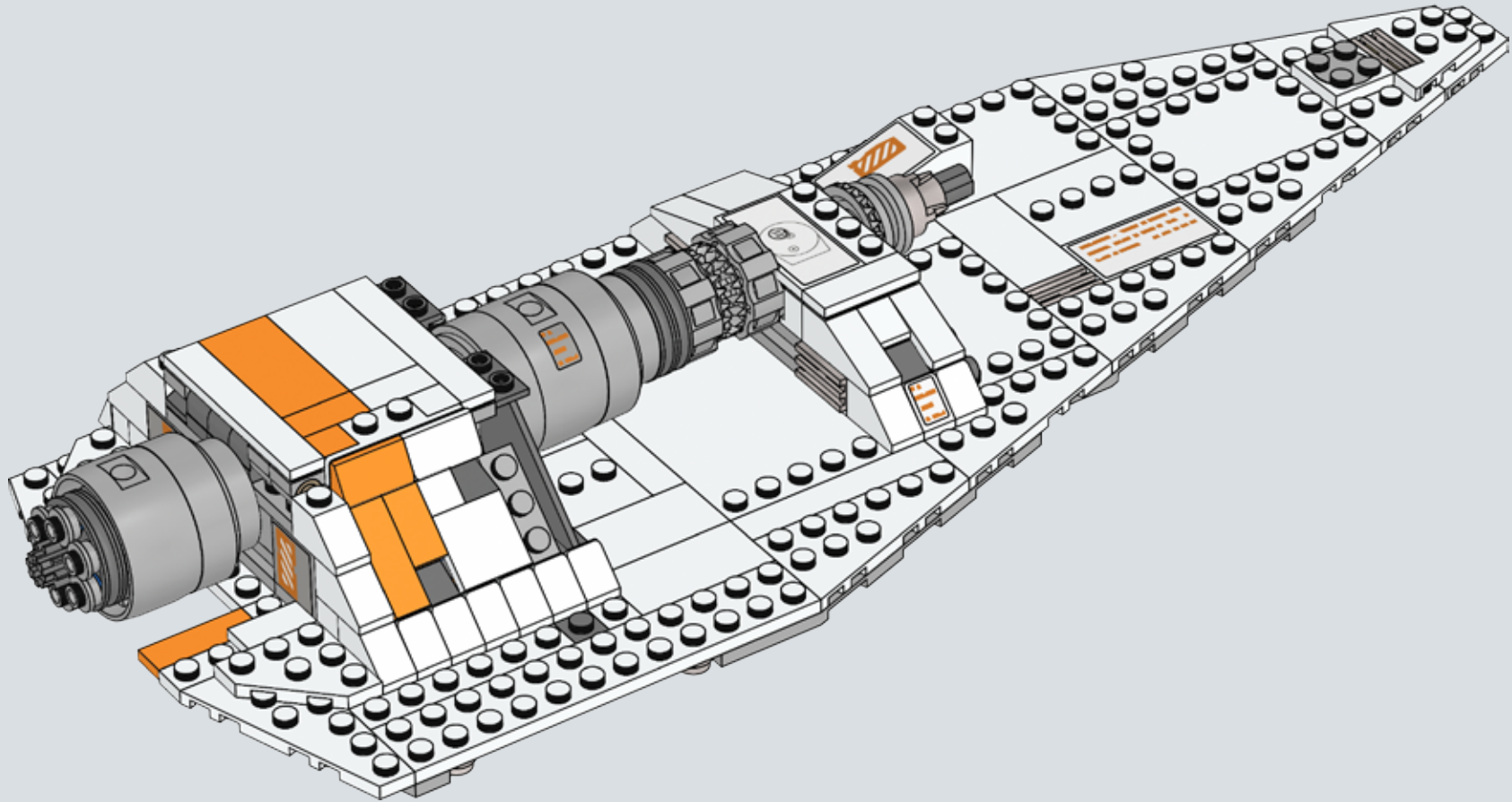

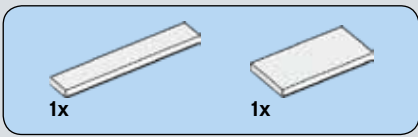

285

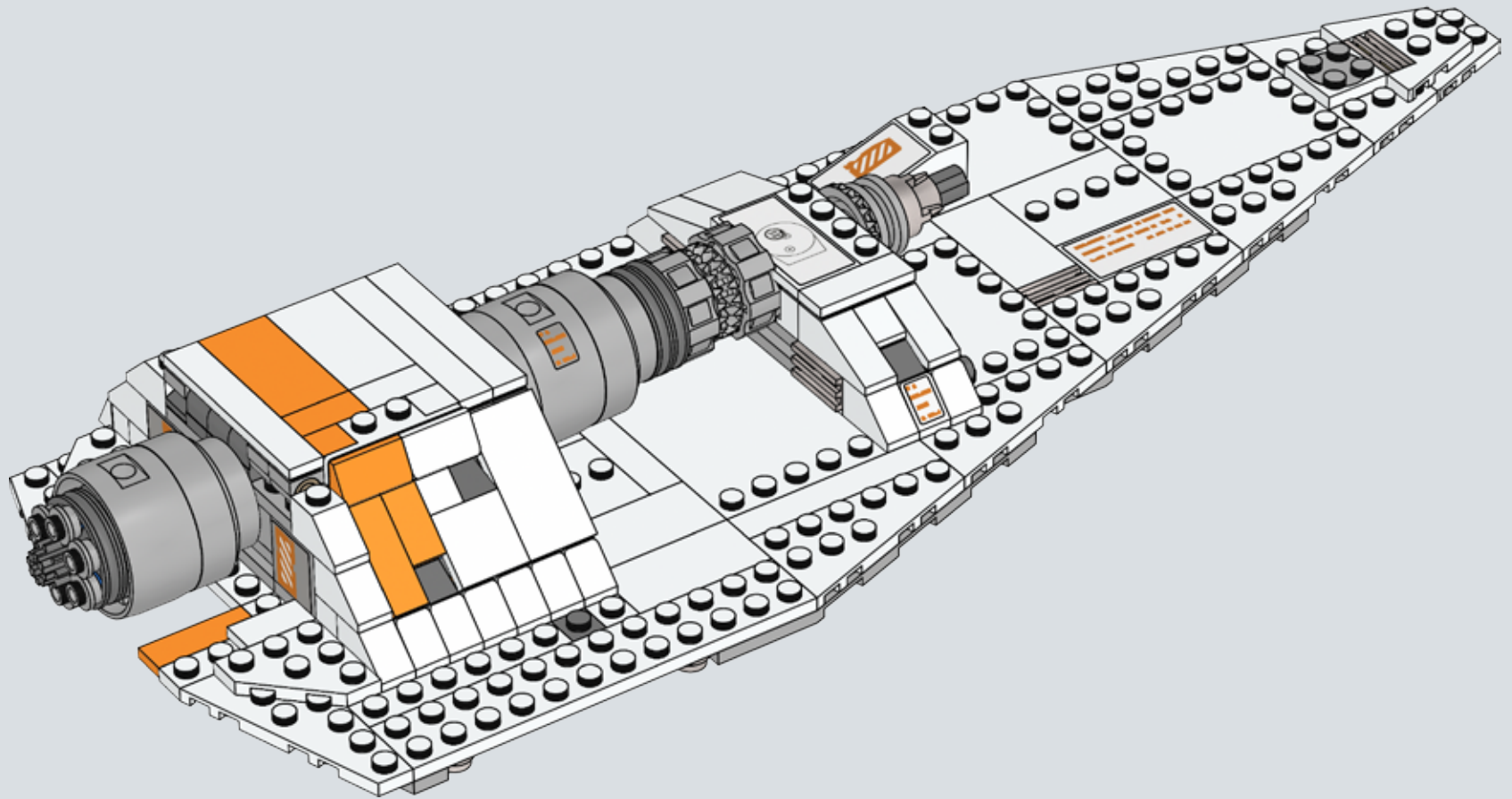



2x



3x

286

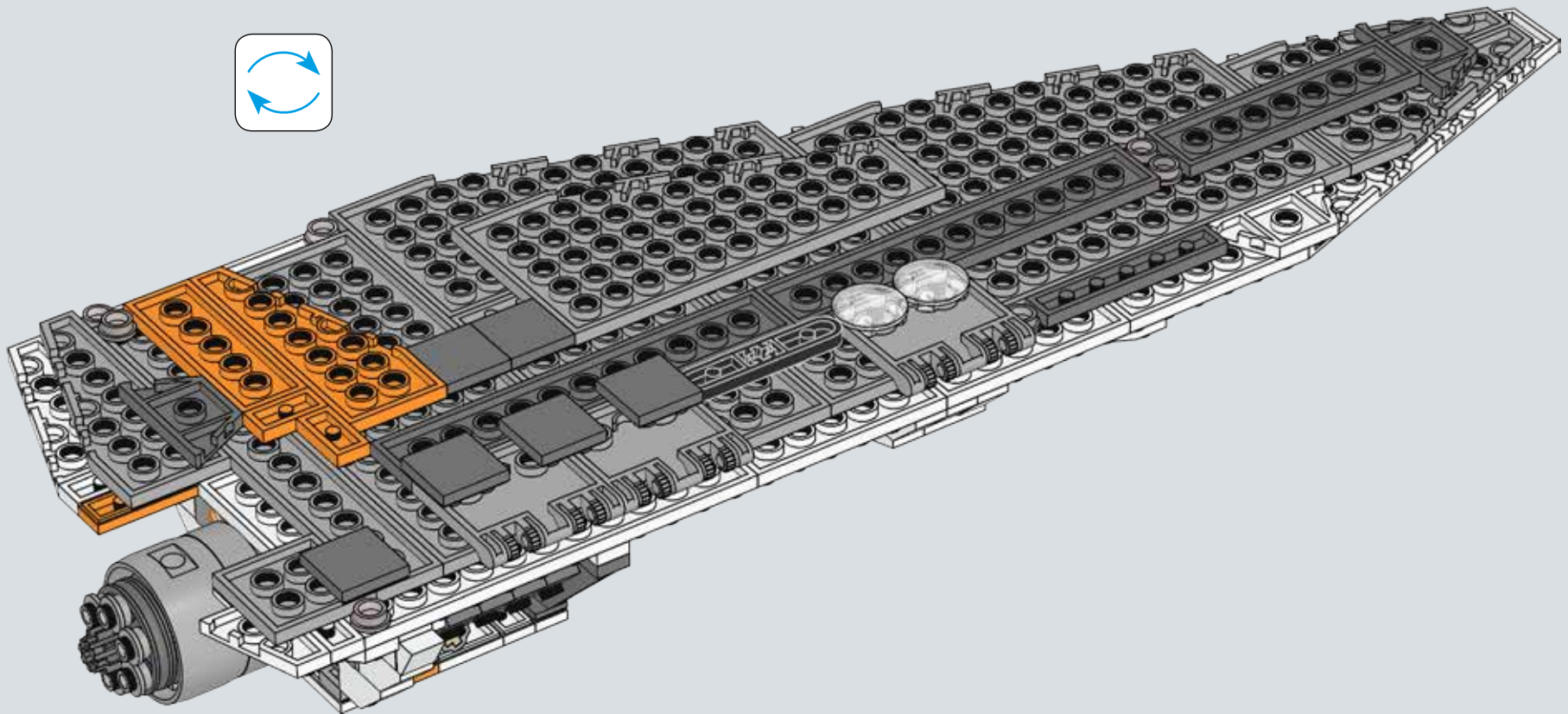
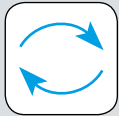

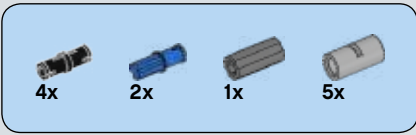

287

1



2

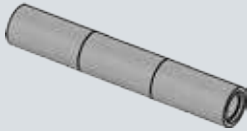

3

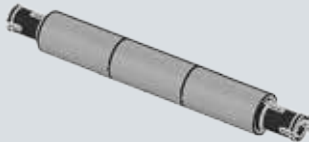

4

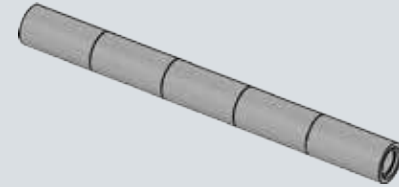

5

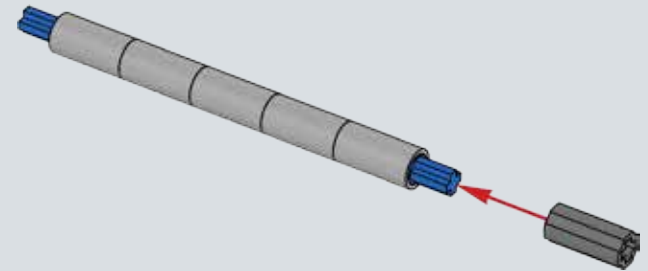

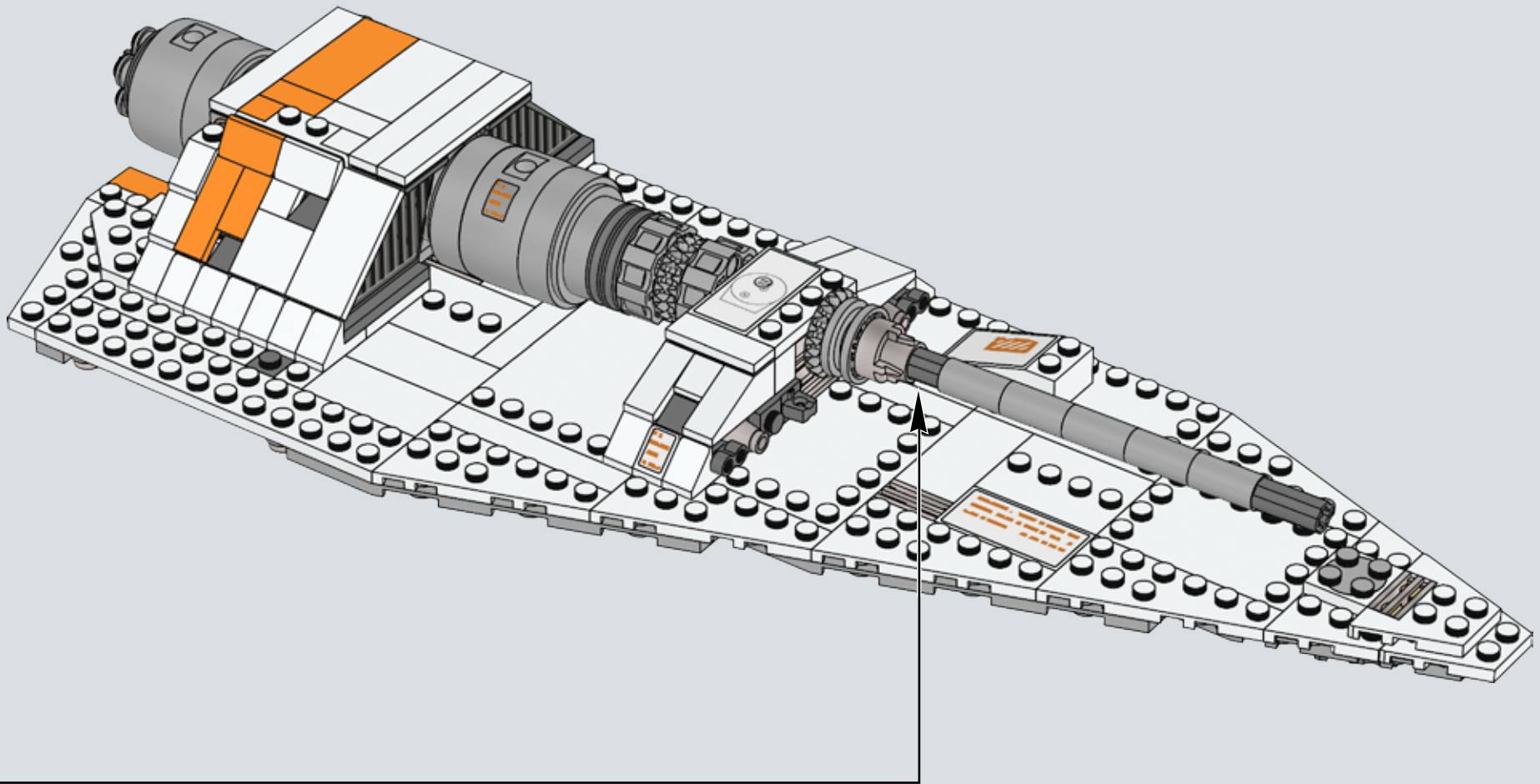
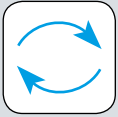

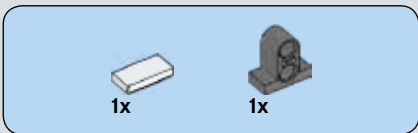

288

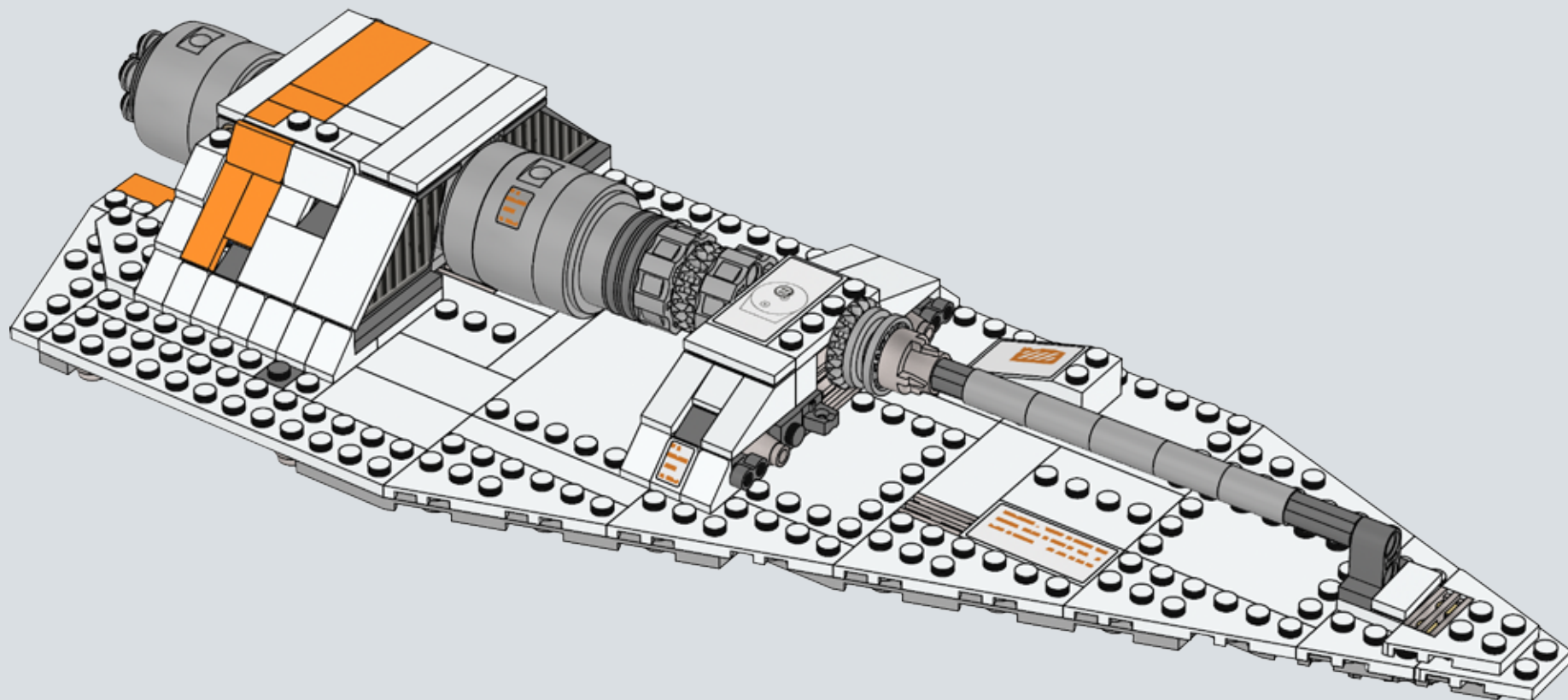

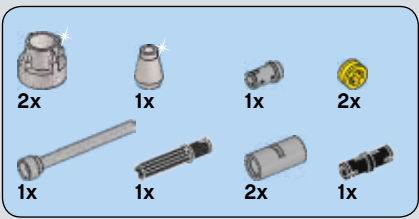

289

1

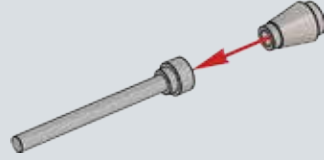

2

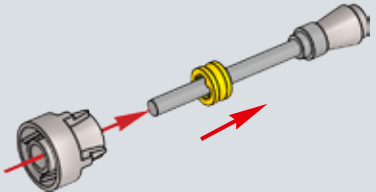

3

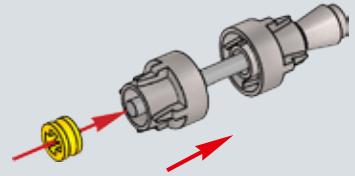

4

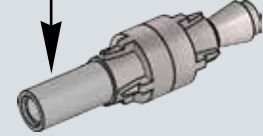
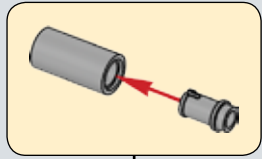

5

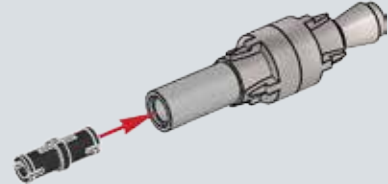

6

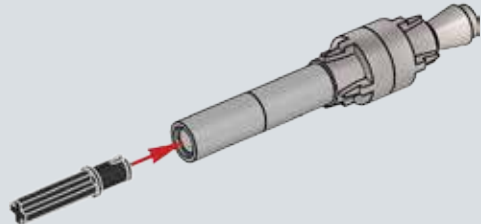

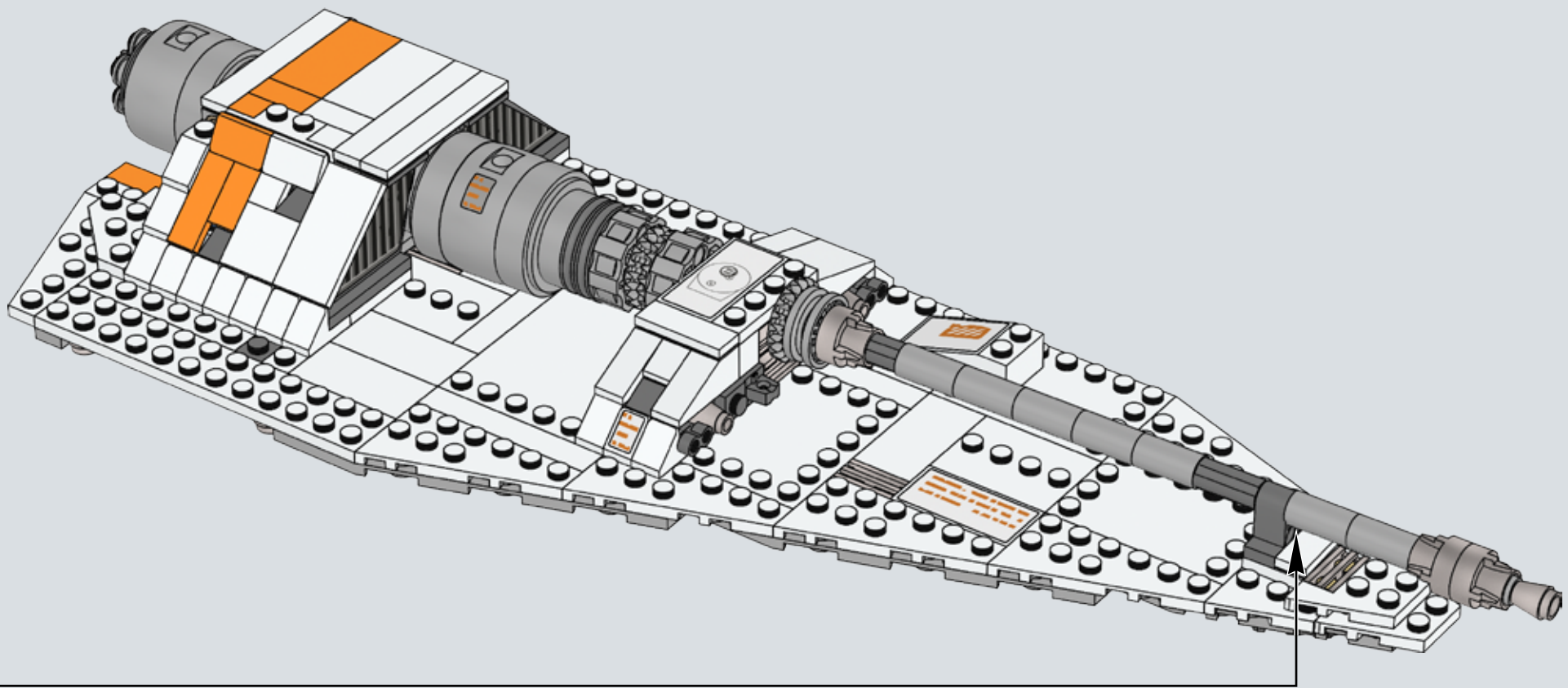

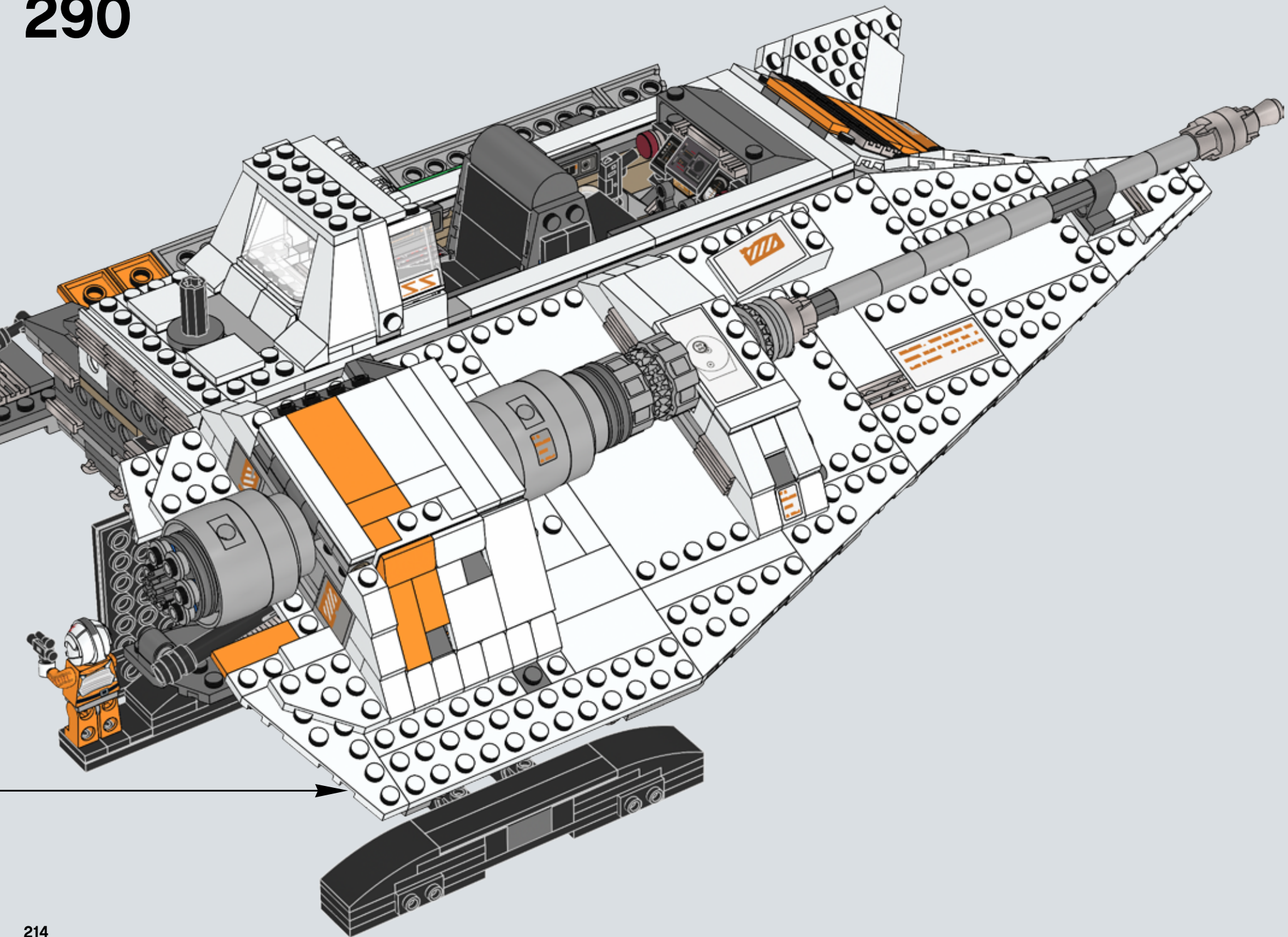

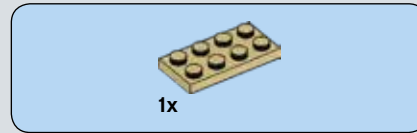
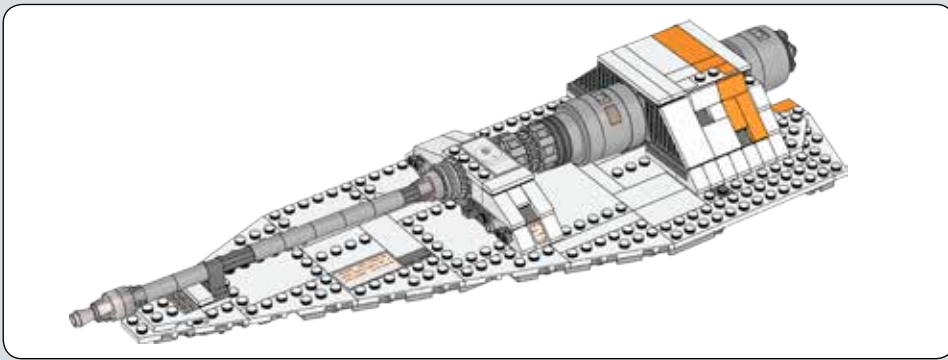

292

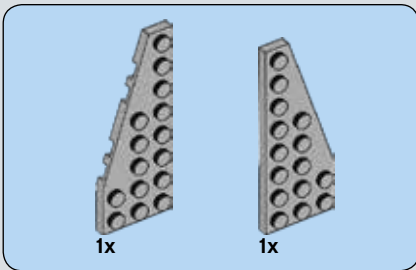
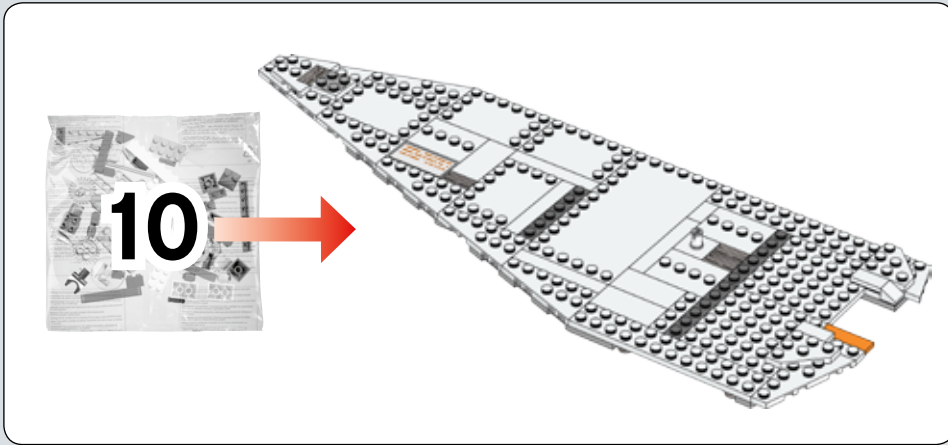

291

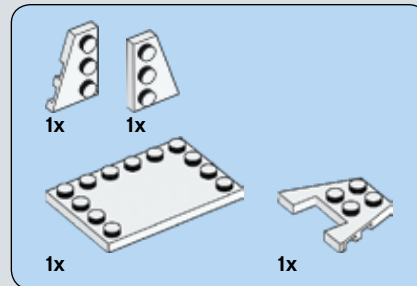
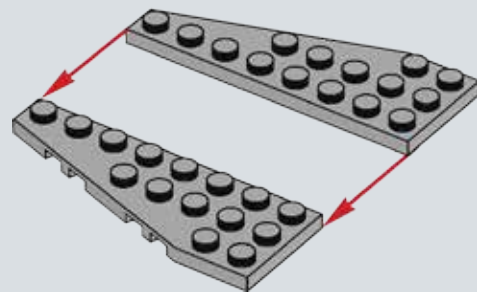

293

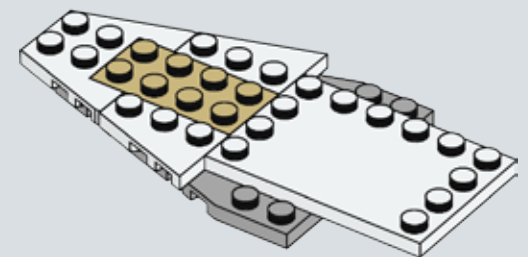
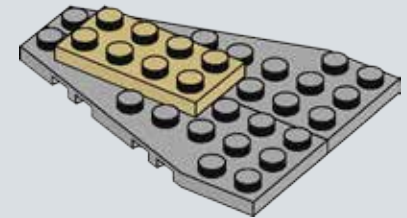

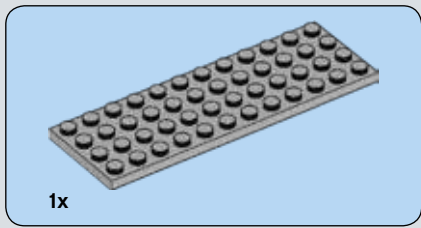

294

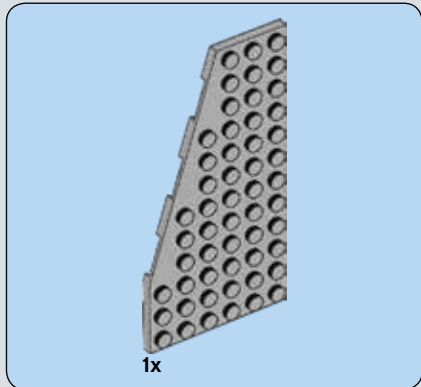
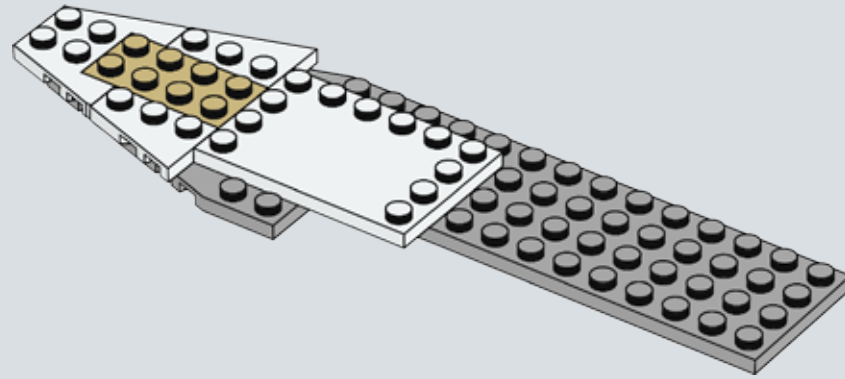

295

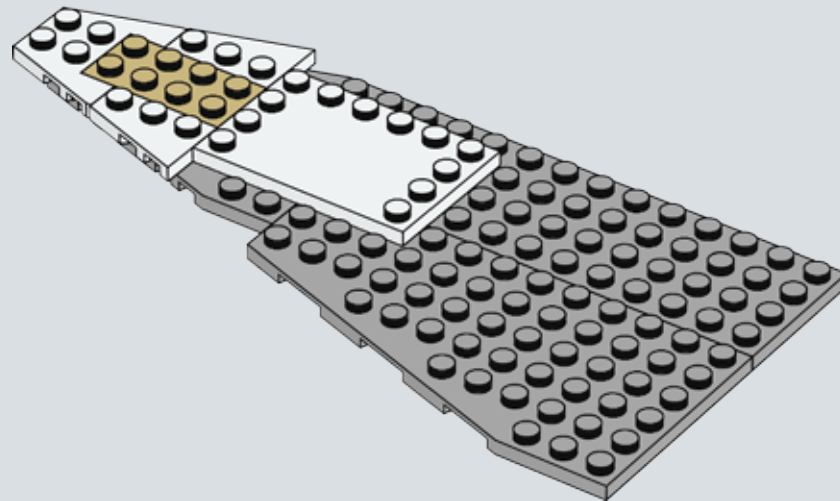

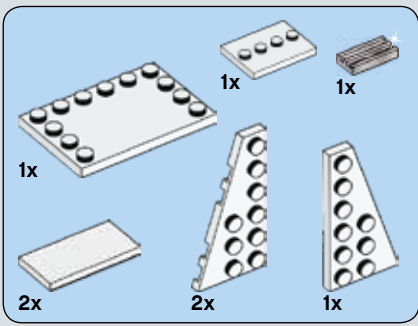

296

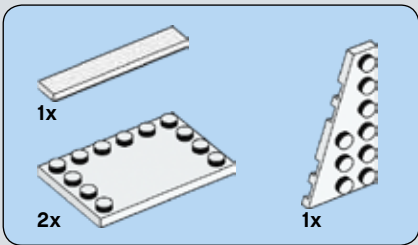
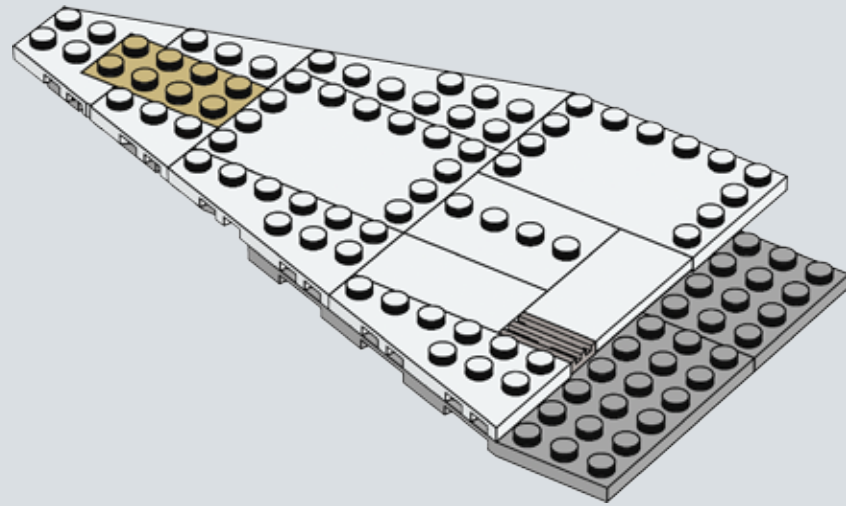

297

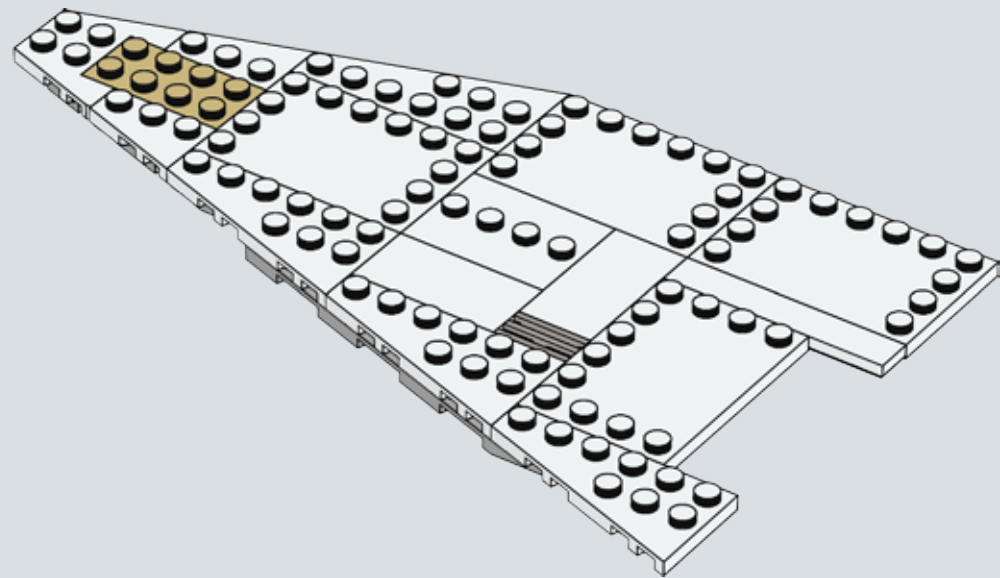

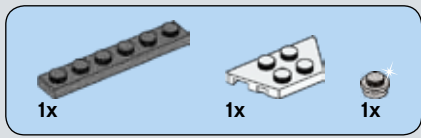

298

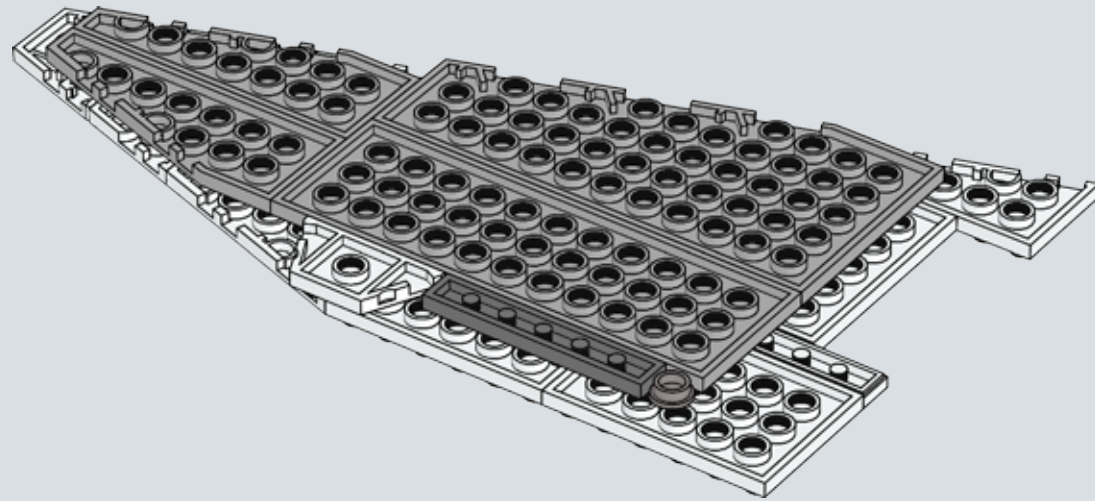
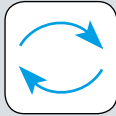

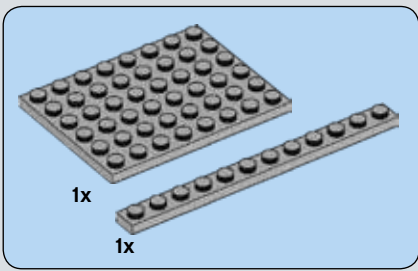

299

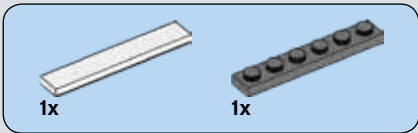
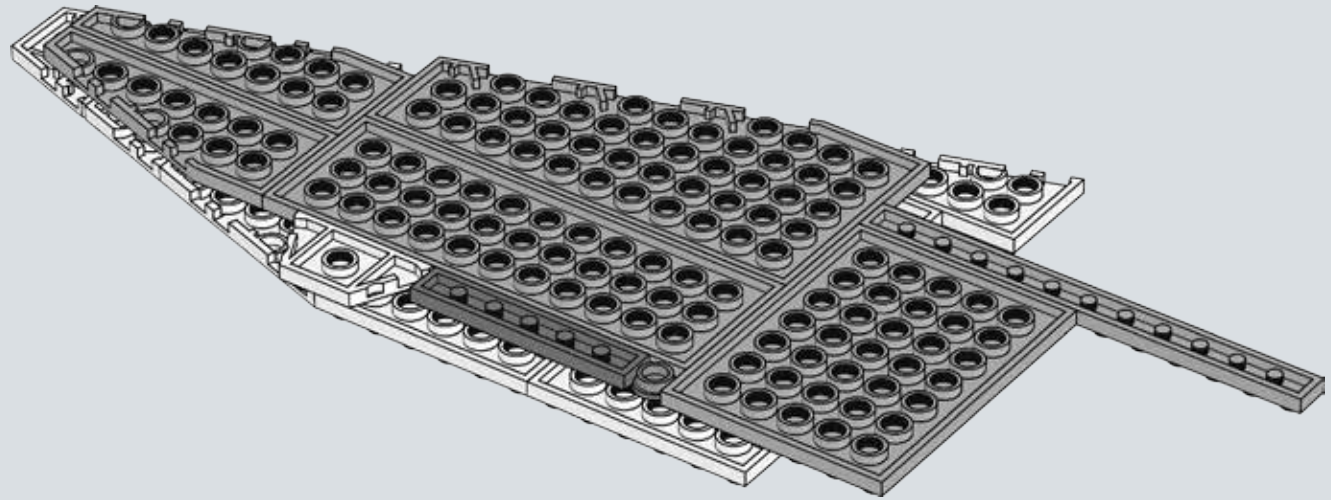

300

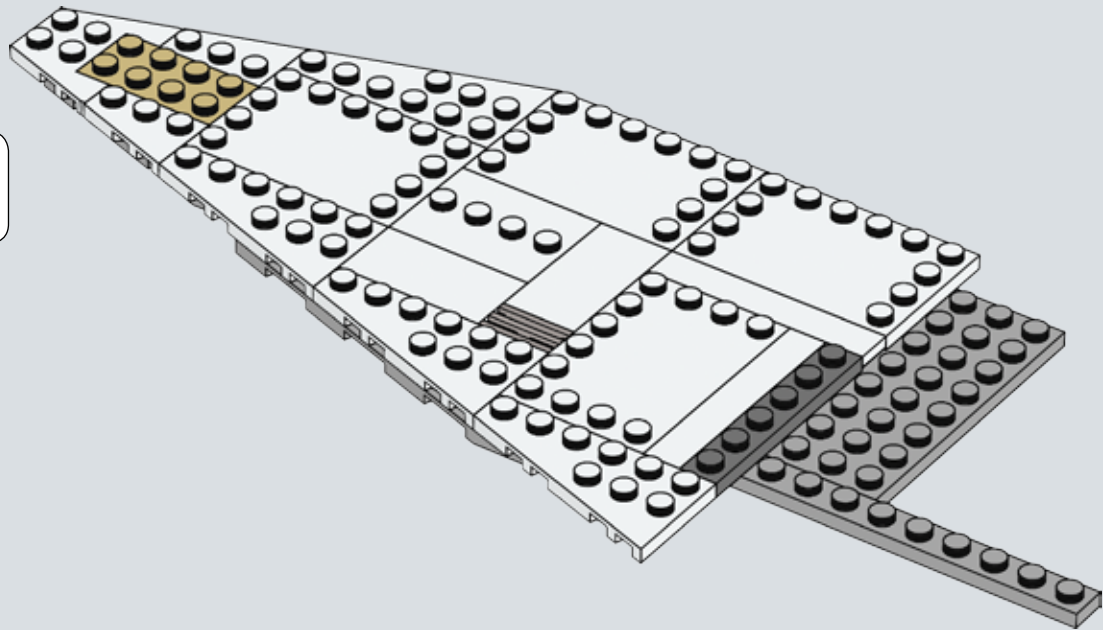
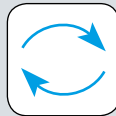

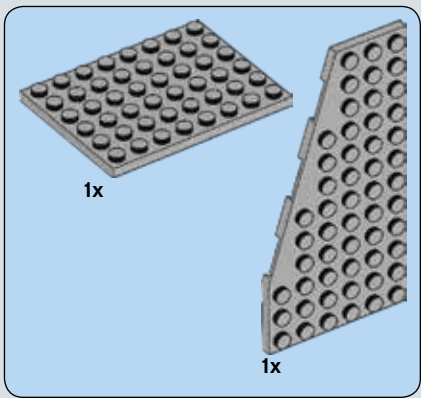

301

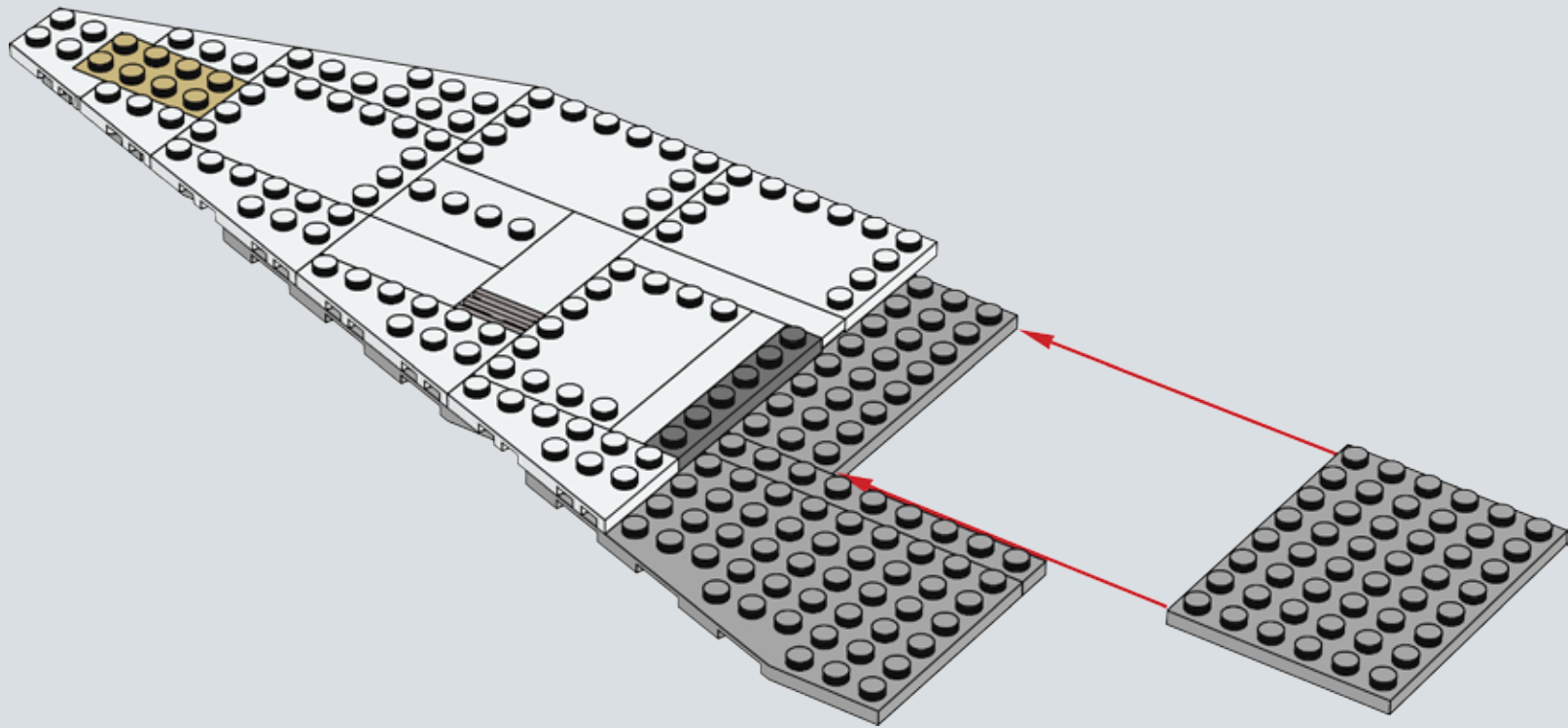

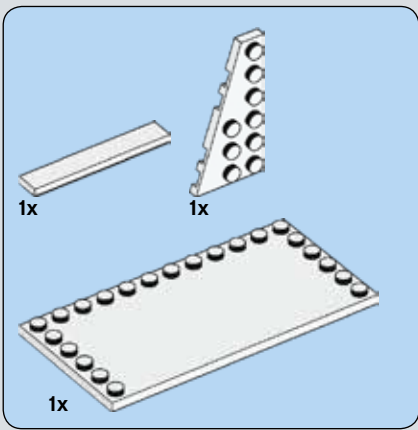

302

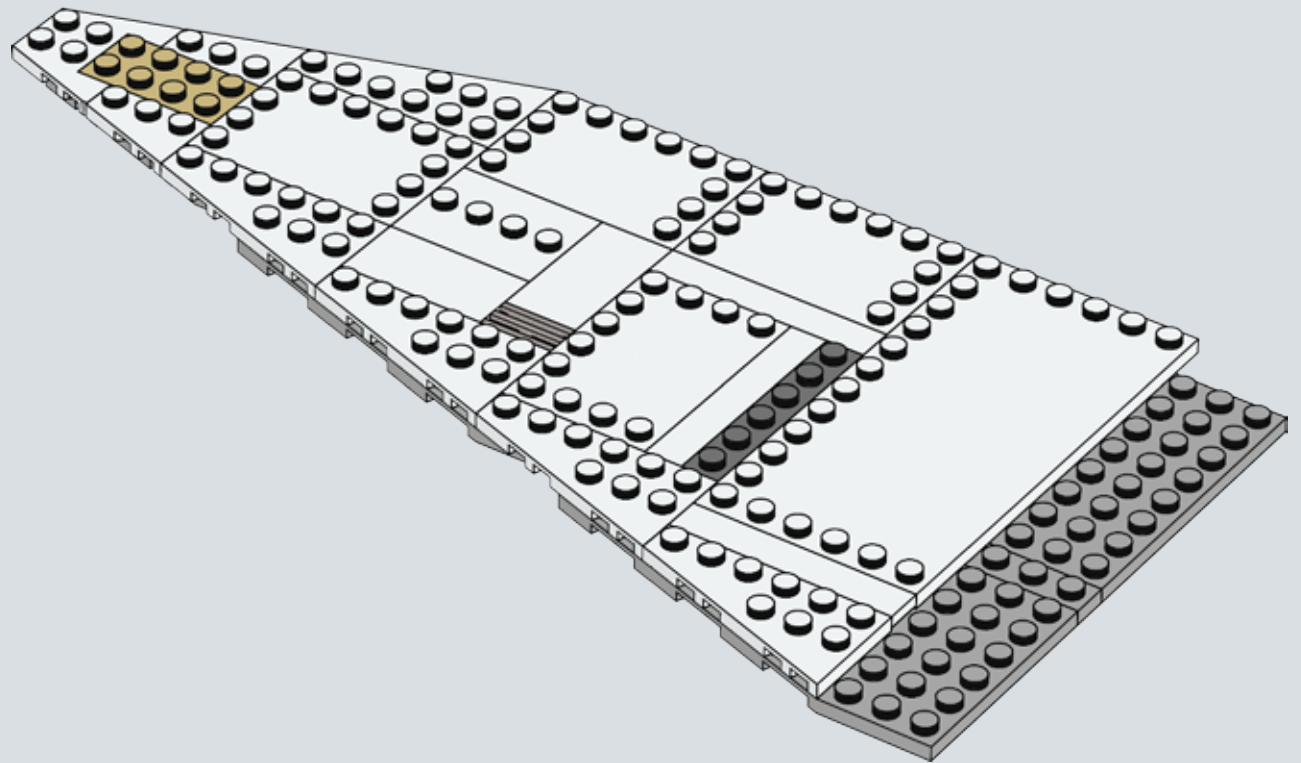

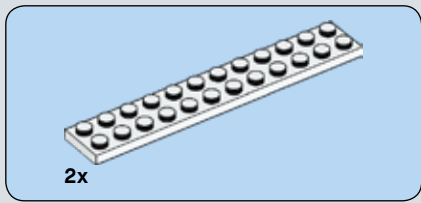

303

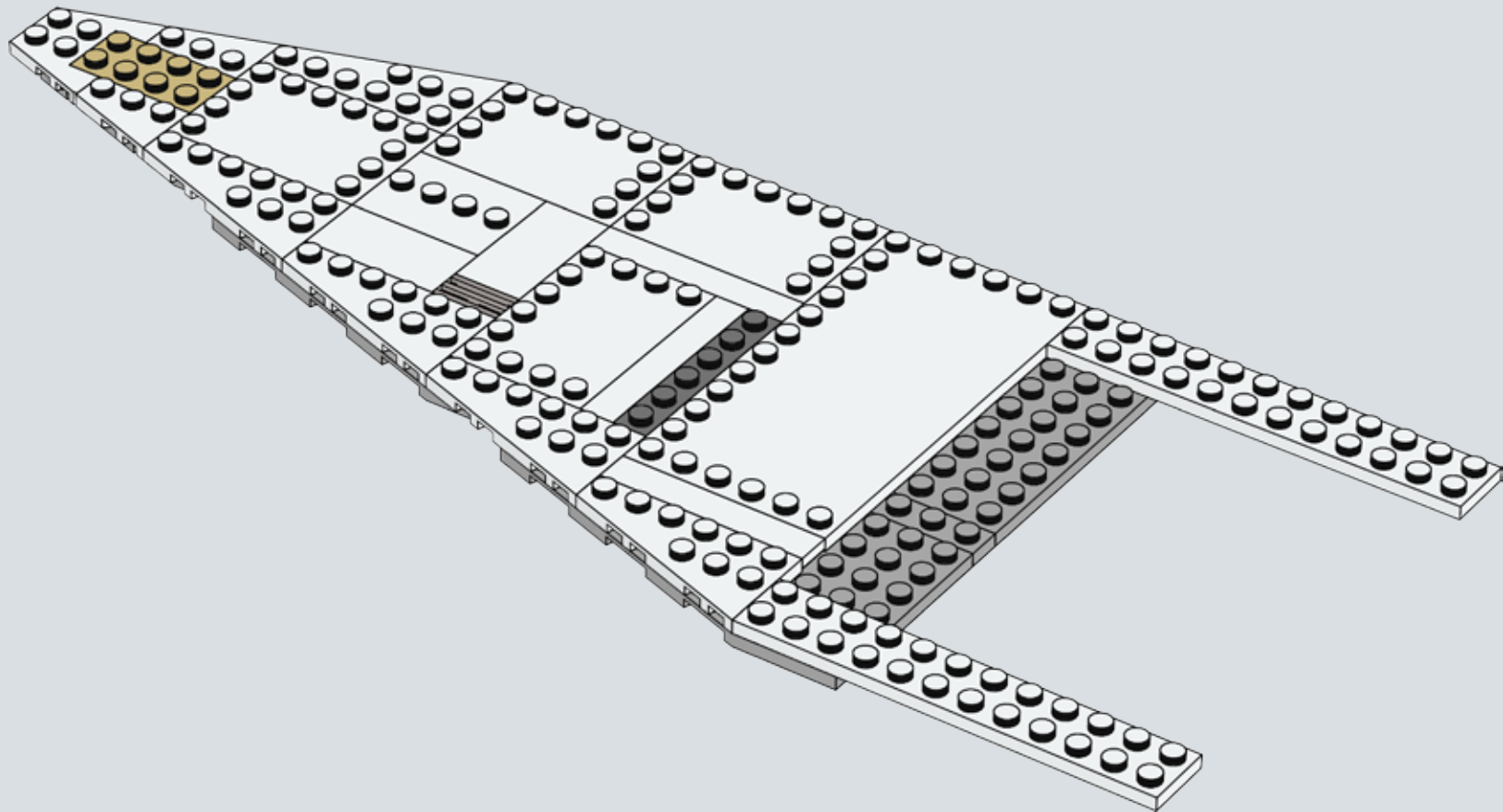

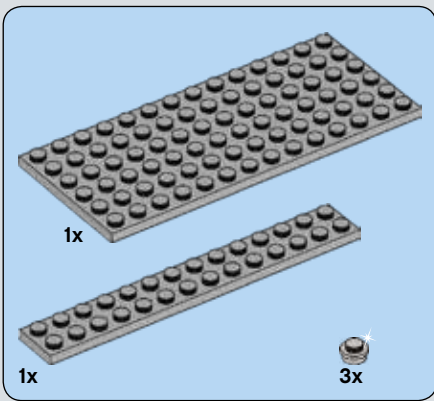

304

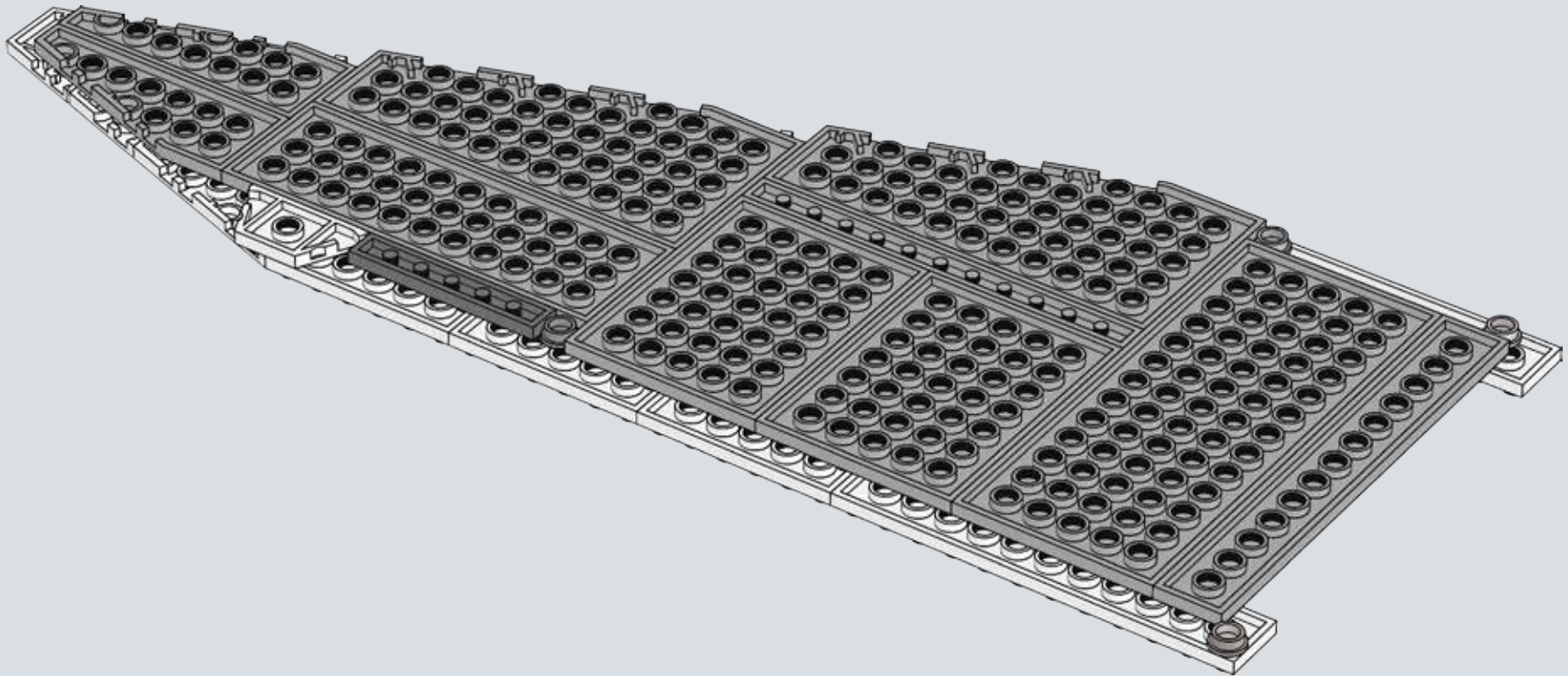
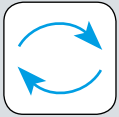

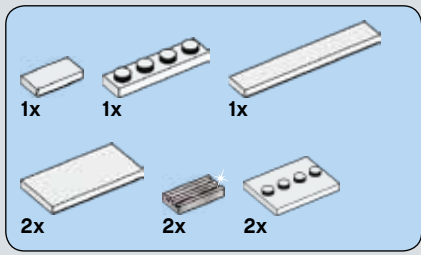

305

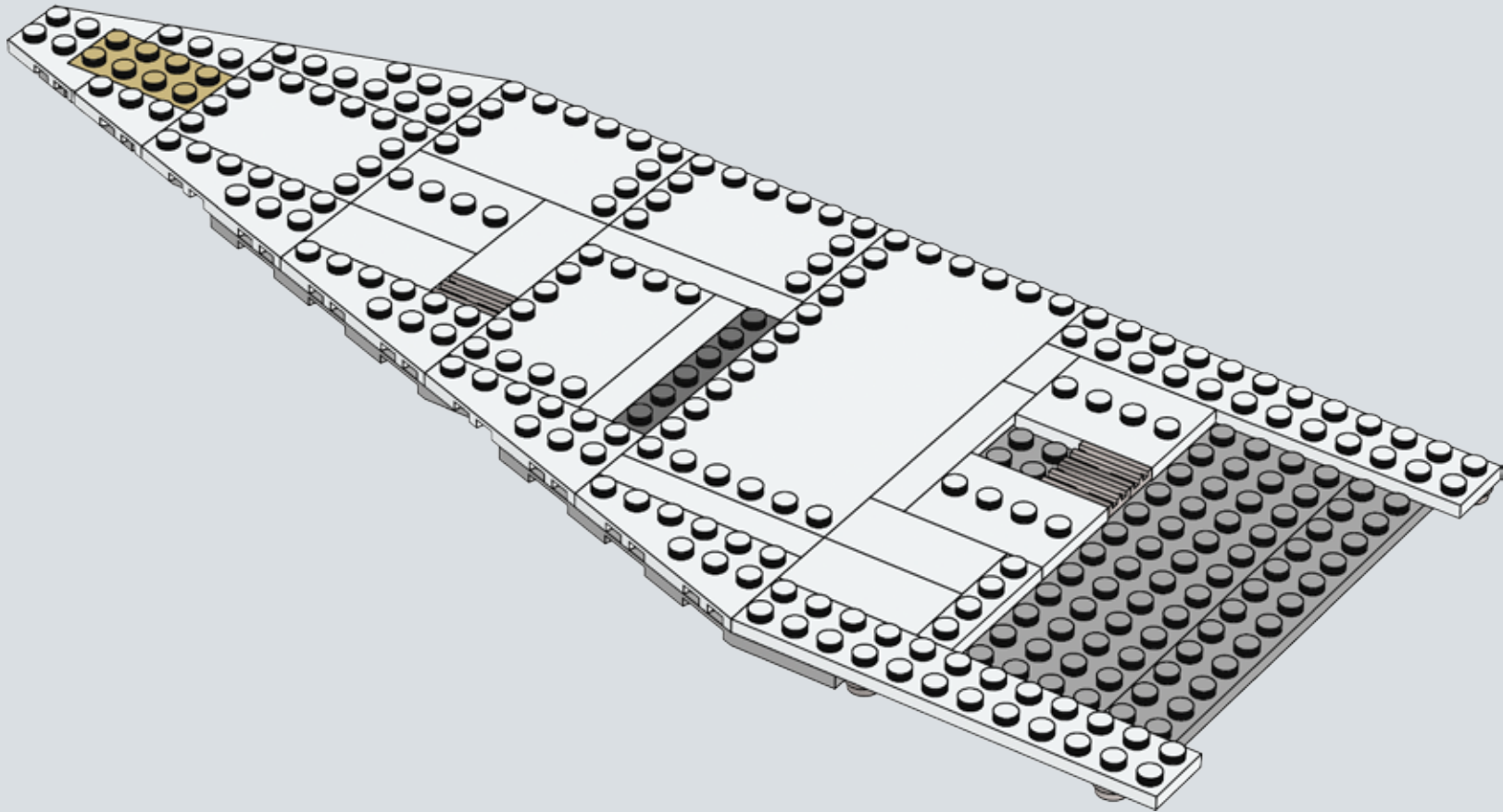

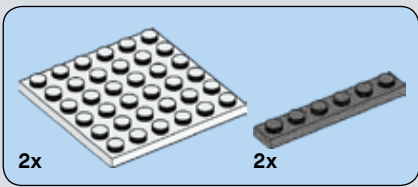

306

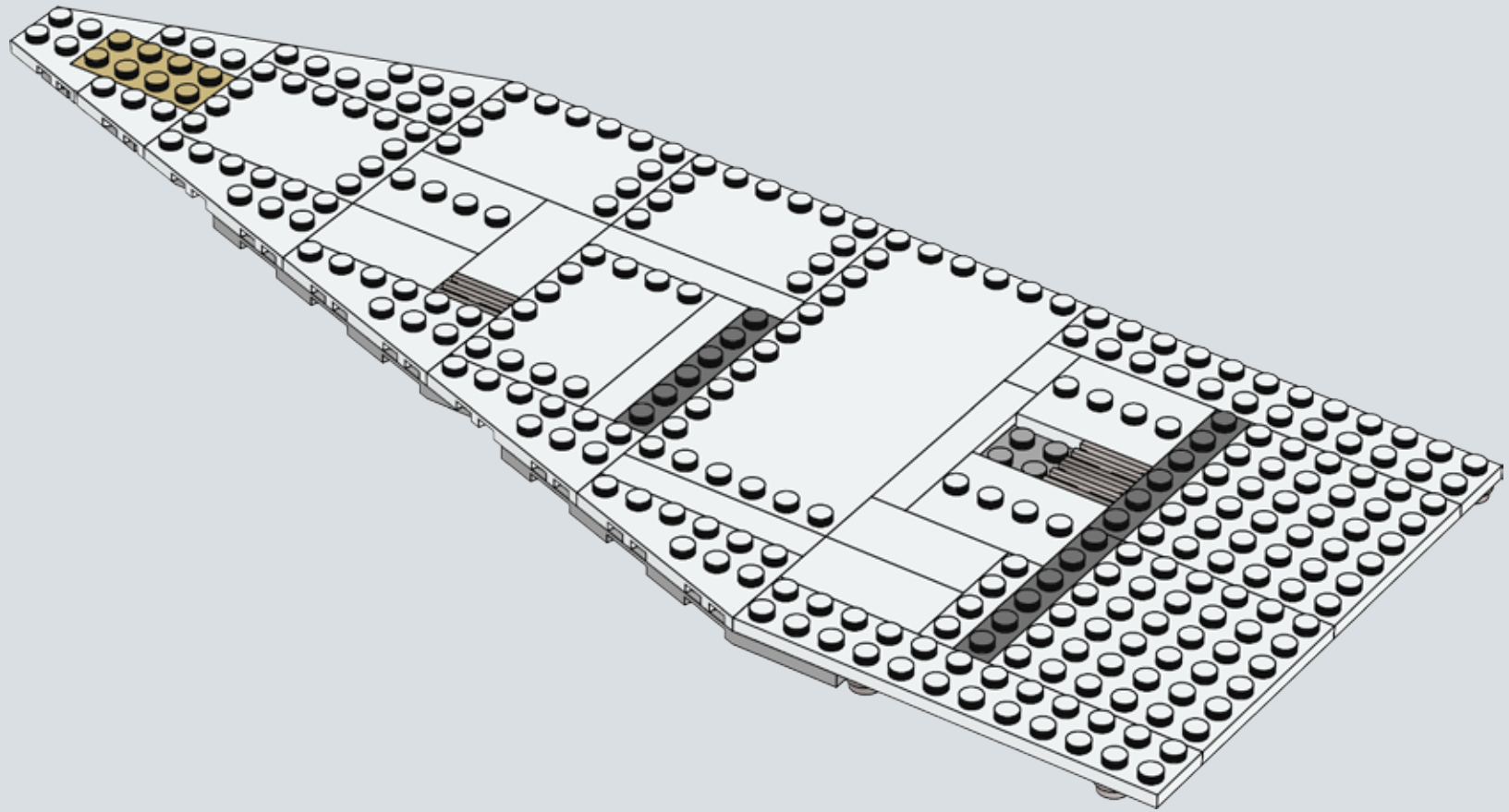

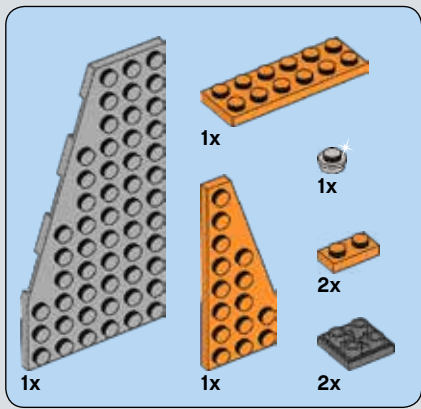

307

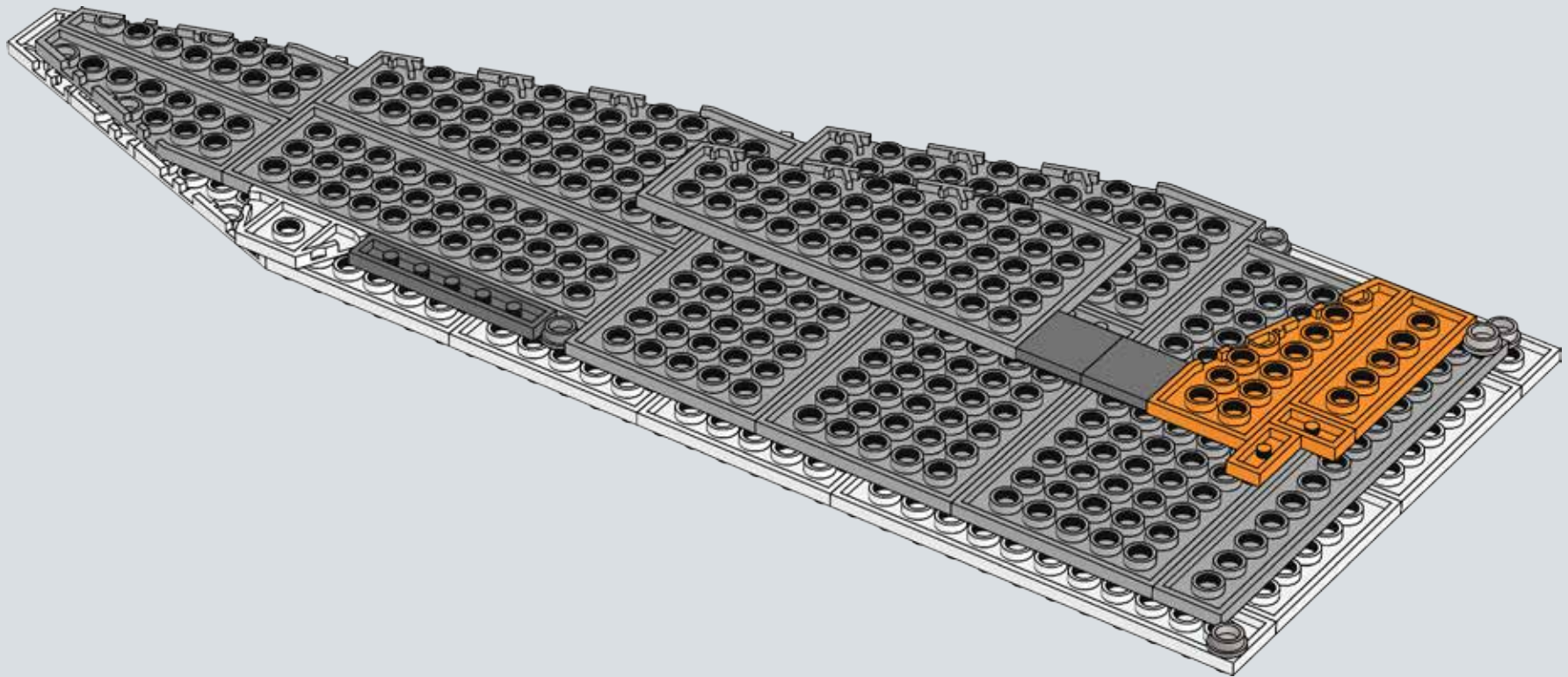
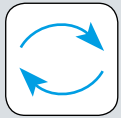

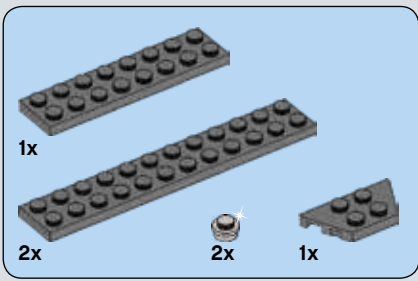

308

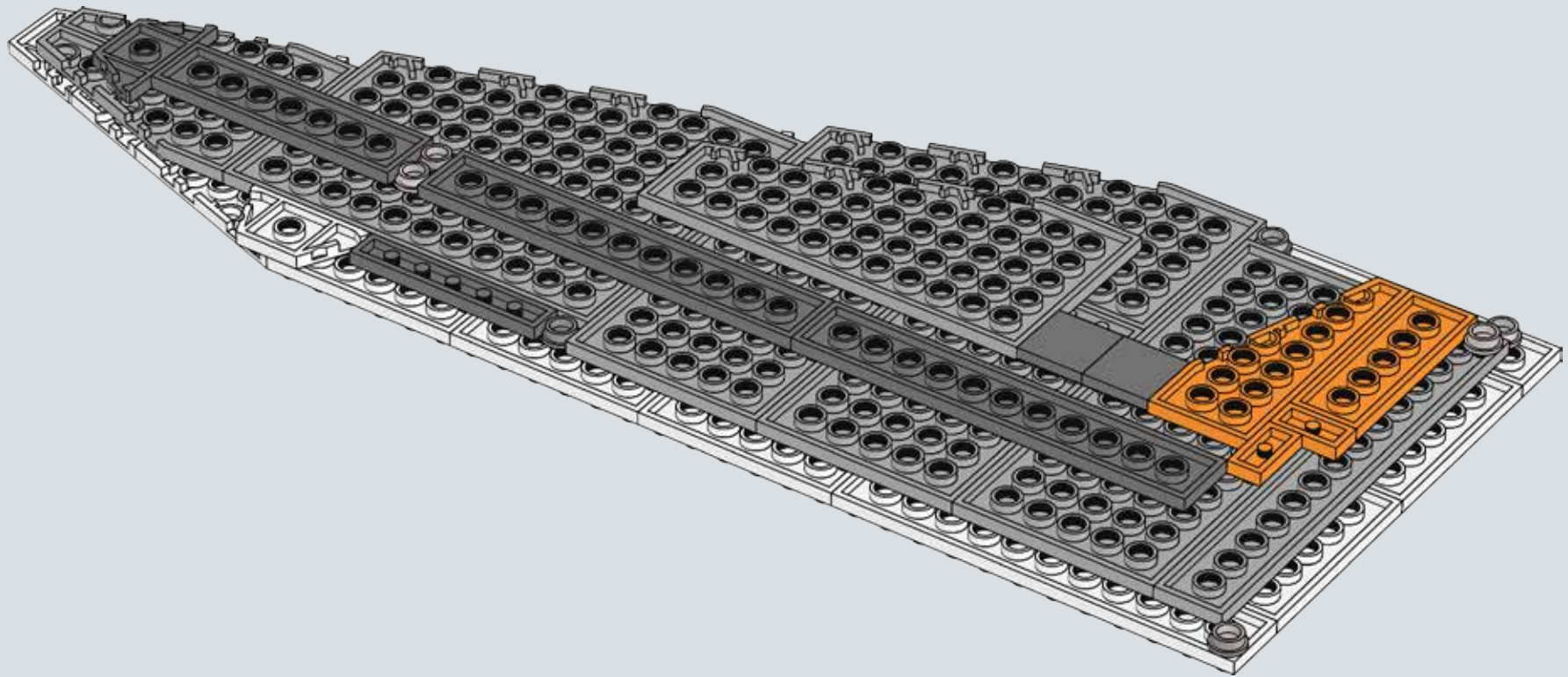

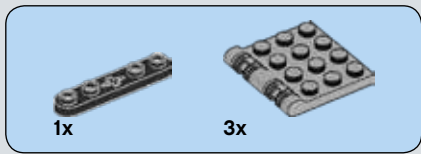

309

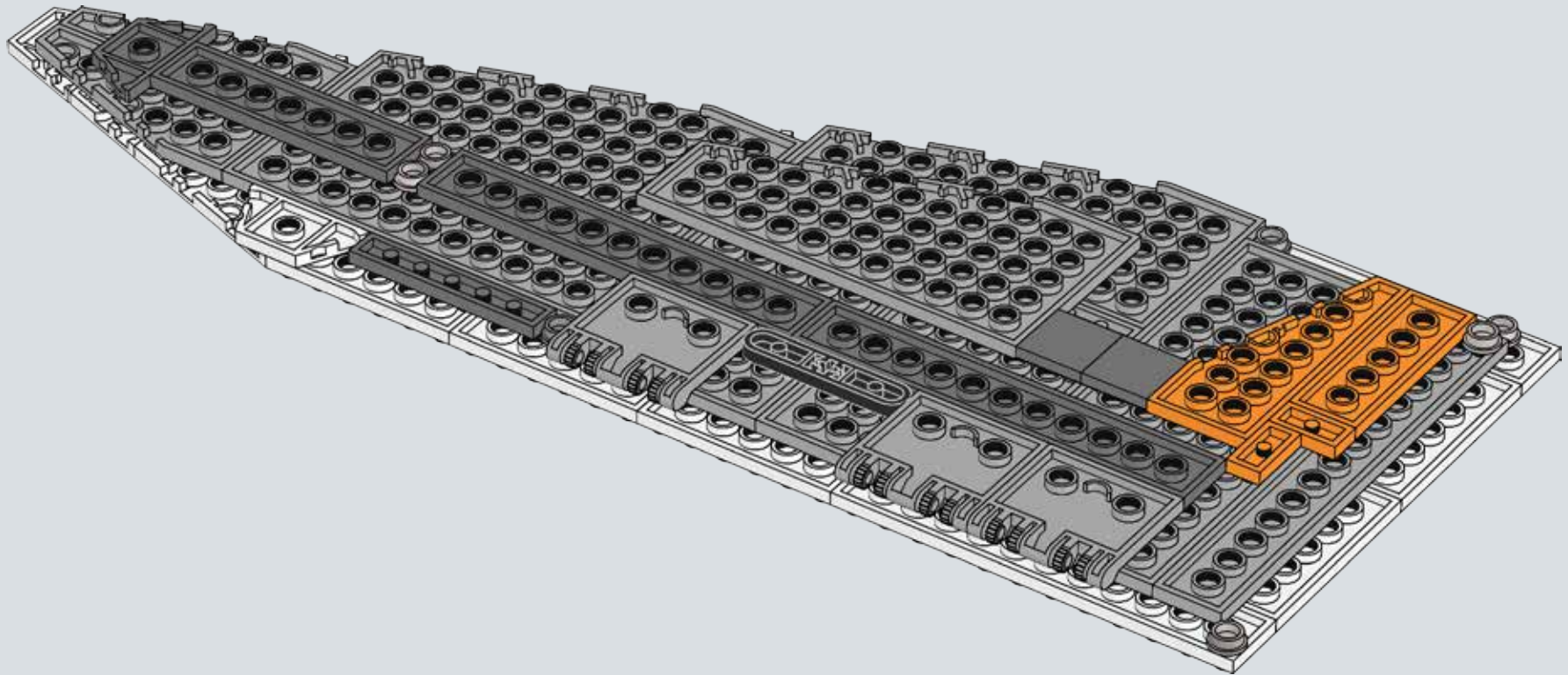

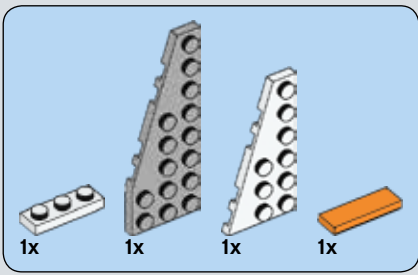

310

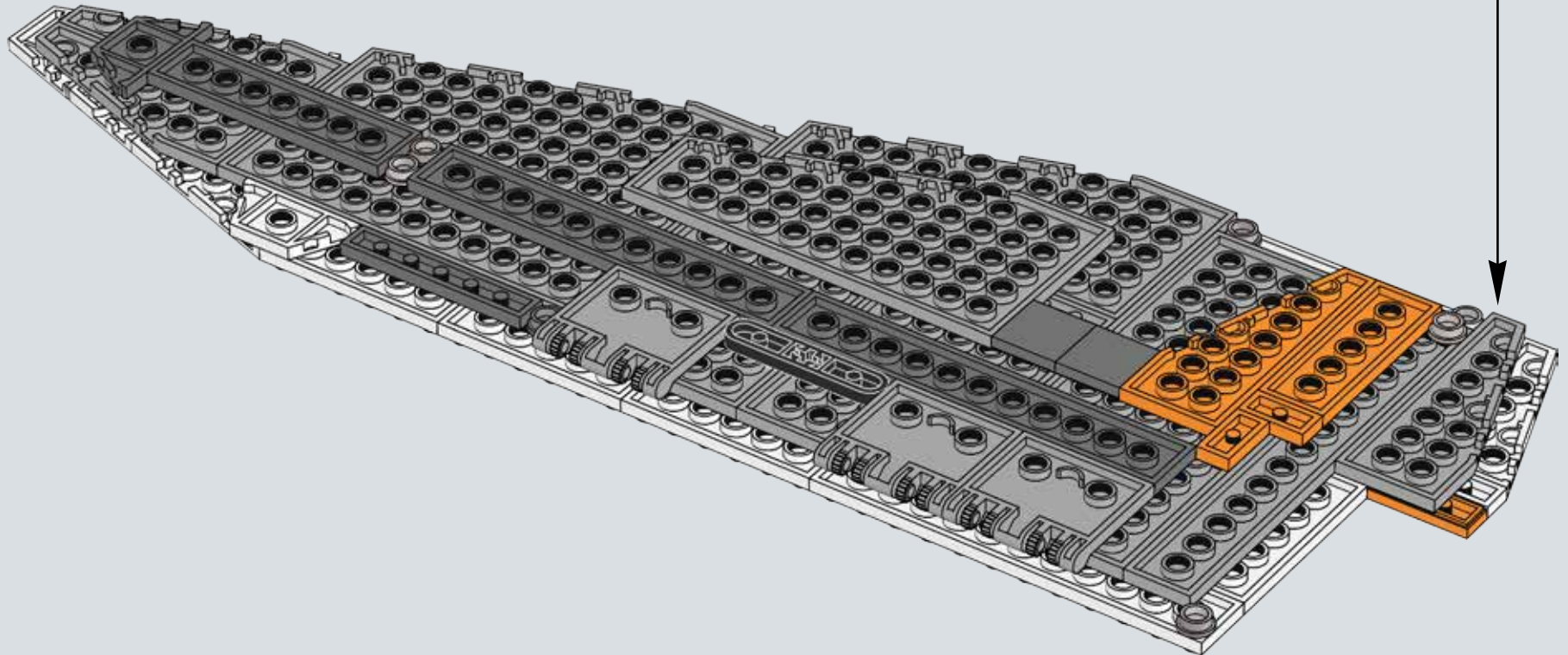
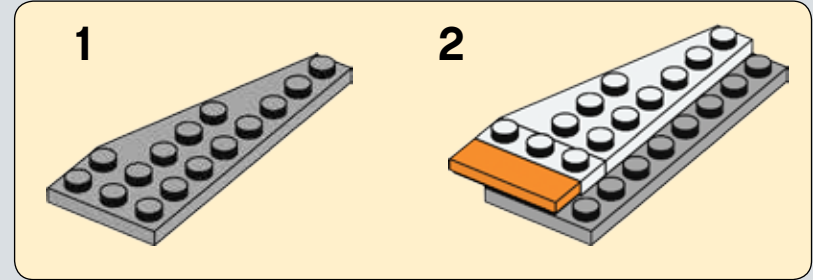

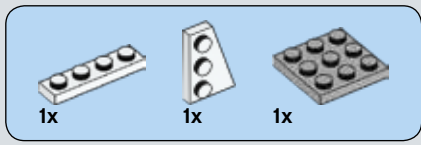

311

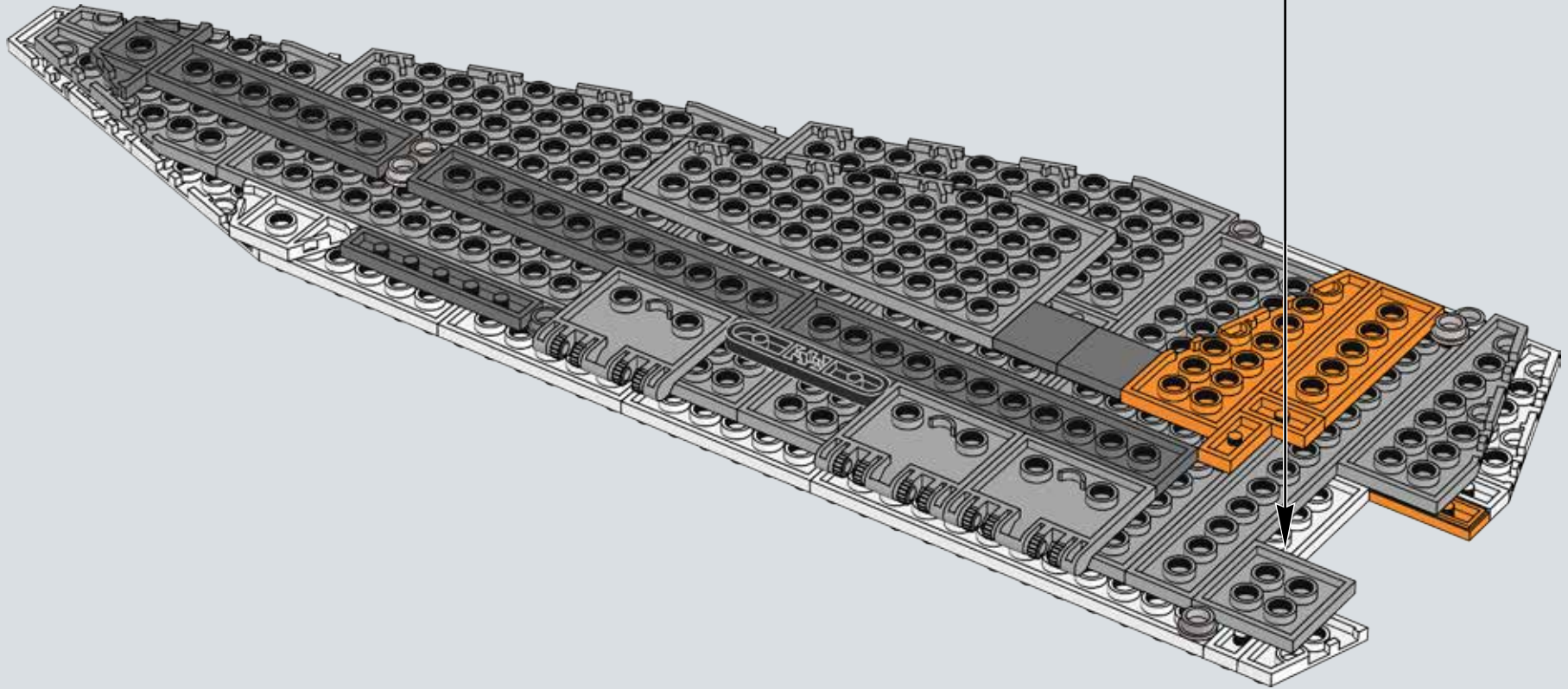
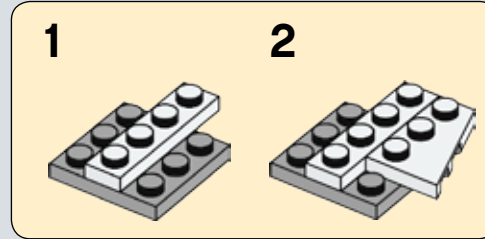



312

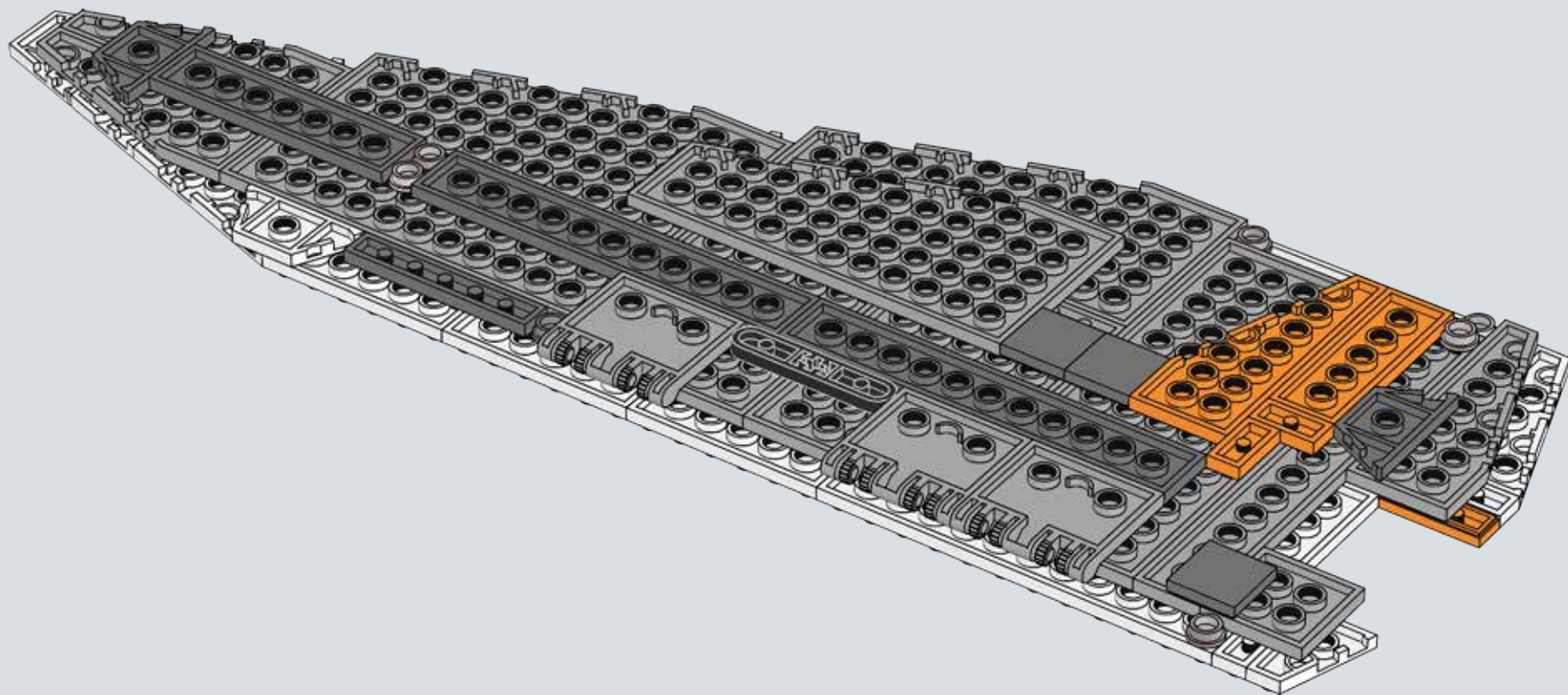



313

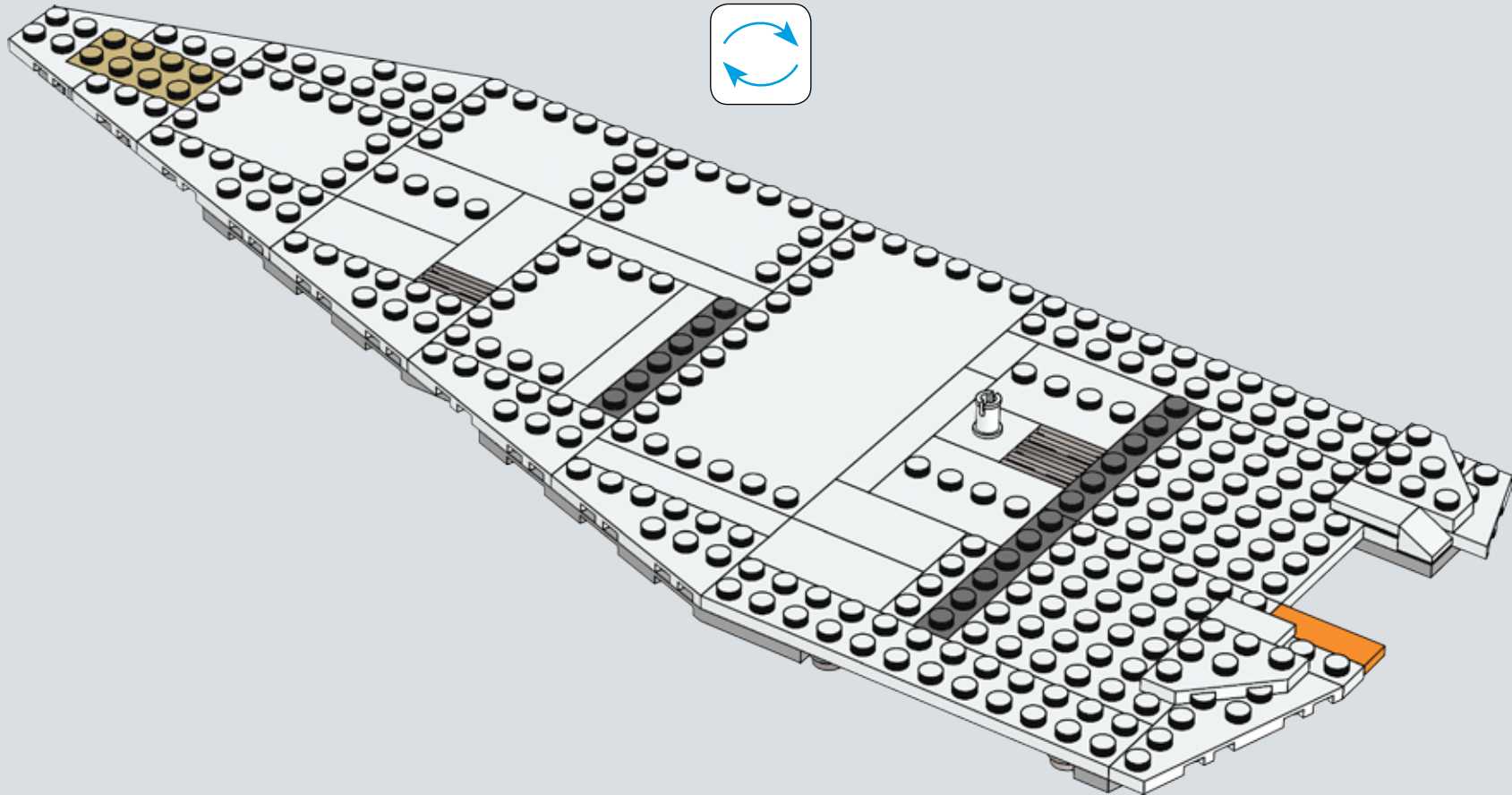
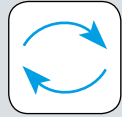

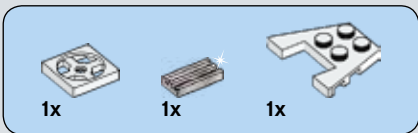

314

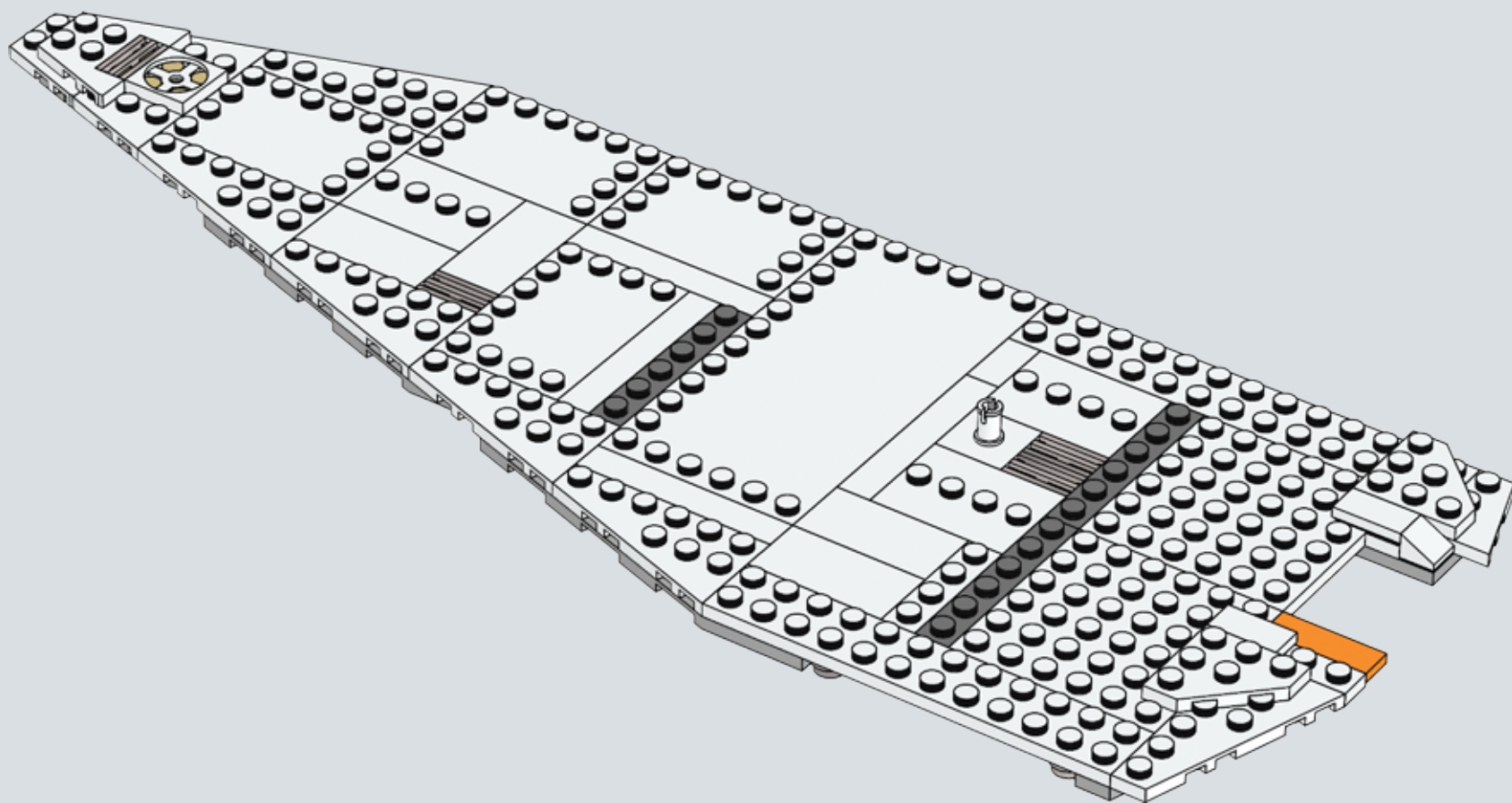



1x

315

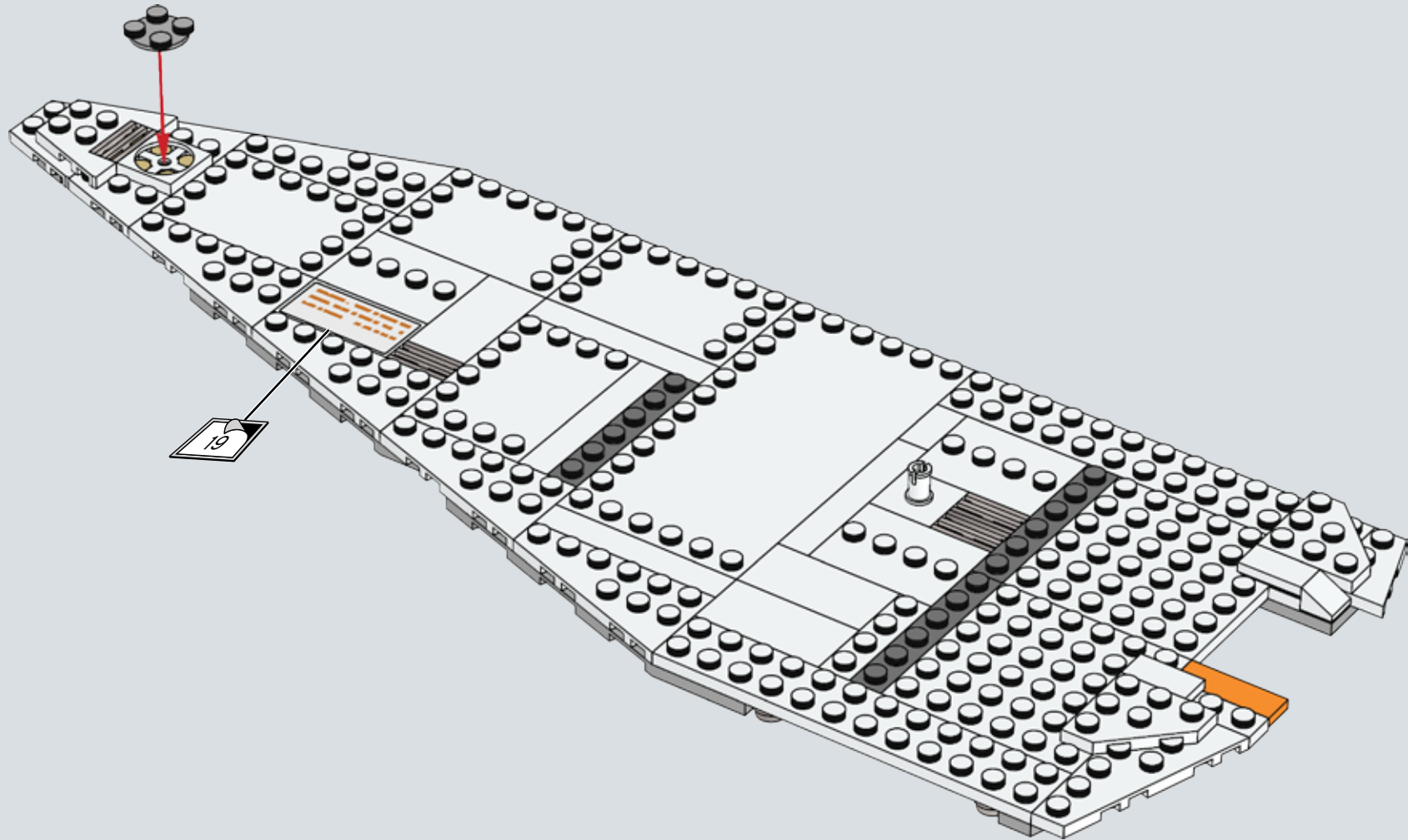

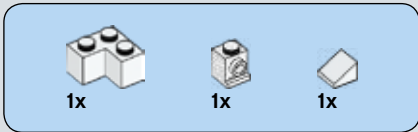
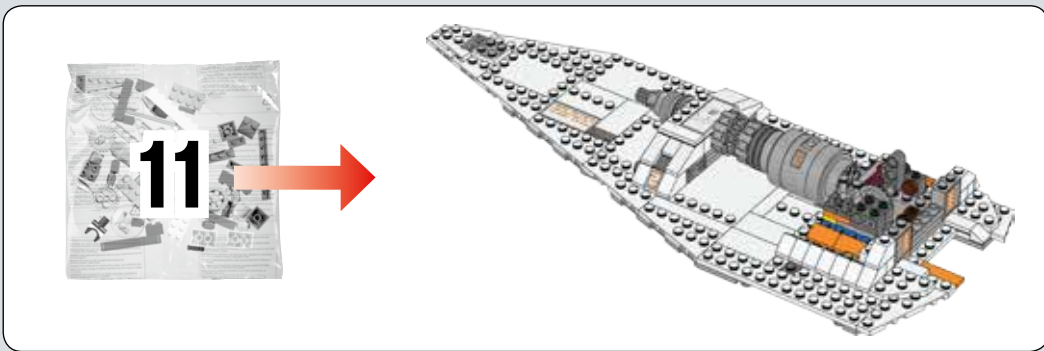

316

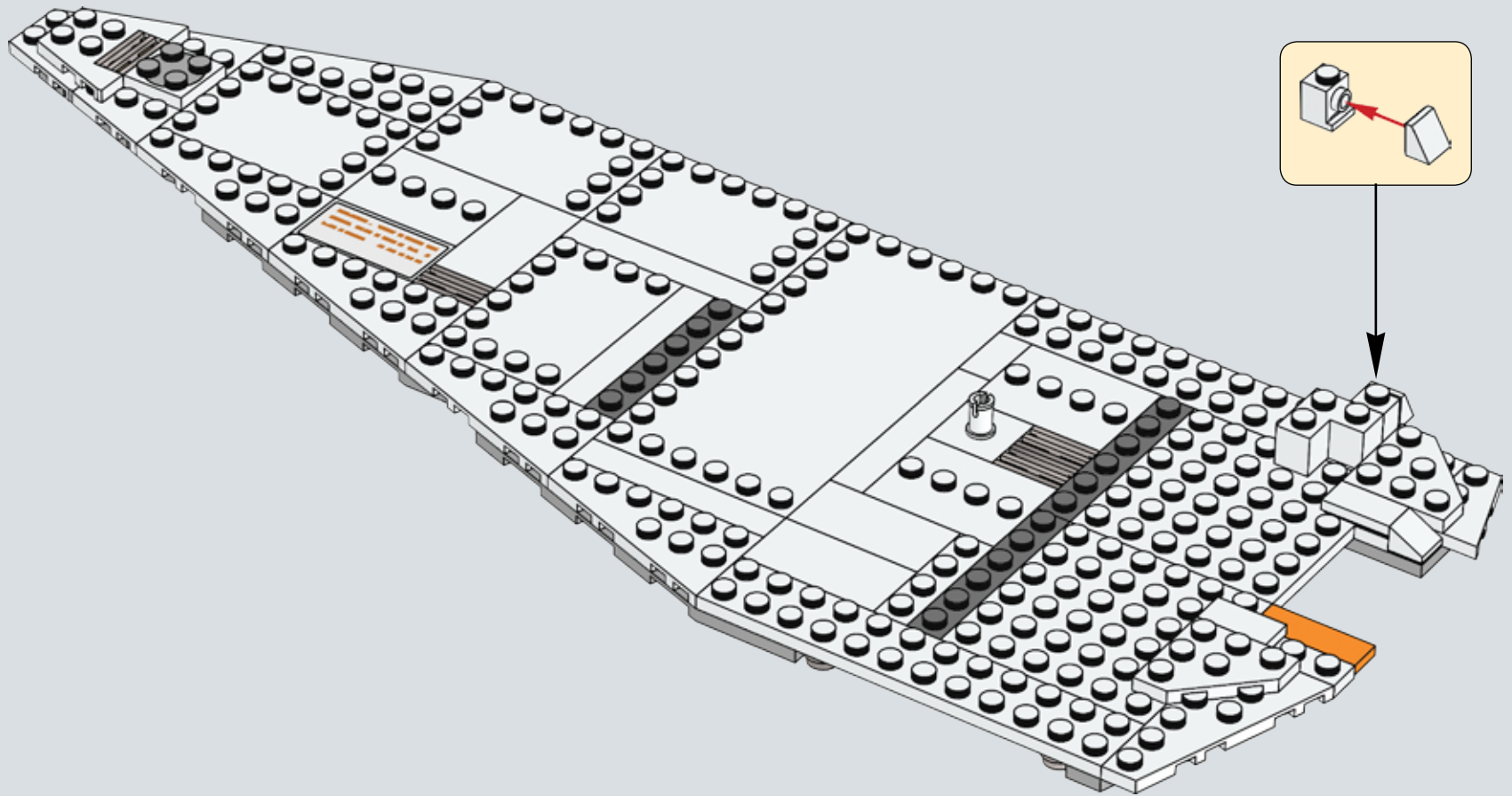

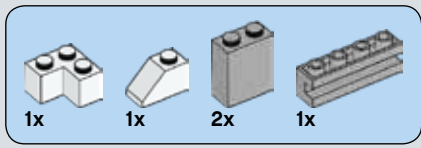

317

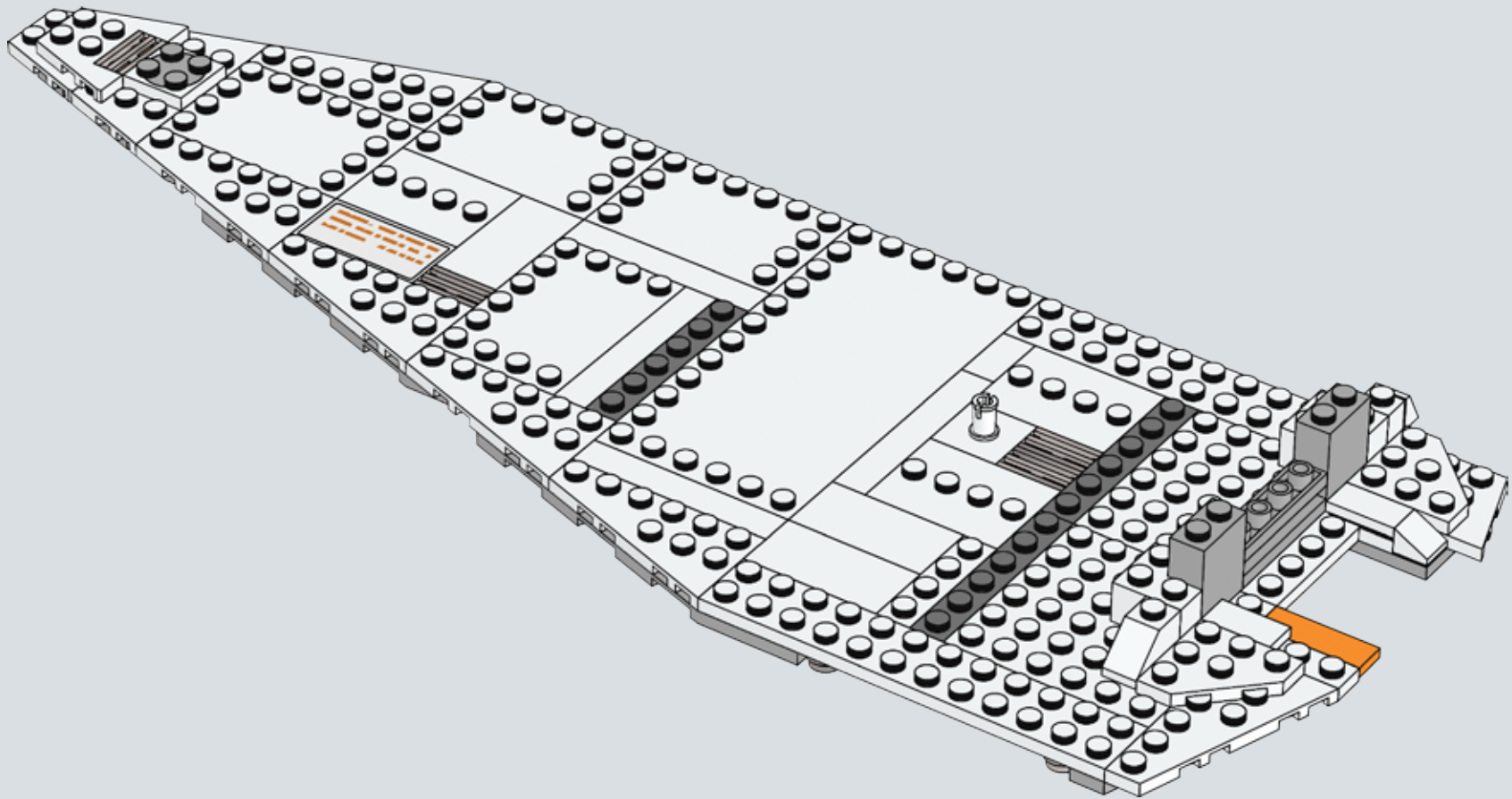

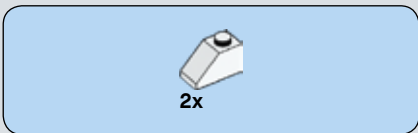

318

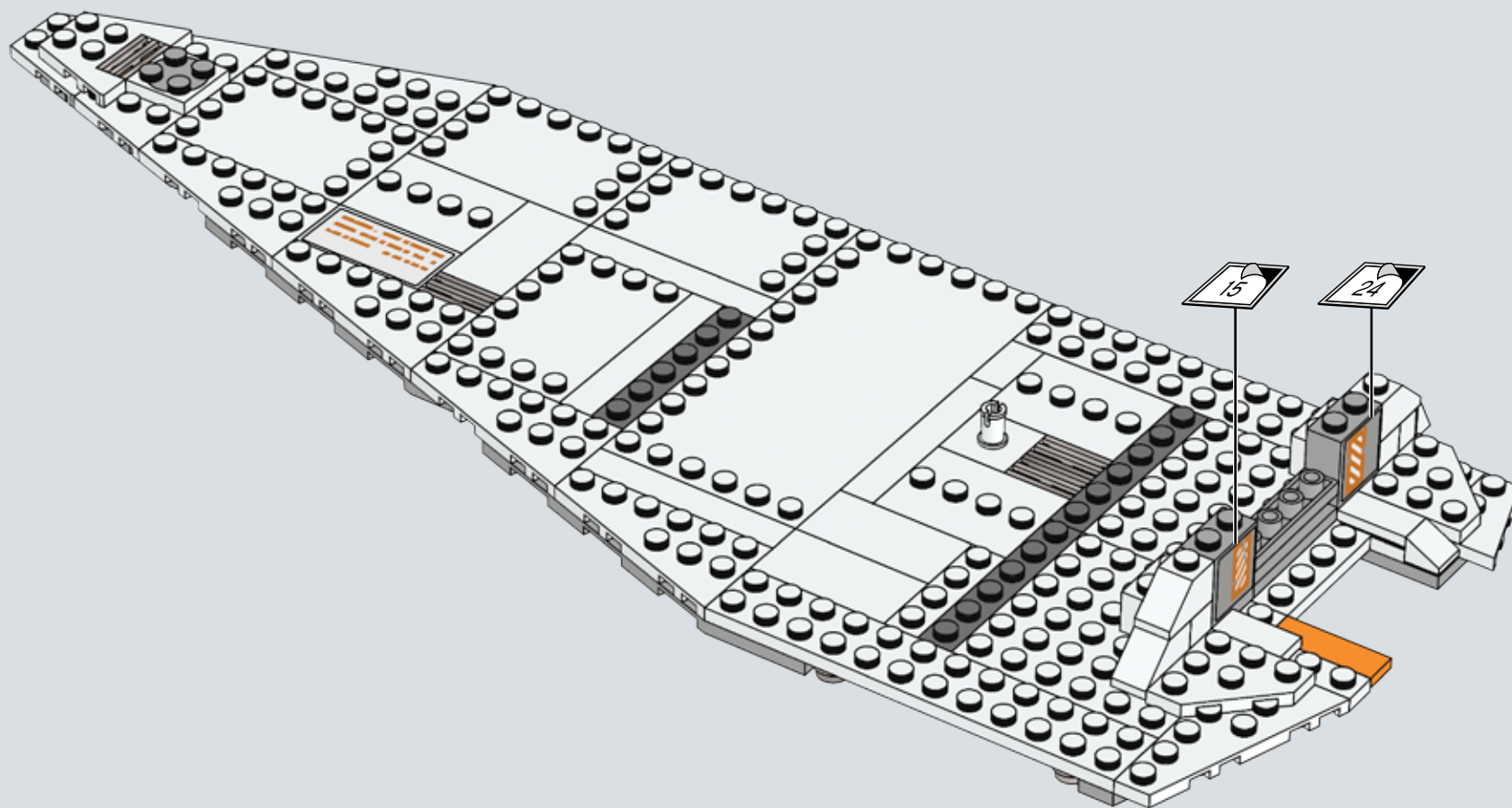



319

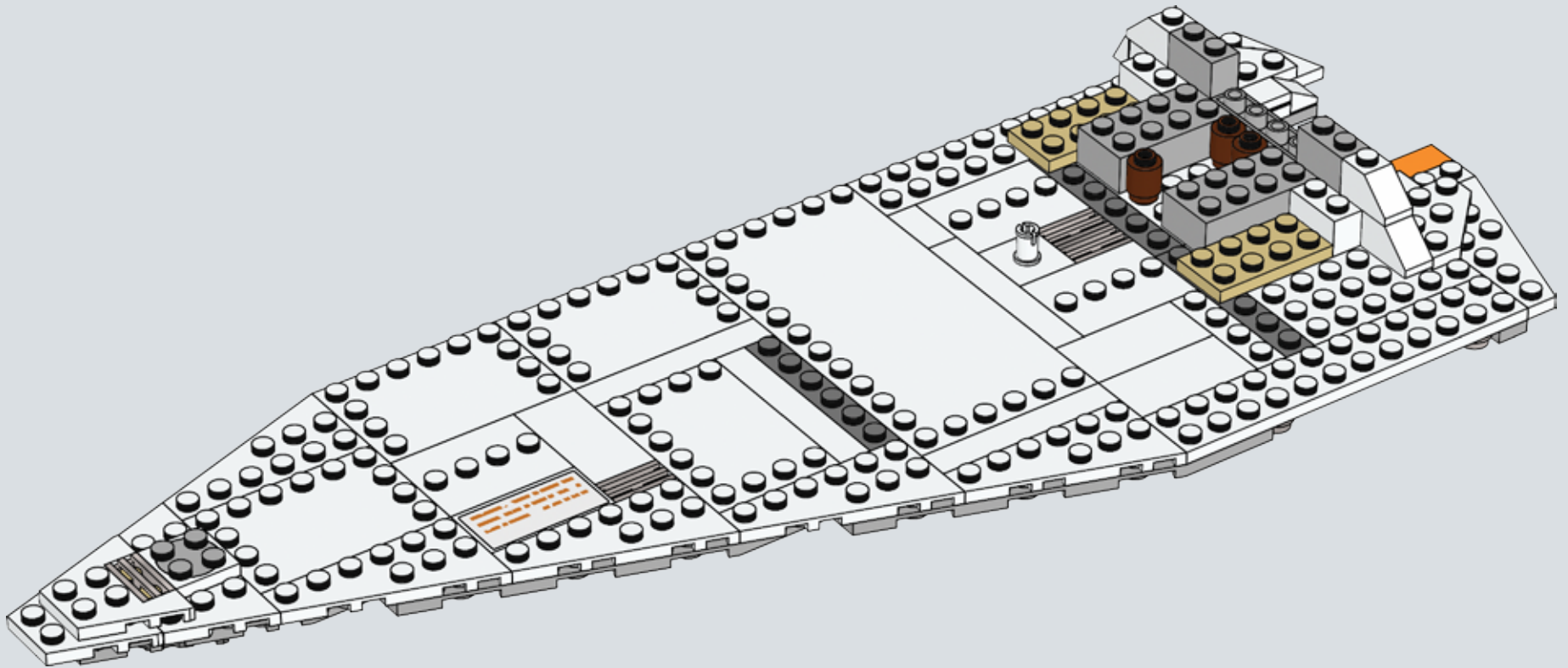



320

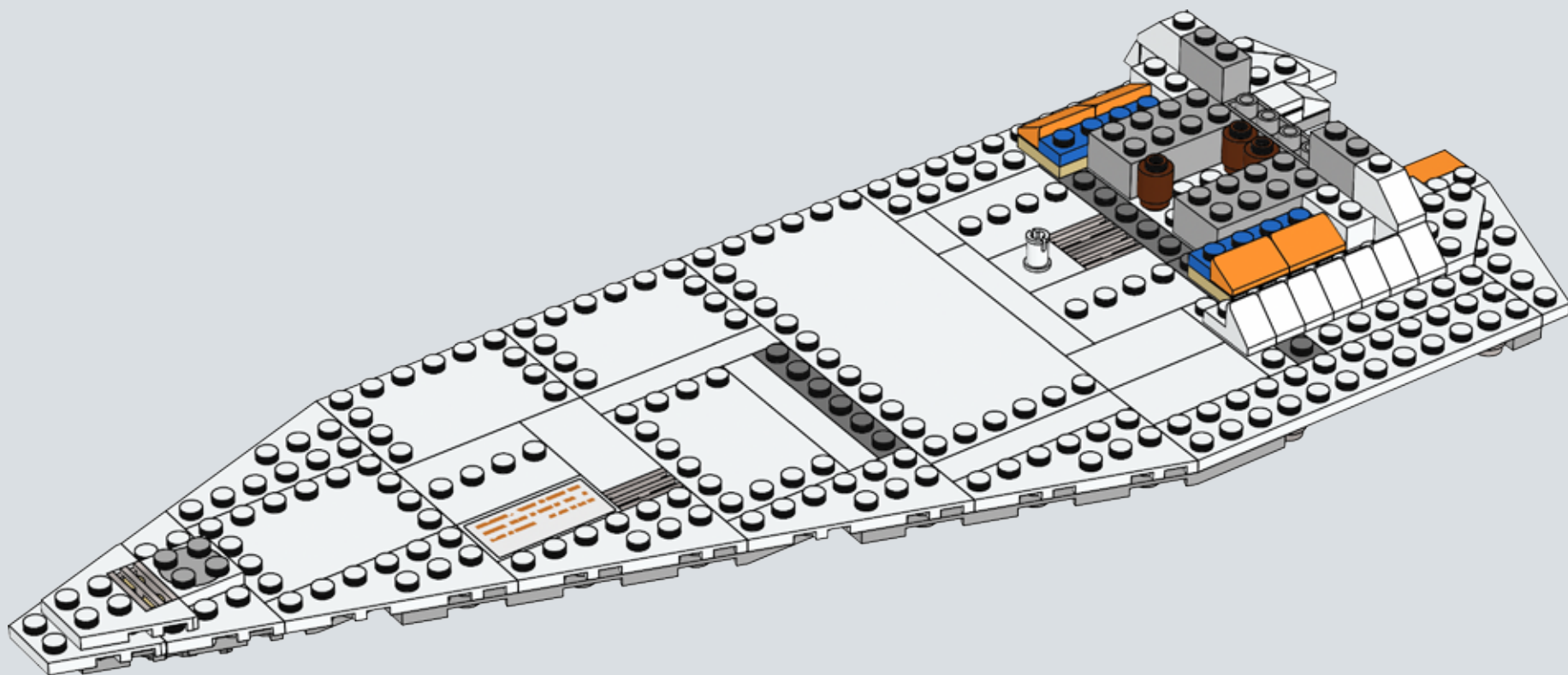

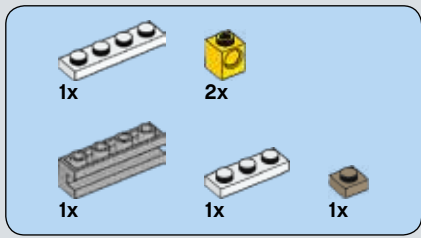

321

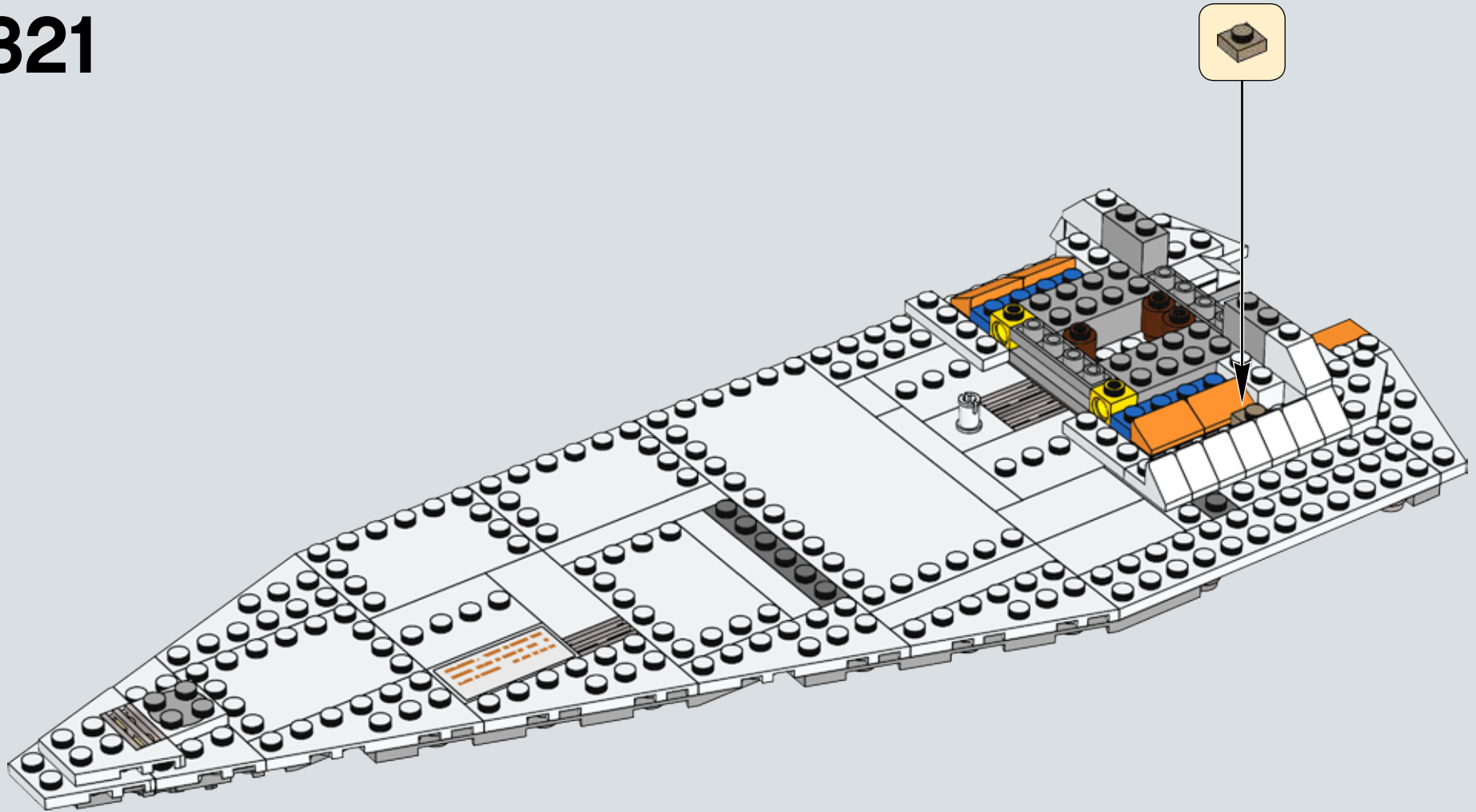



322

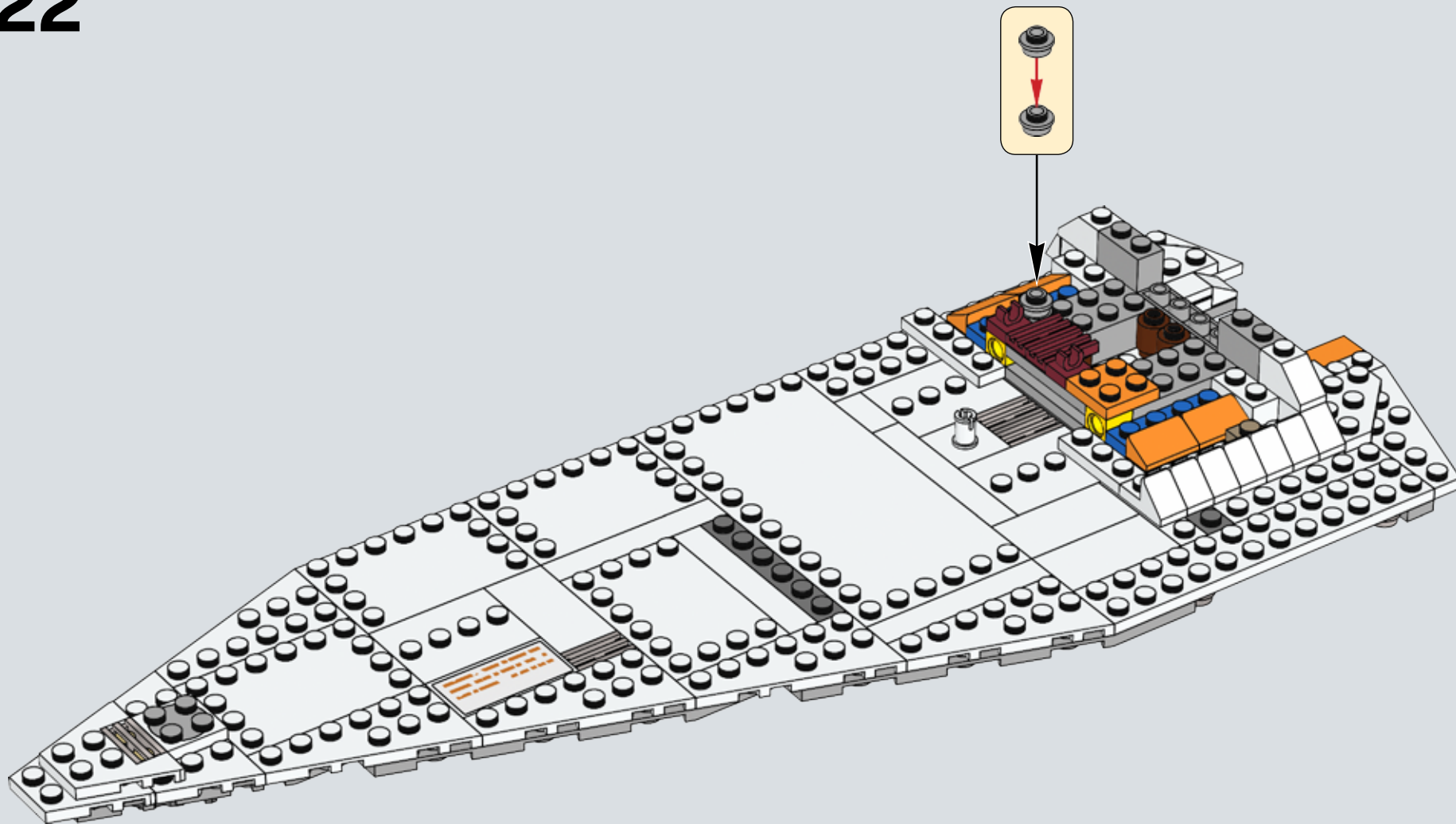



2x

323

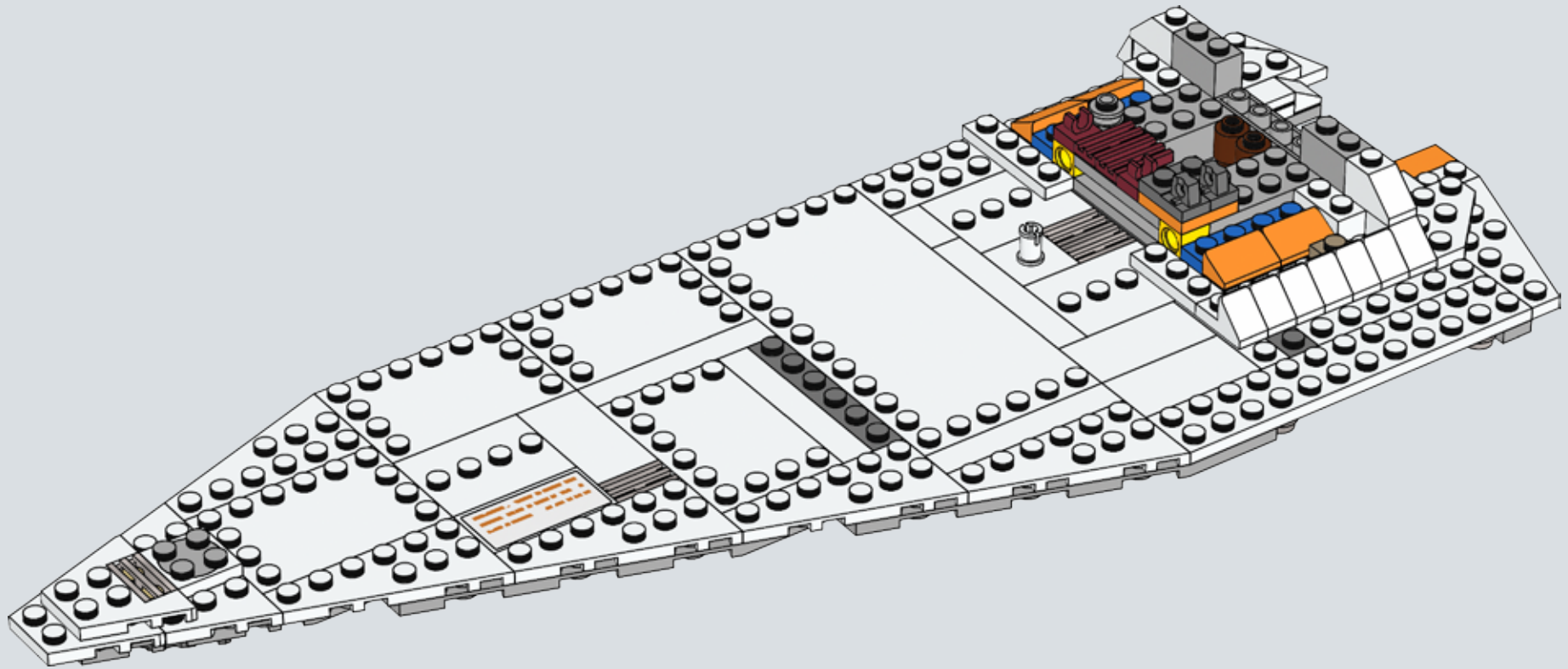

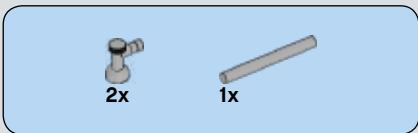

324

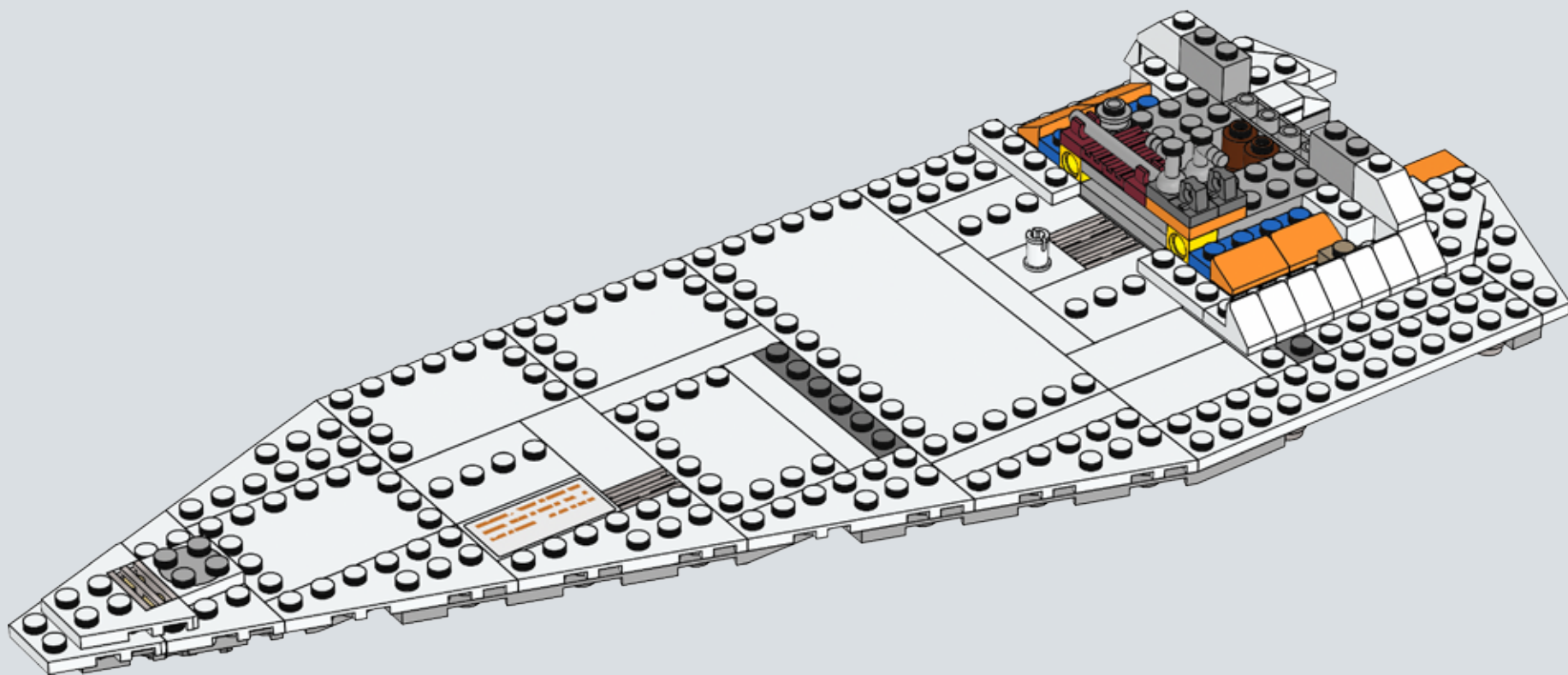

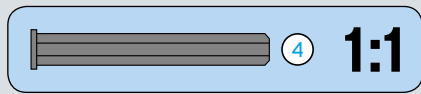
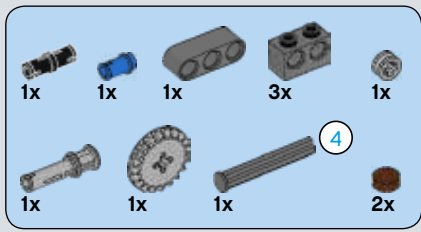

325

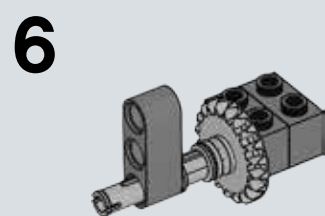
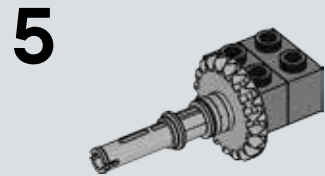
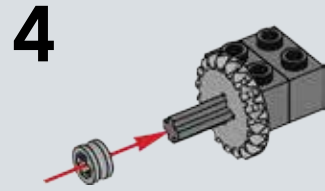
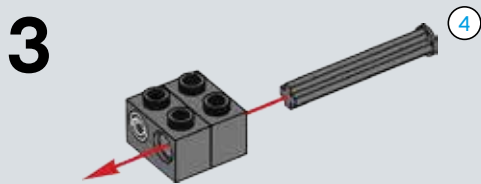
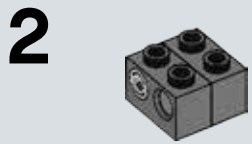
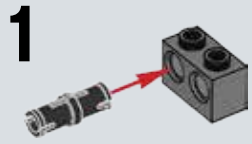

7

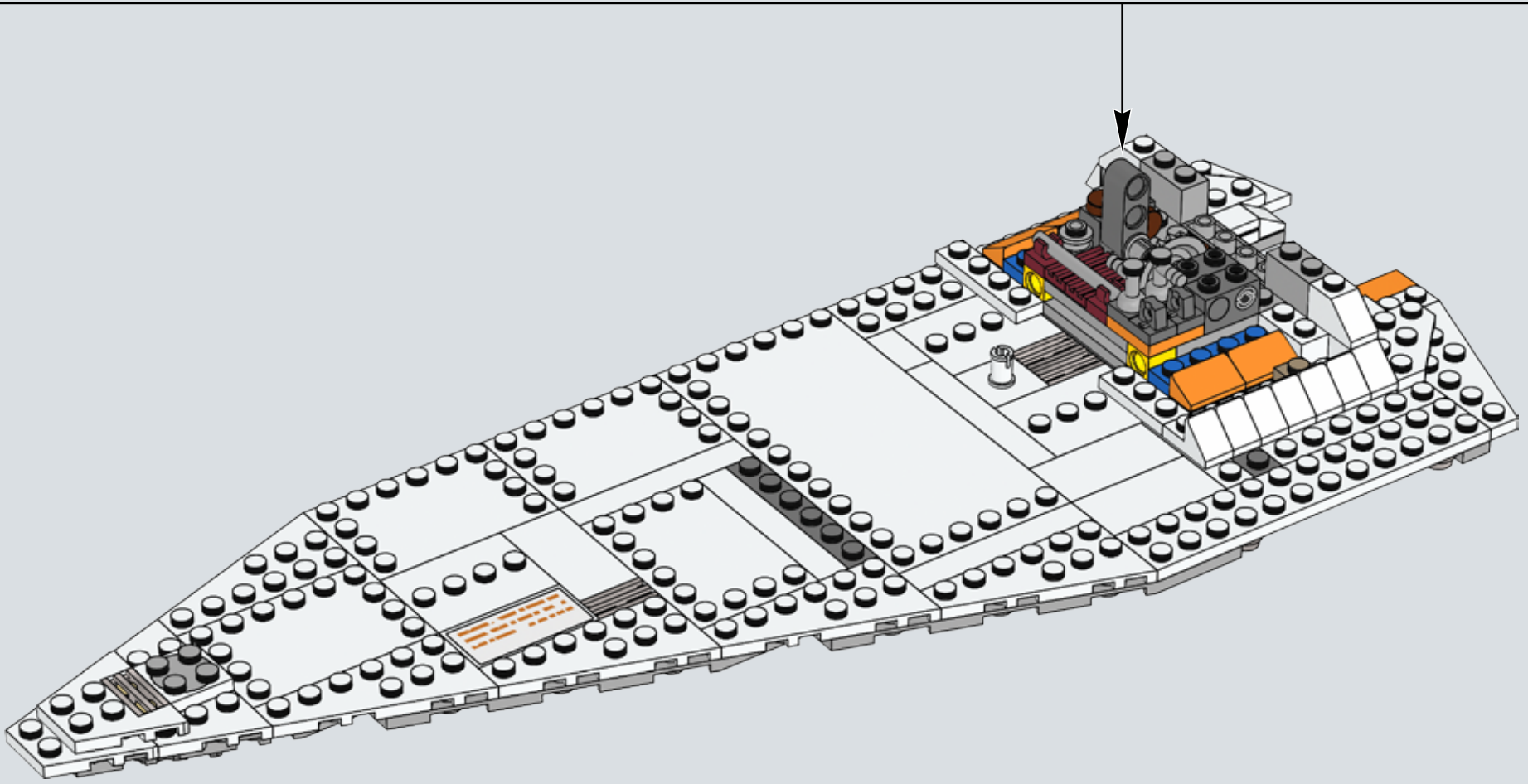
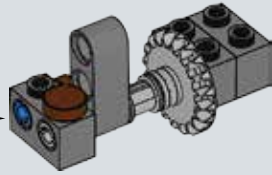
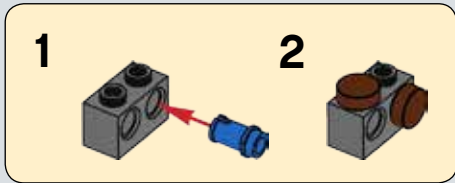

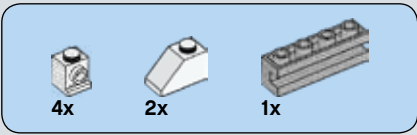

326

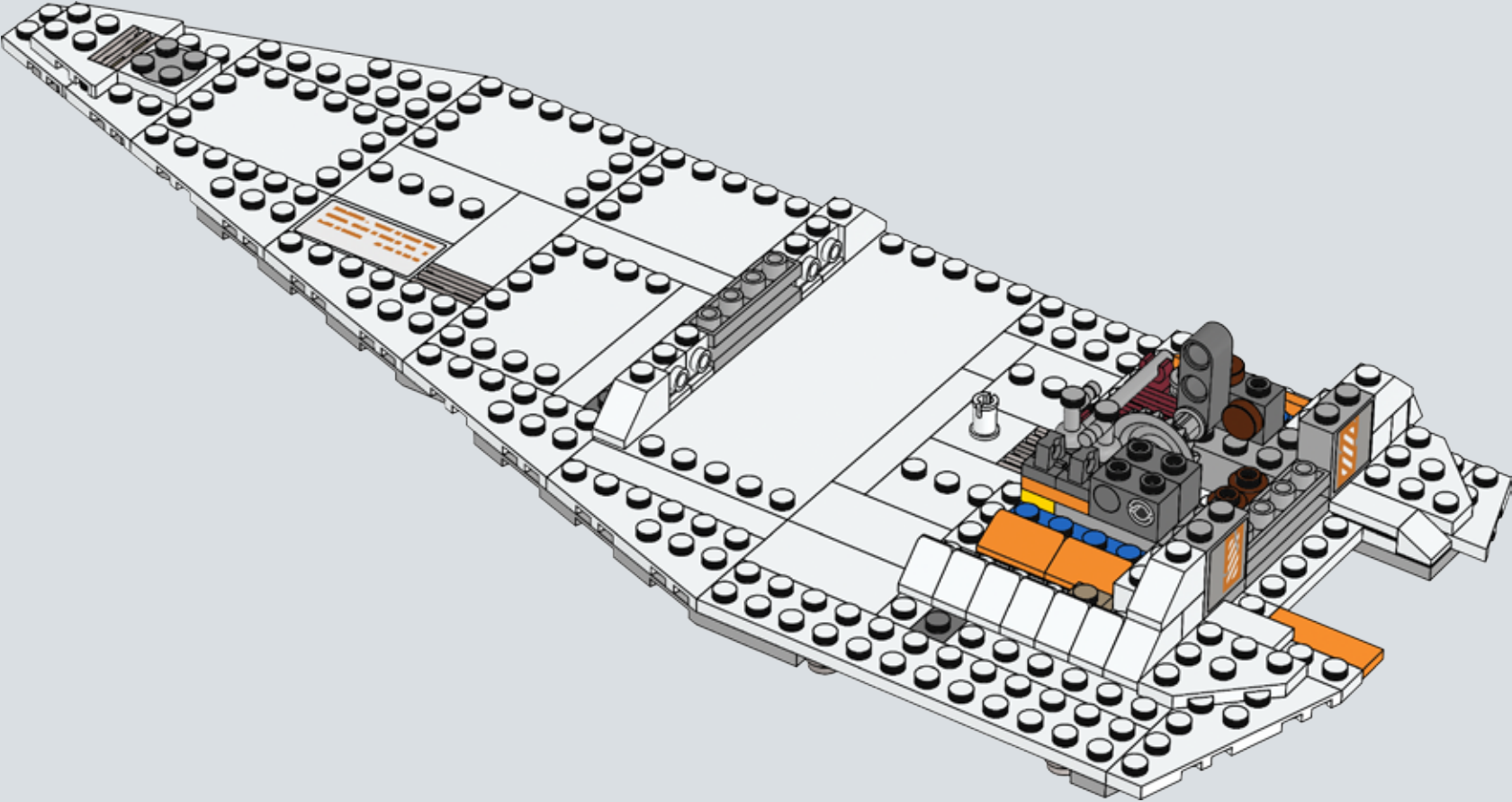

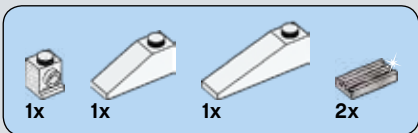

327

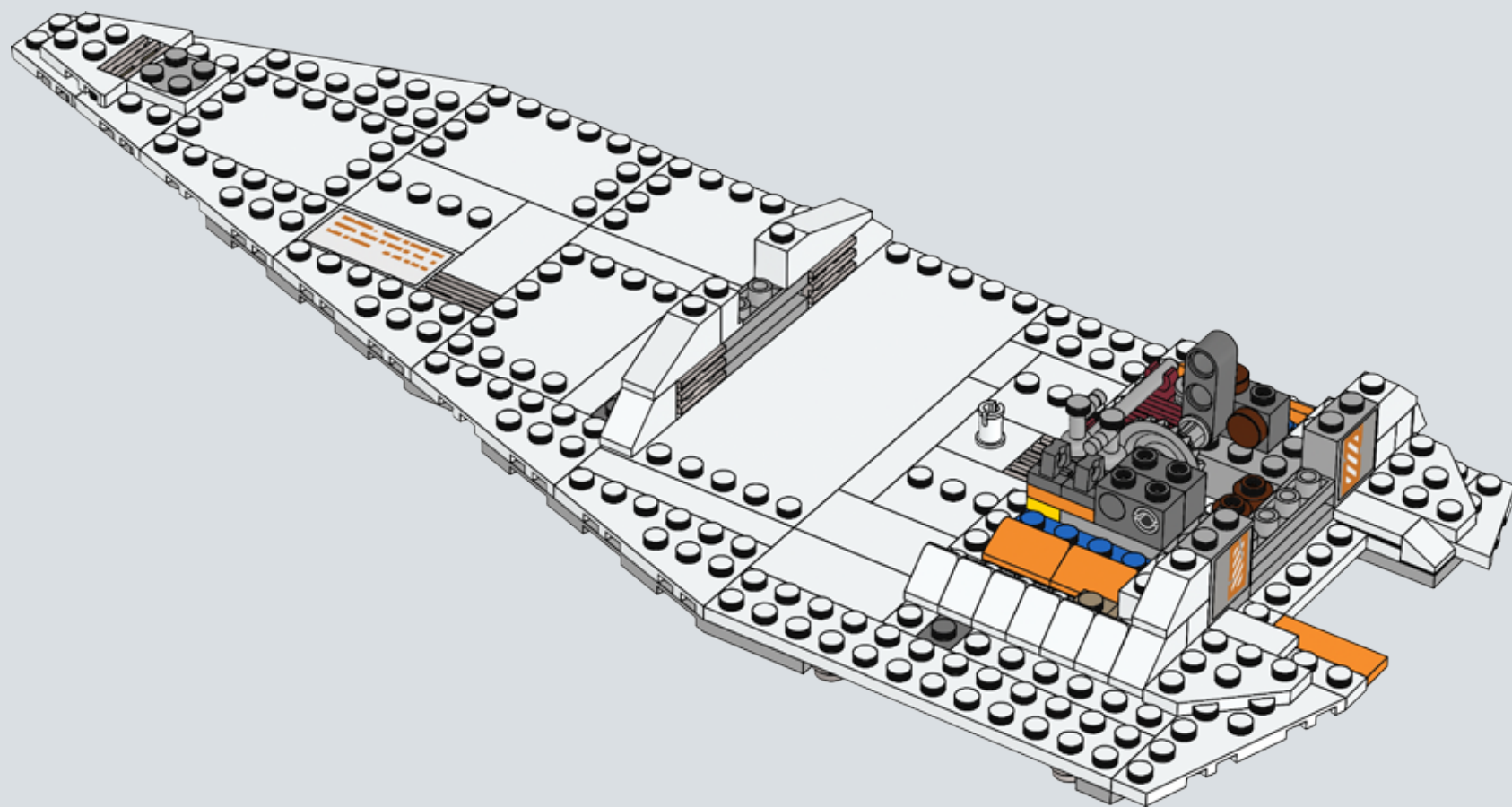



328

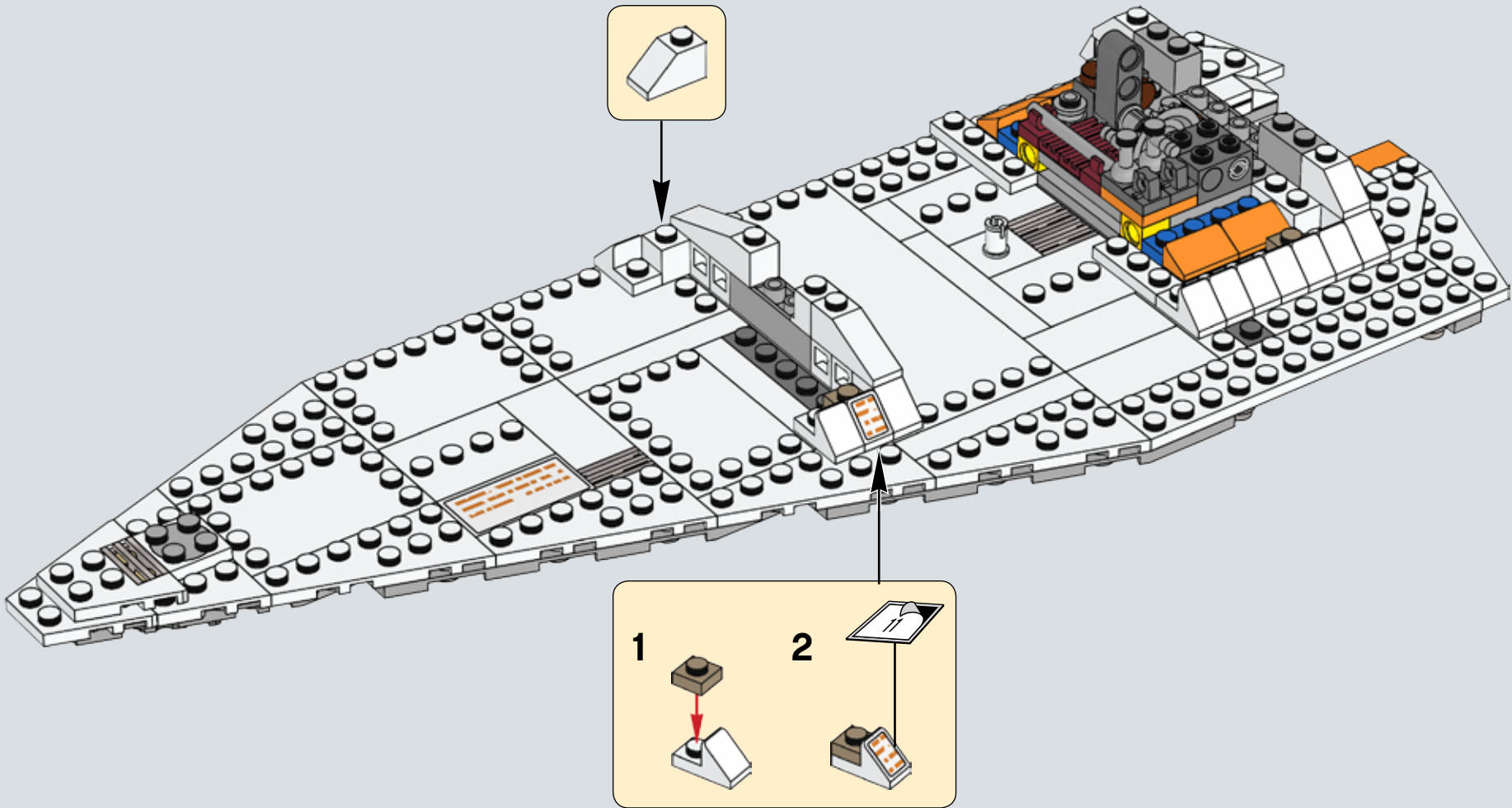

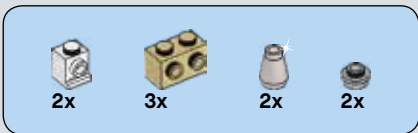

329

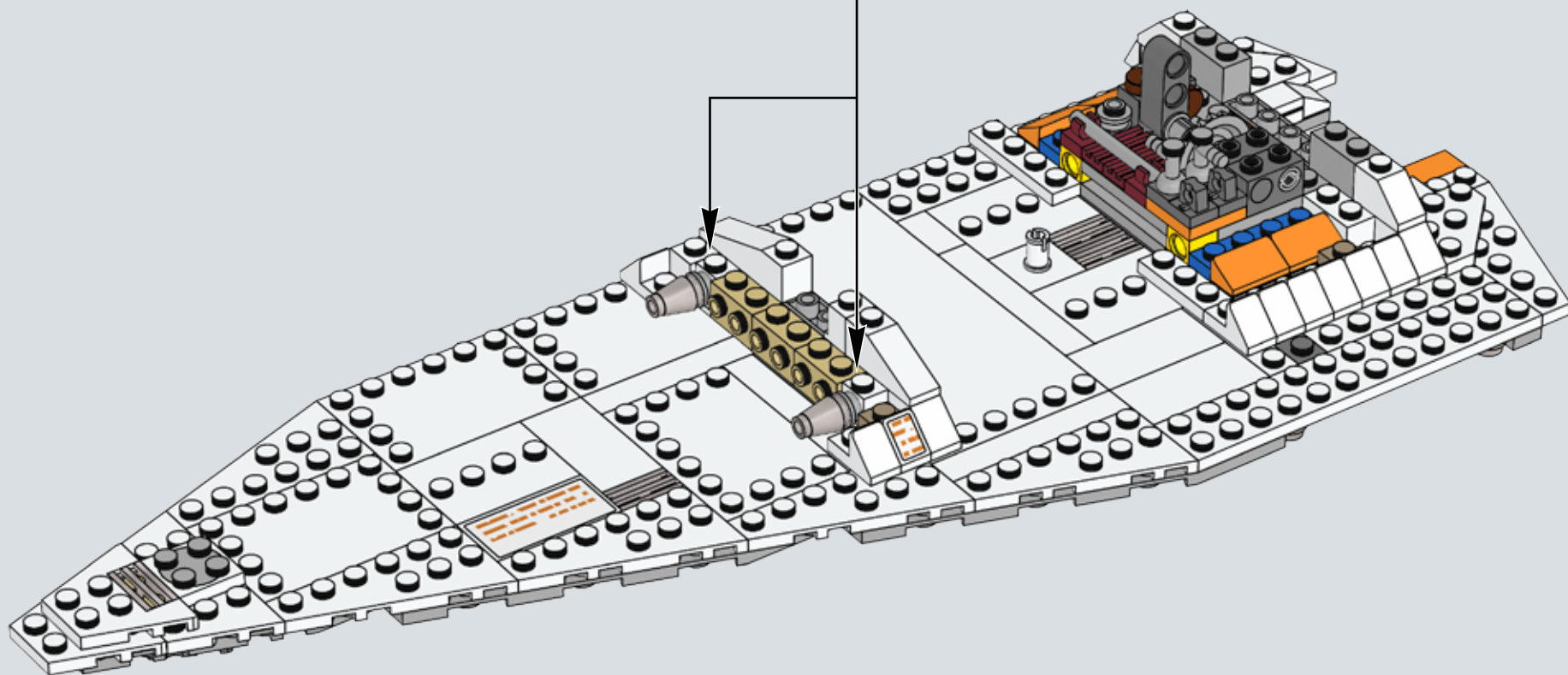
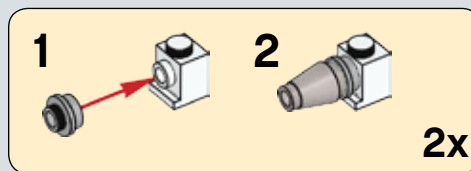



330

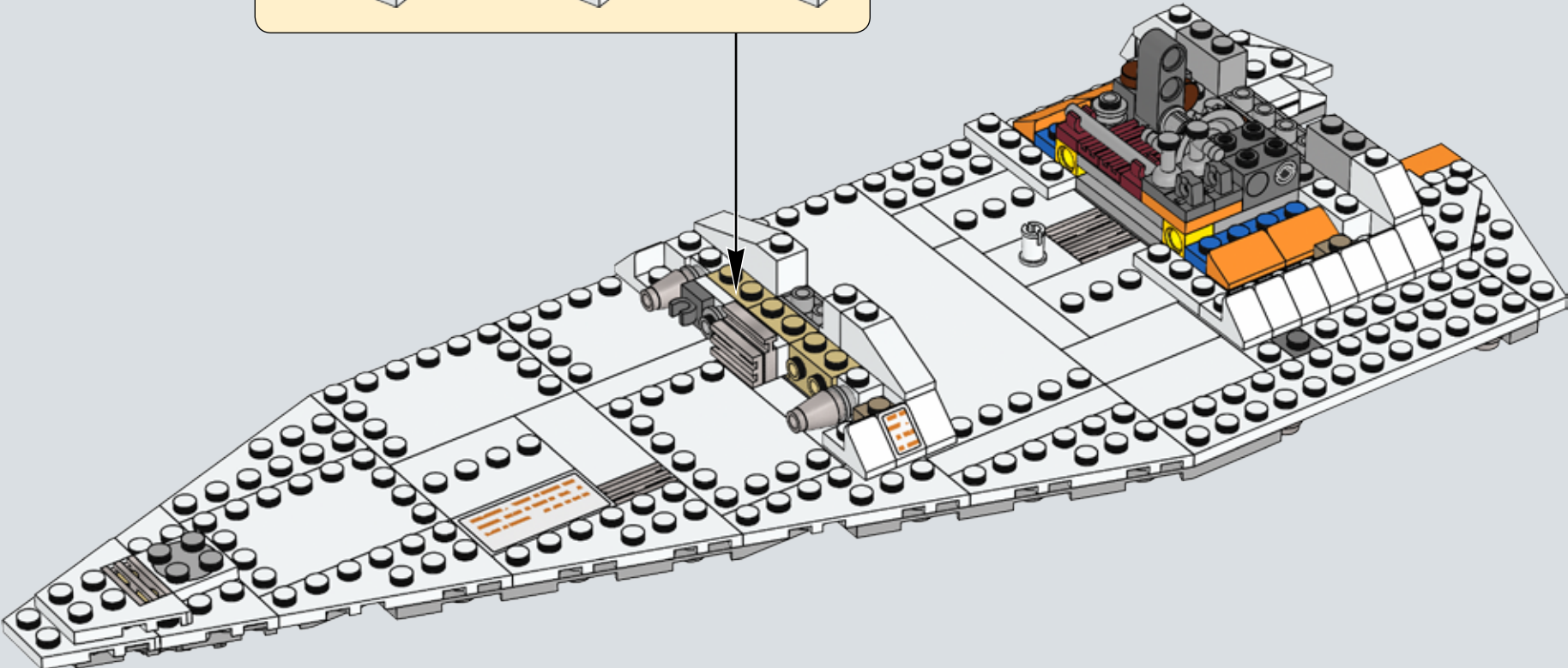
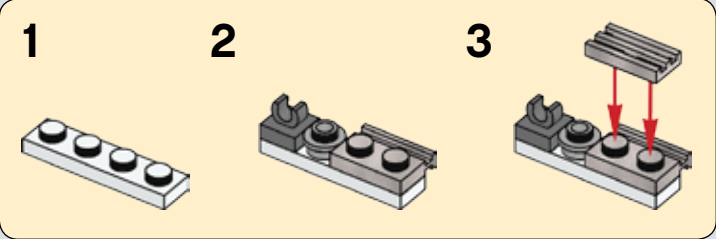



2x



1x

331

1

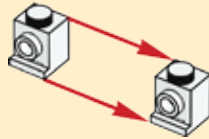

2

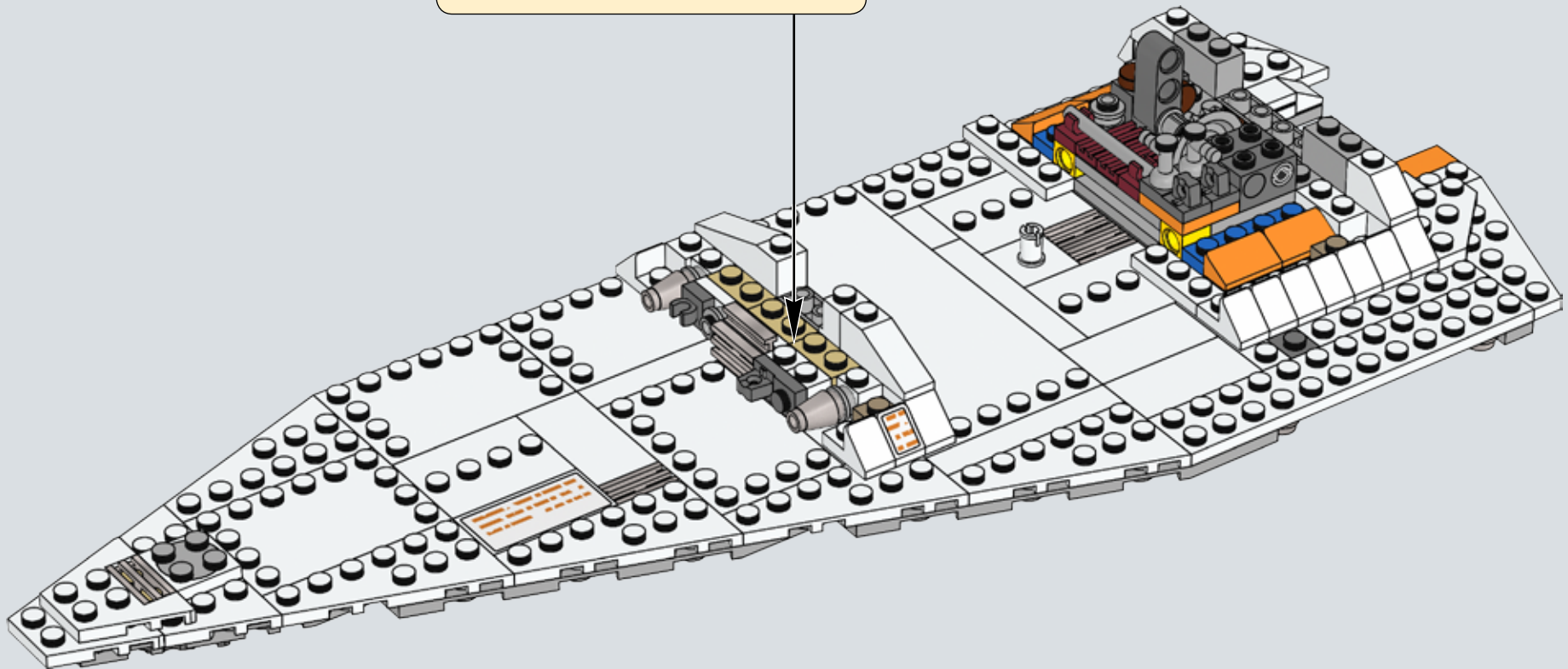
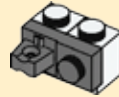

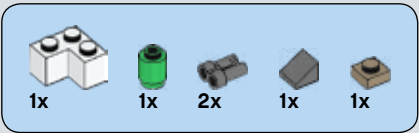

332

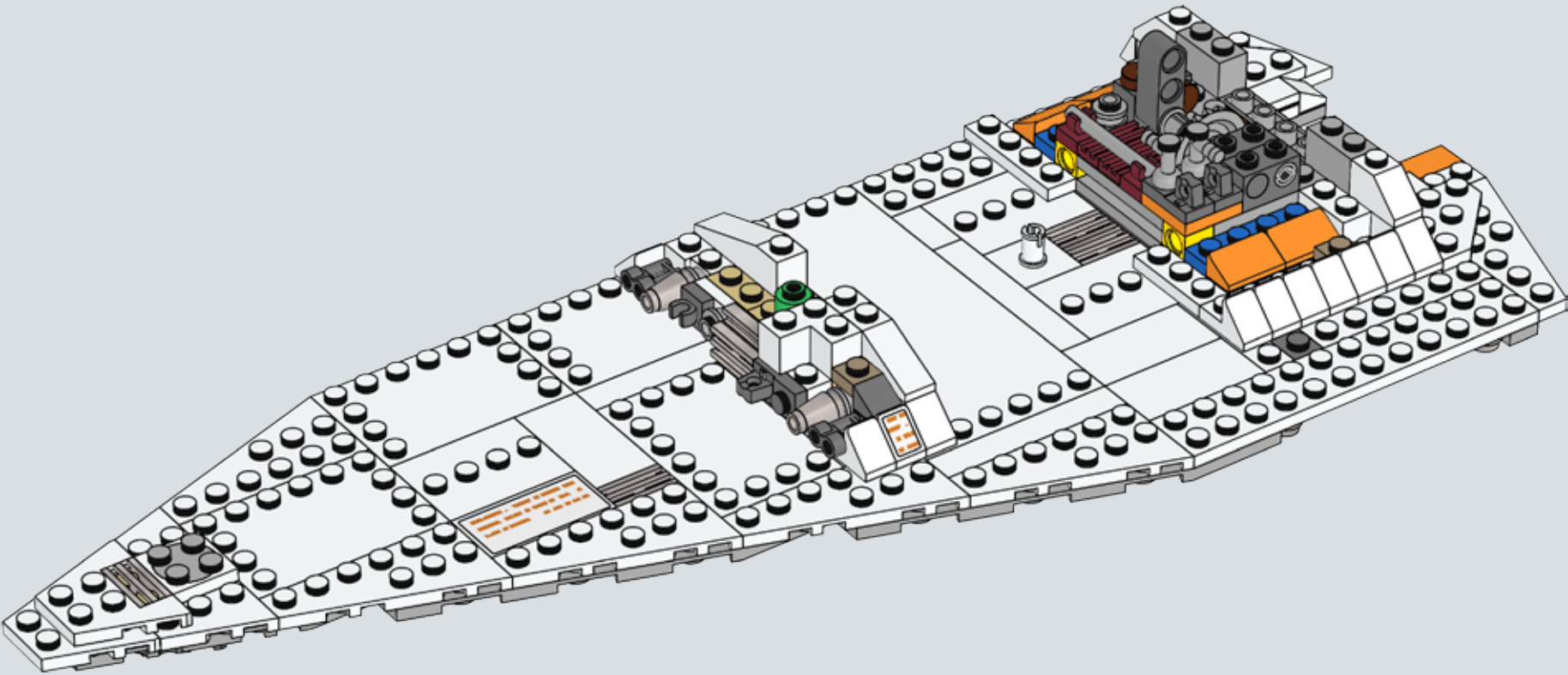

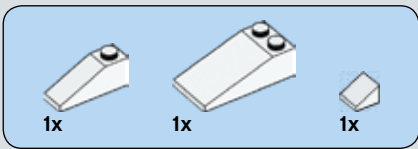

333

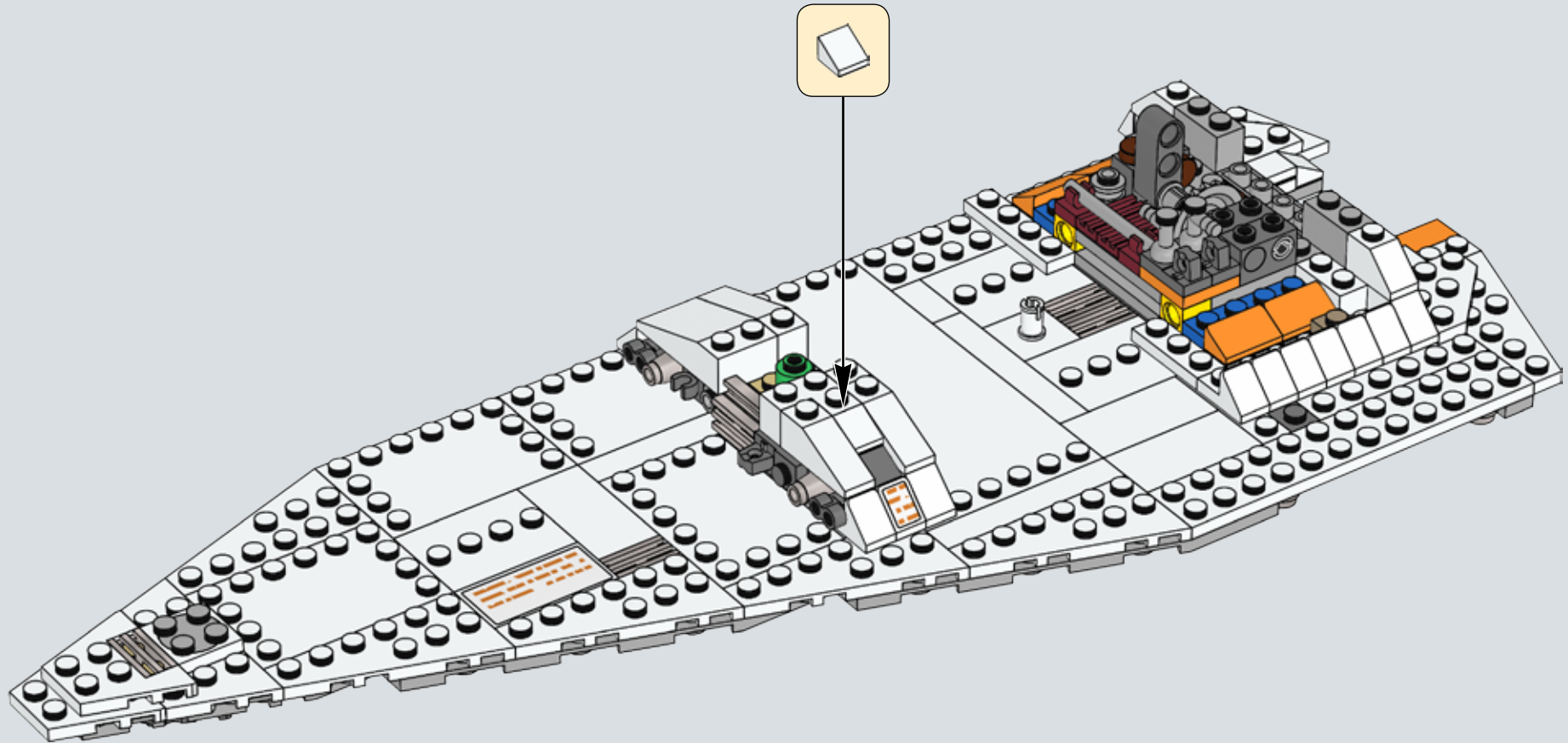

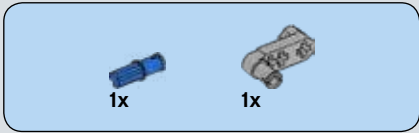
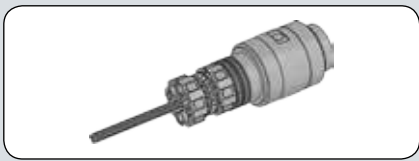

334

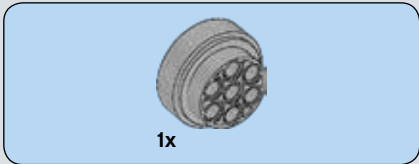
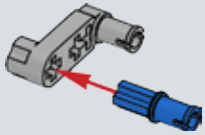

335

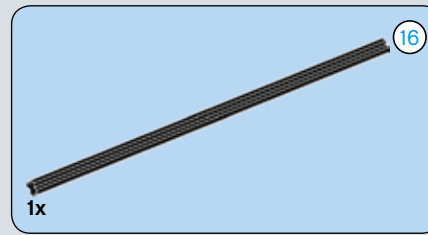
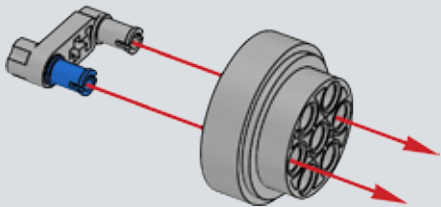

336

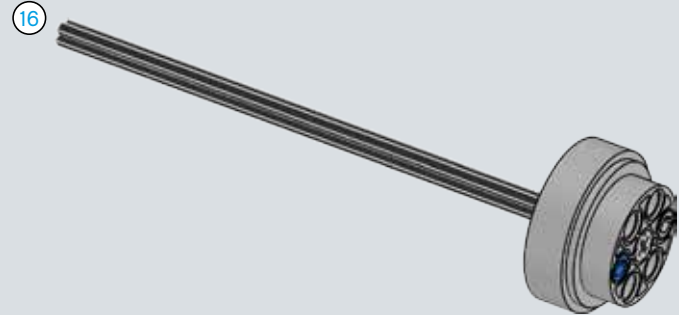

337

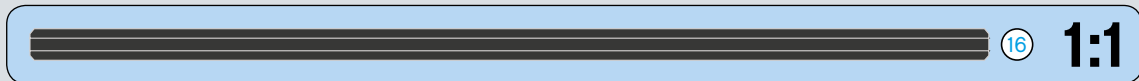
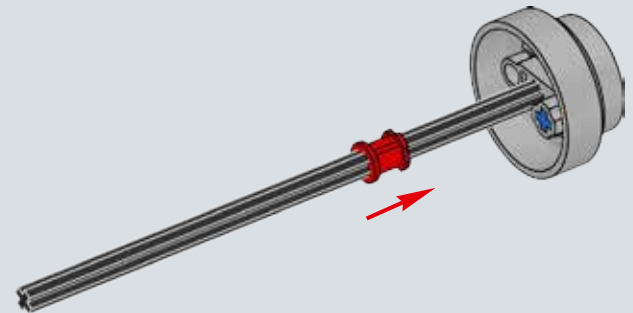

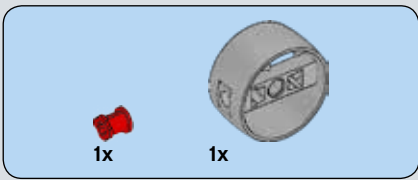

338

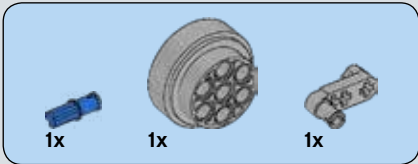
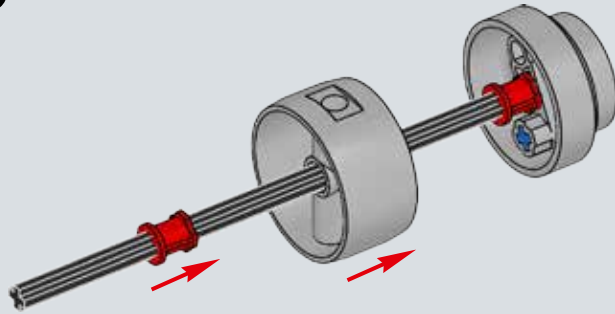

339

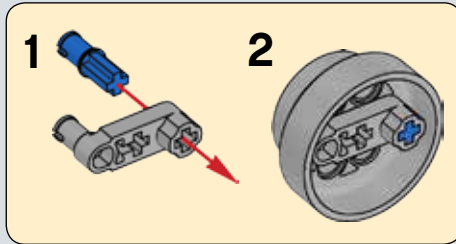

340

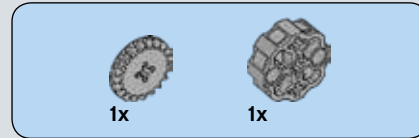
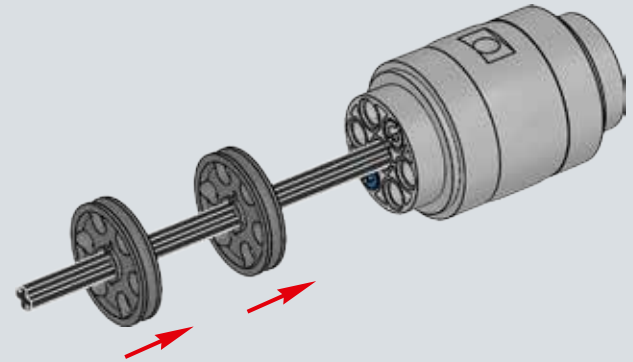

341

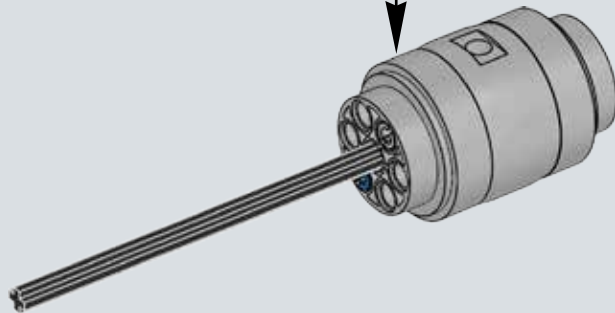
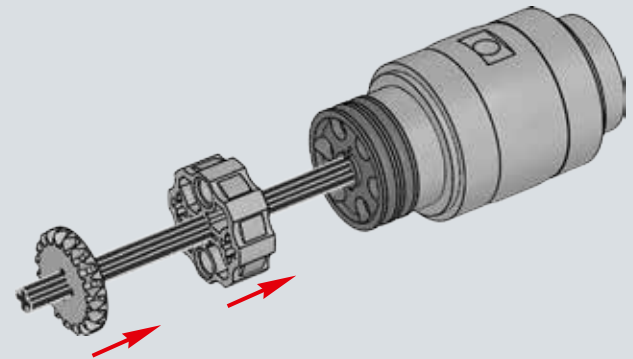

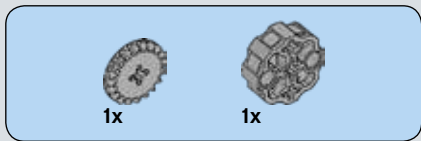

342

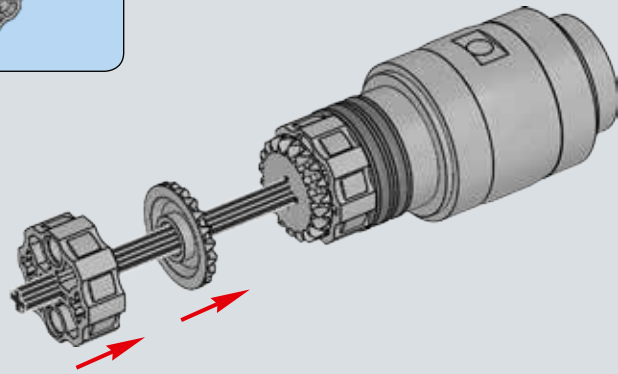

343

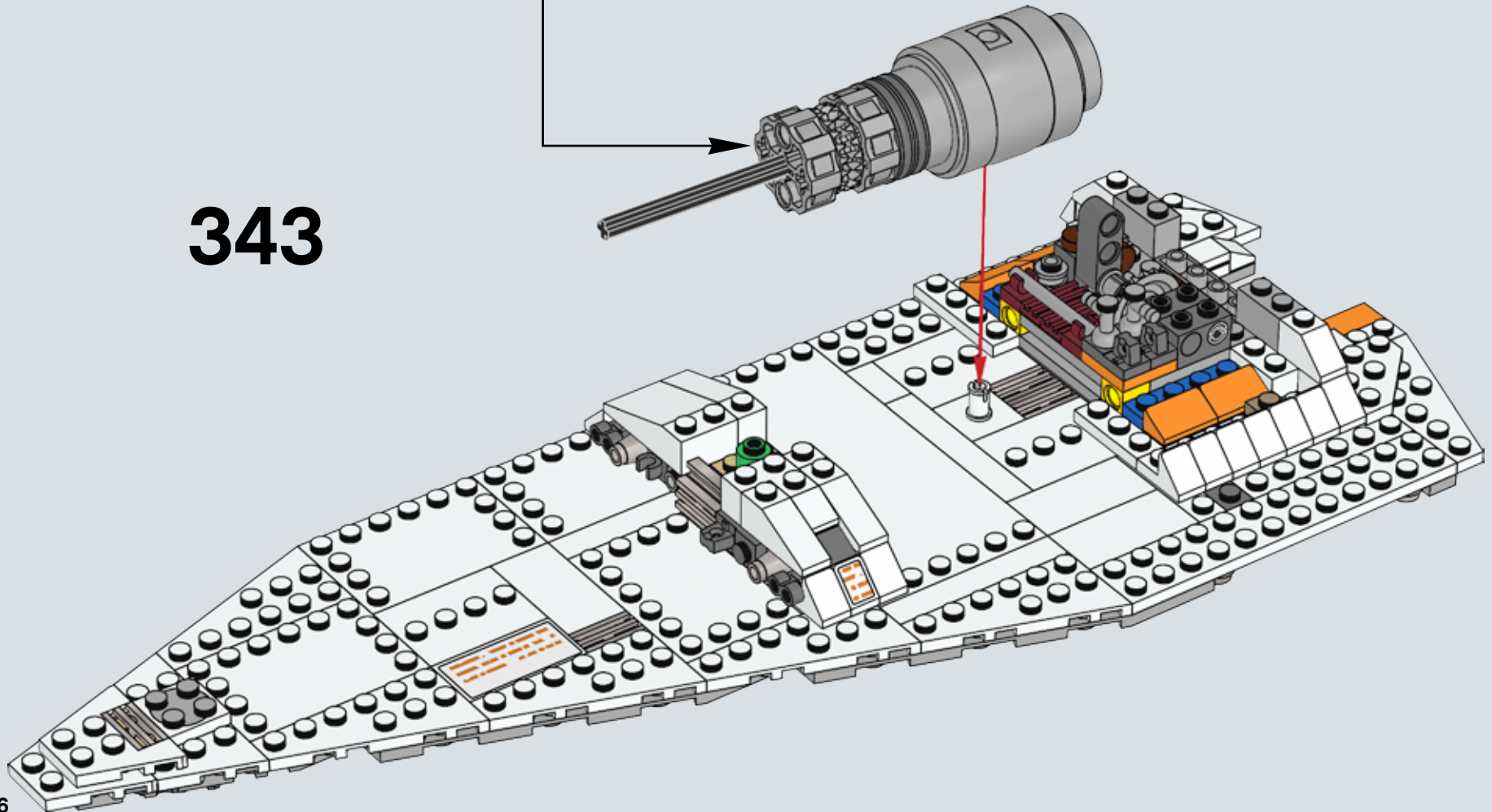

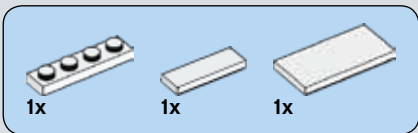

344

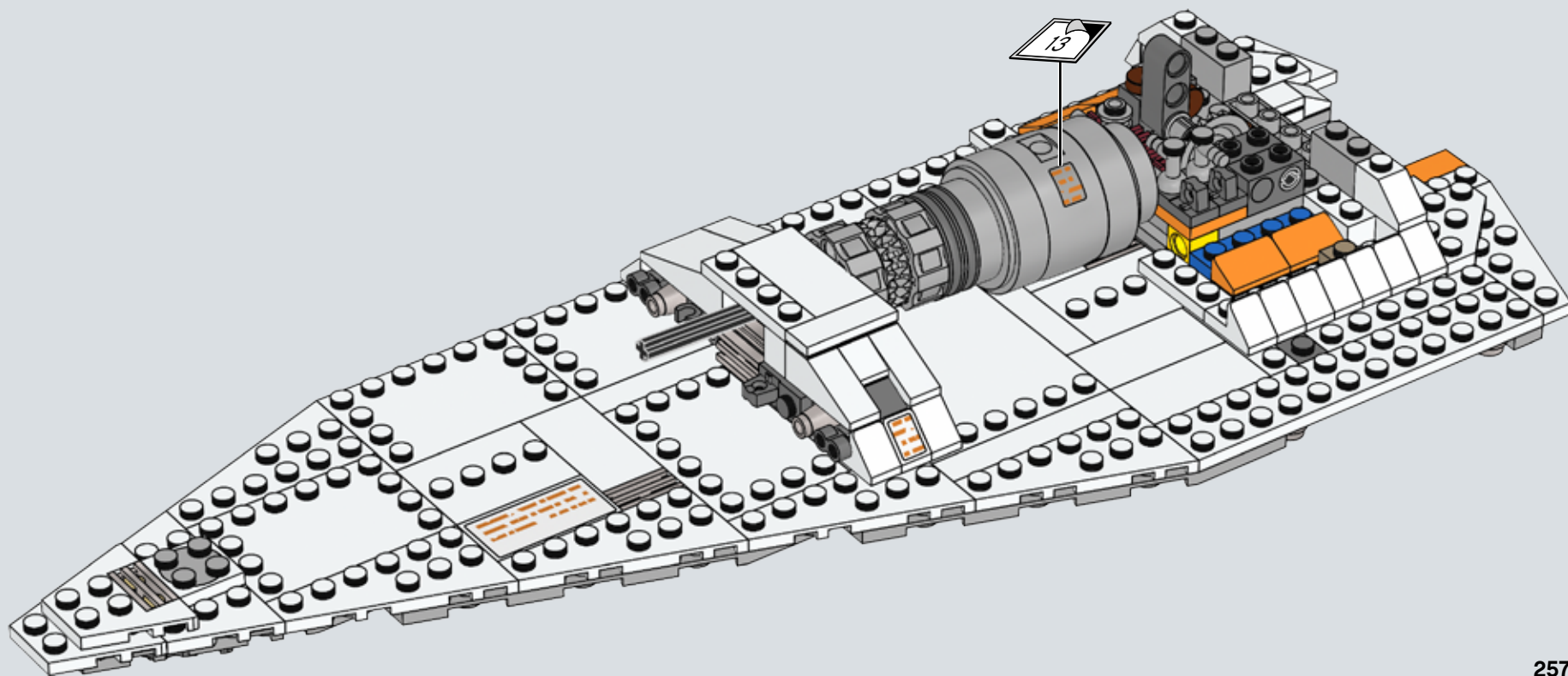



1x



1x

345

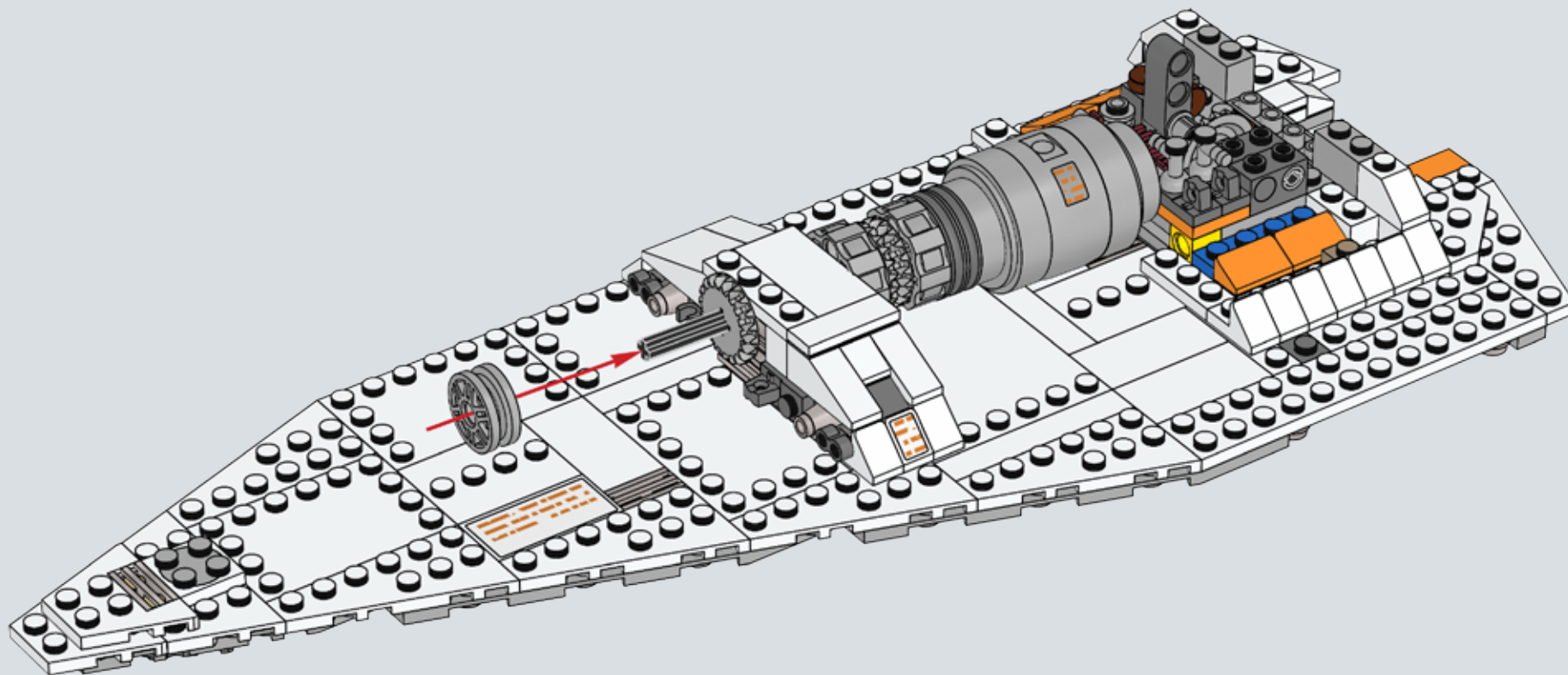



346

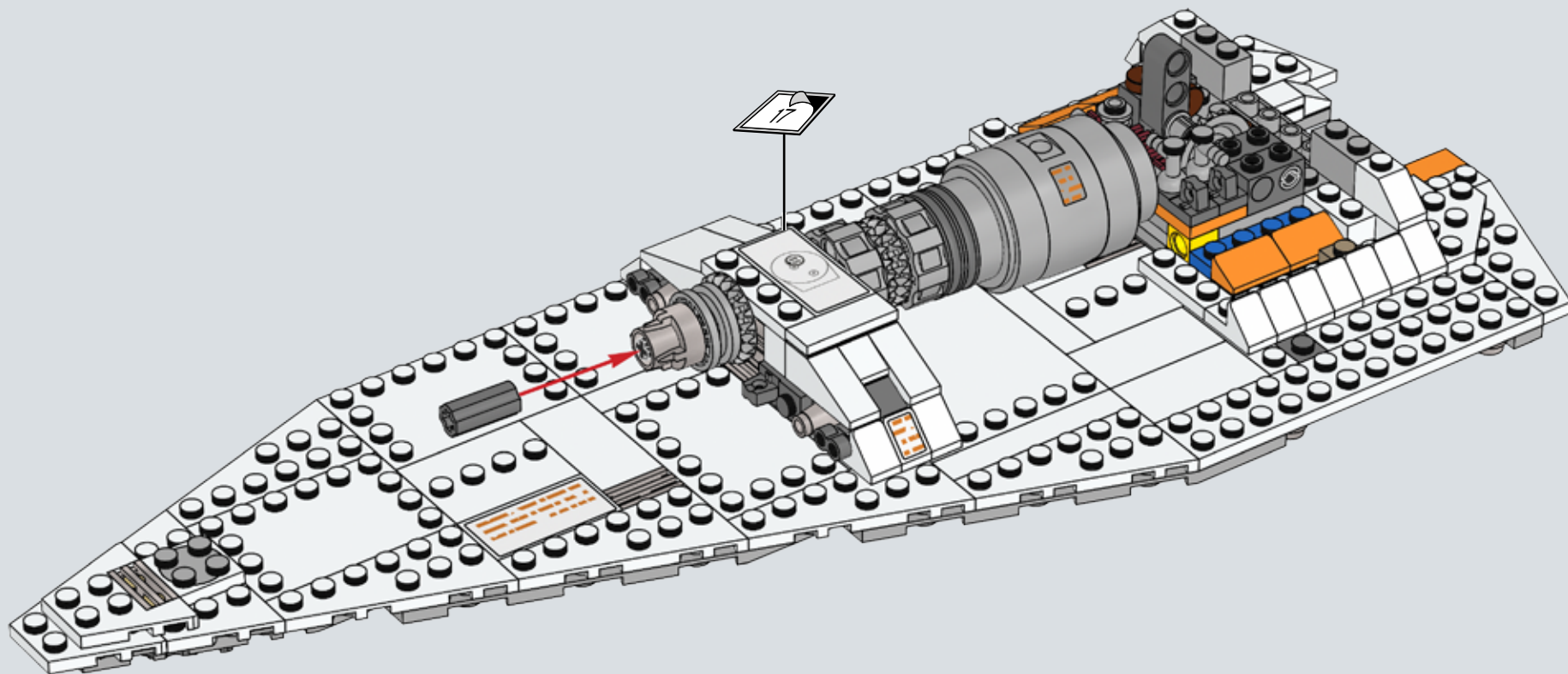

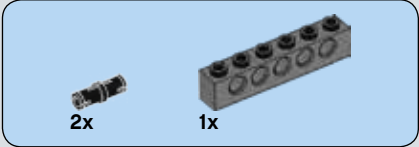

347

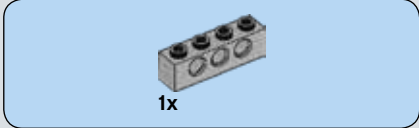
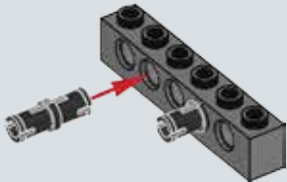

348

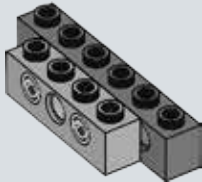

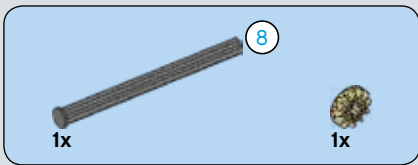

349

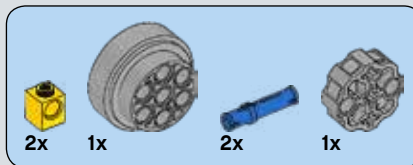
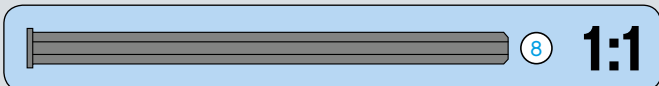
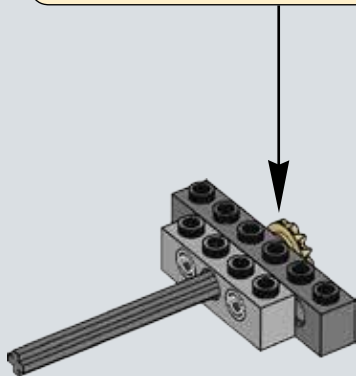
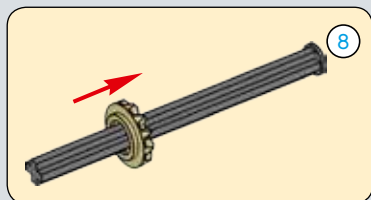

350

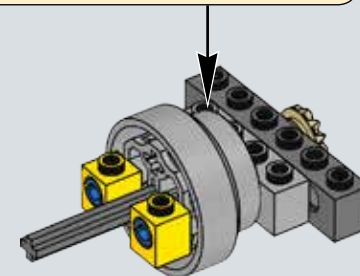
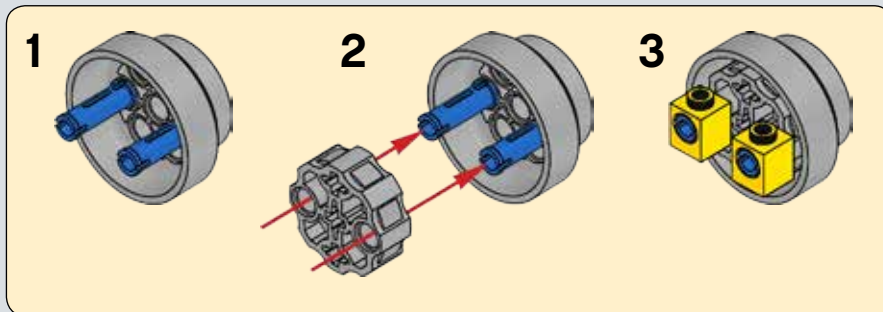

351

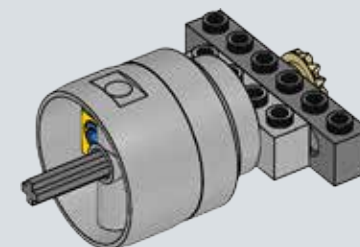

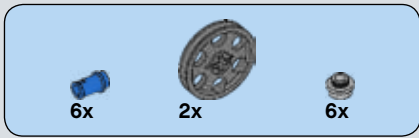

352

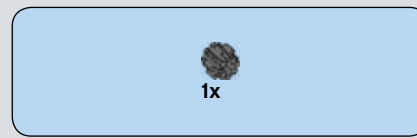
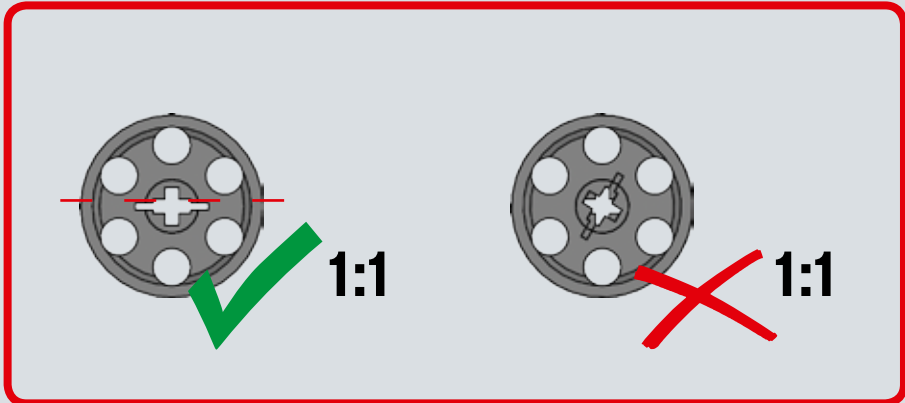
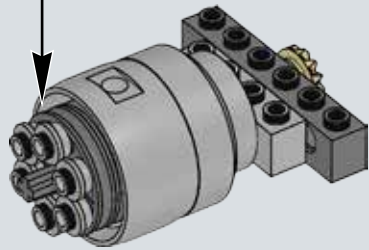
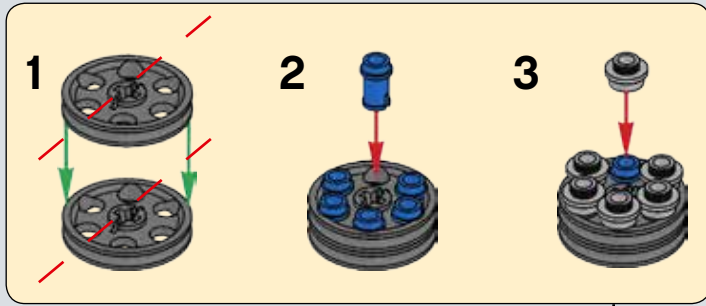

353

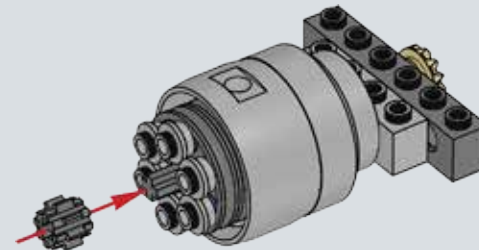

354

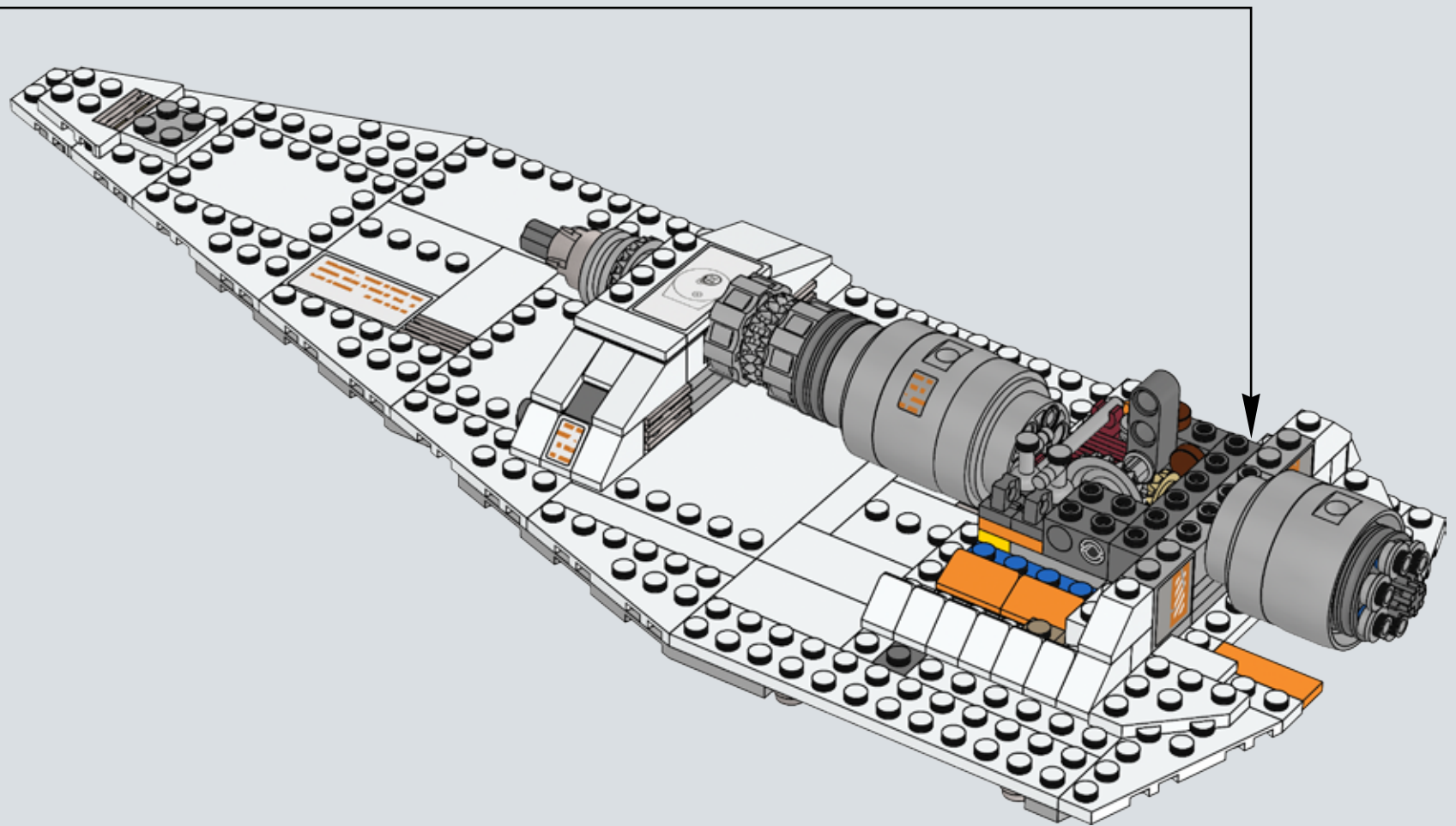



355

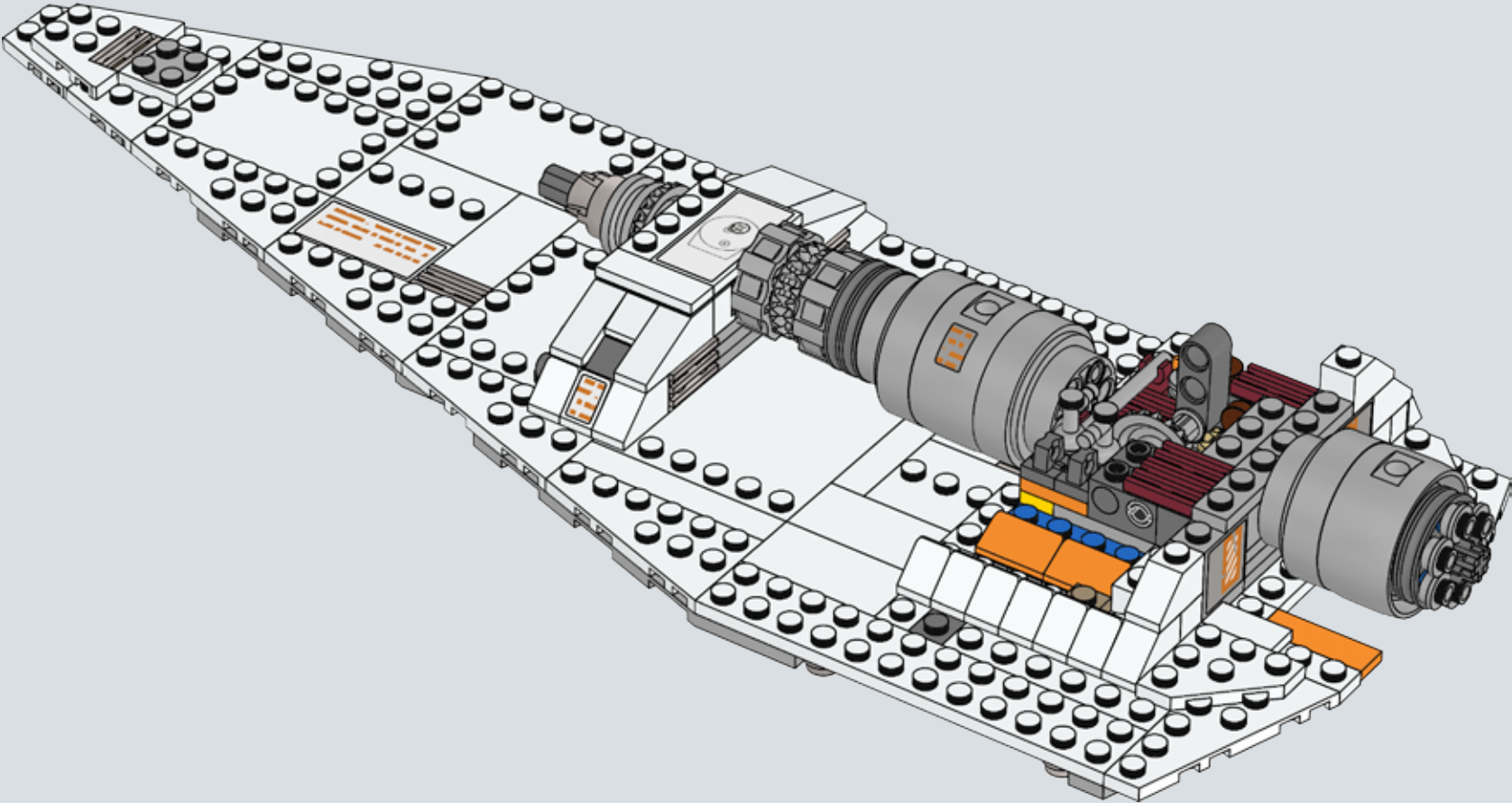



356

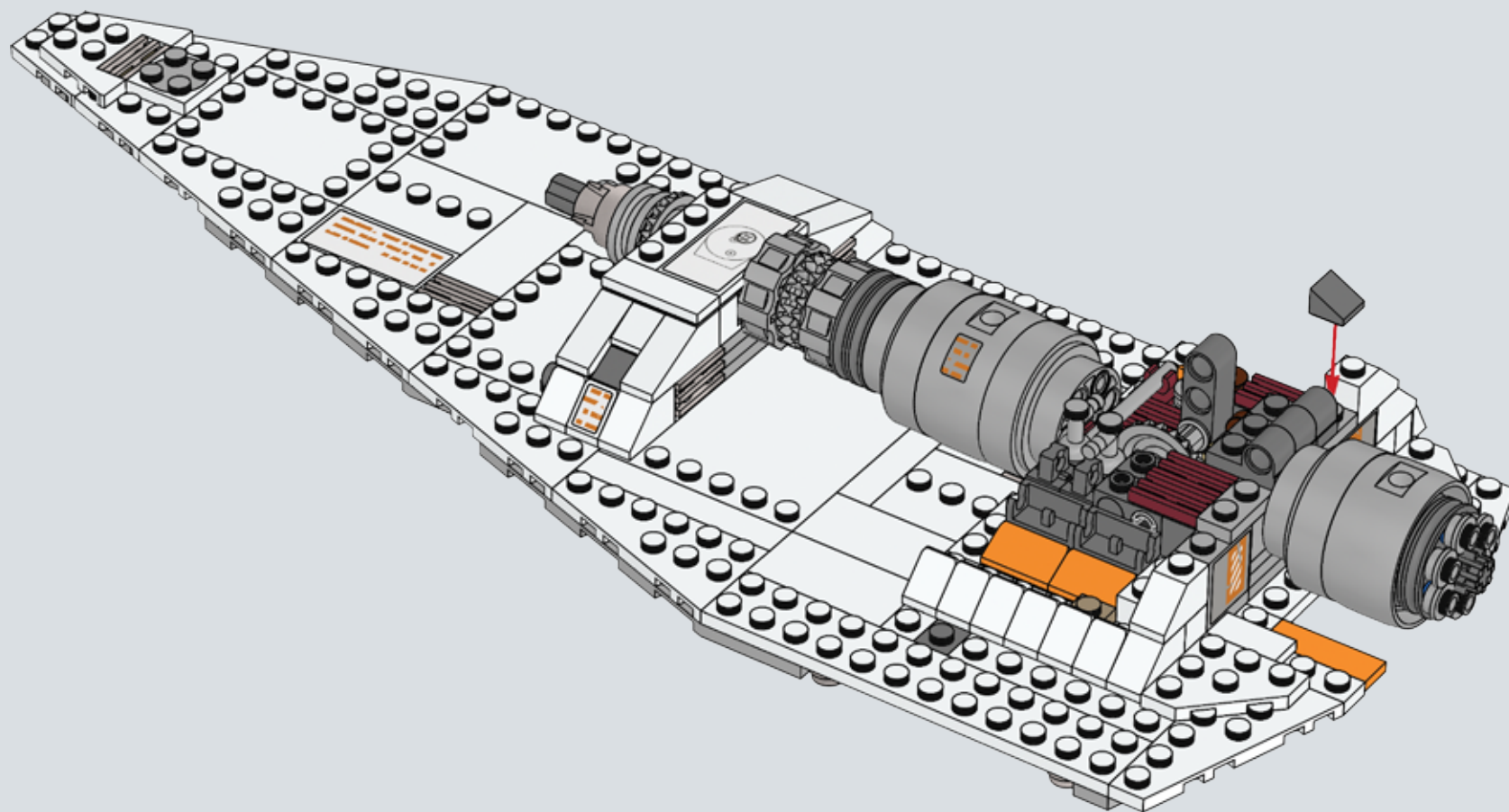



357

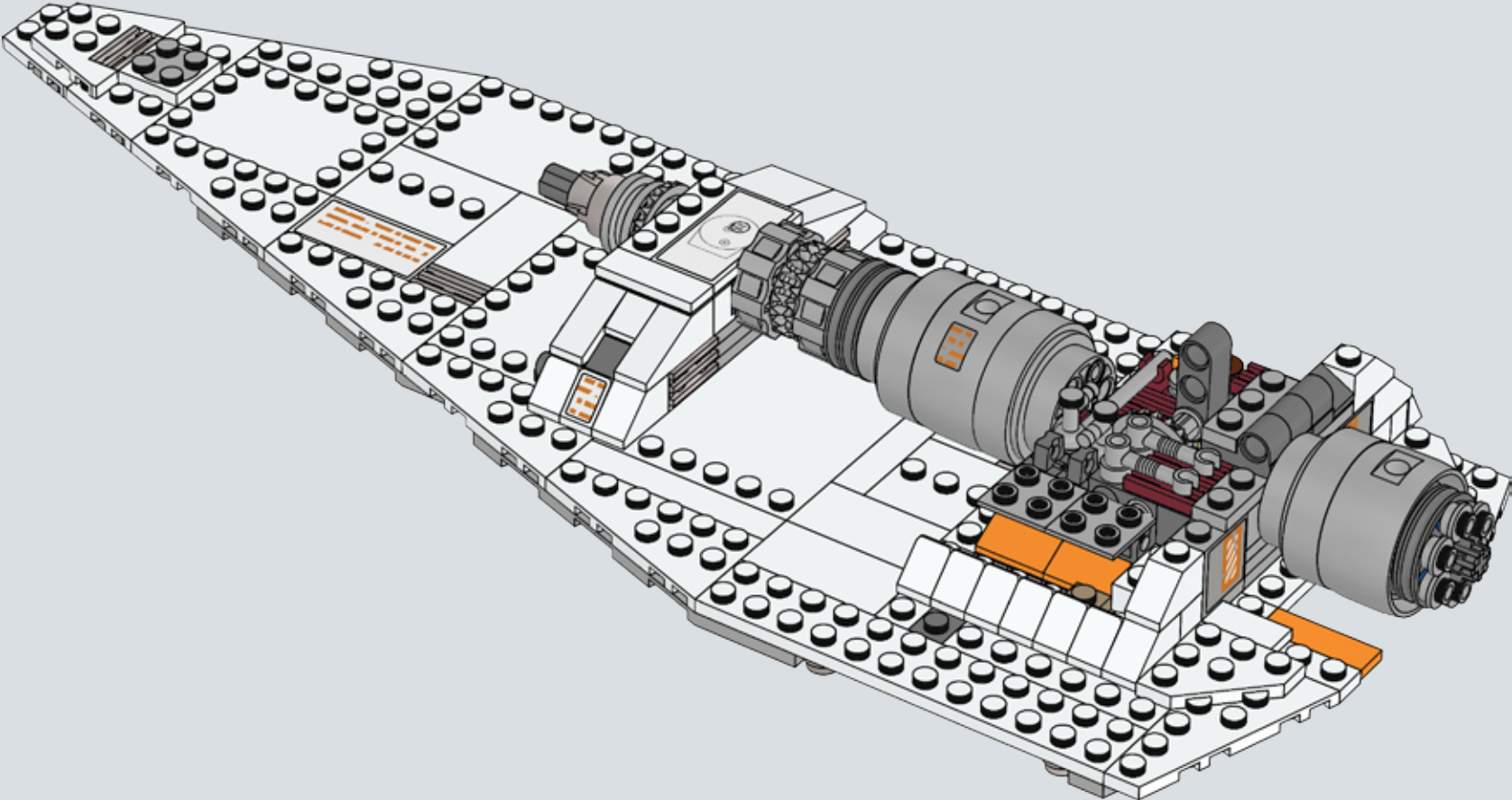



358

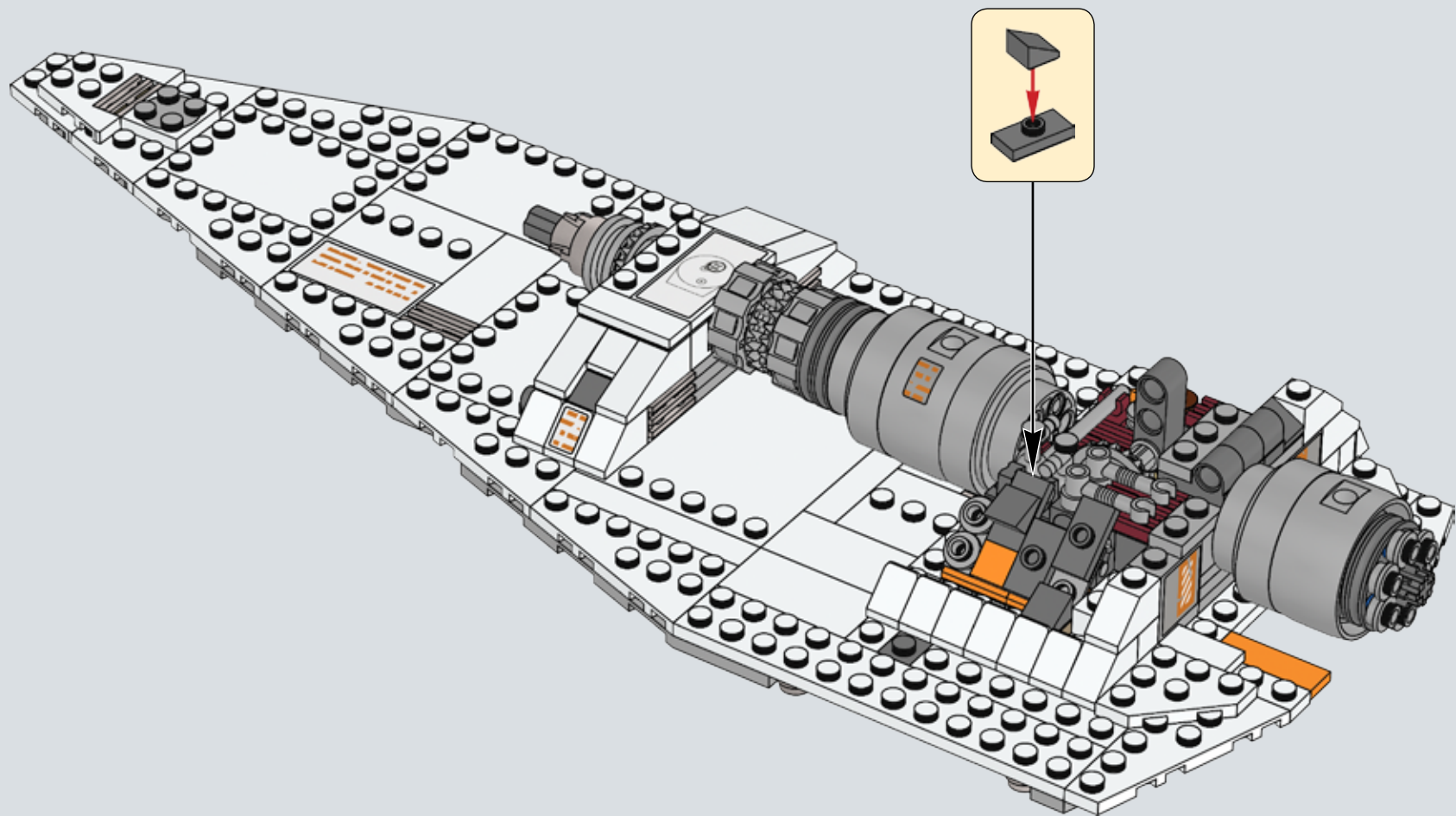



359

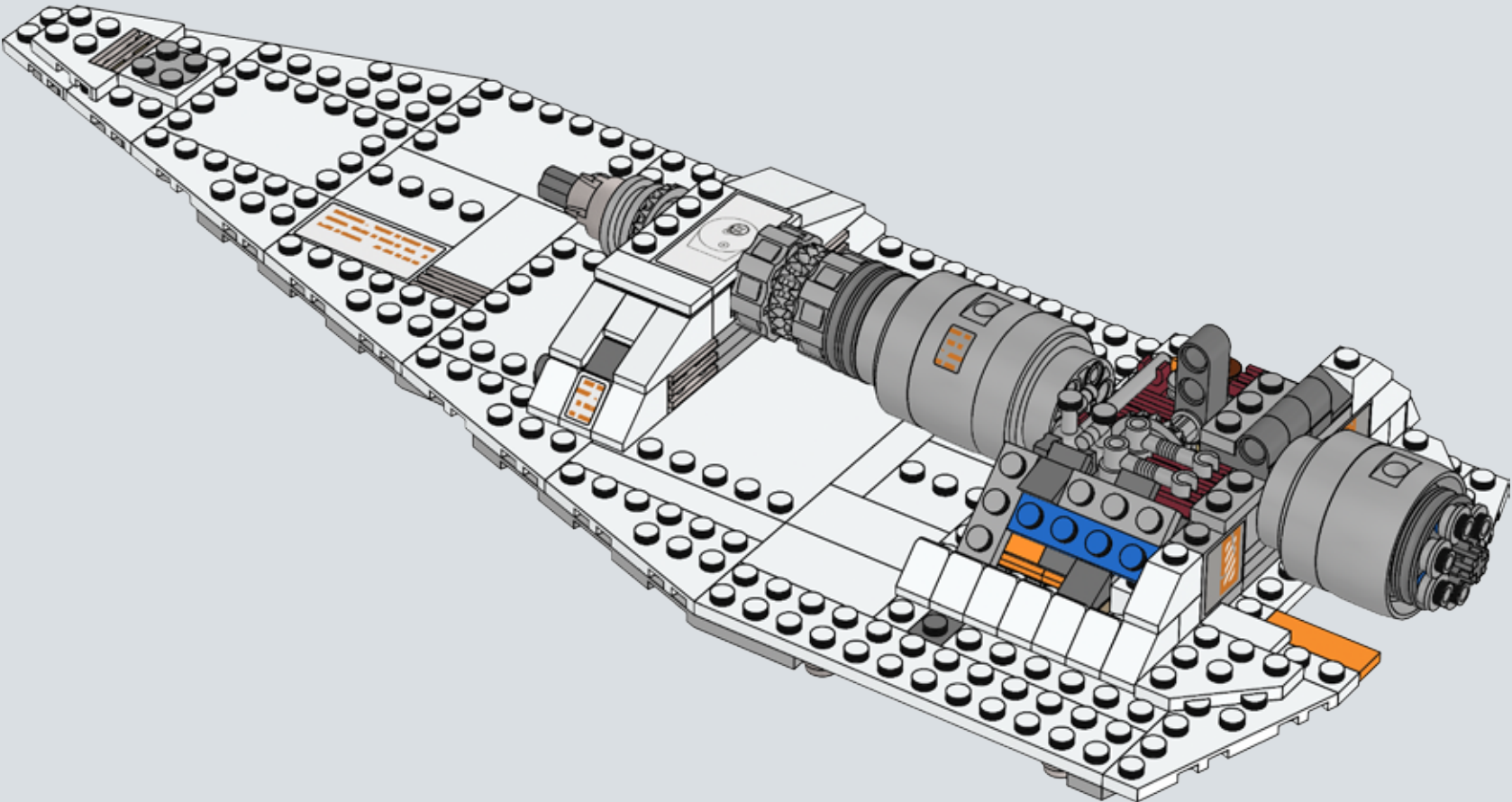

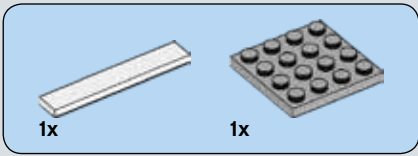
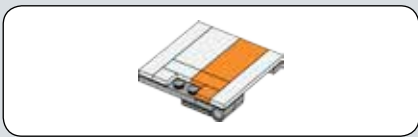

360

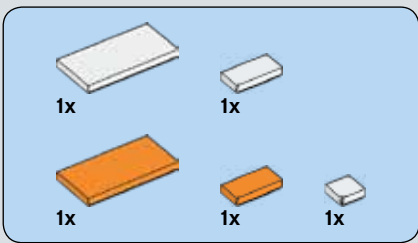
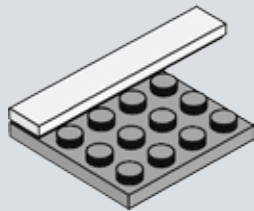

361

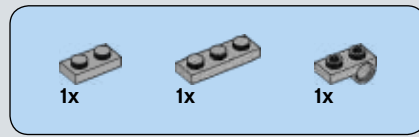
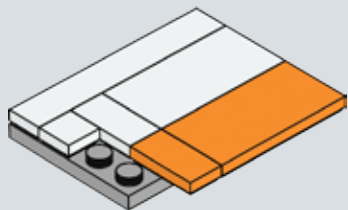

362

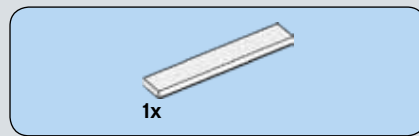
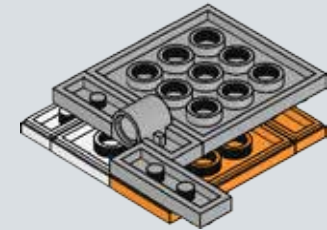
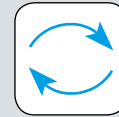

363

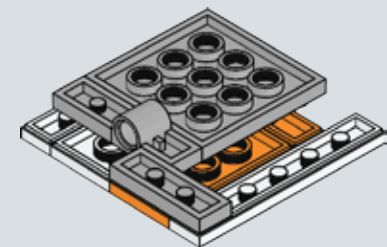



2x

364

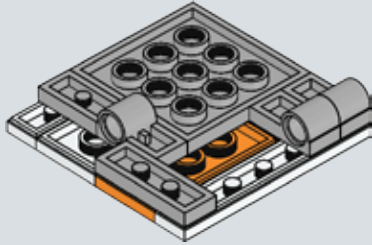

1x



1x

365

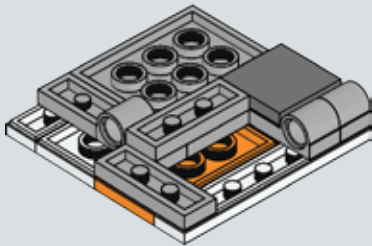

1x

366

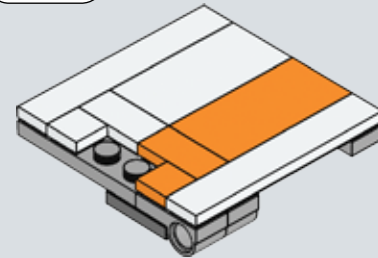
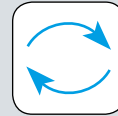

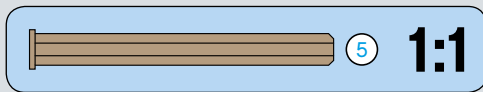
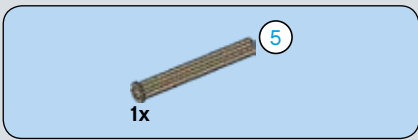

367

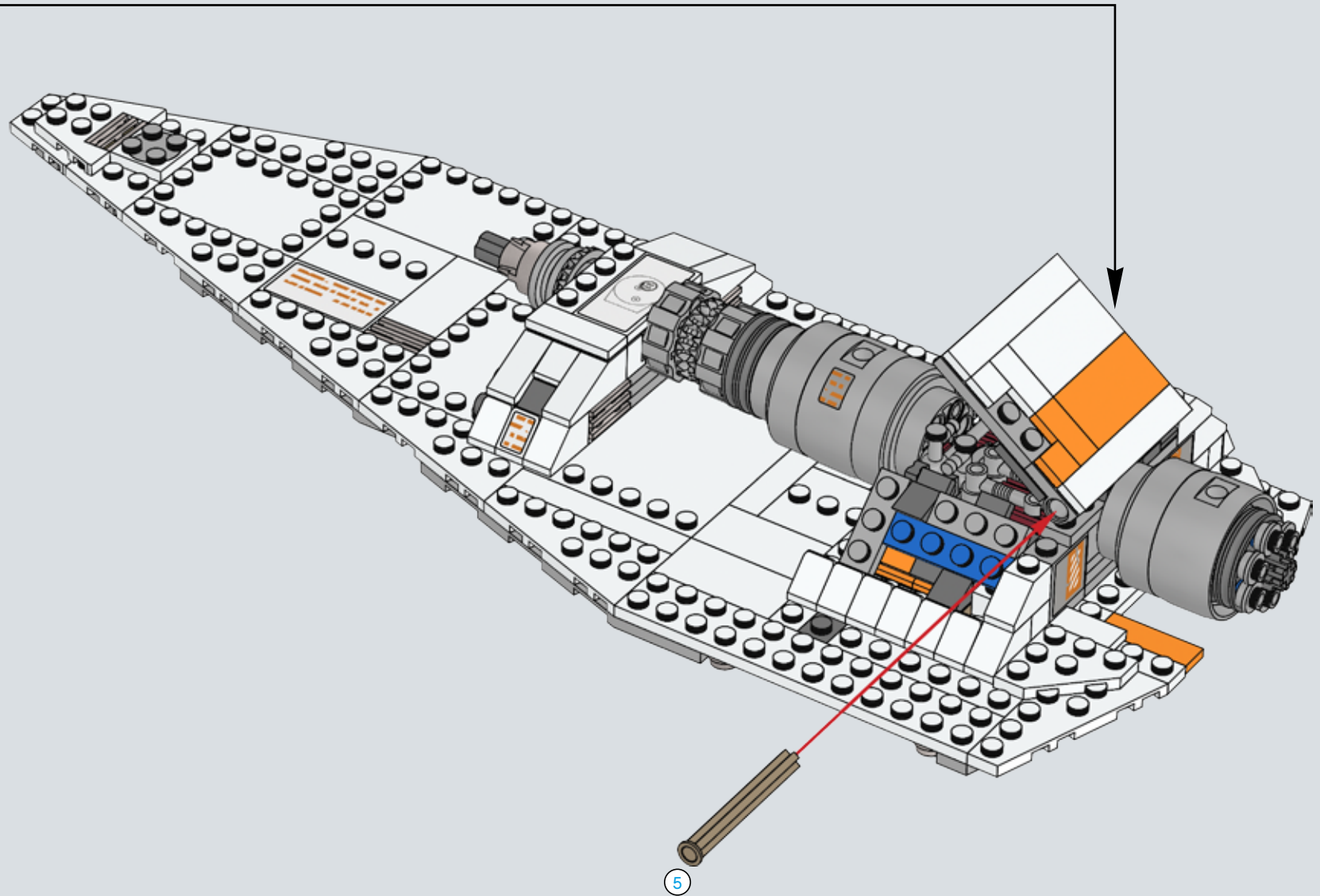



1x

368

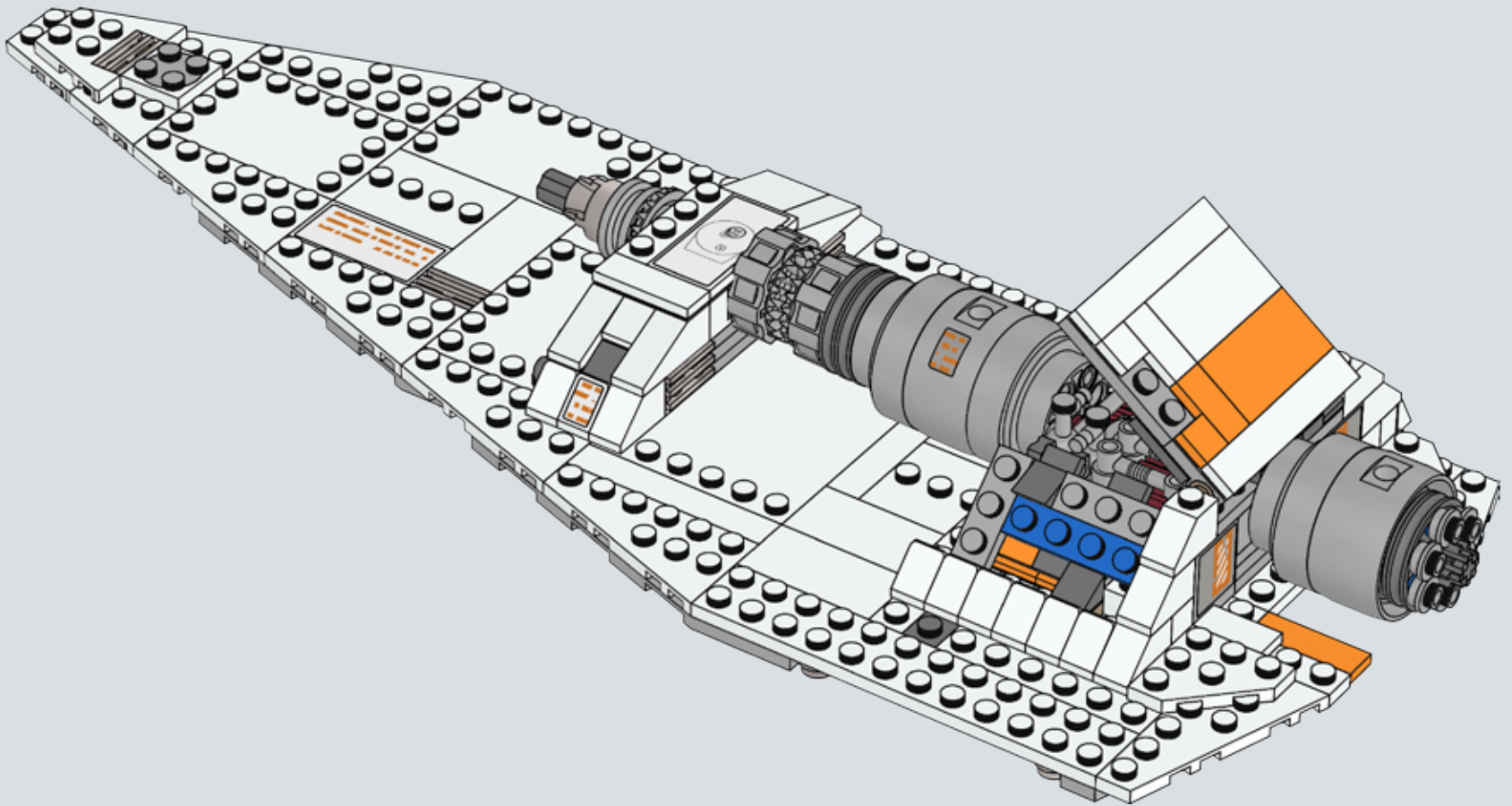

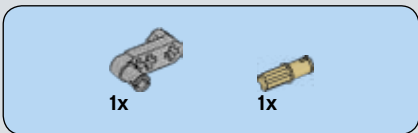

369

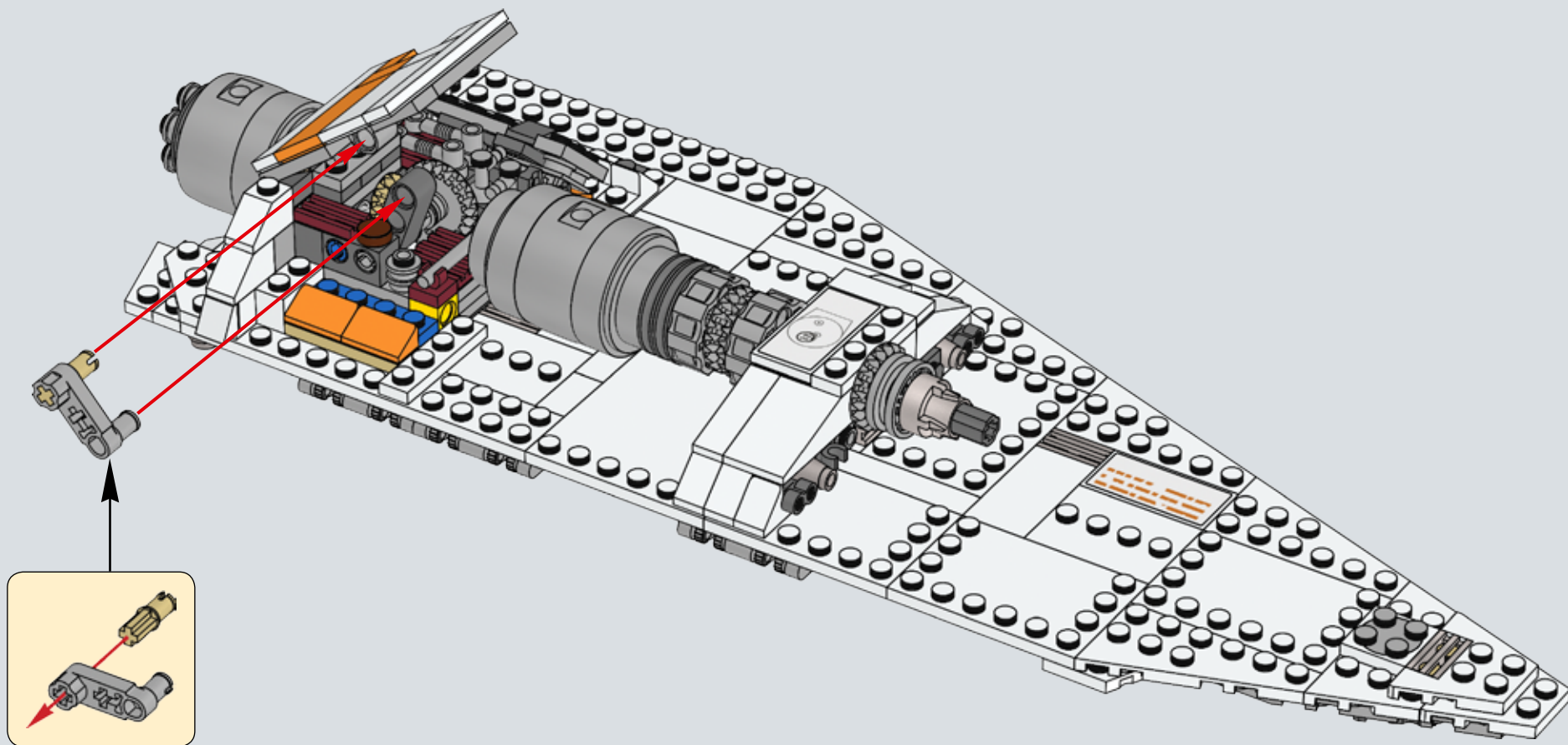
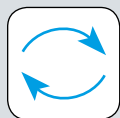

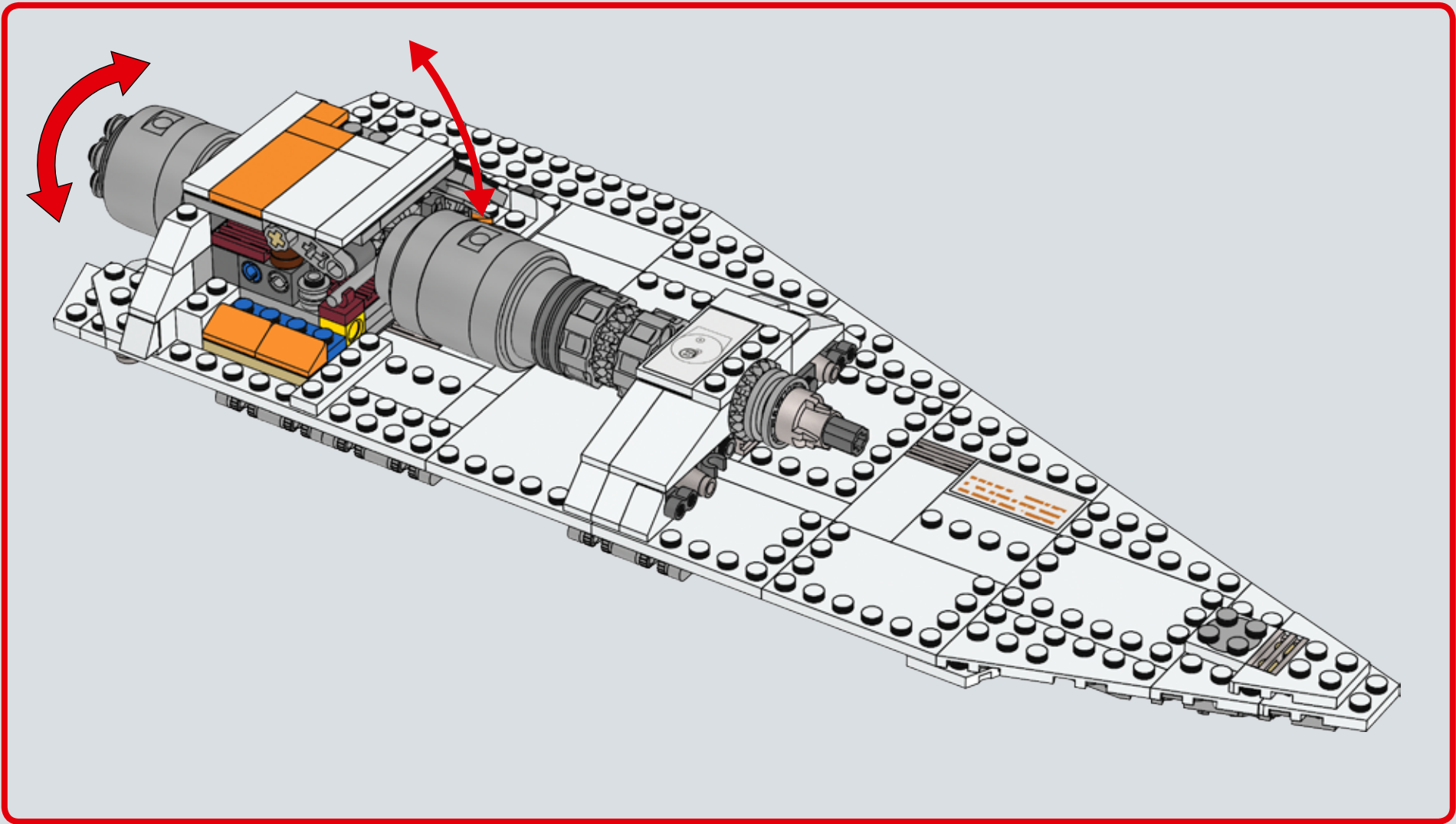



370

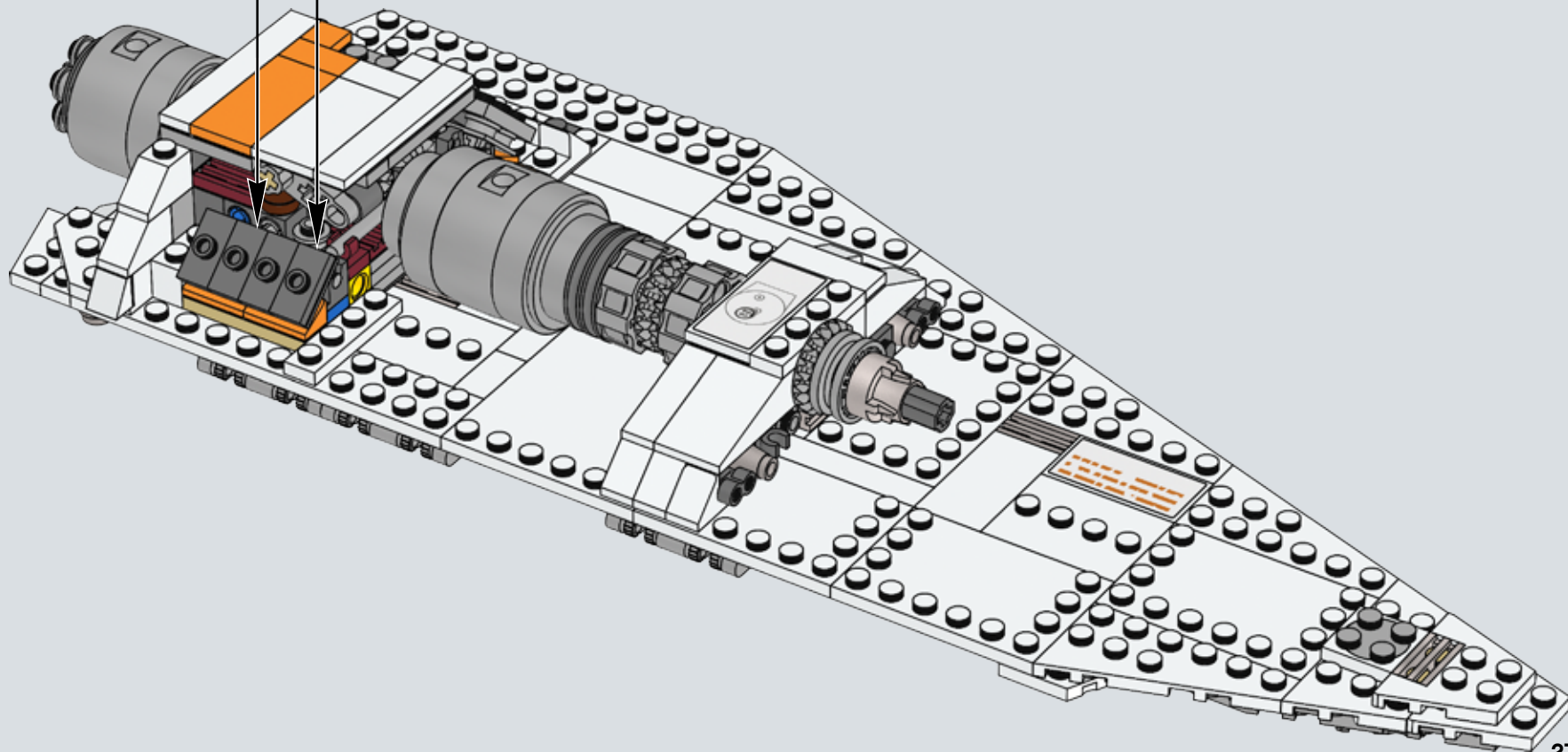
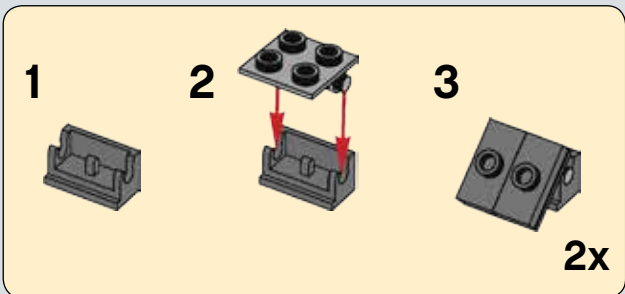

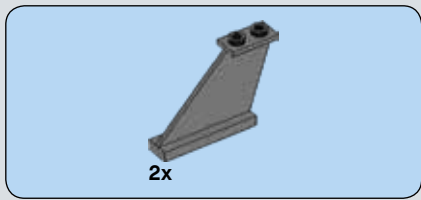

371

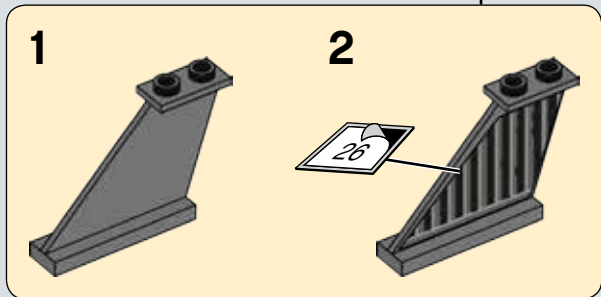
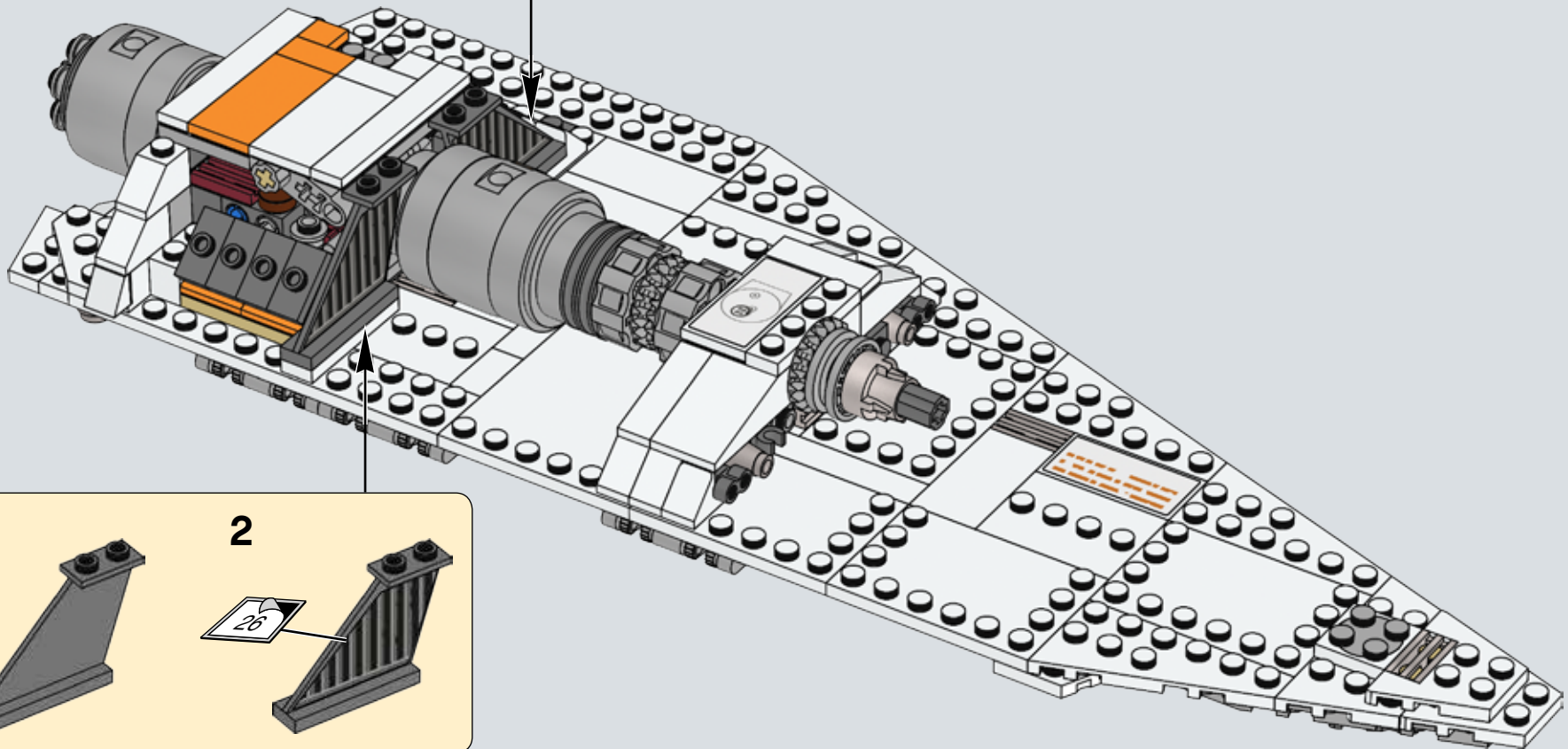
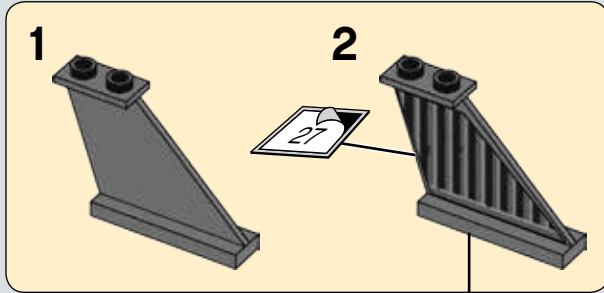



372

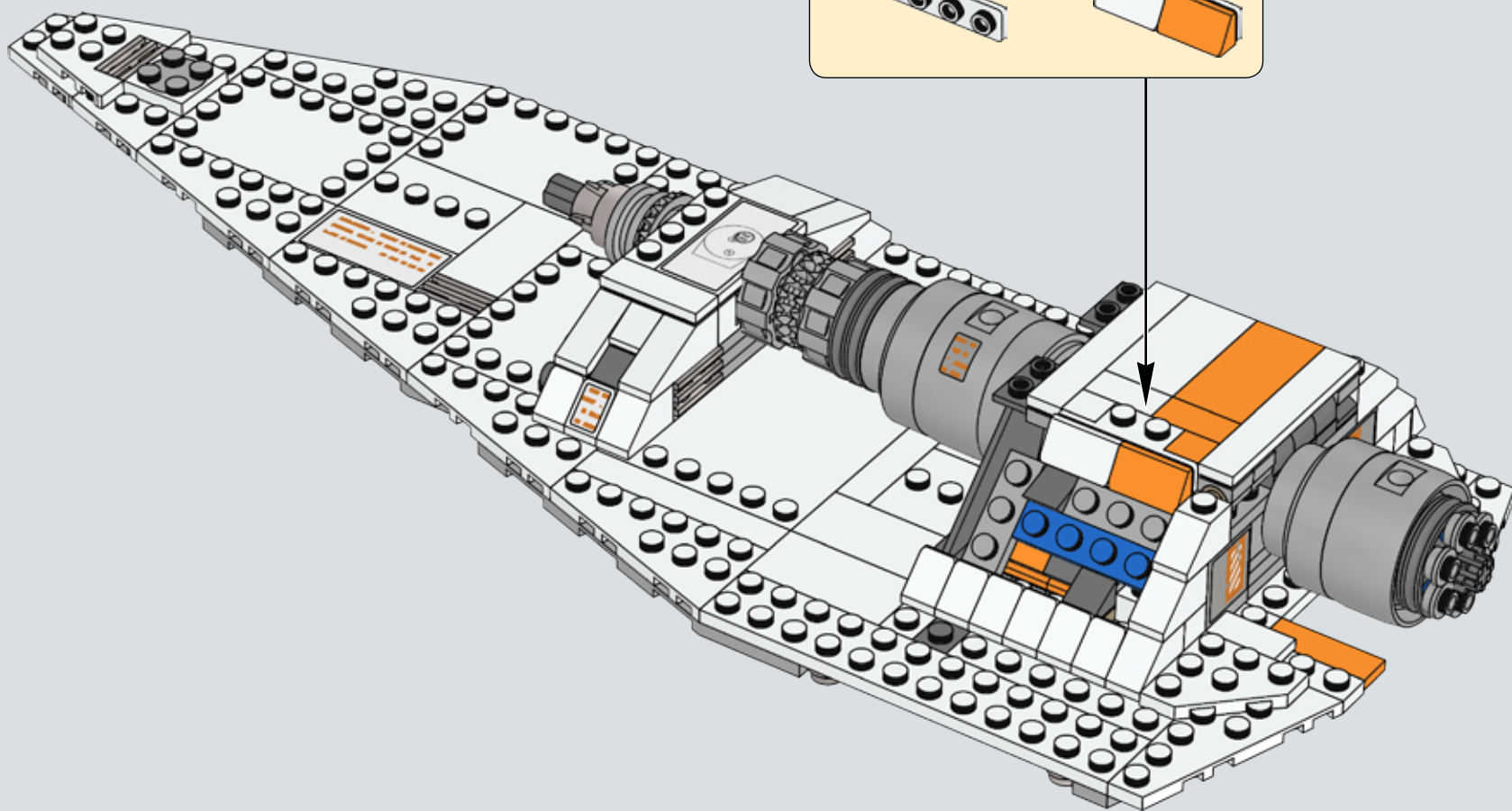
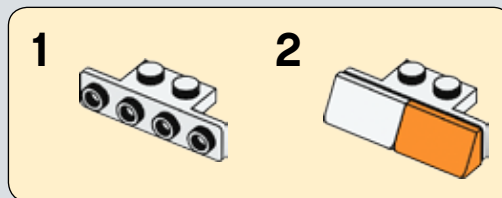
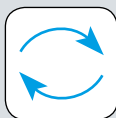

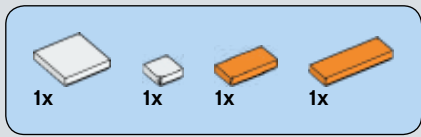

373

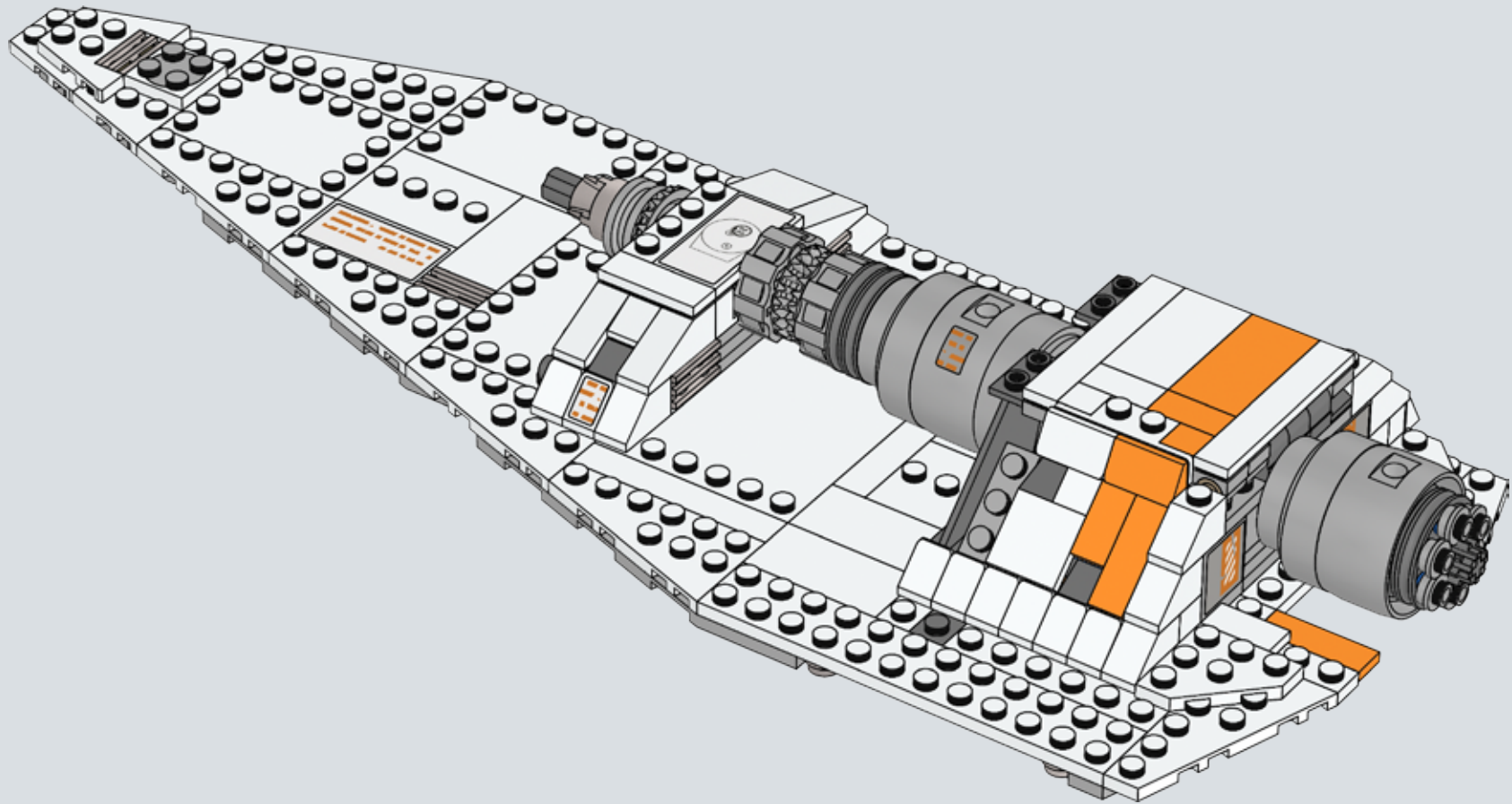

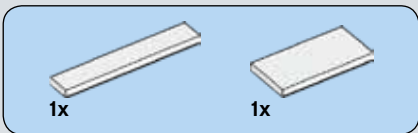

374

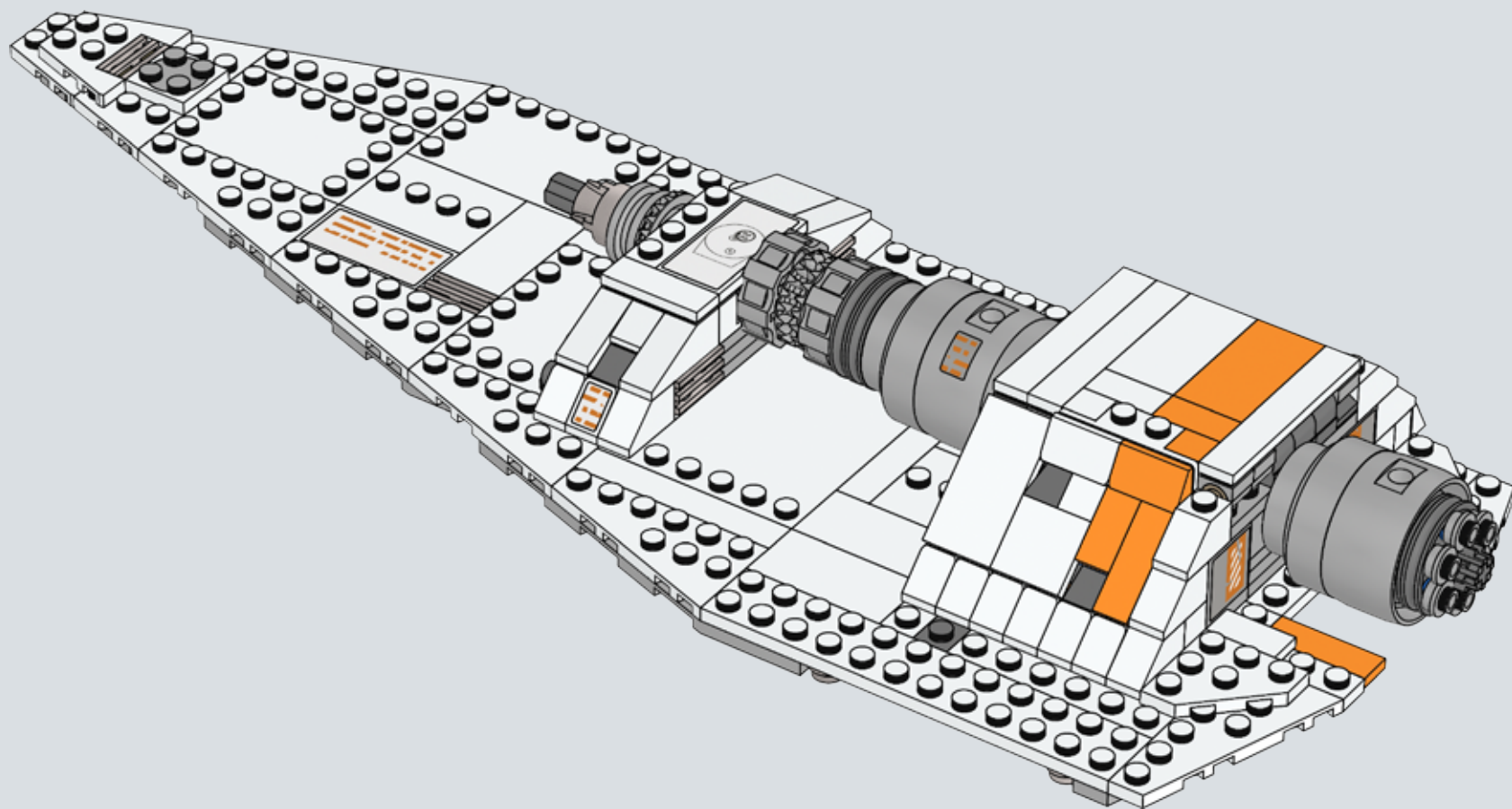



2x



3x

375

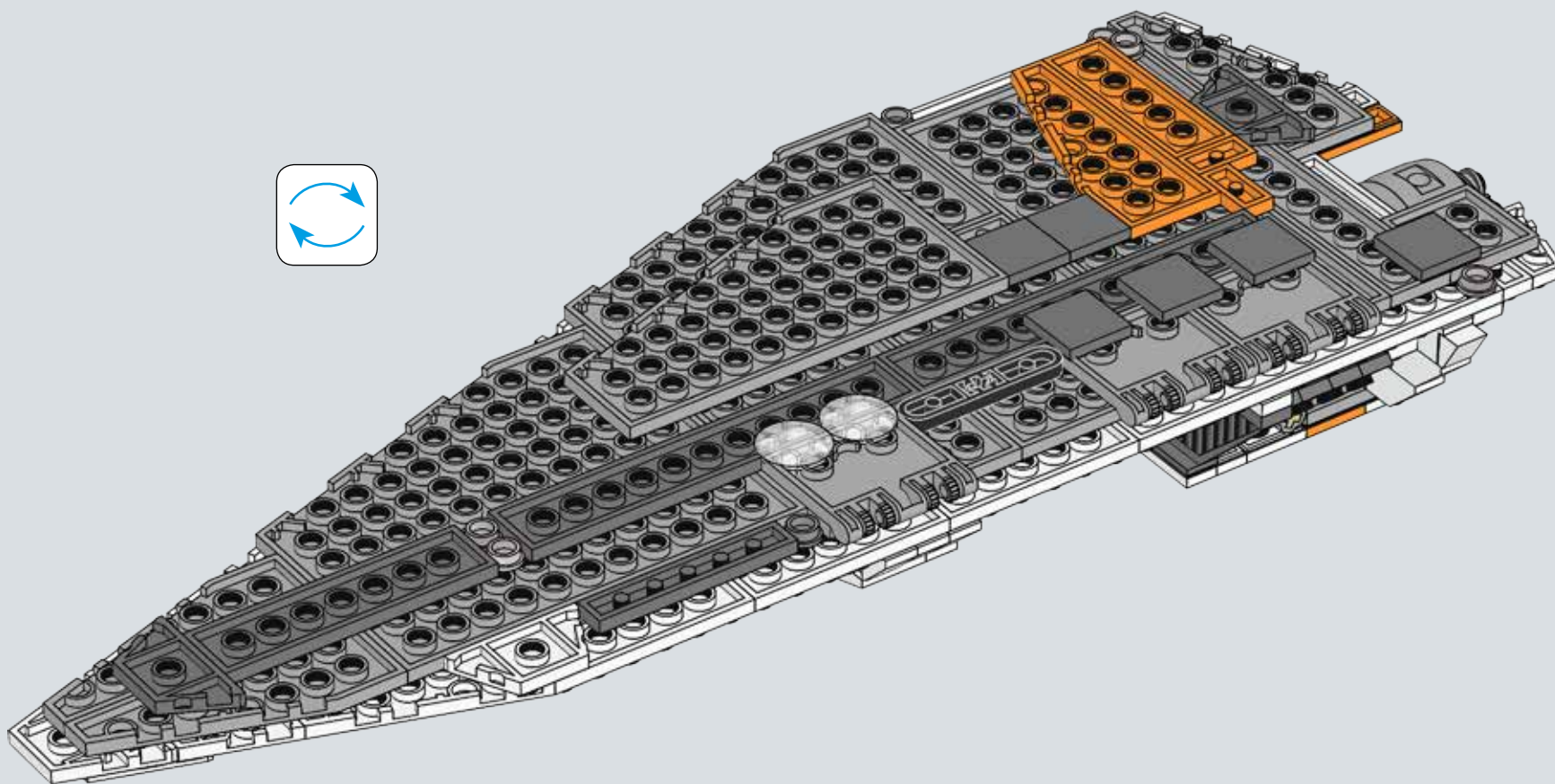
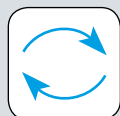

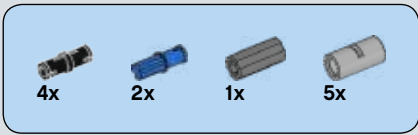

376

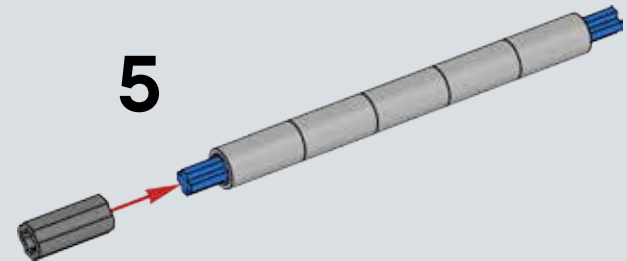
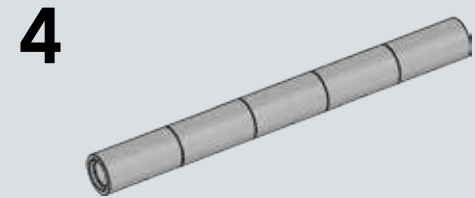
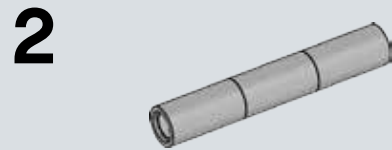
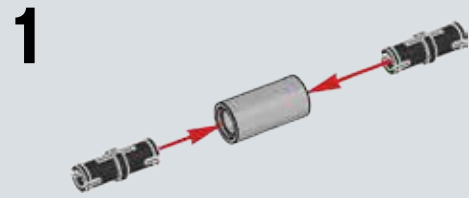

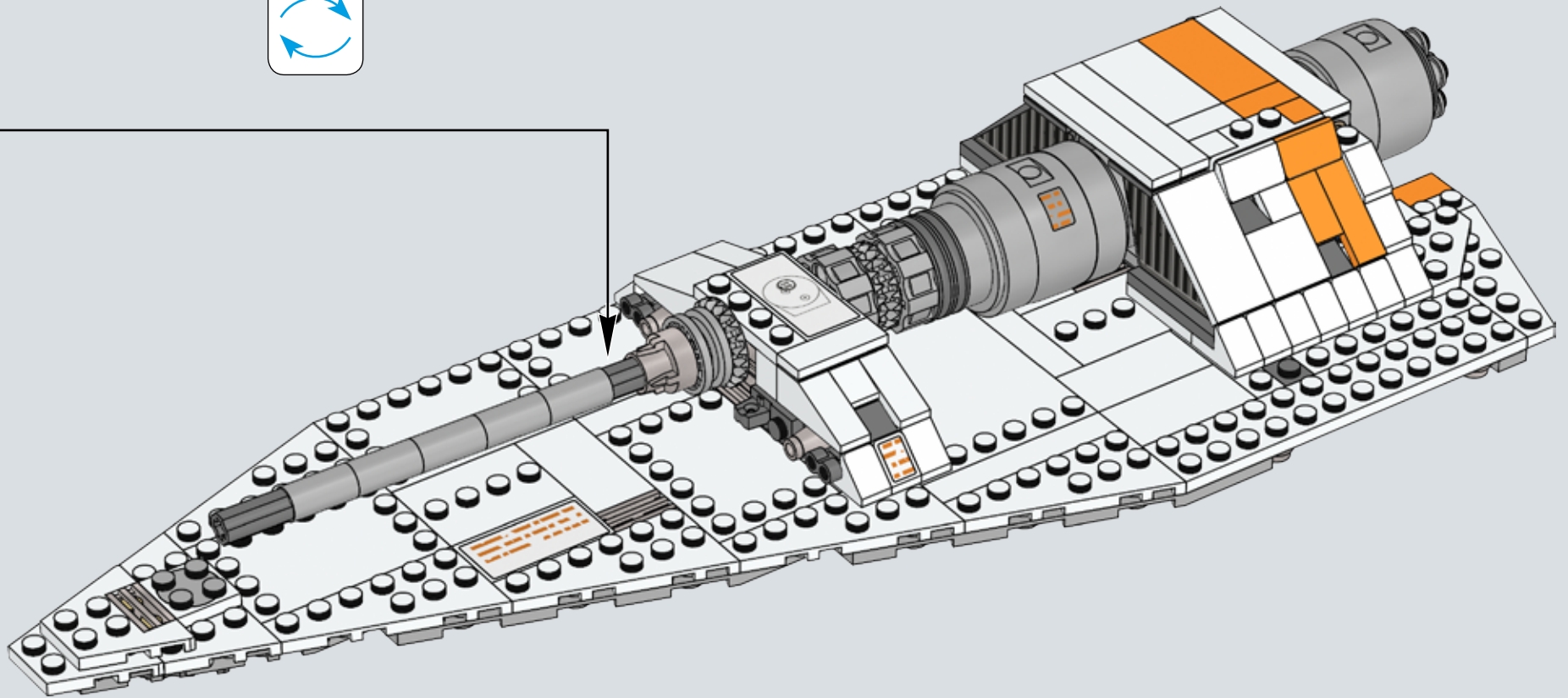
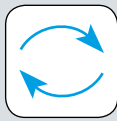

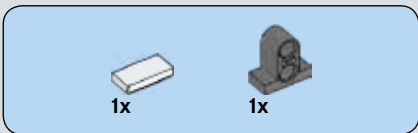

377

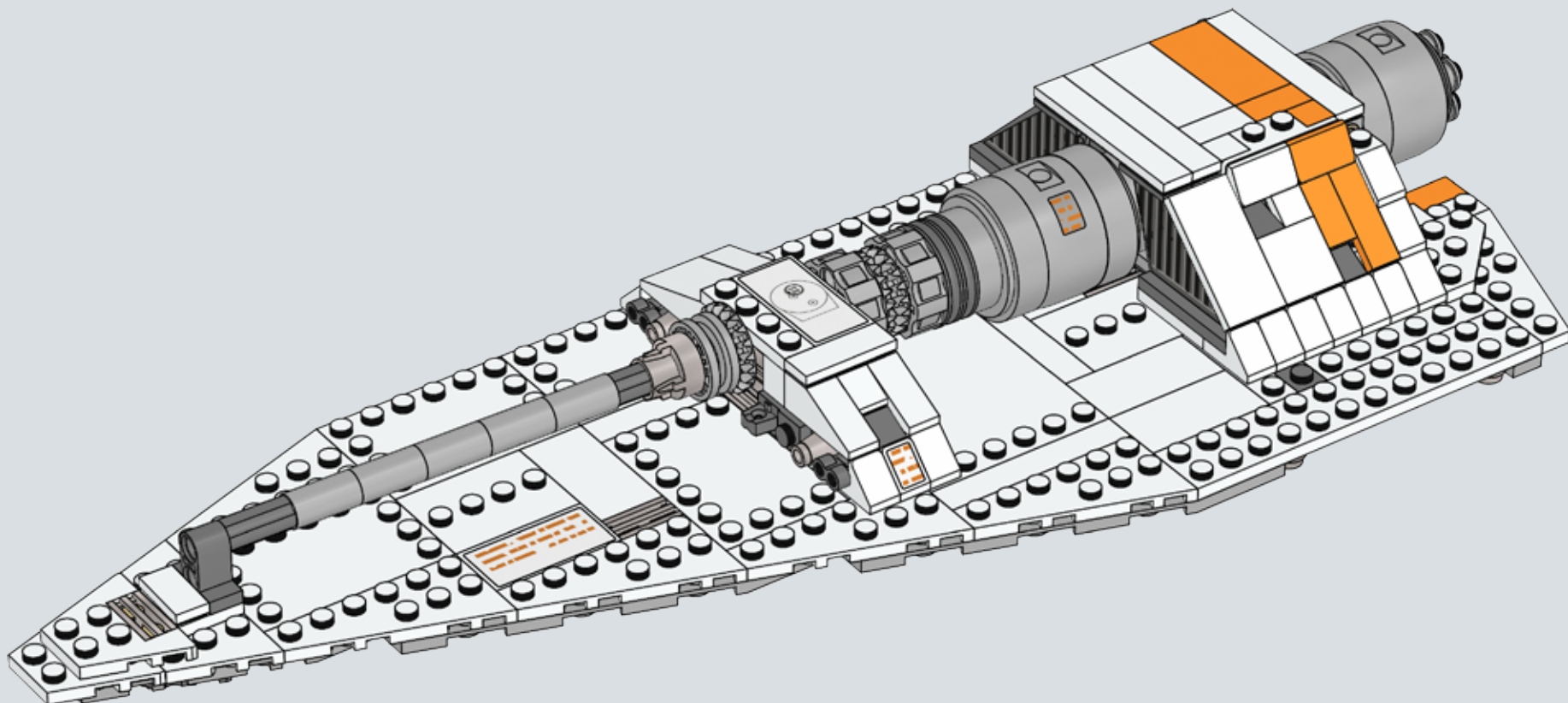

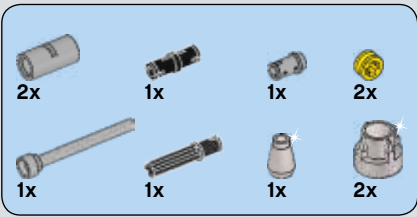

378

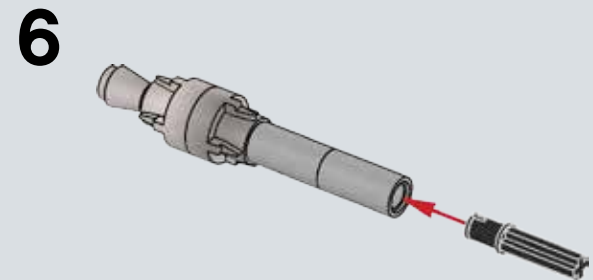
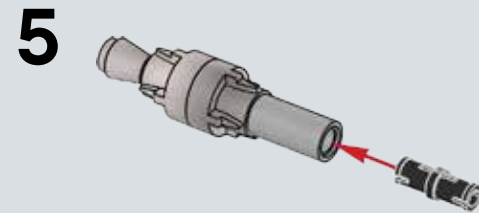
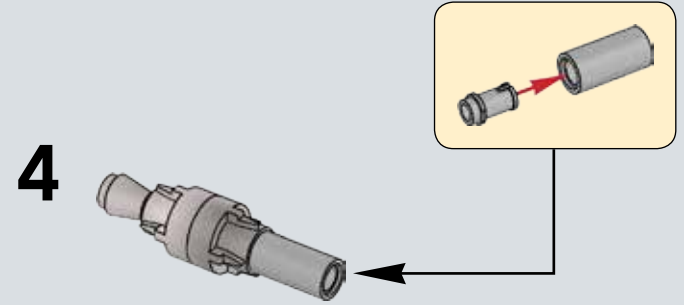
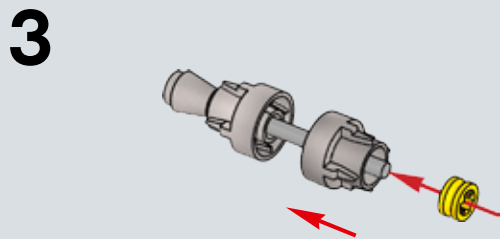
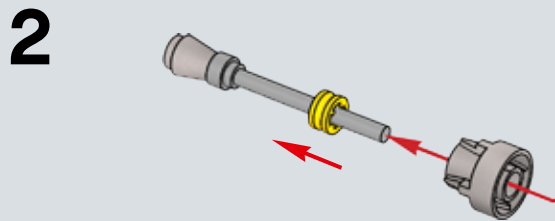
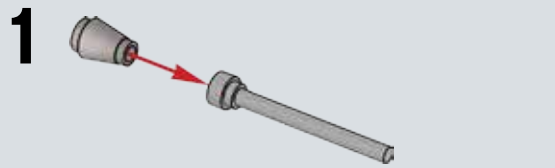

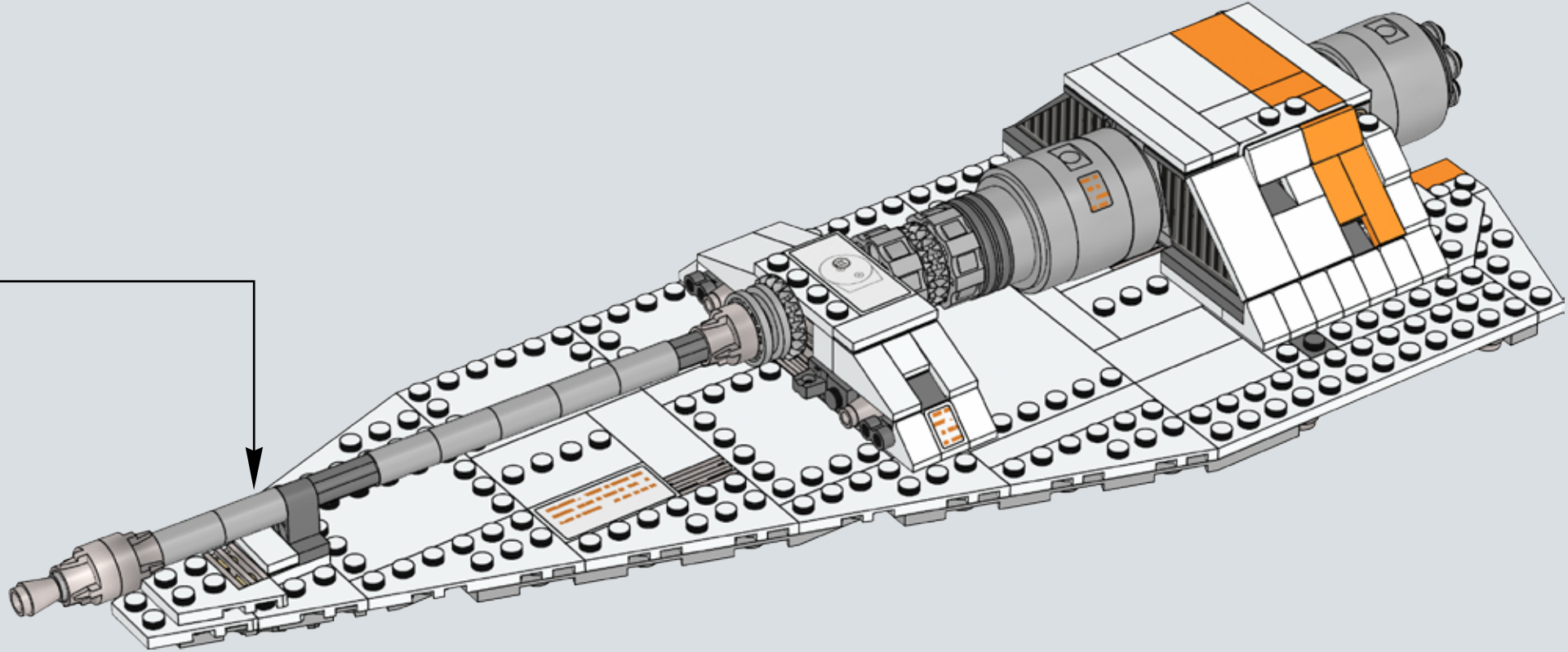

379

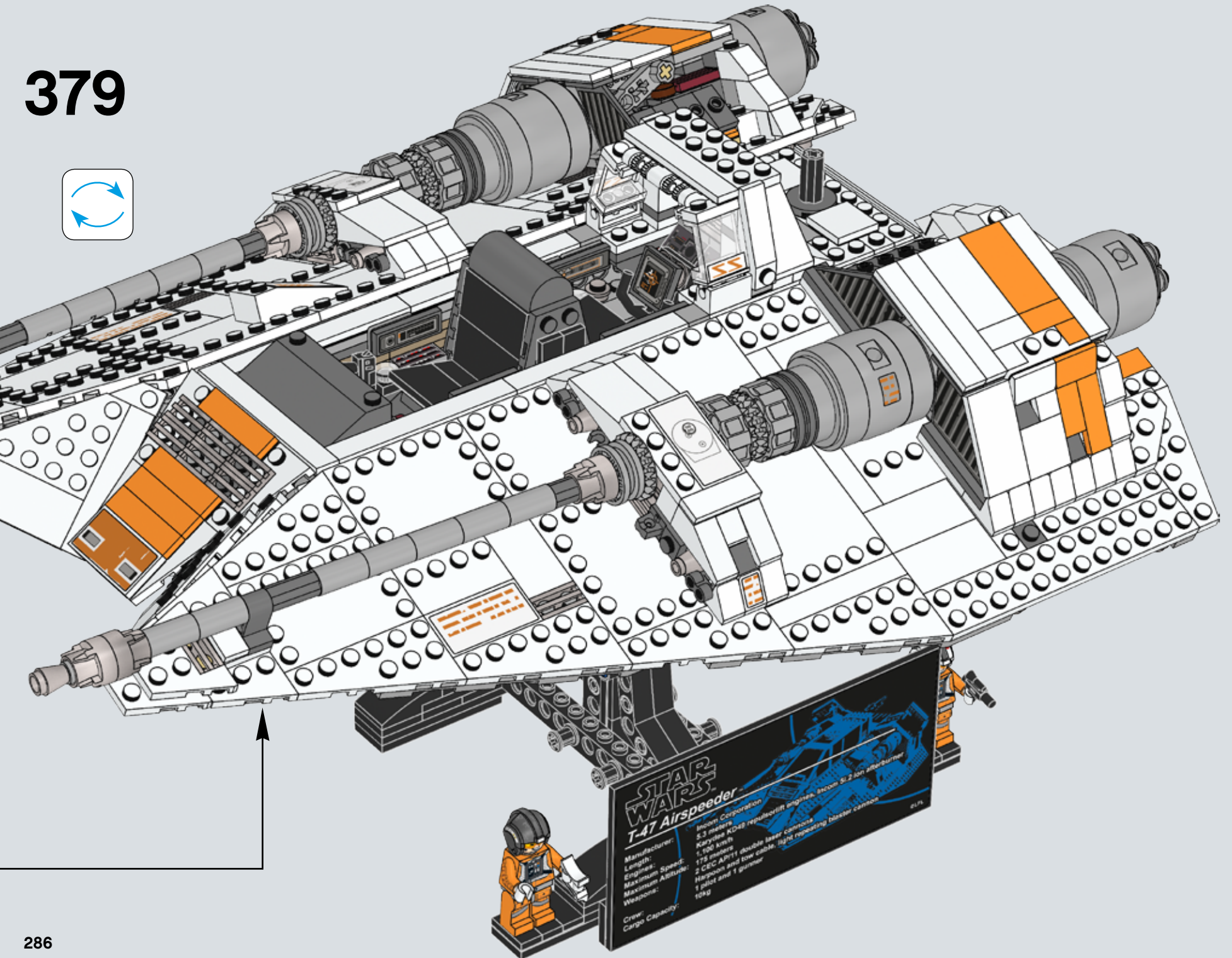
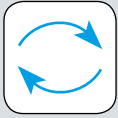

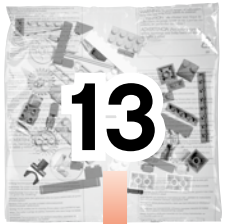

13

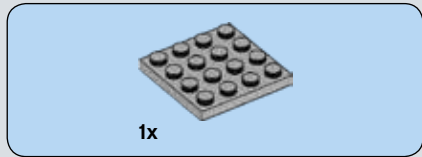
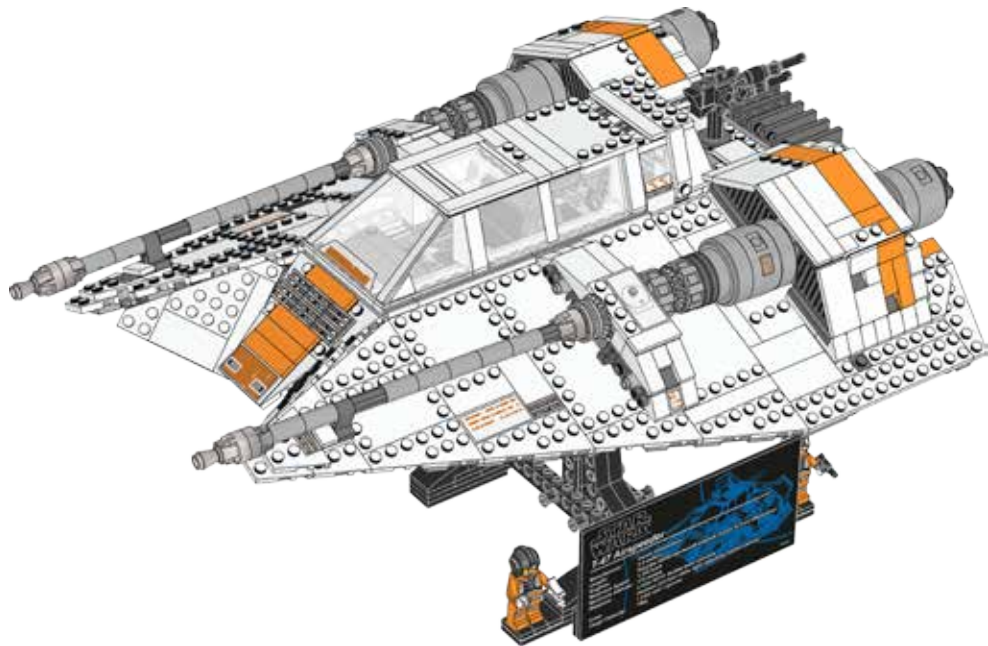

1x

380



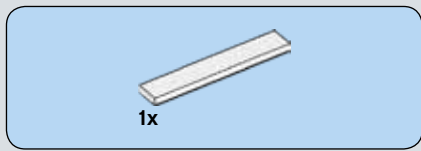

381

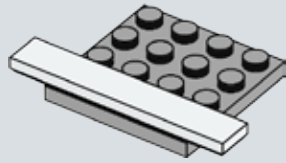

382

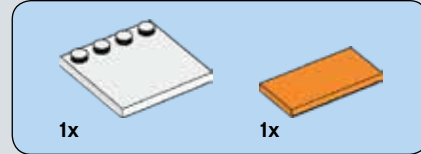
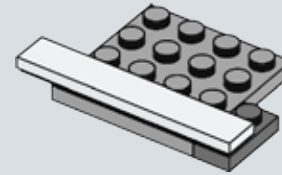

383

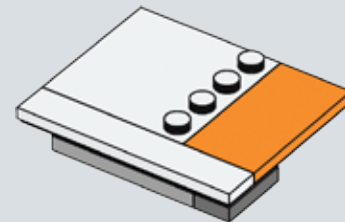

384

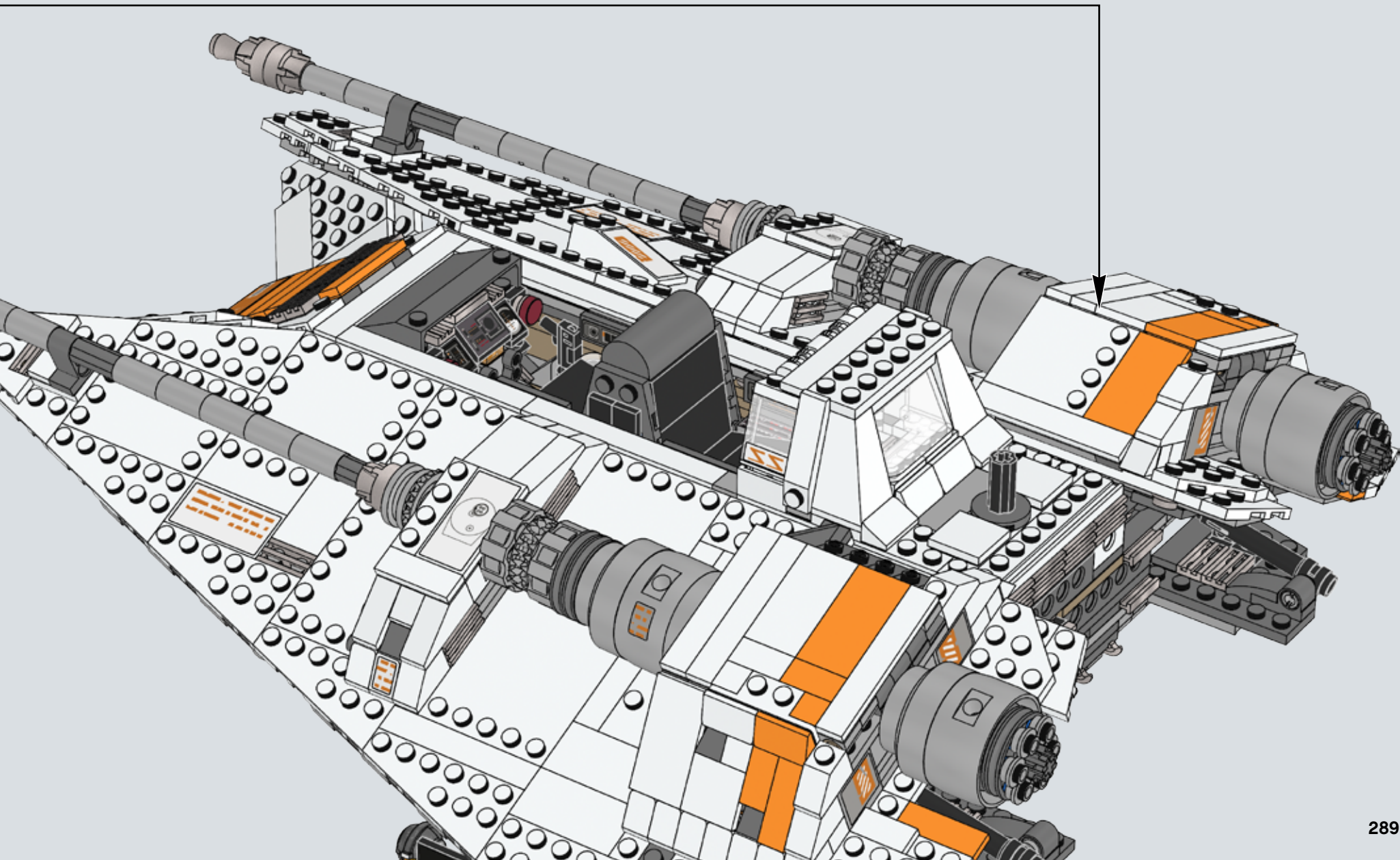

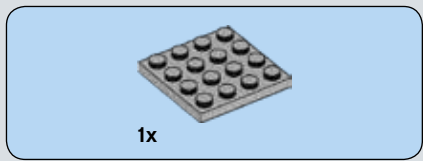

385

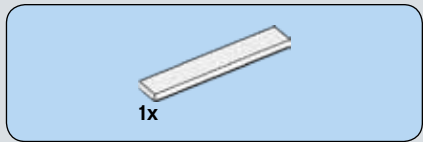

386

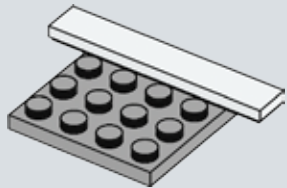

387

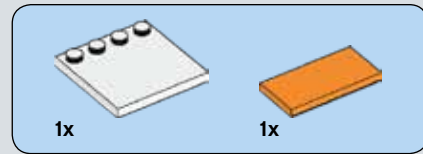
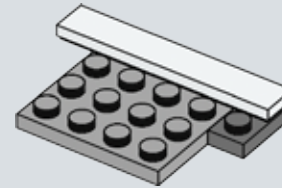

388

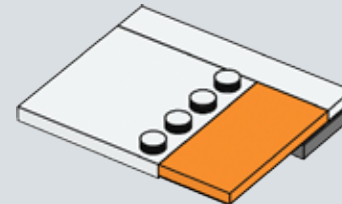

389

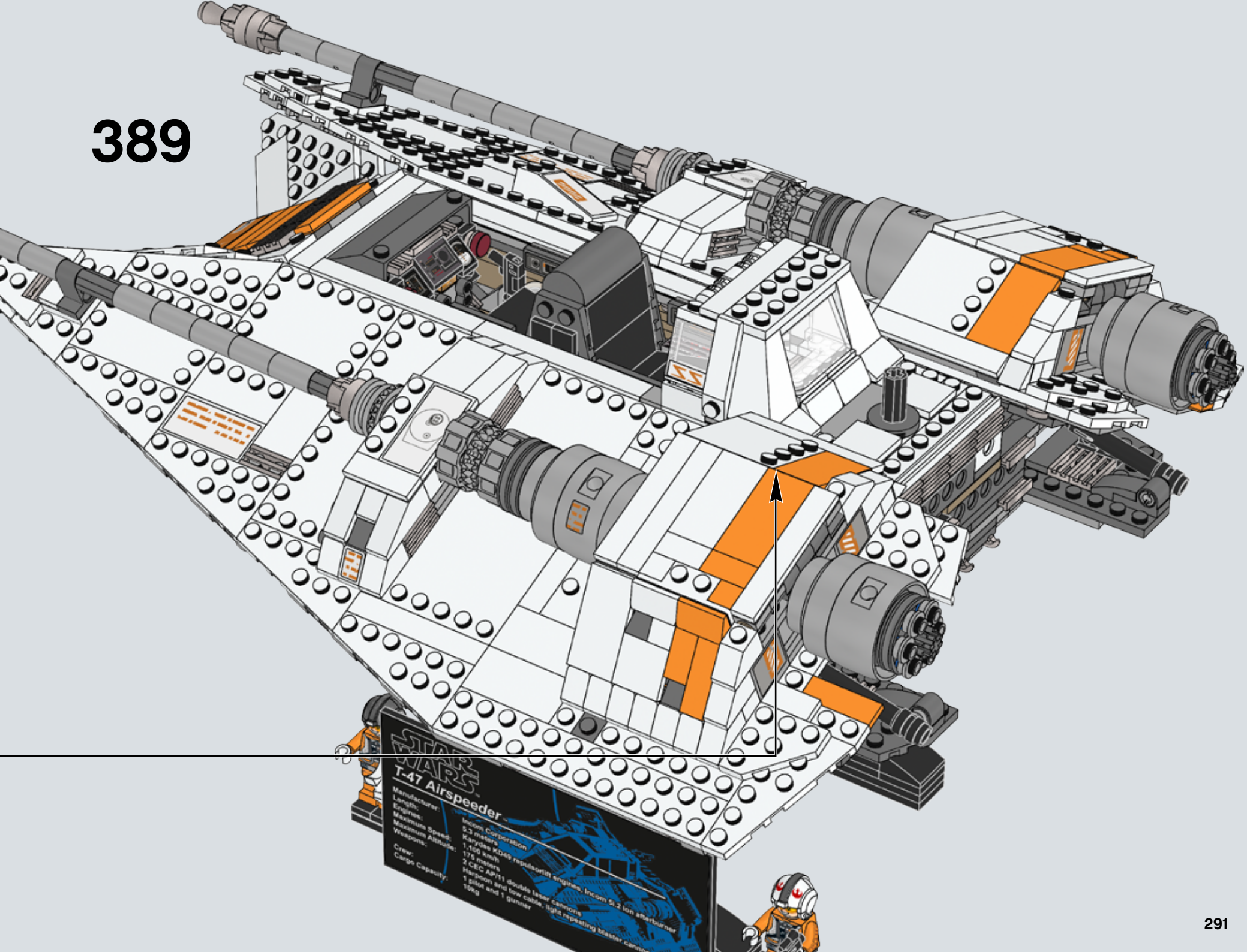

STAR WARS
T-47 Airspeeder

Manufacturer: Incom Corporation
Length: 5.3 meters
Engine: Karydes KD49 repulsorlift engines, Incom S-2 Ion afterburner
Maximum Speed: 1,160 km/h
Maximum Altitude: 175 meters
Weapons: 2 CEC AP-11 double laser cannons, Harrison and low caliber, light repeating blaster cannon

Crew: 1 pilot and 1 gunner
Cargo Capacity: 10kg

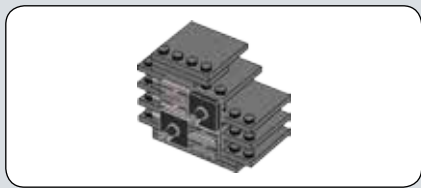

390

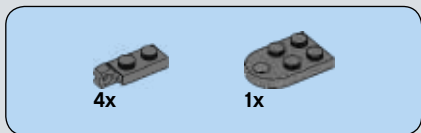
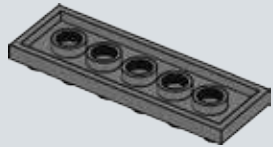

391

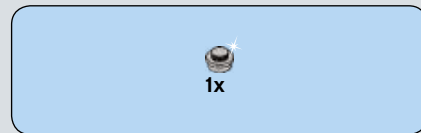
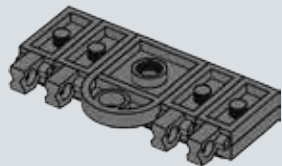

392

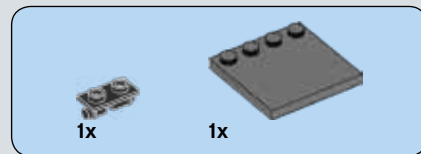
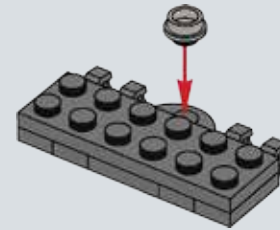
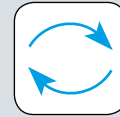

393

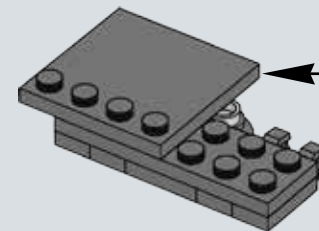
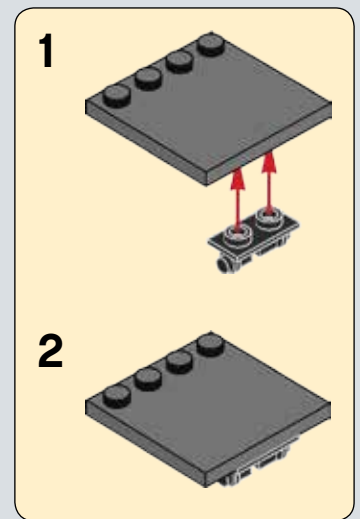

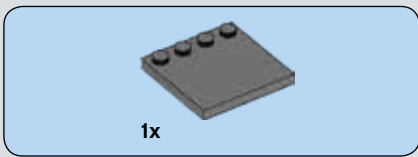

394

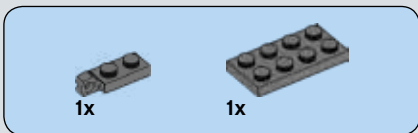
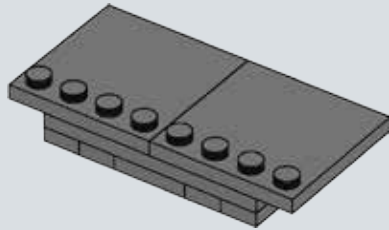

395

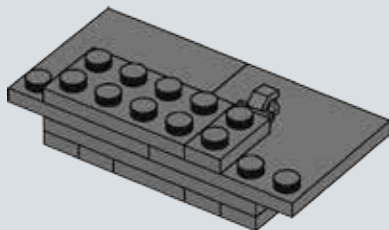

396

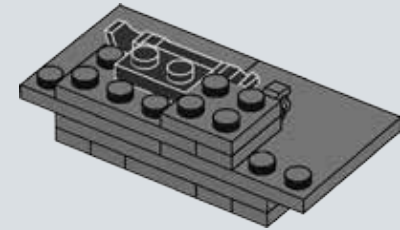

397

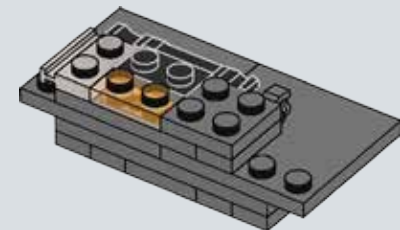

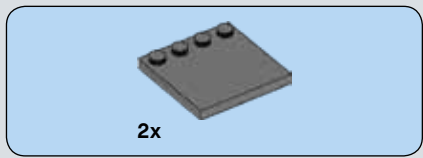

398

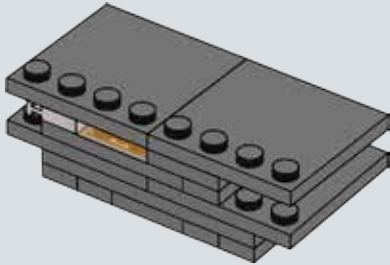

399

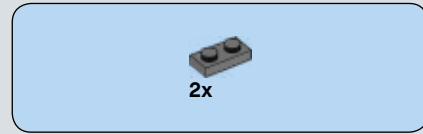
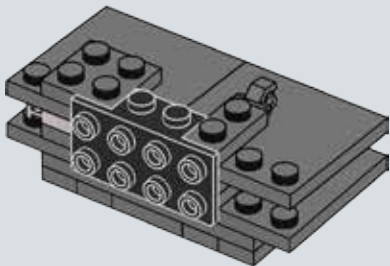

400

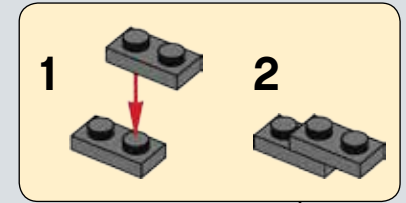
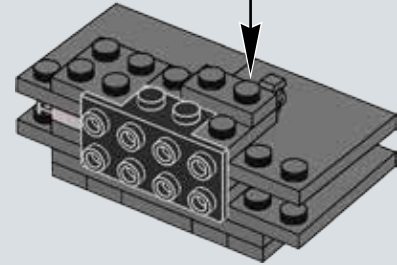

401

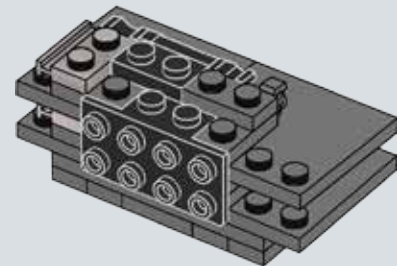



2x

402

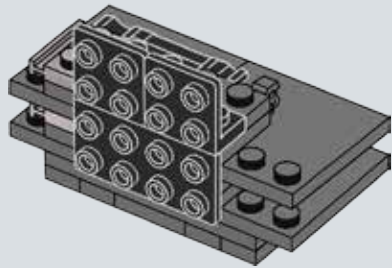

2x

403

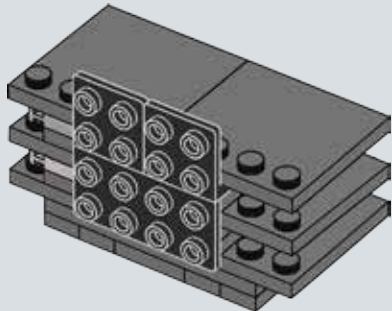

1x

404

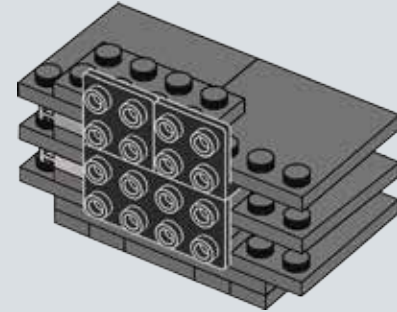

1x



2x



2x

405

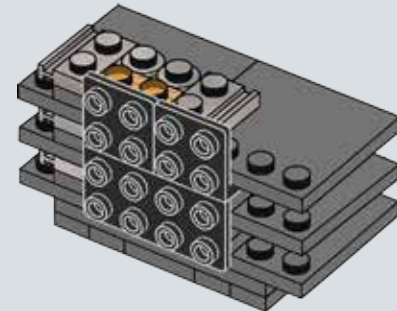

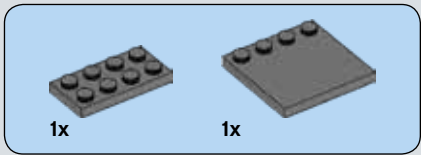

406

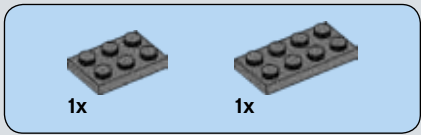
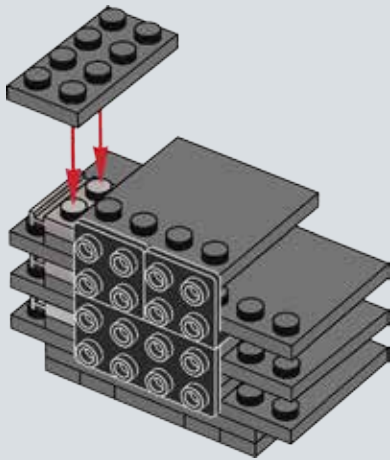

407

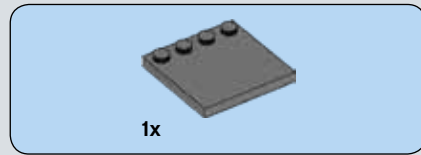
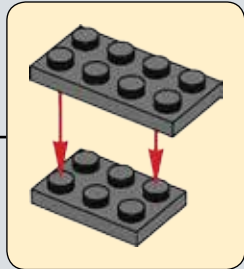
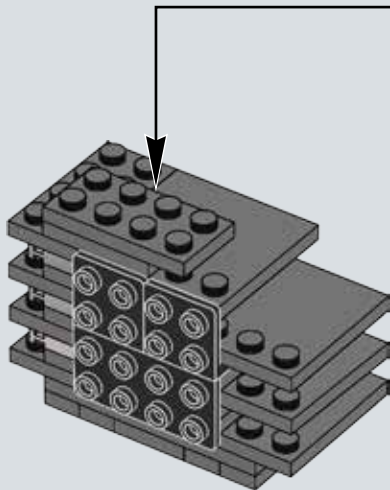

408

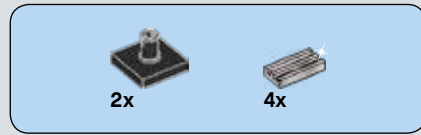
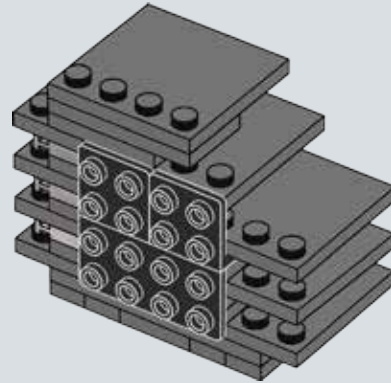

409

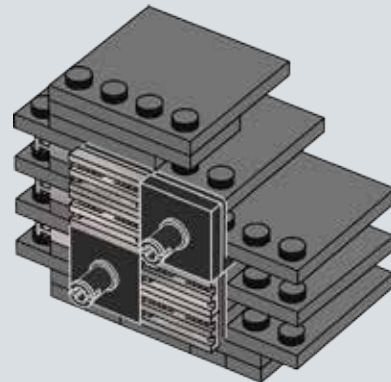

410

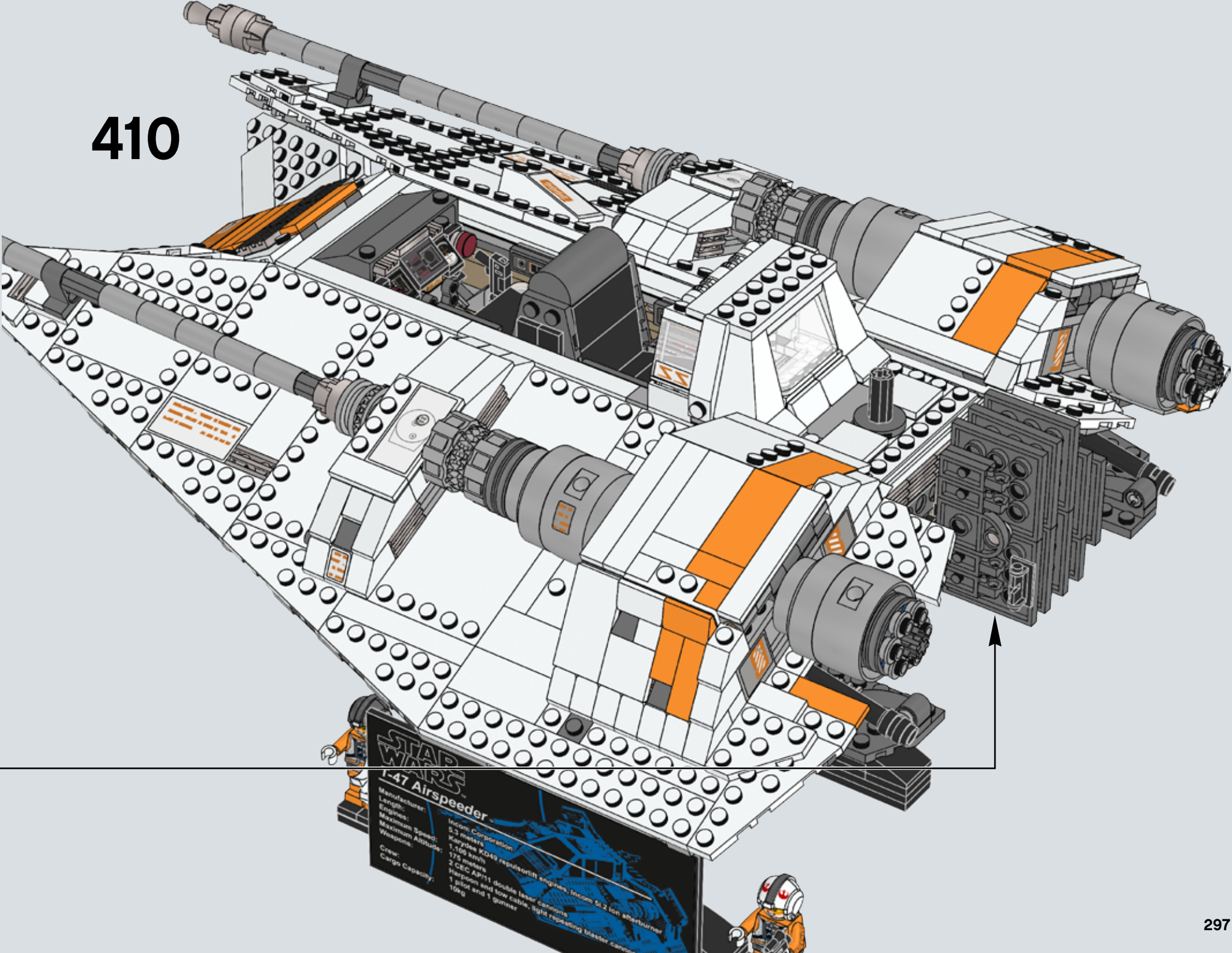

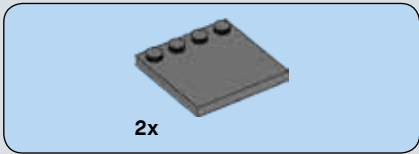
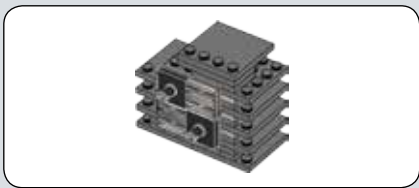

411

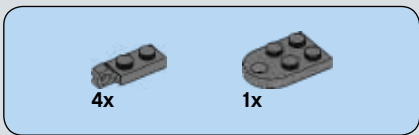
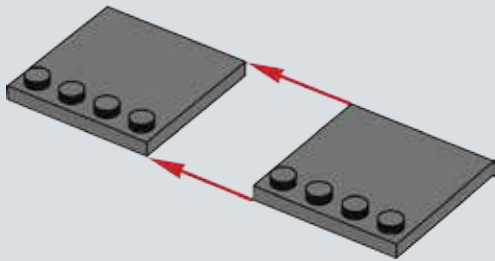

412

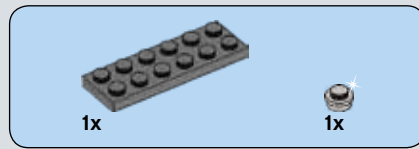
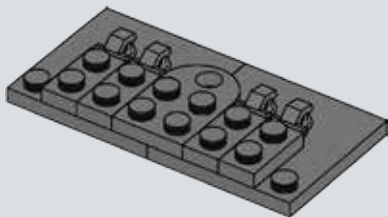

413

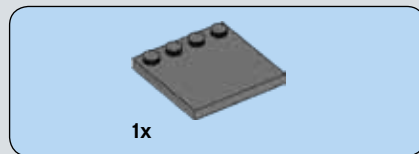
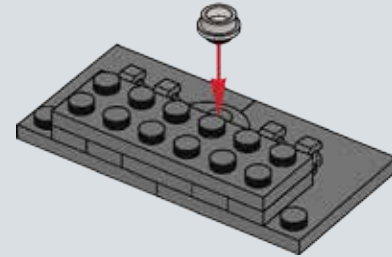

414

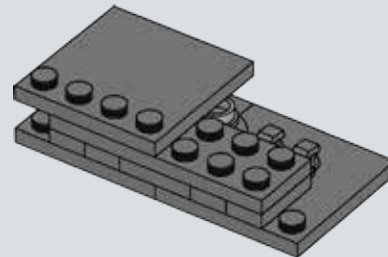

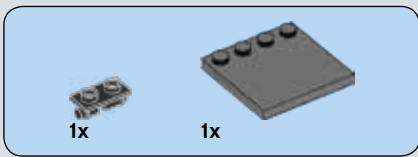

415

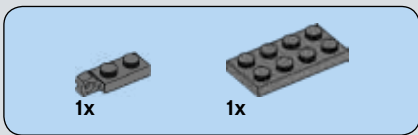
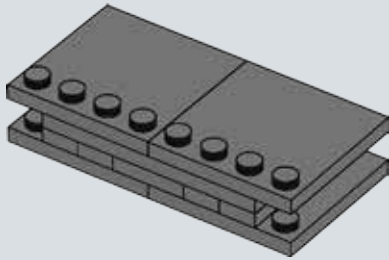
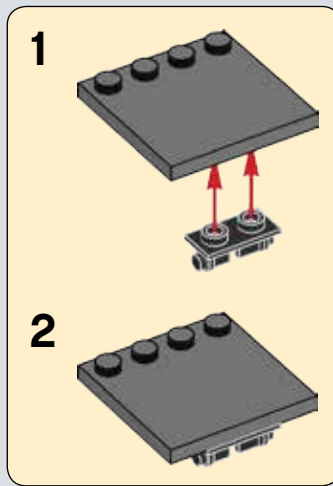

416

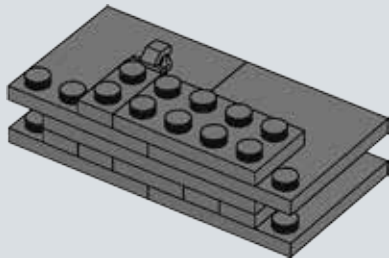

417

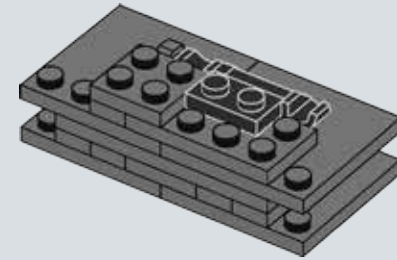

418

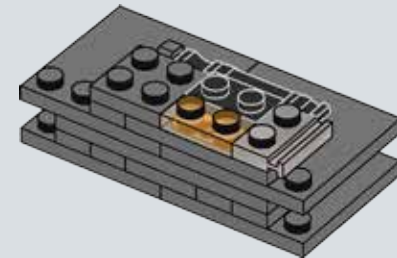

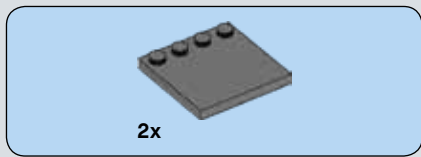

419

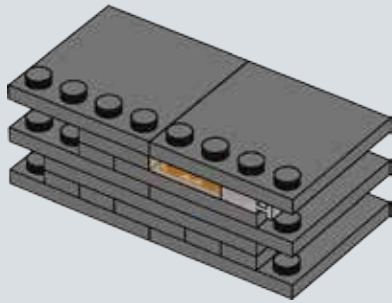

420

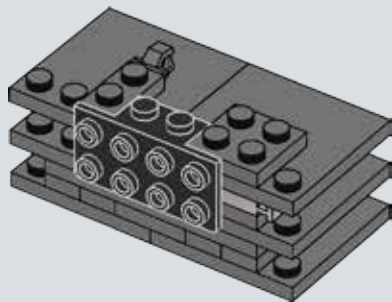

421

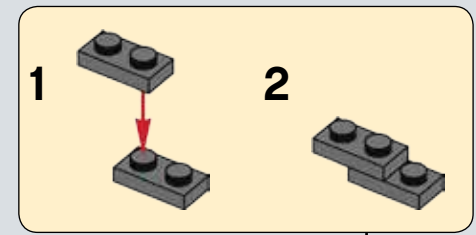
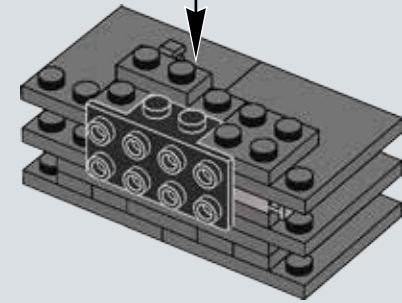

422

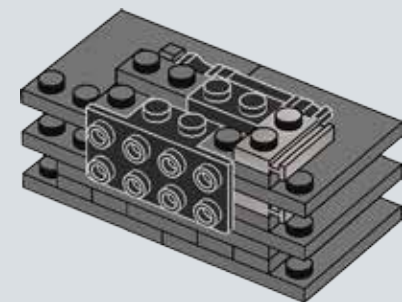



2x

423

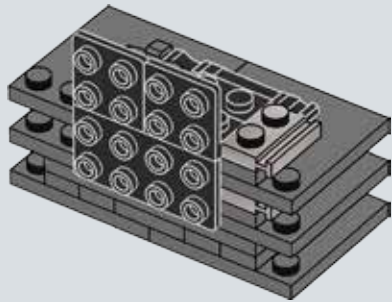

2x

424

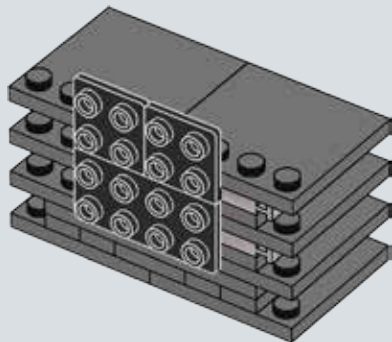

1x

425

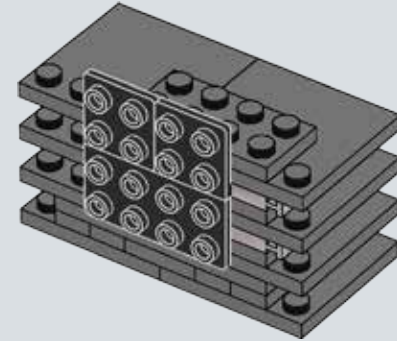

1x



2x



2x

426

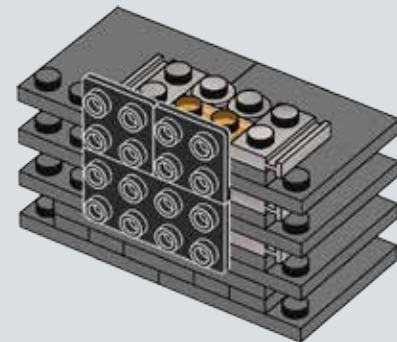

431

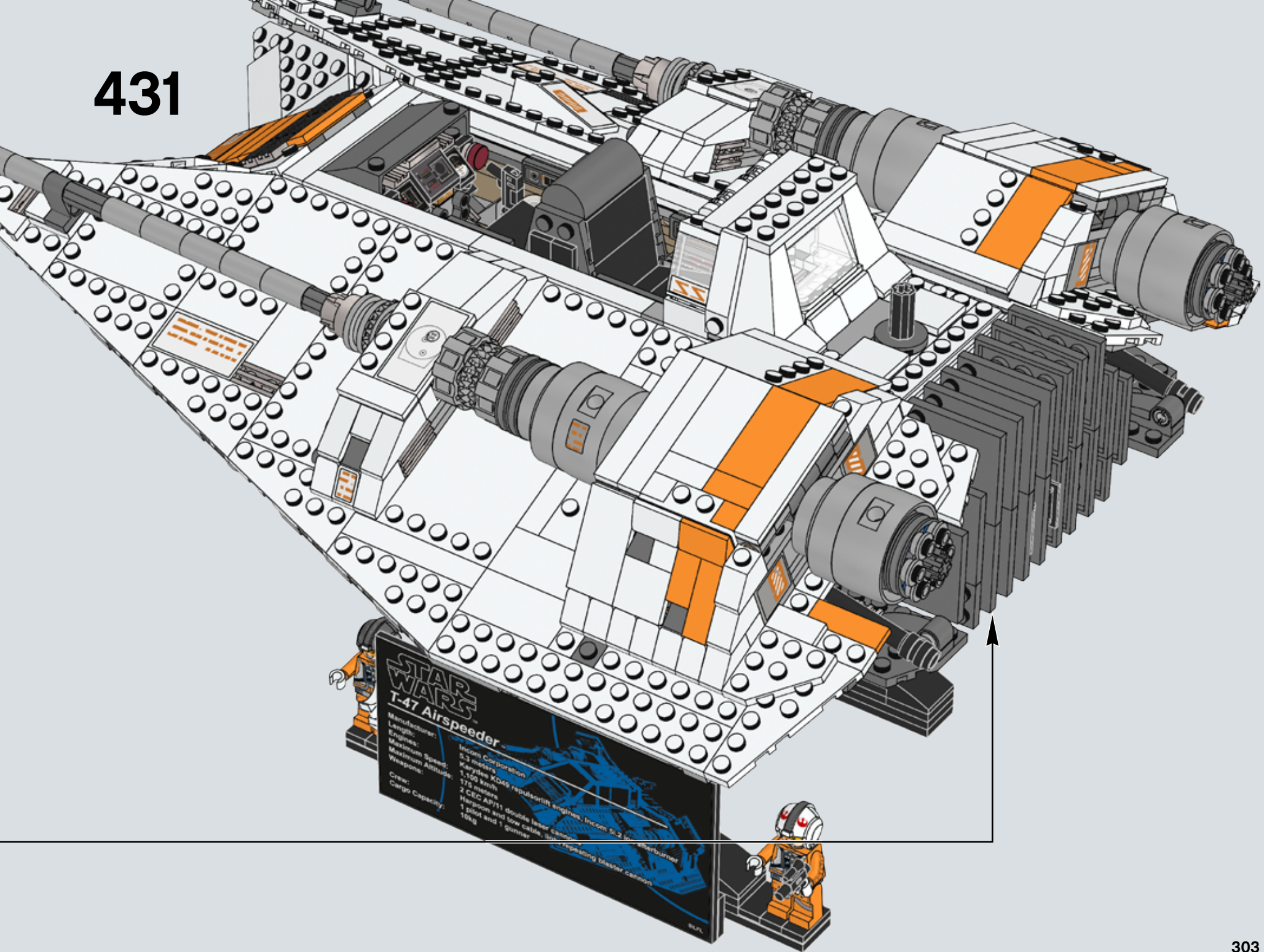

STAR WARS
T-47 Airspeeder

Manufacturer: Incom Corporation
Length: 5.3 meters
Engines: Karydes KD45 repulsorlift engines, Incom S-2 turbo-laserburner
Maximum Speed: 1,101 km/h
Maximum Altitude: 175 meters
Weapons: 2 CEC AP131 double laser cannons, Incom S-2 turbo-laserburner, repeating blaster cannon

Crew: 1 pilot and 1 gunner
Cargo Capacity: 10kg



432



433

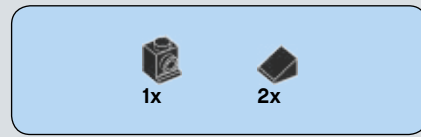
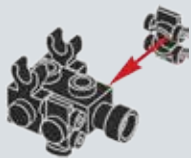

434

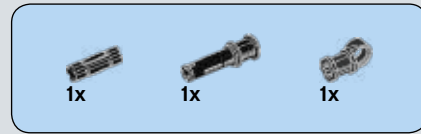
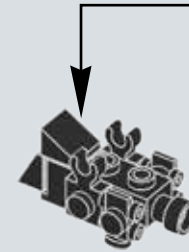
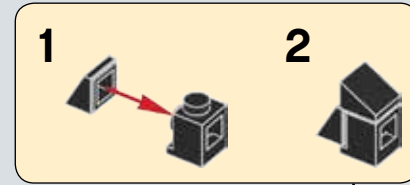

435

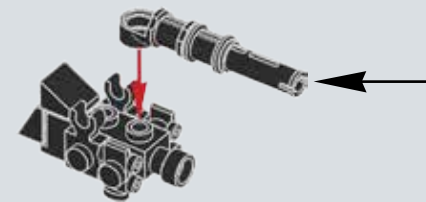



1x

436

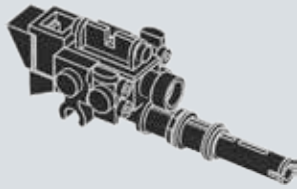
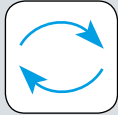

1x



1x



1x

437

1



2



1x

438

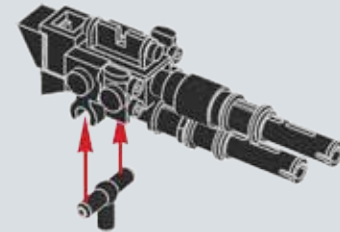

439

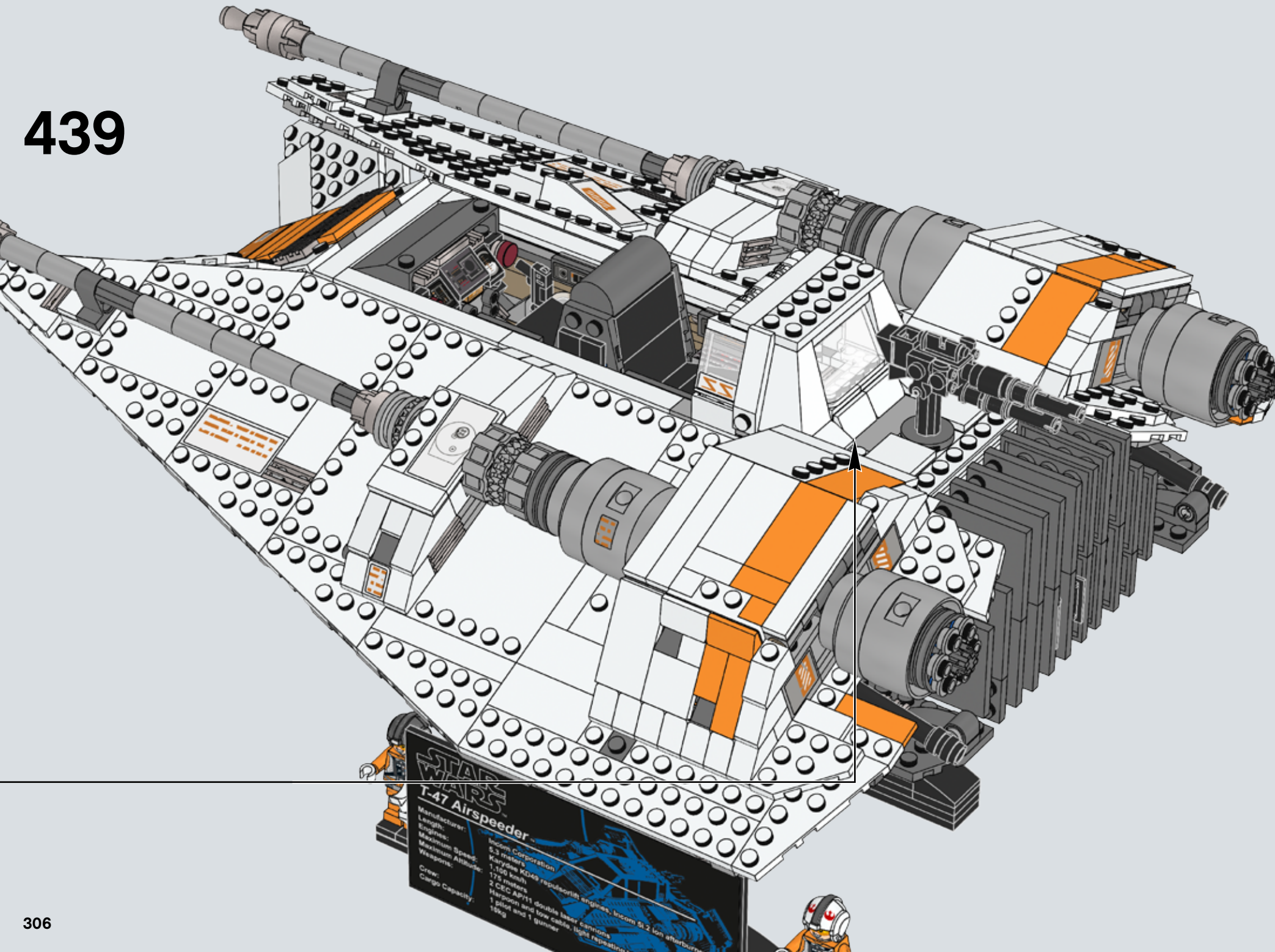

STAR WARS
T-47 Airspeeder

Manufacturer:	Incom Corporation
Length:	5.3 meters
Engines:	Karysae KD69 repulsorlift engines, Incom SL2 ion afterburner
Maximum Speed:	1,100 km/h
Maximum Altitude:	175 meters
Weapons:	2 CEC A8/11 double laser cannons Harpoon and low caliber, light repeating blaster
Crew:	1 pilot and 1 gunner
Cargo Capacity:	15kg

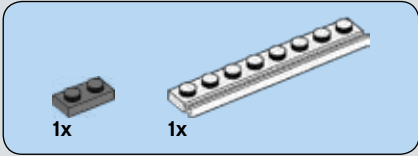
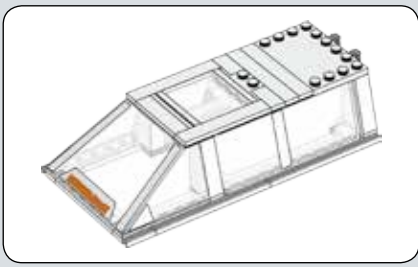

440

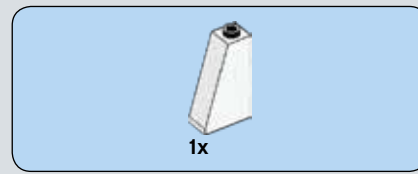
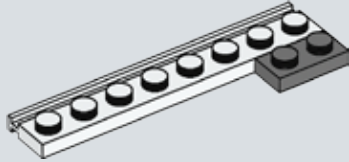

441

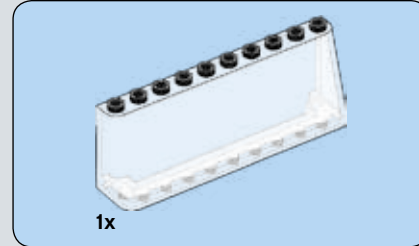
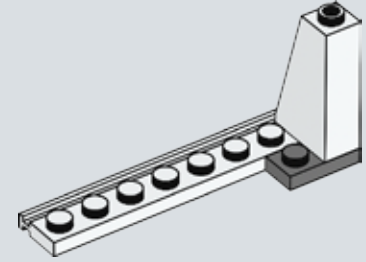

442

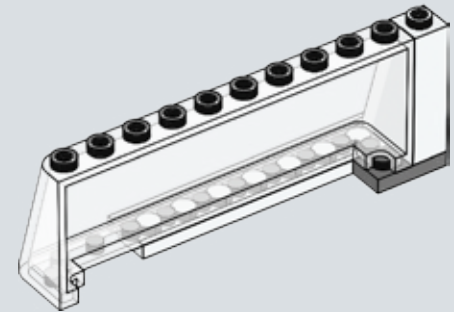

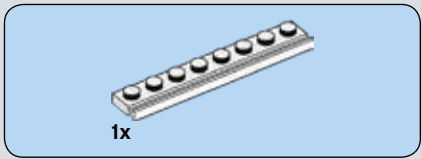

443

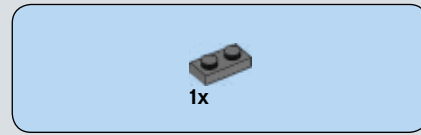
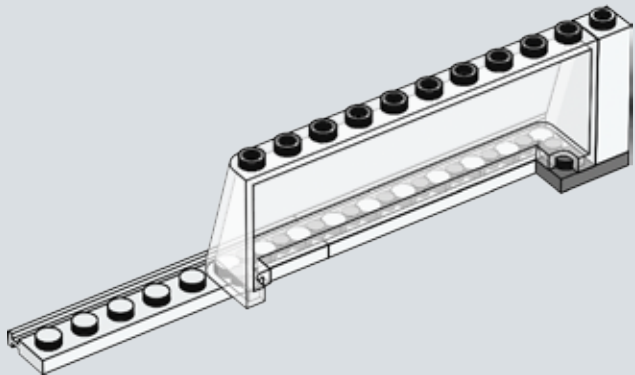

444

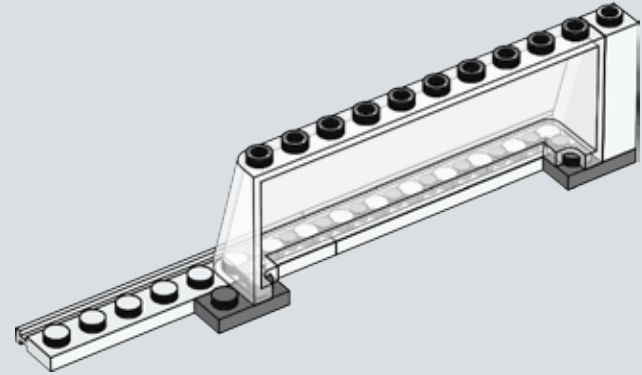

445

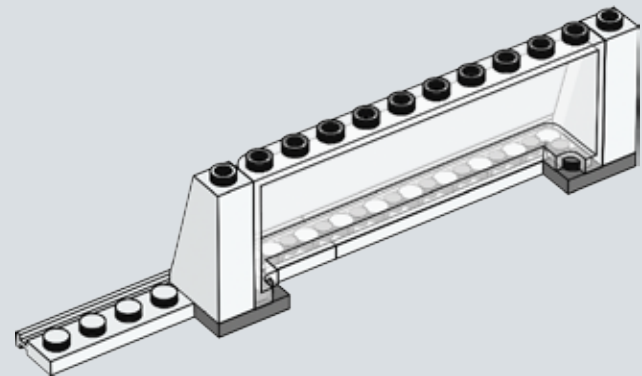

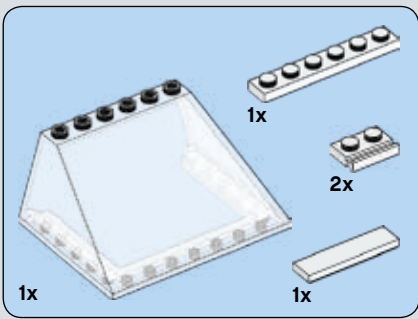

446

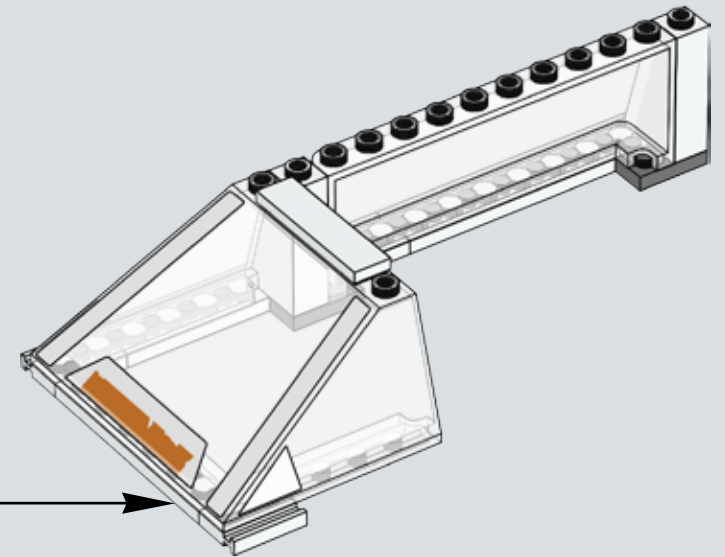
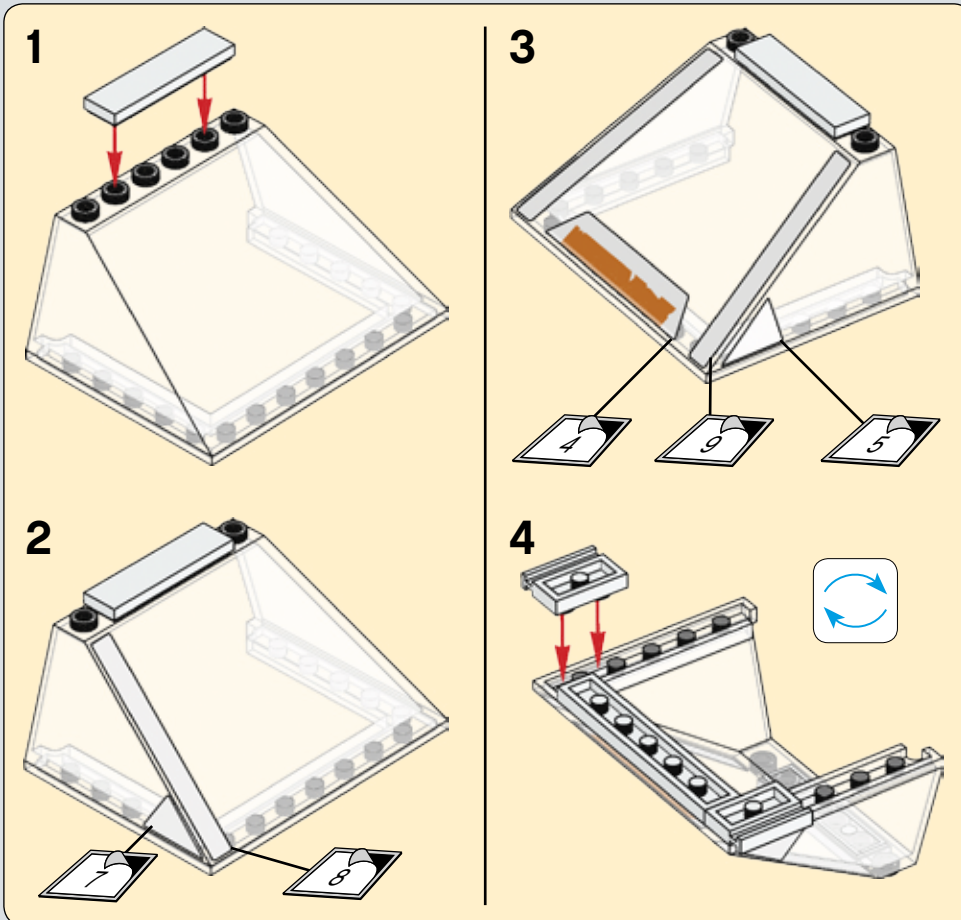

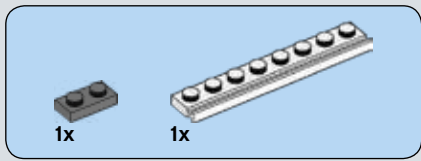

447

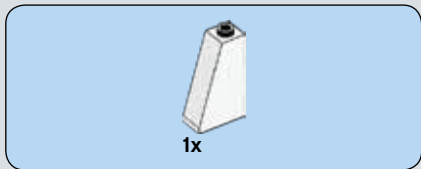
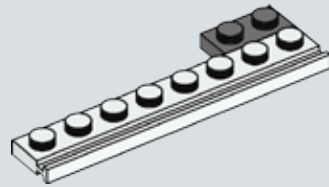

448

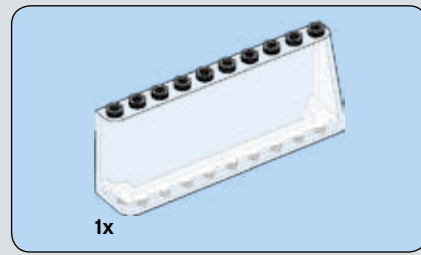
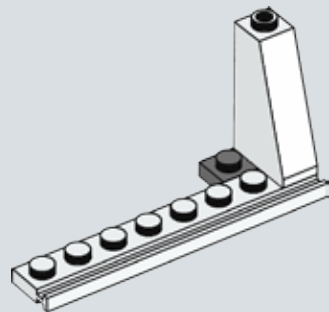

449

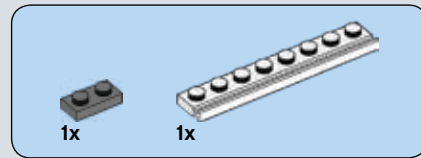
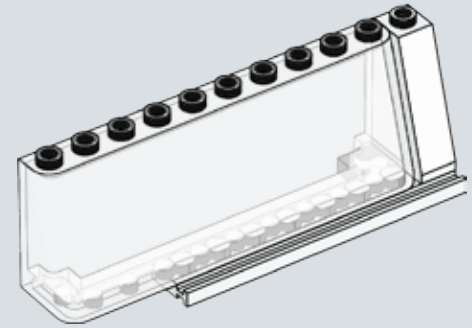

450

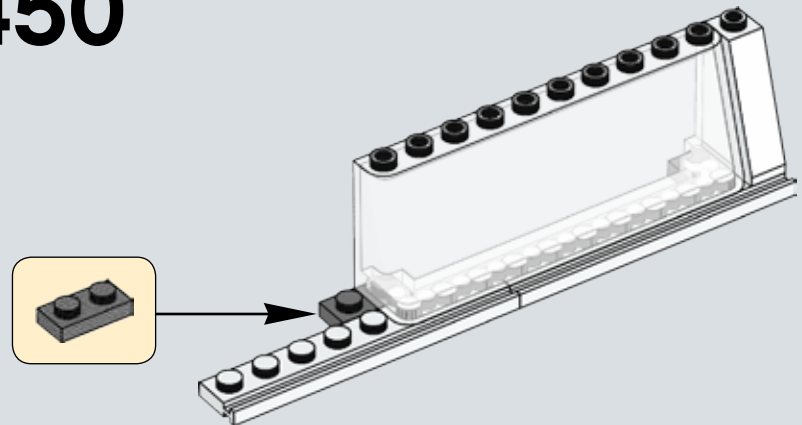

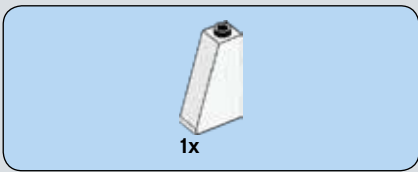

451

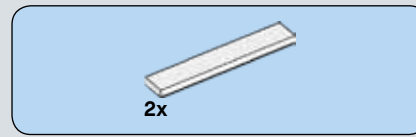
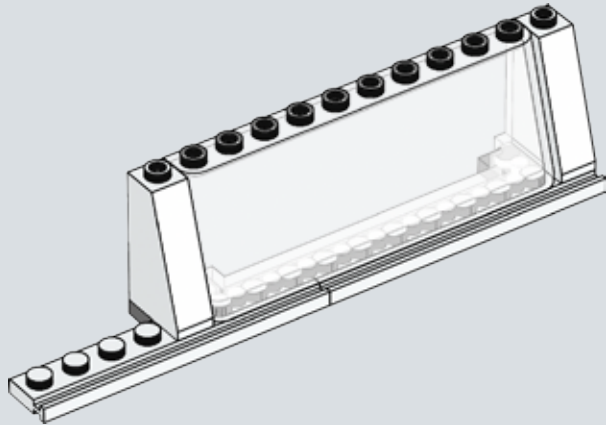

453

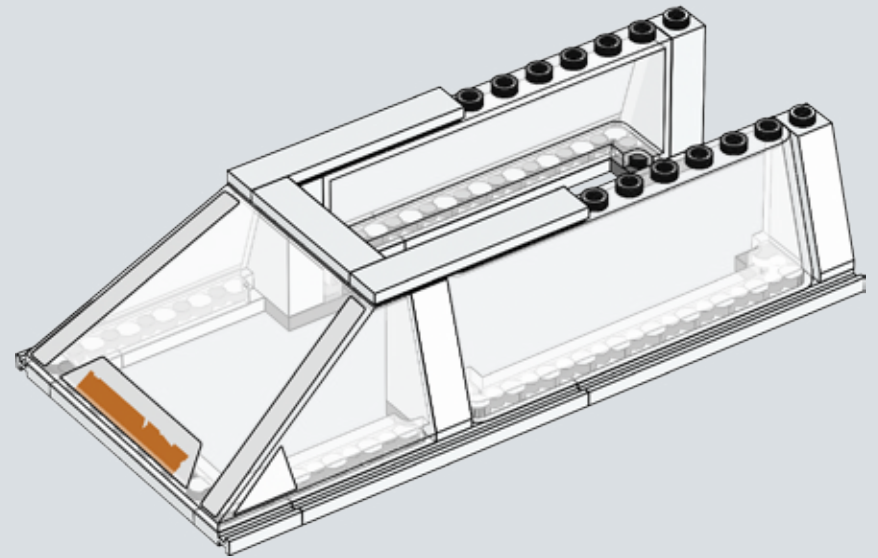

452

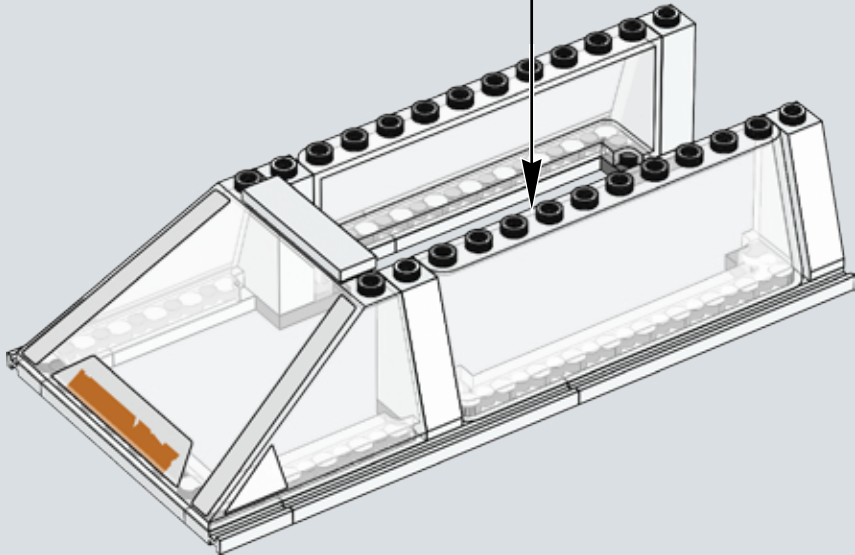

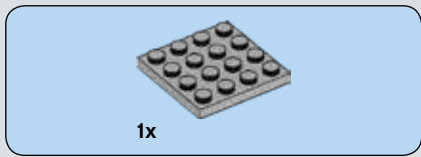

454

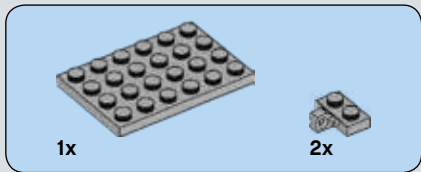

455

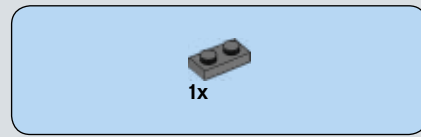
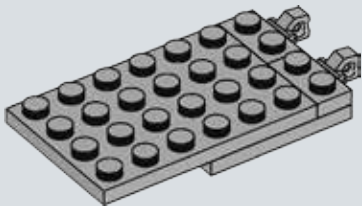

456

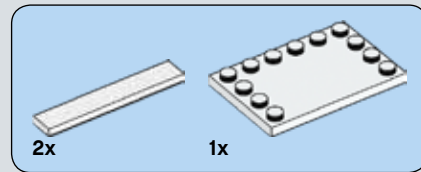
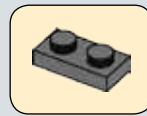
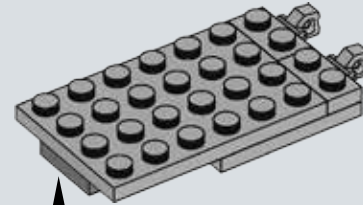

457

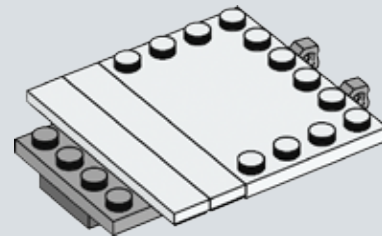

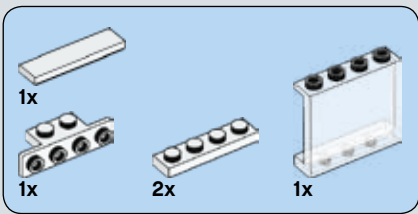

458

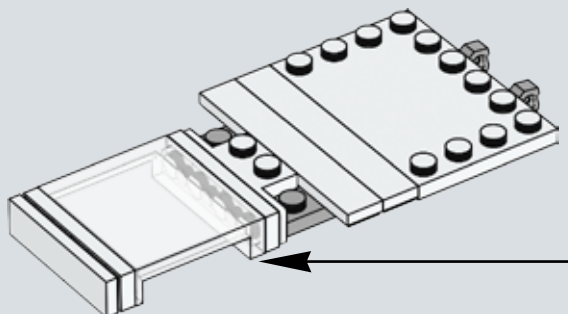
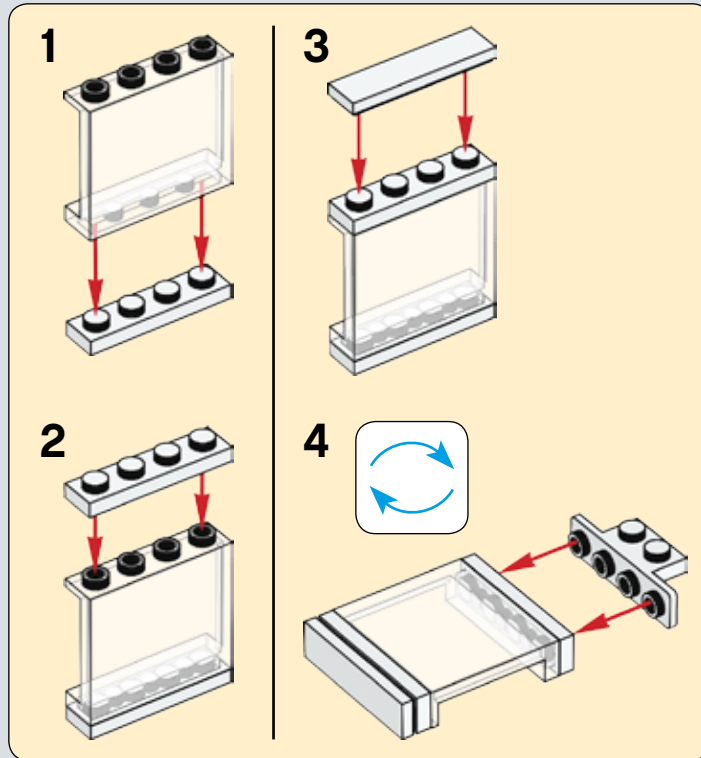

459

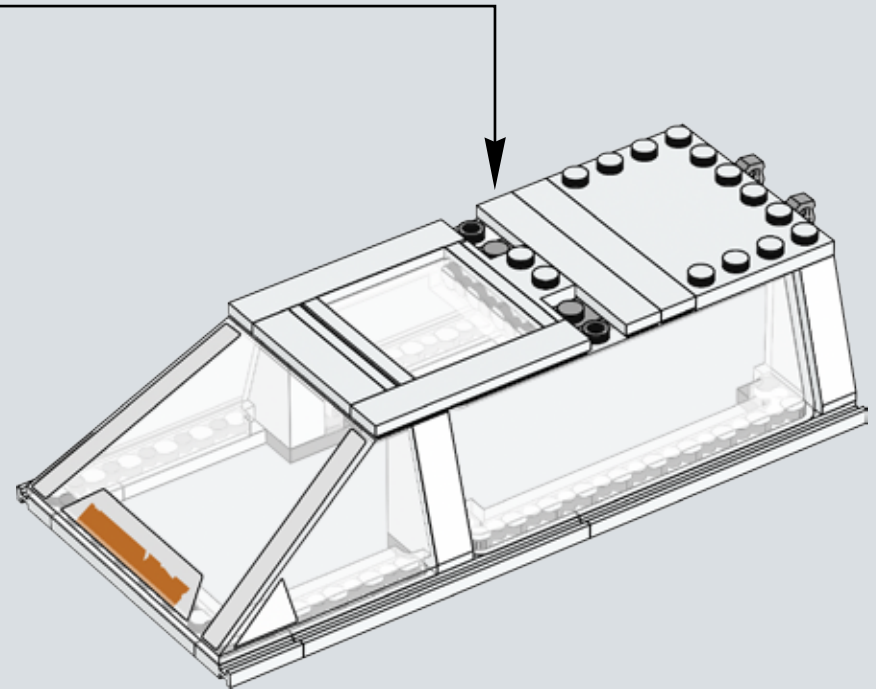



2x

460

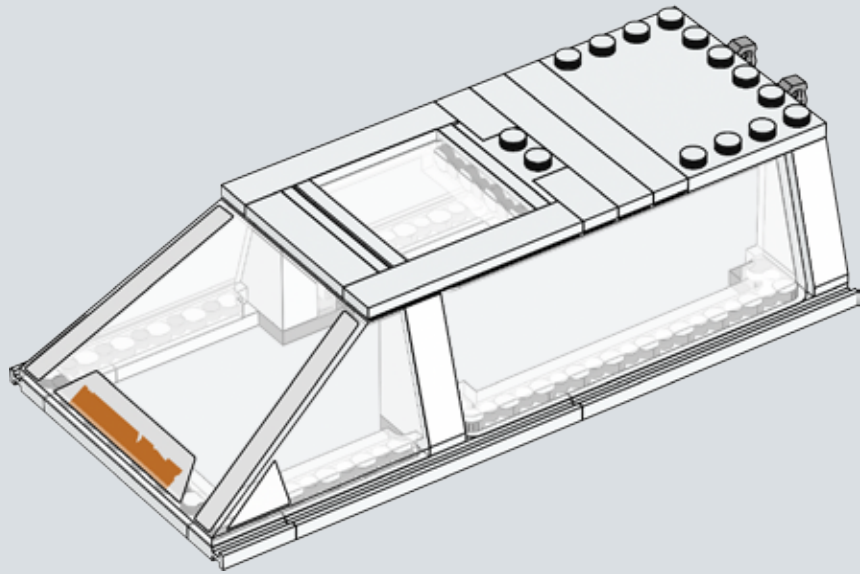

461

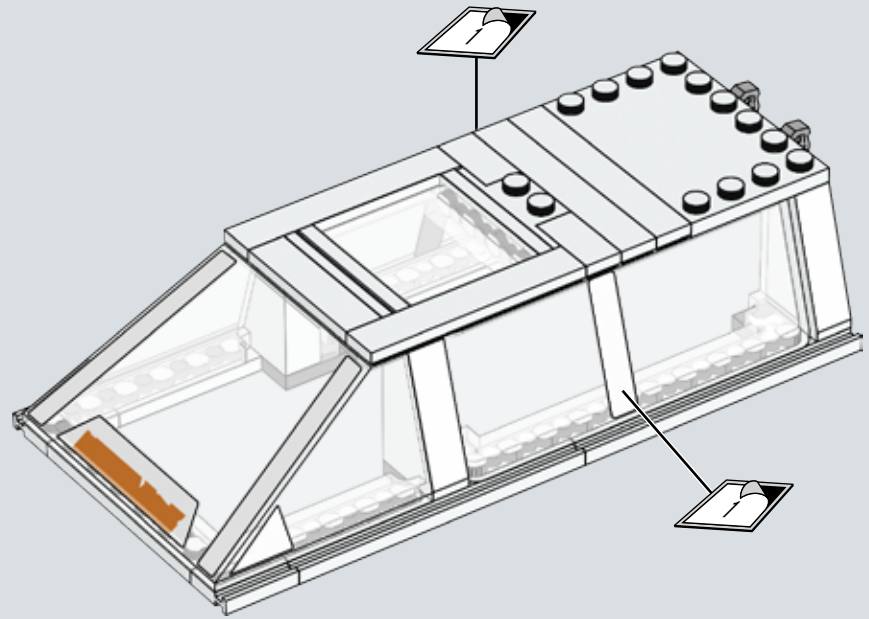

462

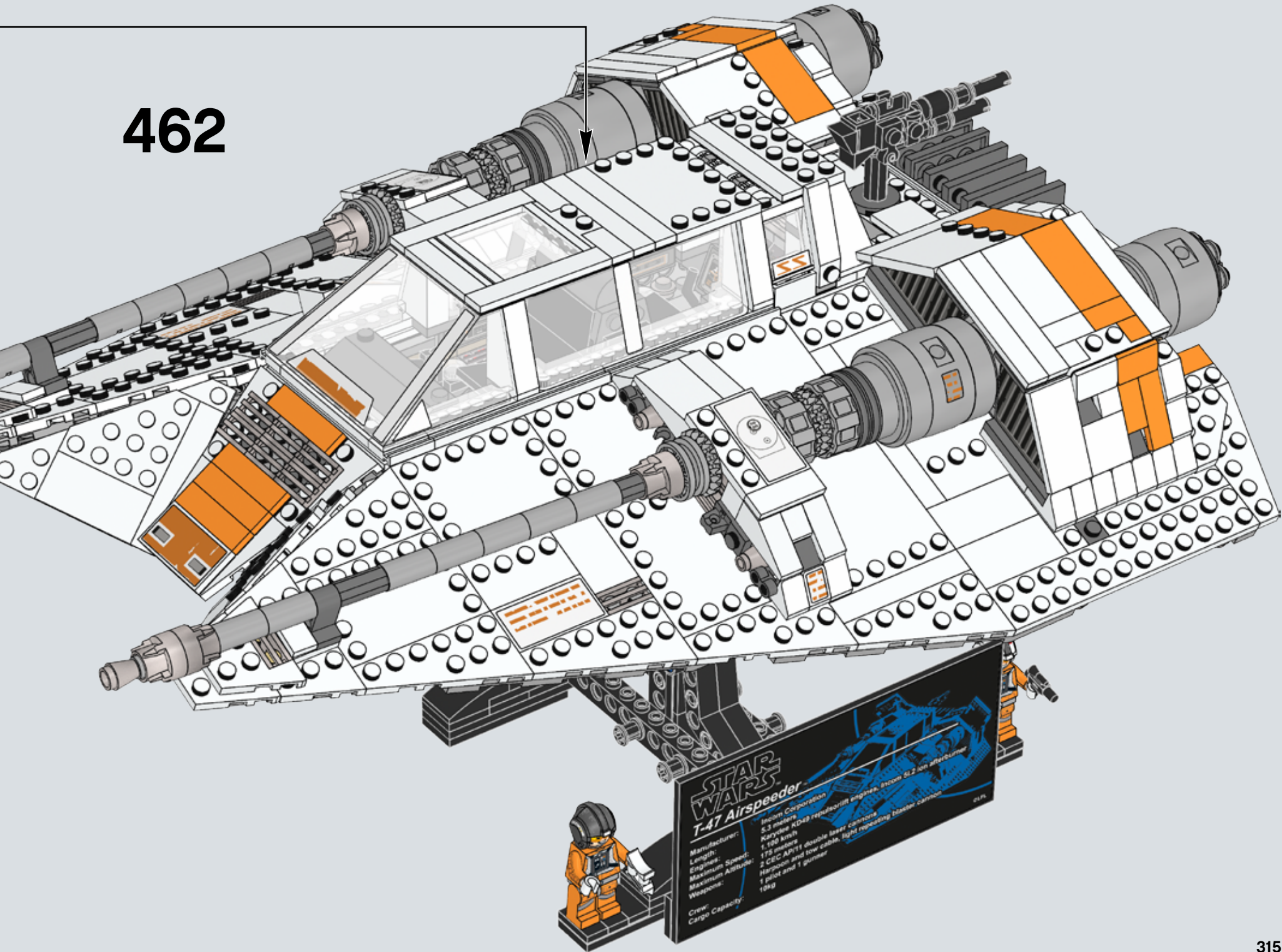

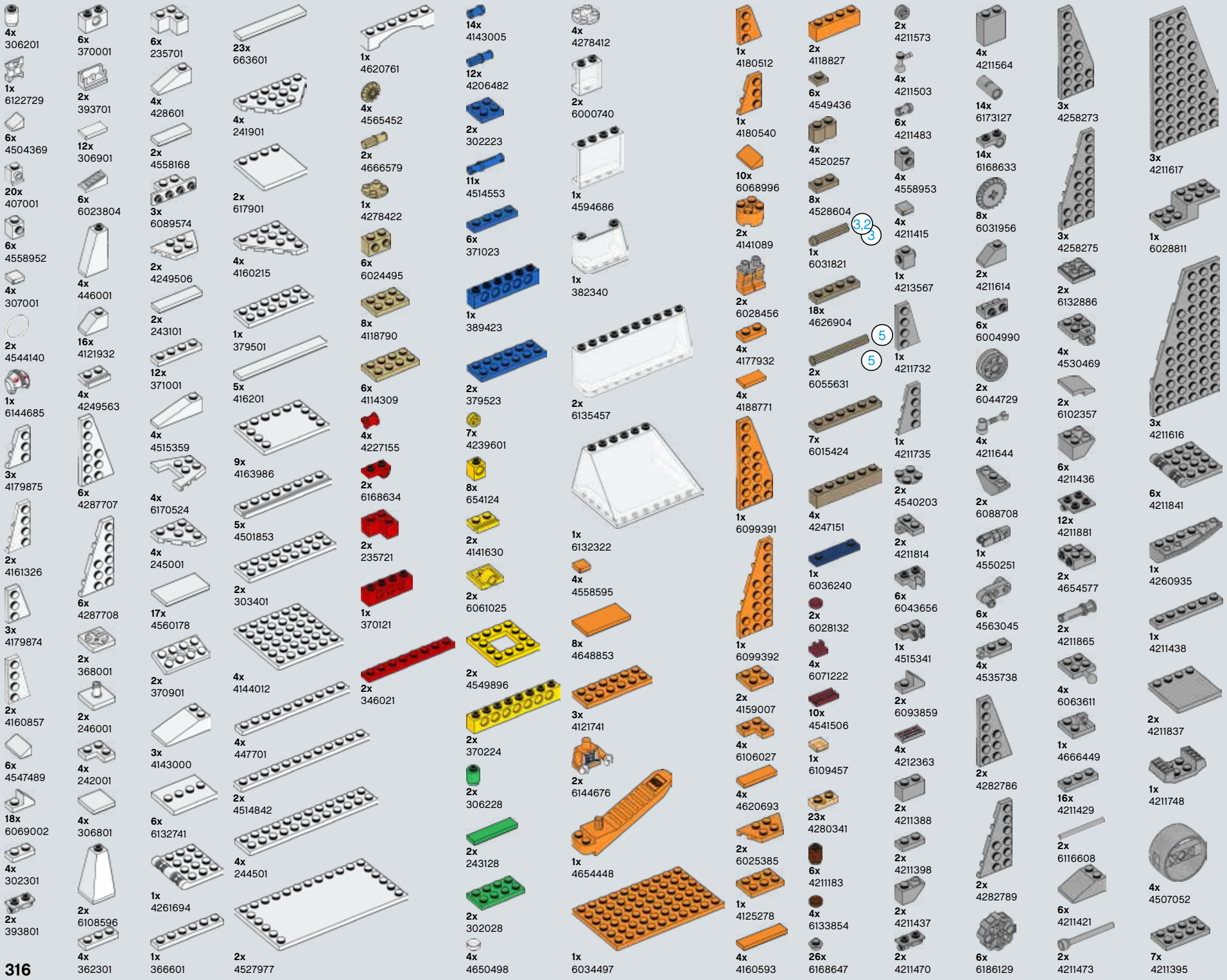

6x 370001
2x 393701
12x 306901
6x 6023804
4x 446001
16x 4121932
4x 4249563
6x 4287707
6x 4287708
2x 368001
2x 246001
6x 4547489
18x 6069002
4x 302301
2x 393801
362301

6x 235701
4x 428601
2x 4558168
3x 6089574
2x 4249506
2x 243101
12x 371001
4x 4515359
4x 6170524
4x 245001
17x 4560178
2x 370901
3x 4143000
6x 6132741
1x 4261694
1x 366601

23x 663601
4x 241901
2x 617901
4x 4160215
1x 379501
5x 416201
9x 4163986
5x 4501853
2x 303401
4x 4144012
4x 447701
2x 4514842
4x 244501
2x 4527977

1x 4620761
4x 4565452
2x 4666579
1x 4278422
6x 6024495
8x 4118790
6x 4114309
4x 4227155
2x 6168634
2x 235721
1x 370121
2x 346021
2x 4549896
2x 370224
2x 306228
2x 243128
2x 302028
4x 4650498

14x 4143005
12x 4206482
2x 302223
11x 4514553
6x 371023
1x 389423
2x 379523
7x 4239601
8x 654124
2x 4141630
2x 6061025
2x 4549896
2x 370224
2x 306228
2x 243128
2x 302028
4x 4650498

4x 4620761
4x 4565452
2x 4666579
1x 4278422
6x 6024495
8x 4118790
6x 4114309
4x 4227155
2x 6168634
2x 235721
1x 370121
2x 346021
2x 4549896
2x 370224
2x 306228
2x 243128
2x 302028
4x 4650498

4x 4620761
4x 4565452
2x 4666579
1x 4278422
6x 6024495
8x 4118790
6x 4114309
4x 4227155
2x 6168634
2x 235721
1x 370121
2x 346021
2x 4549896
2x 370224
2x 306228
2x 243128
2x 302028
4x 4650498

4x 4620761
4x 4565452
2x 4666579
1x 4278422
6x 6024495
8x 4118790
6x 4114309
4x 4227155
2x 6168634
2x 235721
1x 370121
2x 346021
2x 4549896
2x 370224
2x 306228
2x 243128
2x 302028
4x 4650498

4x 4620761
4x 4565452
2x 4666579
1x 4278422
6x 6024495
8x 4118790
6x 4114309
4x 4227155
2x 6168634
2x 235721
1x 370121
2x 346021
2x 4549896
2x 370224
2x 306228
2x 243128
2x 302028
4x 4650498

4x 4620761
4x 4565452
2x 4666579
1x 4278422
6x 6024495
8x 4118790
6x 4114309
4x 4227155
2x 6168634
2x 235721
1x 370121
2x 346021
2x 4549896
2x 370224
2x 306228
2x 243128
2x 302028
4x 4650498

4x 4620761
4x 4565452
2x 4666579
1x 4278422
6x 6024495
8x 4118790
6x 4114309
4x 4227155
2x 6168634
2x 235721
1x 370121
2x 346021
2x 4549896
2x 370224
2x 306228
2x 243128
2x 302028
4x 4650498

4x 4620761
4x 4565452
2x 4666579
1x 4278422
6x 6024495
8x 4118790
6x 4114309
4x 4227155
2x 6168634
2x 235721
1x 370121
2x 346021
2x 4549896
2x 370224
2x 306228
2x 243128
2x 302028
4x 4650498

4x 4620761
4x 4565452
2x 4666579
1x 4278422
6x 6024495
8x 4118790
6x 4114309
4x 4227155
2x 6168634
2x 235721
1x 370121
2x 346021
2x 4549896
2x 370224
2x 306228
2x 243128
2x 302028
4x 4650498

4x 4620761
4x 4565452
2x 4666579
1x 4278422
6x 6024495
8x 4118790
6x 4114309
4x 4227155
2x 6168634
2x 235721
1x 370121
2x 346021
2x 4549896
2x 370224
2x 306228
2x 243128
2x 302028
4x 4650498

4x 4620761
4x 4565452
2x 4666579
1x 4278422
6x 6024495
8x 4118790
6x 4114309
4x 4227155
2x 6168634
2x 235721
1x 370121
2x 346021
2x 4549896
2x 370224
2x 306228
2x 243128
2x 302028
4x 4650498

4x 4620761
4x 4565452
2x 4666579
1x 4278422
6x 6024495
8x 4118790
6x 4114309
4x 4227155
2x 6168634
2x 235721
1x 370121
2x 346021
2x 4549896
2x 370224
2x 306228
2x 243128
2x 302028
4x 4650498

4x 4620761
4x 4565452
2x 4666579
1x 4278422
6x 6024495
8x 4118790
6x 4114309
4x 4227155
2x 6168634
2x 235721
1x 370121
2x 346021
2x 4549896
2x 370224
2x 306228
2x 243128
2x 302028
4x 4650498

4x 4620761
4x 4565452
2x 4666579
1x 4278422
6x 6024495
8x 4118790
6x 4114309
4x 4227155
2x 6168634
2x 235721
1x 370121
2x 346021
2x 4549896
2x 370224
2x 306228
2x 243128
2x 302028
4x 4650498

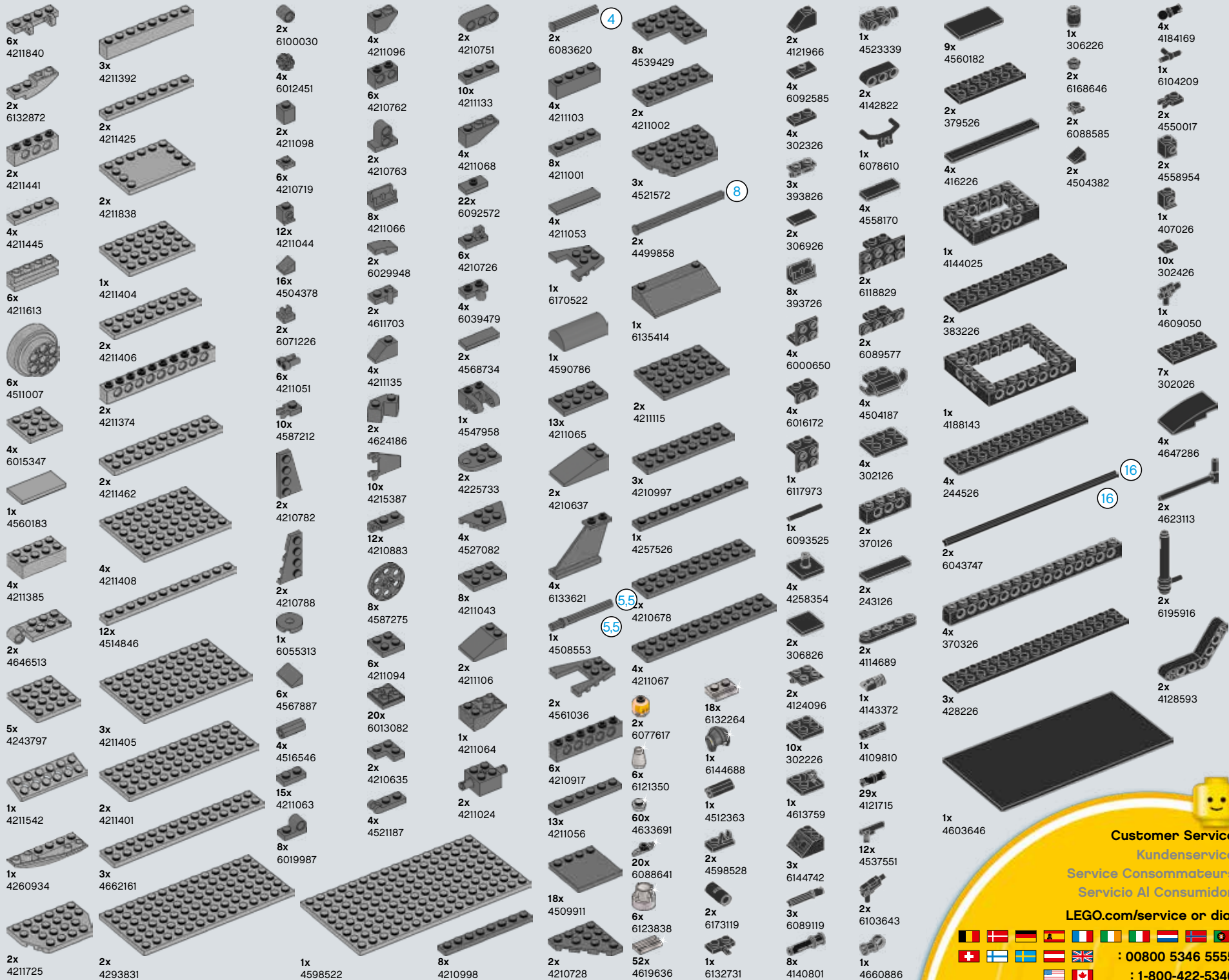



Customer Service
 Kundenservice
 Service Consommateurs
 Servicio Al Consumidor
LEGO.com/service or dial

 : 00800 5346 5555
 : 1-800-422-5346

WIN

GO TO WWW.LEGO.COM/PRODUCTFEEDBACK AND
GIVE US YOUR SHORT **FEEDBACK** ABOUT THIS
LEGO® SET FOR A CHANCE TO WIN
A COOL LEGO PRIZE.

Terms & Conditions apply



LEGO.com/productfeedback

GEWINNE

Erzähle uns auf
www.LEGO.com/productfeedback

etwas über die Erfahrungen, die
du mit diesem LEGO® Set gemacht
hast, und sichere dir die Chance
auf einen coolen LEGO Preis!

Es gelten die
Teilnahmebedingungen

GAGNE

Rends-toi sur
www.LEGO.com/productfeedback

et donne-nous quelques com-
mentaires sur ce produit LEGO®
pour avoir une chance de gagner
un prix LEGO !

Voir Conditions Générales

GANANA

Visita
www.LEGO.com/productfeedback

y envíanos tu opinión acerca de
este set LEGO®, ¡Participarás en el
sorteo de un premio LEGO!

Términos y Condiciones aplicables

获取奖品

登录
www.LEGO.com/productfeedback

给出关于此乐高®套装的简短反馈，
就有机会获得炫酷乐高高奖品

《条款及条件》适用

경품 당첨 기회

www.LEGO.com/productfeedback

페이지로 이동하여 이 레고® 세트에
대한 간략한 피드백을 보내 주시고
멋진 레고 경품을 탈 수 있는 기회도
잡으십시오

약관 적용

ЗАПОЛНИ АНКЕТУ И ПОЛУЧИ ПРИЗ

Перейди по ссылке
www.LEGO.com/productfeedback

ответь всего на несколько во-
просов об этом наборе LEGO®,
и у тебя появится шанс выиграть
замечательный приз от компании
LEGO.

Применяются Условия и правила
участия