



NINJAGO™

Masters of Spinjitzu



70602



LEGO.com/ninjago

EN IMPORTANT: Never modify the elements or use other projectiles than provided with this toy.

DE WICHTIG: Die Elemente dürfen nicht verändert werden. Es dürfen ausschließlich die mit dem Spielzeug mitgelieferten Geschosse verwendet werden.

FR IMPORTANT : Ne jamais modifier les éléments ni utiliser d'autres projectiles que ceux fournis avec ce jouet.

IT IMPORTANTE: Non modificare gli elementi o utilizzare proiettili non forniti con questo prodotto.

NL BELANGRIJK: Verander niets aan de elementen en gebruik geen andere projectielen dan de bij het speelgoed geleverde.

ES IMPORTANTE: No modifique los elementos ni utilice otros proyectiles diferentes a los suministrados junto con este juguete.

DA VIGTIGT: Elementerne må ikke ændres, og der må ikke bruges andre projektiler end dem, der følger med legetøjet.

IS MIKLIVÆGT: Aldrei skal breyta einingum vörunnar eða nota önnur skot en þau sem fylgja þessu leikfangi.

FI TÄRKEÄÄ: Älä koskaan tee osiin muutoksia tai käytä lelussa muita kuin sen sisältämiä ammuksia.

SV VIKTIGT: Modifiera aldrig delarna och använd aldrig andra projektiler än de som medföljer denna leksak.

NO VIKTIG: Elementene må ikke endres, og det må aldri brukes andre prosjektiler enn dem som følger med leketøyet.

PT IMPORTANTE: Nunca modifique os elementos nem utilize projecteis que não tenham sido fornecidos com este brinquedo.

EL ΣΗΜΑΝΤΙΚΟ: Ποτέ μην τροποποιείτε τα στοιχεία του παιχνιδιού και μην χρησιμοποιείτε άλλα βλήματα εκτός από αυτά που συνοδεύουν αυτό το παιχνίδι.

JA 重要：部品を改造したり、本製品に付属の発射体以外のものを使用しないでください。

ZH 重要提示：切勿更改组件或使用并非由本玩具附带的弹丸。

KO 중요: 이들 부품을 수정하거나 이 원구와 함께 제공된 것이 아닌 발사체는 결코 사용하지 마십시오.

RU ВАЖНО: Запрещается вносить изменения в элементы или использовать другие снаряды, отличные от тех, которые поставляются с данной игрушкой.

PL WAŻNE: Nigdy nie modyfikować elementów ani nie używać innych pocisków niż dostarczonych z zabawką.

CZ UPOZORNĚNÍ: Nikdy neupravujte součástky a nepoužívejte jiné projektily než ty, které jsou dodávány s touto hračkou.

SK UPOZORNENIE: Nikdy neupravujte súčasti a nepoužívajte iné projektily než tie, ktoré sú dodávané s touto hračkou.

HU FONTOS: Az elemeket nem szabad módosítani, és a játékhöz adott lövedékek helyett sem szabad mást használni.

UA УВАГА: Ніколи не модифікуйте елементи. Використовуйте тільки снаряди, що входять у комплект цієї іграшки.

HR VAŽNO: Nemojte nikad mijenjati elemente ili koristiti druge projektile osim onih koji bili priloženi uz ovu igračku prilikom kupnje.

SR VAŽNO: Nemojte da modifikujete elemente i ne koristite druge projektile osim onih koji dolaze uz ovu igračku.

MK VAŽNO: Nikogash ne menuvajte gi elementite i ne koristete drugi projektili od tih što vi se dadeni so igračkata.

SL POMEMBNO: Nikoli ne spreminjajte elementov in uporabljajte le izstrelke, ki so bili priloženi tej igrački.

RO IMPORTANT: Nu modificați niciodată elementele și nu utilizați alte proiectile decât cele furnizate cu această jucărie.

BG ВАЖНО: В никакъв случай не видоизменяйте елементите и не използвайте други снаряди освен предоставените с тази играчка.

LV SVARĪGI: Nekad nepārveidojiet rotallietas elementus, vienmēr izmantojiet tikai tās komplektā iekļautās lodītes.

ET OLULINE: Mänguasja osi ei tohi teistega asendada, kasutada võib ainult kaasasolevat heitkeha.

TR SVARBU: Niekuomet nekeiskite elementų ir naudokite tik tuos šovinius, kurie yra pridėti prie šio žaislo.

LT ÖNEMLI: Hiçbir zaman parçalarda değişiklik yapmayın veya bu oyuncakla verilenler dışında fırlatıcılar kullanmayın.

AR ملاحظة مهمة: تجنب تعديل العناصر أو استخدام مقذوفات أخرى خلاف المرفقة مع هذه اللعبة.

ID PENTING: Jangan pernah memodifikasi elemen atau menggunakan pelet lain selain yang disediakan bersama mainan ini.

MS PENTING: Jangan ubah suai elemen atau guna peluncur lain selain daripada yang disediakan untuk alat mainan ini.

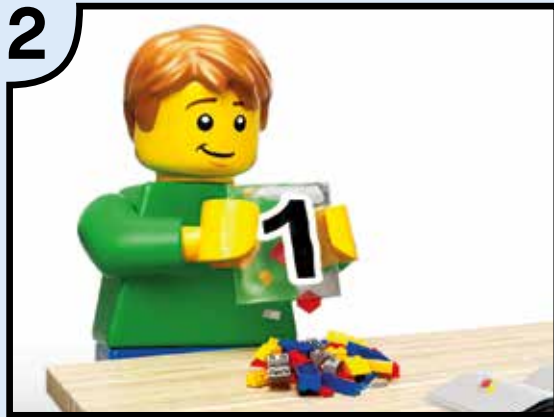



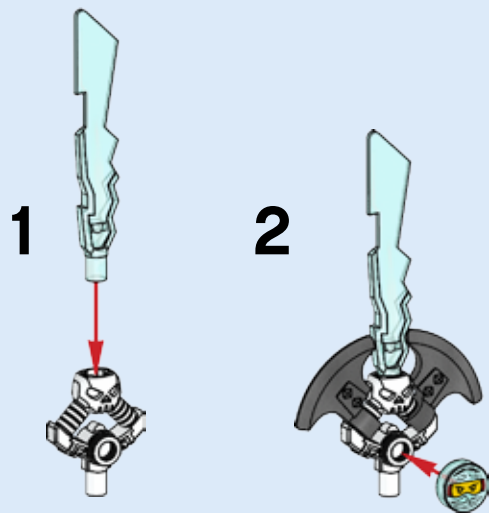
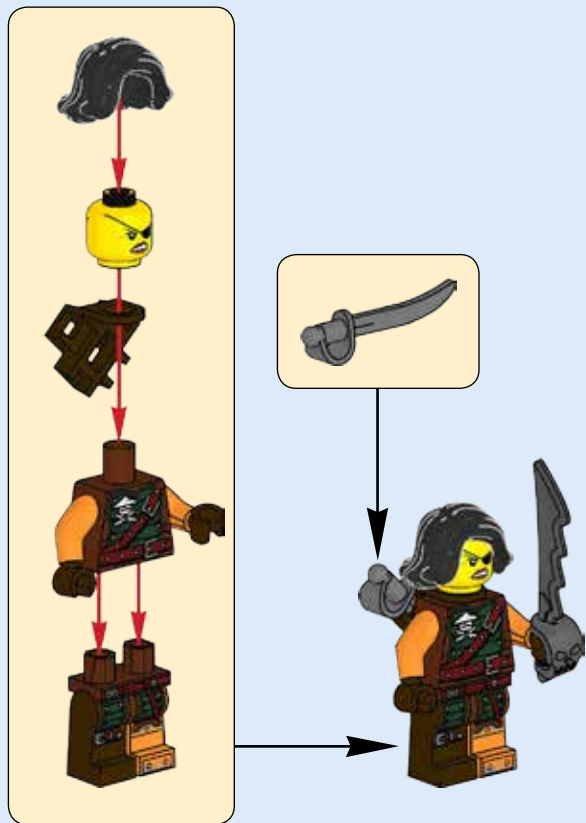

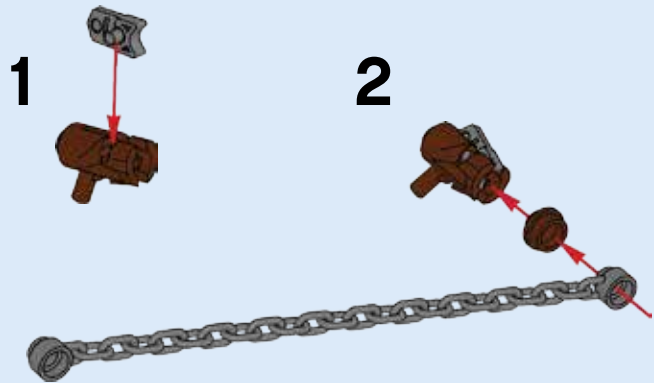

6



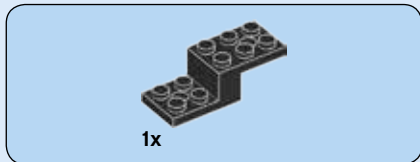

1

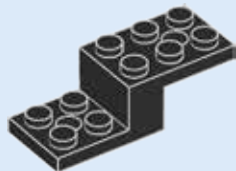

2

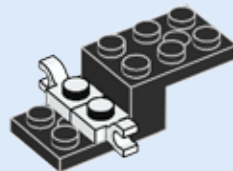



1x

3

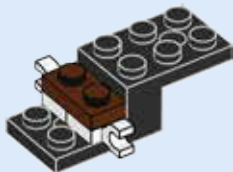

8



1x



2x

4

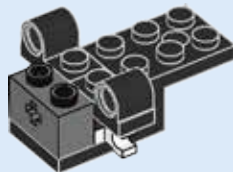



5

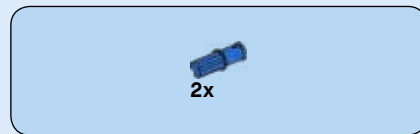
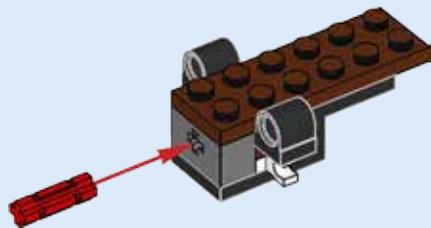

6

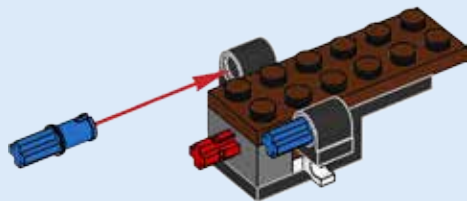



1x



2x



1x

7

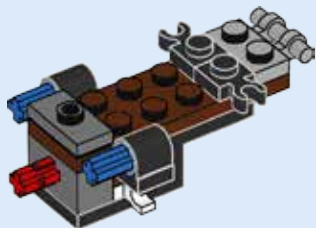

1x



1x

8

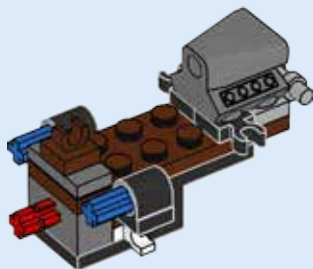

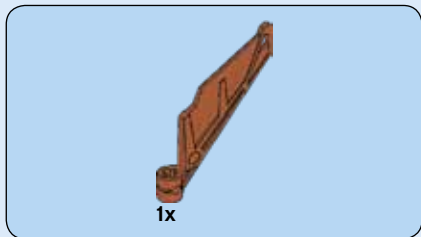

9

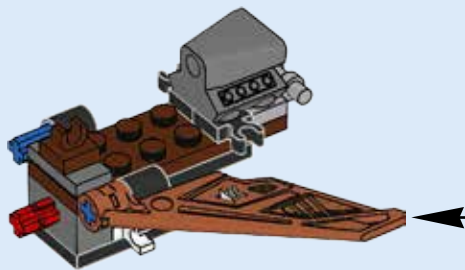
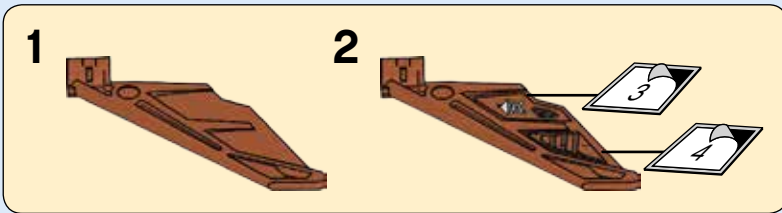

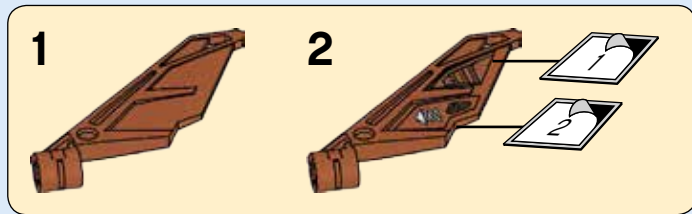
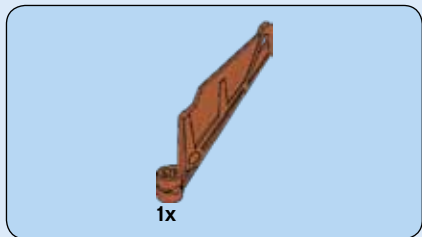

10

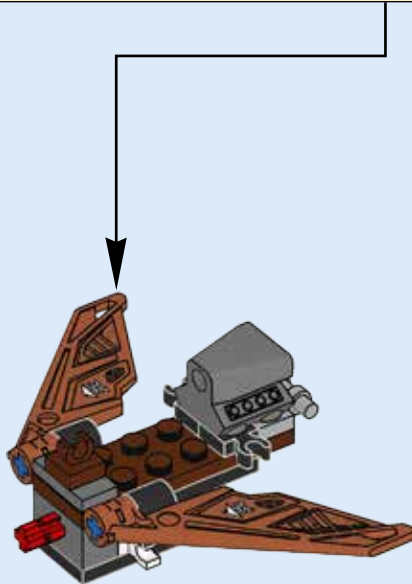



11

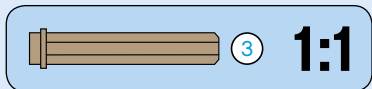
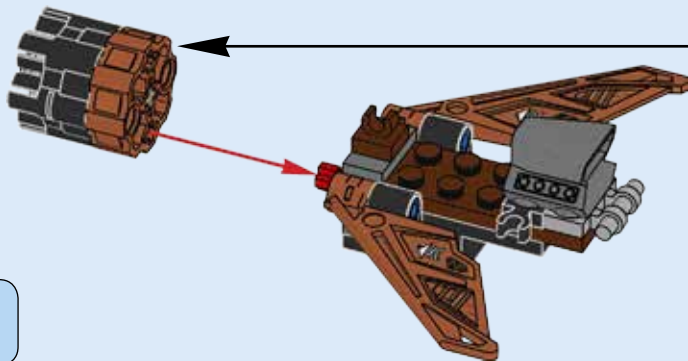
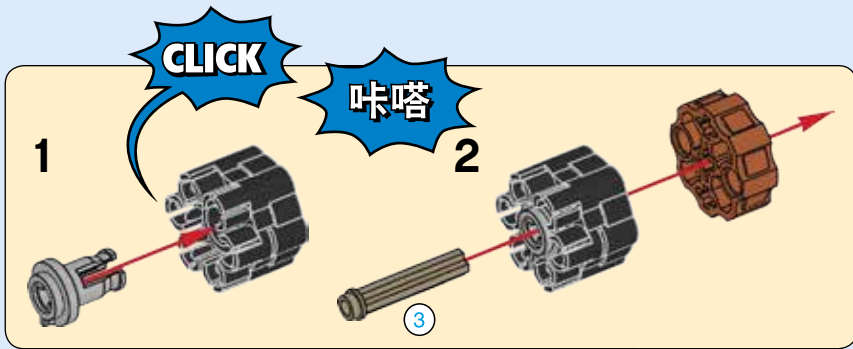



2x

12

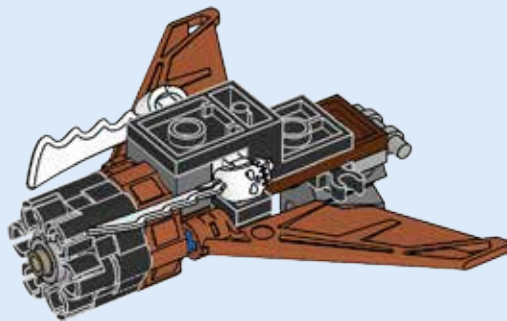
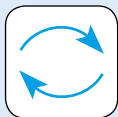

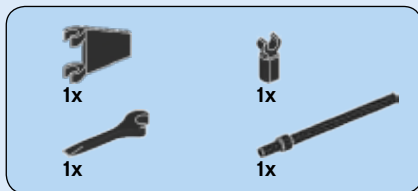

13

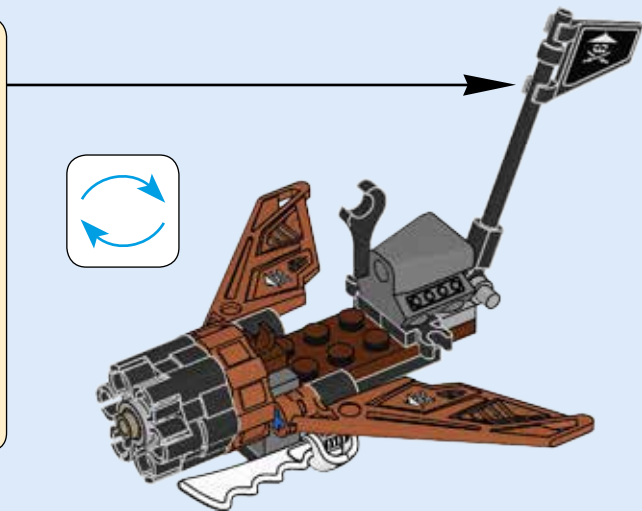
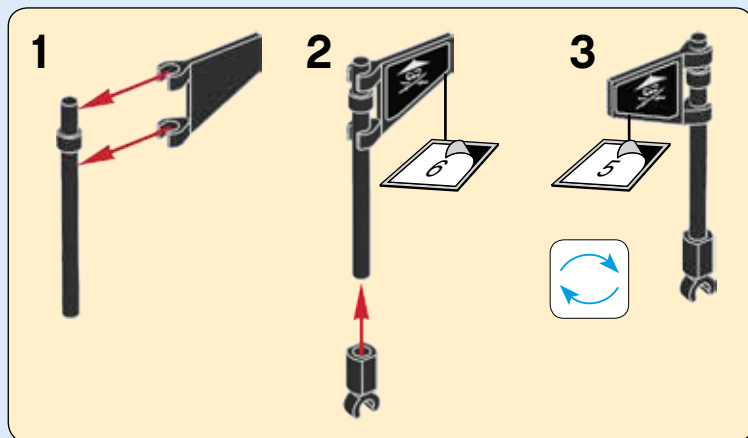



6x



1x

14

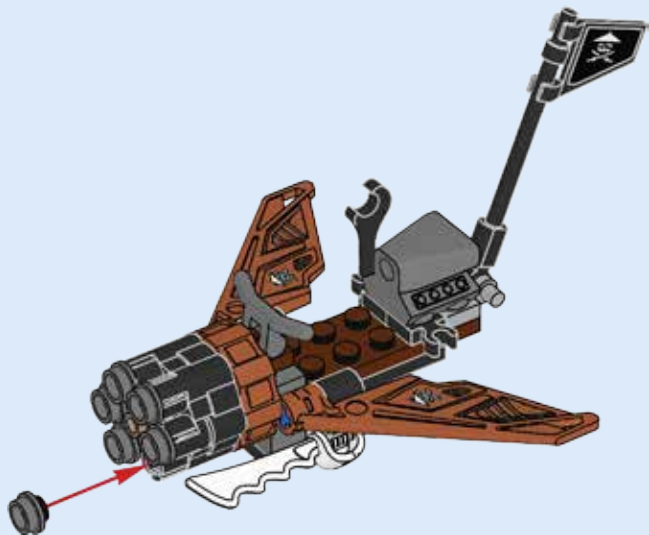

16



6x



15

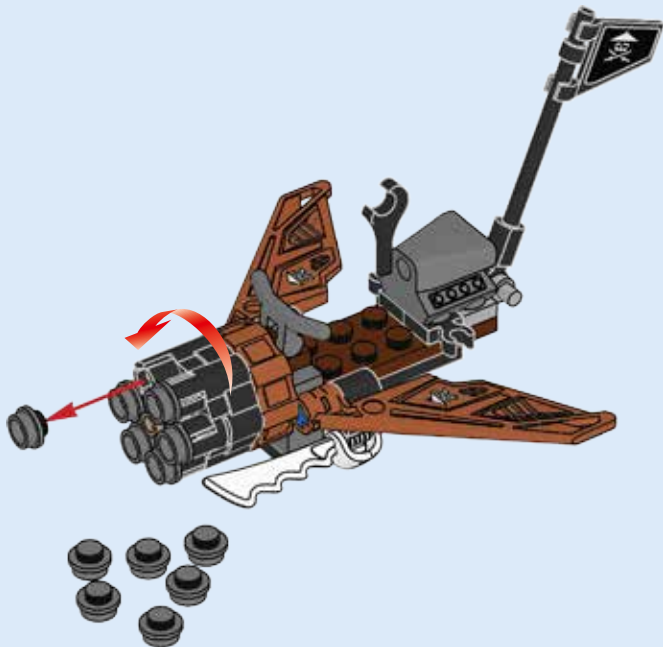

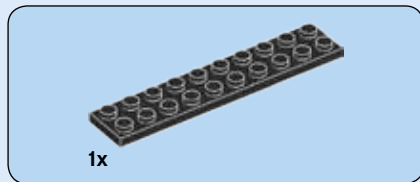

1

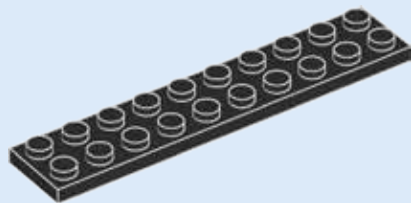

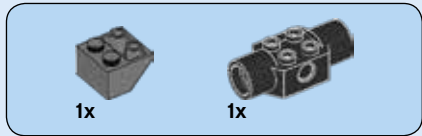

2

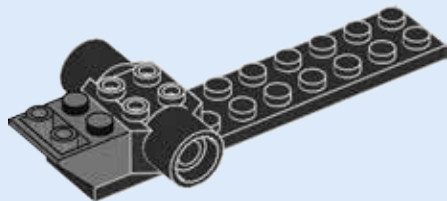

3

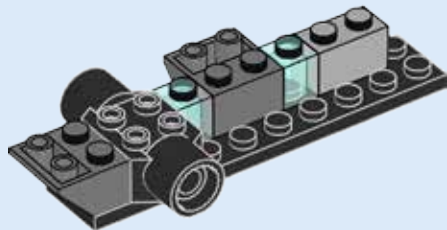

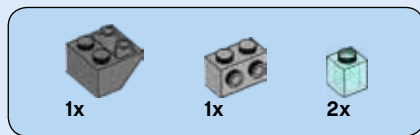

4

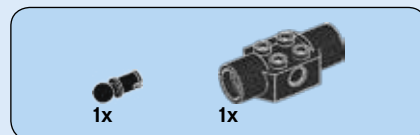
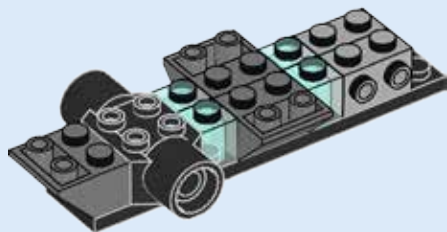

5

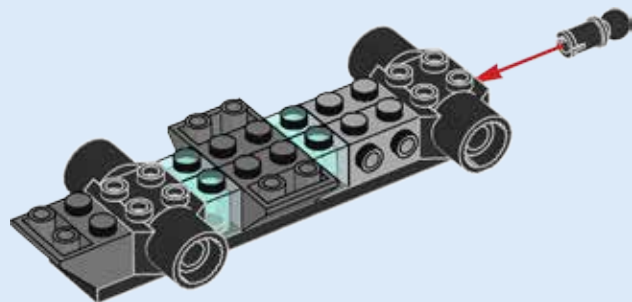

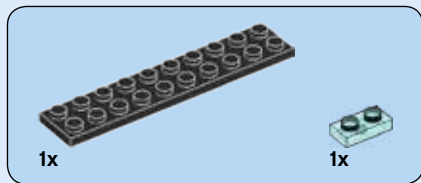

6

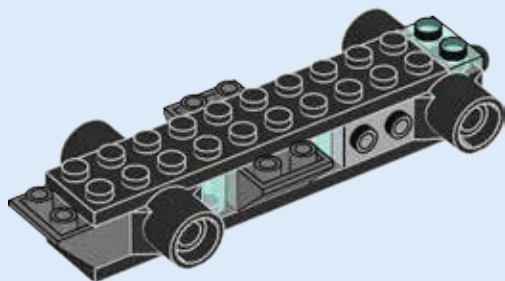

7

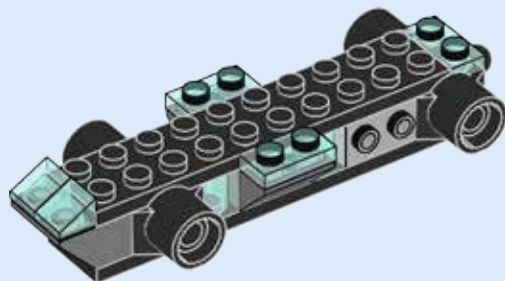



8

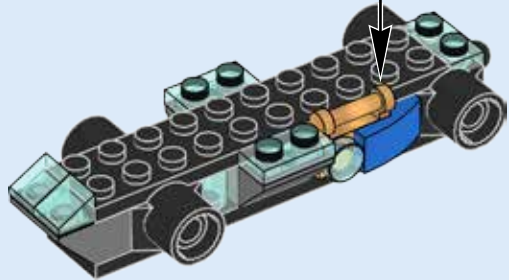
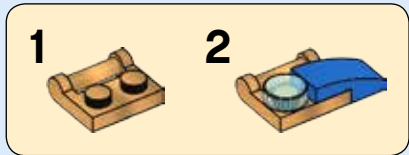

9

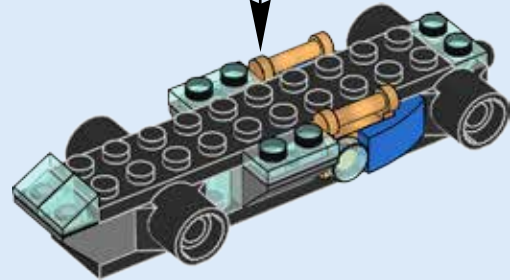



10

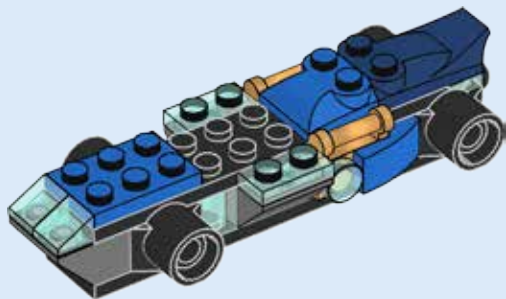

11

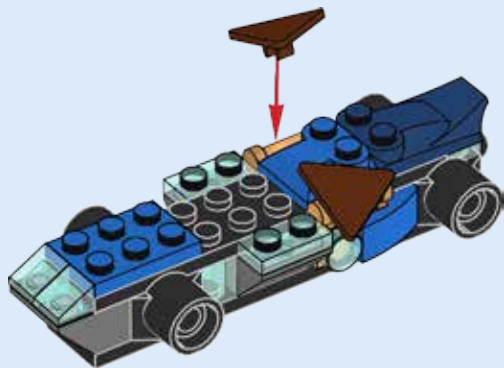

12

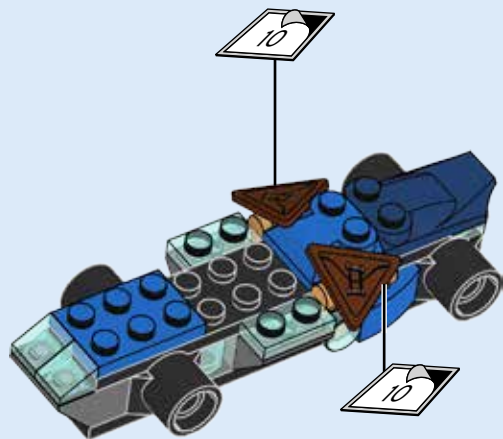

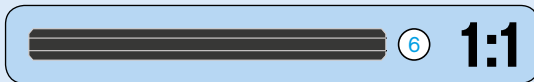
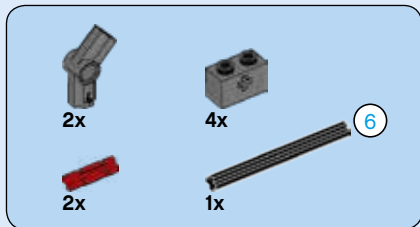

13

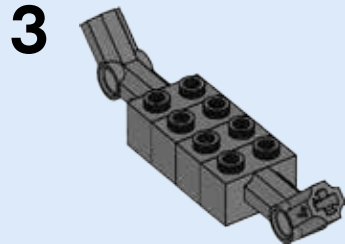
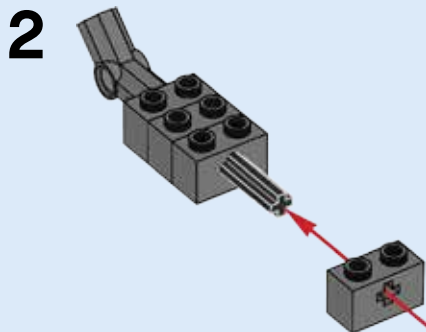
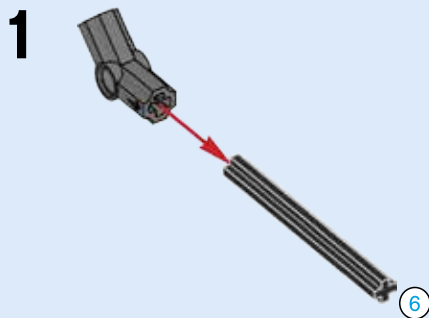

4

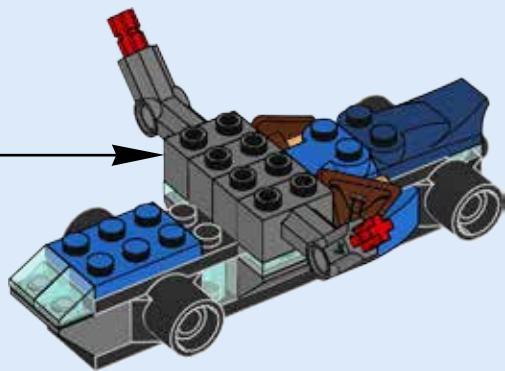
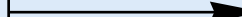
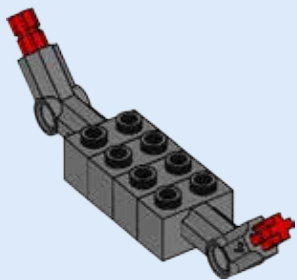



2x

14

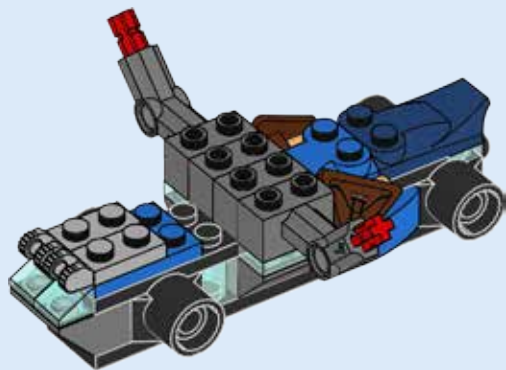

26



1x

15

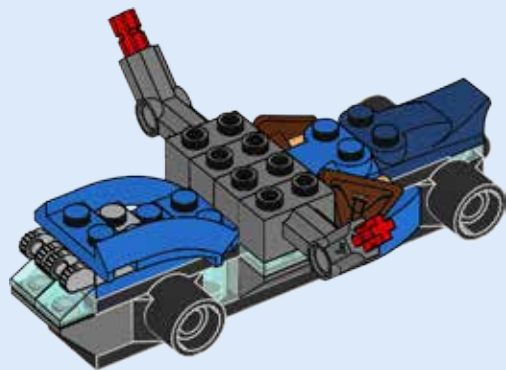



1x

16

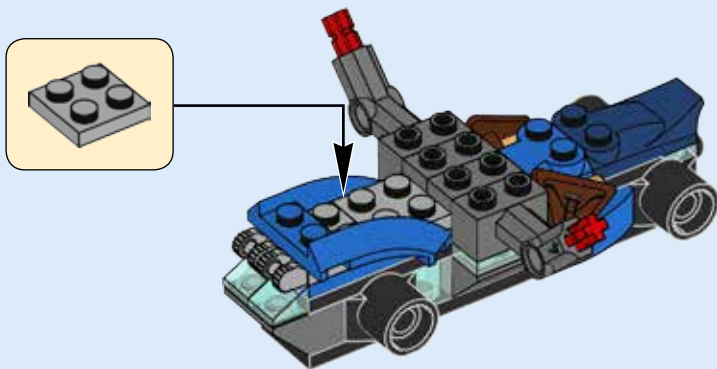



17

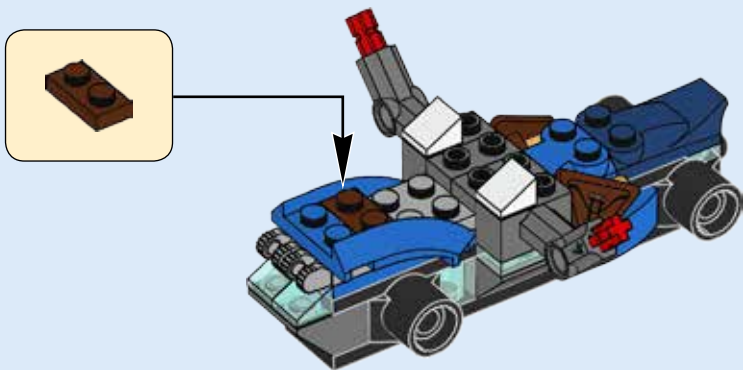

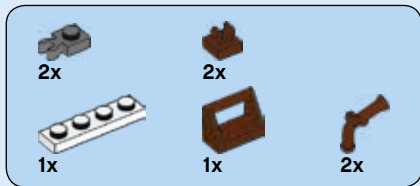

18

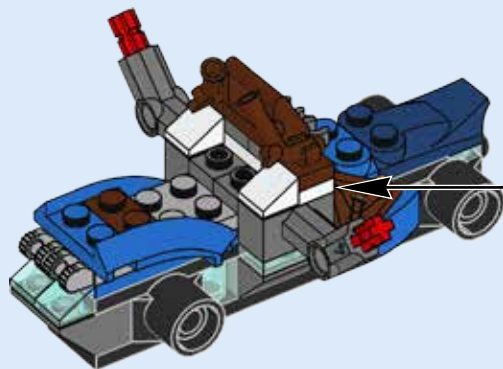
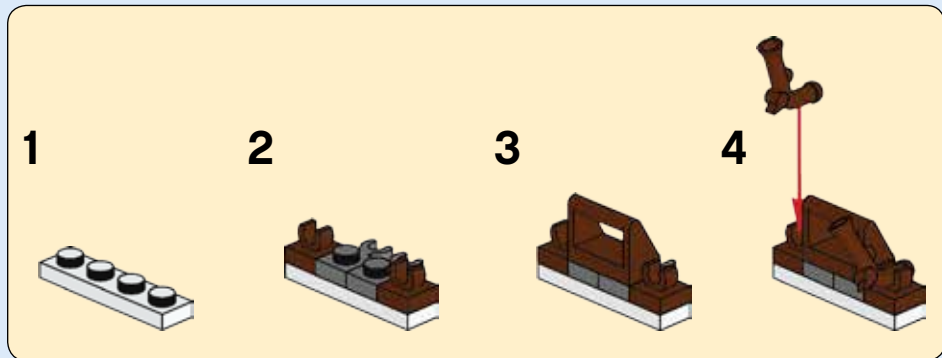



19

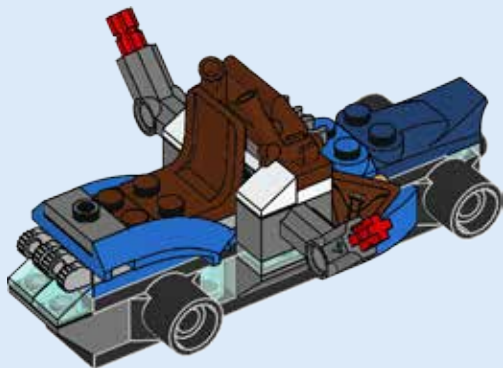



1x



1x

20

