



# CITY

60068



 [LEGO.com/city](https://www.lego.com/city)



**WARNING:** CHOKING HAZARD.  
Small parts. Not for children under 3 years.



+





**AVERTISSEMENT :**

**RISQUE D'ÉTOUFFEMENT.**

Contient des petites pièces. Ne convient pas aux enfants de moins de 3 ans.



**ADVERTENCIA:**

**PELIGRO DE ASFIXIA.**

No recomendado para niños menores de 3 años. Contiene piezas pequeñas.



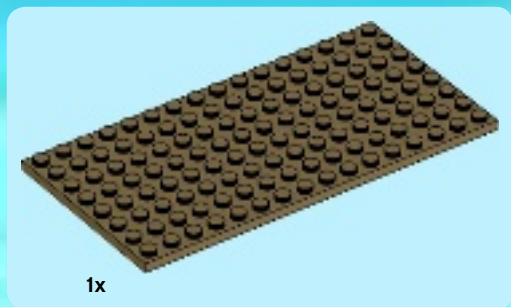

1

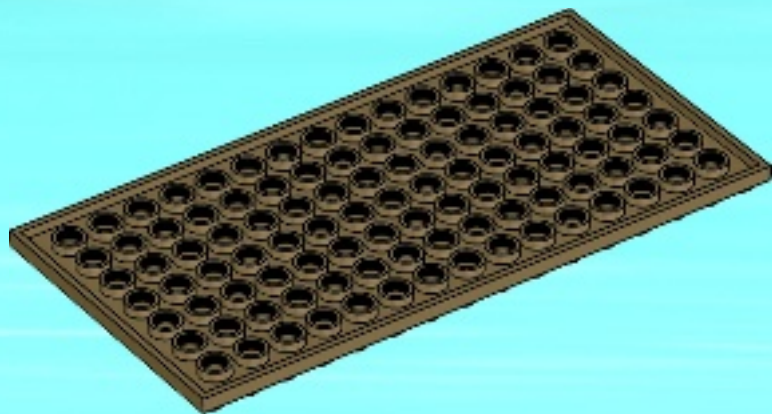



2x

2

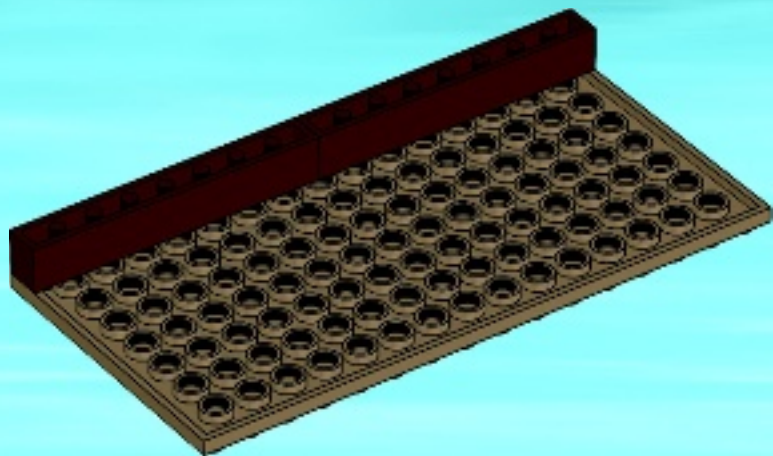



2x

3

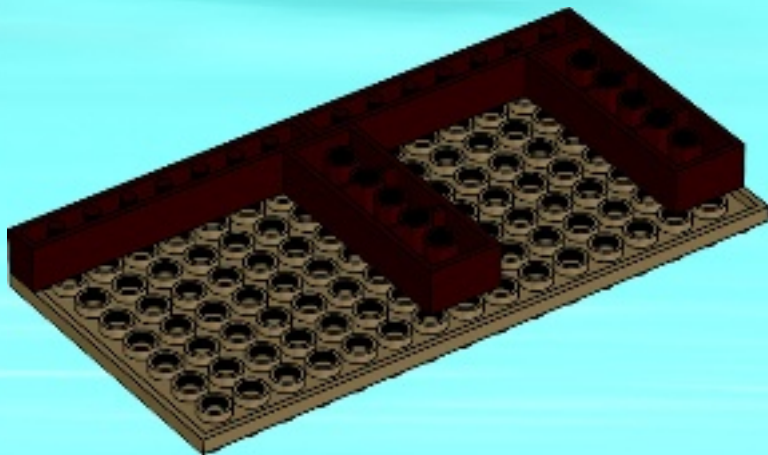

6



2x

4

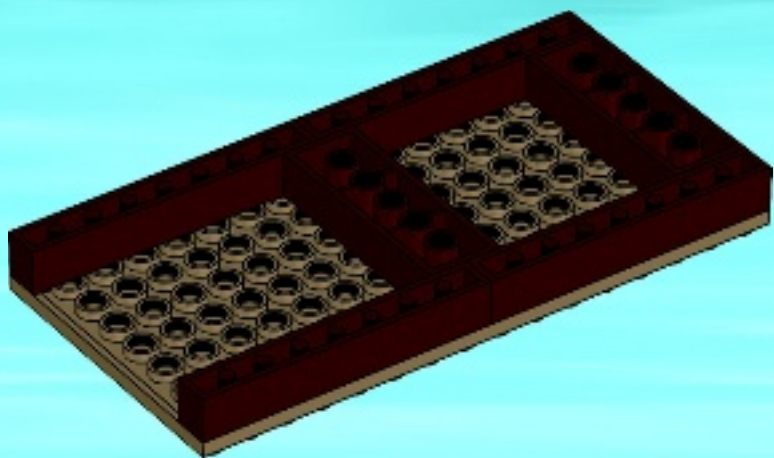



2x

5

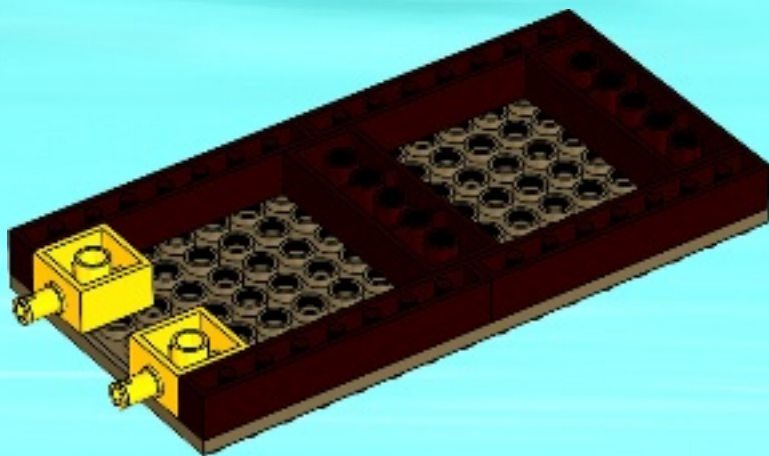

8





3x

6

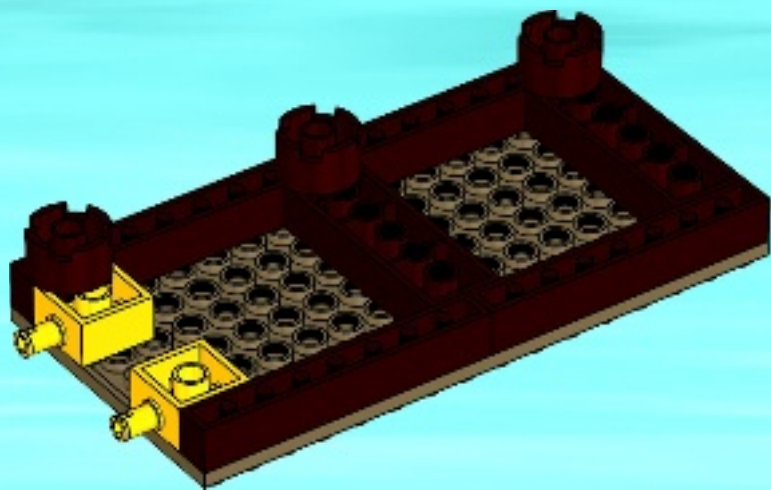



3x

7

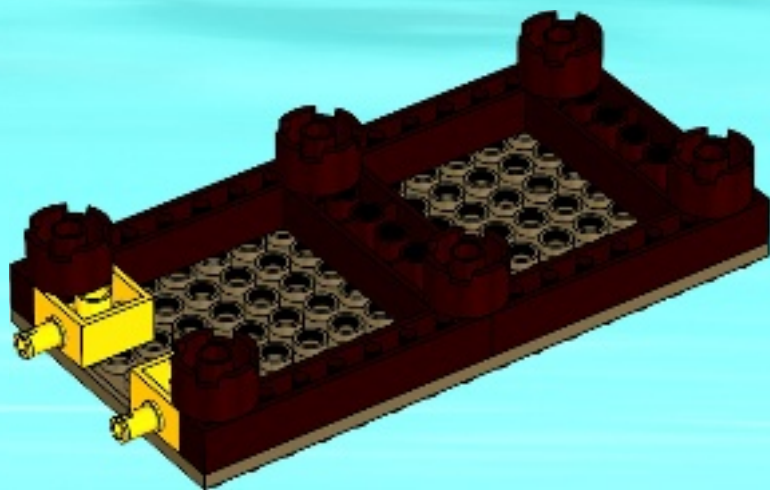

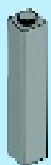

1x

8

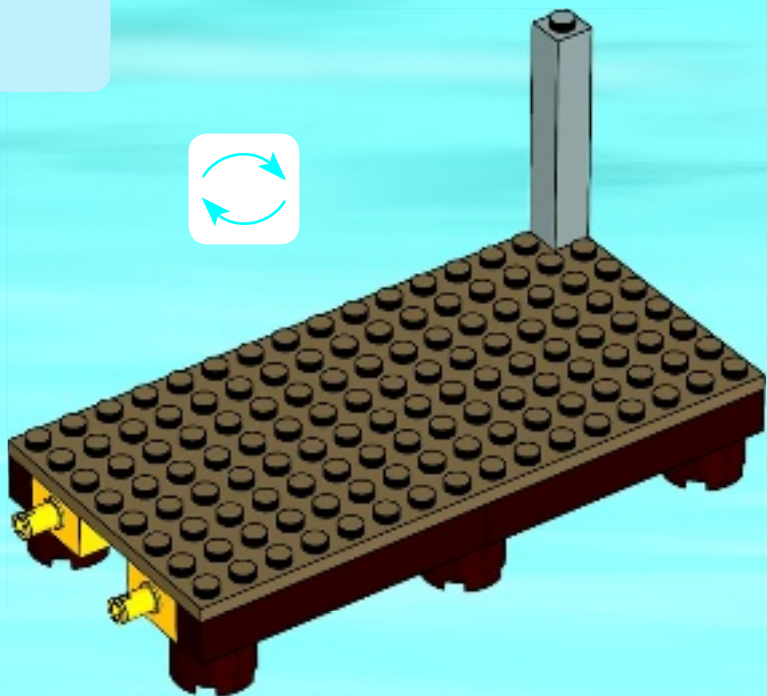



2x

9

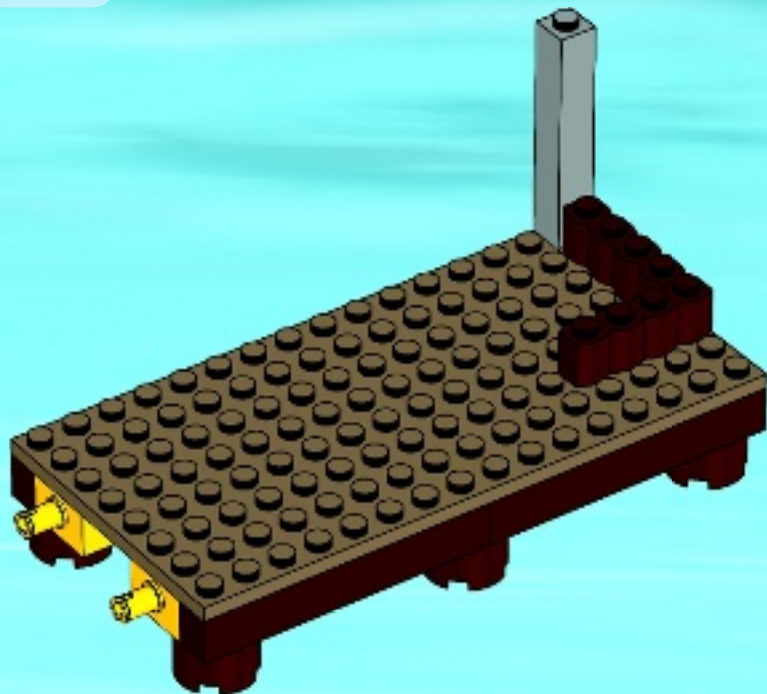



3x

10

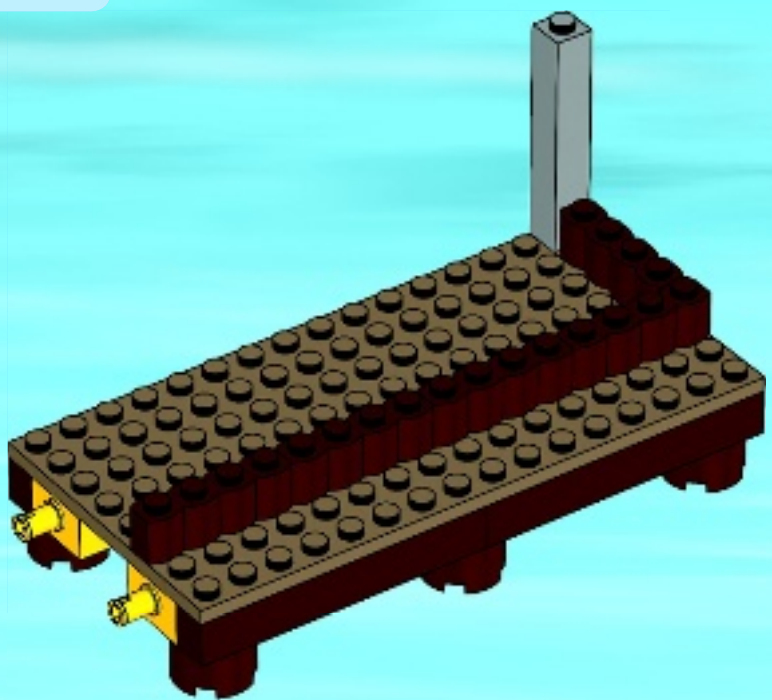



2x

11

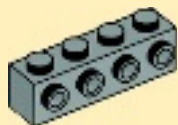
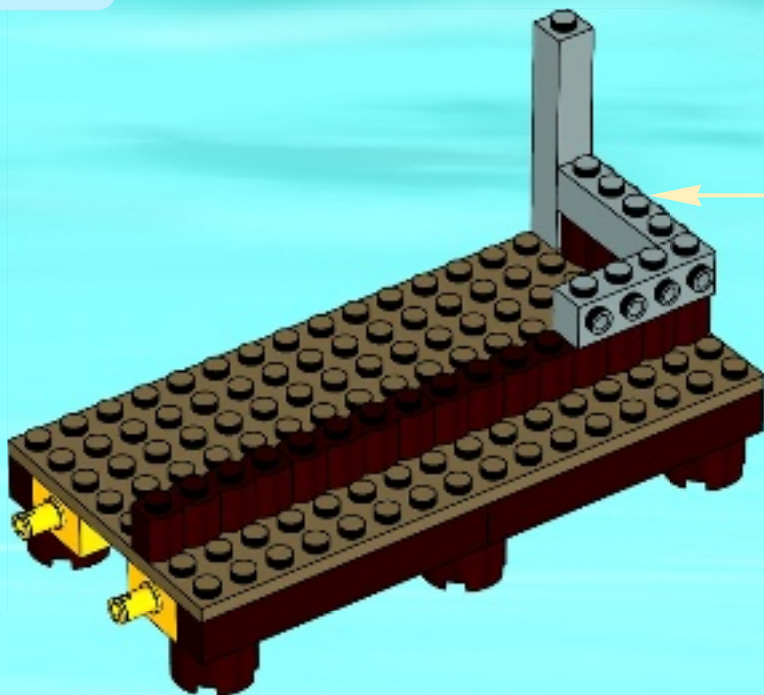



3x

12

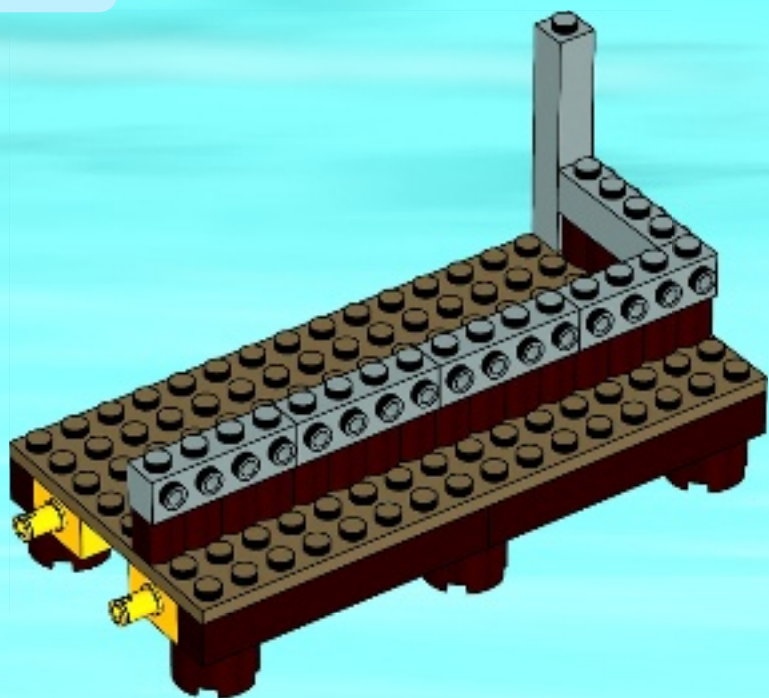

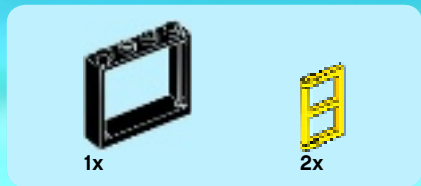

13

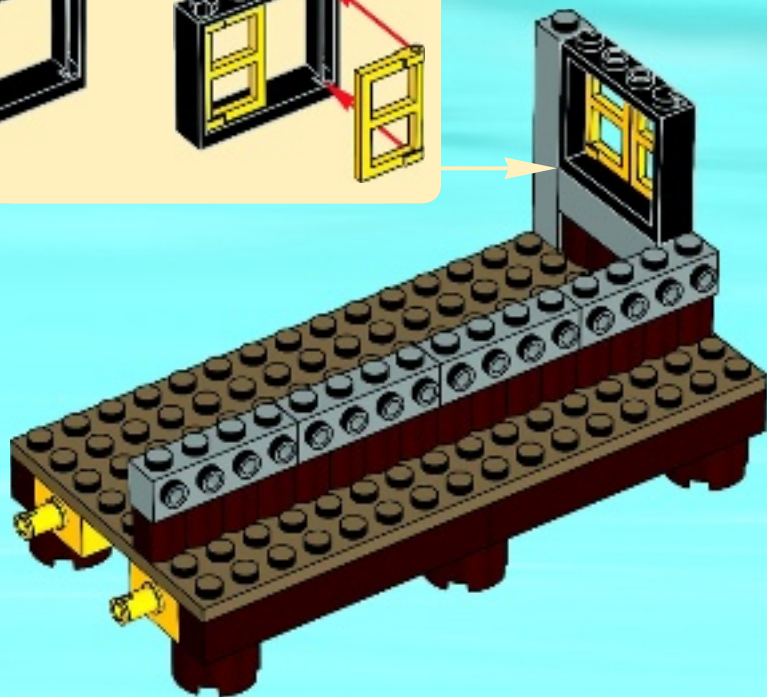
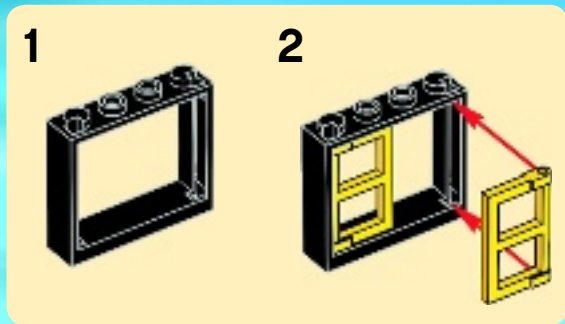







6x

15

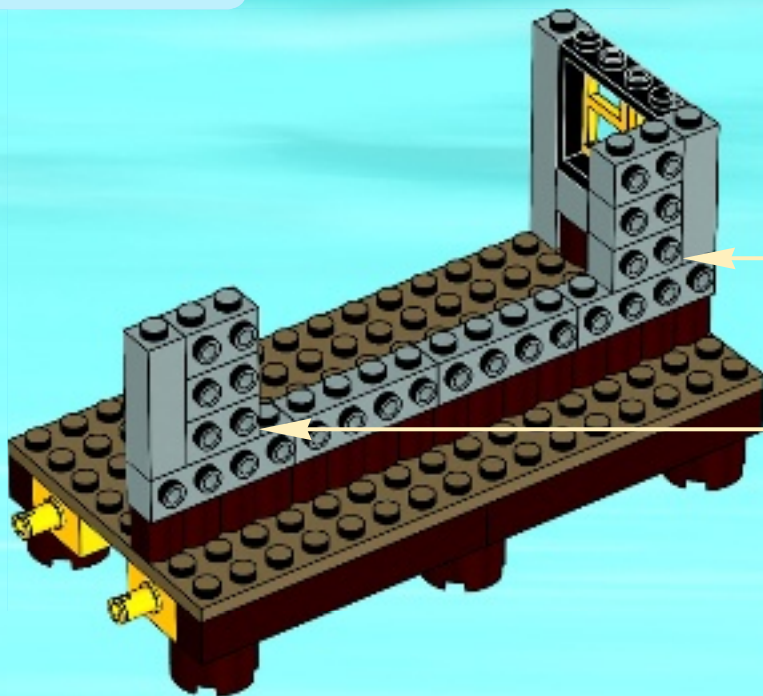

1

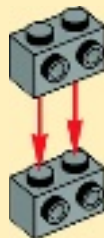

2

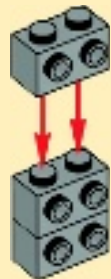

2x

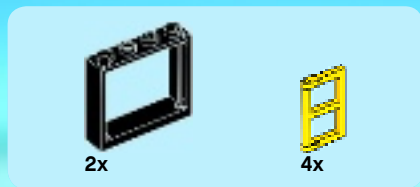

16

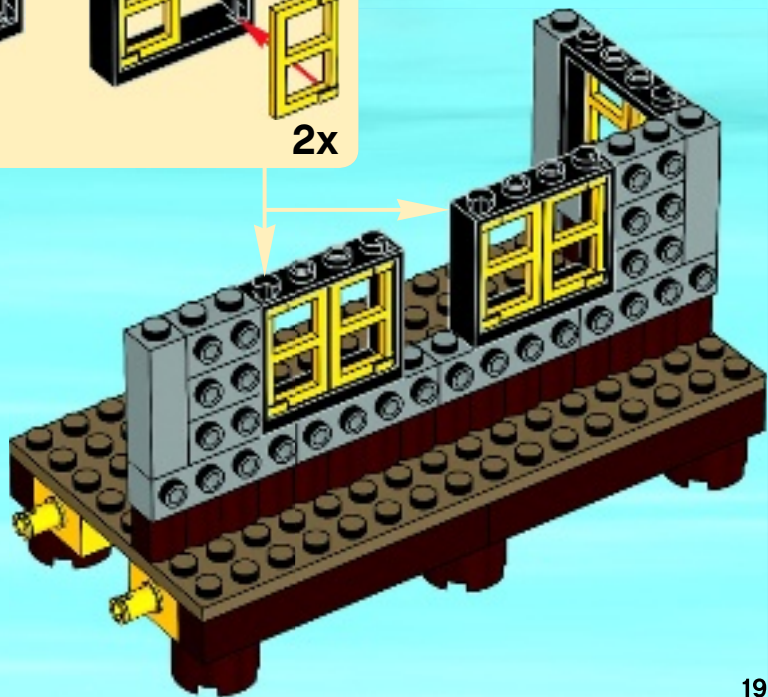
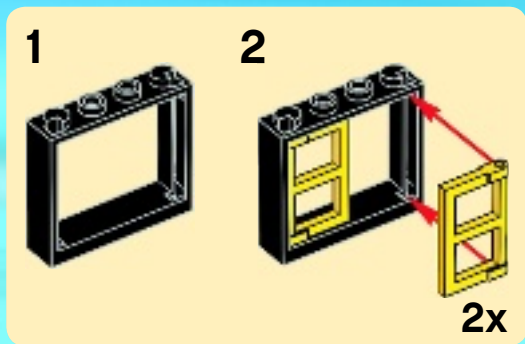



1x



2x

17

1



2

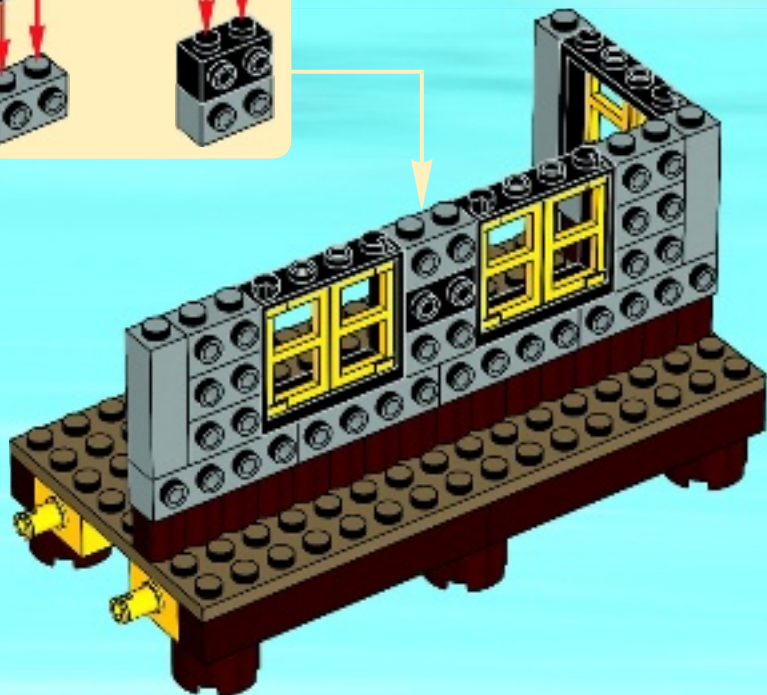
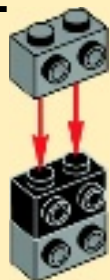



2x

18

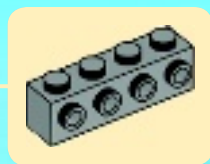
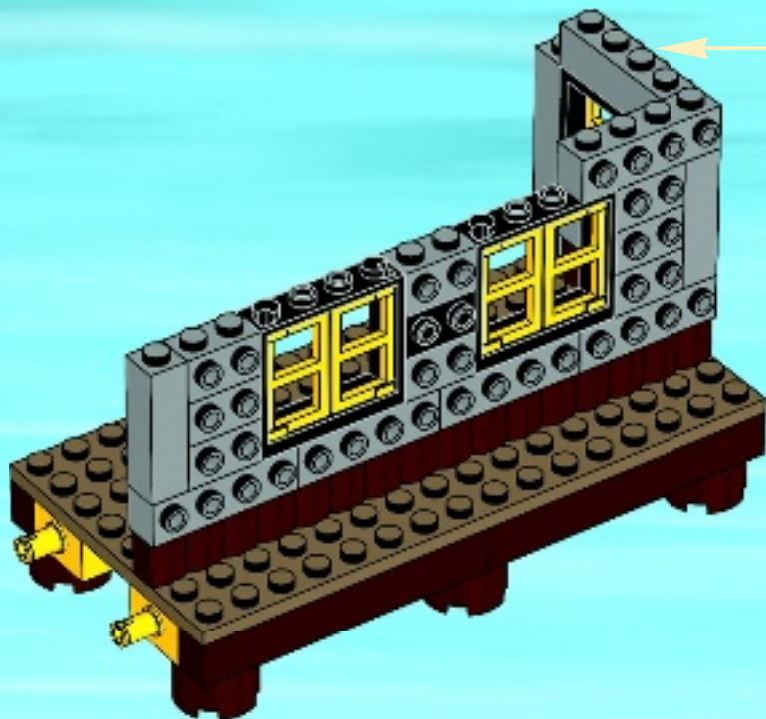



3x

19

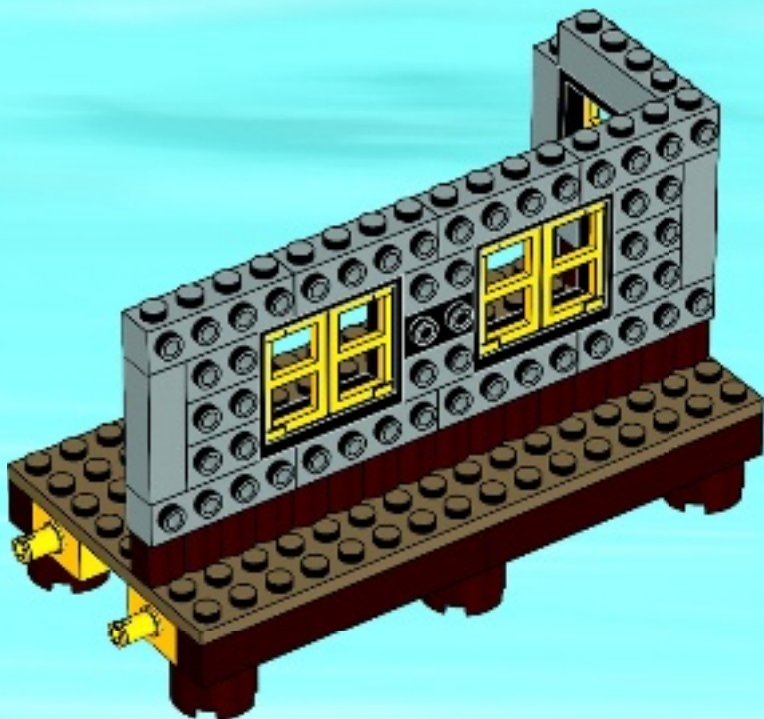

22



1x



20

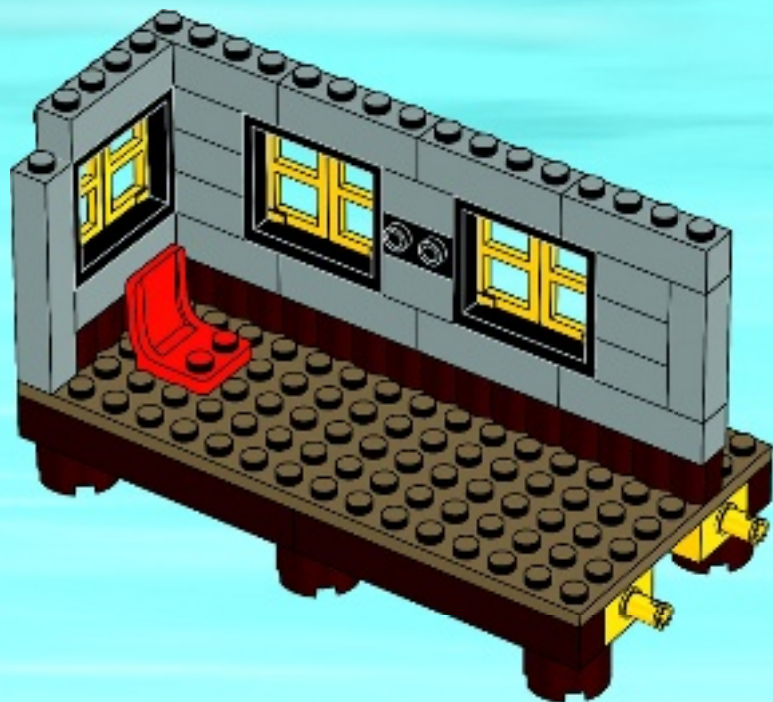



1x



2x

# 21

1



2

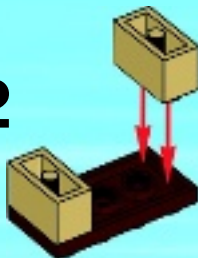

3





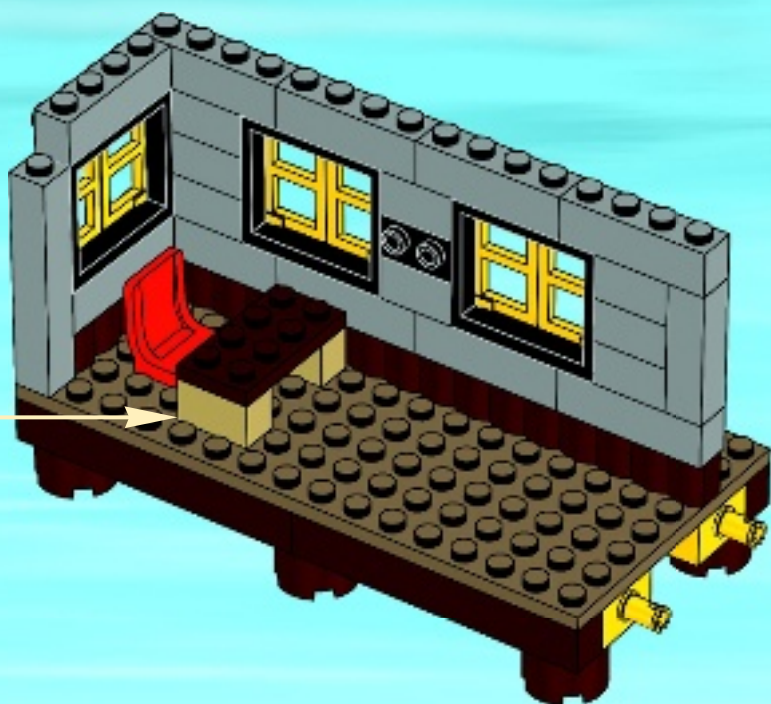



2x



1x

# 22

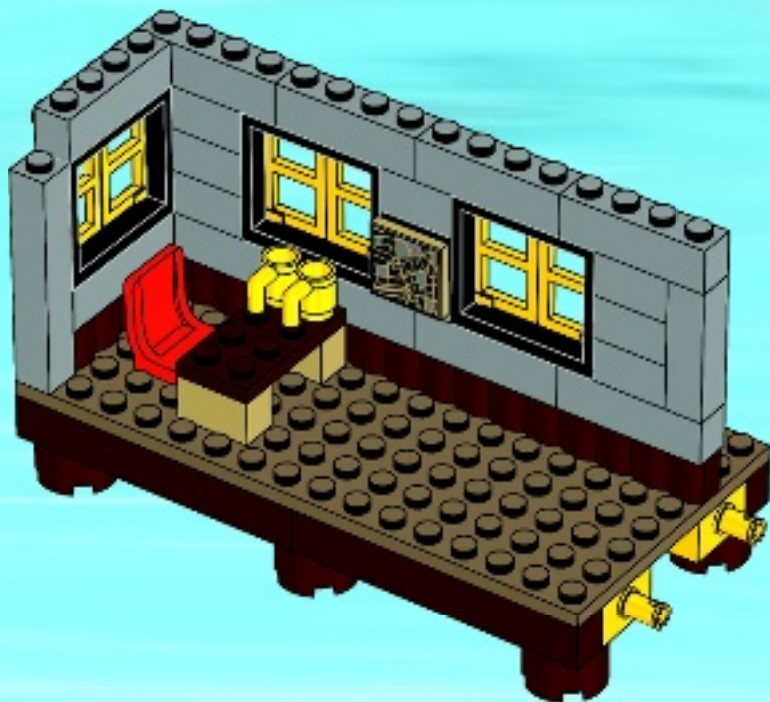



1x



1x

23

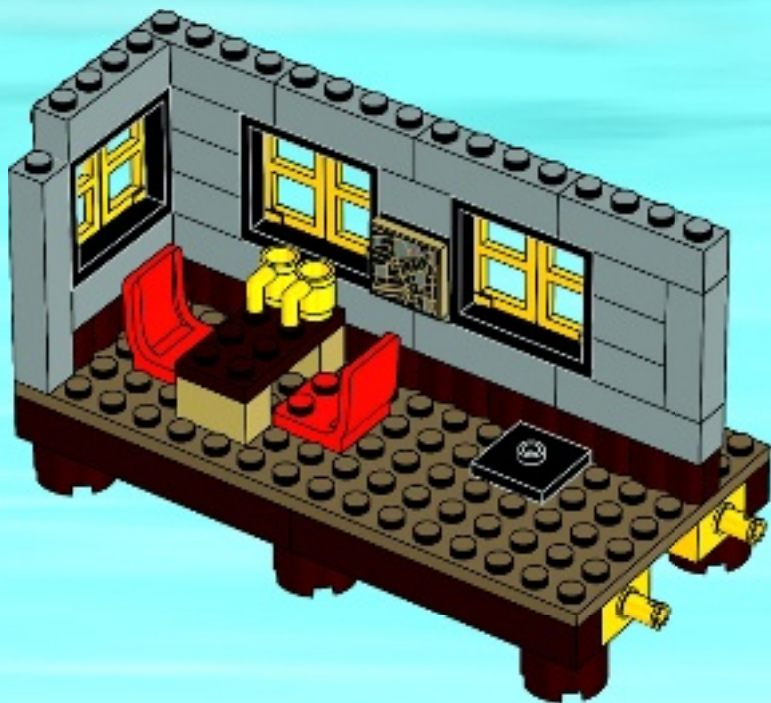



1x



1x



3x

# 24

## 1

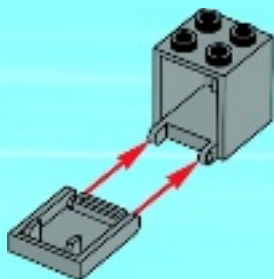

## 2

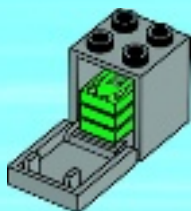

## 3





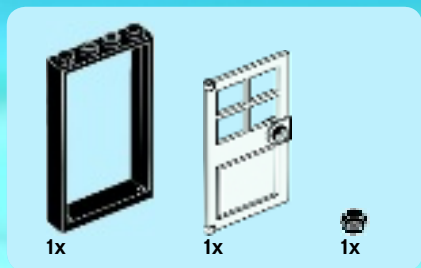

25

1



2

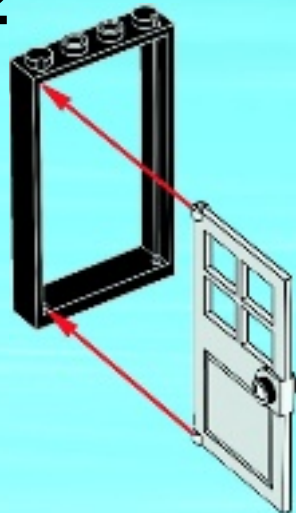

3

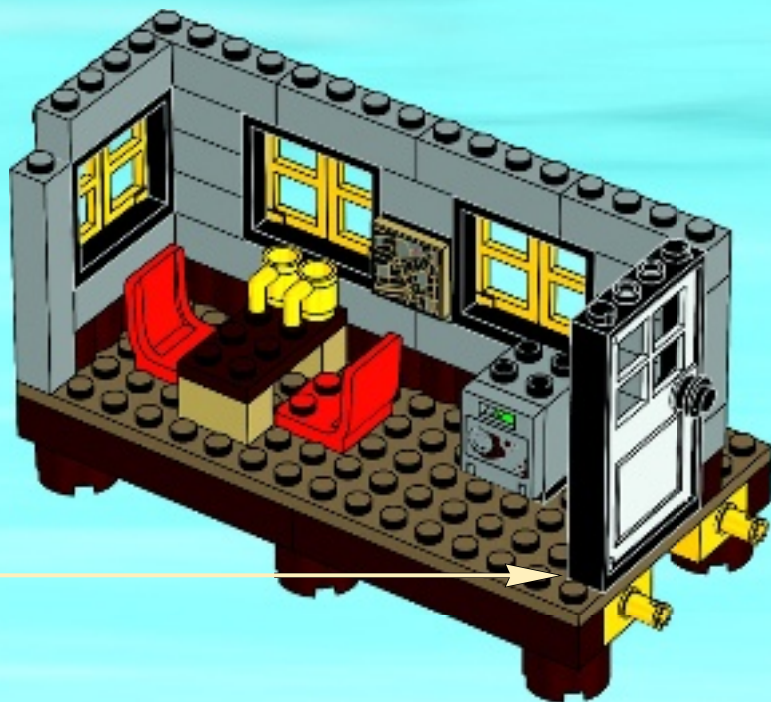



1x

26

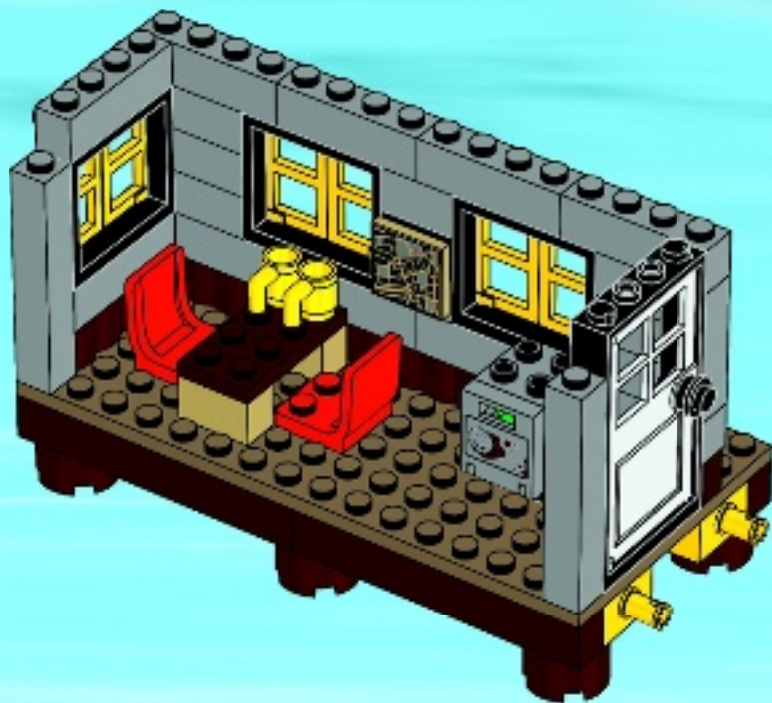



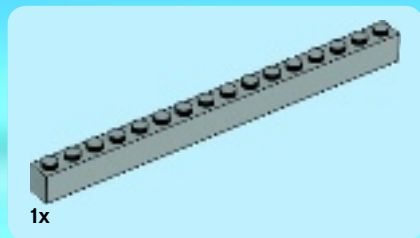

27

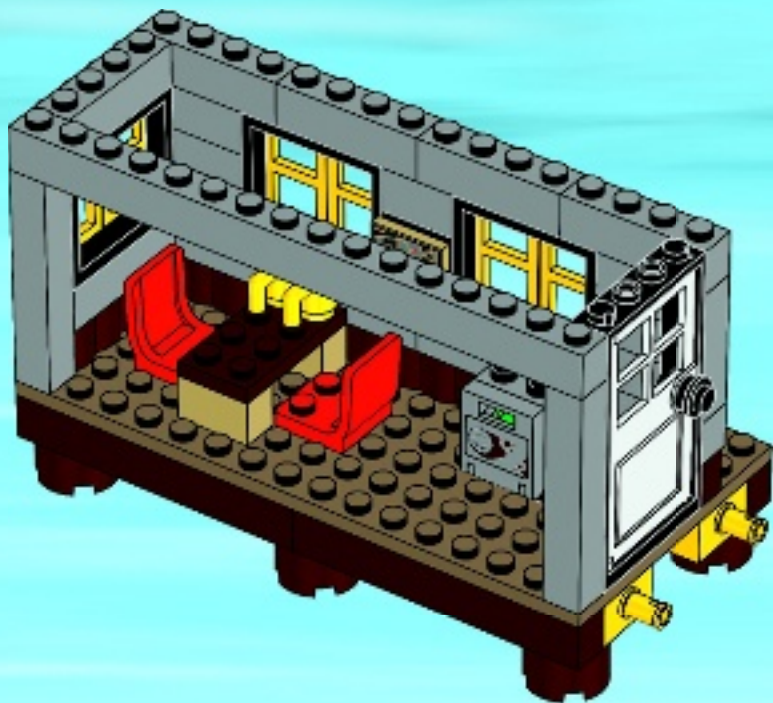



3x

28

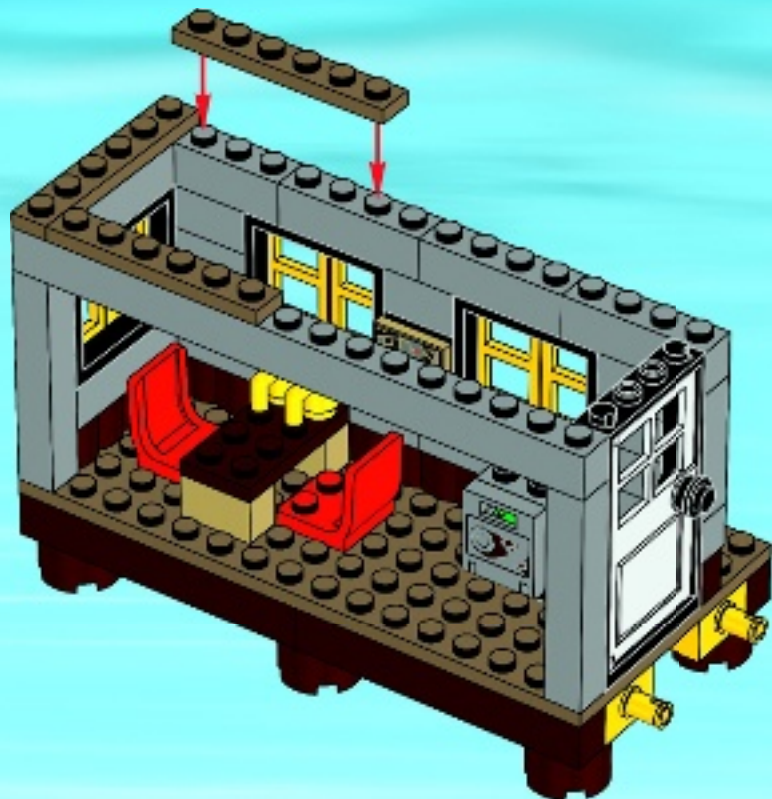



2x

29

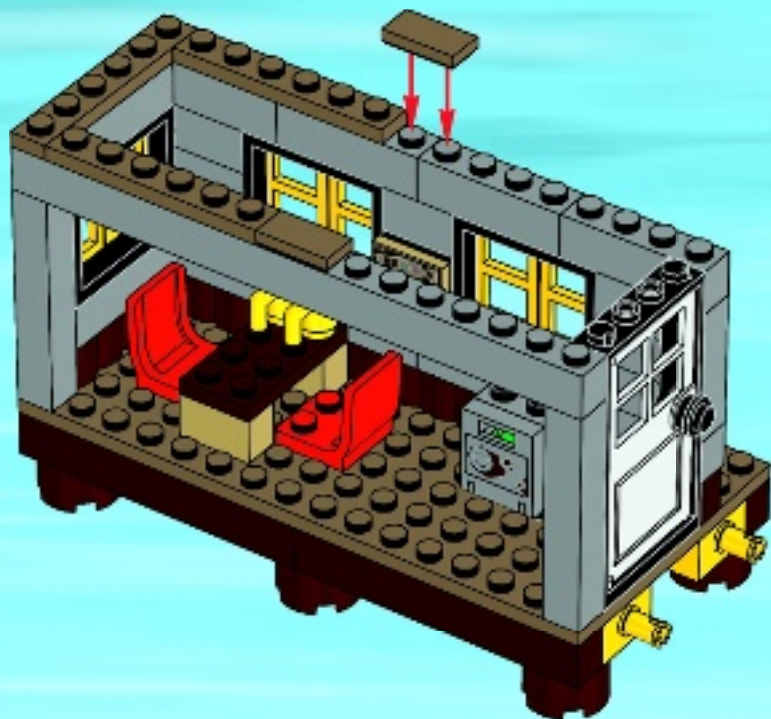



3x

30

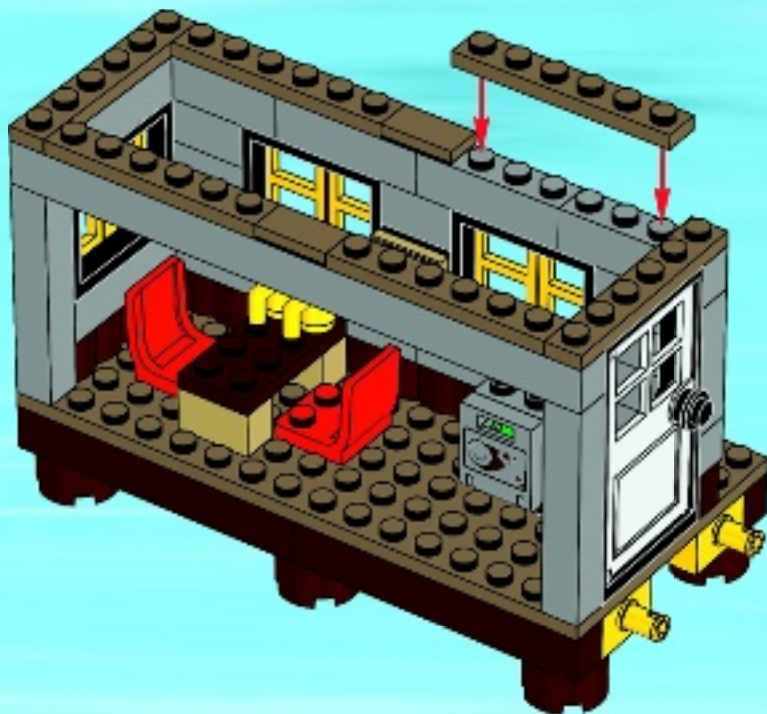

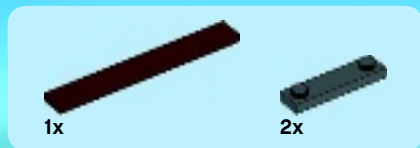

31

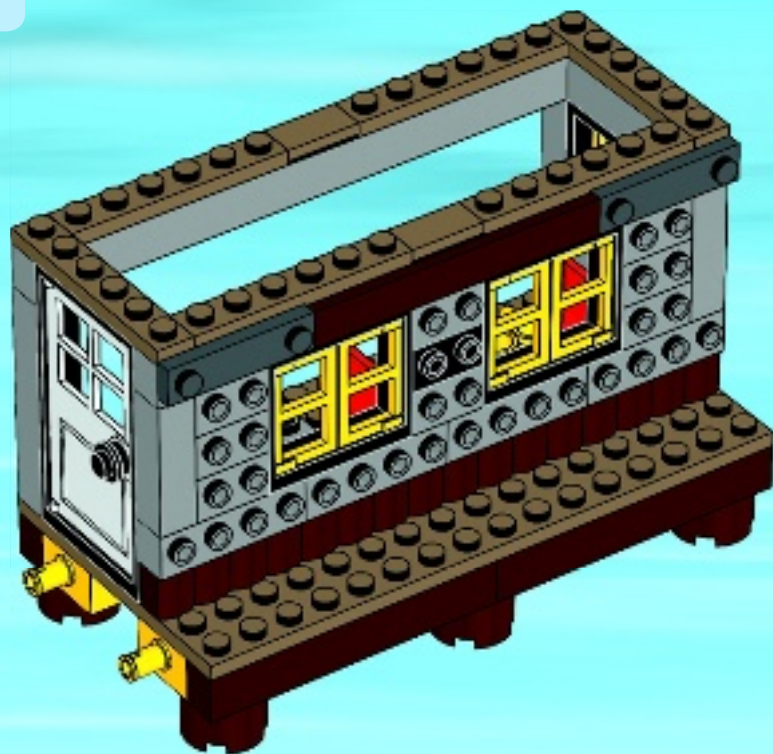



1x



1x



1x

# 32

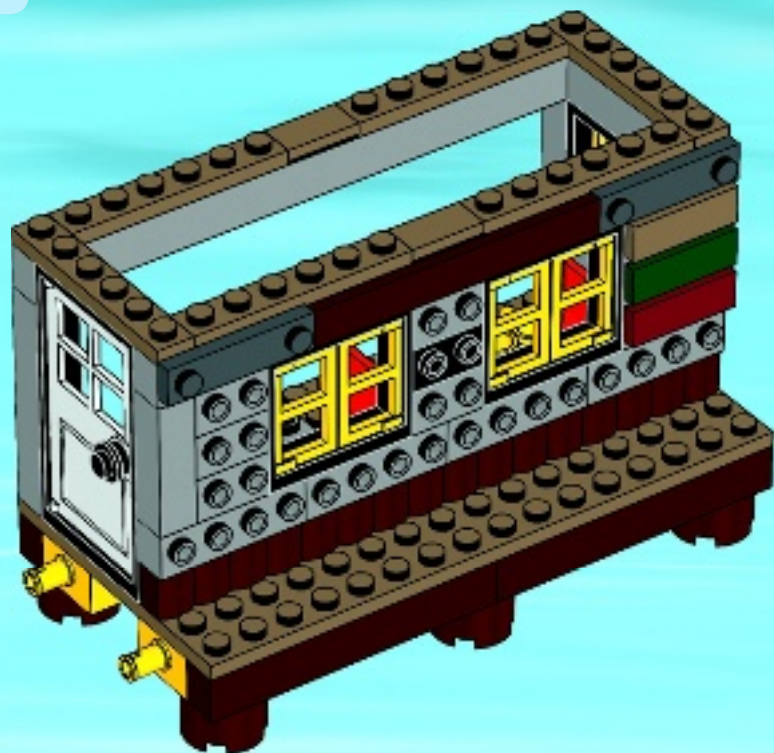



1x



2x

# 33

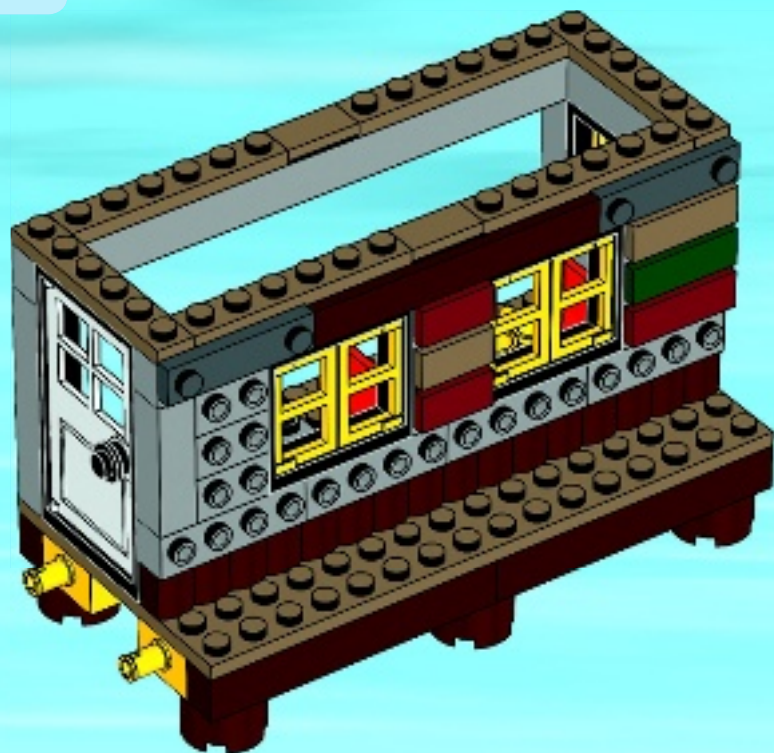



1x



1x



1x

# 34

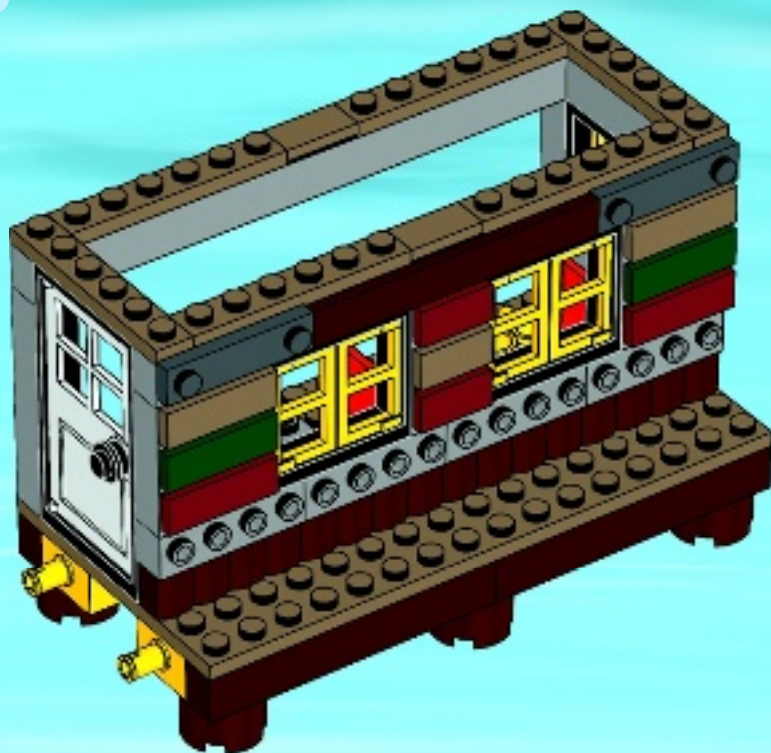





35

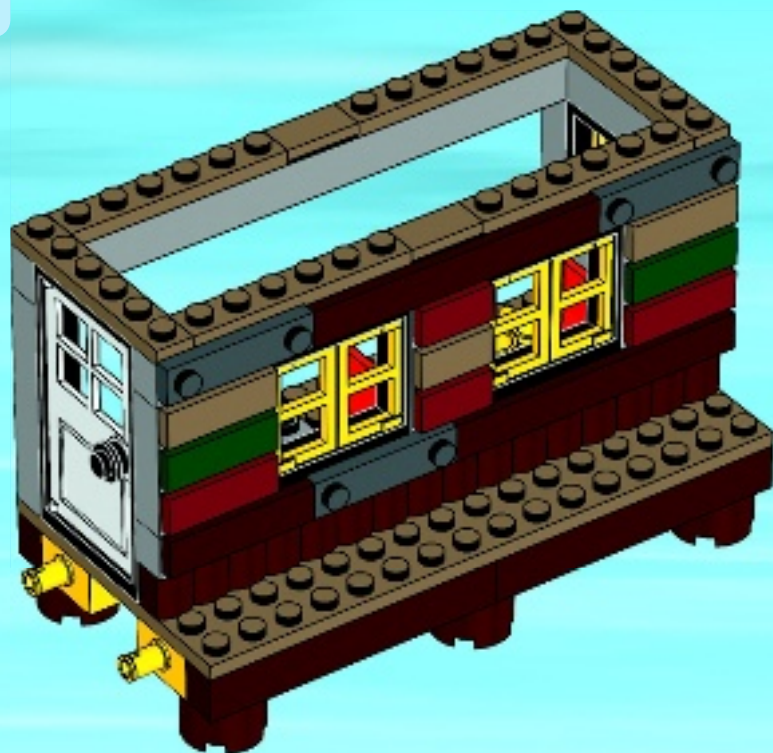



2x

# 36

1



2



2x

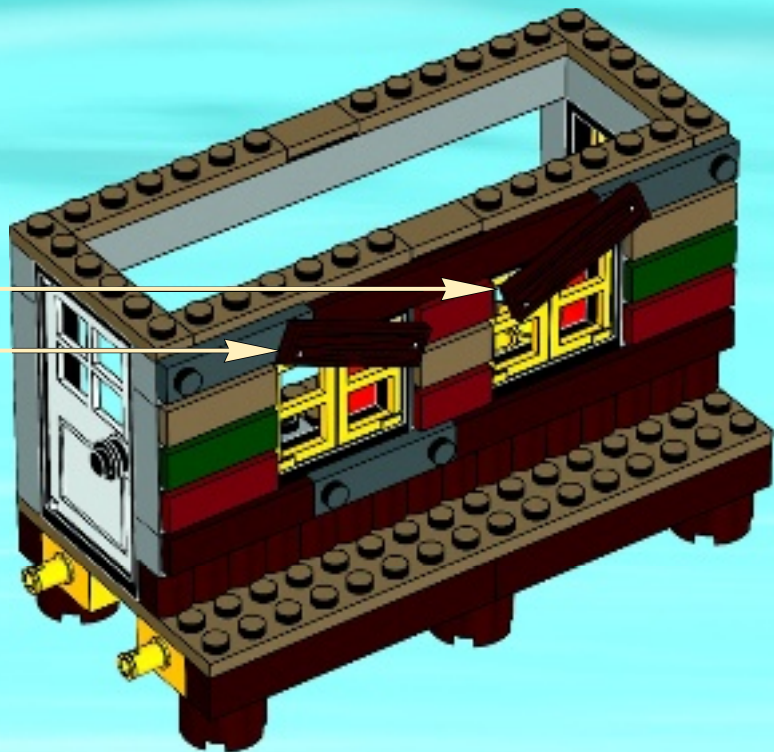



2x

37

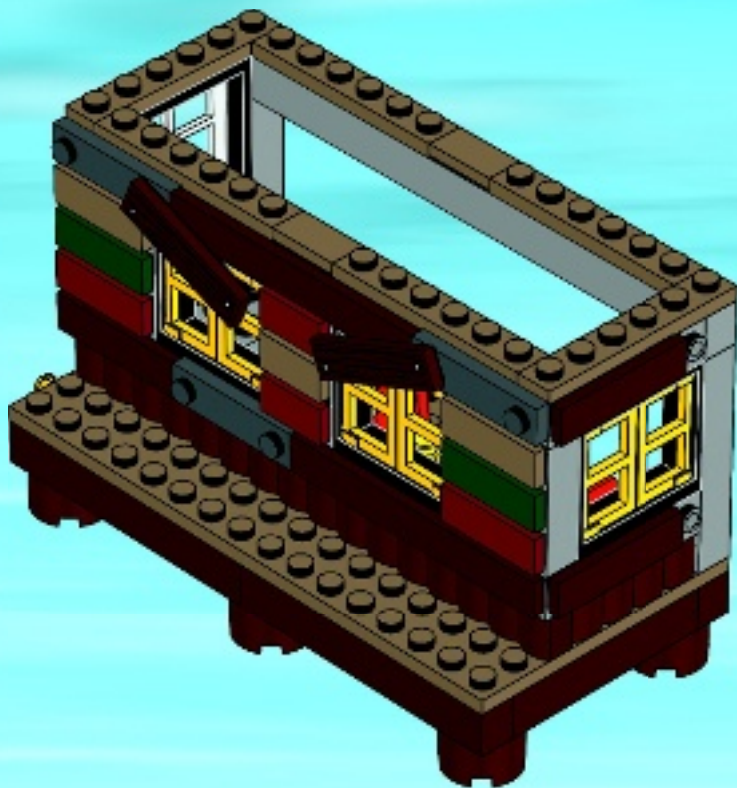



1x



1x

# 38

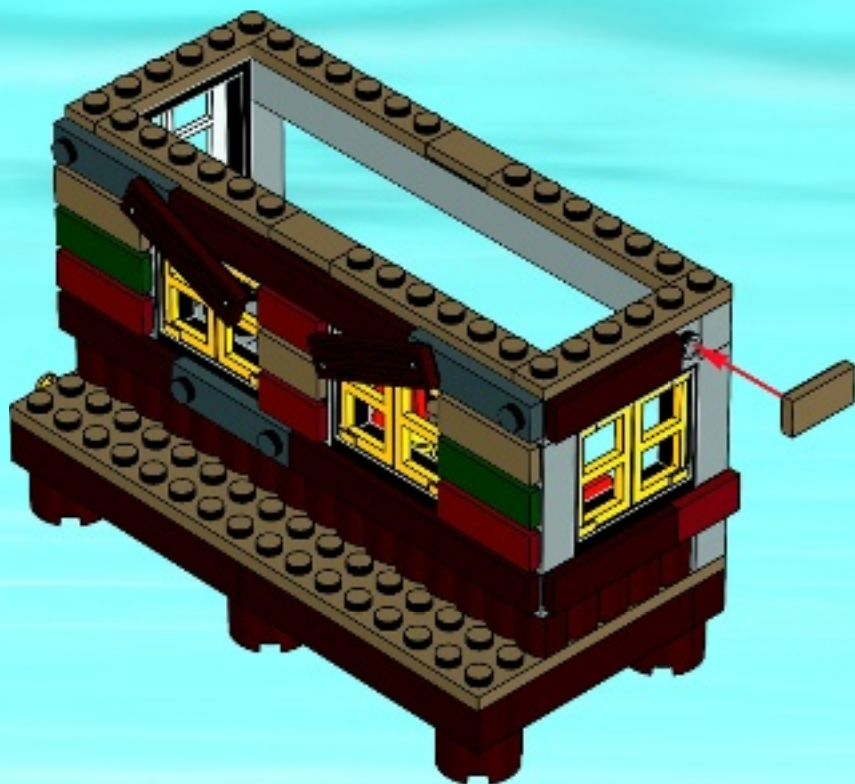

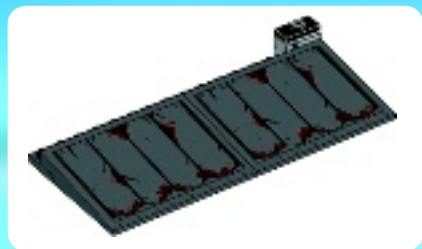

1x

**1**

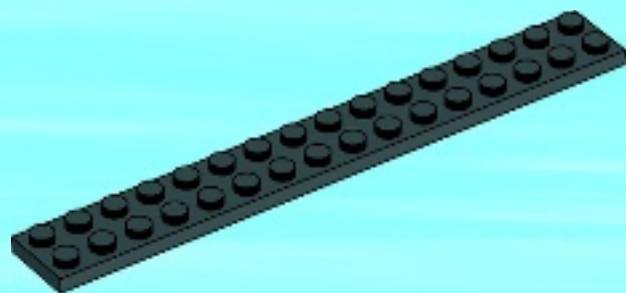



1x



1x

2

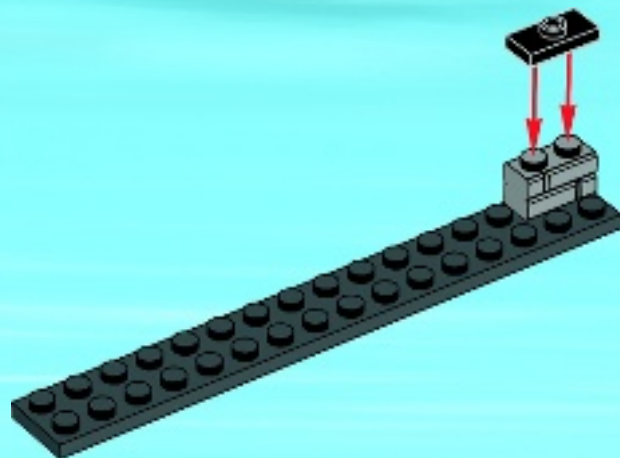

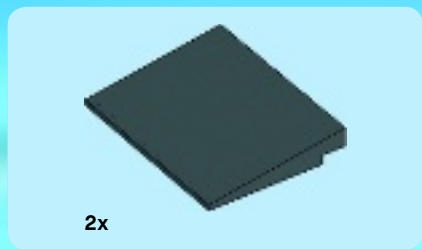

3

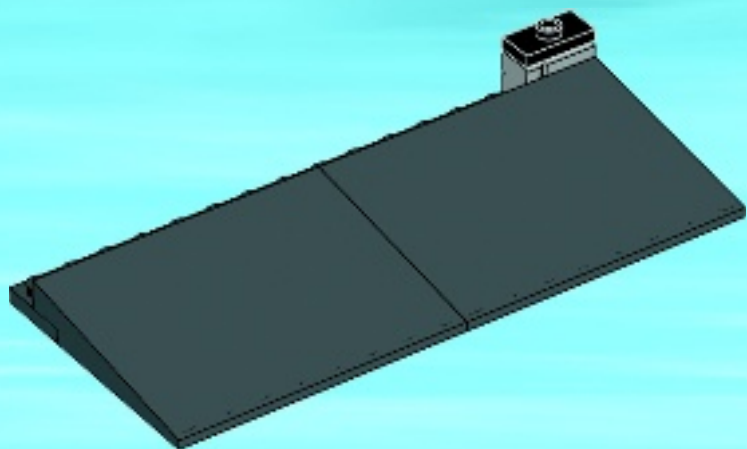

4

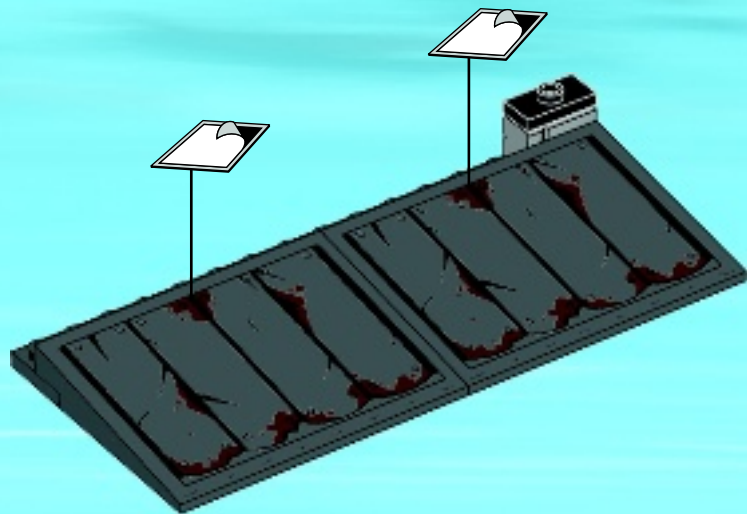



39





# 40

1



2



3



4



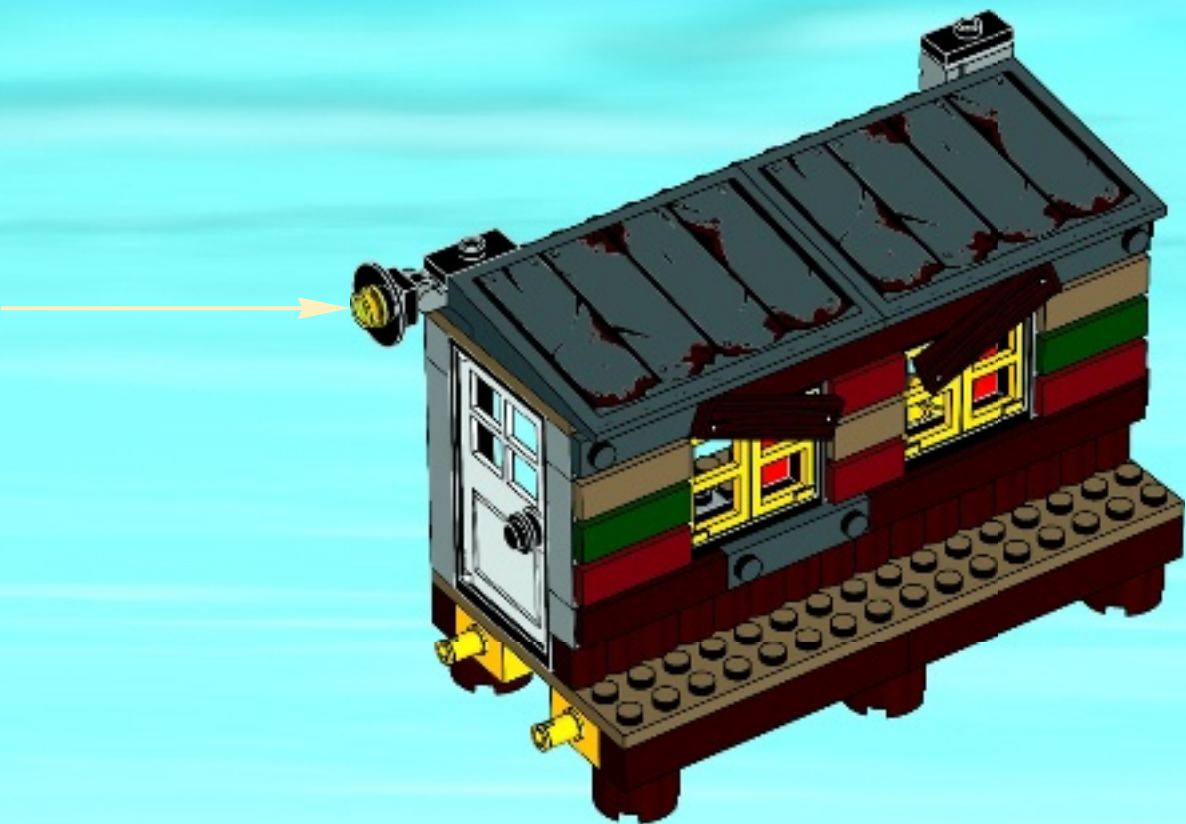



3x

41



52

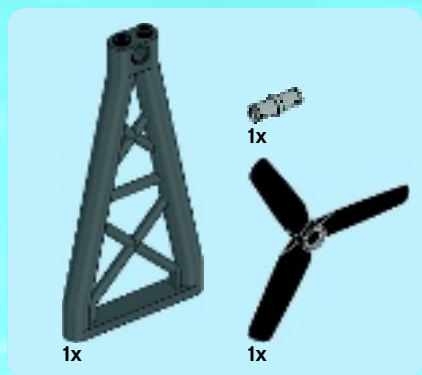

42

1



2





43

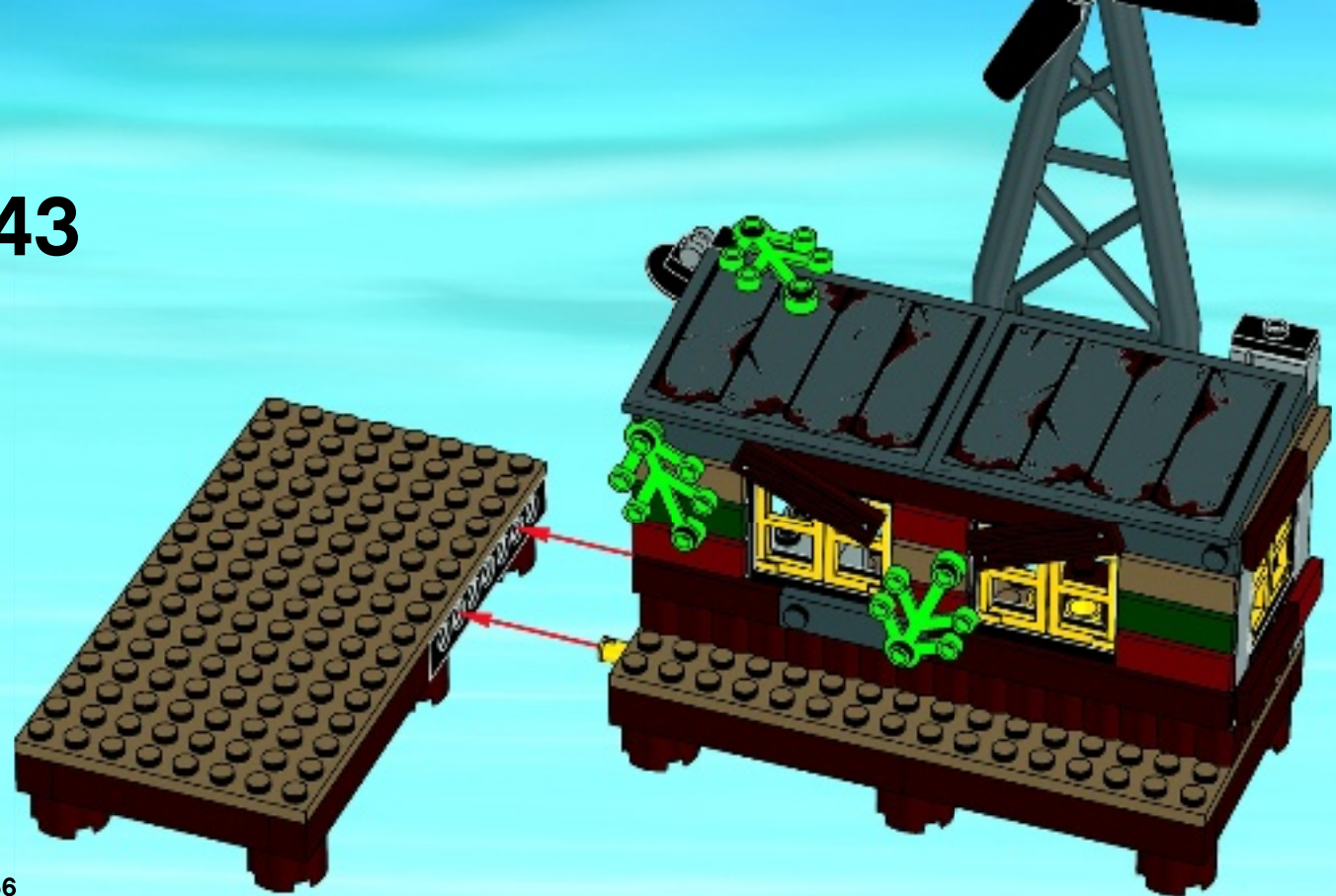





4x

44





1x



1x

# 45

1



2



3





