

44010-44011

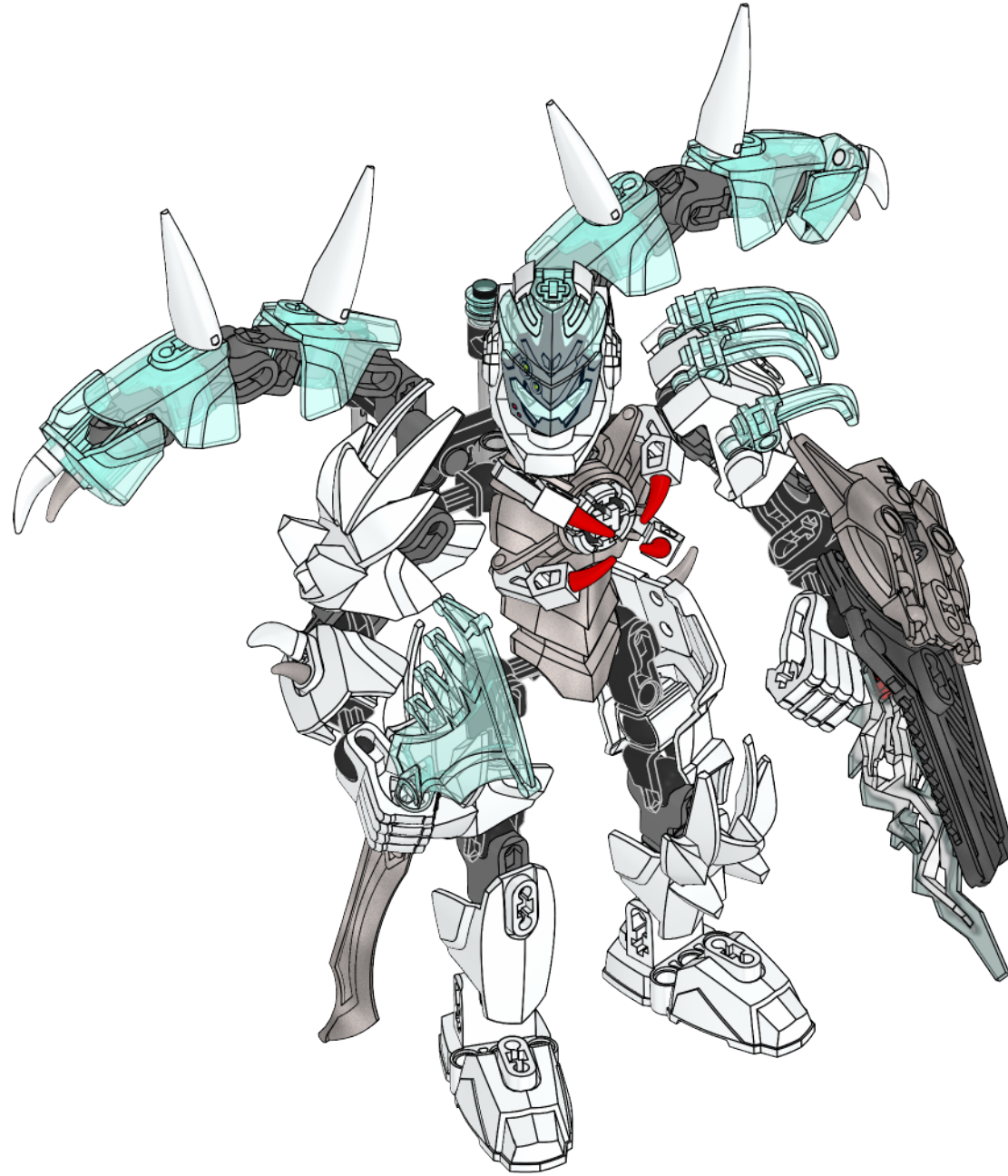

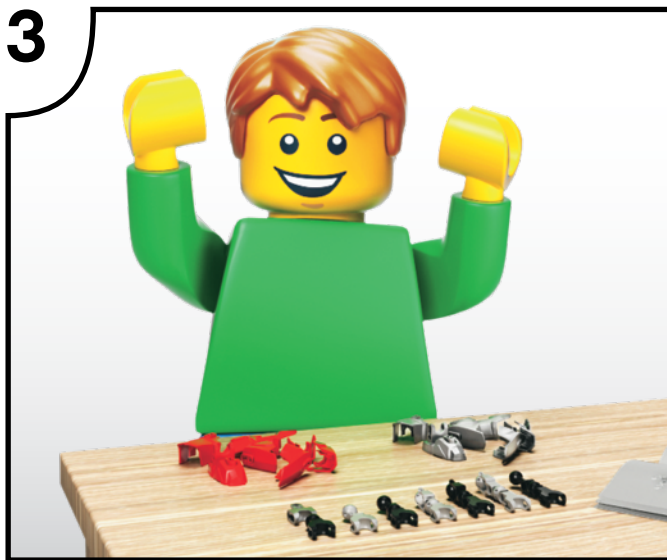

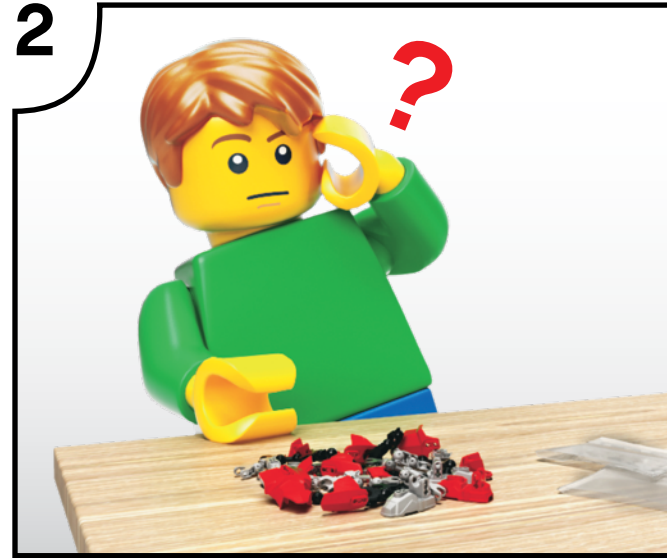
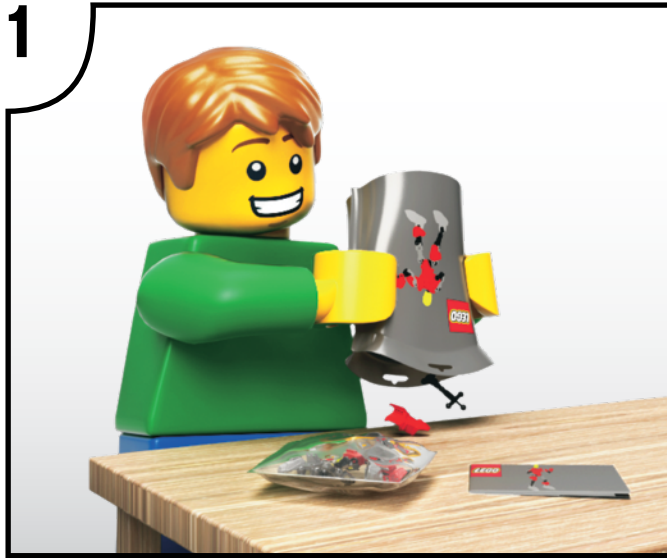
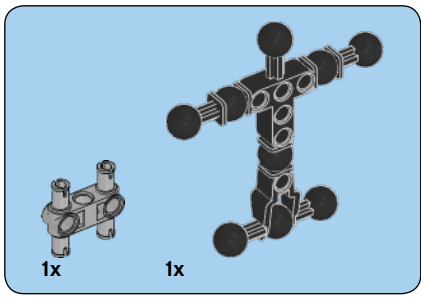

1

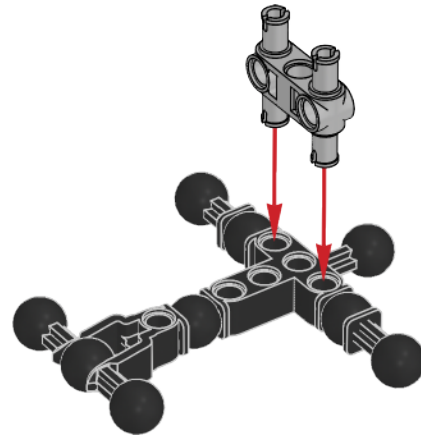

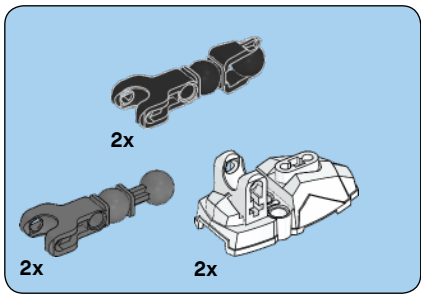

**2**

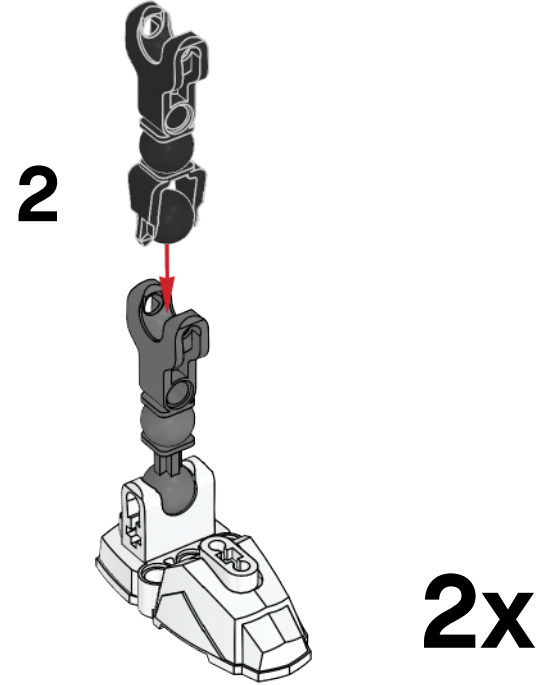
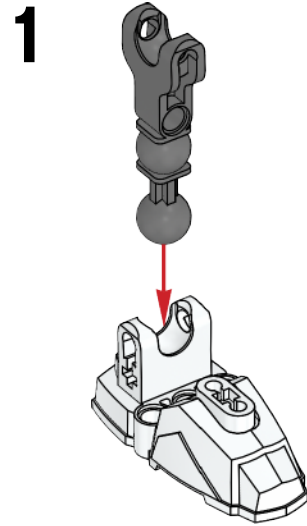

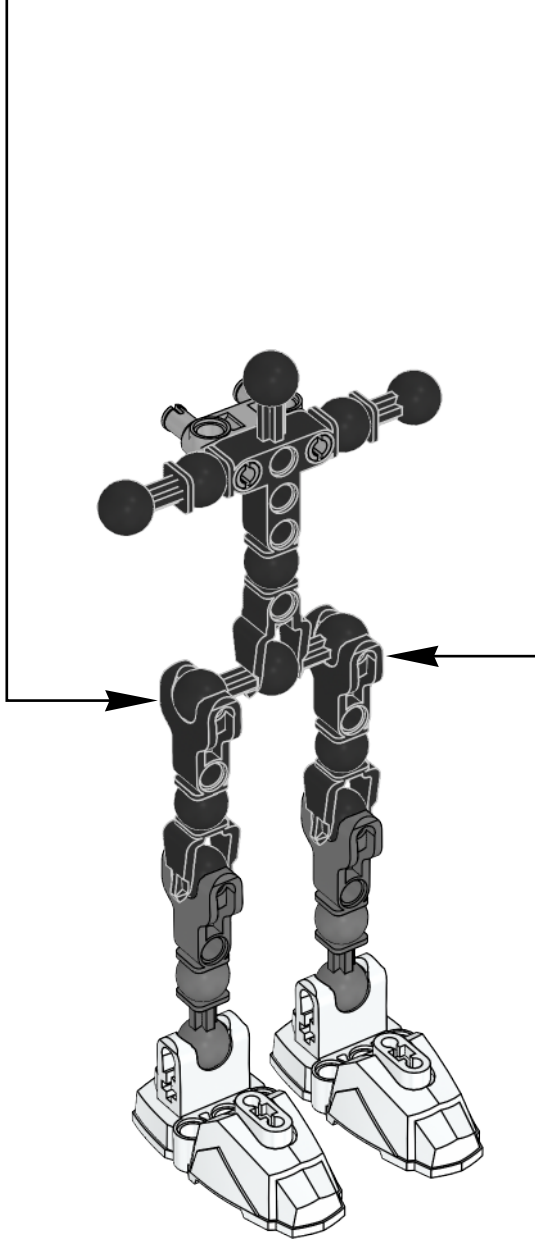

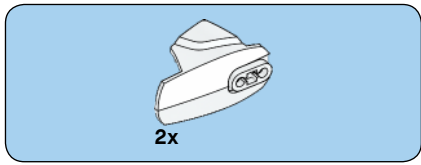

3

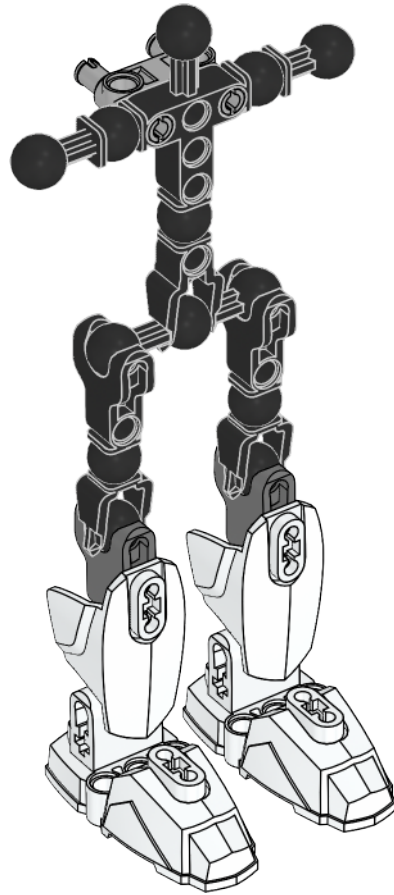

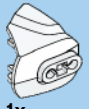

1x

4

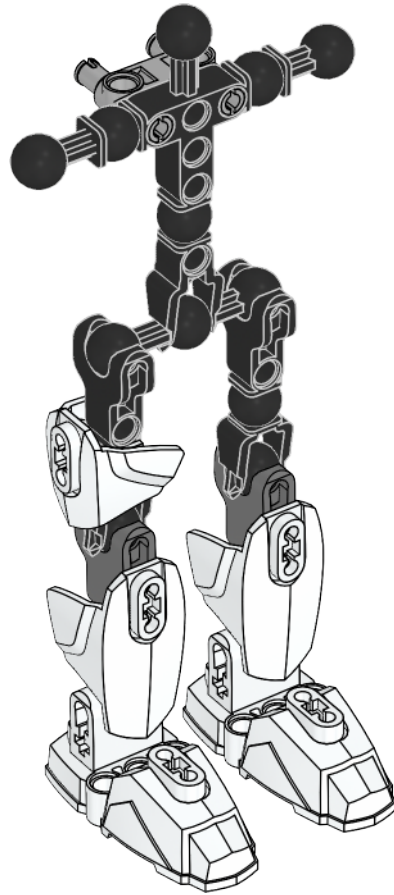

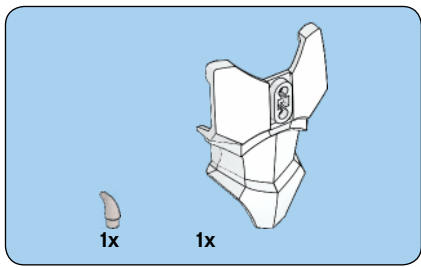

5

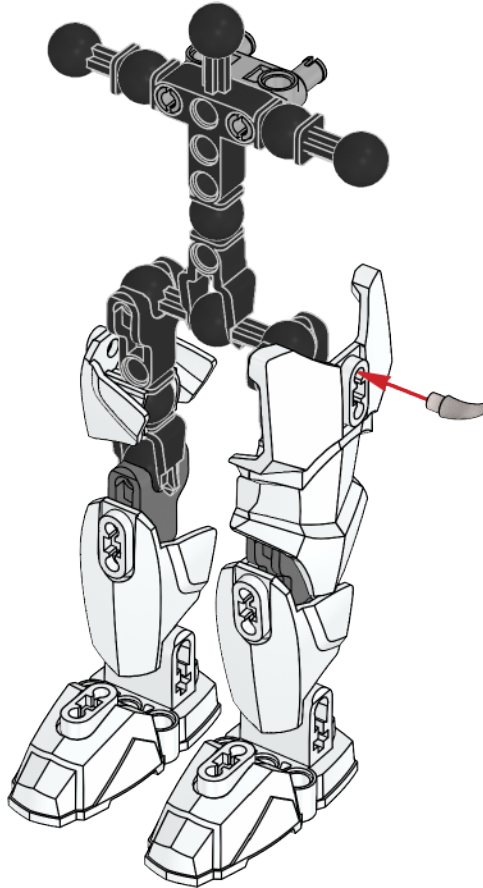



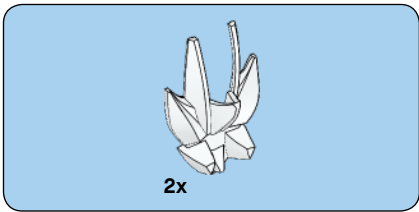

6

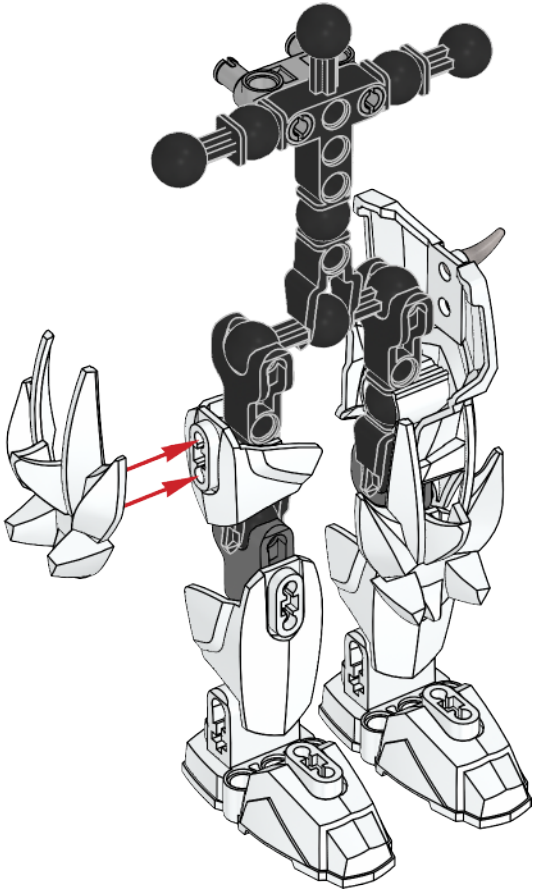

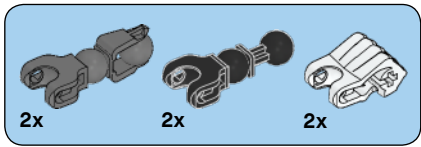

7

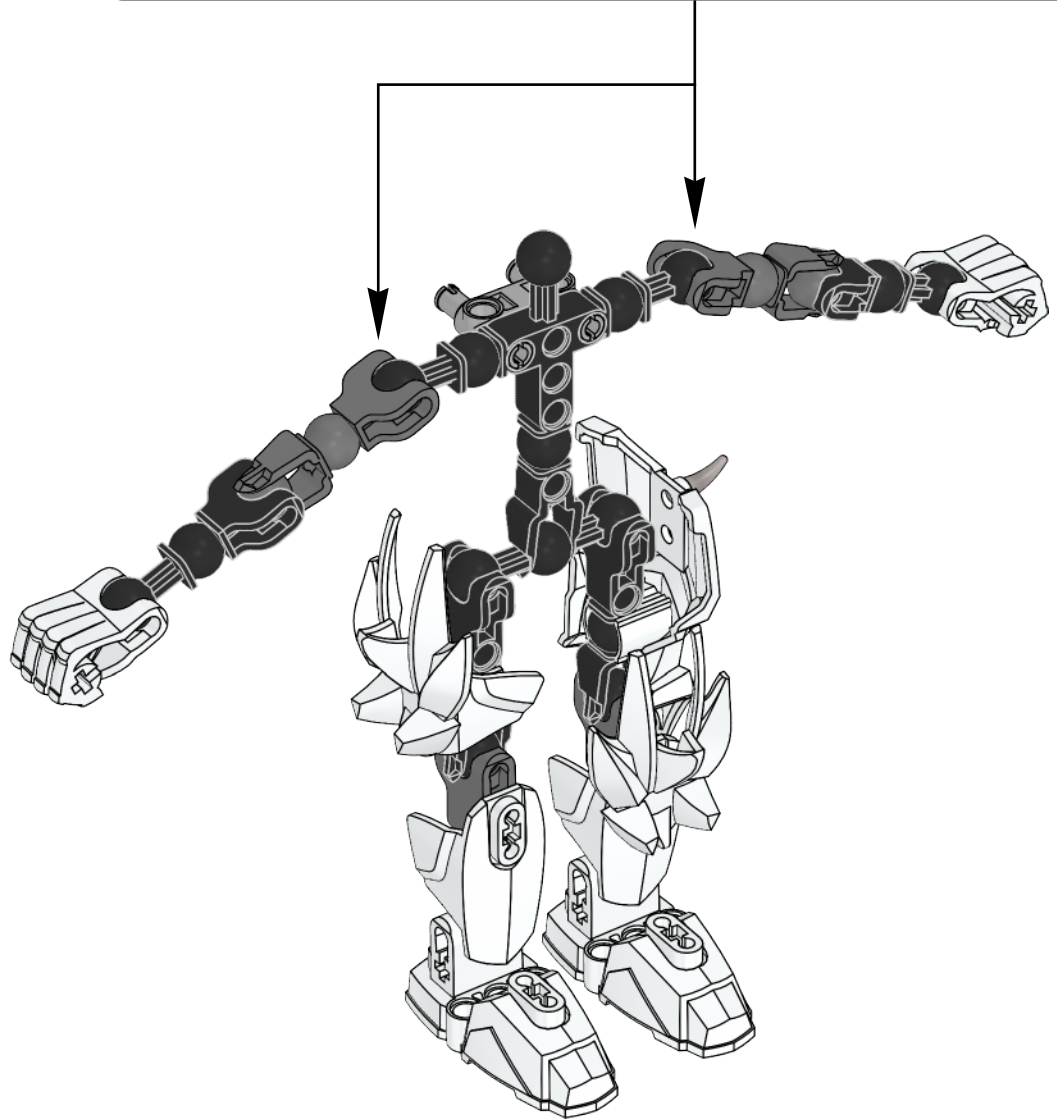
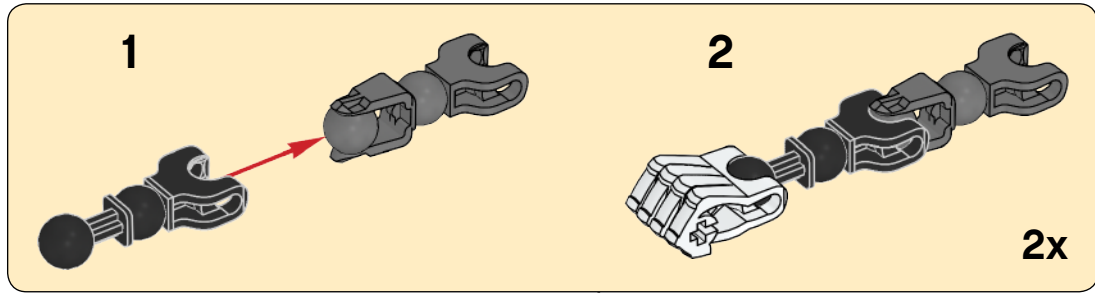

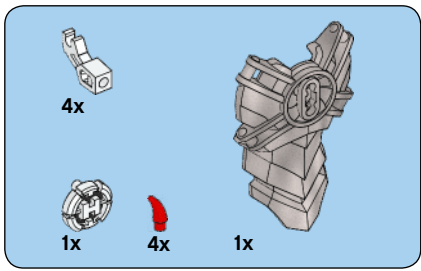

8

1

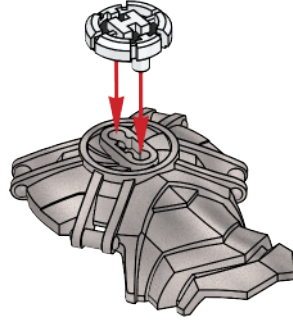

2

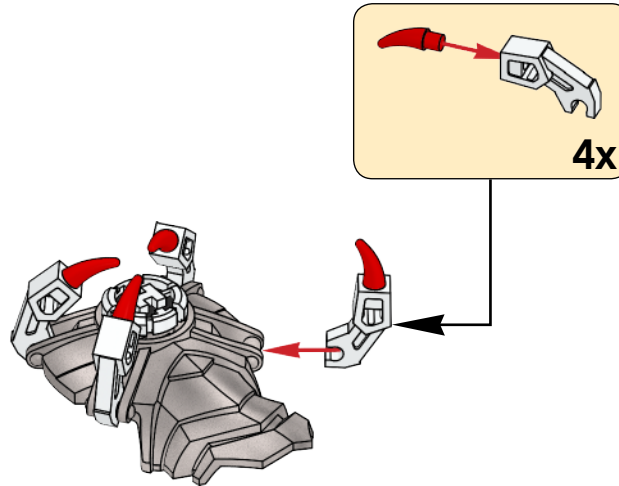

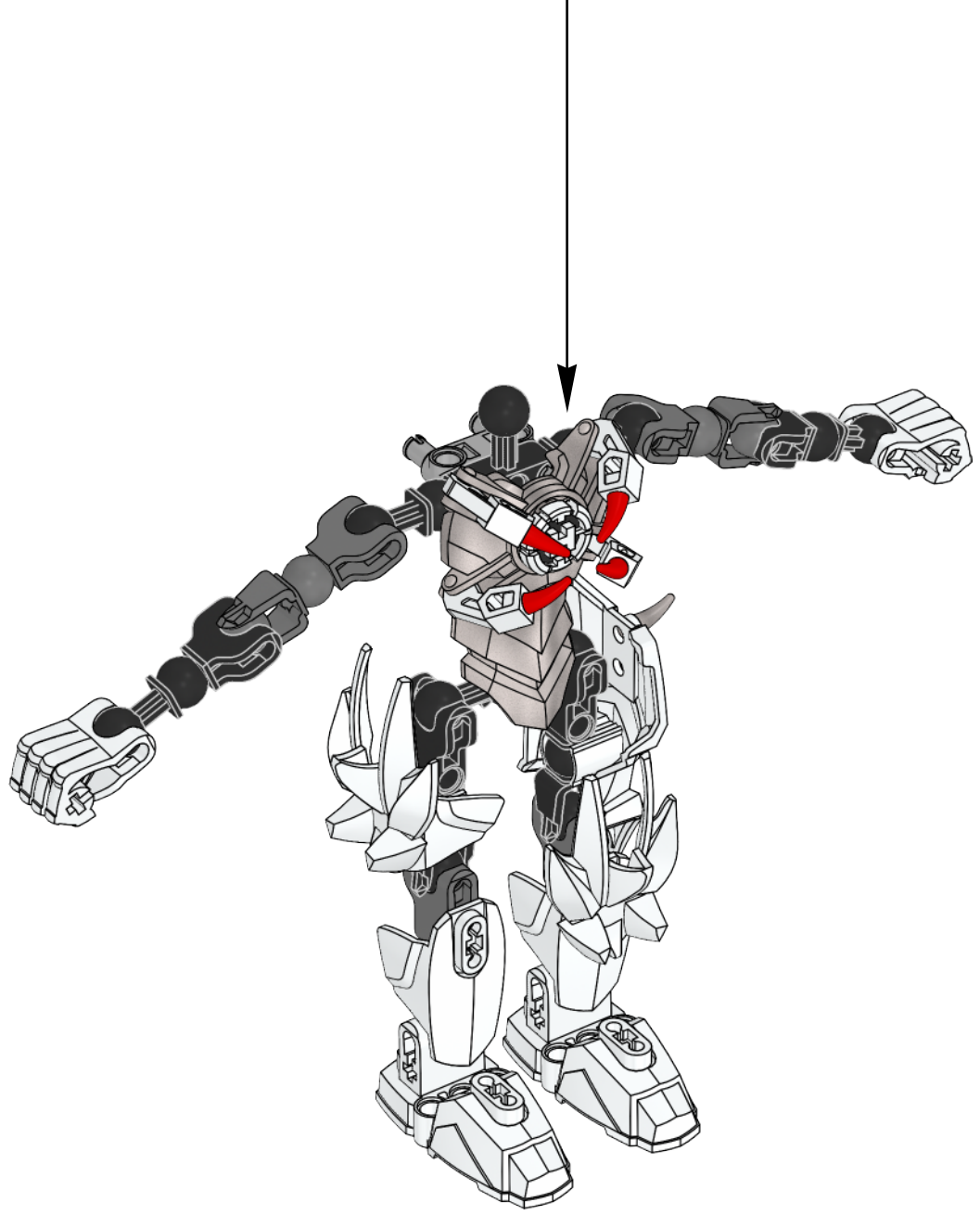

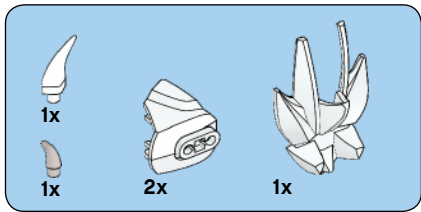

9

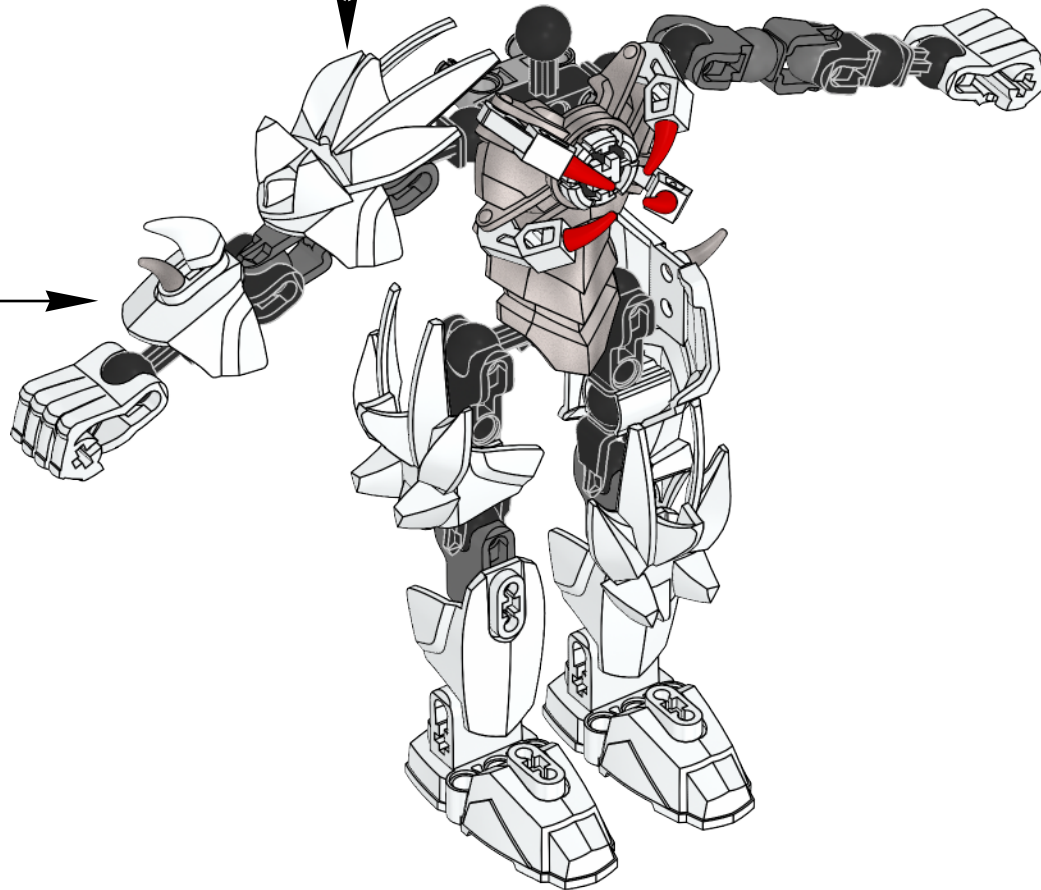
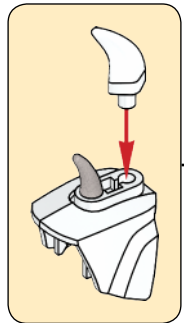
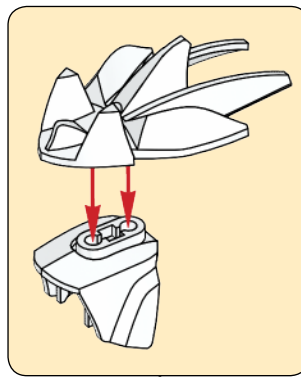

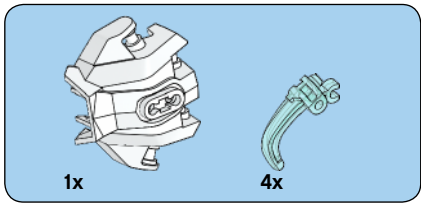

# 10

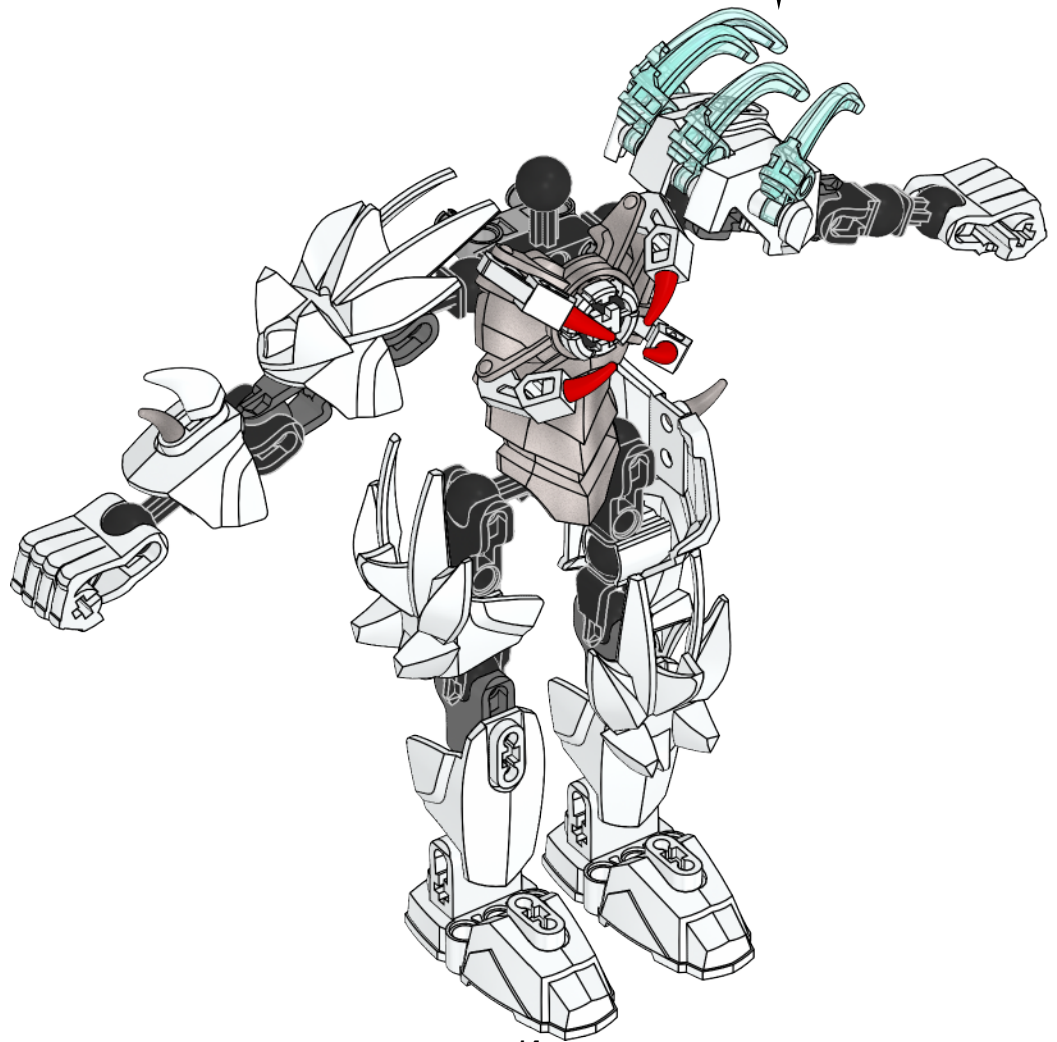
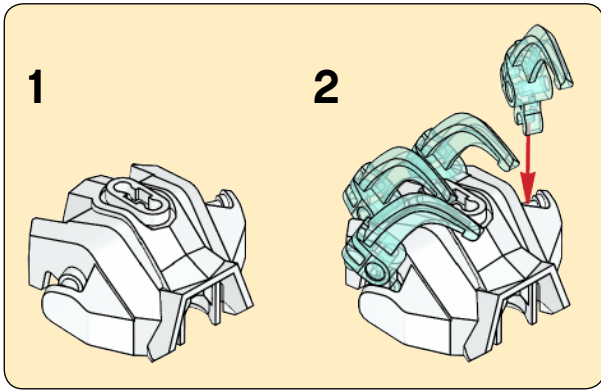

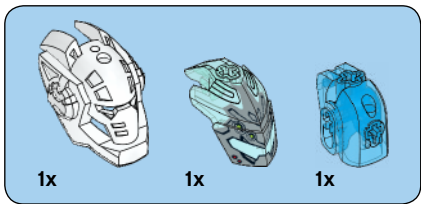

11

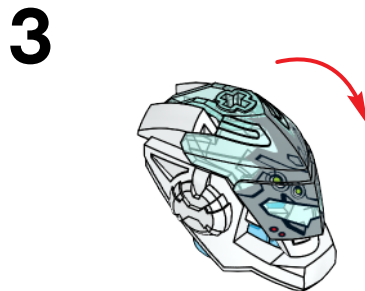
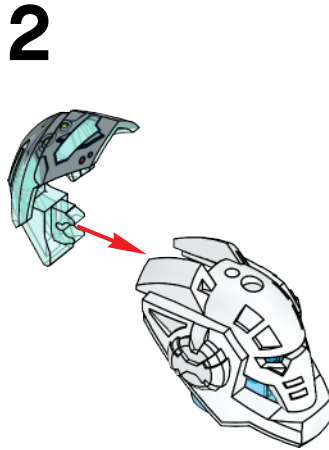
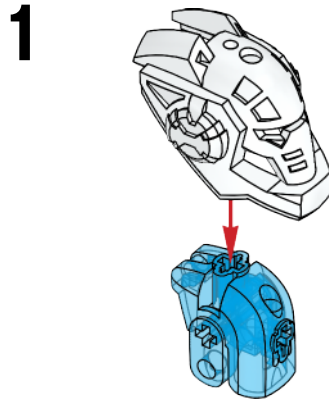

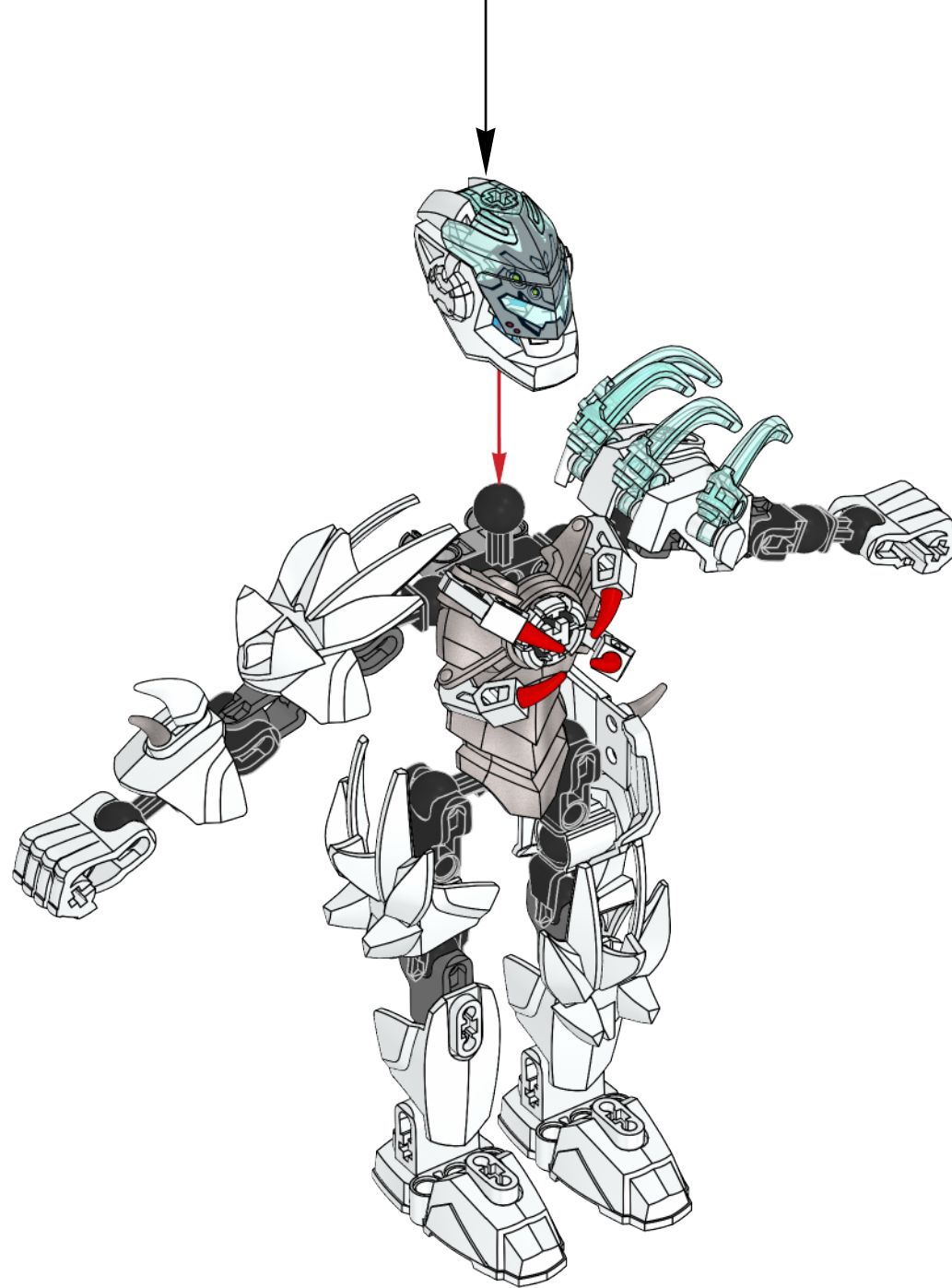



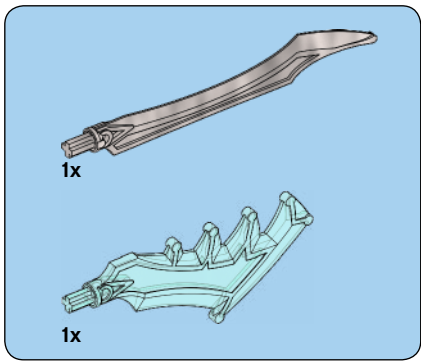

12

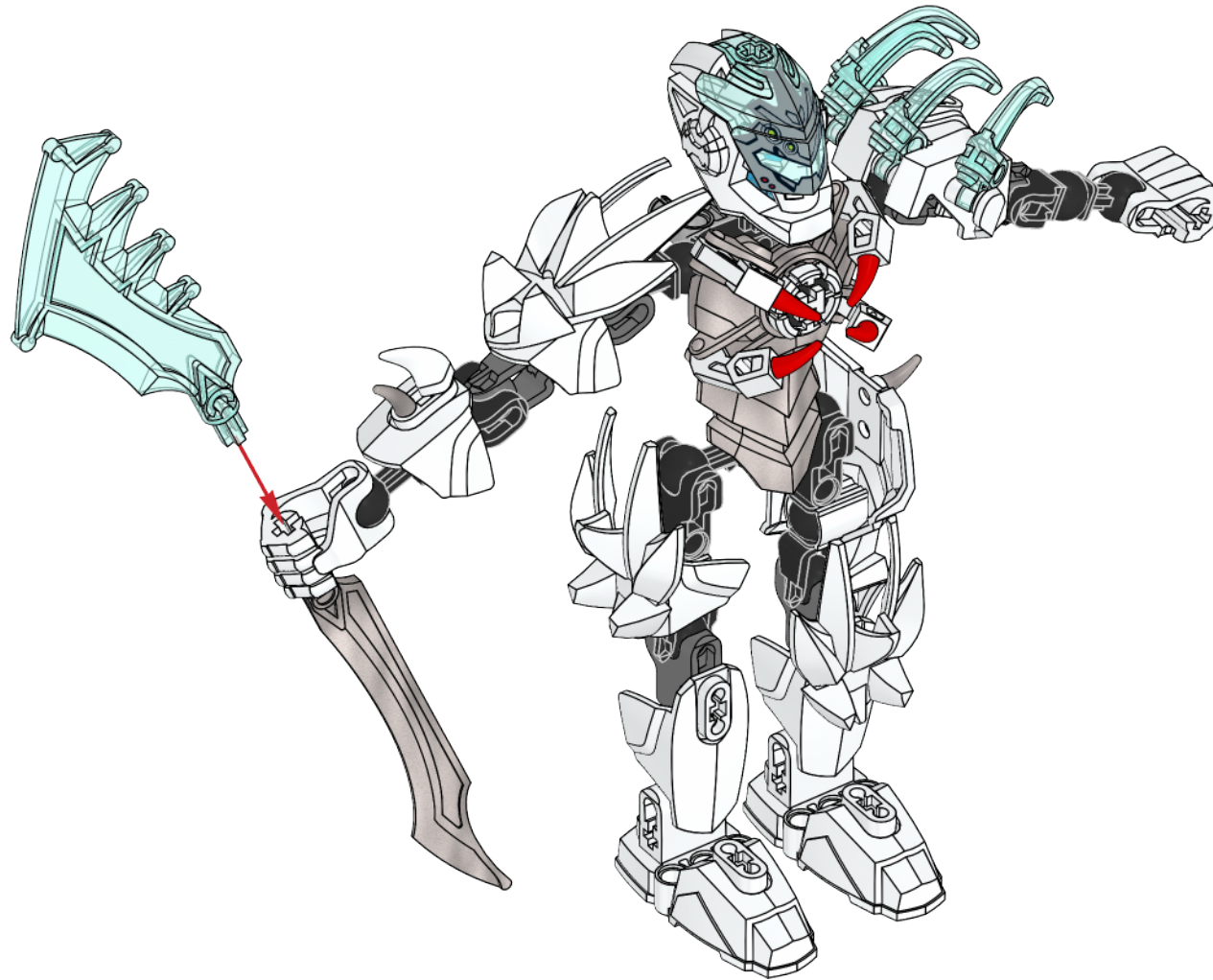

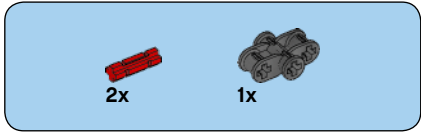
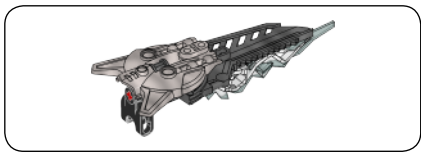

1

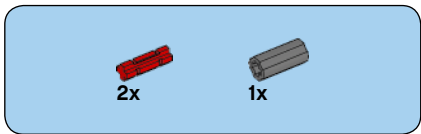
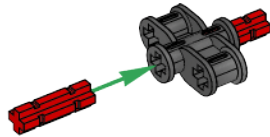

2

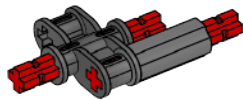
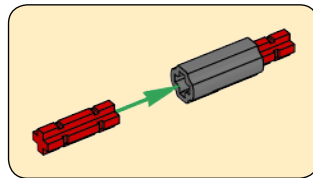

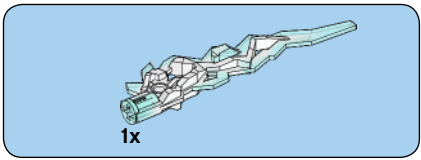

3

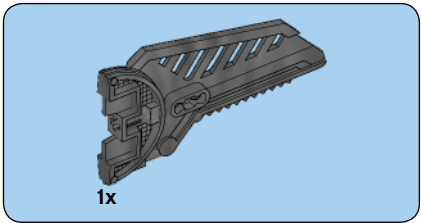
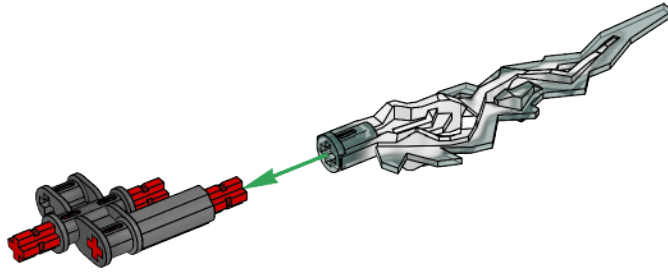

4

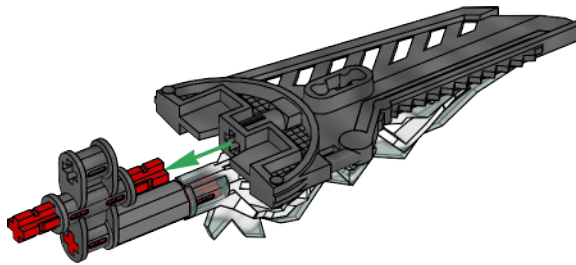
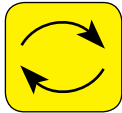

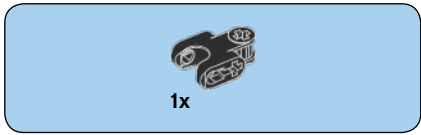

5

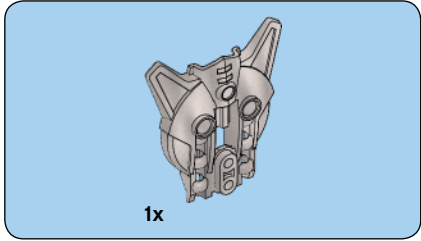
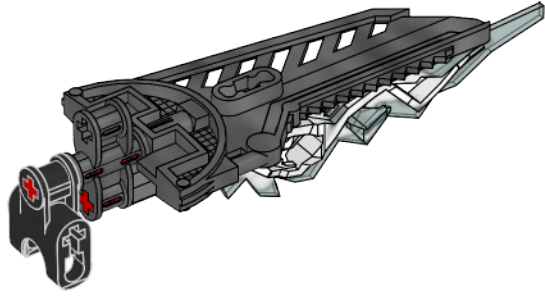

6

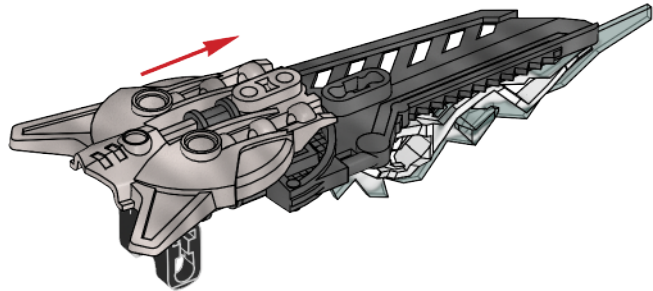

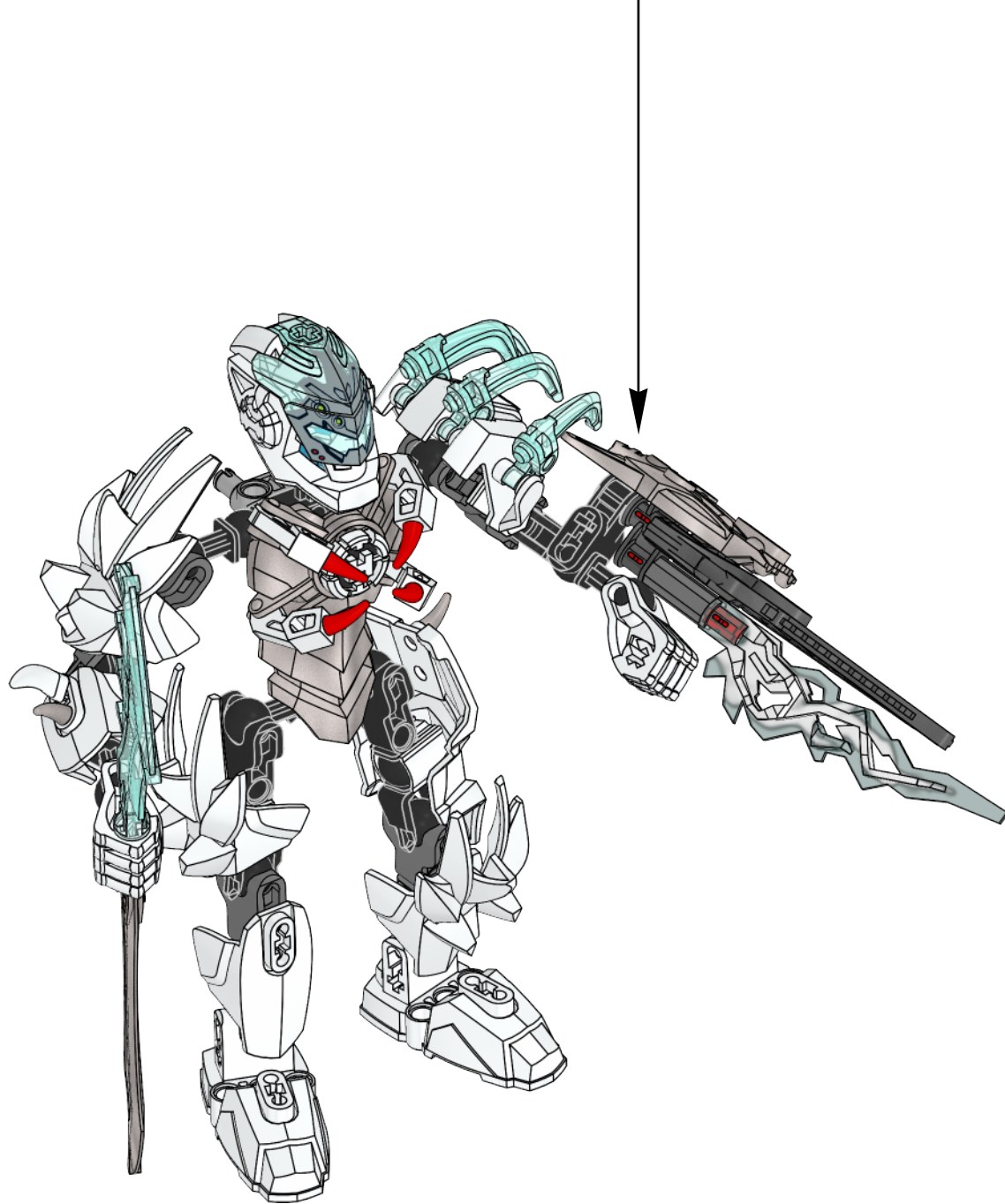

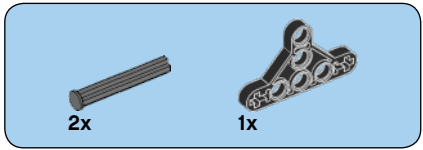
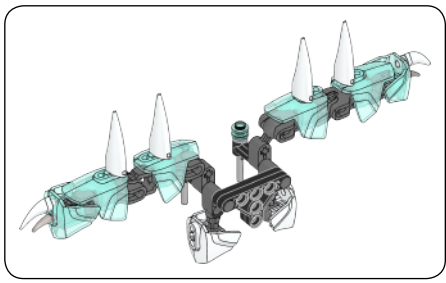

1

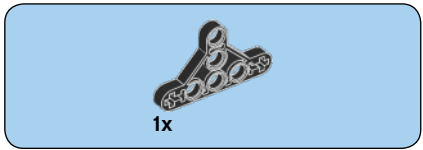
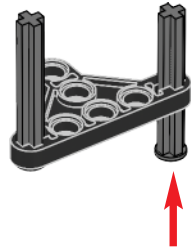

2

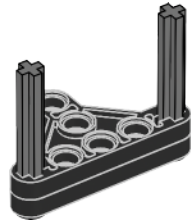

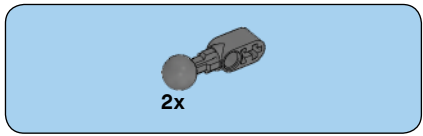

3

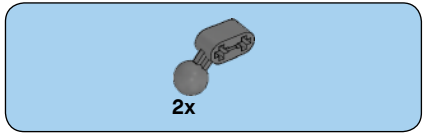
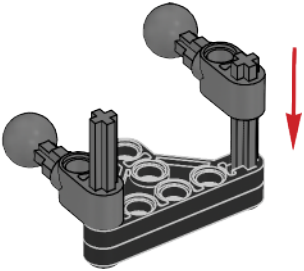

4

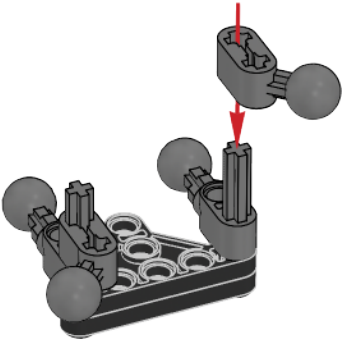



2x

5

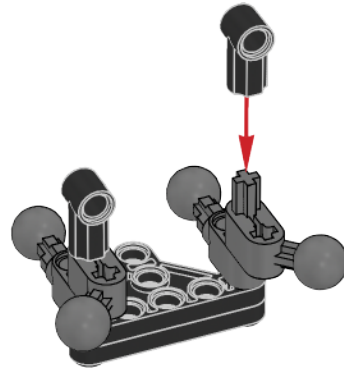



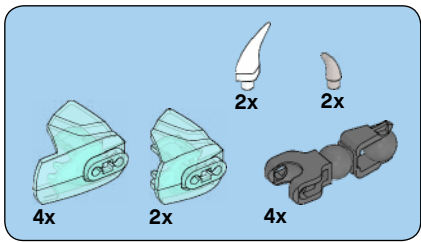

6

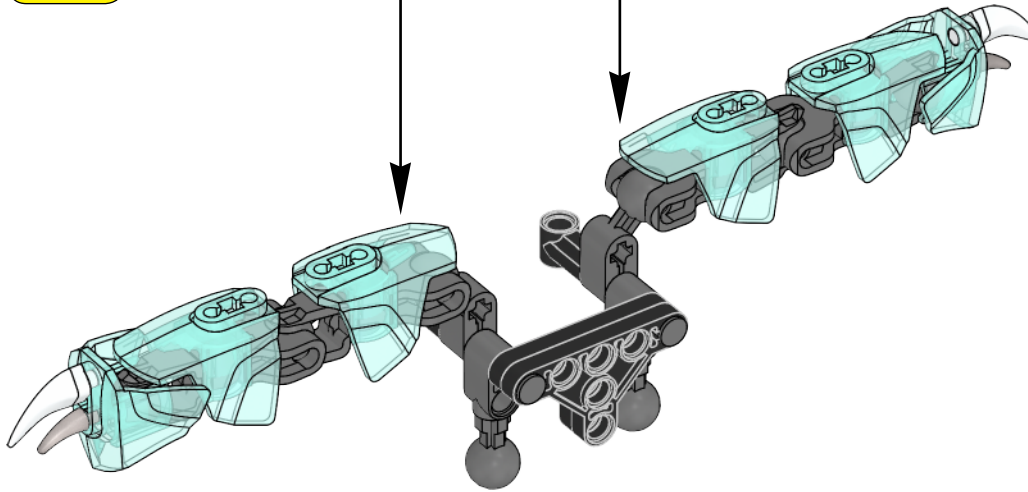
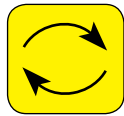
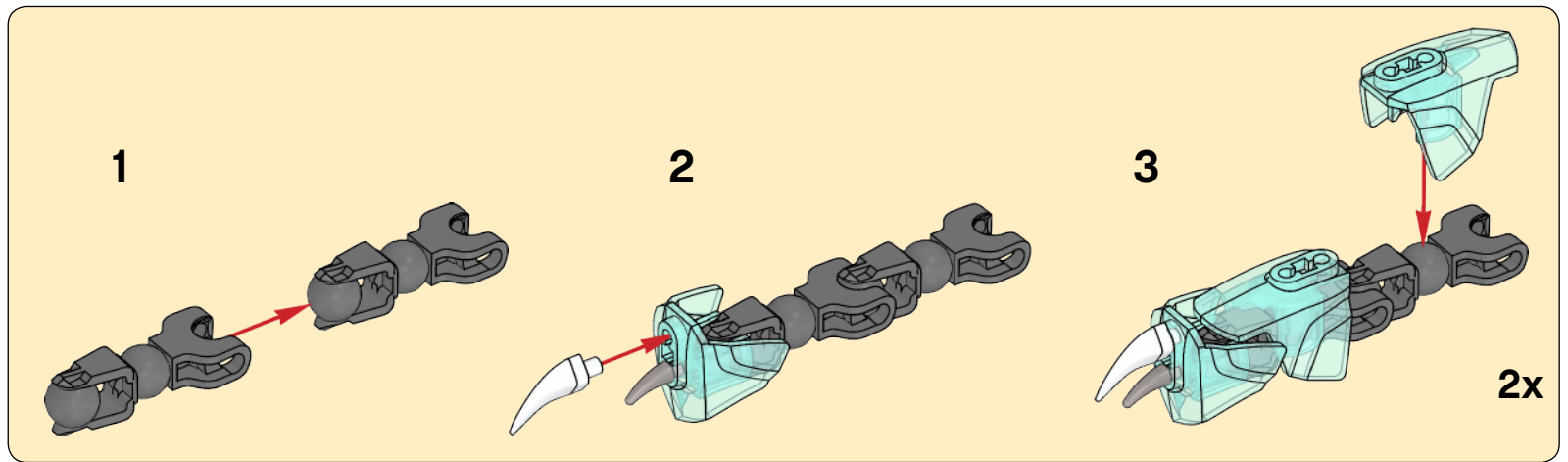

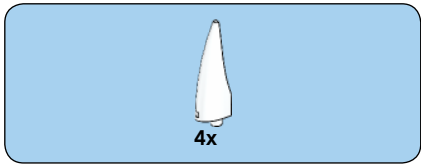

7

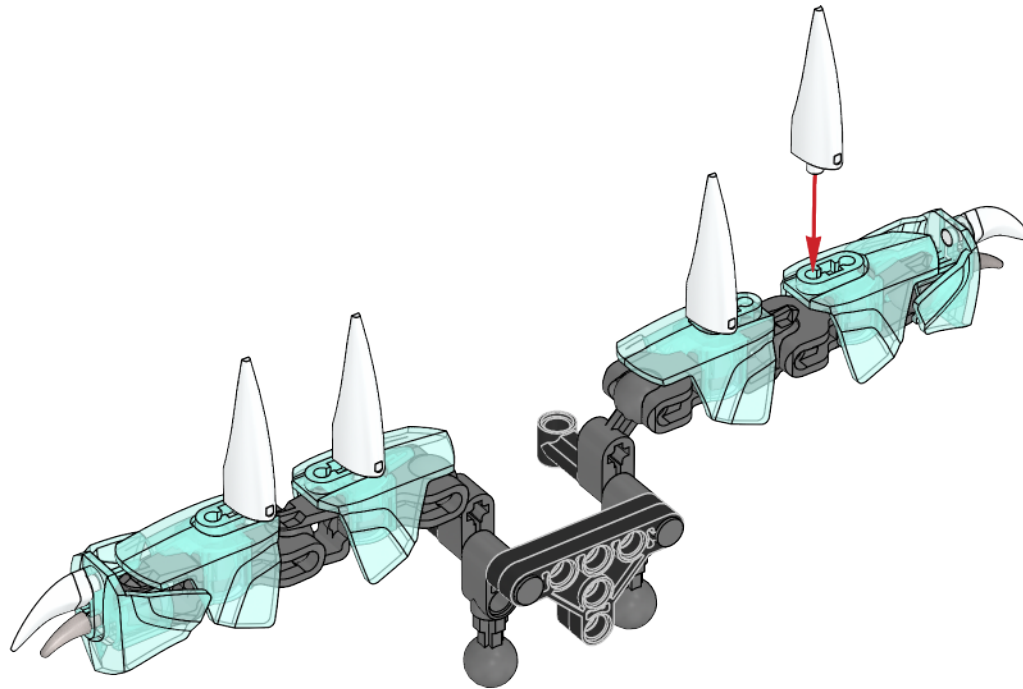

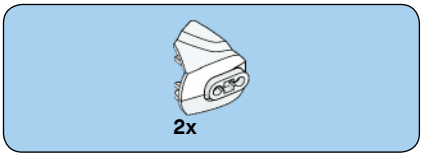

8

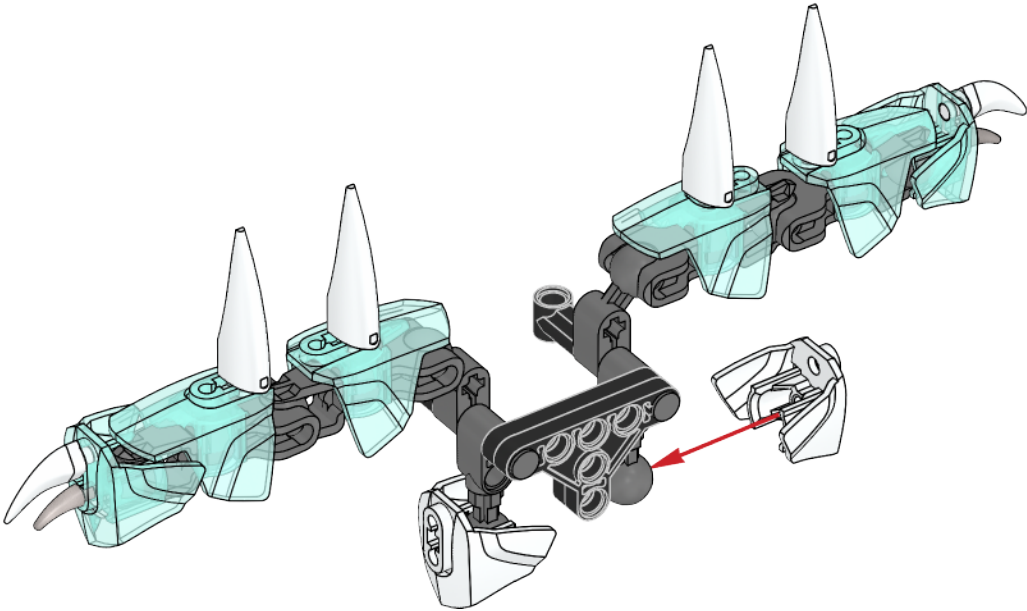

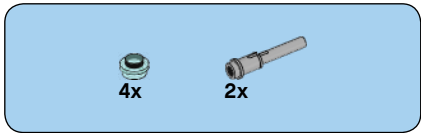

9

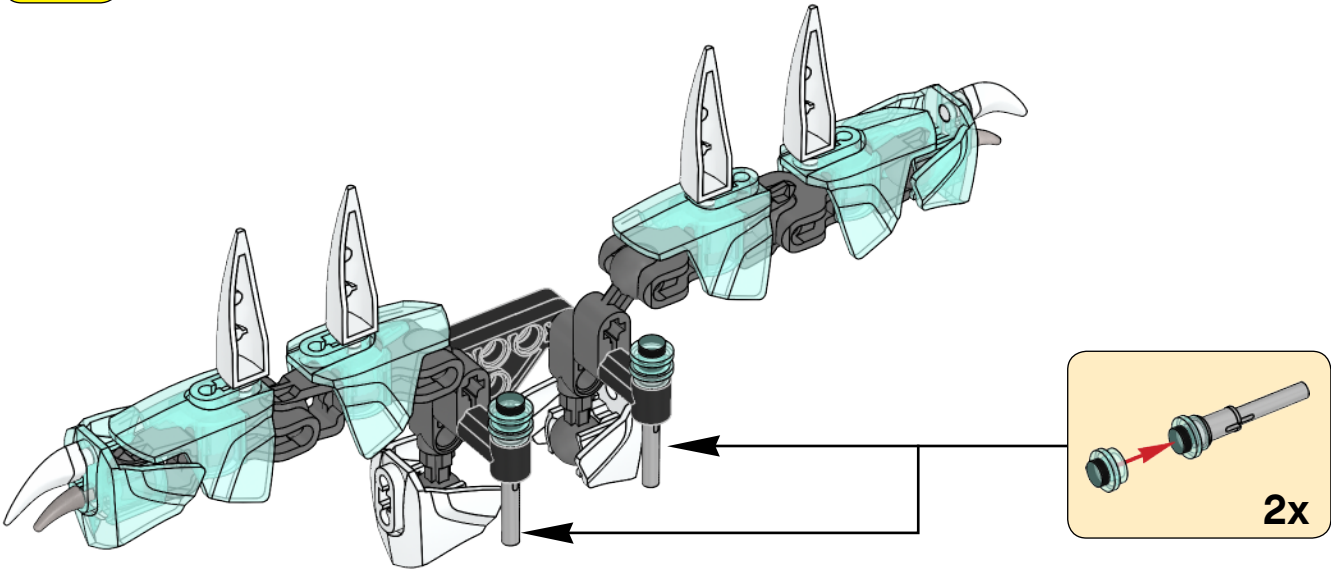
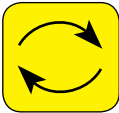

14

