



# Disney

43223



**WARNING:** CHOKING HAZARD. Toy contains small parts and a small ball. Not for children under 3 years.



### **Get excited about our new packaging!**

We're switching from plastic to paper-based packaging. That's why you might find a mix of paper and plastic in our boxes!

### **Nos nouveaux emballages vous emballeront !**

Nous passons des emballages en plastique aux emballages à base de papier. C'est pourquoi vous pourriez trouver un mélange de papier et de plastique dans nos boîtes !

### **¡Te presentamos nuestros nuevos empaques!**

Estamos sustituyendo las bolsas de plástico por bolsas con base de papel. ¡Por eso, puedes encontrar una mezcla de papel y de plástico en nuestras cajas!

**[LEGO.com/sustainable-packaging](https://www.lego.com/sustainable-packaging)**



# BUILDER



Apple and the Apple logo are trademarks of Apple Inc., registered in the U.S. and other countries and regions. App Store is a service mark of Apple Inc. Google Play and the Google Play logo are trademarks of Google LLC. Tencent and the Tencent logo are trademarks of Tencent Inc.

Q [LEGO.com/devicecheck](https://www.lego.com/devicecheck)

**EN** Ask parents' permission before going online | **DE** Eltern um Erlaubnis bitten, bevor du online gehst | **FR** Demande l'autorisation d'un parent avant d'aller en ligne | **IT** Chiedi il permesso ai tuoi genitori prima di andare online | **ES** Pídeles permiso a tus papás antes de conectarte a Internet | **PT** Pede autorização aos pais antes de acederes online | **ZH** 上网前应先征得父母的同意 | **PL** Poproś rodziców o zgodę, zanim wejdiesz do Internetu | **CS** Než půjdeš na internet, požádej rodiče o svolení | **SK** Skôr než pôjdeš na internet, vypýtaj si povolenie od rodičov | **HU** Kérj szülői engedélyt, mielőtt online csatlakoznál! | **RO** Cere permisiunea părinților înainte de a te conecta online | **BG** Поискайте разрешение от родител, преди да влезете онлайн | **LV** Pirms došanās tiešsaistē palūdz atļauju vecākiem | **ET** Enne Interneti kasutamist küsi vanematelt luba | **LT** Prieš prisijungdami prie interneto, atsiklauskite tėvų



## AVERTISSEMENT : RISQUE D'ÉTOUFFEMENT.

Le jouet contient des petites pièces ainsi qu'une petite boule.  
Il ne convient pas aux enfants de moins de 3 ans.



## ADVERTENCIA: PELIGRO DE ASFIXIA.

Juguete que contiene partes pequeñas y una pelota pequeña.  
No recomendado para niños menores de 3 años.

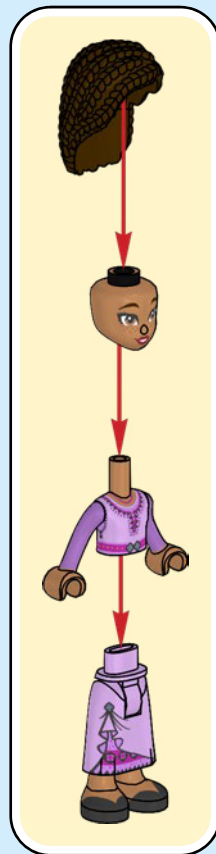

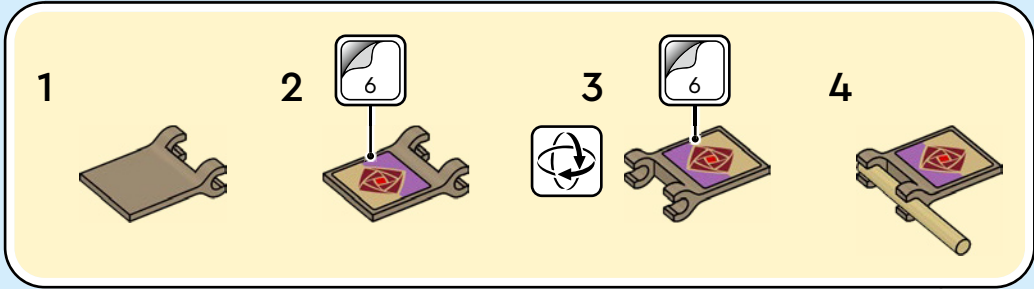

1



2

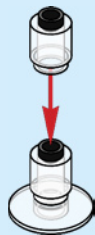

3



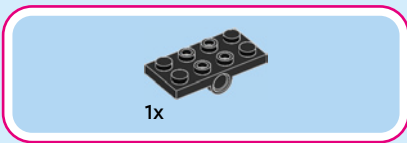
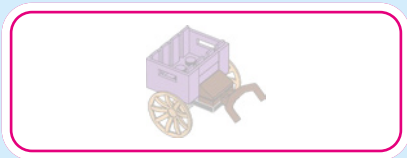

1

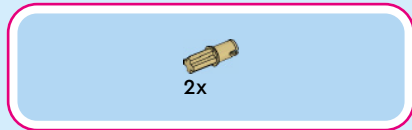
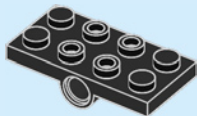

2

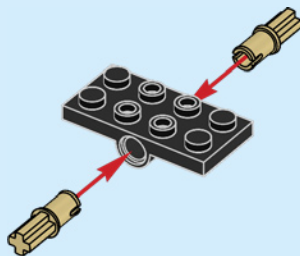



3

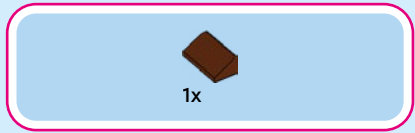
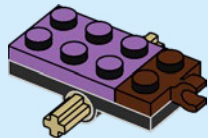

4

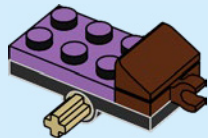



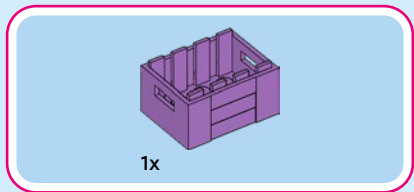

5

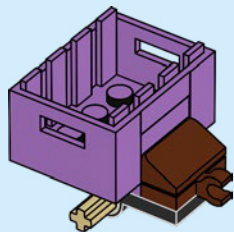

6

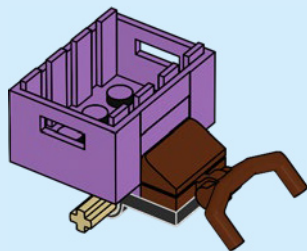



2x

7

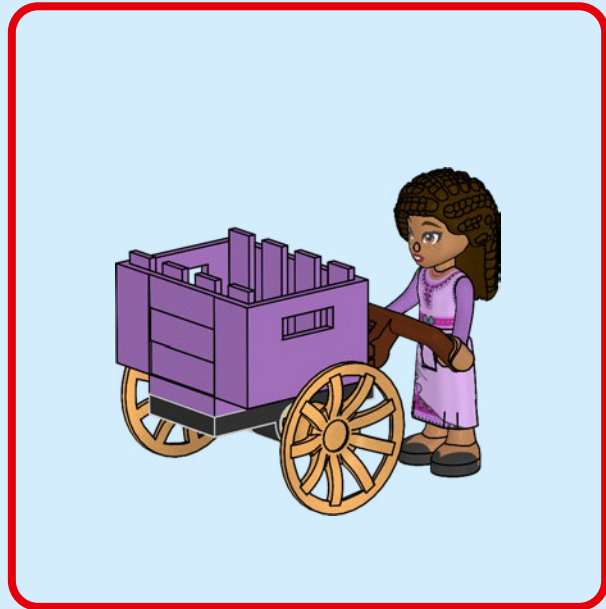

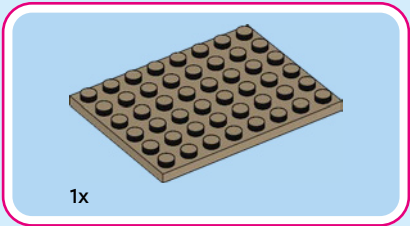
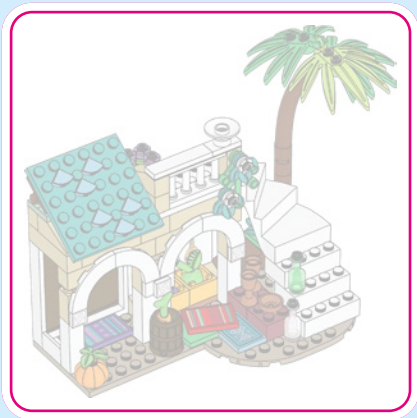

1

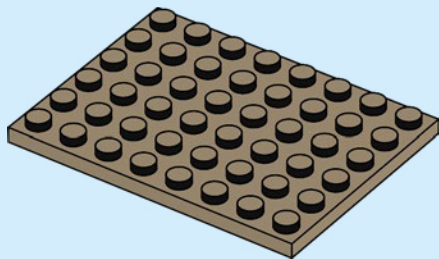

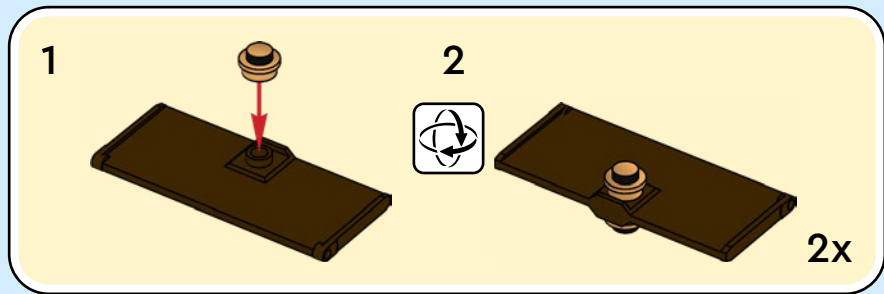
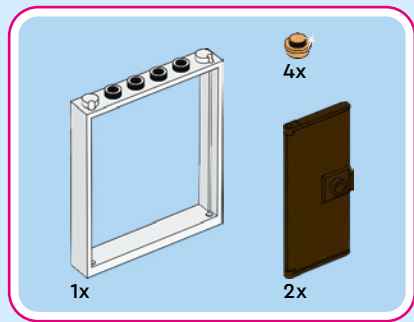

2

1

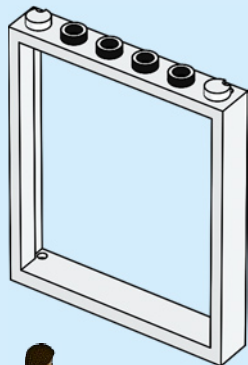

2

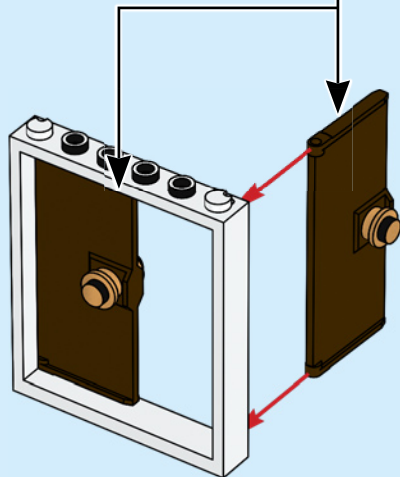

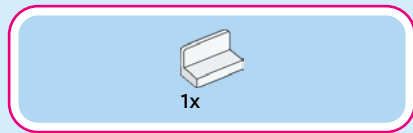
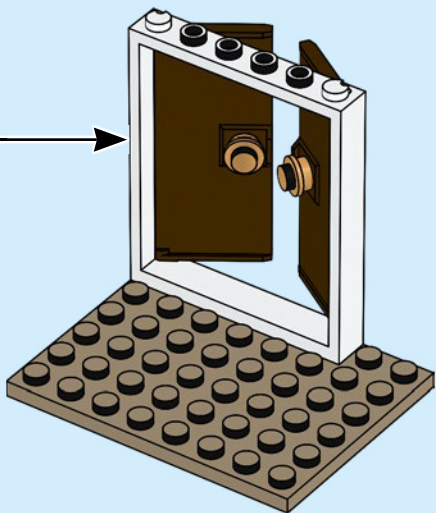

3

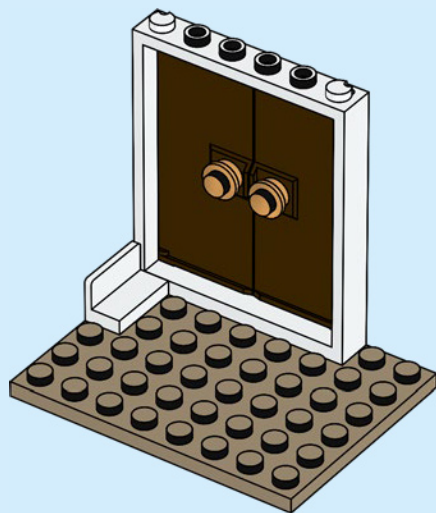

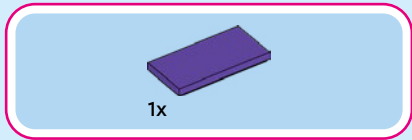

4

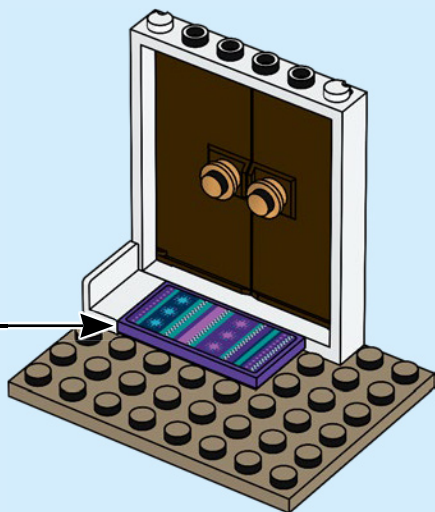
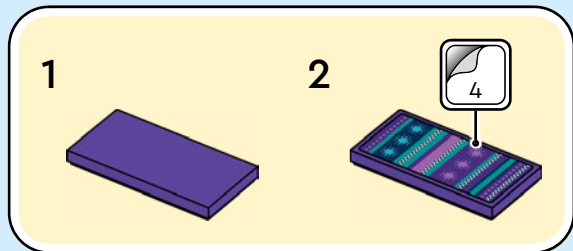

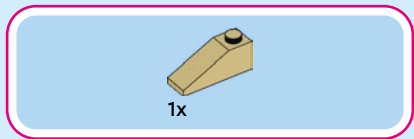

5

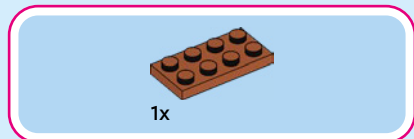
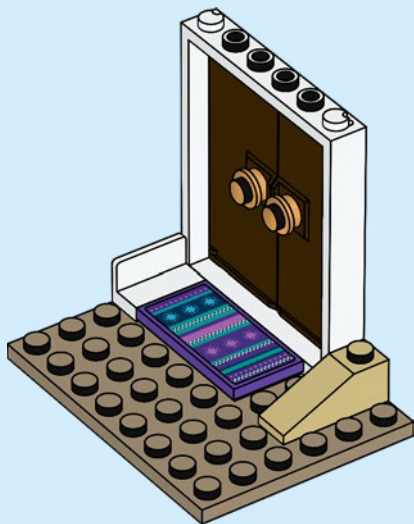

6

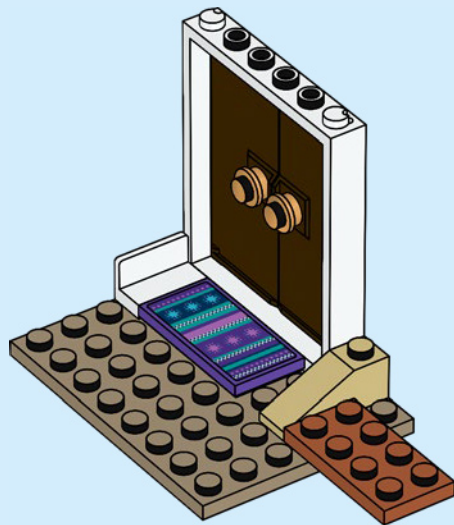

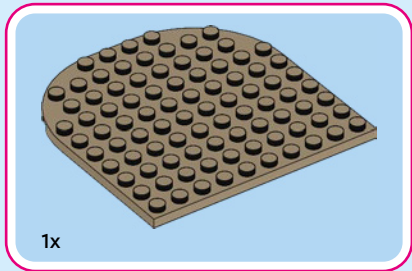

7

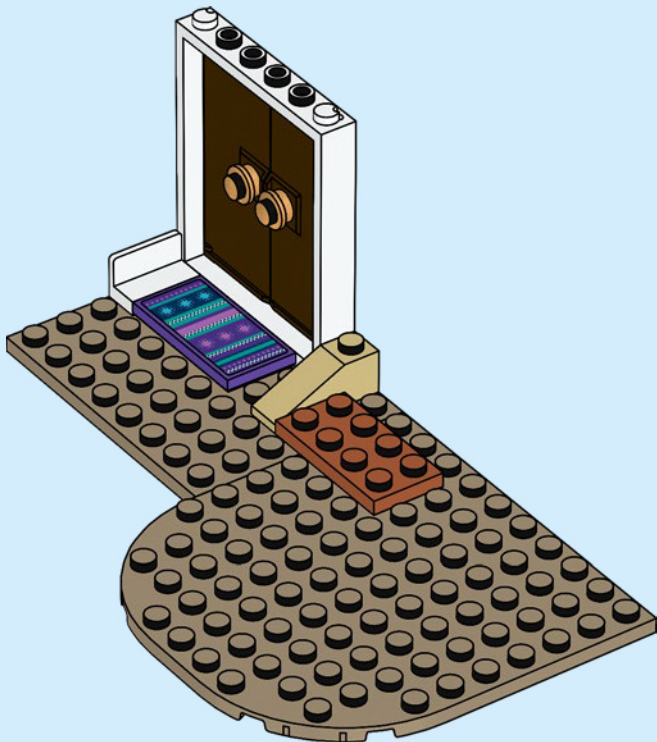





1x

8



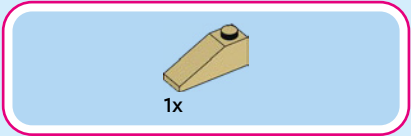

9



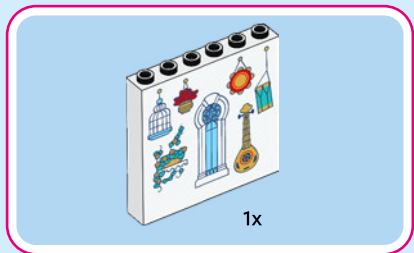

10

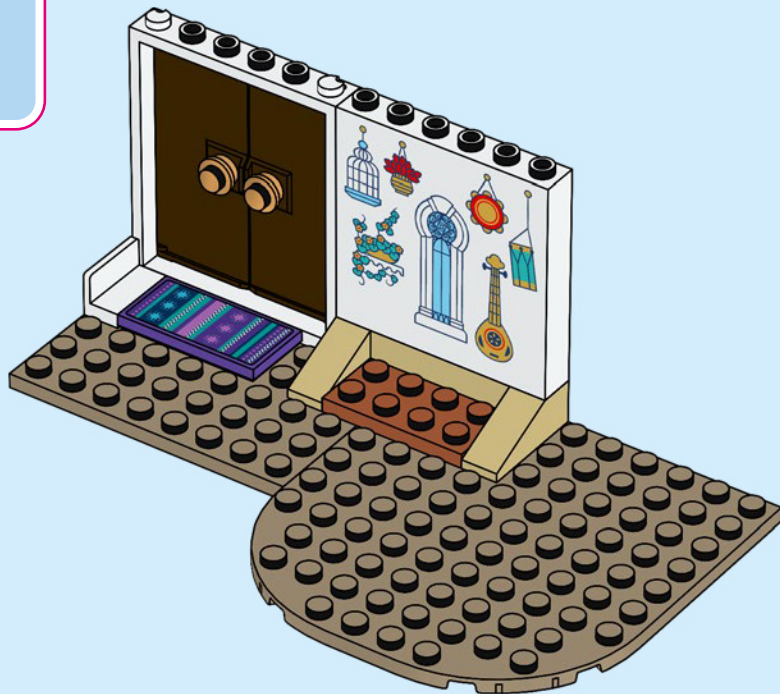



2x

11

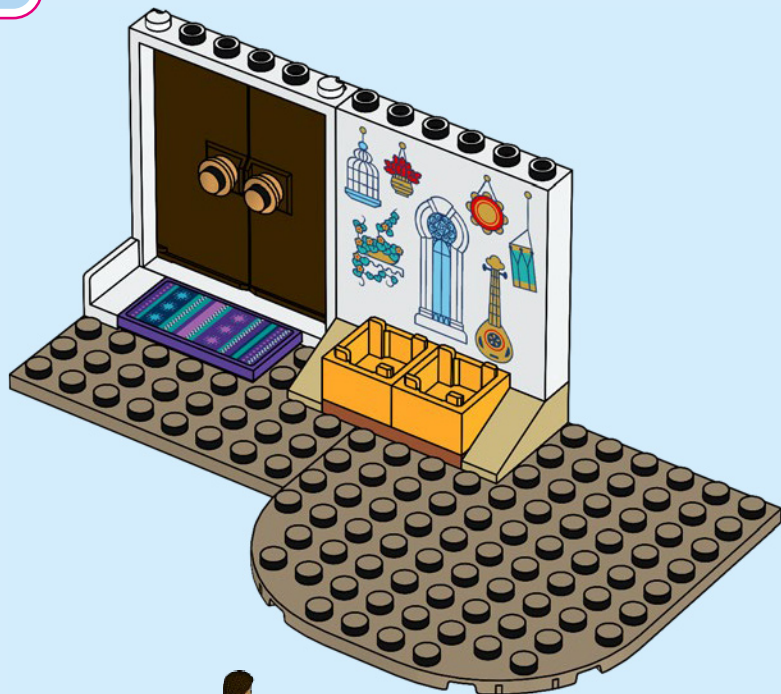

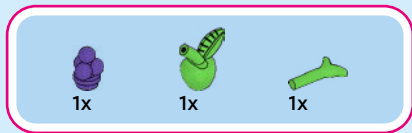

12

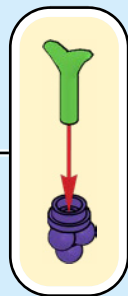
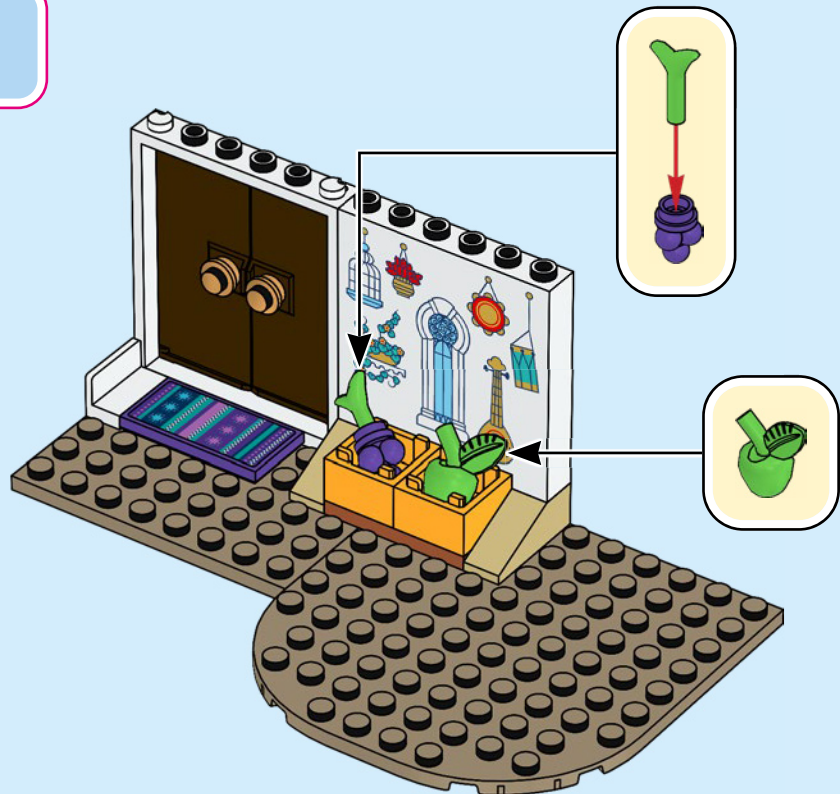

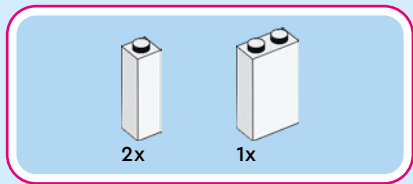

13





1x



2x

14

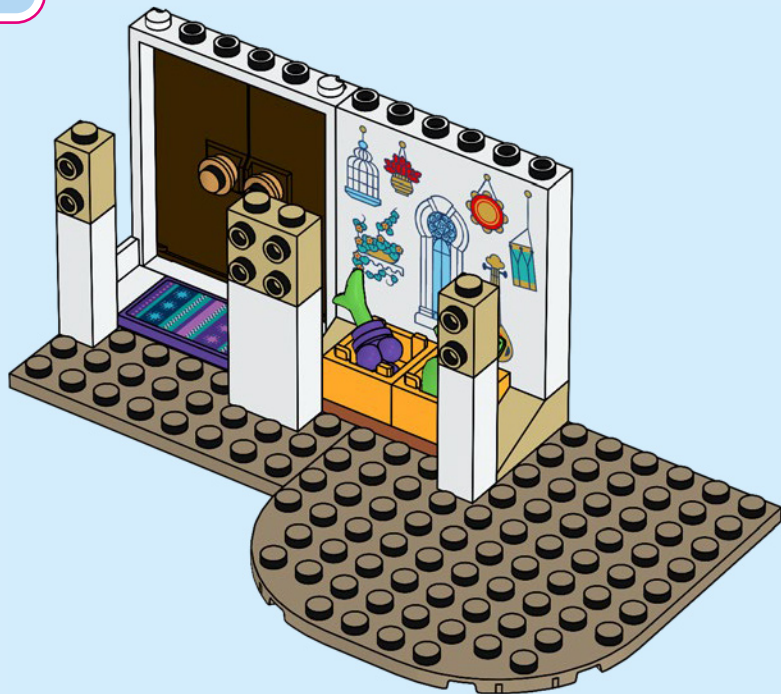



2x



1x

15





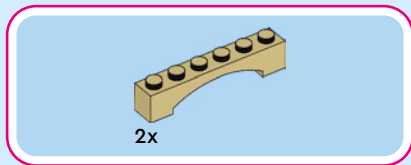

16

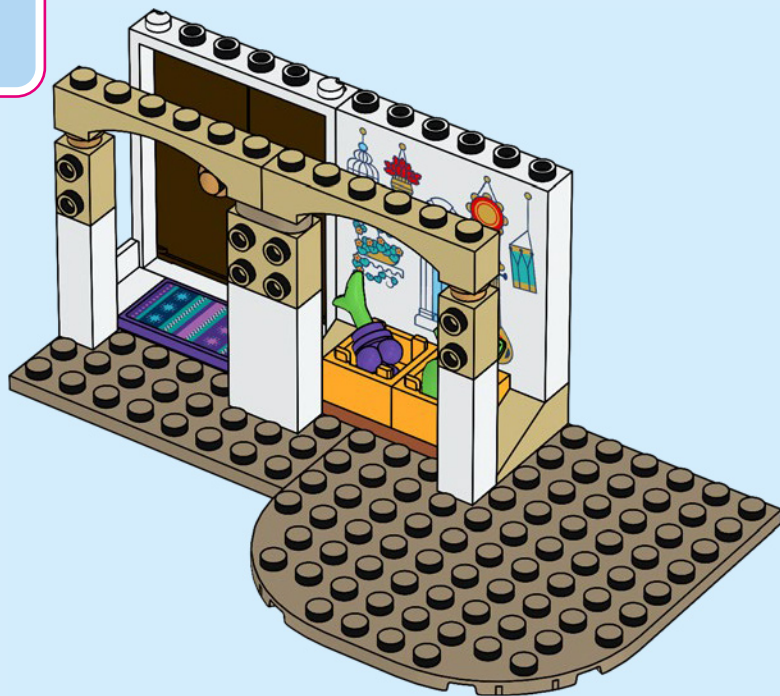

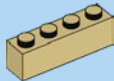

1x

17

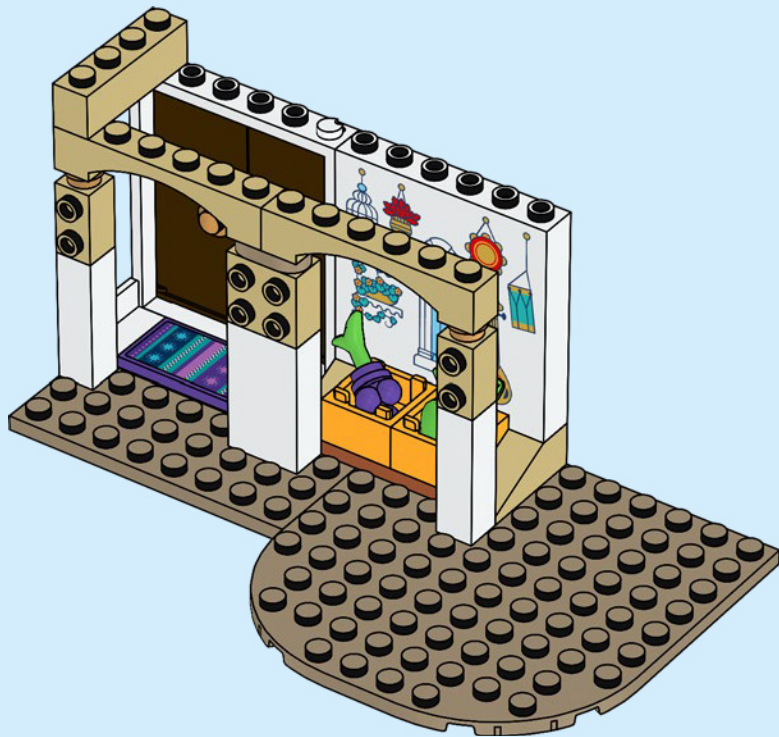

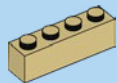

2x

18

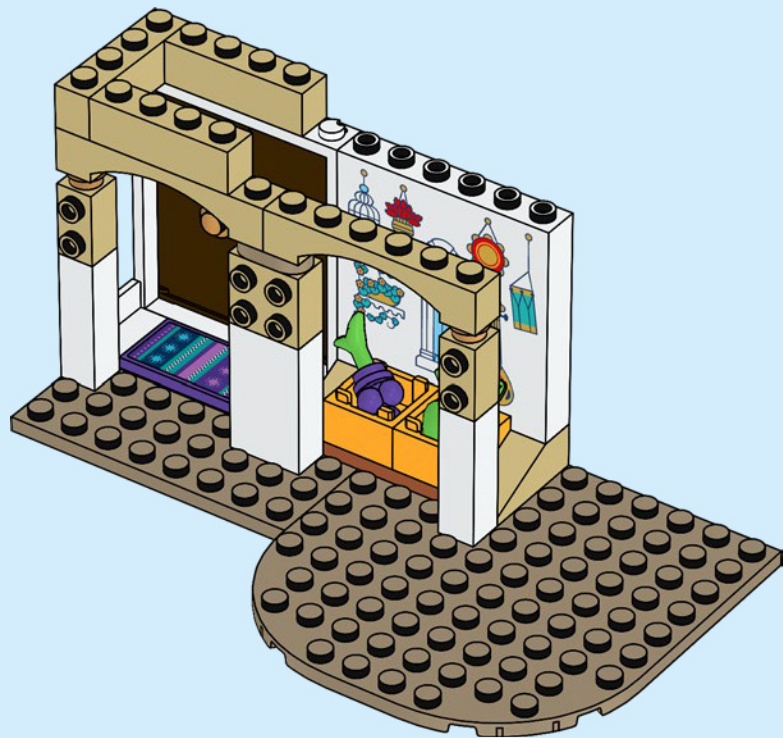



1x

19

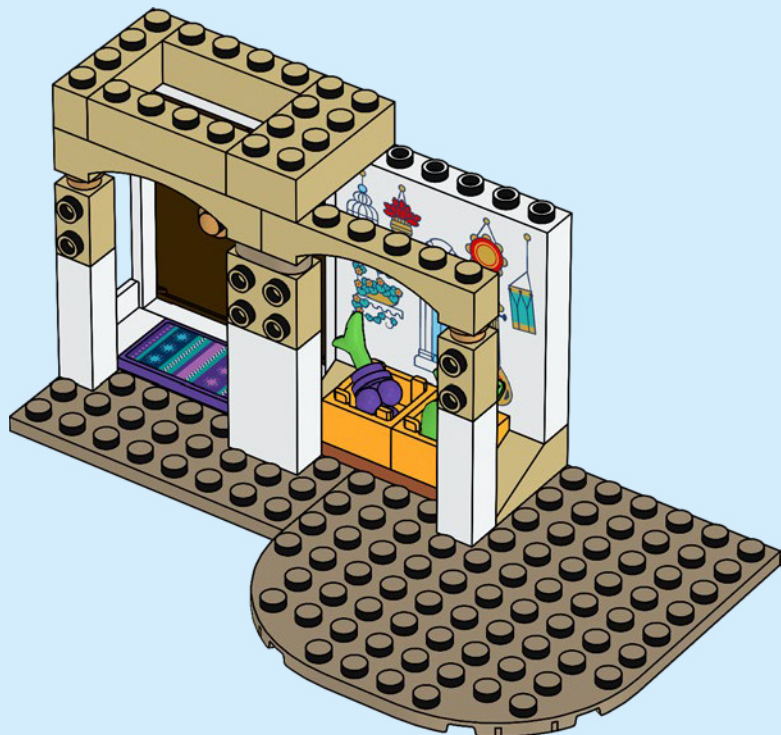

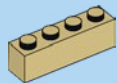

2x

20

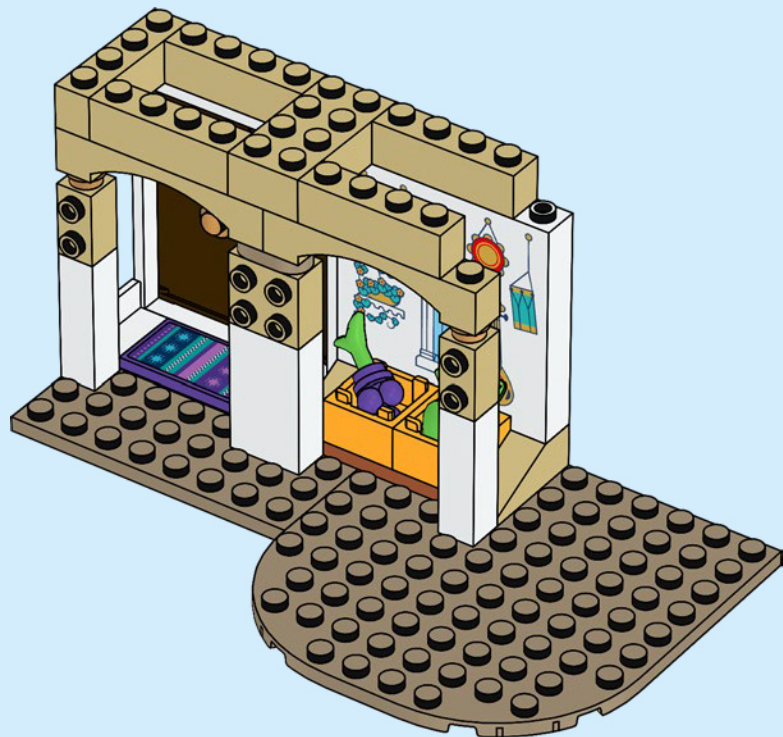

21

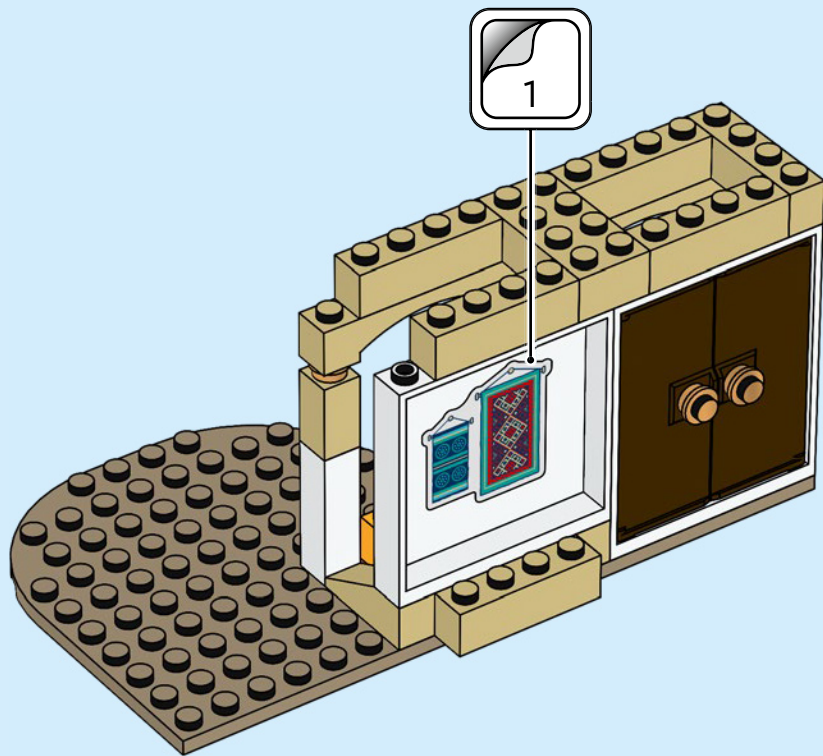
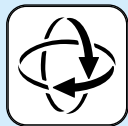

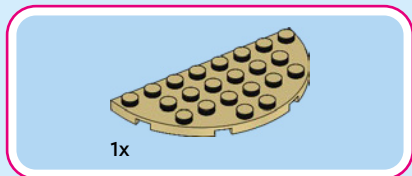

22

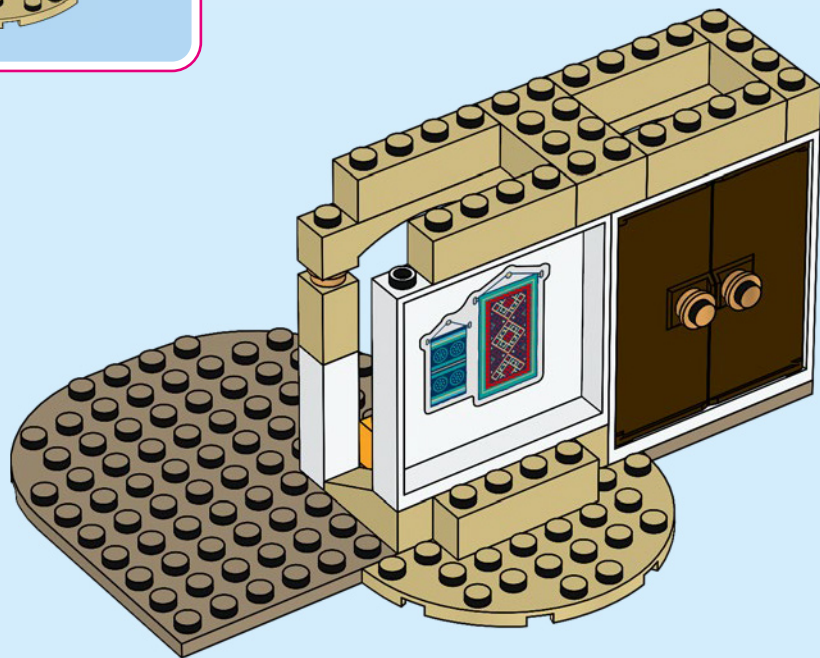



2x



1x

23





24





1x

25





1x



1x



1x

# 26



1



2





1x

27





1x

28

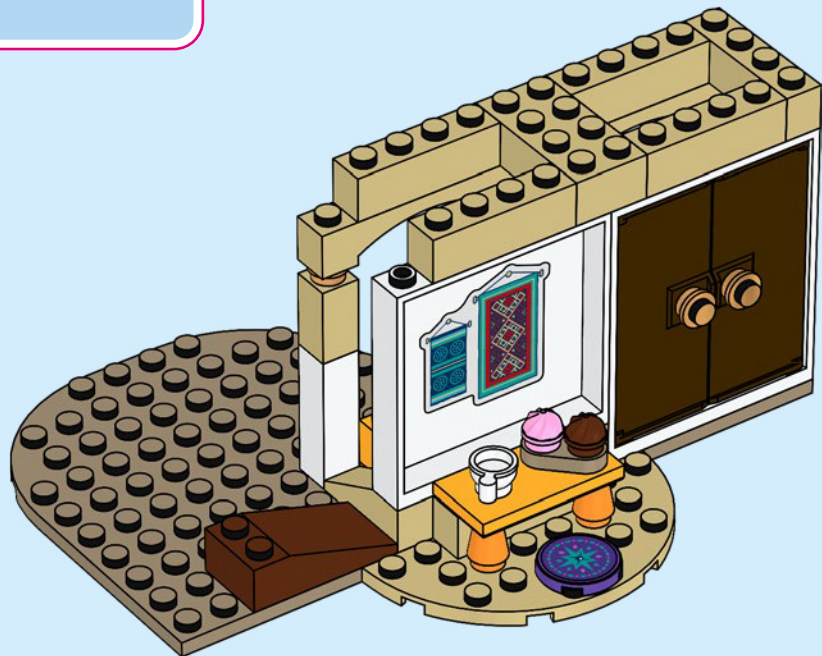



1x



1x

29

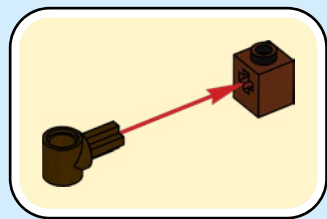



1x

30





1x

31







2x

32





1x

33





1x



1x

# 34

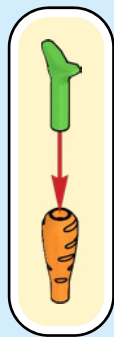





1x

35



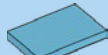

1x

36

1

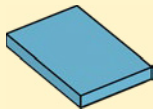

2

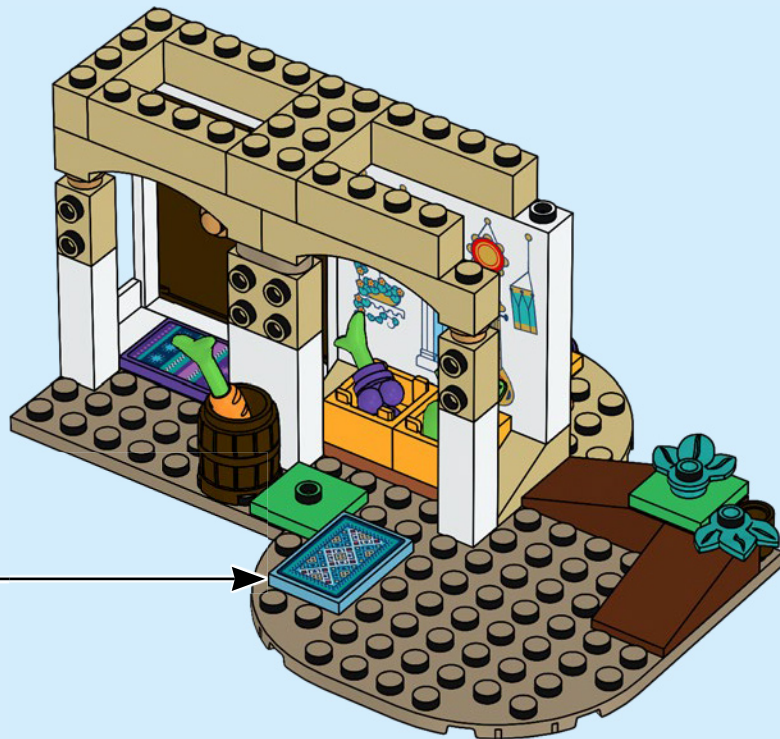



2x

37





2x



1x

38





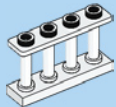

1x



1x

39





1x

40





1x

41





1x

42





2x

43



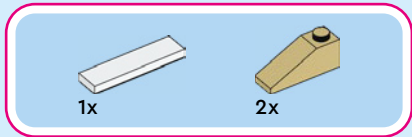

44

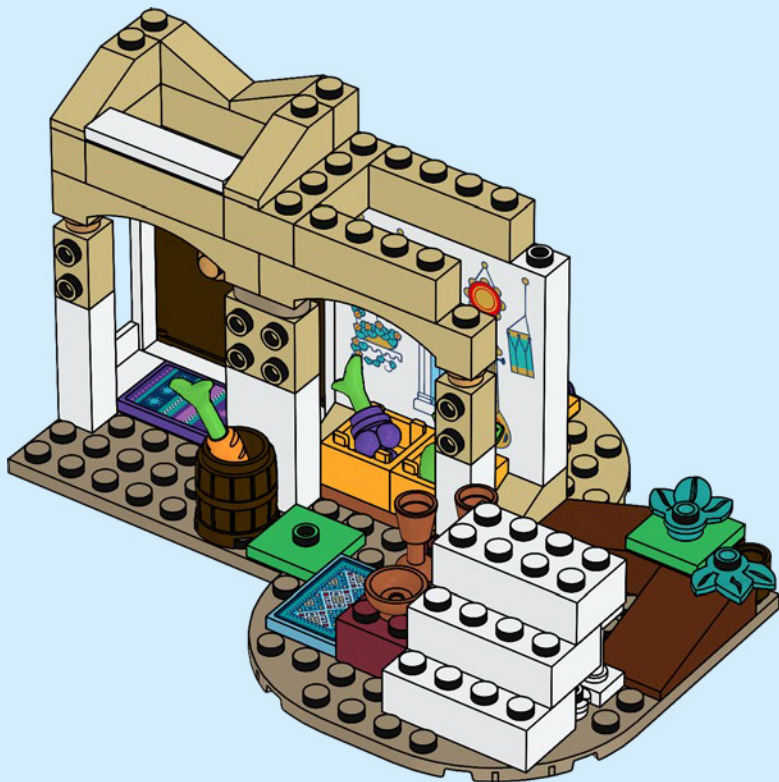

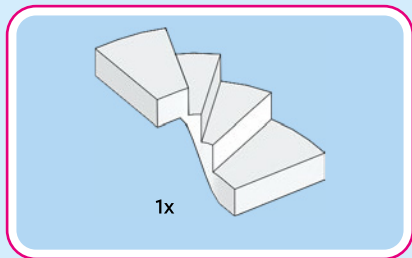

45

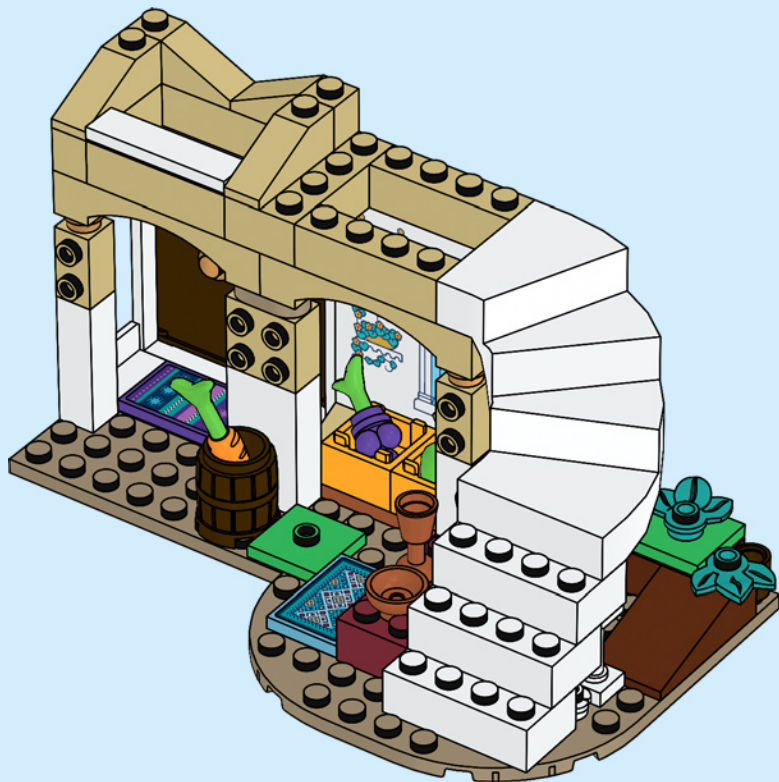

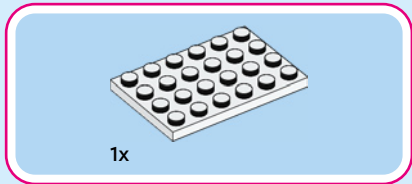

46

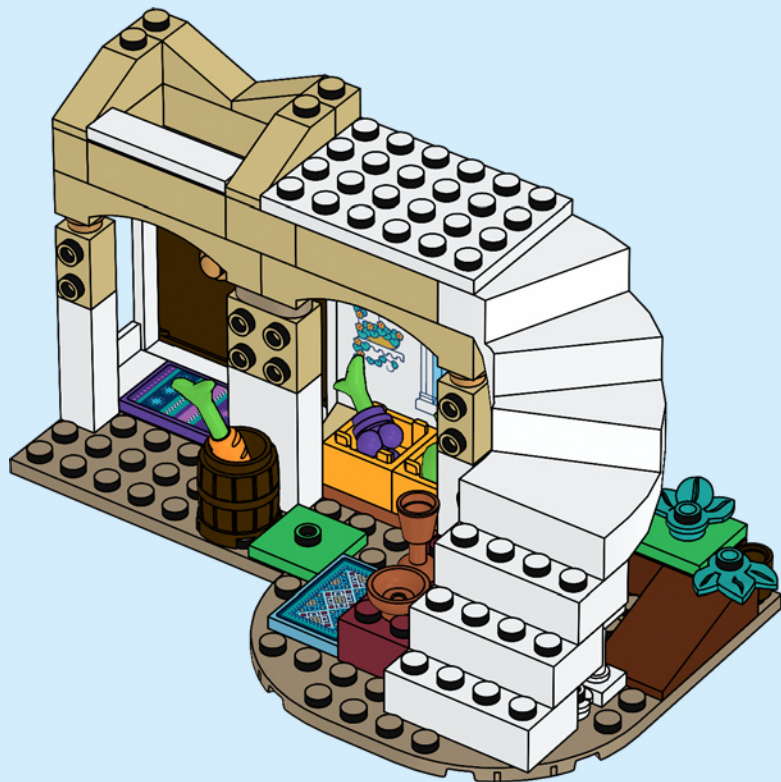





1x



1x

47

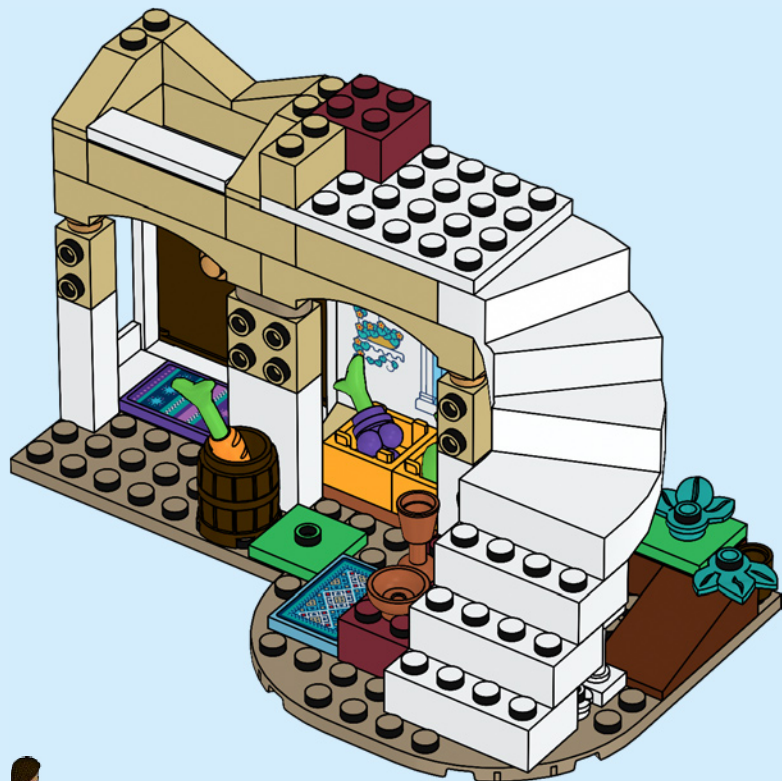



1x

48

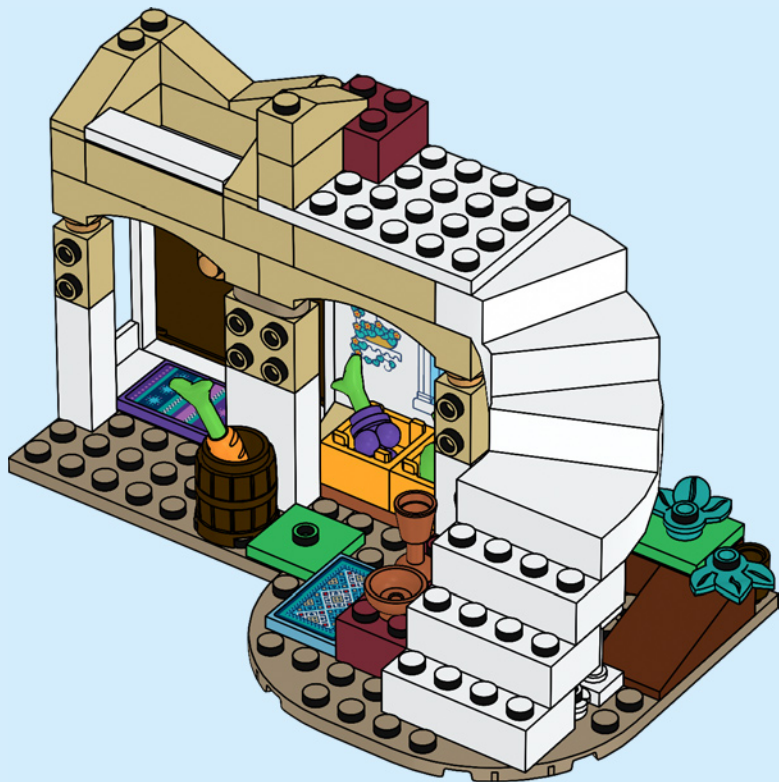



3x

49

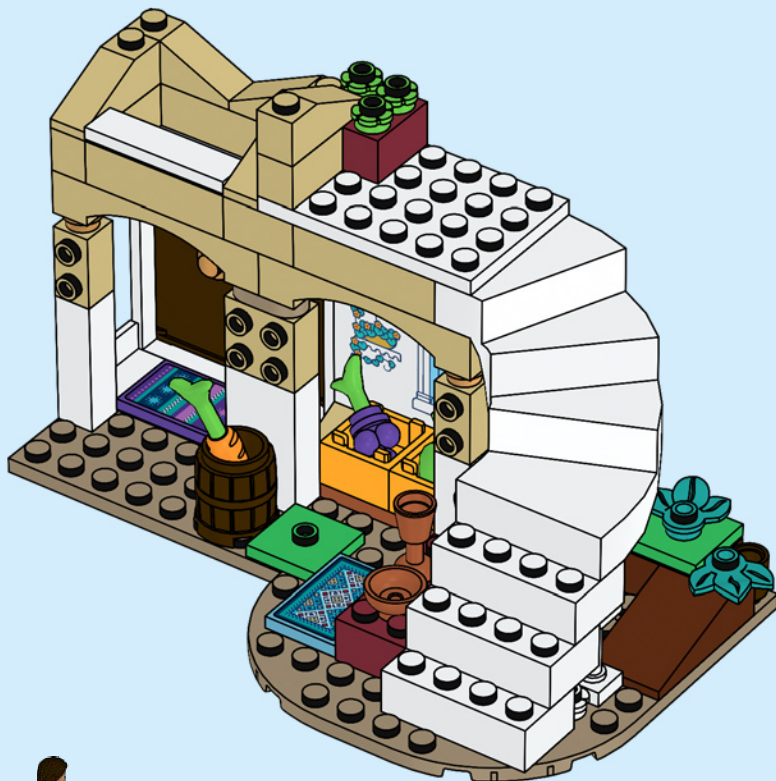



3x

50



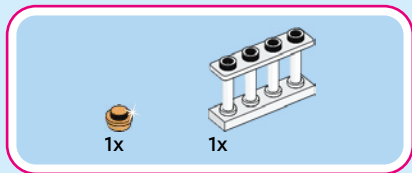

51





1x

52





1x



1x

# 53





1x



1x

54

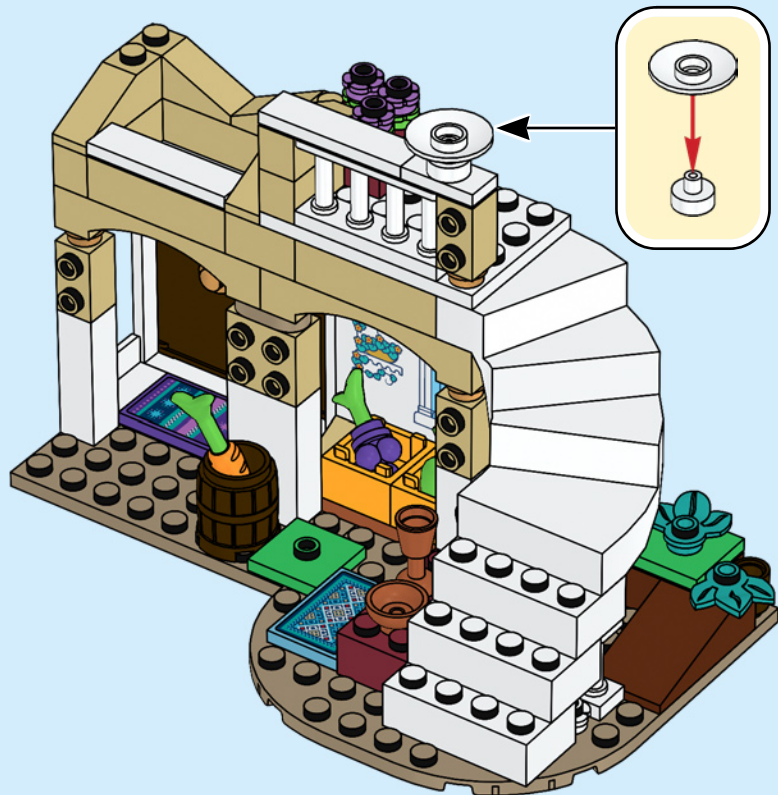





1x

55

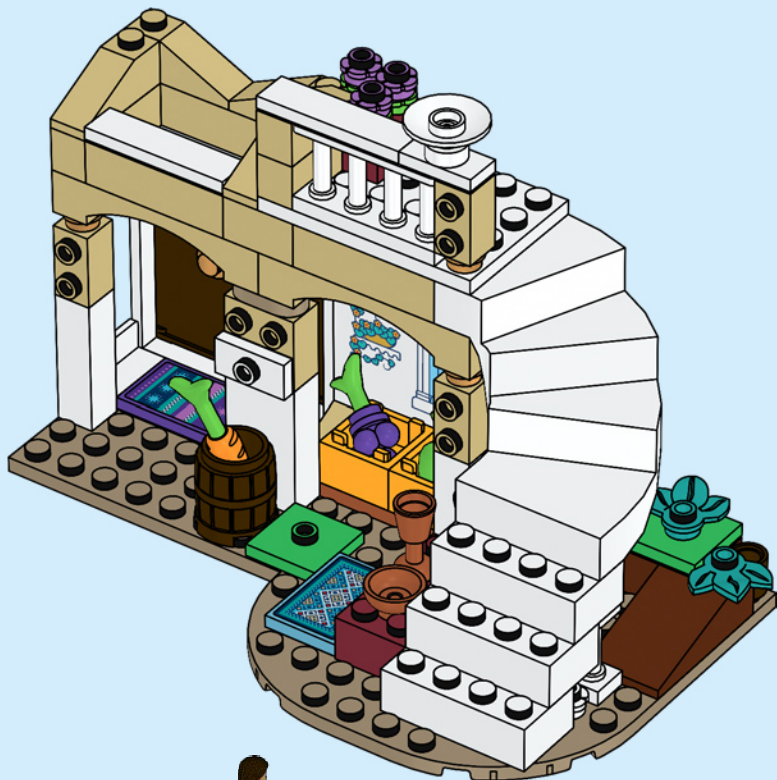



4x

56





3x

57





2x

58



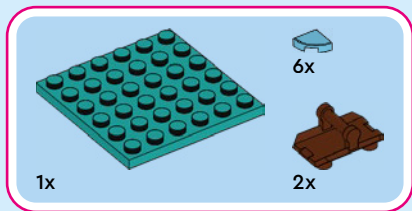

59

1

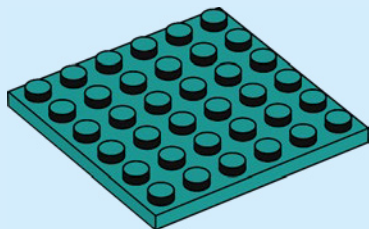

2

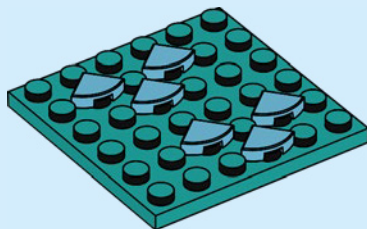

3

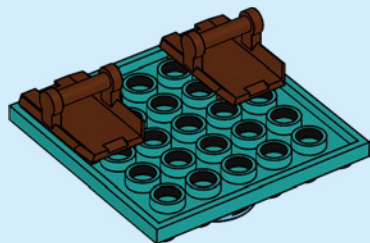



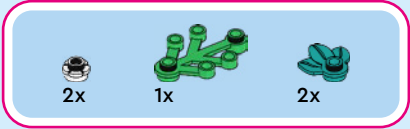

60

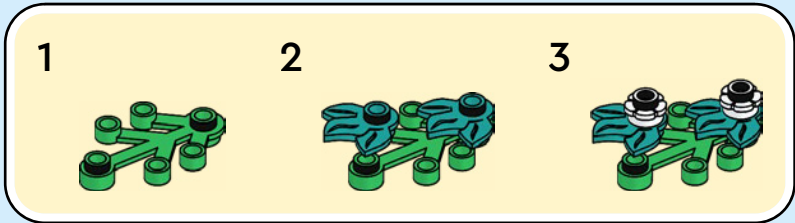

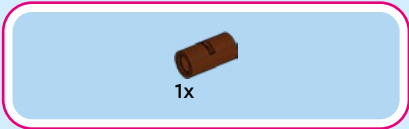
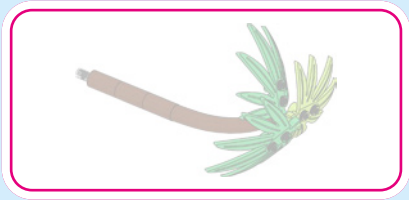

61

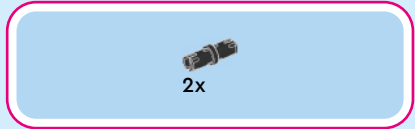

62

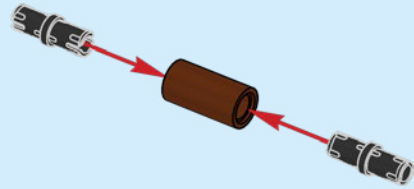





1x



1x

63

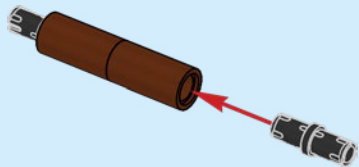

1x

64

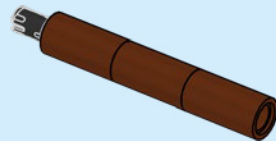

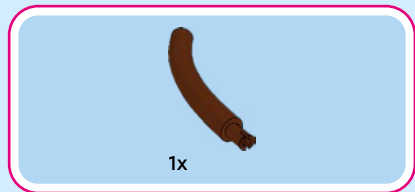

65

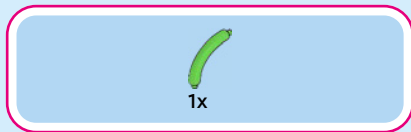
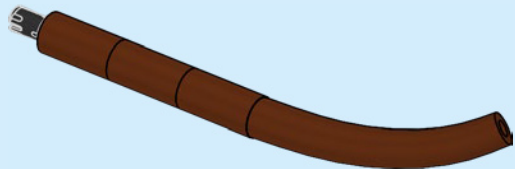

66

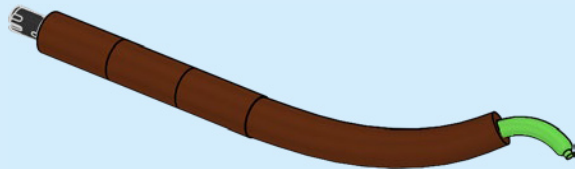

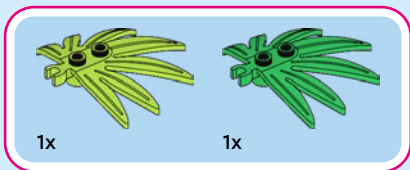

67

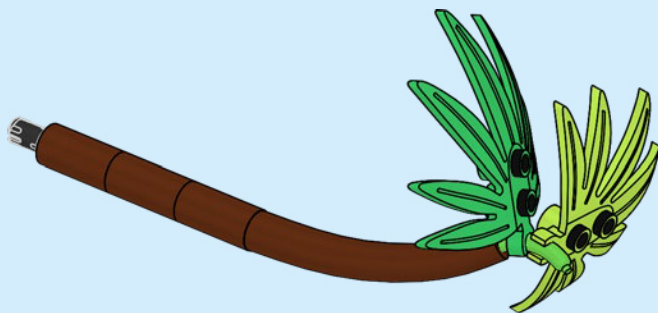



1x

68



69





1x



1x

70

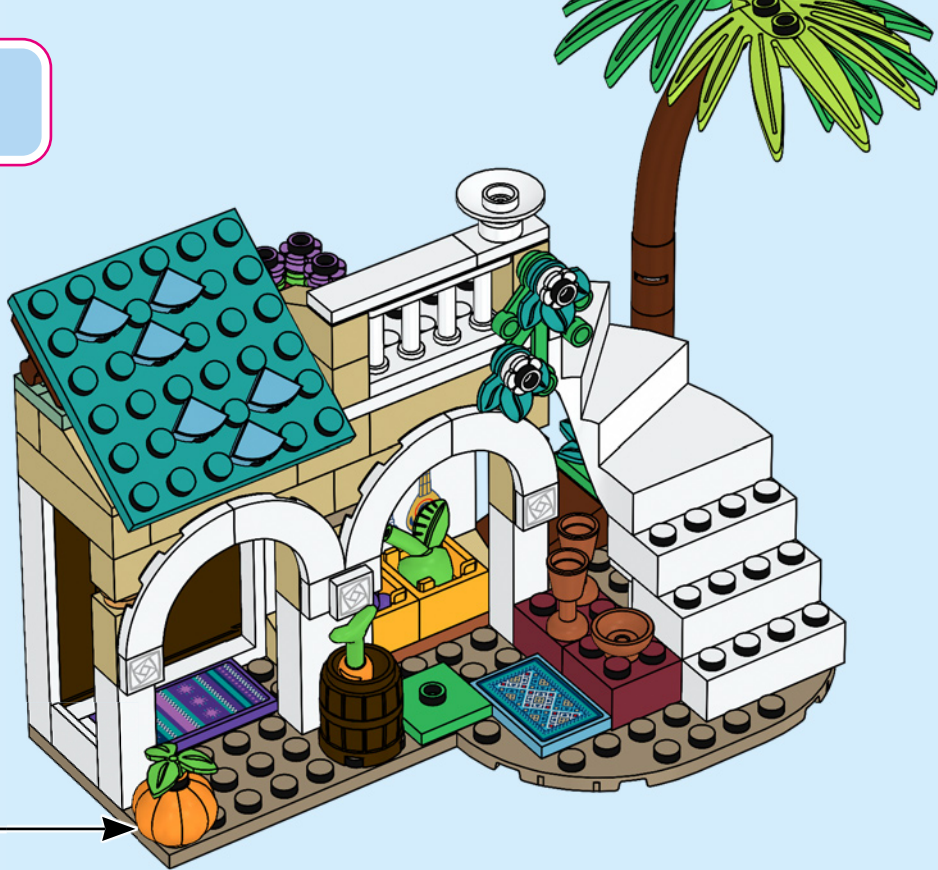
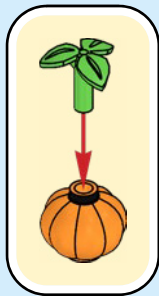

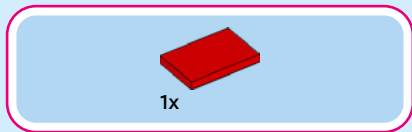

71

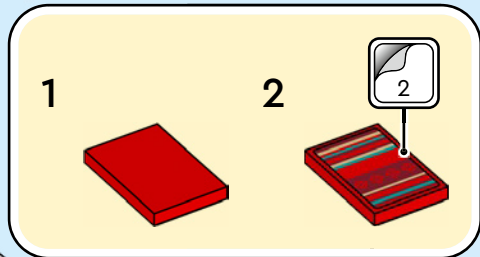



1x



1x

72









3x  
6206149



1x  
6186681



3x  
6455001



1x  
6235083



1x  
474001



2x  
6051511



2x  
6055541



1x  
6153776



1x  
6146215



2x  
243101



4x  
6373439



2x  
6047813



3x  
300101

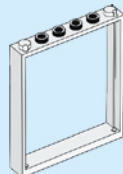

1x  
6256127



1x  
6464391

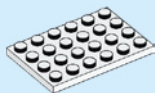

1x  
303201

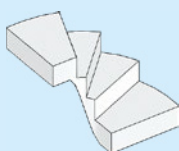

1x  
6458979



3x  
6232135



2x  
4666579



1x  
6214334



1x  
4109995



7x  
6058090



1x  
6116614



5x  
4113916



2x  
4114319



2x  
4618876



1x  
6123812



1x  
6189130



1x  
6455021



2x  
6223655



1x  
6247369



1x  
6245306



3x  
6206150



1x  
6430093



1x  
6413063



1x  
6235080



2x  
4119479



2x  
6389692



1x  
6268814



2x  
6313099



1x  
6420470



2x  
6420468



1x  
4535928



1x  
6247364



2x  
4518029



1x  
6267125



1x  
6424015



4x  
6270179

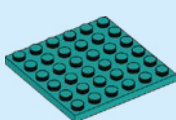

1x  
6251830

3x  
6279875

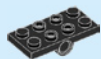

1x  
6194233



1x  
6313098



2x  
6231386



1x  
6365489



1x  
4251796

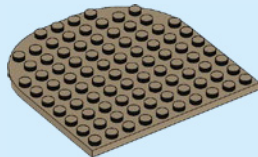

1x  
6463586

1x  
6060731



1x  
6397610



1x  
6035291



3x  
6173132



1x  
6313124



1x  
6327818



1x  
6326087



2x  
6328480



2x  
4225869



2x  
6385882



7x  
4523159



1x  
6424008



1x  
6278447



1x  
6097501



1x  
6167472



2x  
6439231



1x  
6369683



1x  
6455310



1x  
6134197



1x  
6278987



2x  
6452420



1x  
6454983



1x  
6460972



1x  
6455038



6x  
6150307



1x  
6233166



2x  
6360075



3x  
4539104



3x  
6209684



1x  
6461097



1x  
6344844



1x  
6460299



LEGO.com/service



YOU COULD **WIN**



Scan this QR code or go to **LEGO.COM/PRODUCTFEEDBACK** and give us your short feedback about this LEGO® set for a chance to win a cool LEGO prize.

Terms and Conditions apply\*

**EN: YOU COULD WIN.** Terms and Conditions apply\* **DE: Du könntest GEWINNEN.** Es gelten die Teilnahmebedingungen\* **FR: Tu pourrais GAGNER.** Des conditions s'appliquent\* **IT: Potresti VINCERE tu.** Termini e condizioni sono applicabili\* **ES: Puedes GANAR.** Aplican términos y condiciones\* **PT: Poderá GANHAR.** Aplicam-se termos e condições\* **ZH: 轻松获奖. 条款和条件适用\*** **PL: Szansa na WYGRANĄ.** Obowiązują warunki korzystania\* **CS: Máte šanci VYHRÁT.** Platí všeobecné smluvní podmínky\* **SK: Máte šancu VYHRAŤ.** Platia všeobecné zmluvné podmienky\* **HU: TE IS NYERHETSZ.** Felhasználási feltételek érvényesek\* **RO: Ai putea CÂȘTIGA.** Se aplică termeni și condiții\* **BG: Можете да СПЕЧЕЛИТЕ.** Има определени правила и условия\* **LV: Tu vari LAIMĒT.** Ir spēkā noteikumi un nosacījumi.\* **ET: Sul on võimalus VÕITA.** Kehtivad tingimused\* **LT: Jūs galite LAIMĖTI.** Taikomos sąlygos\*

\*[LEGO.com/productfeedback-terms](https://www.lego.com/productfeedback-terms)