

Sunblock



3852



1



2



2

1



2



4x

1



2

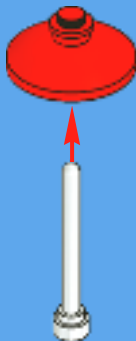

4x

1



2



5x



1



2

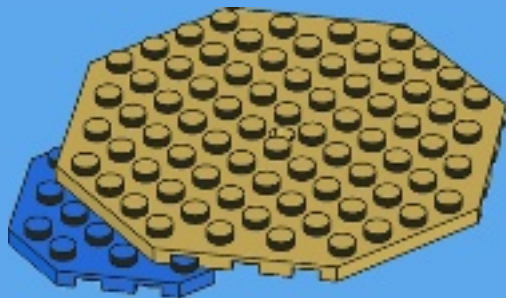

4

3

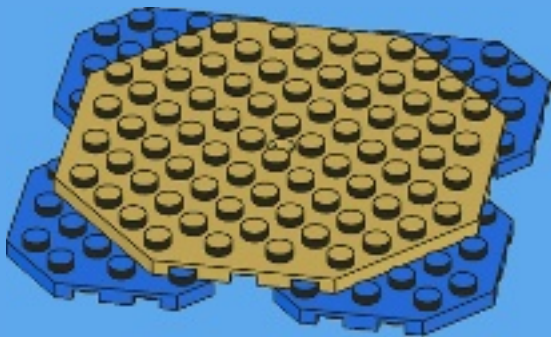

4

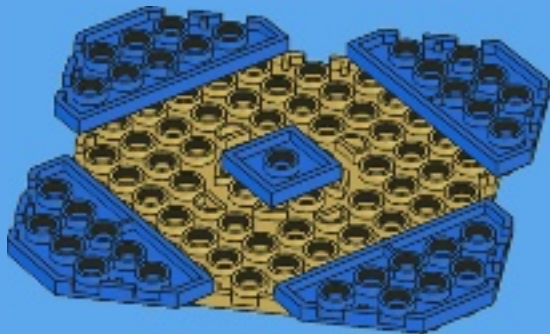



5

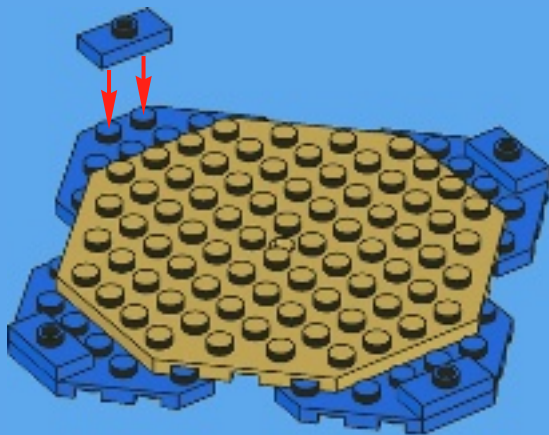

6

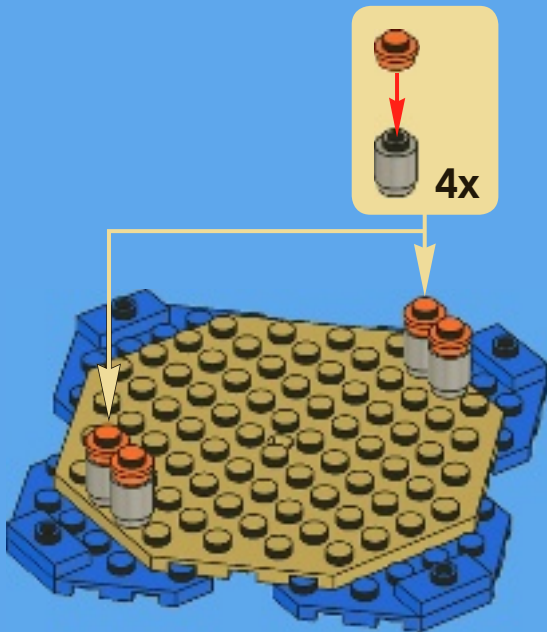

7

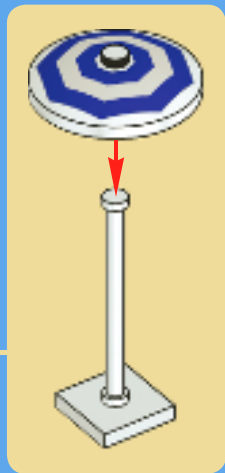
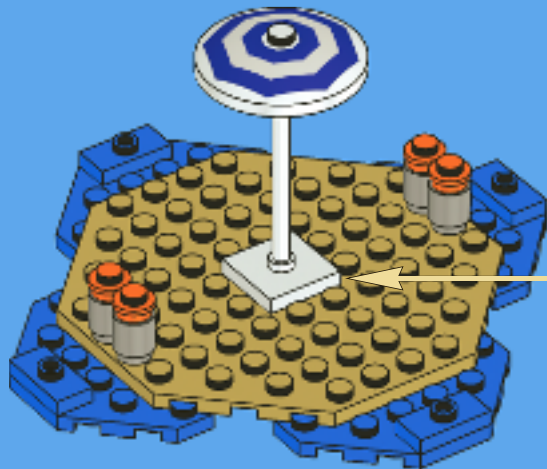

1



2



8







1x
4610669



1x
4558593



4x
3005740



1x
4527526



1x
4580007



4x
4538950



1x
4205004



5x
4277766



4x
4211180



4x
4504376



1x
4271949



4x
241923



1x
306824



4x
4616180



4x
4157103



1x
4542142



1x
4616231



1x
306821



4x
614121



4x
4179584



1x
4599453



4x
379423



1x
302223



1x
307001



1x
4616173



5x
474001



1x
4616174



1x
4117032



9x
395701



Customer Service

Kundenservice

Service Consommateurs

Servicio Al Consumidor

www.lego.com/service or dial



00800 5346 5555 :

1-800-422-5346 :

MINOTAURUS



3841
Minotaurus



2-4



7+





20-30





LEGO



3852
Sunblock
  
2-4 6+ 5-15



3853
Banana Balance
  
2-4 6+ 5-15



3854
Frog Rush
  
2-4 7+ 10-20



3855
Ramses Return
  
2-4 7+ 10-20





www.LEGOclub.com



LEGO® Club Email

LEGO club™

FREE! GRATIS! GRATUIT!



LEGO® Club Magazine

SIGN UP ONLINE!

www.LEGOclub.com

00800 5346 5555*



1-866-534-6258 • 1-877-518-5346

© 2005 LEGO Group

Canada (only)

B1110

- * Freephone. Mobile charges may apply.
- * Numéro sans frais. Des frais peuvent s'appliquer avec les téléphones cellulaires.
- * Gebührenfrei. Kosten für Anrufe aus Mobilfunknetzen können abweichen.
- * Gratis telefoonnummer vanaf vaste lijn.
- * Det er et gratis nummer, når du ringer fra fasttelefon.
- * Det är gratis, när du ringer från en fast telefon.
- * Numéro sans frais. Des frais peuvent s'appliquer avec les téléphones portables.



WIN!

 www.LEGO.com

Go to www.LEGOsurvey.com/product to fill out a survey for a chance to win a cool LEGO® Product.

No purchase necessary.

Open to all residents where not prohibited.



www.LEGOsurvey.com/product

GEWINNE!

Nimm an der Umfrage auf www.LEGOsurvey.com/product teil und hab die Chance ein cooles LEGO® Produkt zu gewinnen!

Die Teilnahme am Gewinnspiel führt zu keinerlei Kaufverpflichtungen. Teilnahme in allen nicht ausgeschlossenen Ländern möglich.

WIN!

Ga naar www.LEGOsurvey.com/product, vul een enquêteformulier in en maak kans op een cool LEGO® product.

Geen aankoopverplichting. Iedereen mag deelnemen, uitgezonderd ingezetenden van landen waar een enquêteverbod geldt.

GAGNE !

www.LEGOsurvey.com/product pour répondre à un questionnaire et avoir une chance de gagner un produit LEGO® très cool !

Aucune obligation d'achat. Ouvert à tous les résidents des pays autorisés.

当てよう!

www.LEGOsurvey.com/product にアクセスして、アンケートにご記入ください。当選者にはレゴ®製品を差し上げます。

お買い上げの必要はありません。禁止されていない限り、すべての皆様にご利用いただけます。

LEGO and the LEGO logo are trademarks of the LEGO Group. ©2011 The LEGO Group. ©2011 LucasFilm Ltd. & TM. All rights reserved.

4622154