

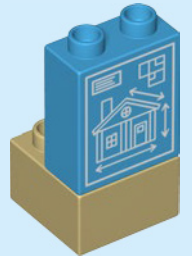

duplo



10932
LEGO.com/DUPL0



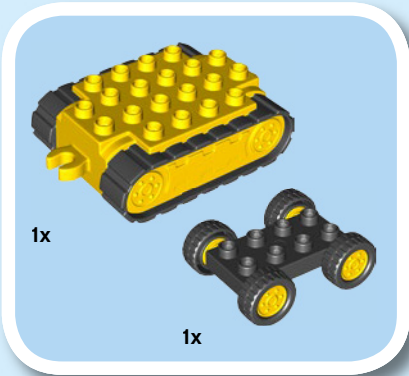

1

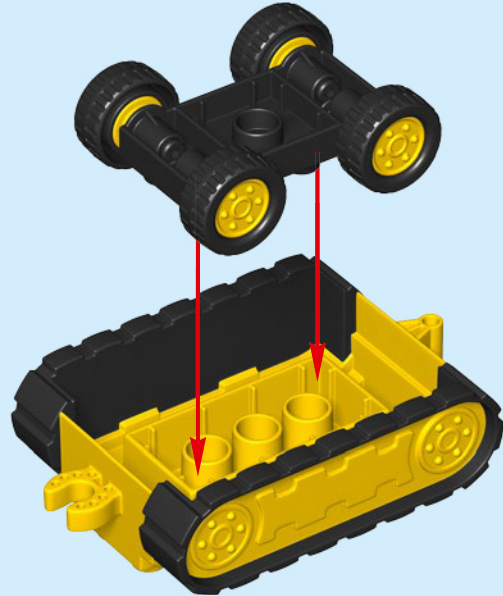

2

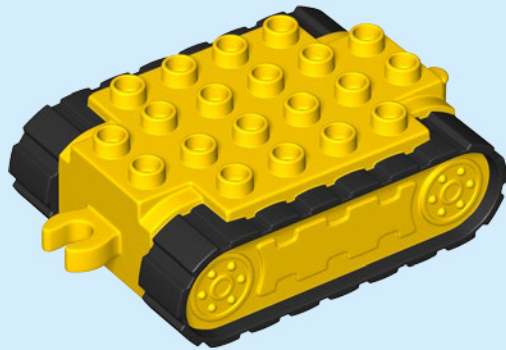

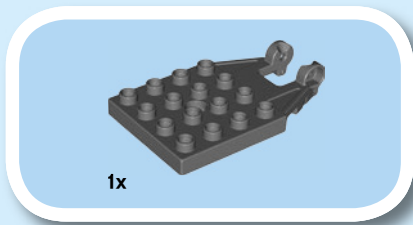

3

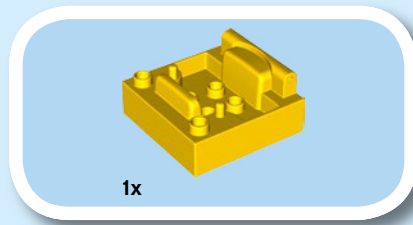
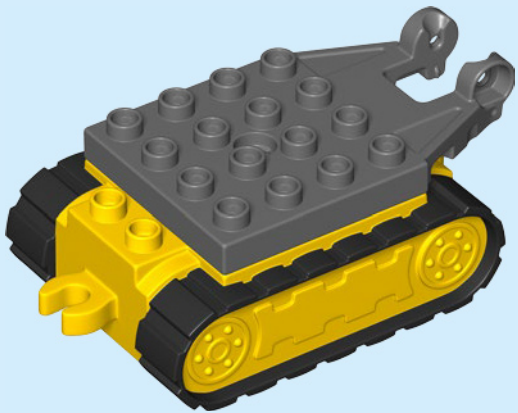

4

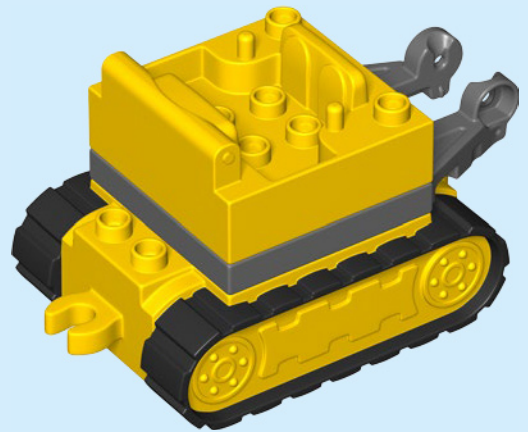

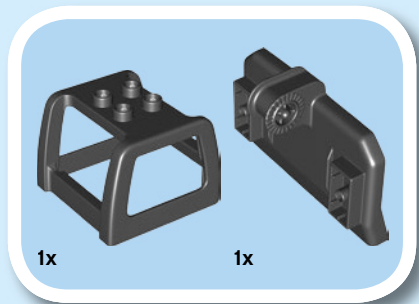

5

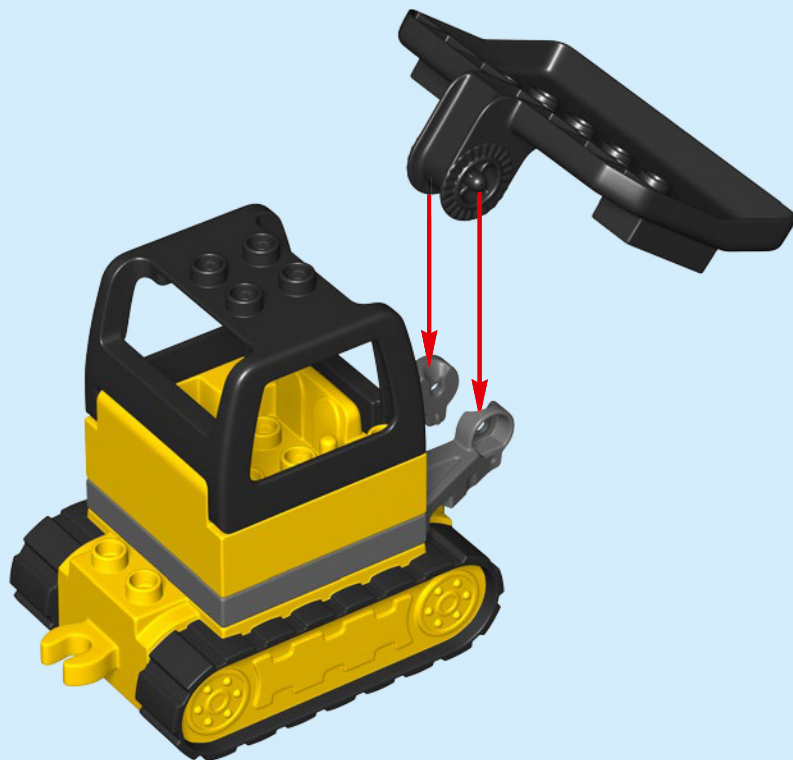



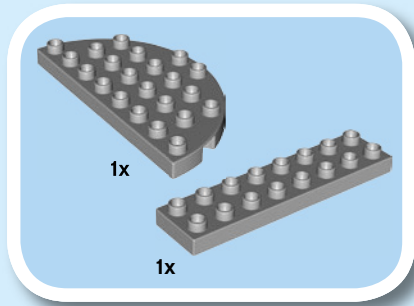

1

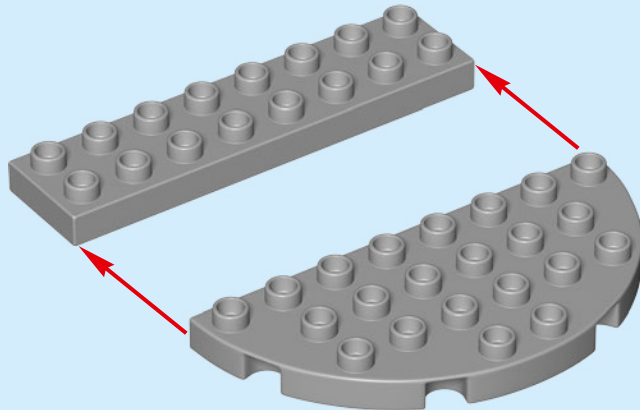

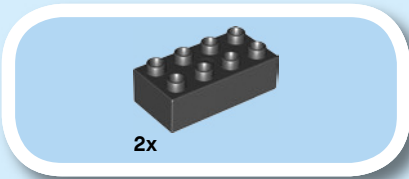

2

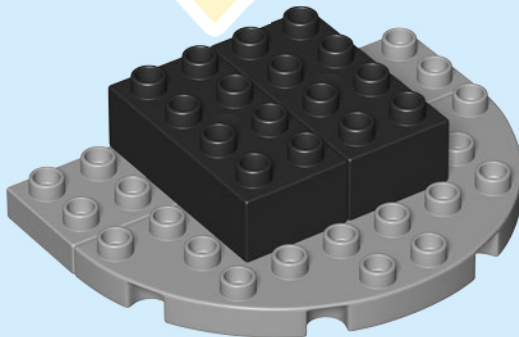
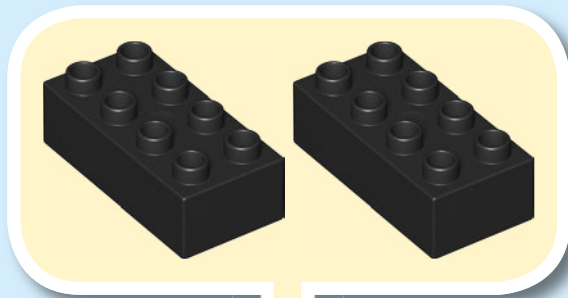

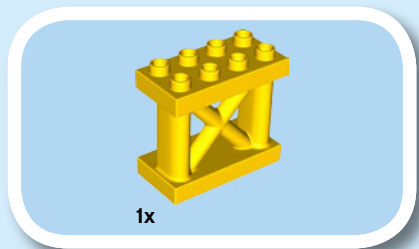

3

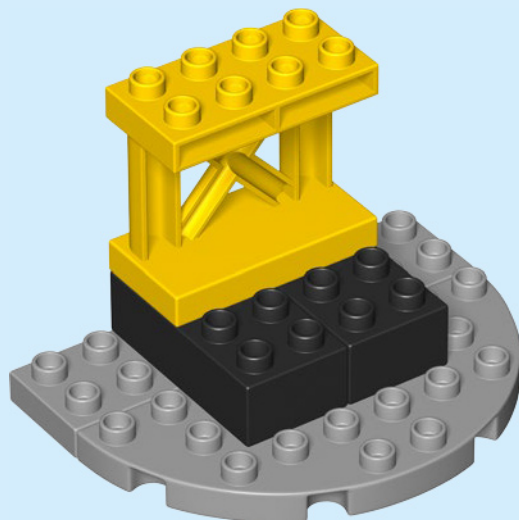

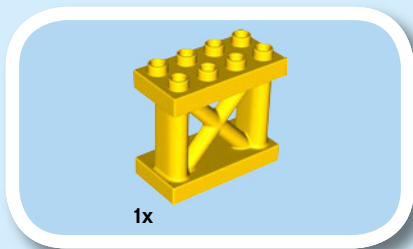

4

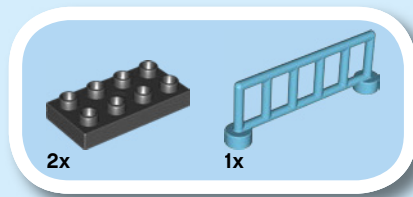
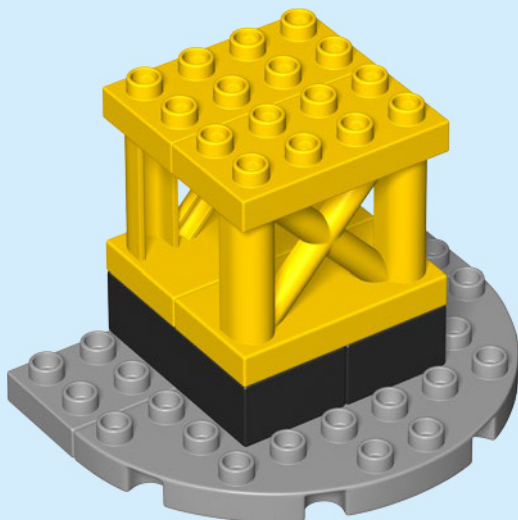

5

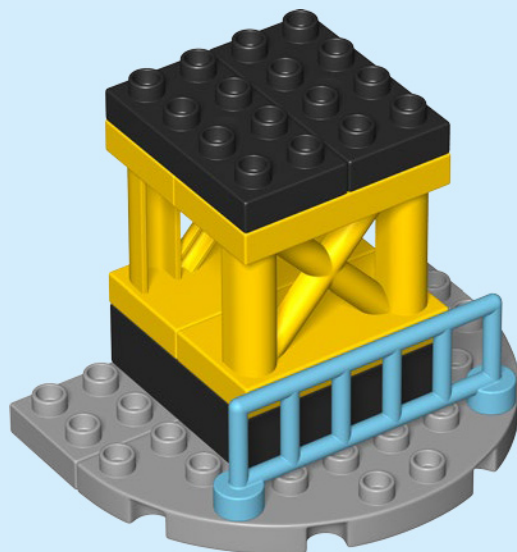



6

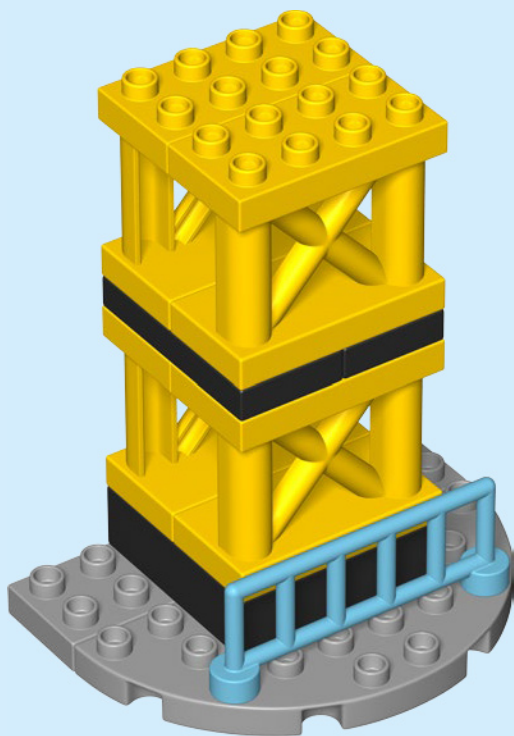

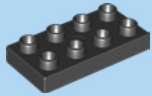

2x

7

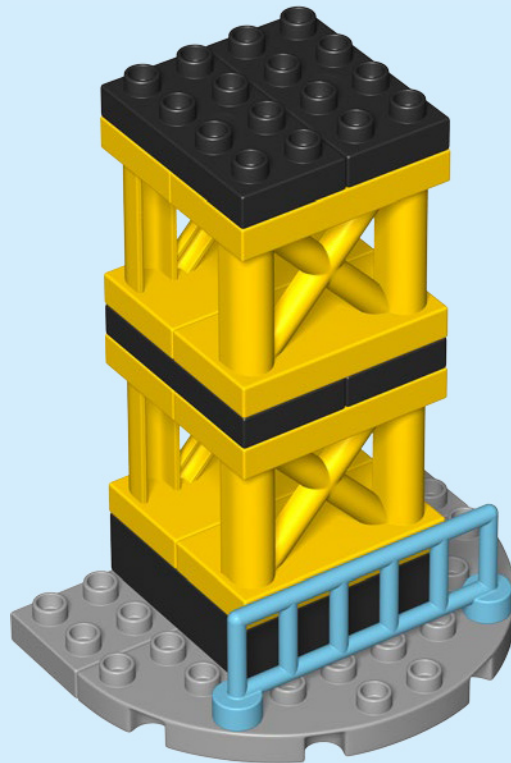

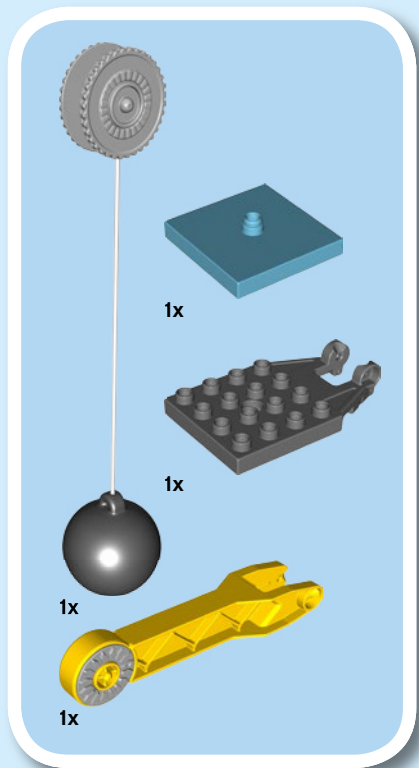

8

1

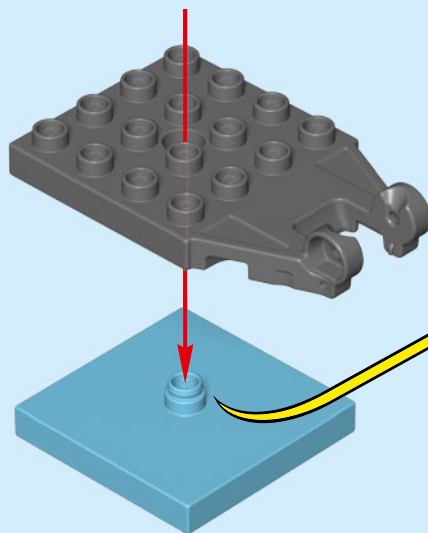

CLICK KLICK
CLIC CLIQUE
KATT KLIKŠKIS
卡塔

2

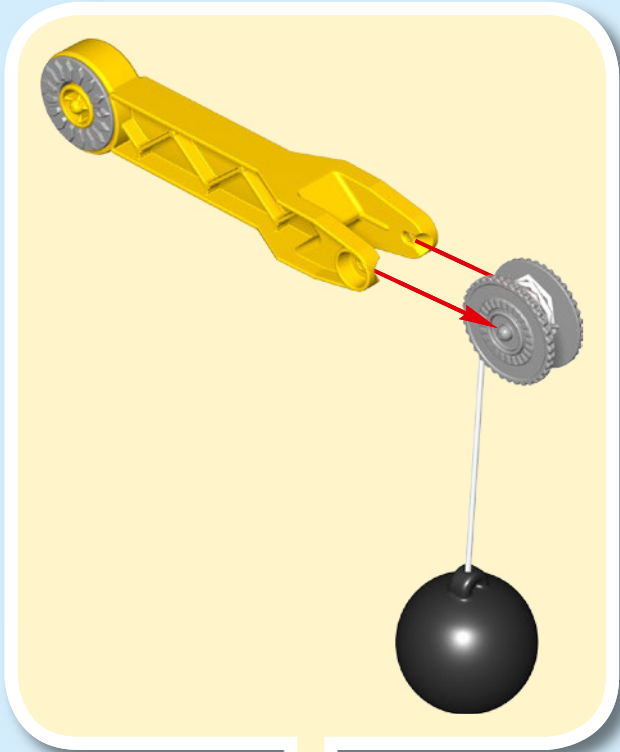
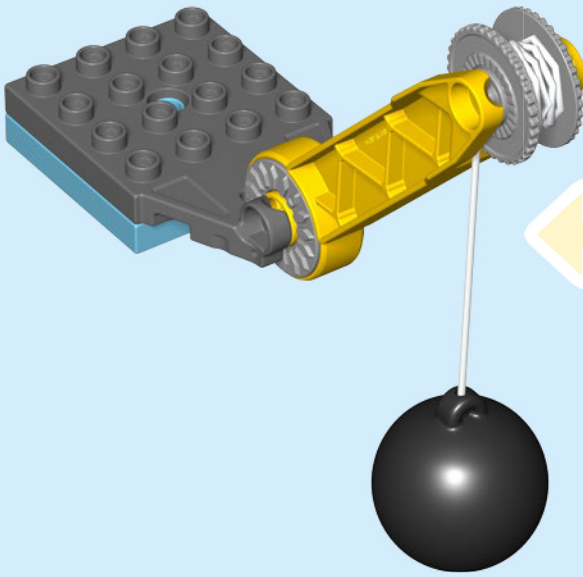

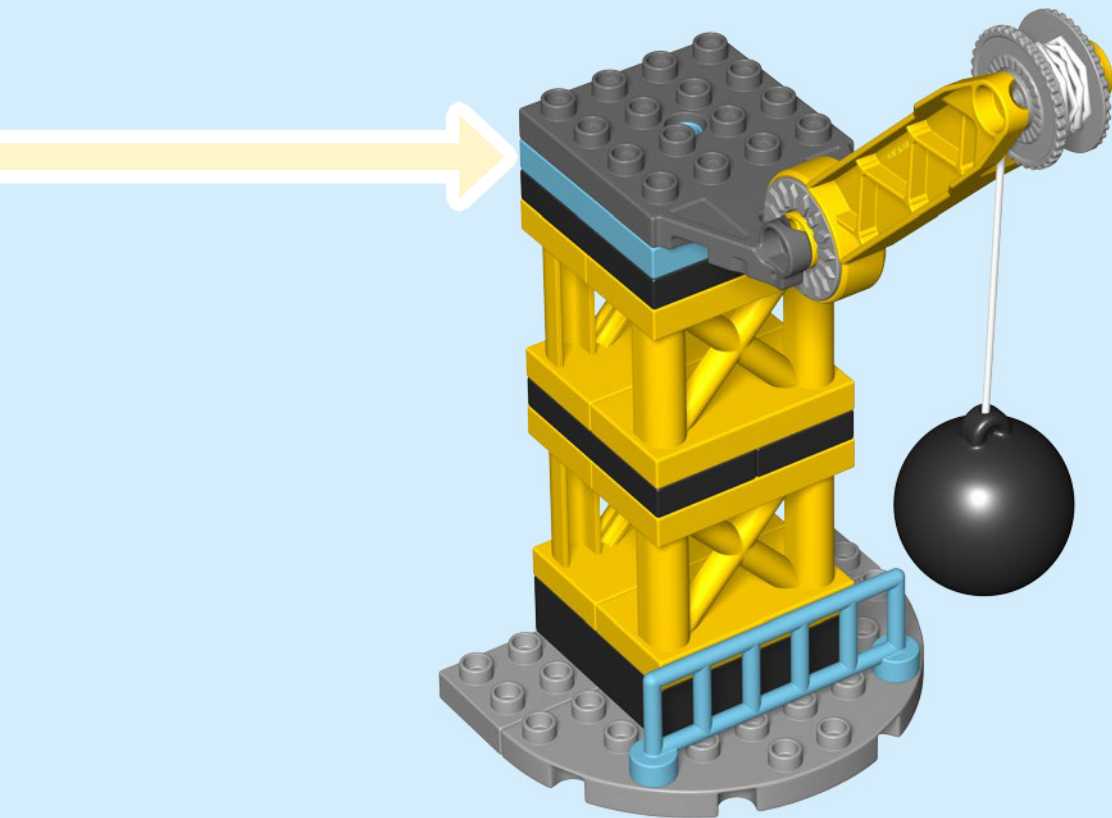



9

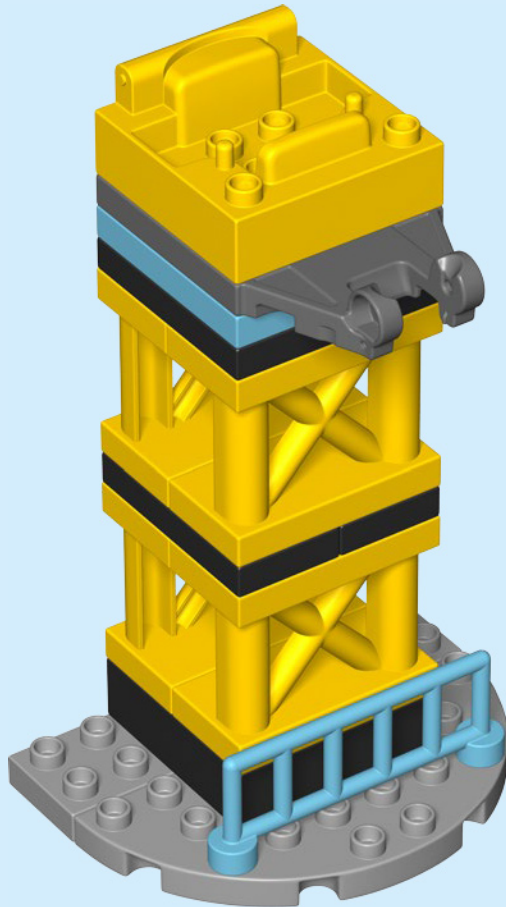

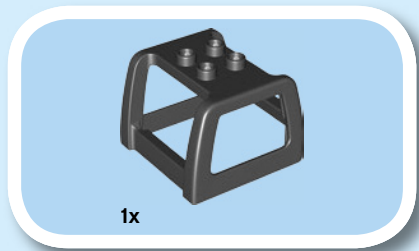

10

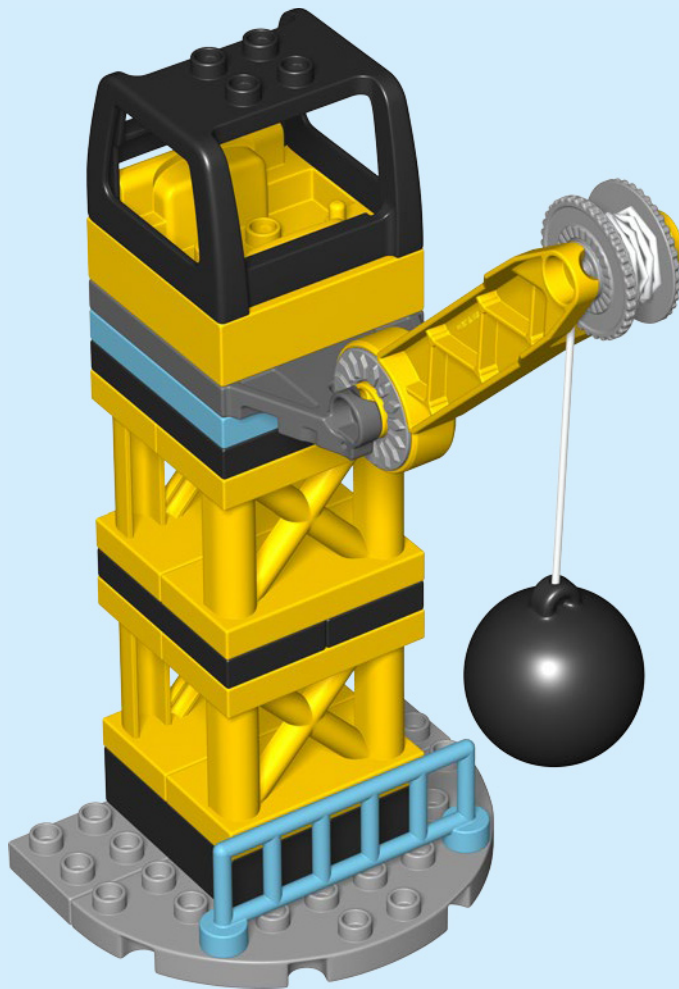



1x

11

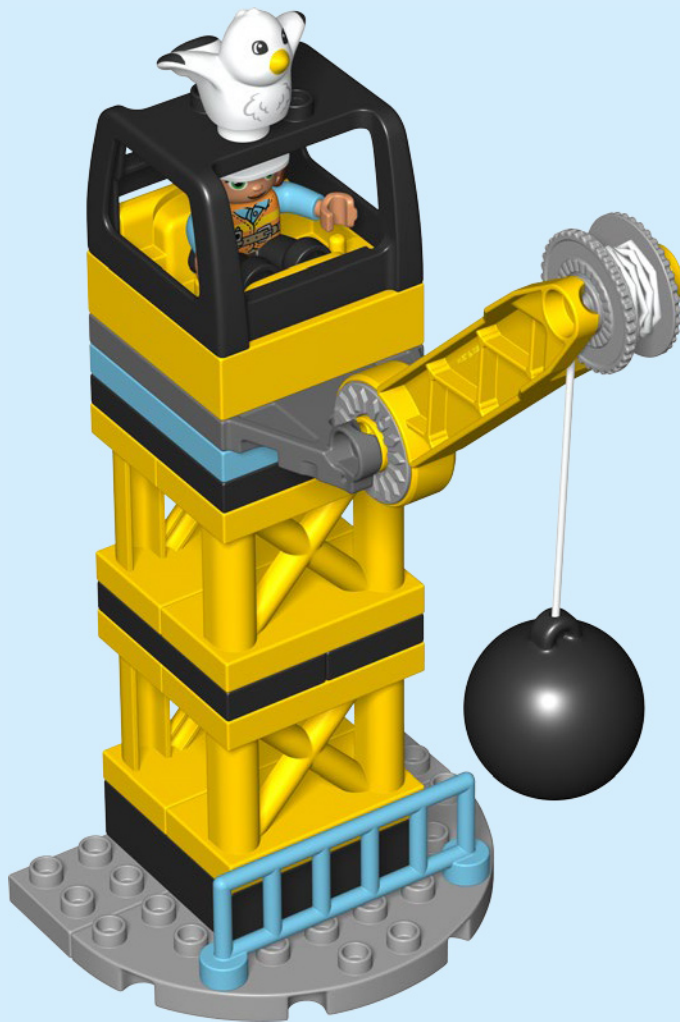

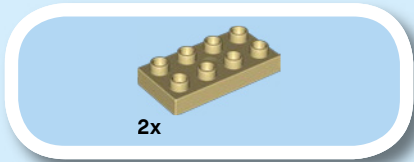

1

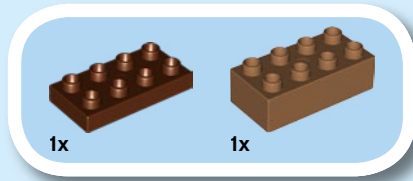
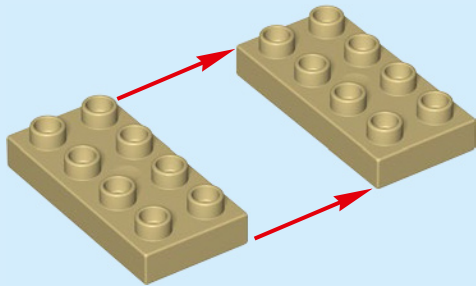

2

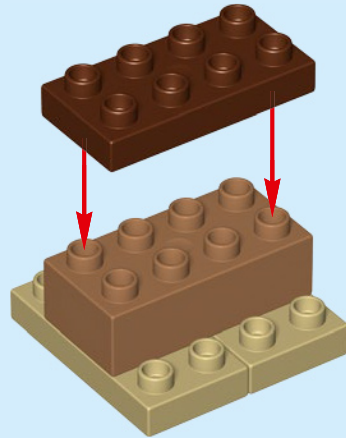

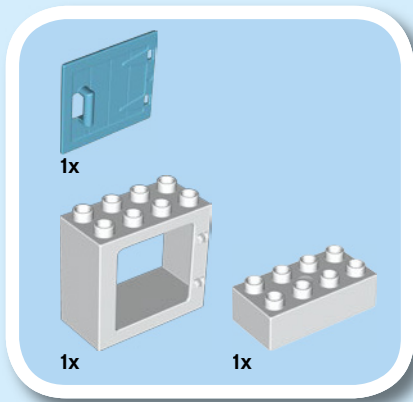

3

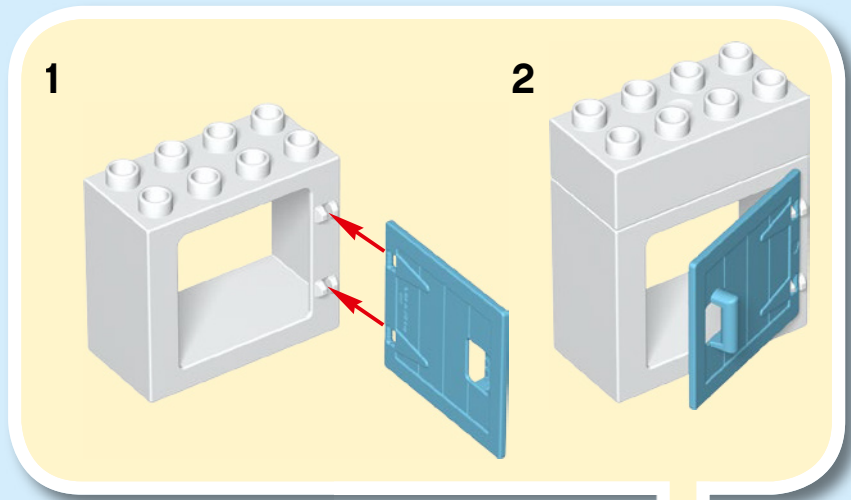

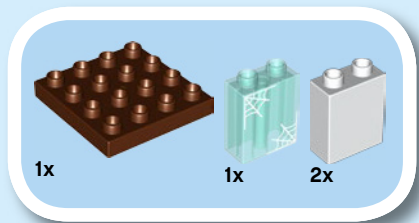

4

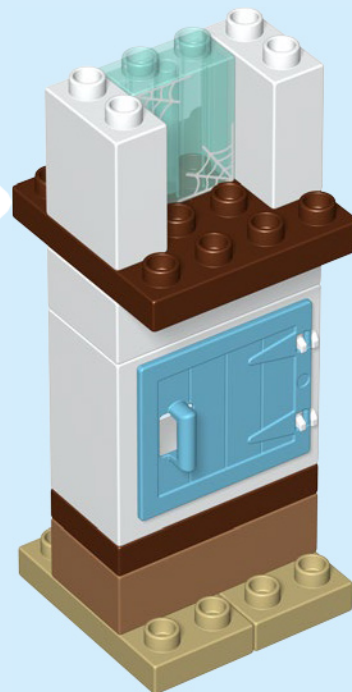
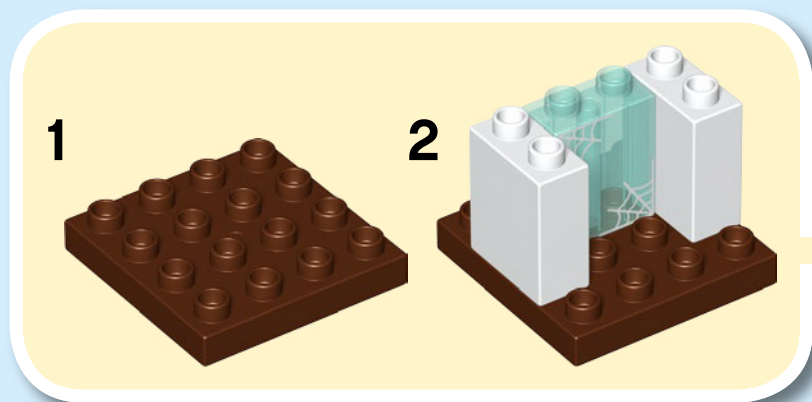

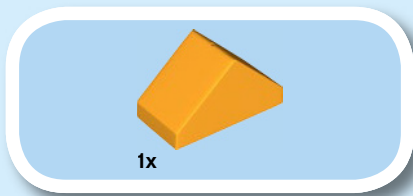

5



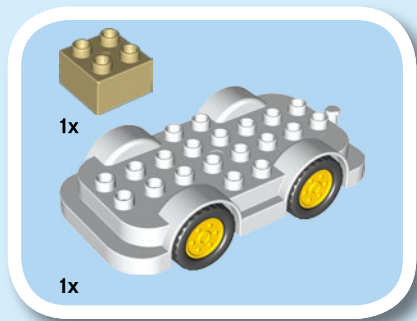

1



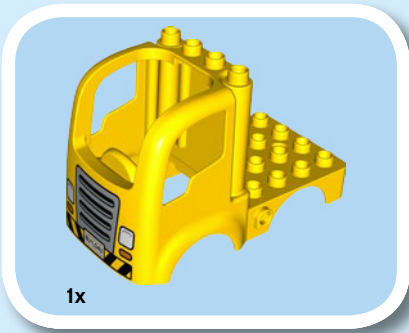

1x

2





1x

3



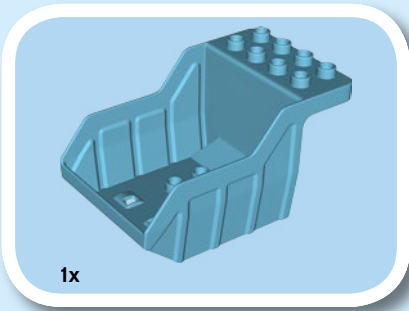

4

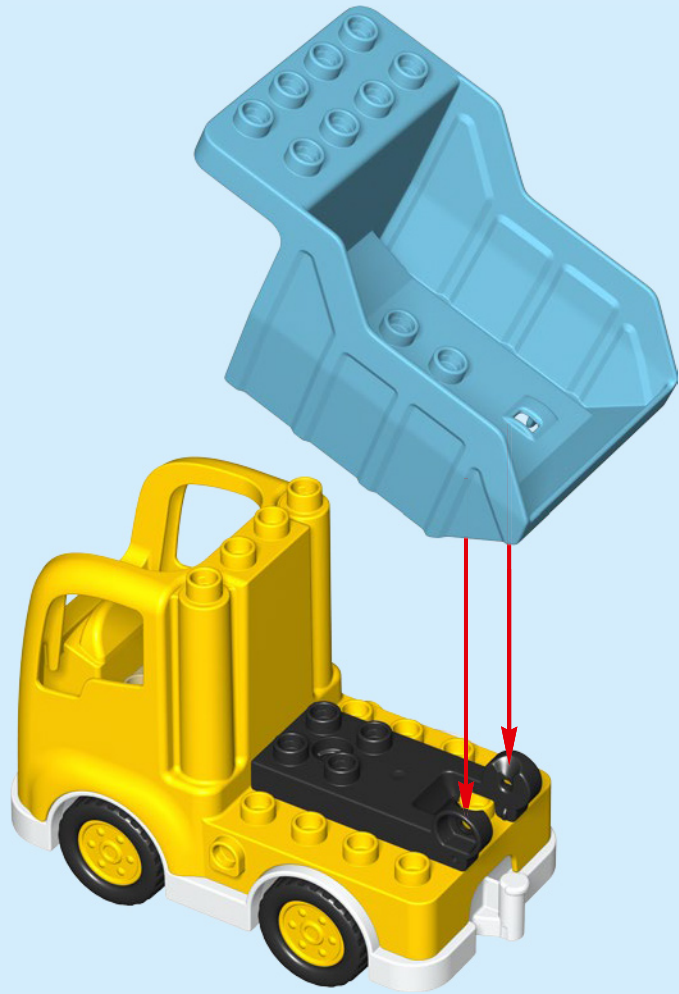

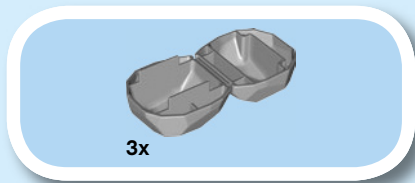

5

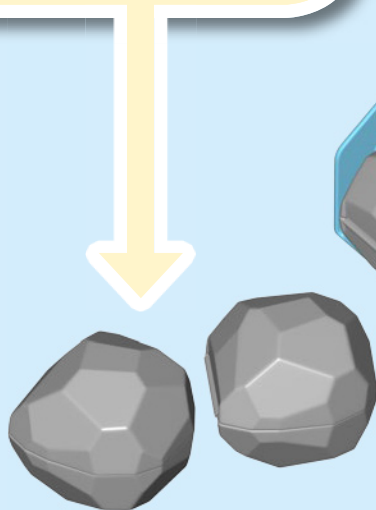
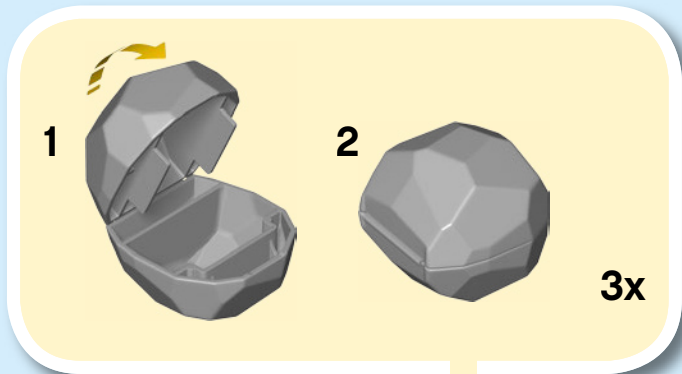

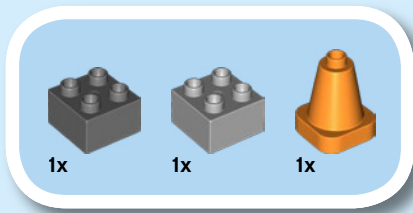

6





duplo



10915
Ages 1½+

Ages/edades

1½

10913
Ages 1½+



D'AUTRES
IDEES
INCLUSES

EXTRA
IDEAS
INCLUDED

INCLUYE
IDEAS
EXTRA



10933
Ages 2+

2+

**BRIQUE
LUMIERE**

**LADRILLO
LUMINOSO**

**LUMIERE
ET SON**

**LUZ Y
SONIDO**

**ACTIONNE
PAR POUSSEE**

PUSH-&-GO



duplo

A WORLD OF LEGO® DUPLO®

LE MONDE DE LEGO® DUPLO®

UN MUNDO DE LEGO® DUPLO®



The availability of apps is subject to the local strategies of the LEGO Group.

La disponibilité des applications est soumise aux stratégies locales du Groupe LEGO.

La disponibilidad de las apps está sujeta a las estrategias regionales de The LEGO Group.



Customer Service
Kundenservice
Service Consommateurs
Servicio Al Consumidor

LEGO.com/service or dial

					: 00800 5346 5555	
		: 1-800-422-5346				



Terms & Conditions apply

LEGO.com/productfeedback

GEWINNE

Erzähle uns auf
www.LEGO.com/productfeedback

etwas über die Erfahrungen, die du mit diesem LEGO® Set gemacht hast, und sichere dir die Chance auf einen coolen LEGO Preis!

Es gelten die Teilnahmebedingungen

GAGNE

Rends-toi sur
www.LEGO.com/productfeedback

et donne-nous quelques commentaires sur ce produit LEGO® pour avoir une chance de gagner un prix LEGO !

Voir Conditions Générales

GANA

Visita
www.LEGO.com/productfeedback

y envíanos tu opinión acerca de este set LEGO®. ¡Participarás en el sorteo de un premio LEGO!

Términos y Condiciones aplicables

获取奖品

登录
www.LEGO.com/productfeedback

给出关于此乐高®套装的简短反馈，就有机会获得炫酷乐高奖品

《条款及条件》适用

LEGO, the LEGO logo, DUPLO and the DUPLO logo are trademarks of the/son des marques de commerce du/son marcas registradas de LEGO Group.
©2020 The LEGO Group. All rights reserved/Tous droits réservés/Todos los derechos reservados.