

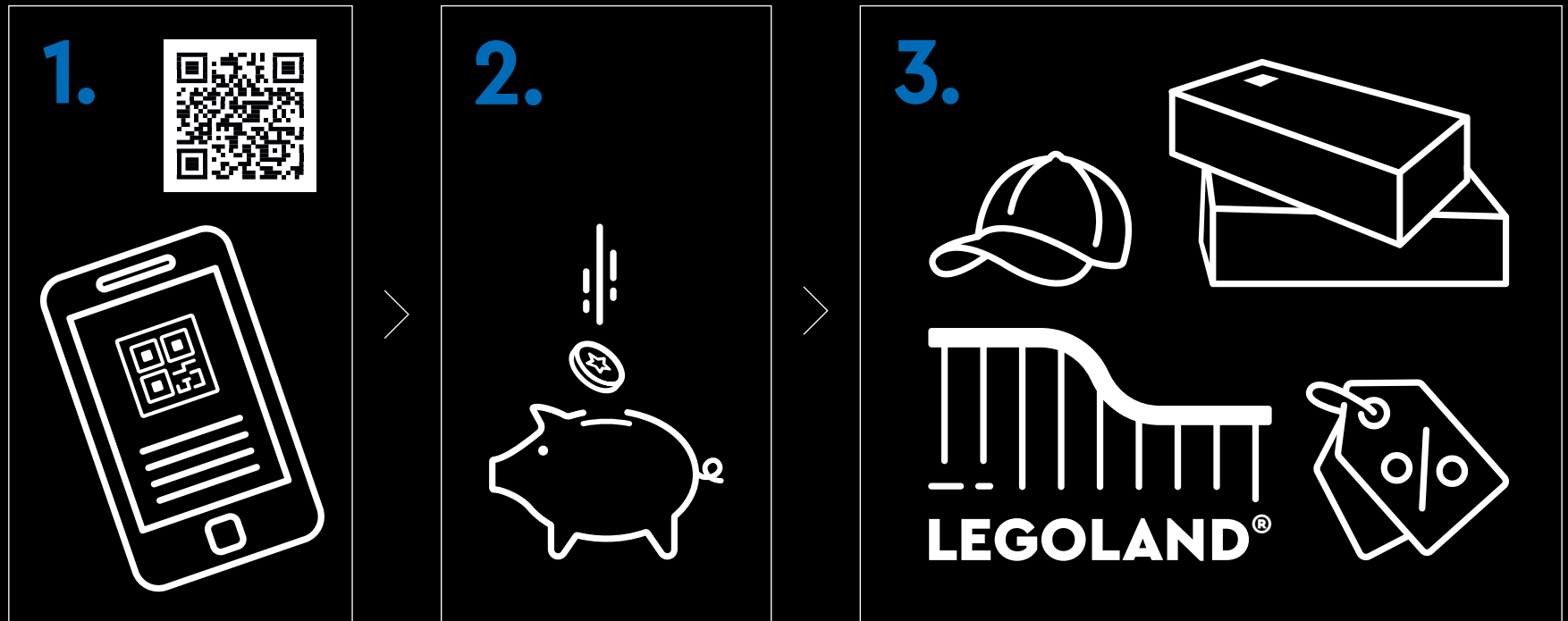



LEGO.com/sustainable-packaging

LEGO® VIP



1. Sign up **2.** Earn points for purchases **3.** Redeem points for rewards, experiences, discounts & more | **1.** Melde dich an **2.** Sammle Punkte bei jedem Kauf **3.** Löse die Punkte für Belohnungen, Erlebnisse, Rabatte und Ähnliches ein | **1.** Inscrivez-vous **2.** Gagnez des points lors de vos achats **3.** Échangez vos points contre des récompenses, des expériences, des remises et bien plus encore | **1.** Iscriviti **2.** Guadagna punti con i tuoi acquisti **3.** Riscatta punti per premi, esperienze, sconti e altro ancora | **1.** Regístrate **2.** Gana puntos por tus compras **3.** Canjea puntos por recompensas, experiencias, descuentos y mucho más | **1.** Registe-se **2.** Ganhe pontos em compras **3.** Troque os pontos para prêmios, experiências, descontos e muito mais | **1.** 注册 **2.** 购物赚积分 **3.** 用积分兑换奖励、体验、折扣等 | **1.** Zarejestruj się **2.** Zdobywaj punkty za zakupy **3.** Wymieniaj punkty na rabaty, przygody i inne nagrody | **1.** Zaregistrujte se **2.** Sbírejte body za nákupy **3.** Vyměňujte body za odměny, zážitky, slevy a spoustu dalšího | **1.** Zaregistrujte se **2.** Získavajte body za nákupy **3.** Uplatnite si body a získajte odmeny, rôzne zážitky, zľavy a ešte viac | **1.** Regisztrálj **2.** Szerezz pontokat minden vásárlással **3.** Váltsd be pontjaidat jutalmakra, élményekre, kedvezményekre és egyebekre | **1.** Înscric-te **2.** Câștigă puncte pentru achiziții **3.** Valorifică puncte pentru recompense, experiențe, reduceri și multe altele | **1.** Регистрируйте се **2.** Получайте точки за покупки **3.** Используйте точки за награды, услуги, отстъпки и т.н. | **1.** Reģistrējies **2.** Pelni punktus par pirkumiem **3.** Izmanto punktus, lai saņemtu balvas, izklaides iespējas, atlaides un daudz ko citu | **1.** Registreeru **2.** Teeni ostude eest punkte **3.** Lunasta punktide eest preemiad, elamused, allahindlused ja muu | **1.** Užsiregistruokite **2.** Pelnykite taškų už pirkinius **3.** Panaudokite taškus atlygiui, funkcijoms, nuolaidoms ir ne tik





BENVENUTI A GRAN BURRONE

A 20 anni dall'uscita de *Il ritorno del re*, la spettacolare trilogia de *Il Signore degli Anelli* rimane una delle opere cinematografiche più significative del nostro tempo. Come si può scegliere una scena o un momento preferito? Nei tempi più bui, Gran Burrone, la maestosa dimora degli Elfi, è un rifugio tranquillo e fiorente, pieno di speranza, calma, unificazione e guarigione. Qui, in un incontro cruciale, i rappresentanti dei popoli della Terra di Mezzo forgiavano *La Compagnia dell'Anello* per distruggere l'Unico Anello che li governa tutti.



*La compagnia dei
designer LEGO®*

UNA COMPAGNIA DI DESIGNER LEGO®

Tutti appartenenti a una compagnia di designer di modelli, elementi e grafica di tutto il mondo, abbiamo intrapreso un viaggio per catturare la magia di questo luogo. Utilizzando le cianografie dei film come riferimento, ci siamo presi alcune libertà artistiche per combinare le nostre caratteristiche preferite. Questa ricostruzione in 6.000 mattoncini LEGO® dell'iconica Imladris, l'Ultima Casa Accogliente, è uno spaccato dettagliato di Gran Burrone in scala di minifigure LEGO, ricco di momenti memorabili della storia e di personaggi amati.



SCENE CLASSICHE DE IL SIGNORE DEGLI ANELLI LEGO®

Dall'arrivo di Gandalf il Grigio nella Contea fino alla battaglia finale contro il Re dei Morti sulle rive di Minas Tirith, potrai esplorare alcune delle scene classiche dei precedenti set LEGO® de *Il Signore degli Anelli*, usciti nel 2012-2013.



9469 L'ARRIVO DI GANDALF™

Gandalf il Grigio si reca nella Contea per il 111° compleanno del suo amico, Bilbo Baggins. Qui incontra il giovane Frodo Baggins e l'avventura ha inizio.



79006 IL CONSIGLIO DI ELROND

Il popolo della Terra di Mezzo è stato convocato a Gran Burrone per il Consiglio di Elrond. Qui determineranno il destino dell'Unico Anello.



9473 LE MINIERE DI MORIA™

L'eroica Compagnia dell'Anello affronta i malvagi orchi Moria e un gigantesco troll delle caverne nella tomba di Balin nelle agghiaccianti Miniere di Moria abbandonate.



9474
LA BATTAGLIA DI HELM'S DEEP™
La fortezza di Helm's Deep e il popolo di Rohan sono attaccati dal barbaro esercito di Uruk-hai di Saruman.



10237
LA TORRE DI ORTHANC
Il più grande set LEGO® de Il Signore degli Anelli al suo lancio (con 2.357 pezzi) presenta sei piani con iconiche minifigure e scene.



79008
L'AGGUATO DEL GALEONE DEI PIRATI
Gli orchi Mordor di Sauron si preparano a dare il benvenuto ai loro alleati a bordo della nave pirata, ma invece devono affrontare Aragorn, Gimli, Legolas e l'Esercito dei Morti.



LA TORRE

Durante il suo soggiorno a Gran Burrone, Bilbo completa il suo libro "There and Back Again" alla sua scrivania nella Torre. Un nascondiglio segreto alla base della Torre è abbastanza grande da nascondere un fuggitivo o tenere l'Unico Anello lontano da occhi indiscreti.

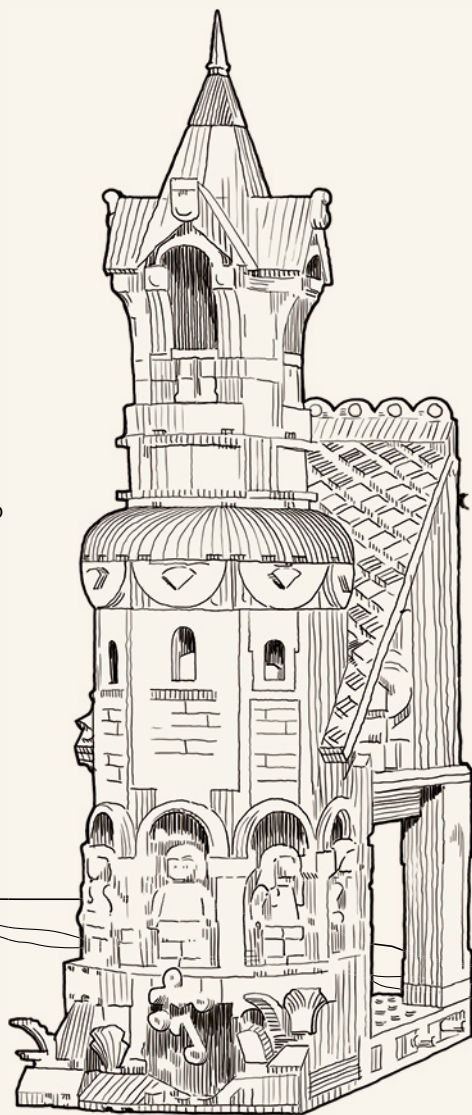

Frodo presenta gambe a doppio stampo per mostrare i suoi piedi nudi, una caratteristica distintiva degli Hobbit della Contea. Indossa anche l'Unico Anello, portato a Gran Burrone affinché il consiglio ne decida il destino.

FRODO BAGGINS



Bilbo presenta una nuova decorazione della testa a 2 lati, incluso il volto spaventoso che rivela brevemente mentre cerca di riprendersi l'Anello da Frodo.

BILBO BAGGINS



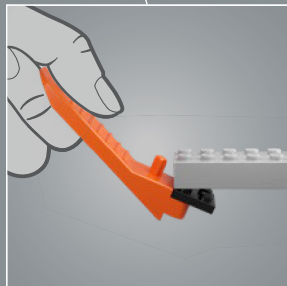
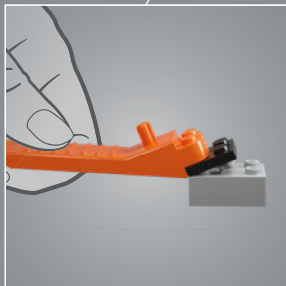
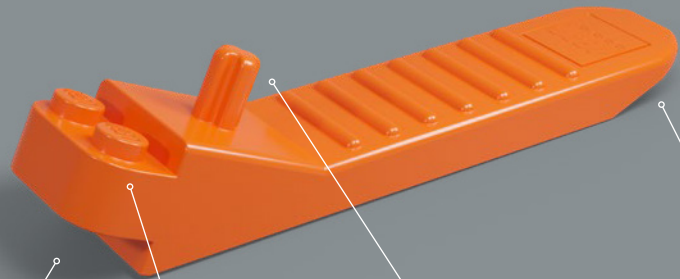

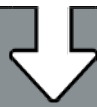

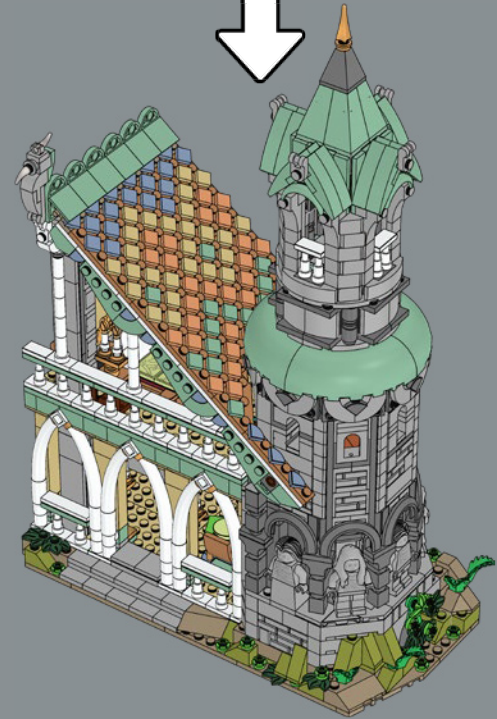



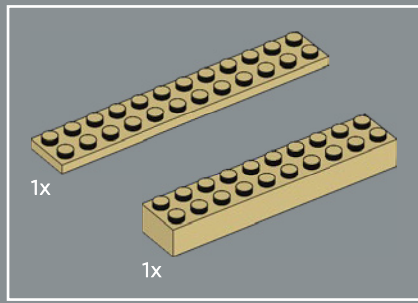

1

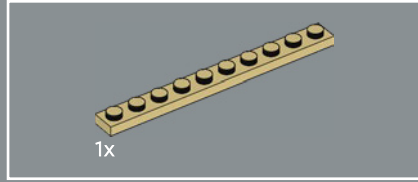
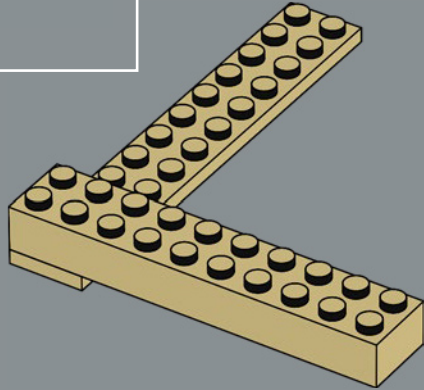

2

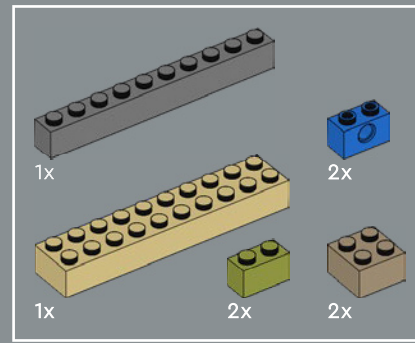
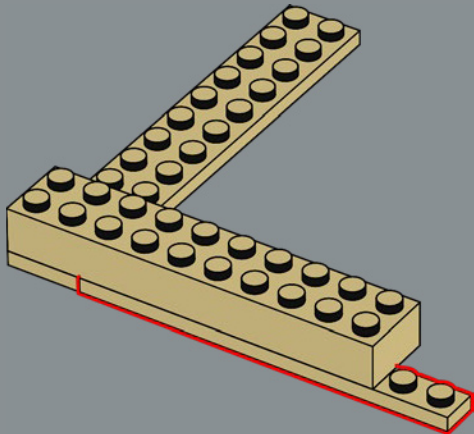

3

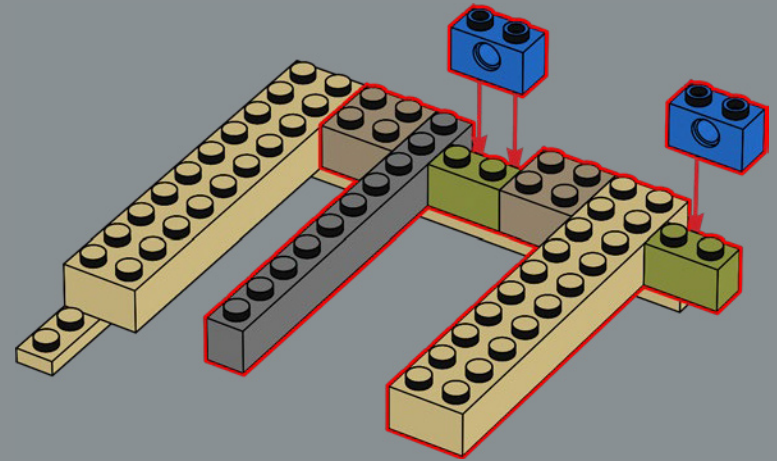

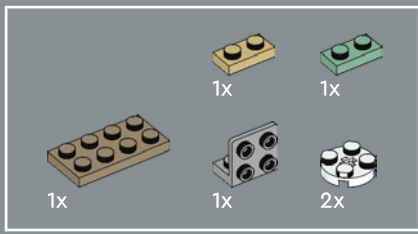

4

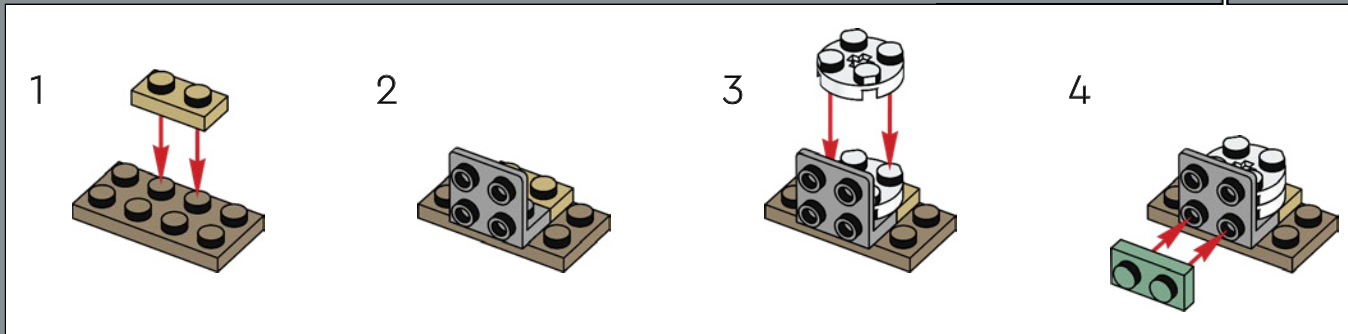
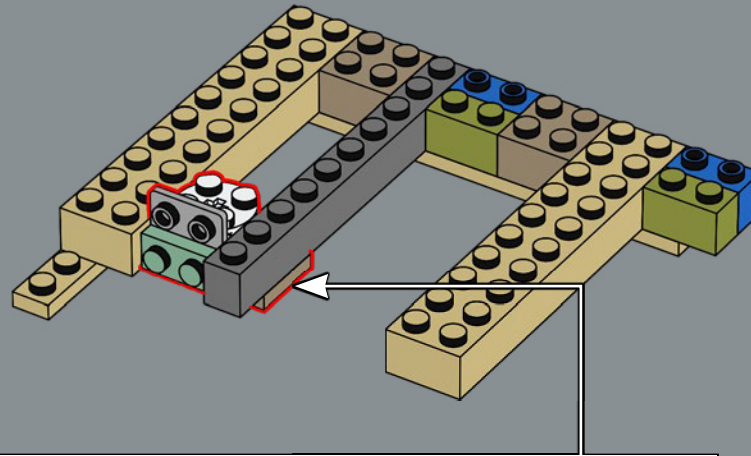

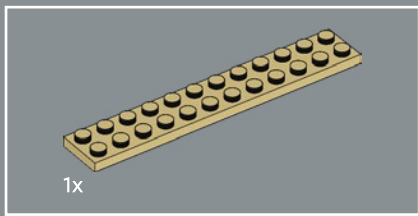

5

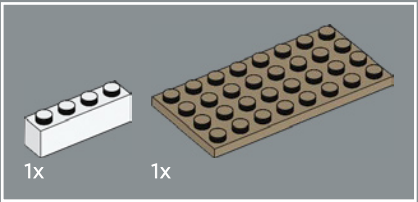
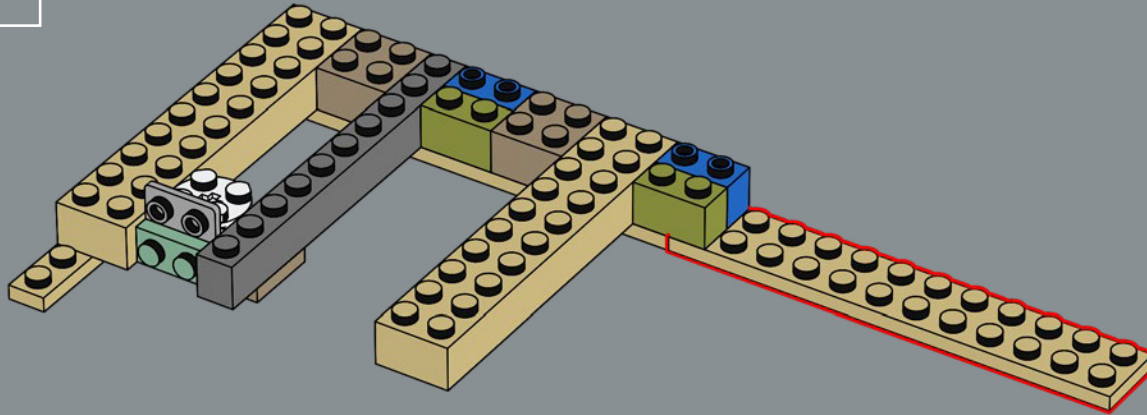

6

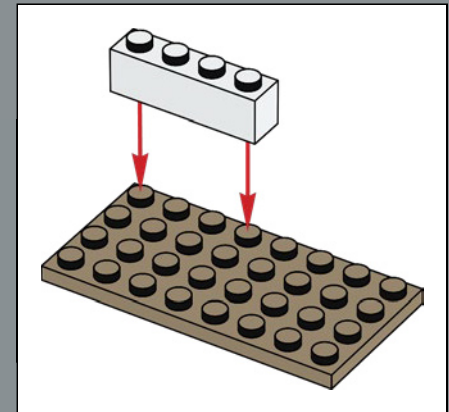
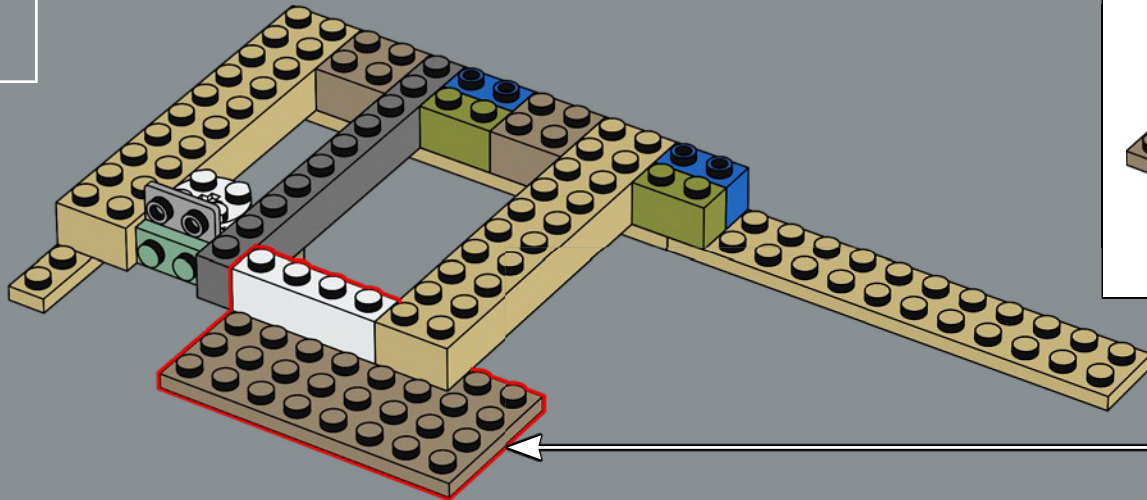

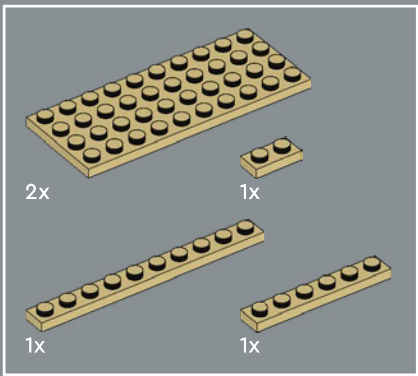

7

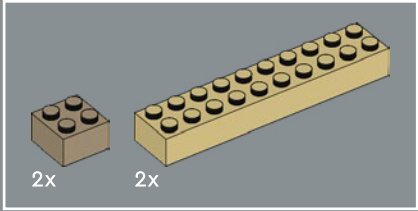
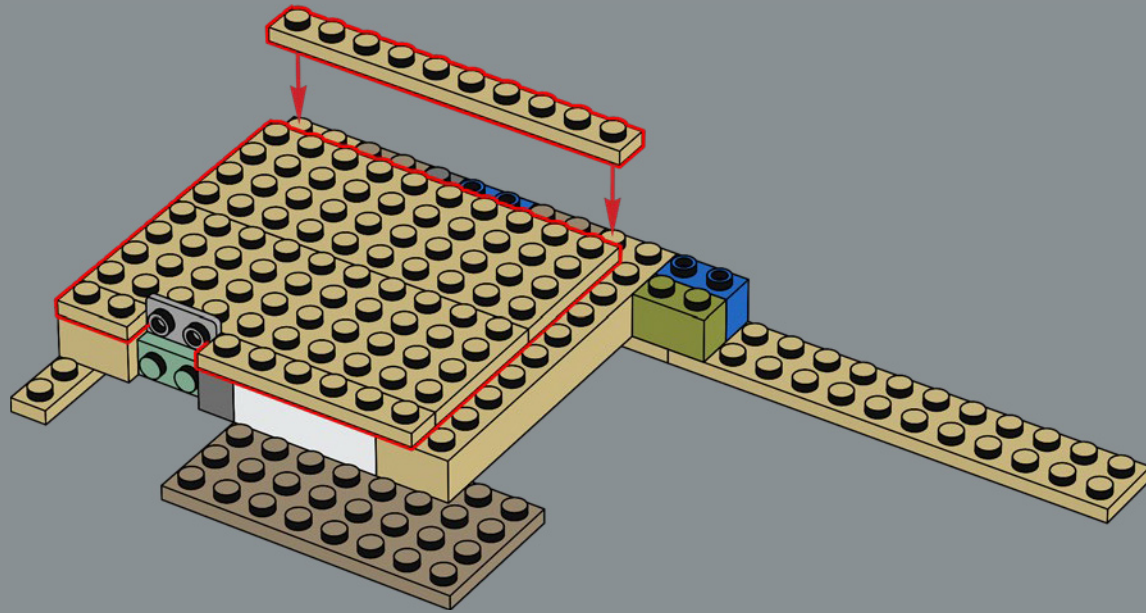

8

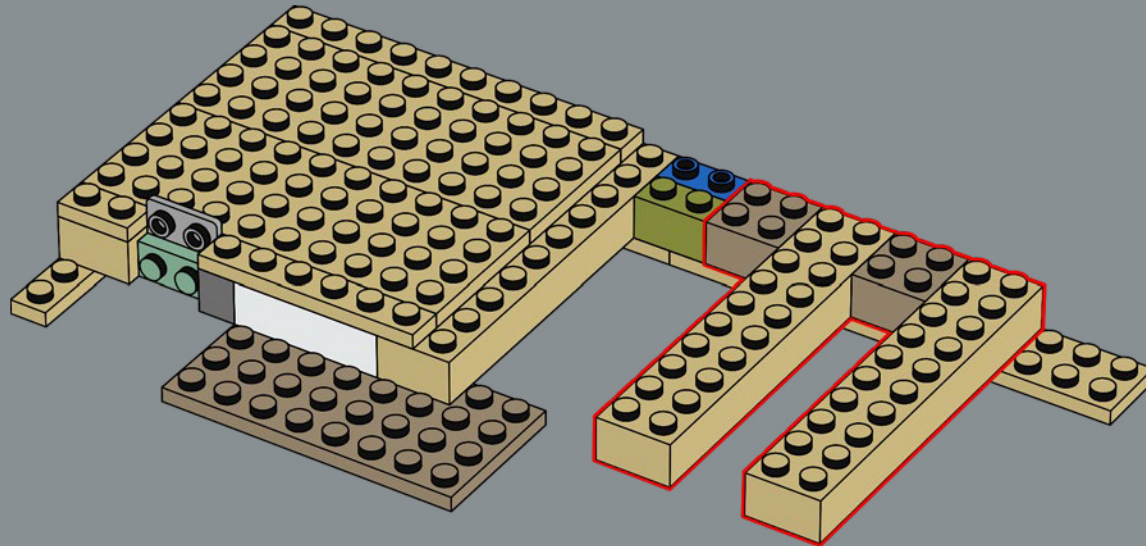

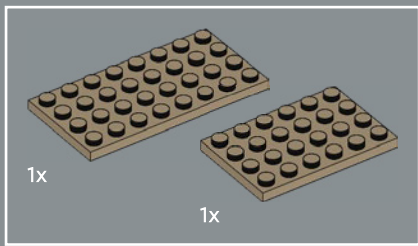

9

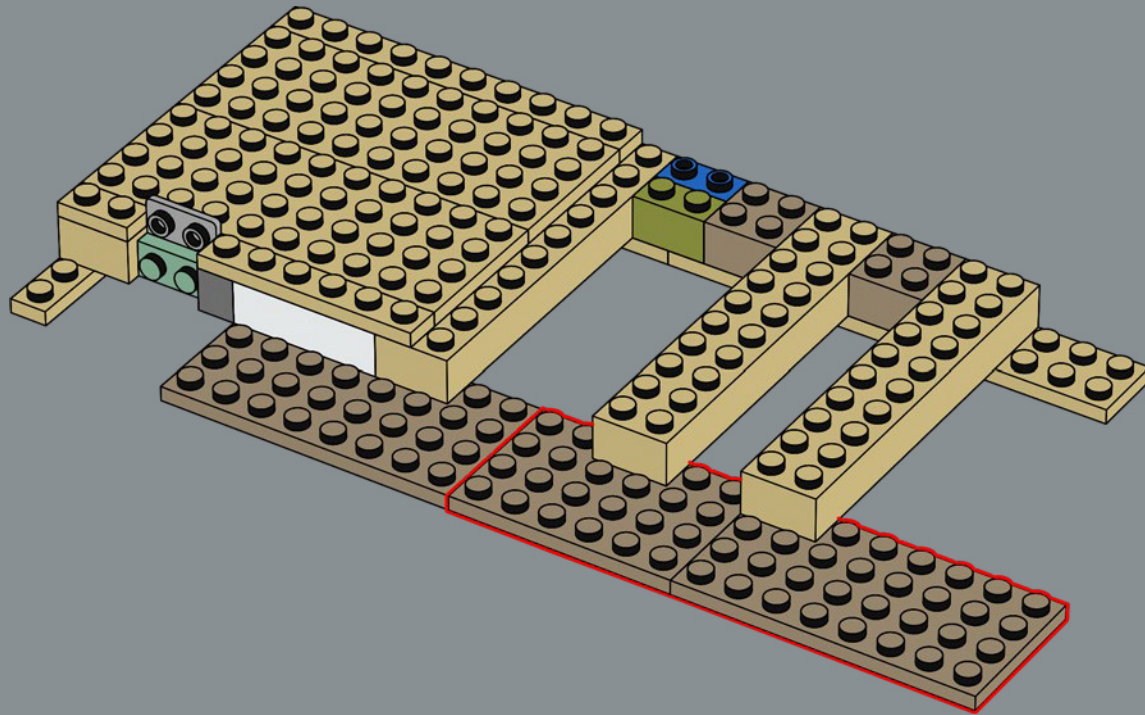

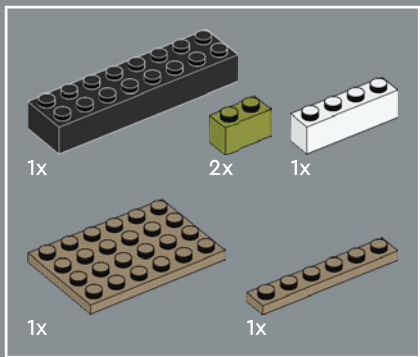

10

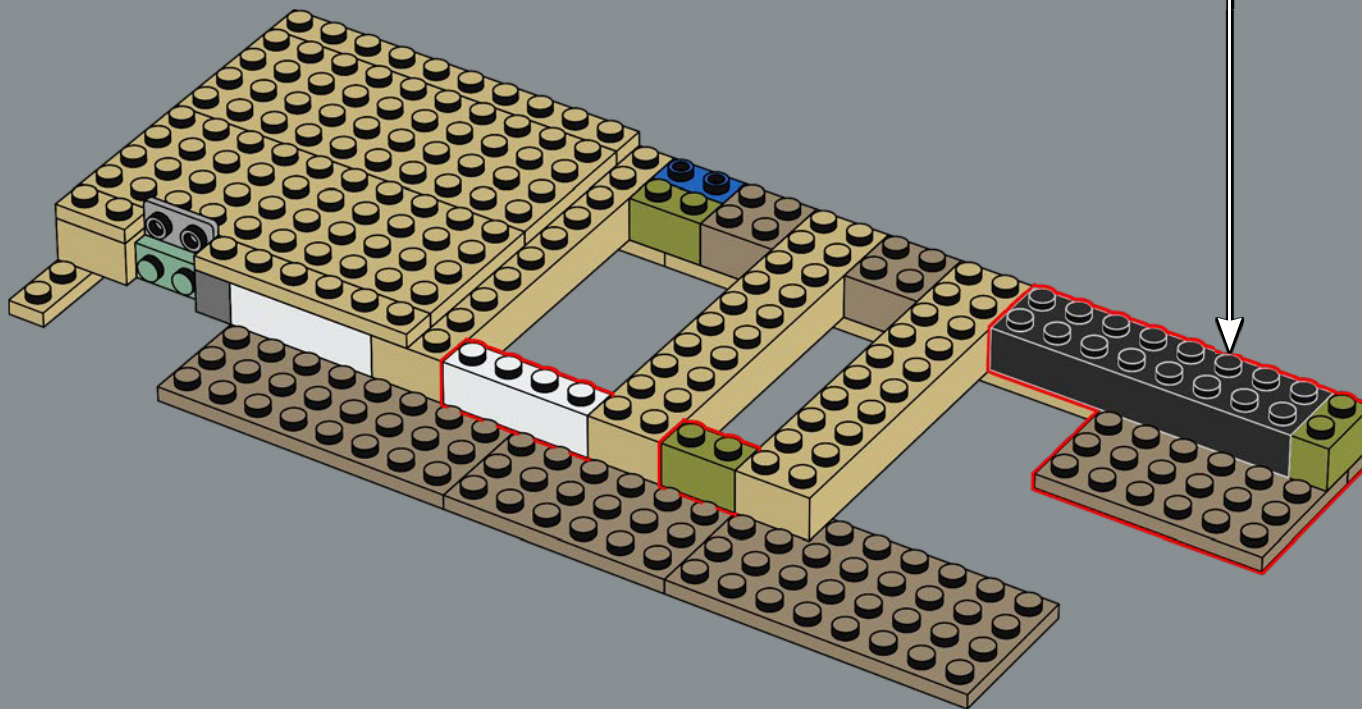
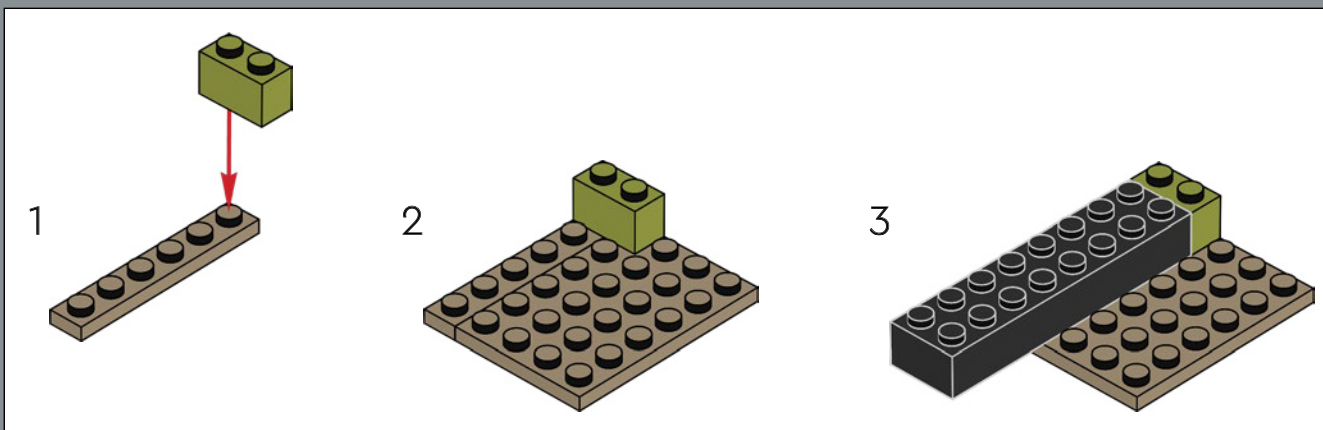

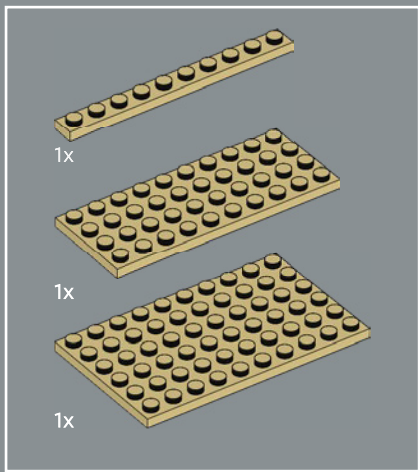

11

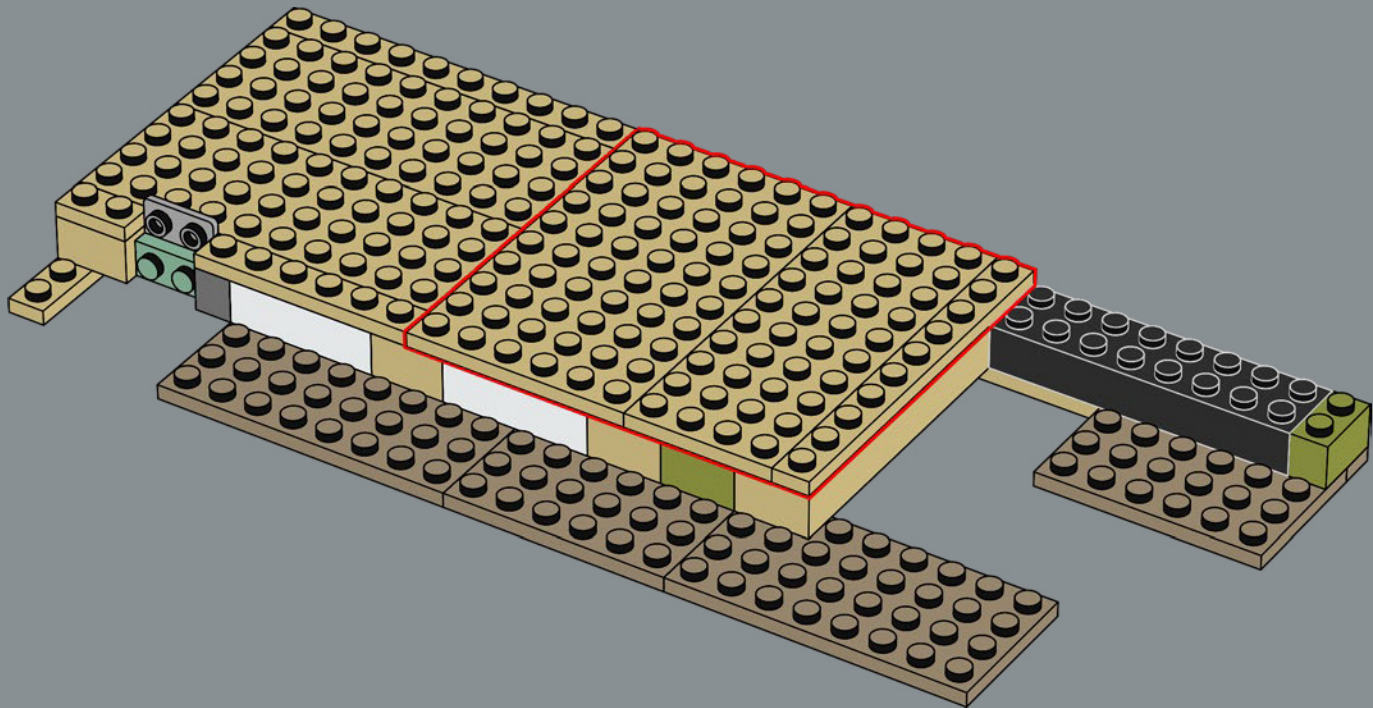

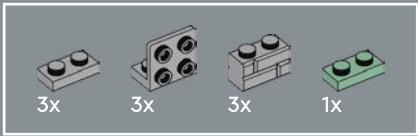

12

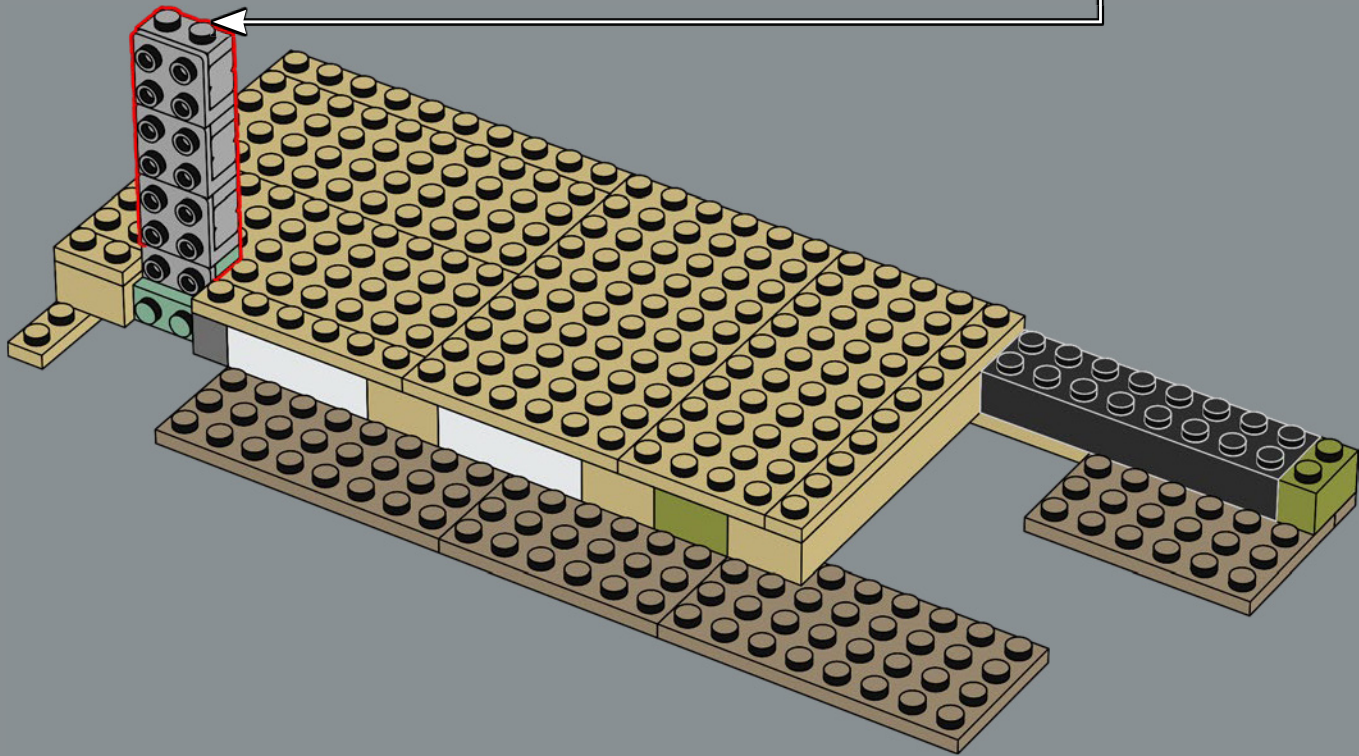
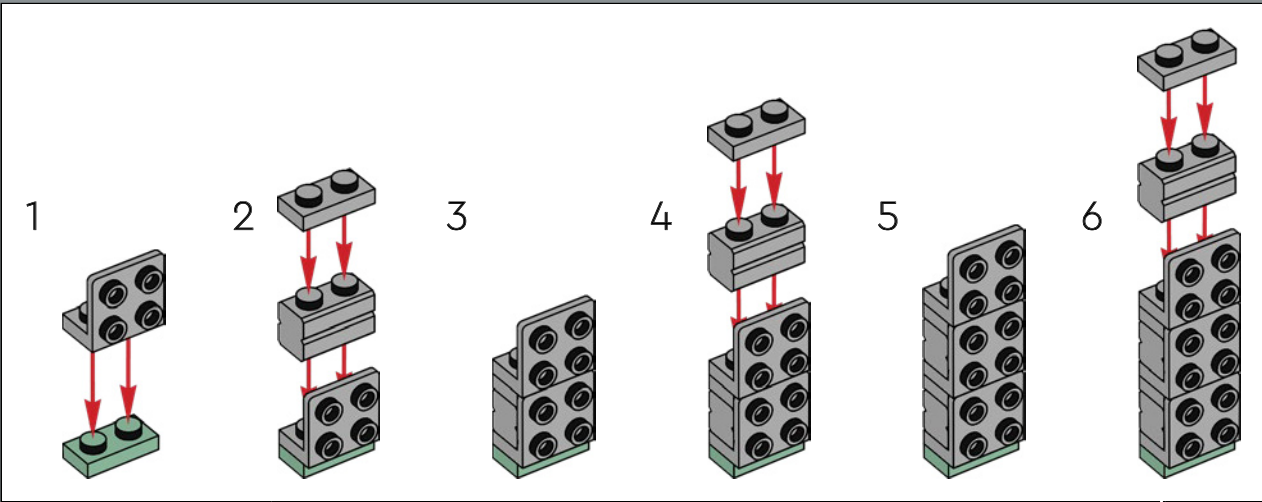

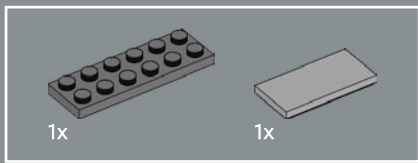

13

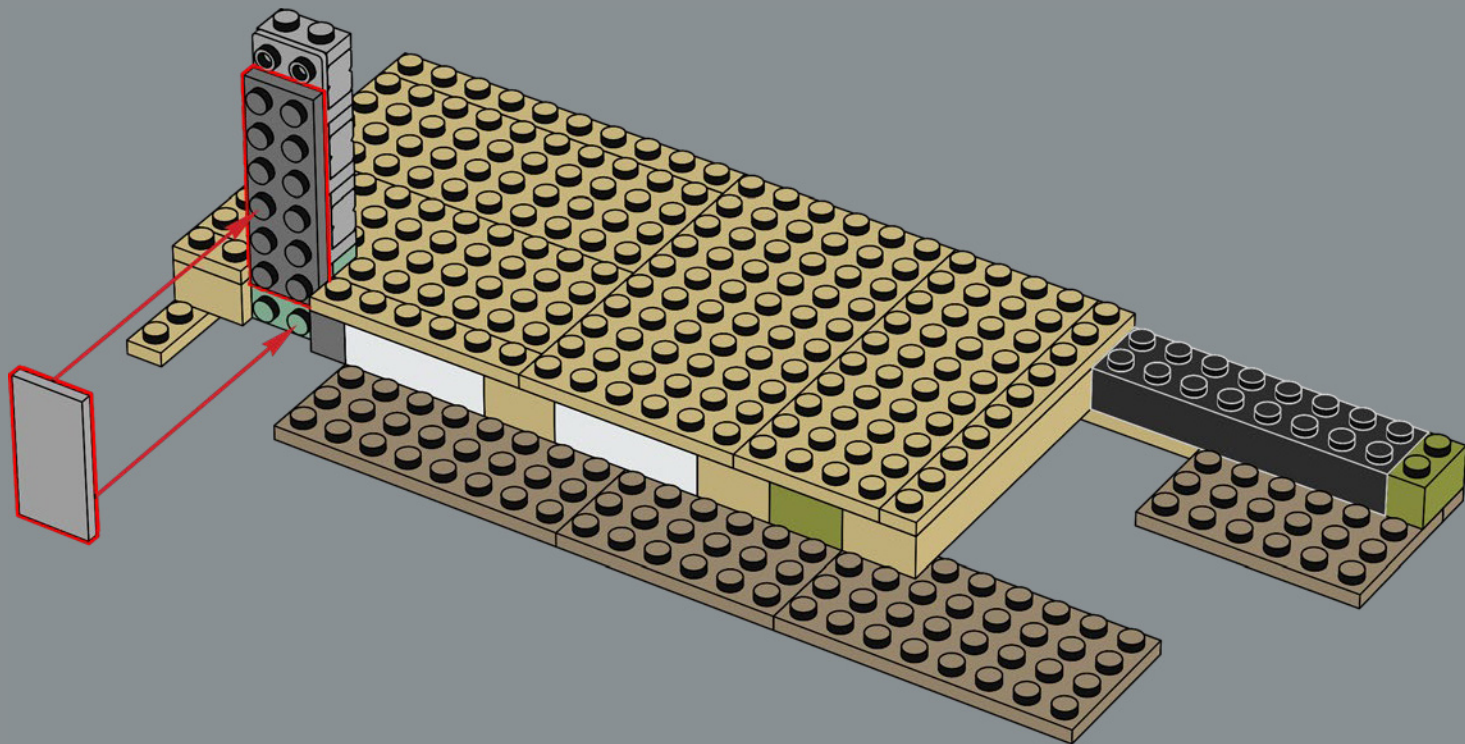

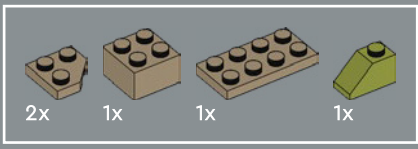

14

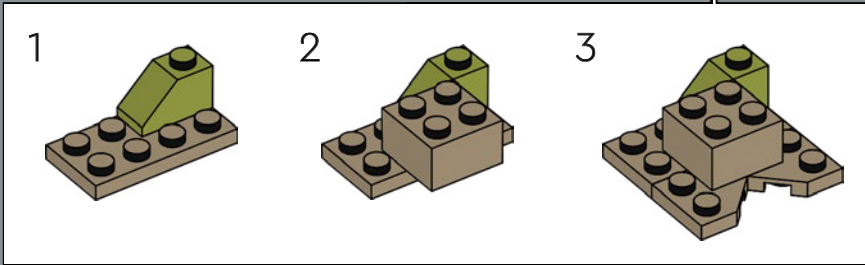
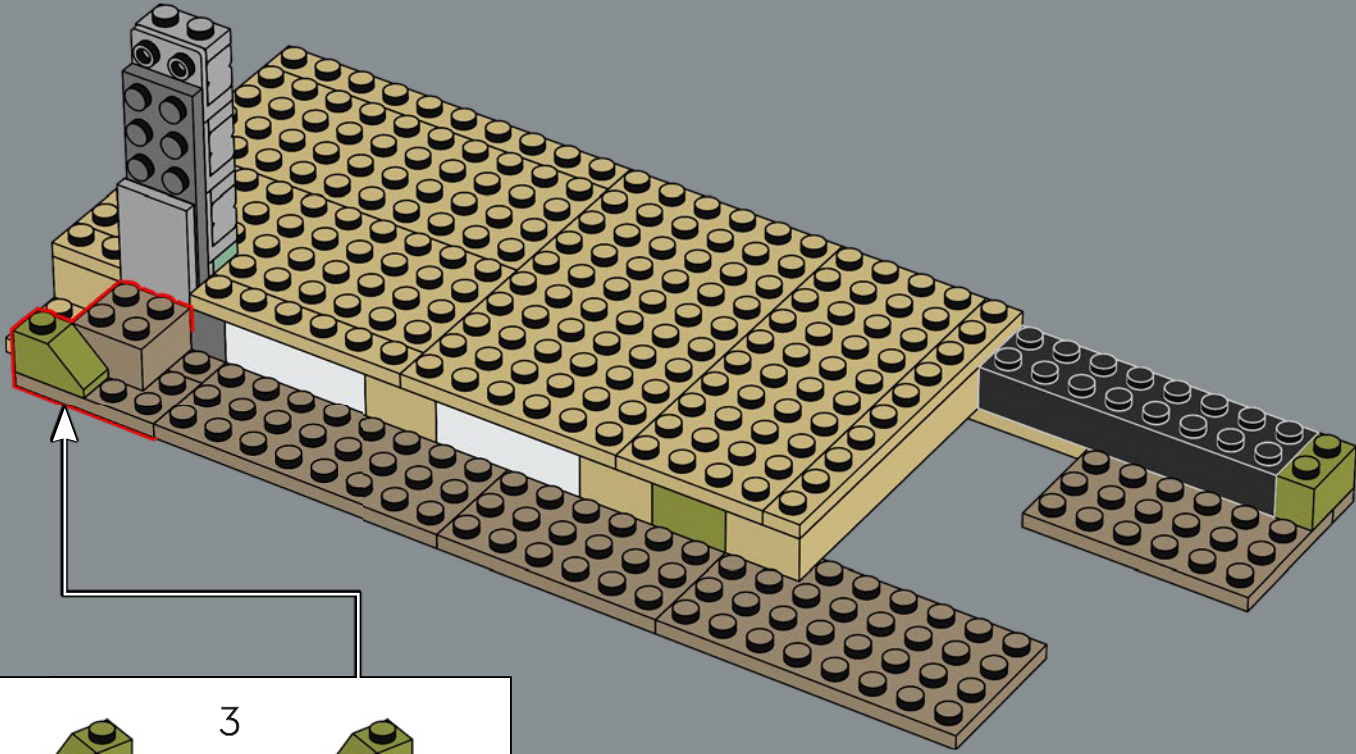

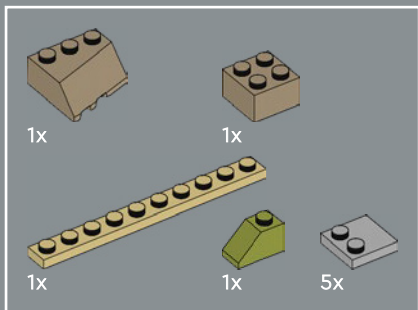

15

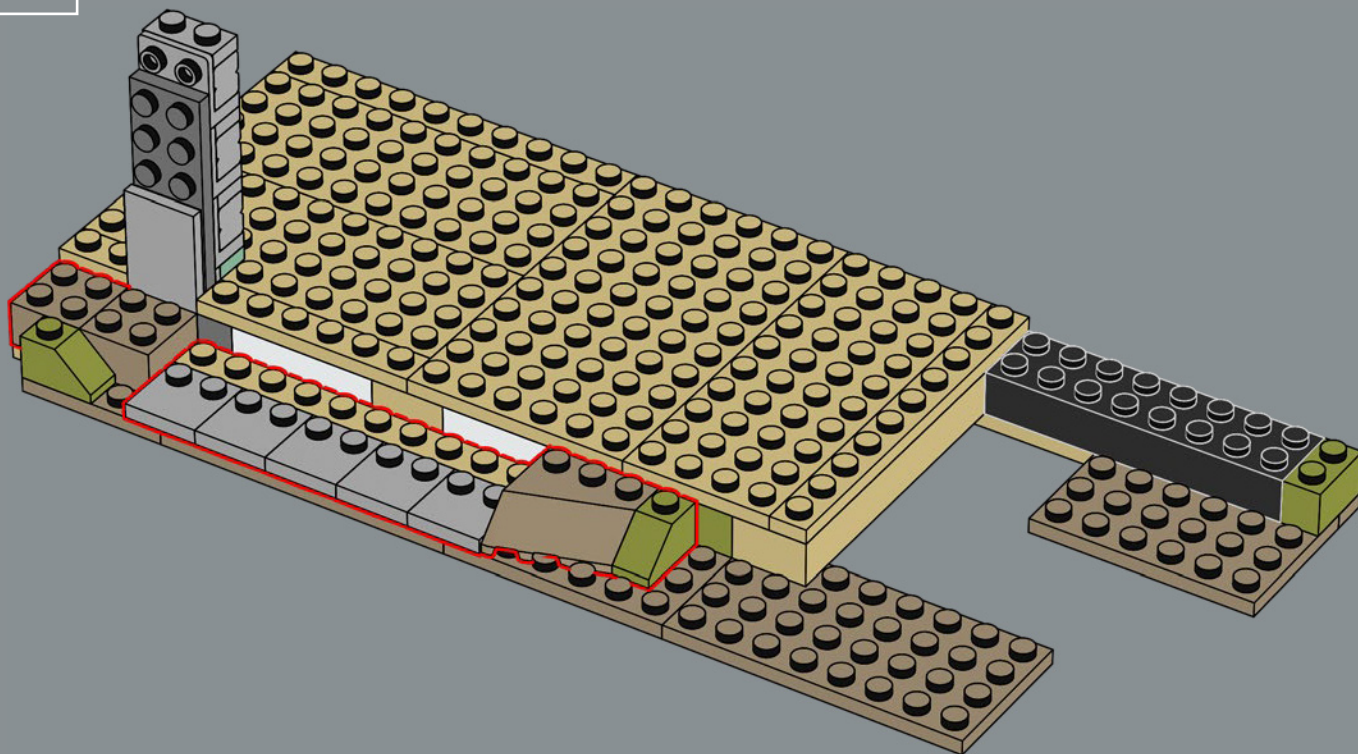

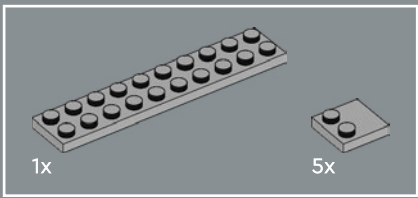

16

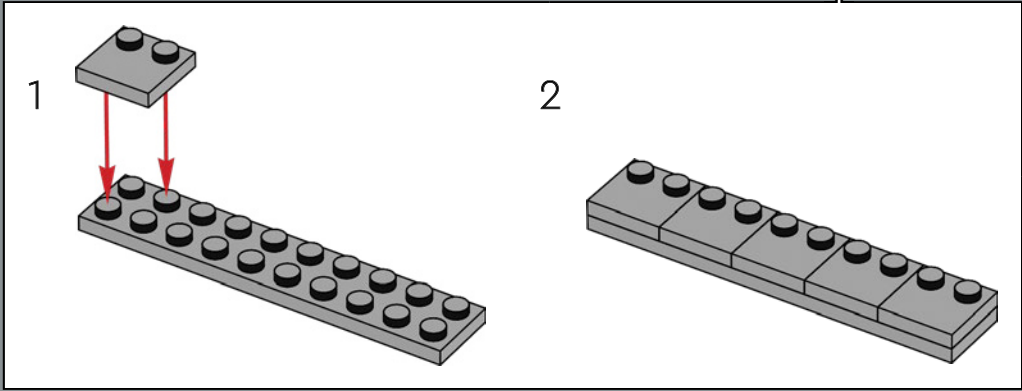
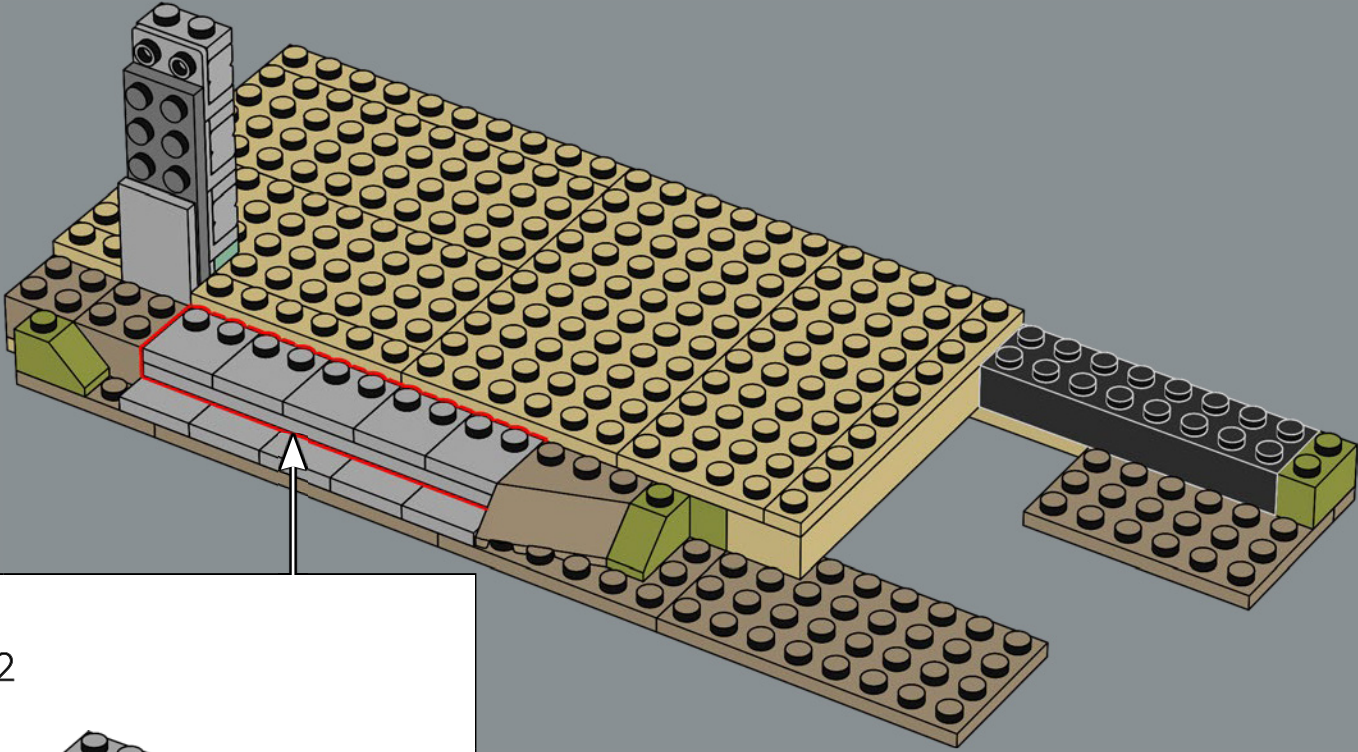

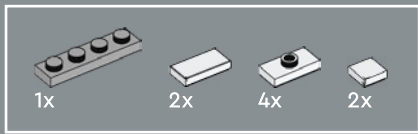

17

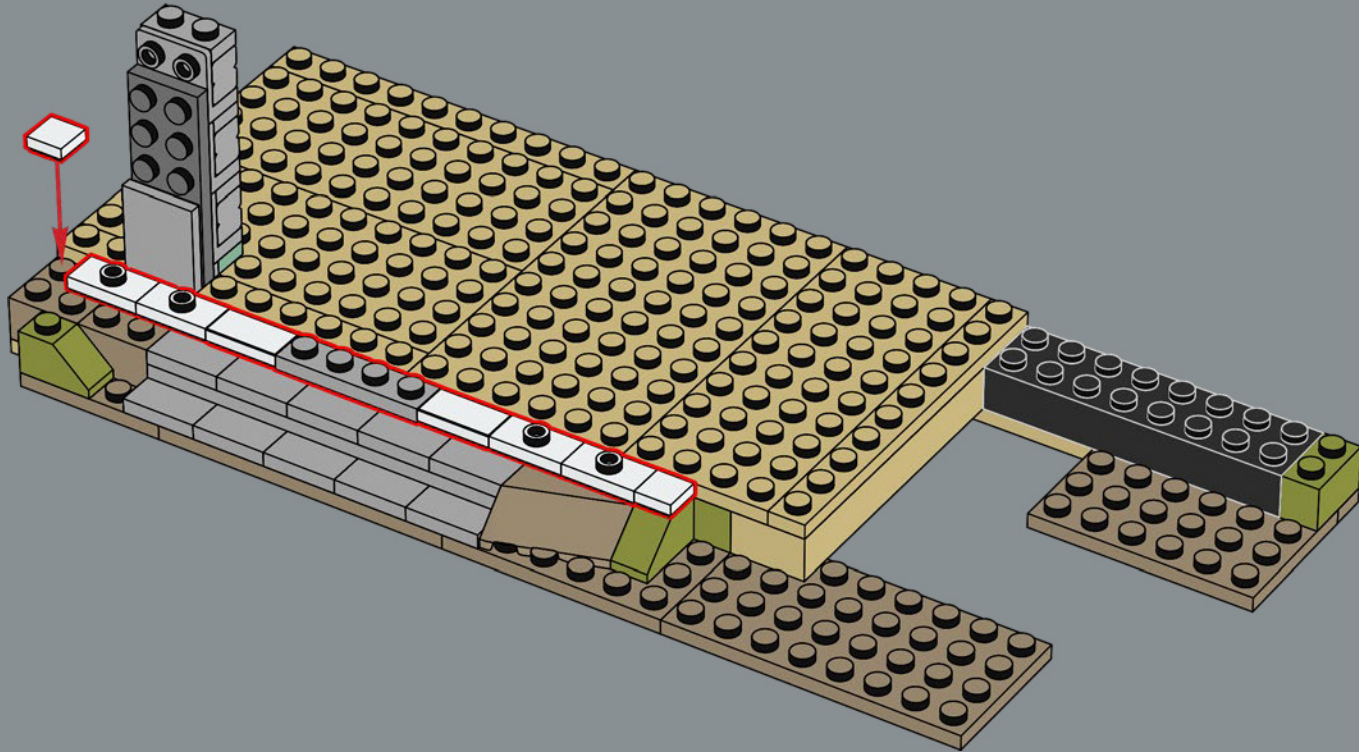

1x  2x 

18

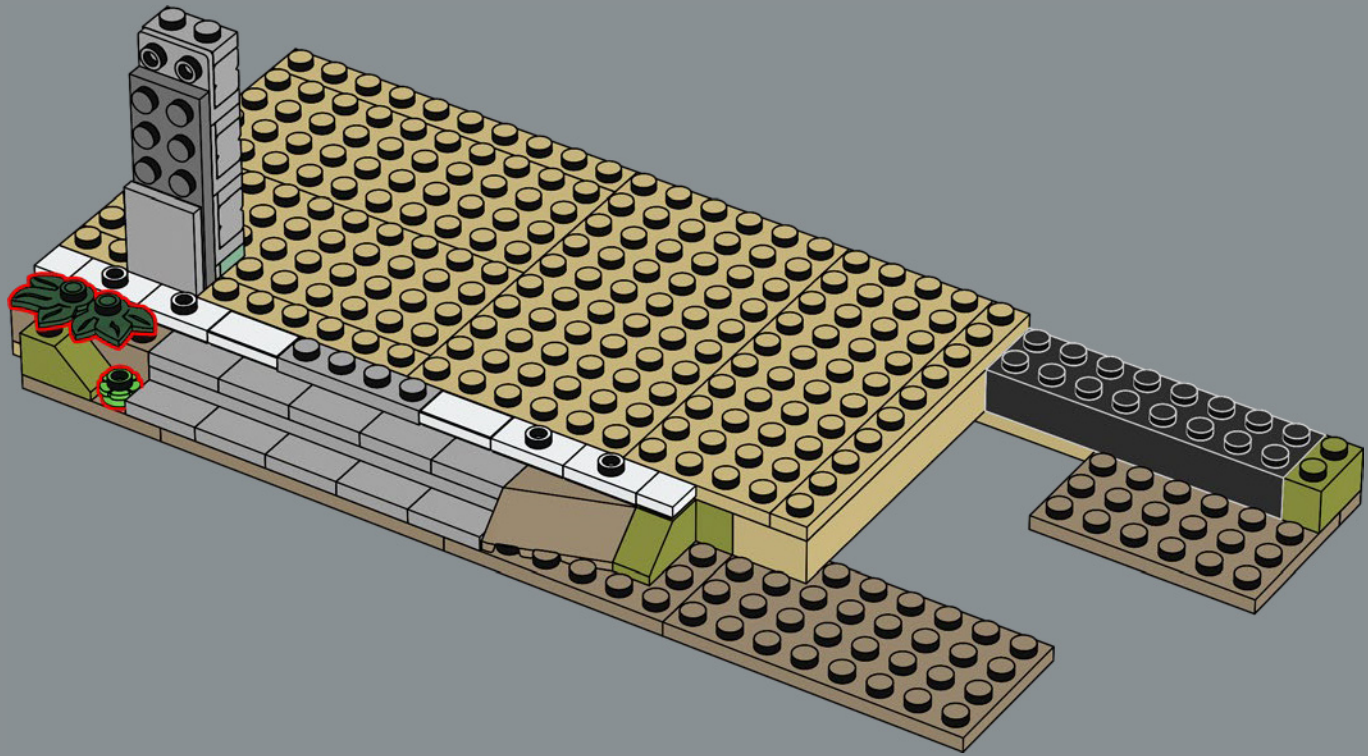

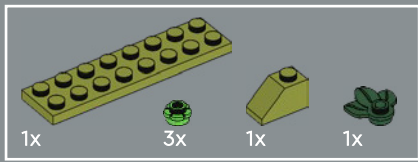

19

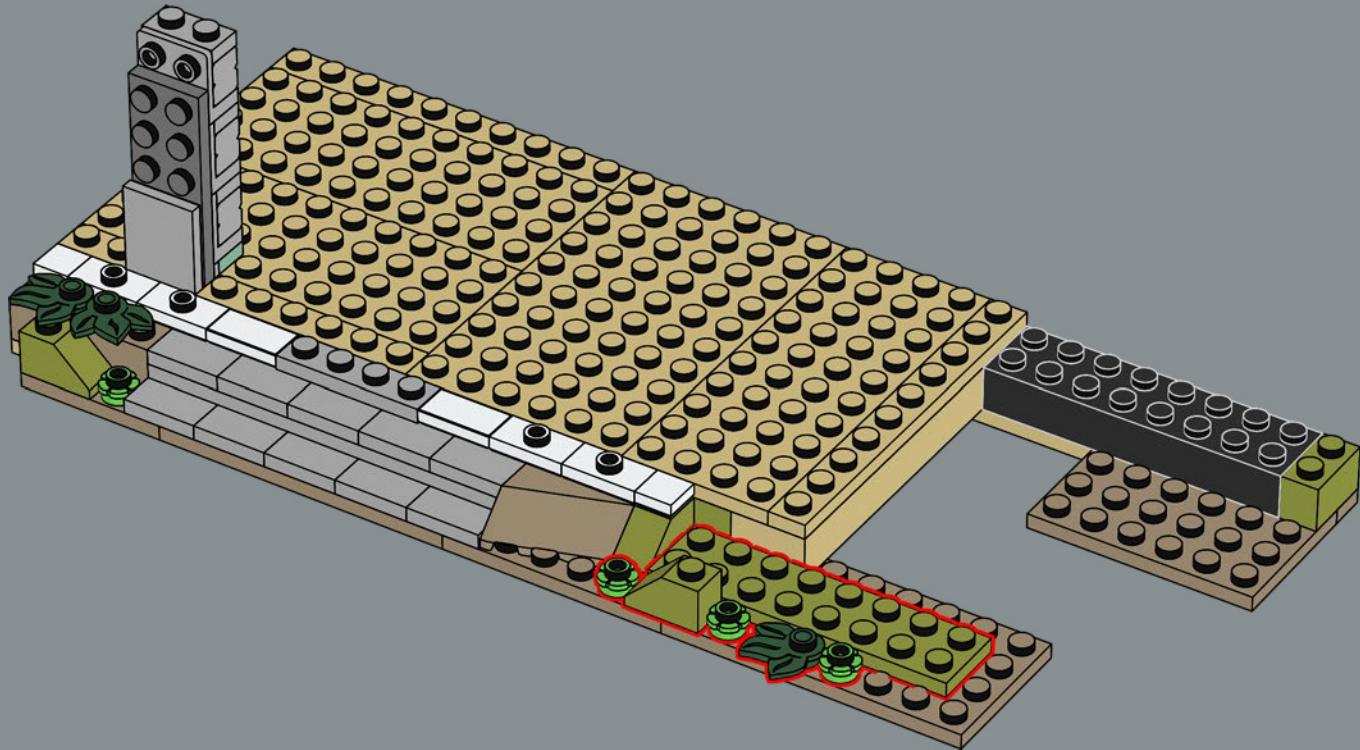

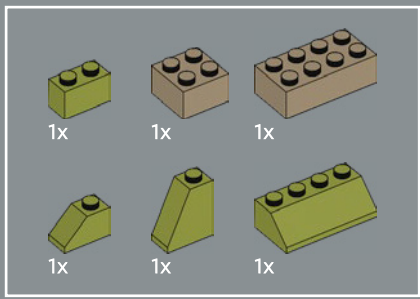

20

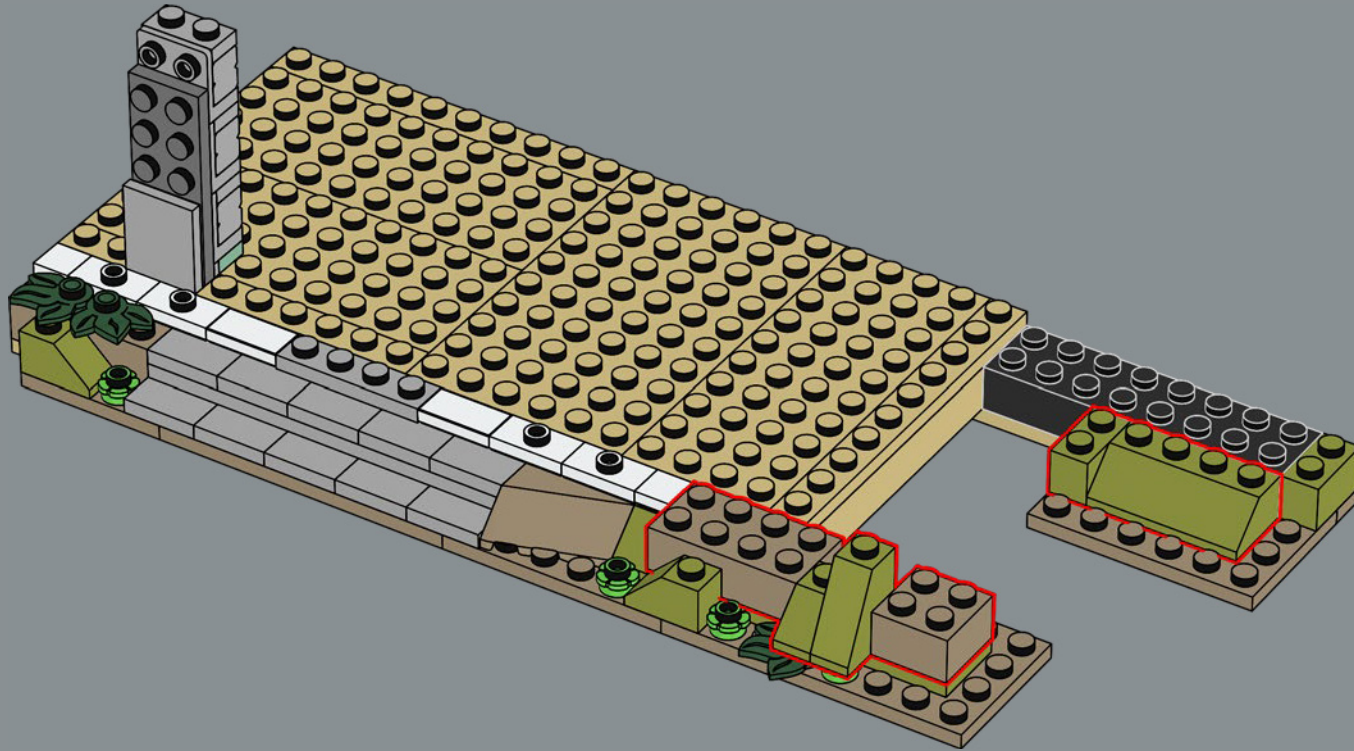

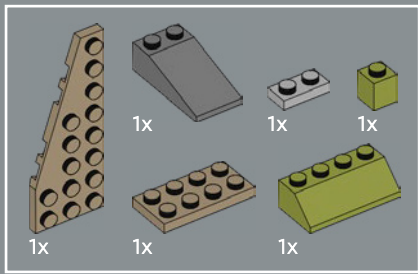

21

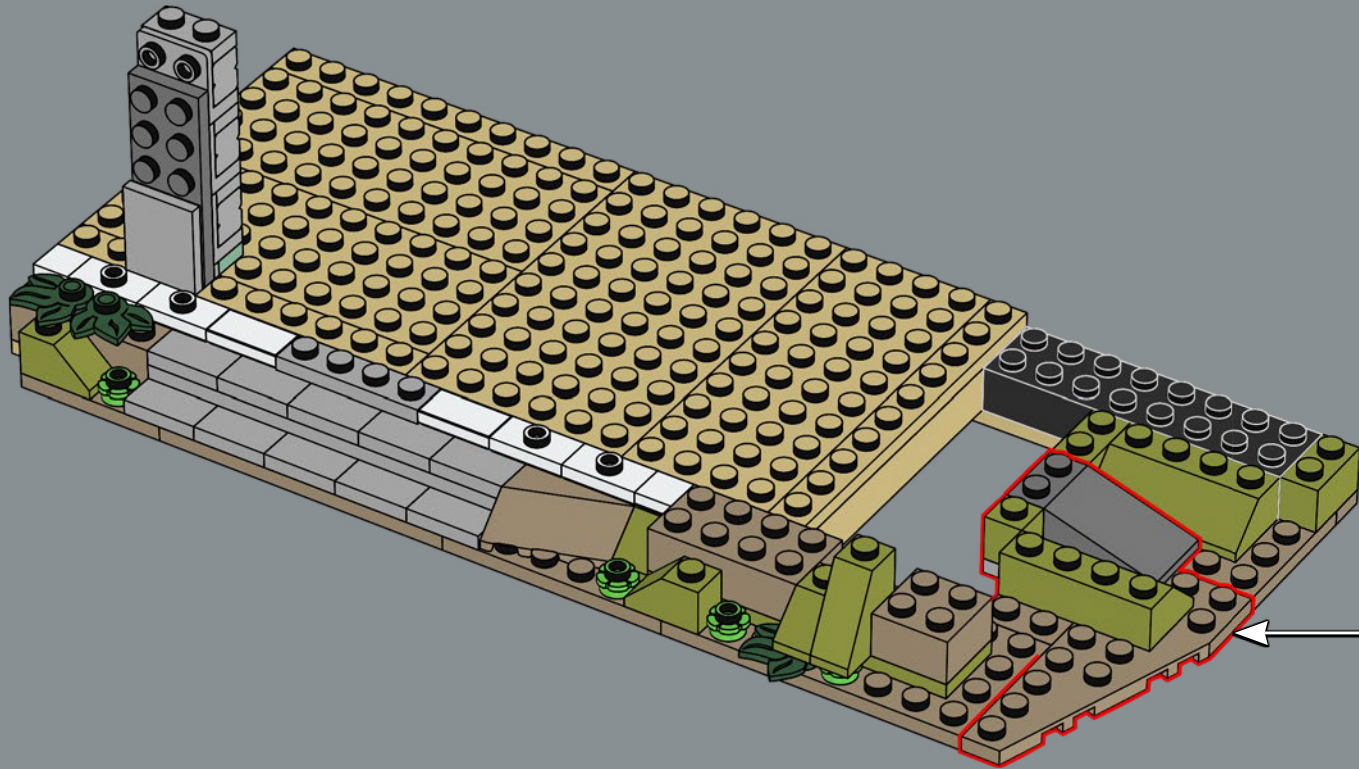
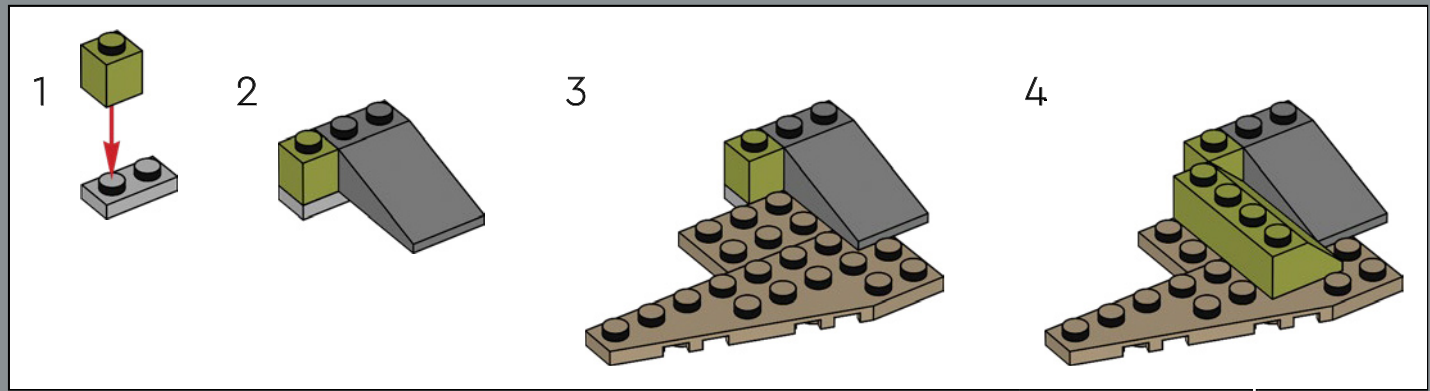

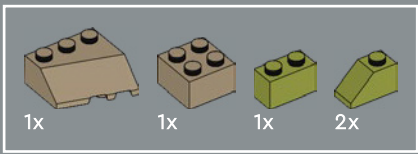

22

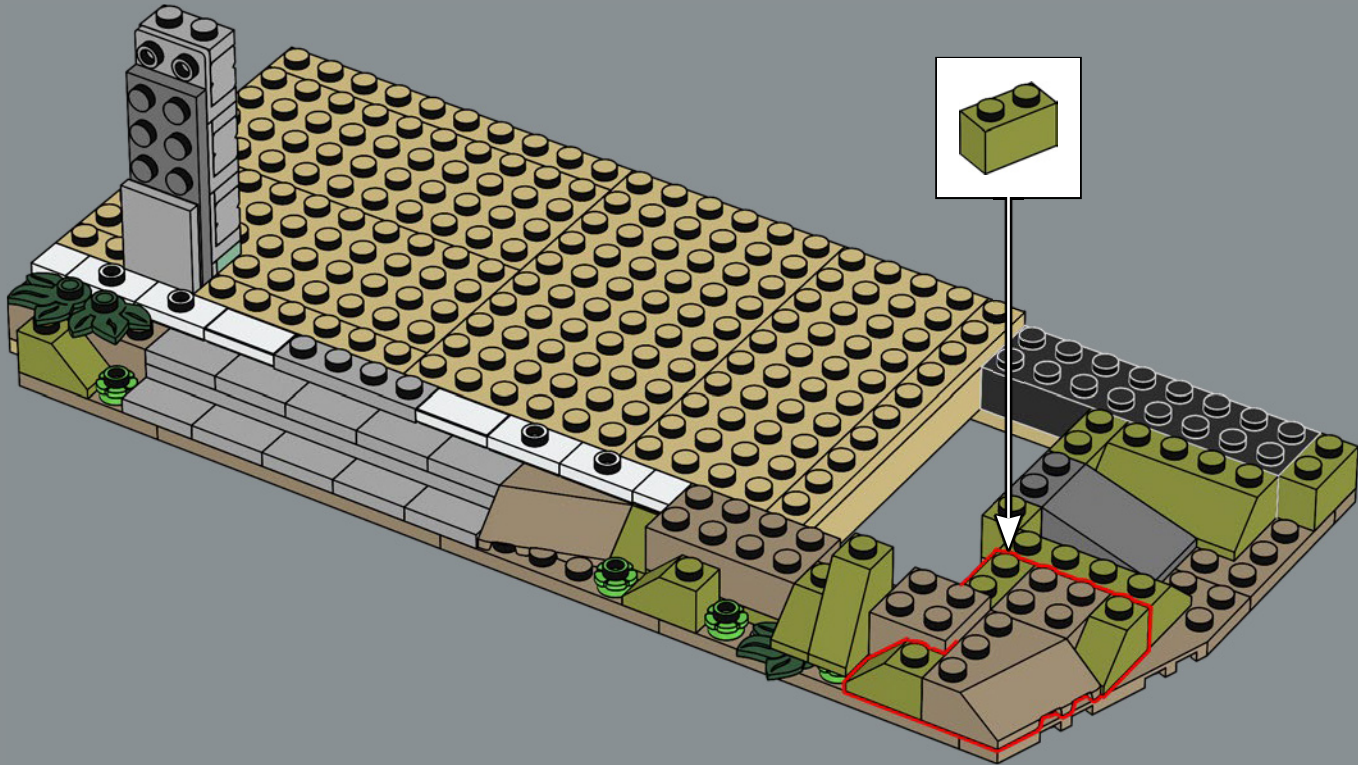

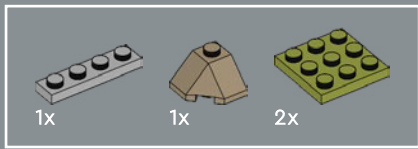

23

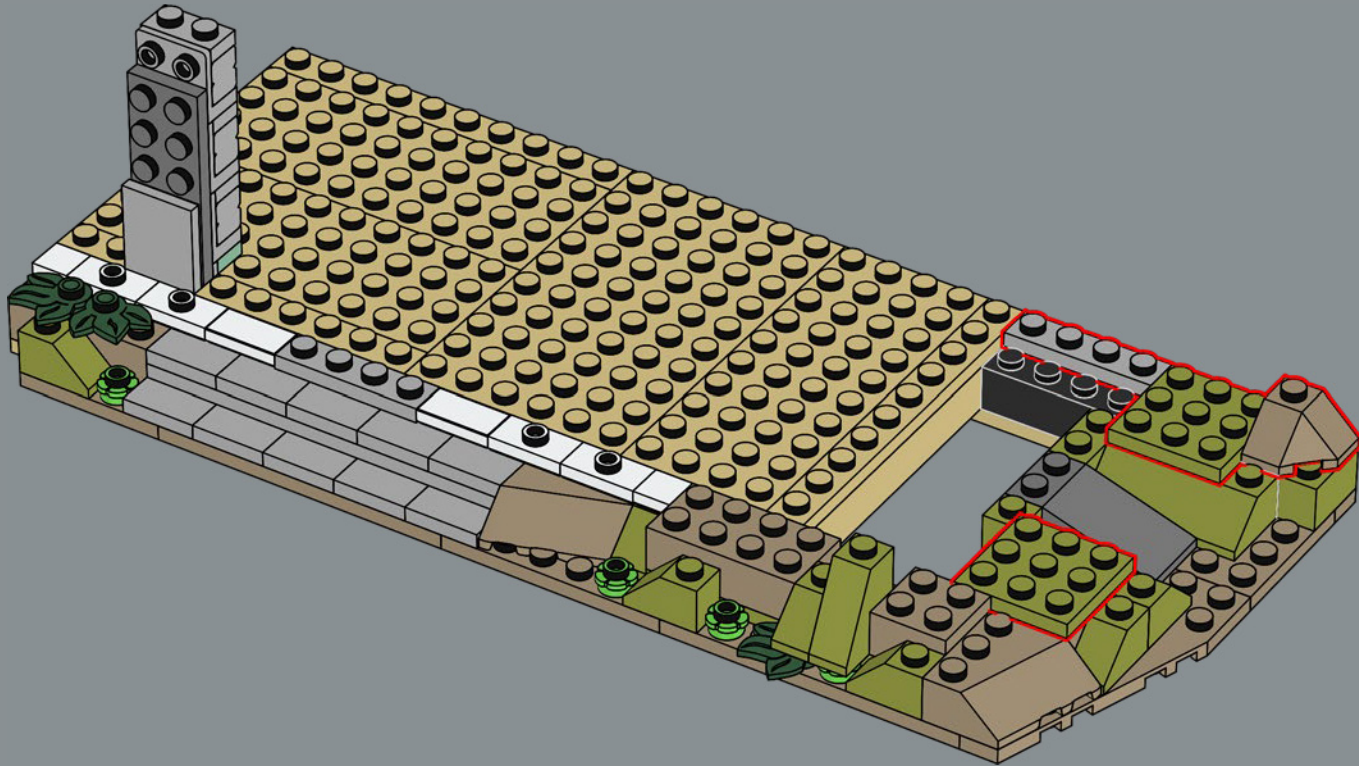

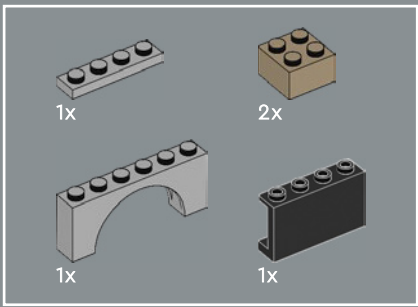

24

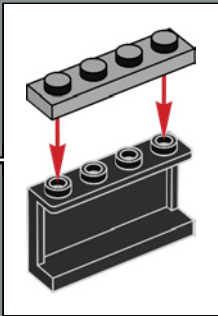
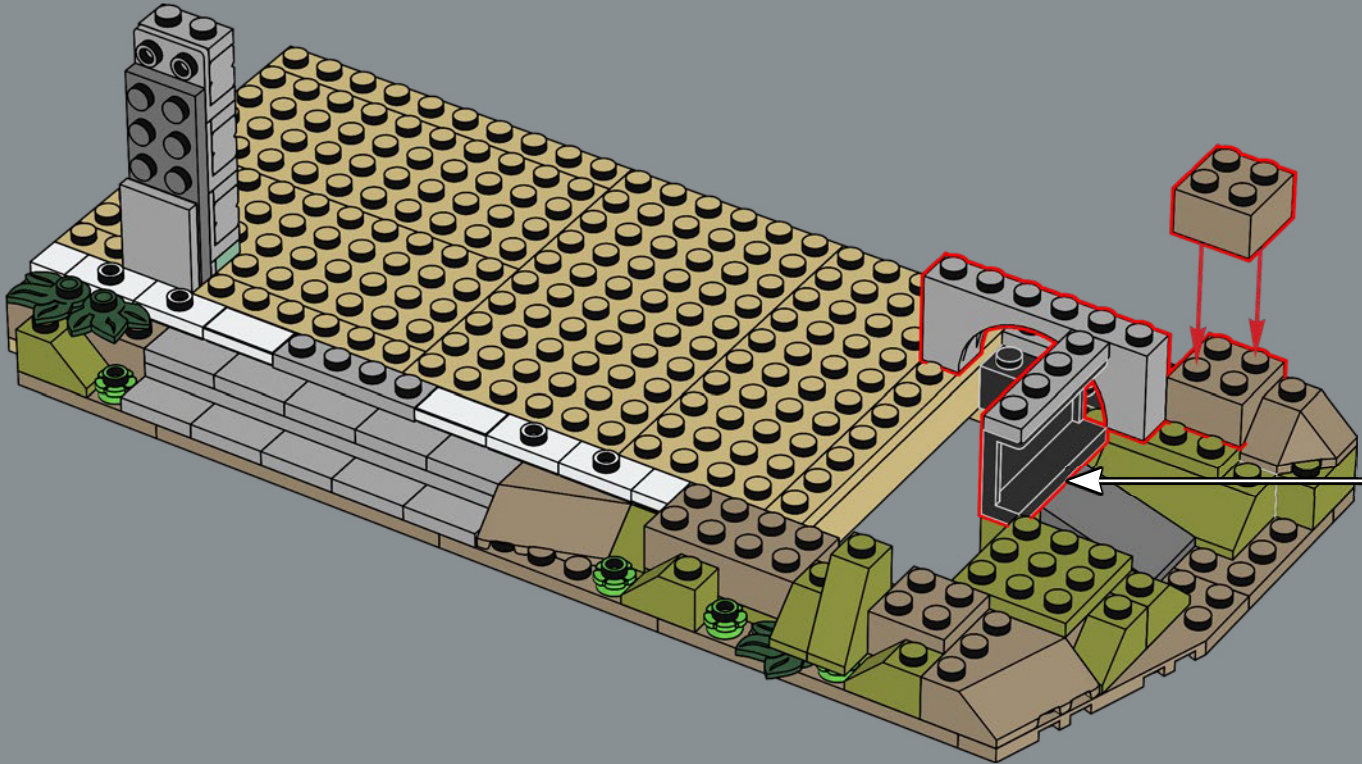

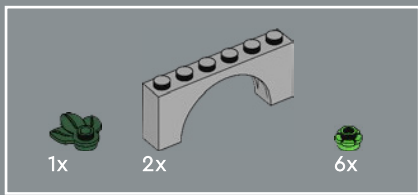

25

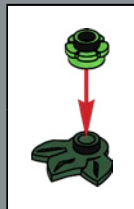
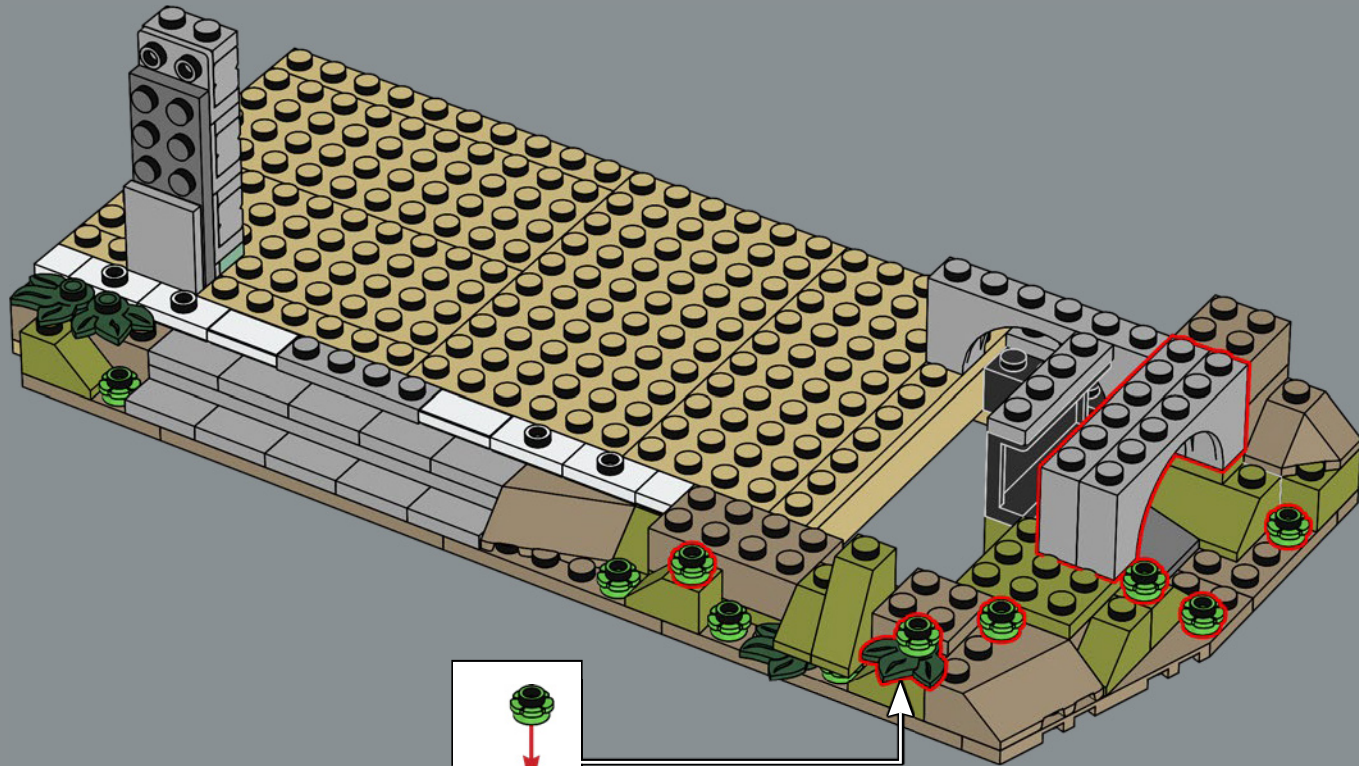

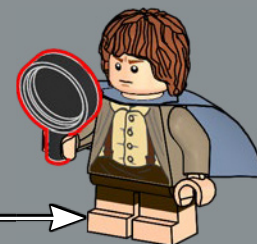
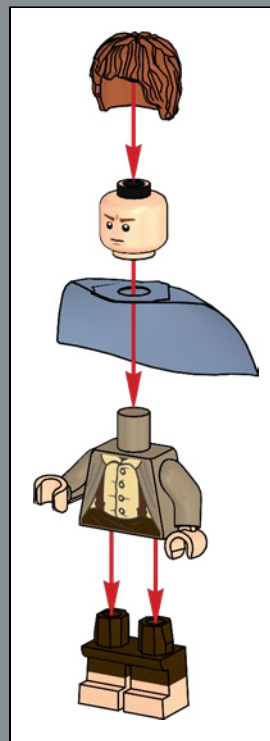
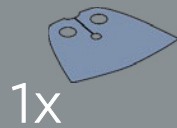
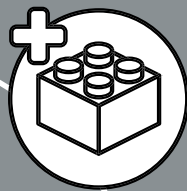

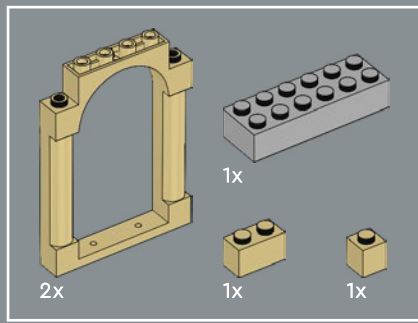

26

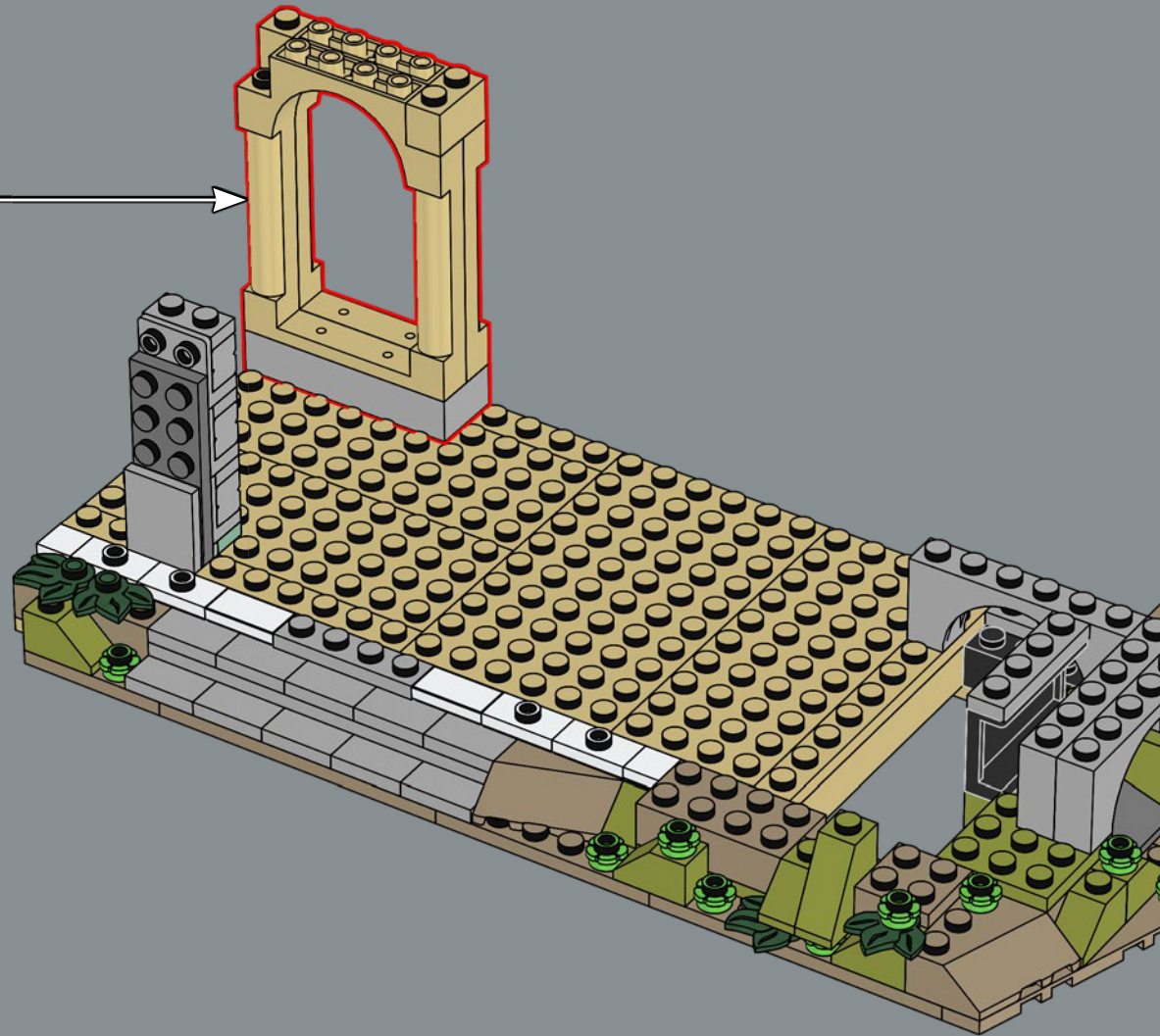
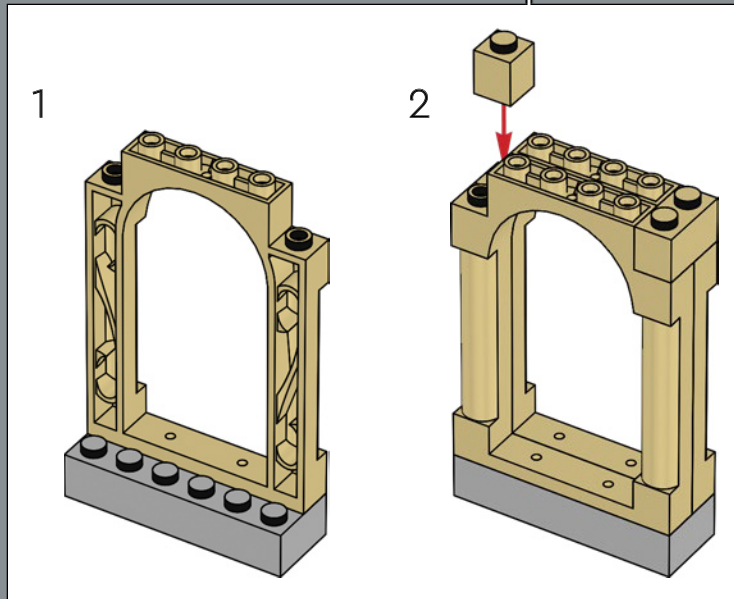

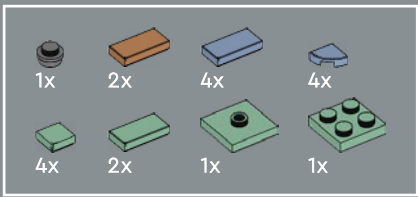

27

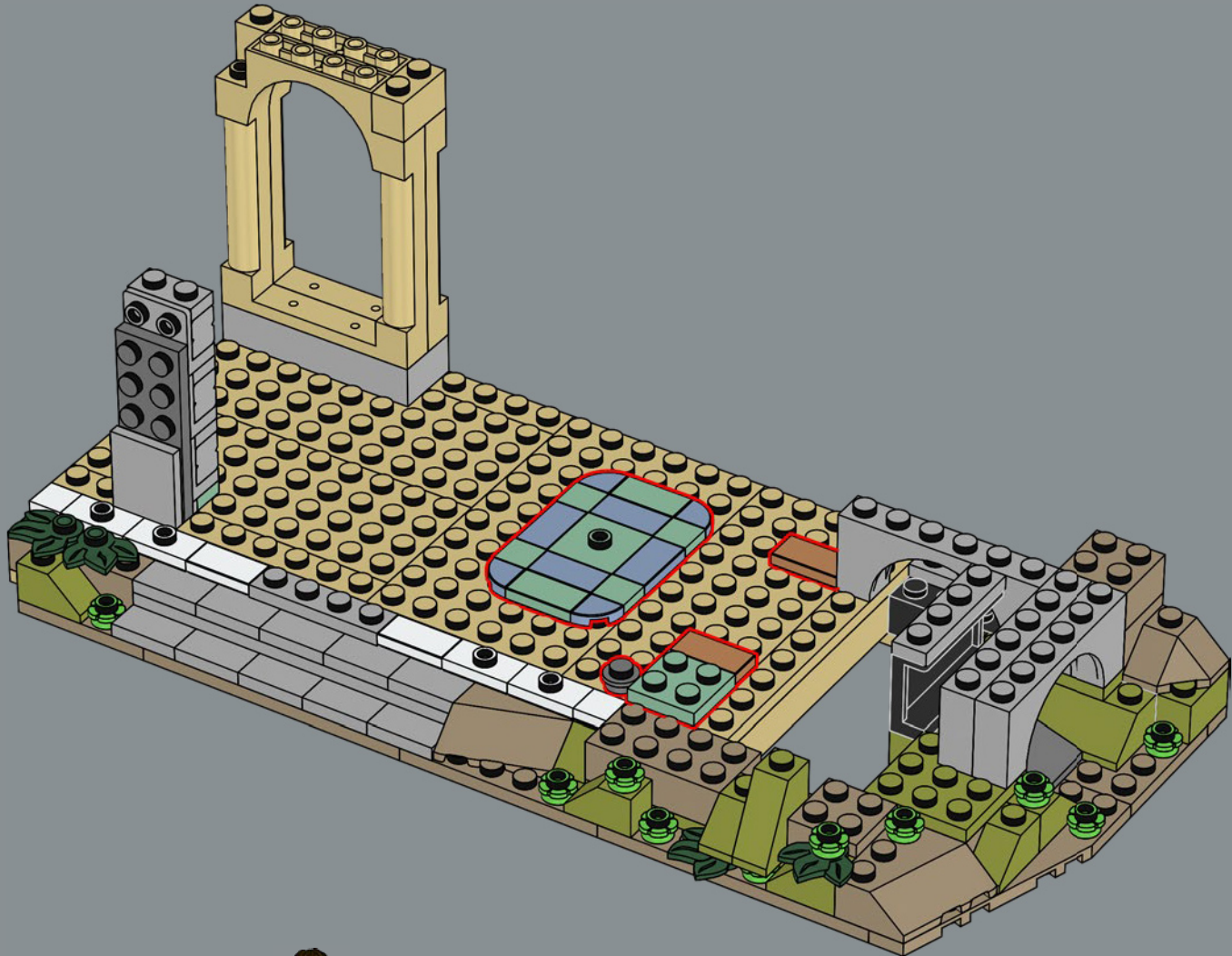

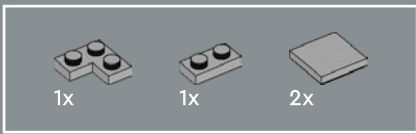

28

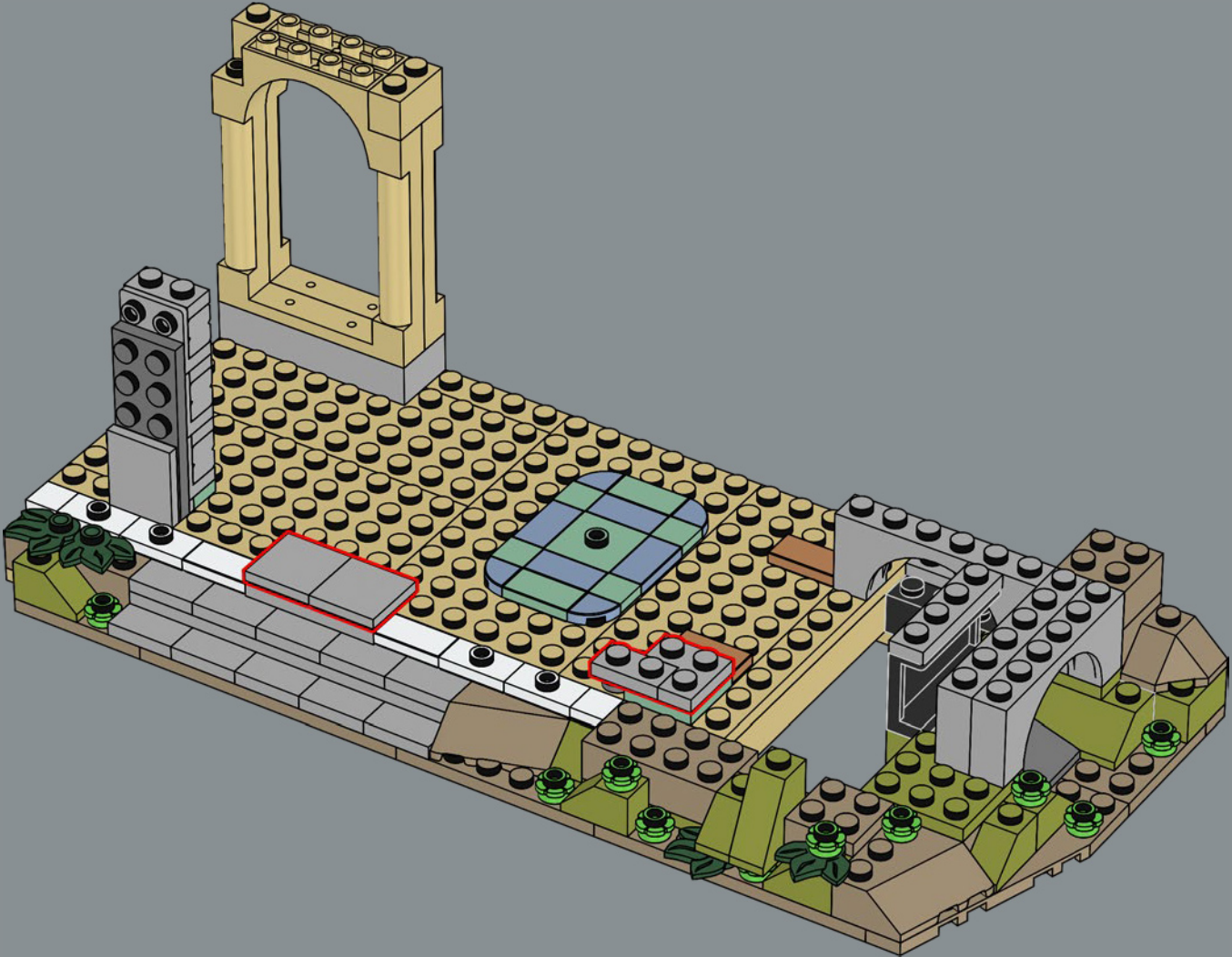



2x

29

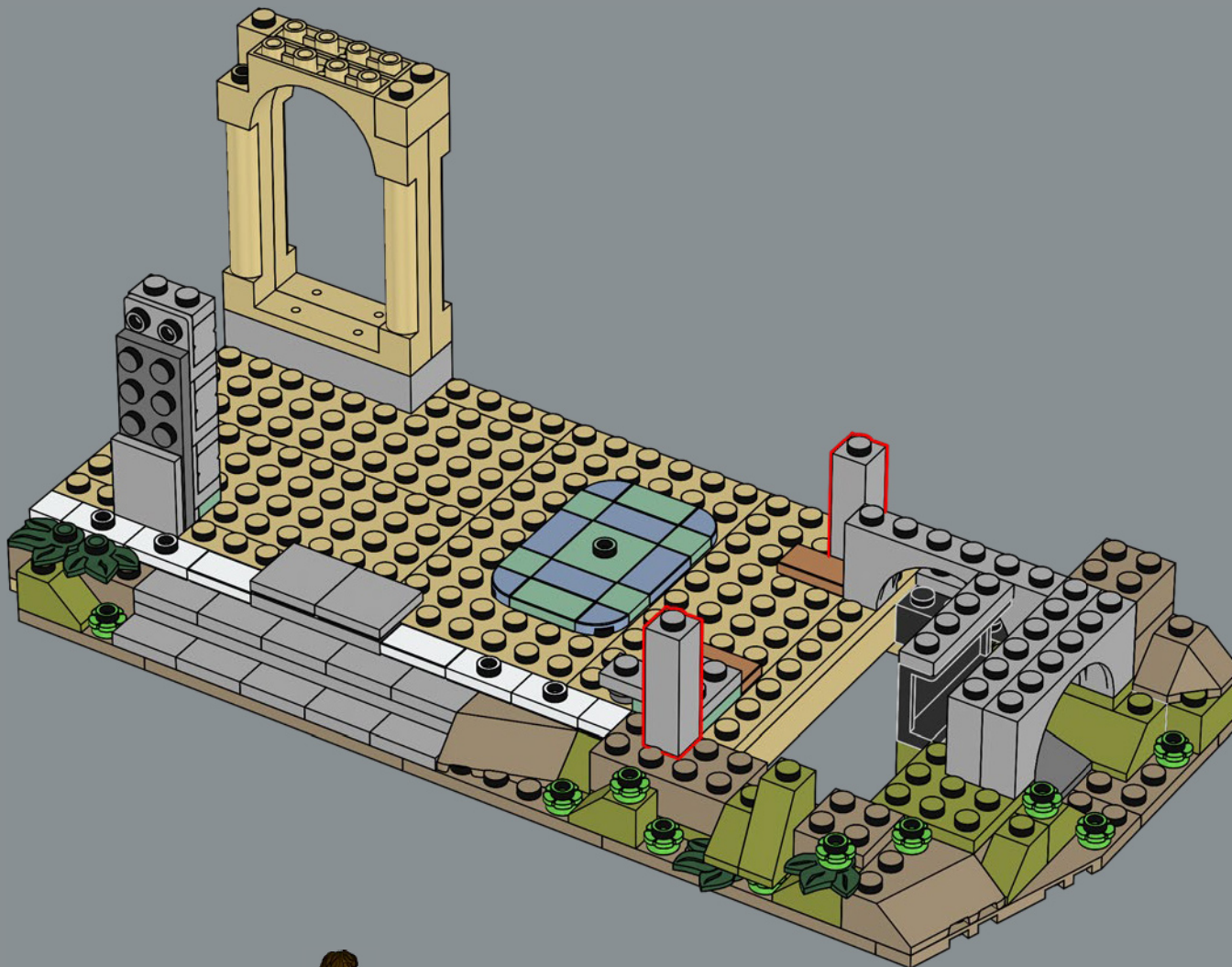



L'elemento felce è un nuovo design introdotto nel 2023.
Si vede qui per la prima volta e ce ne sono 34 in questo modello!

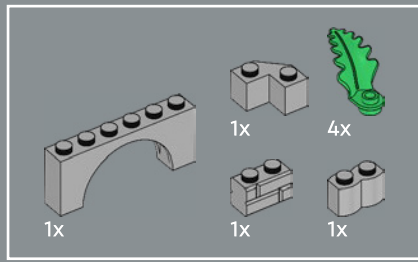

30

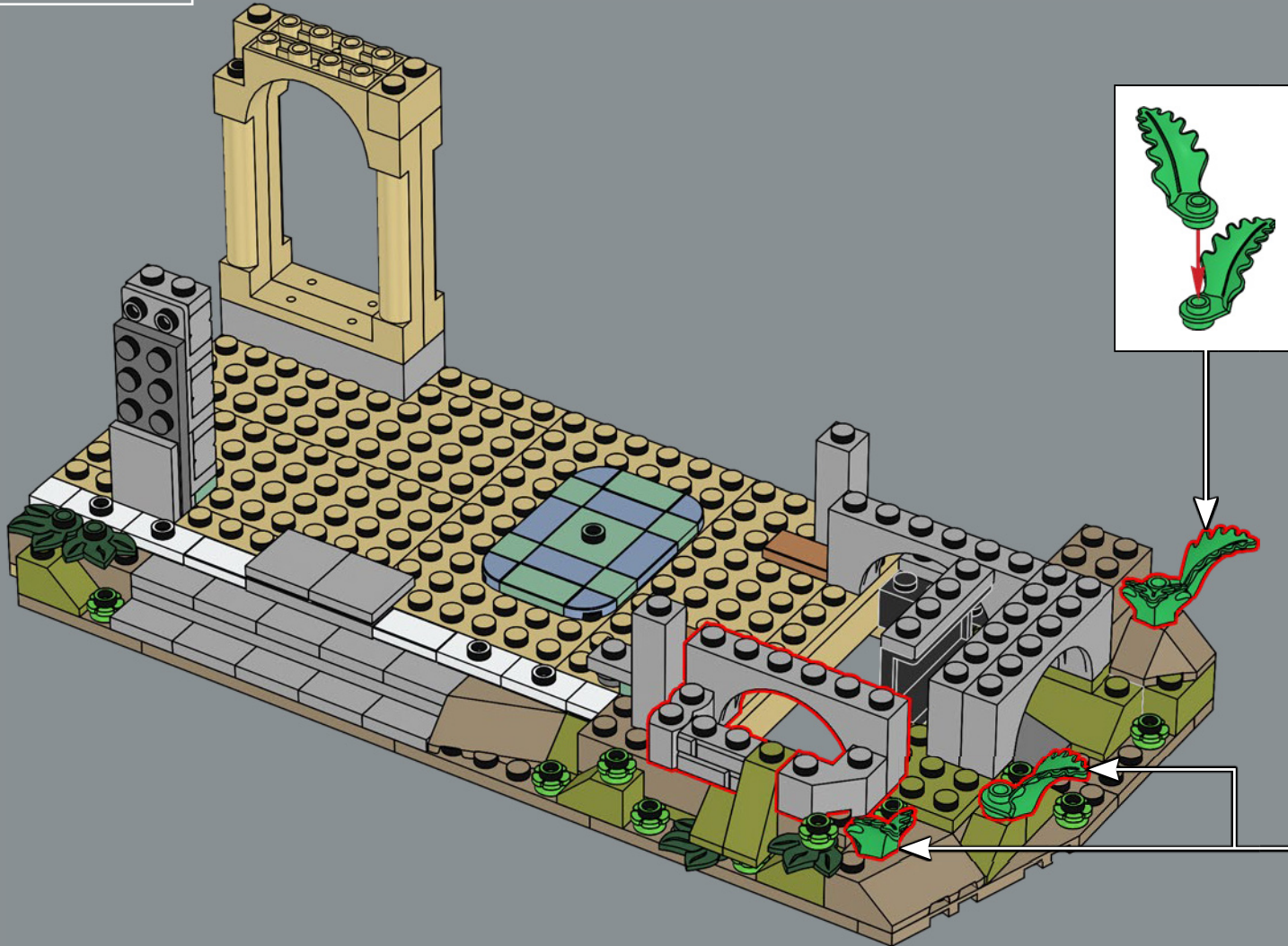

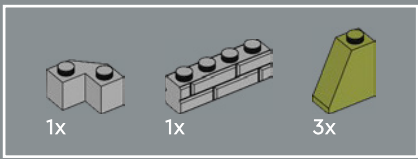

31

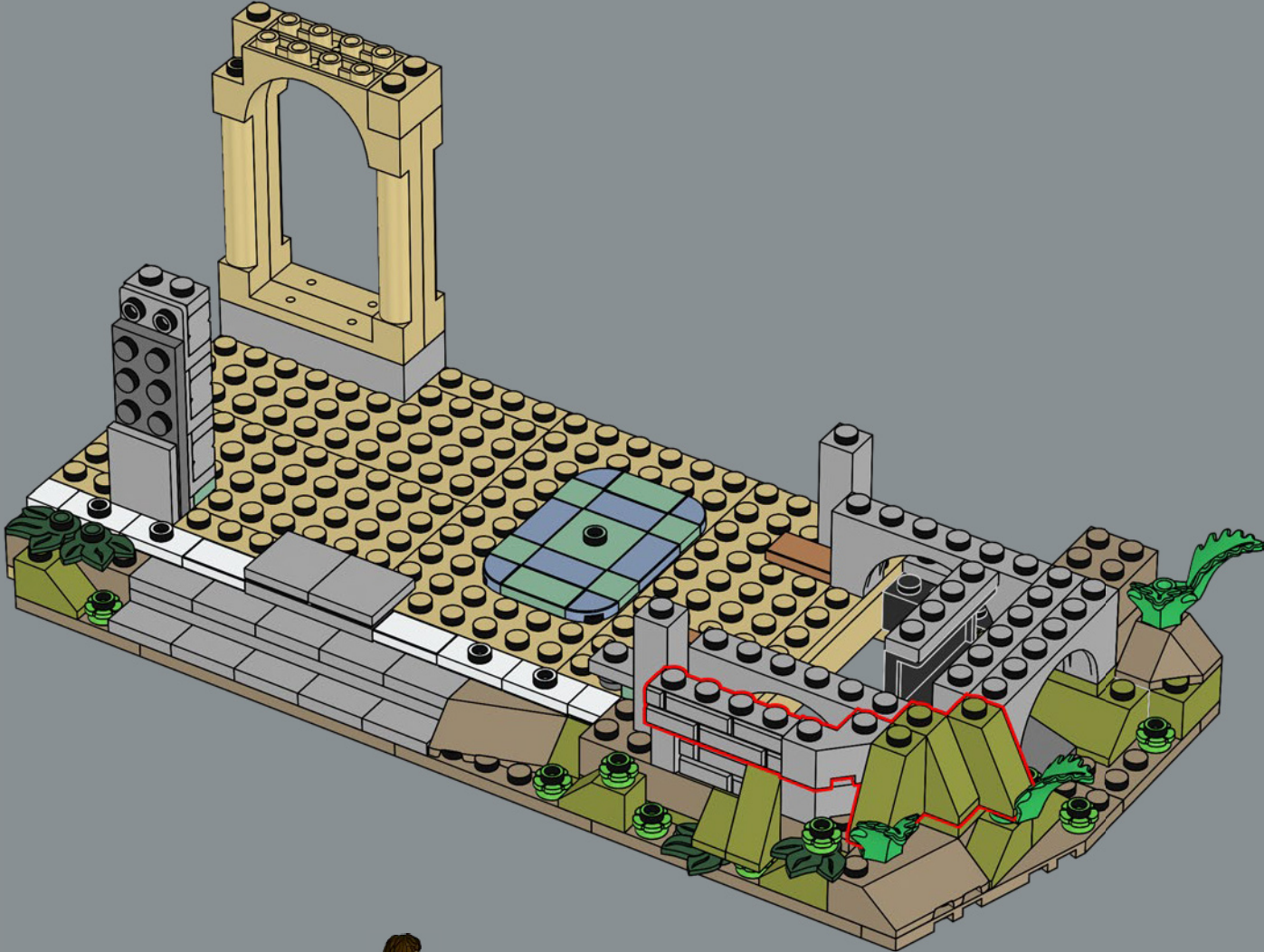

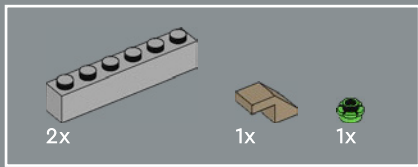

32

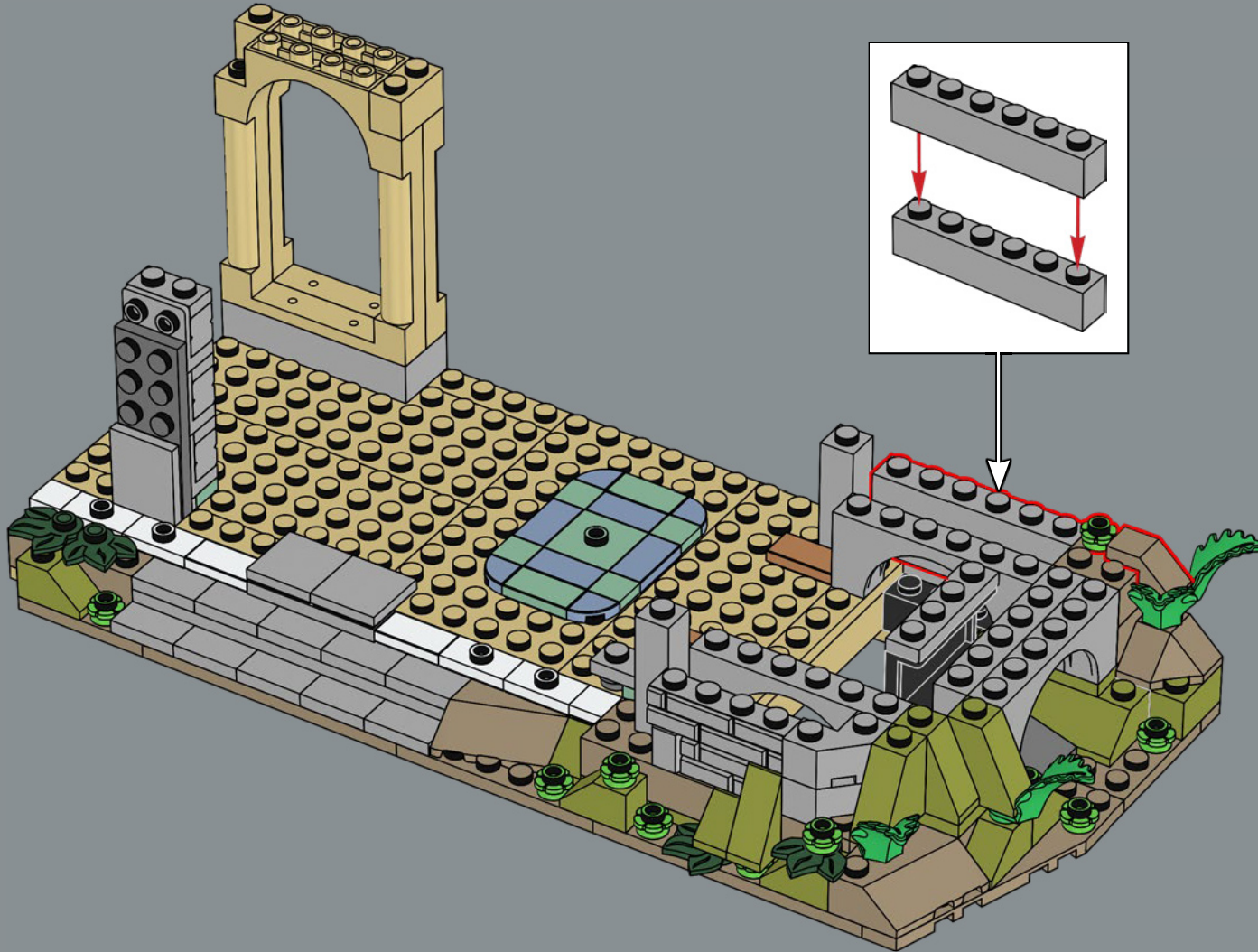

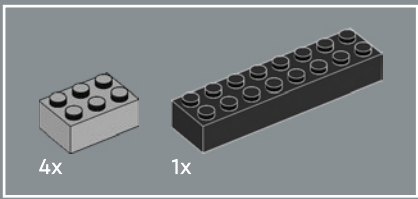

33

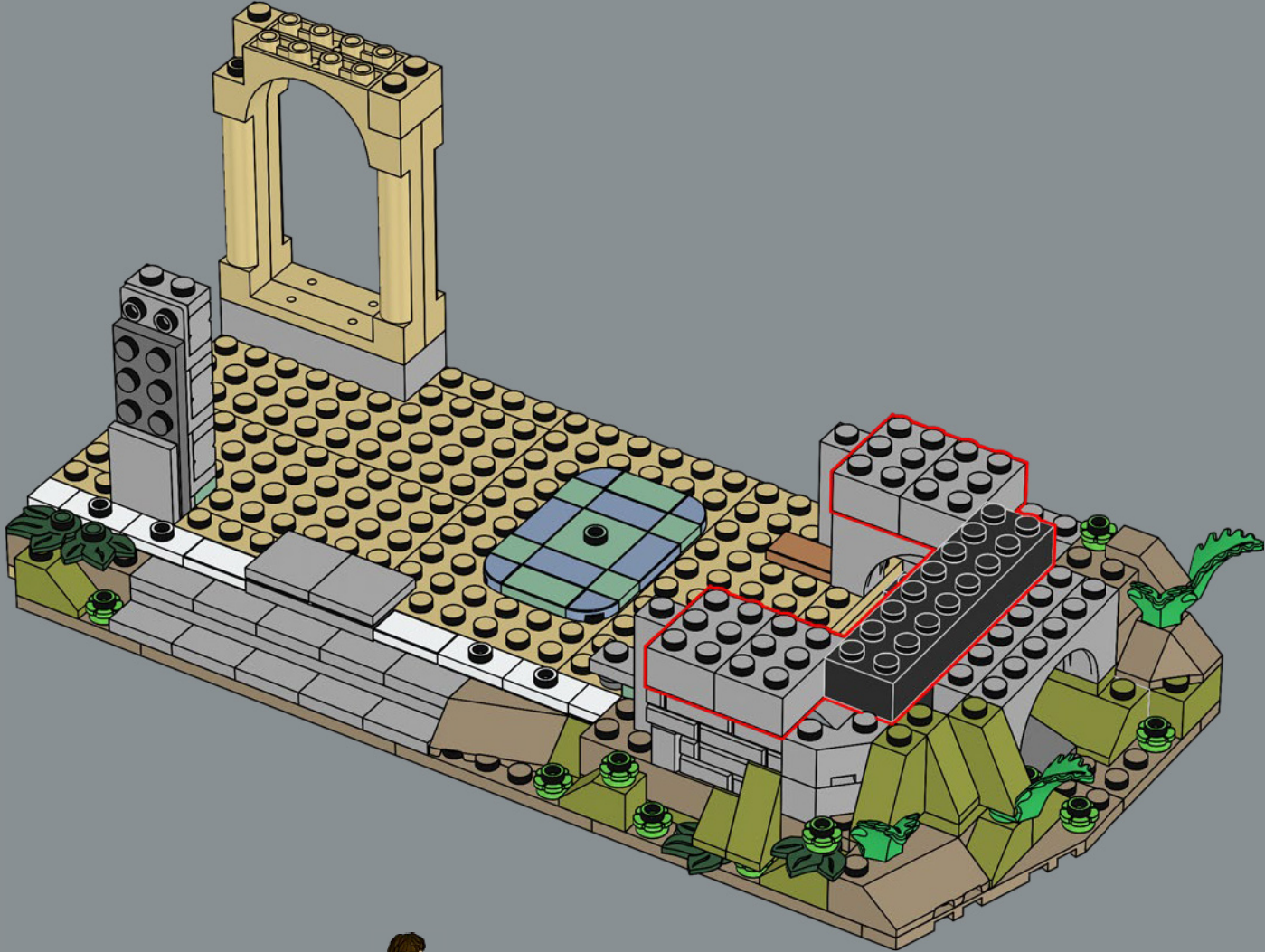

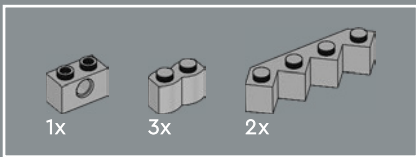

34

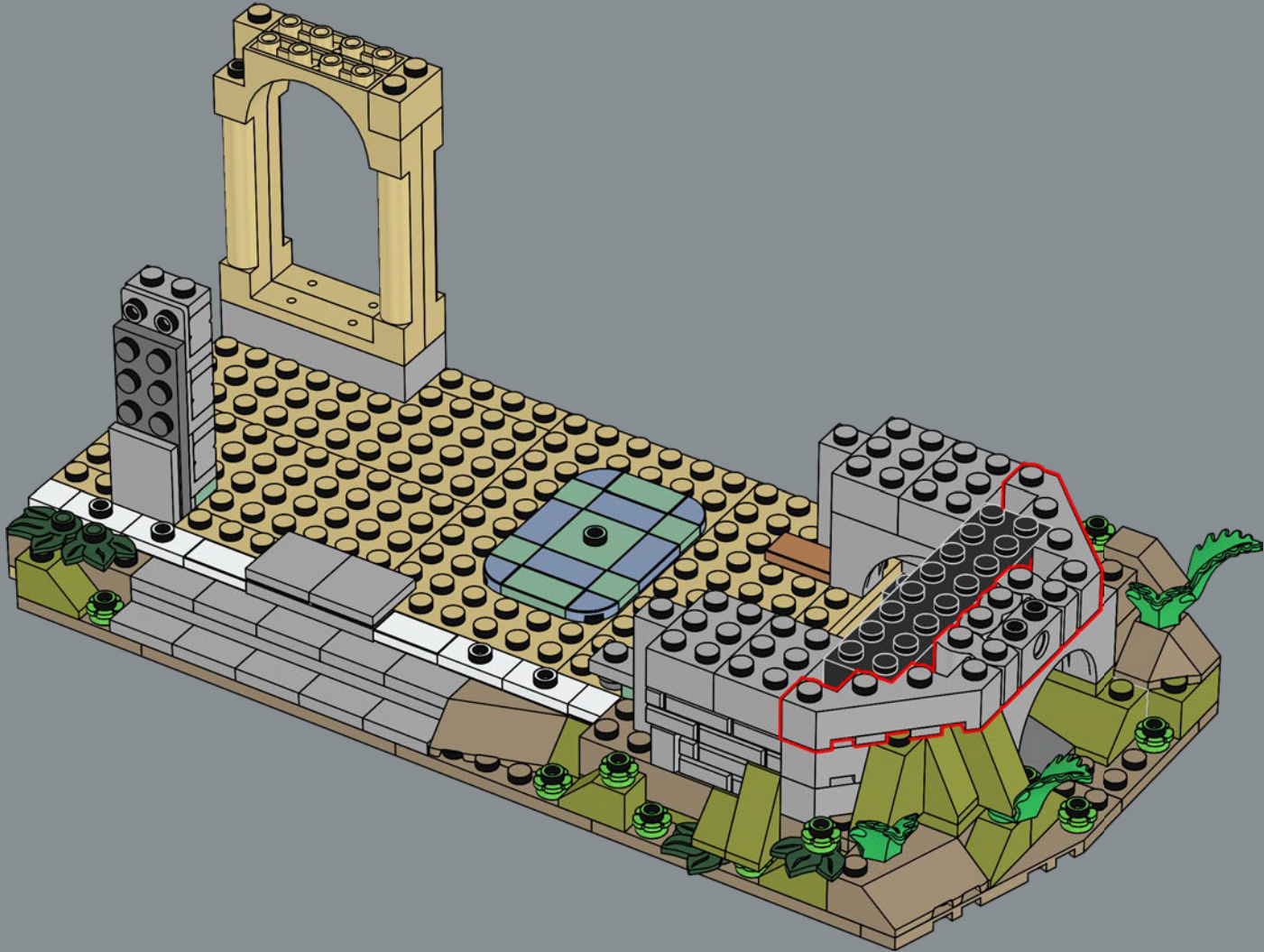

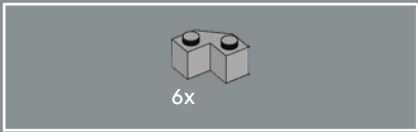

35

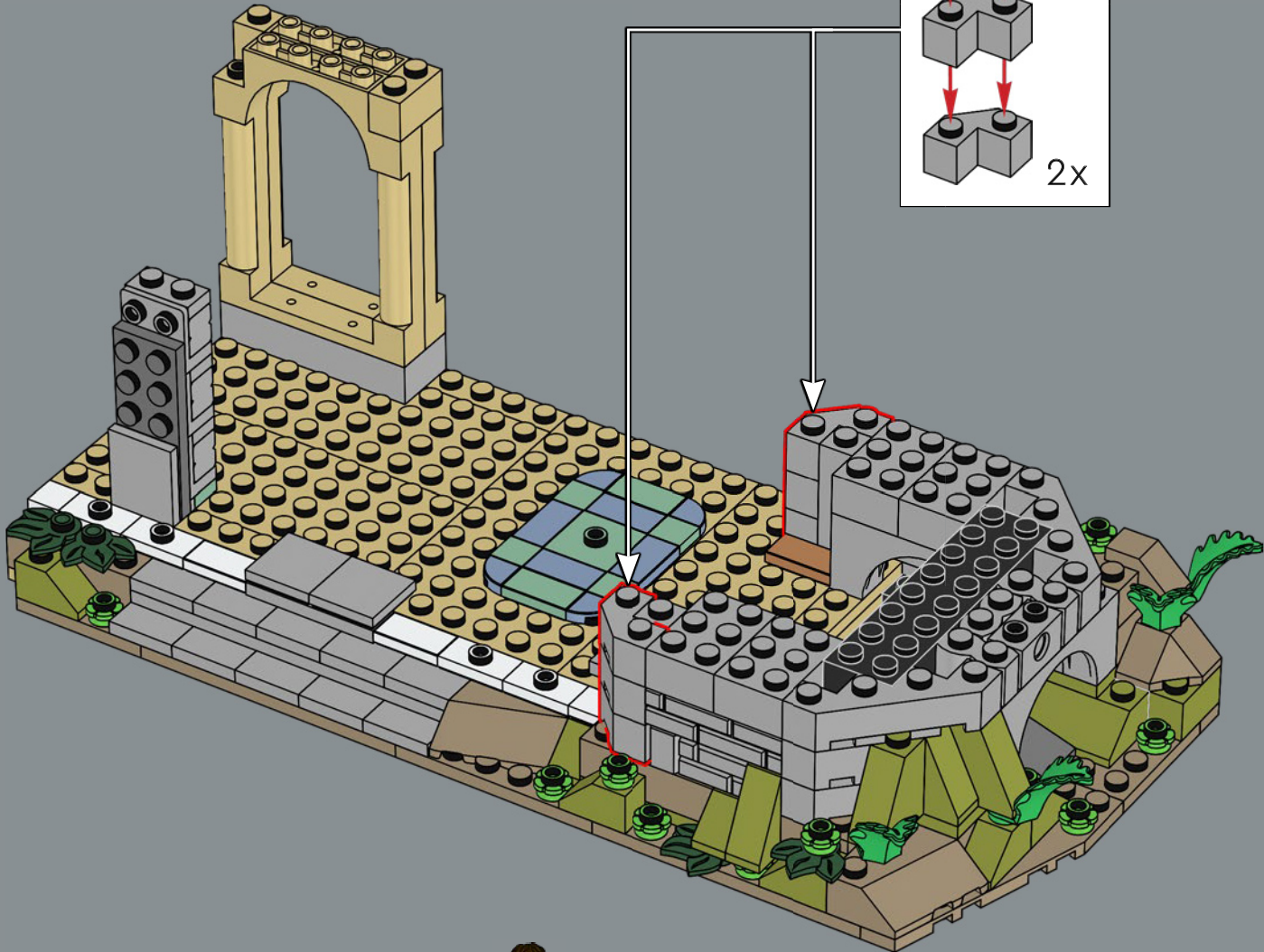
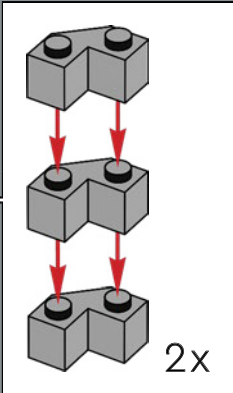

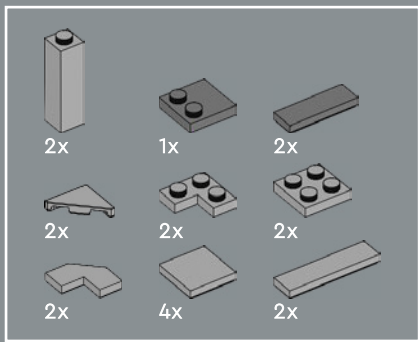

36

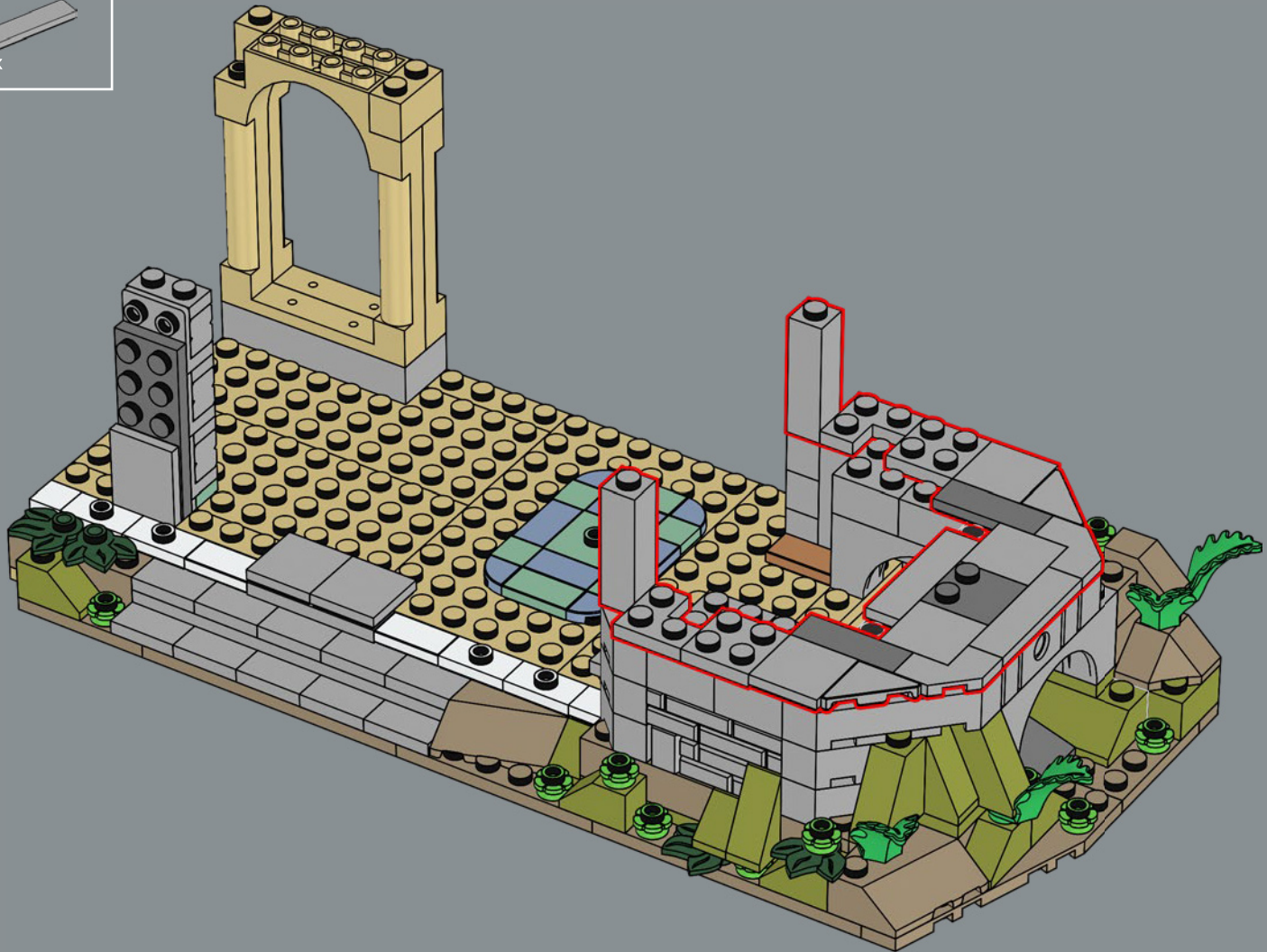

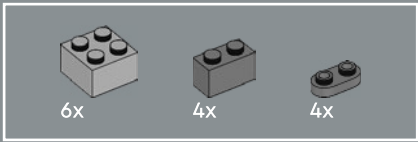

37

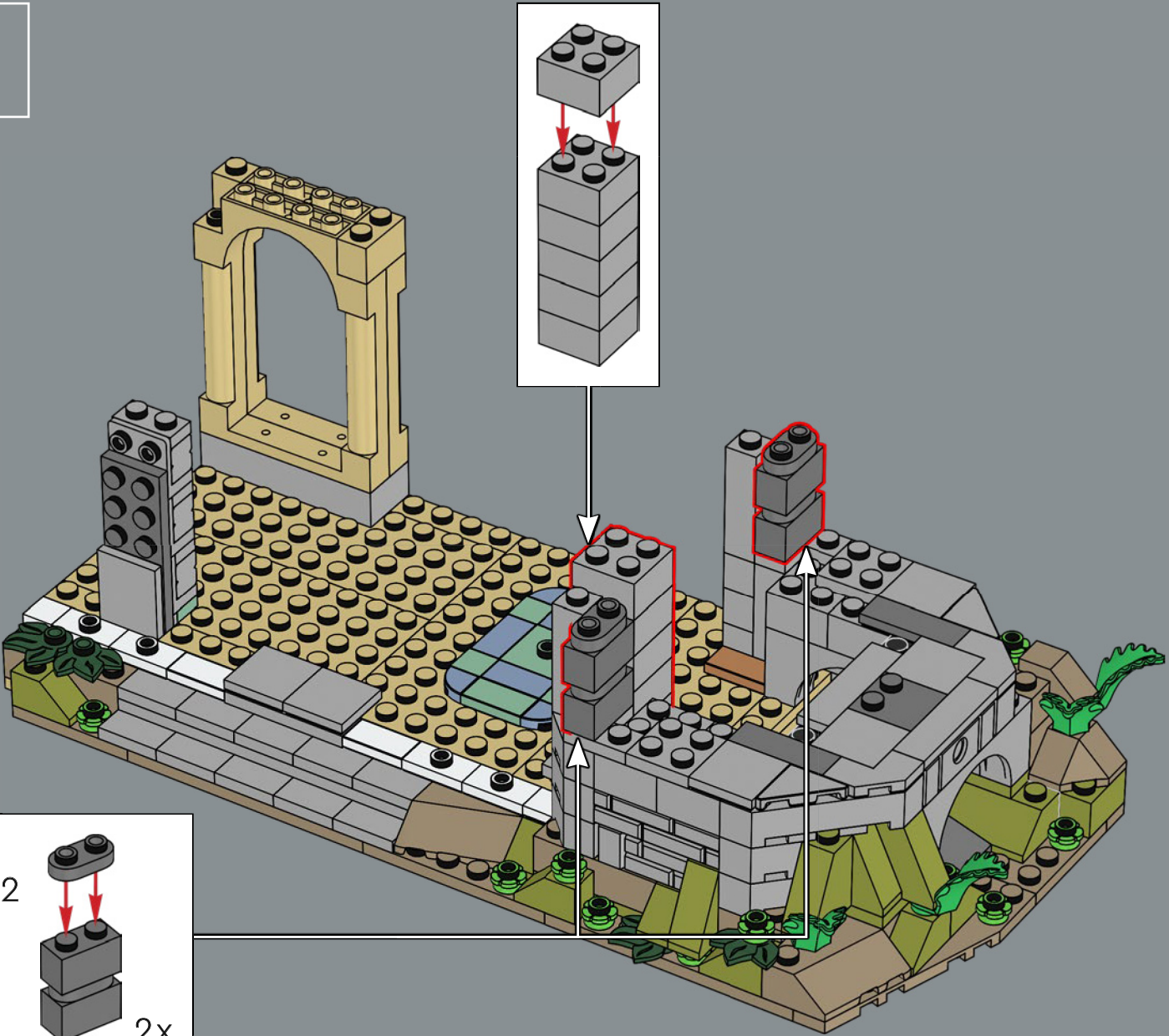

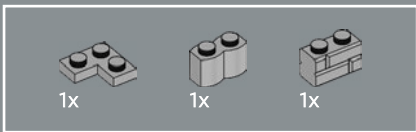

38

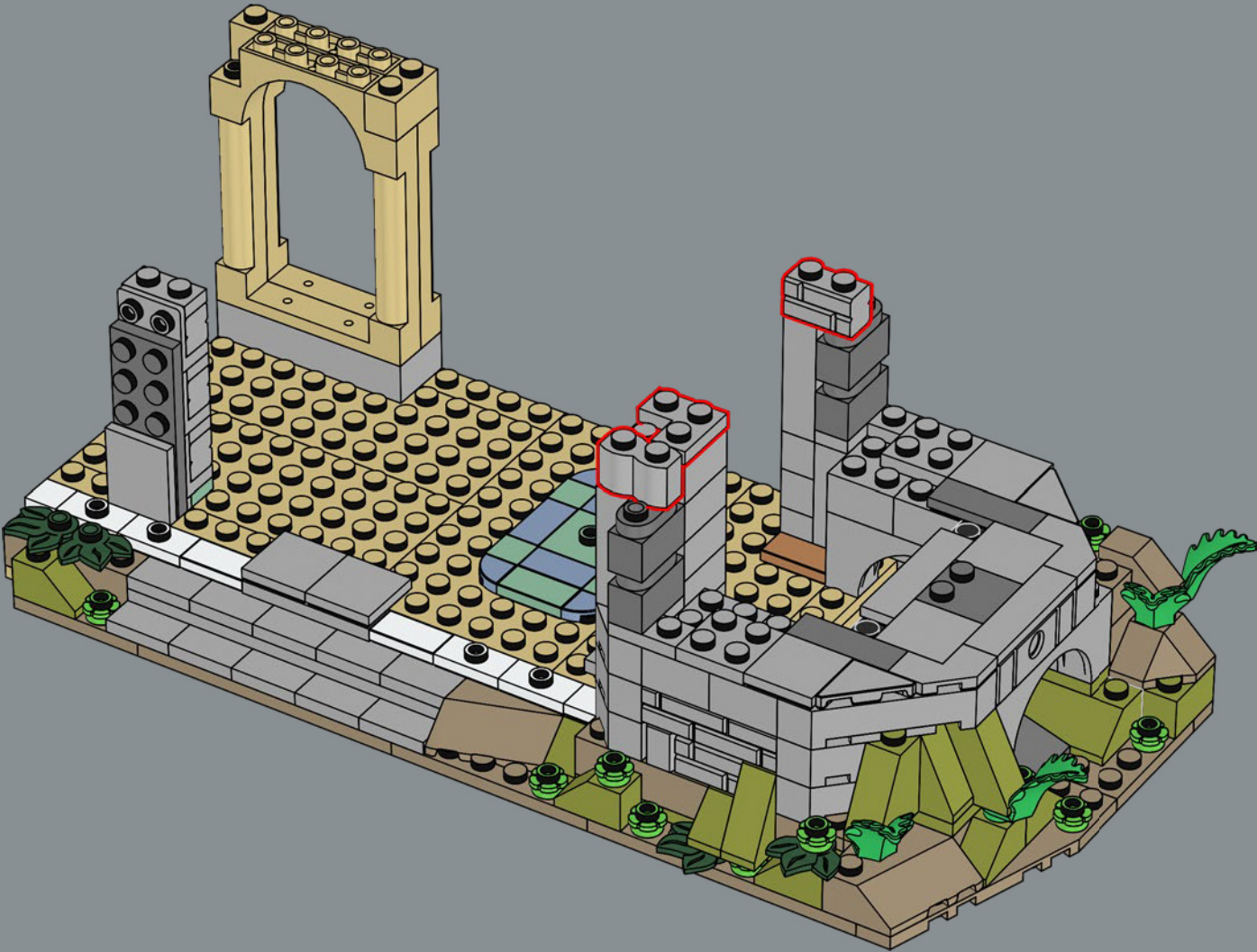



Questo buco-nascondiglio per Samwise Gamgee è stato una delle ultime caratteristiche aggiunte al modello.

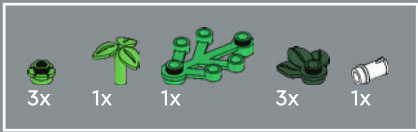

39

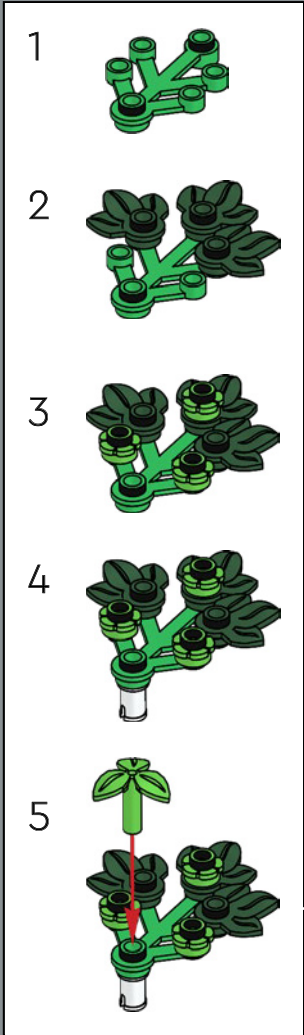

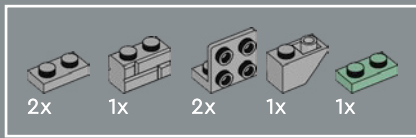

40

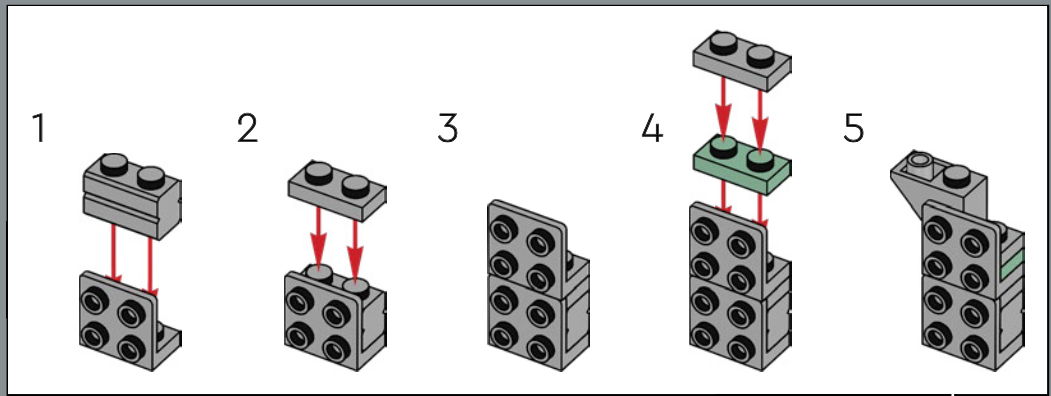
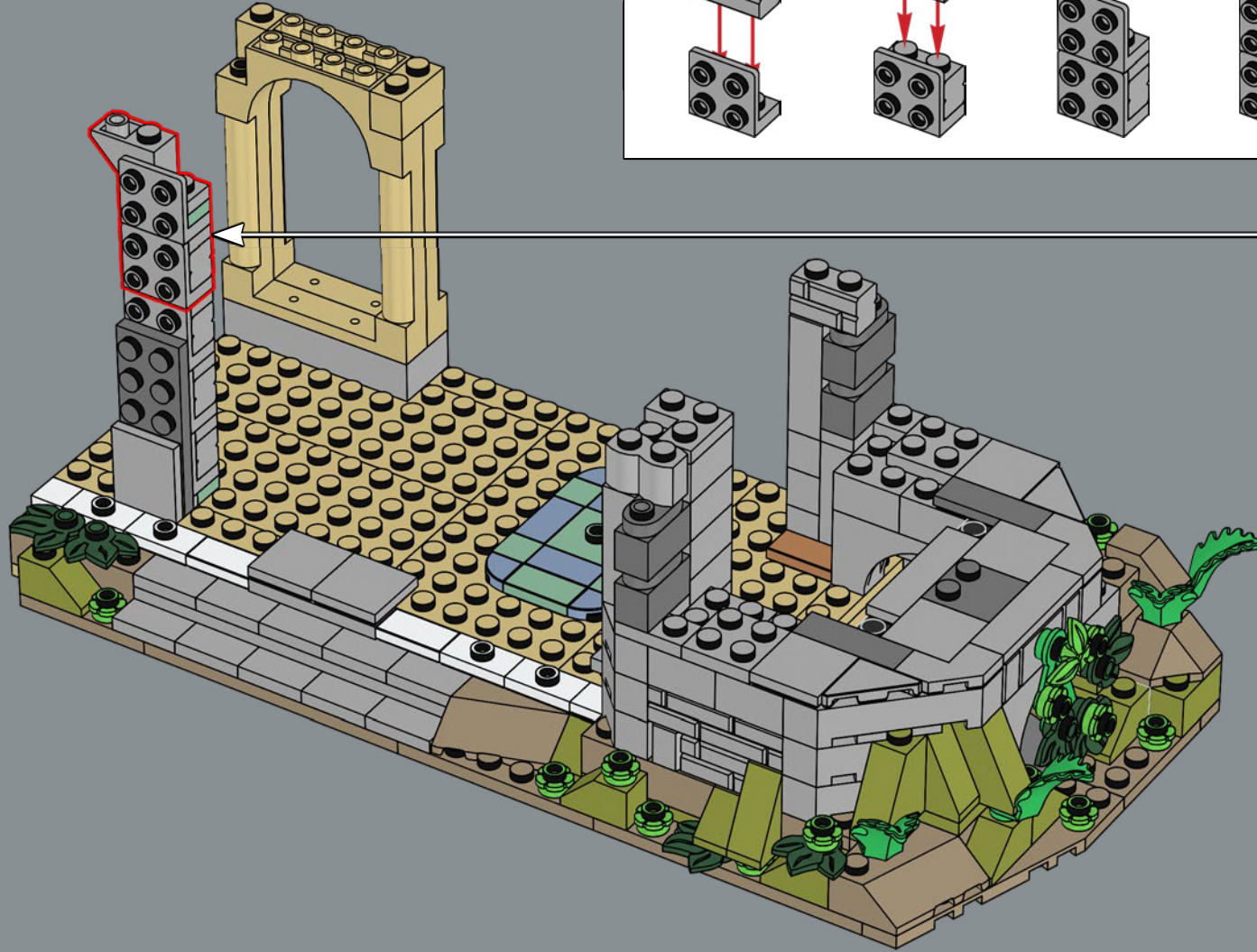

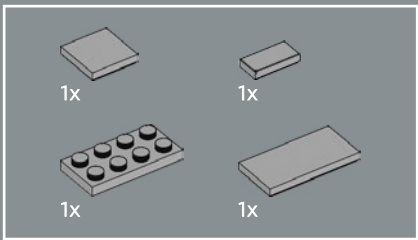

41

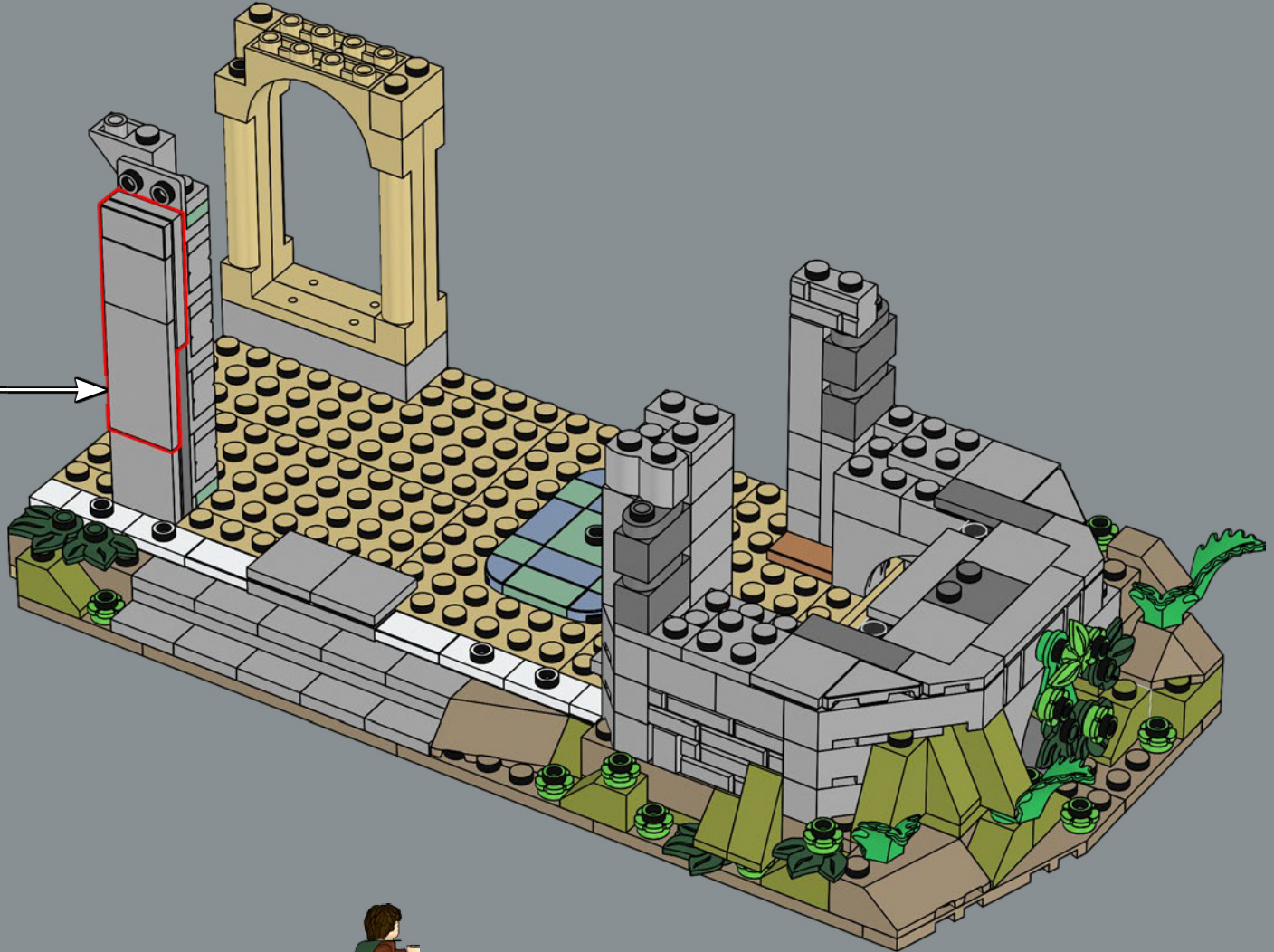
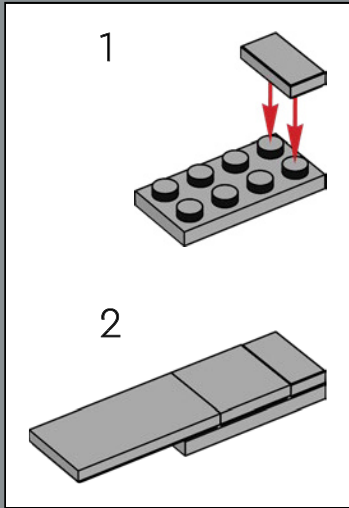

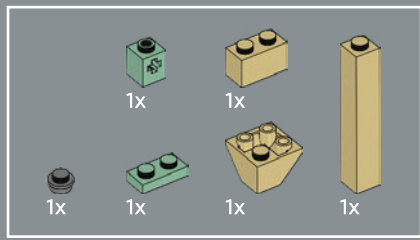

42

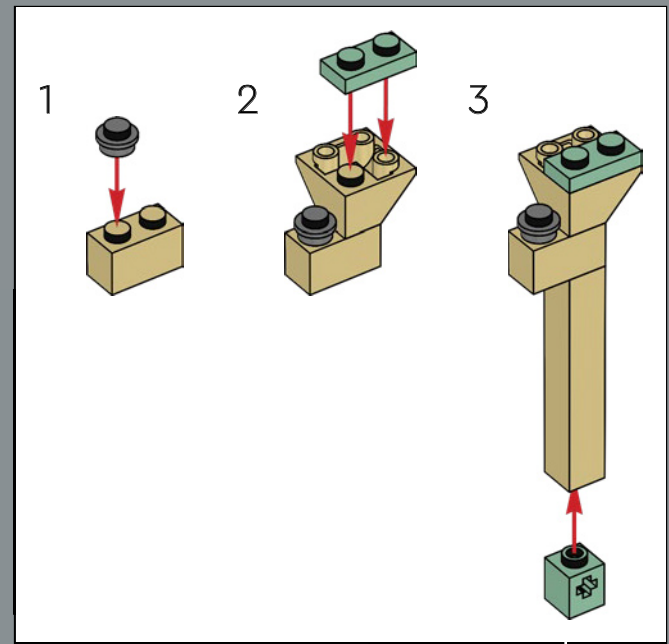
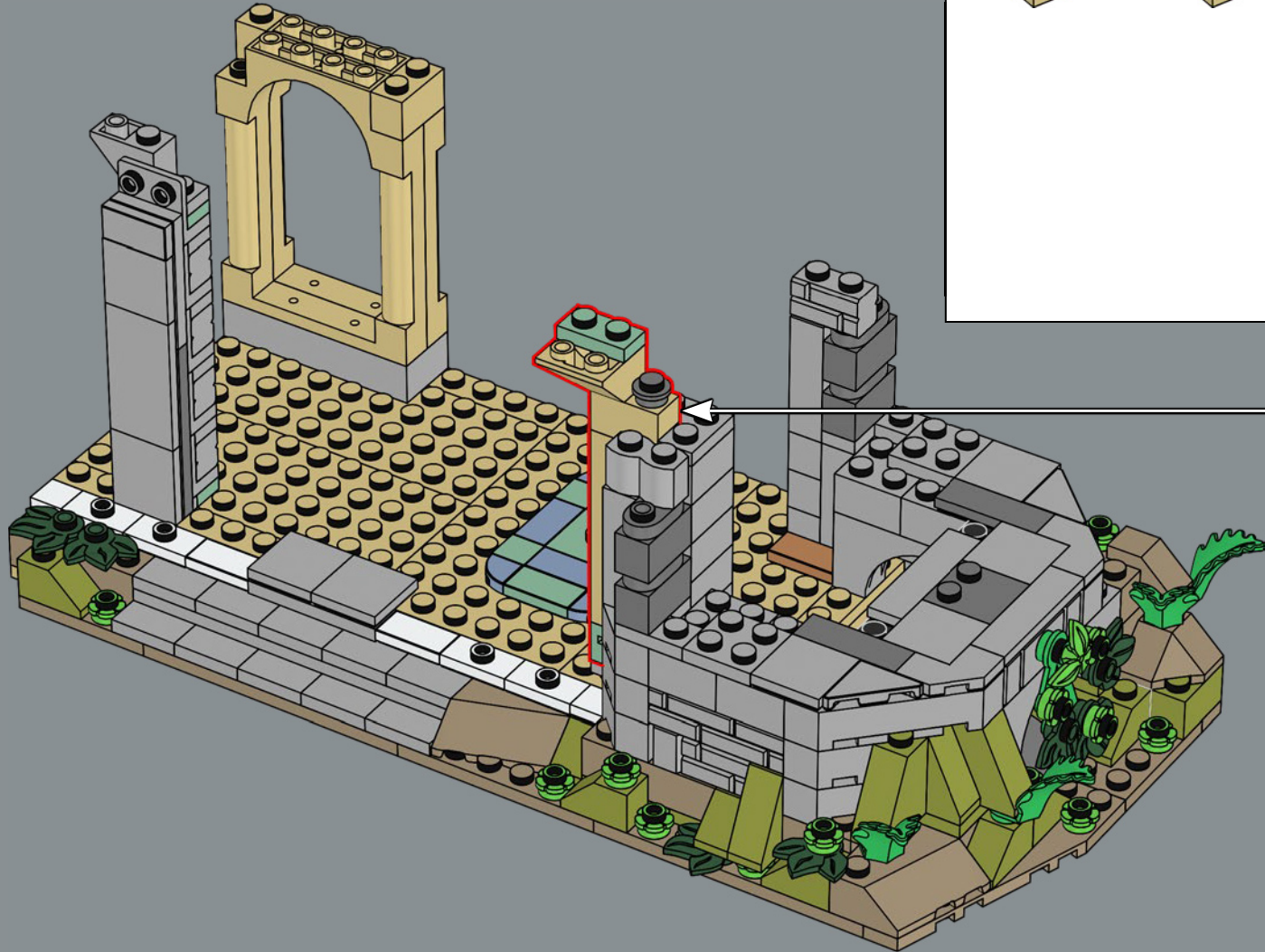

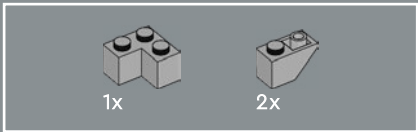

43

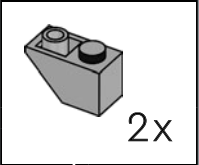

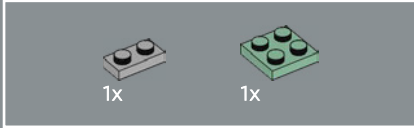
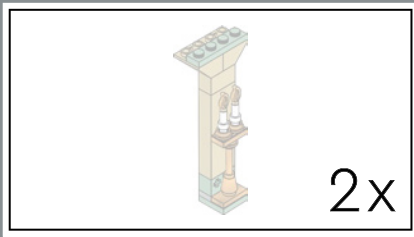

44

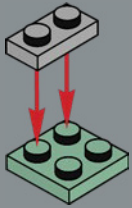

45

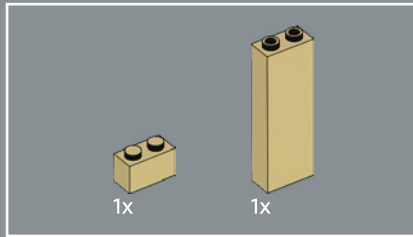
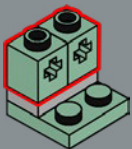

46

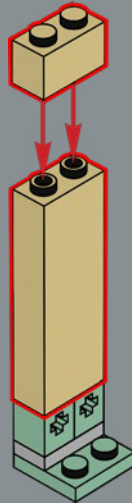

47

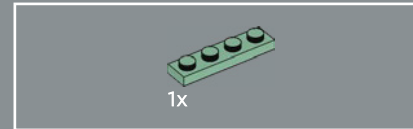
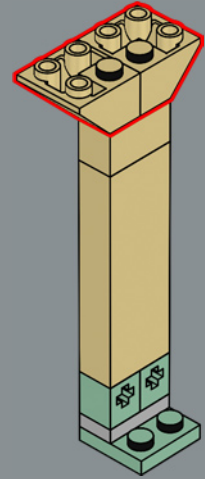

48

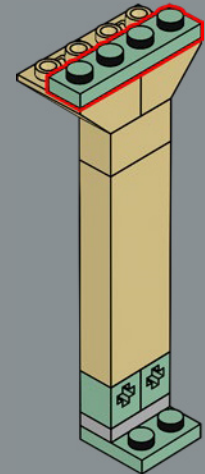

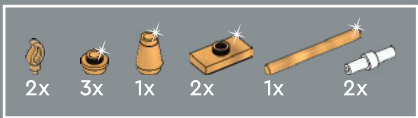

49

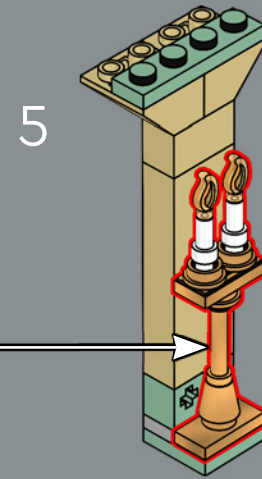
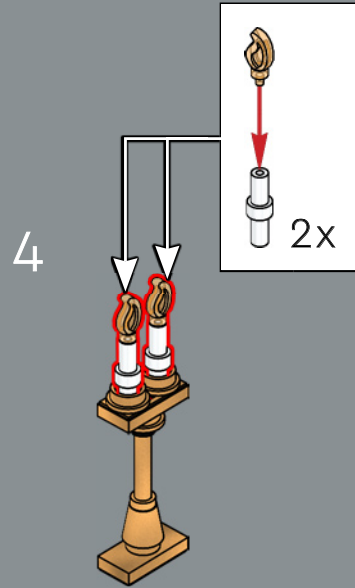
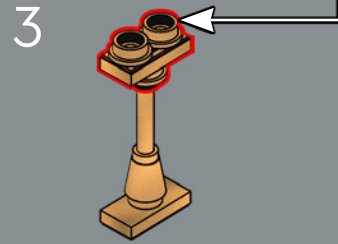
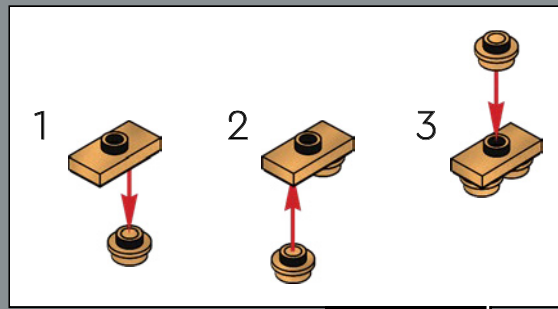
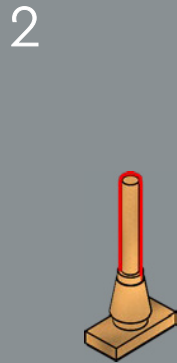
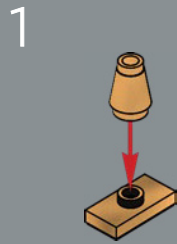

2x



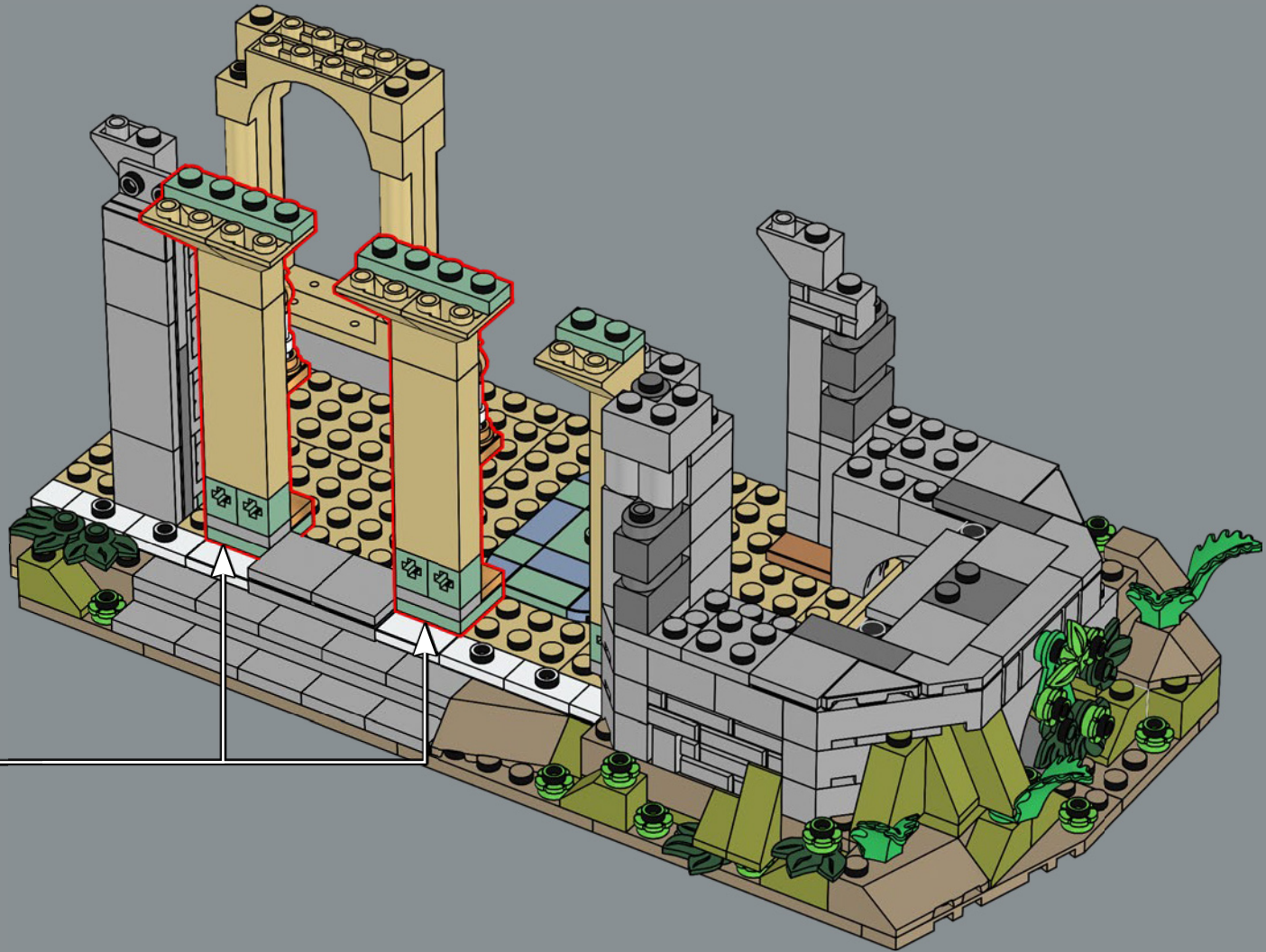

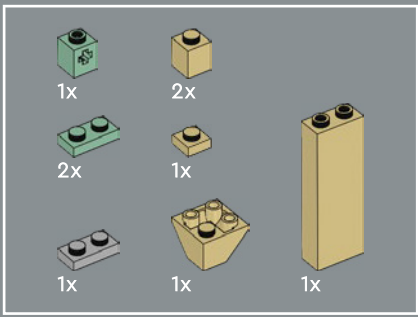

50

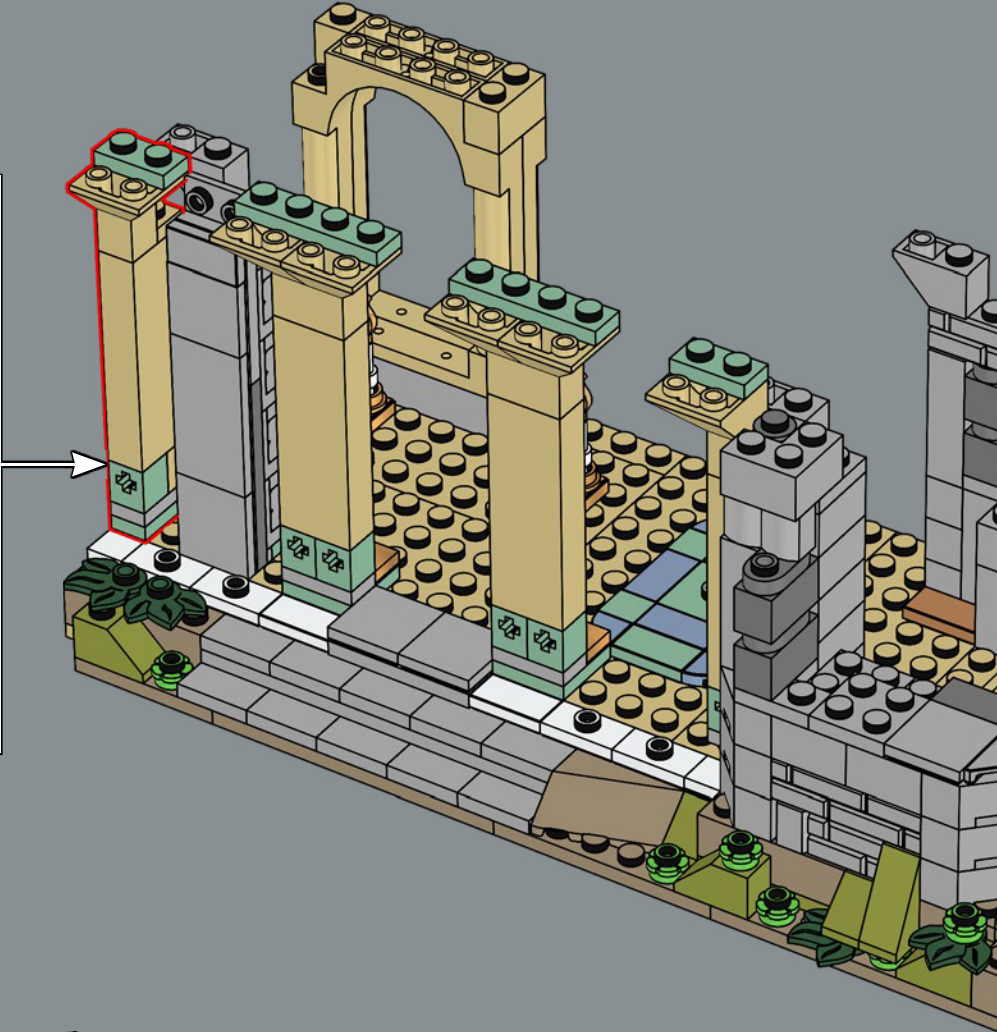
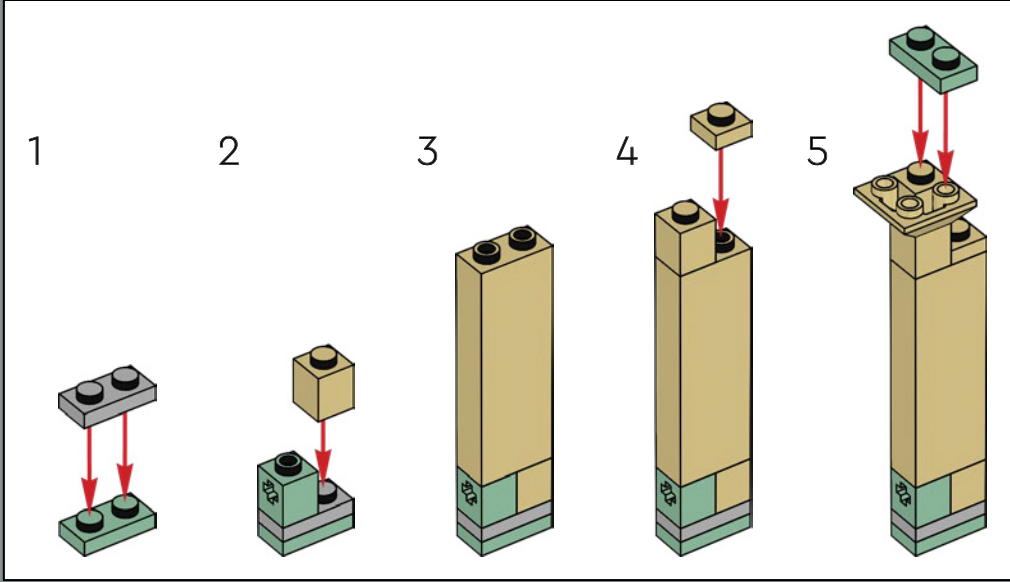

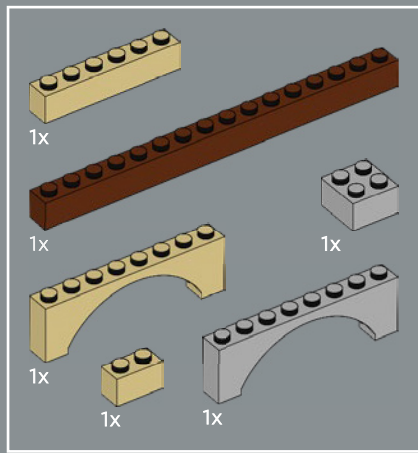

51

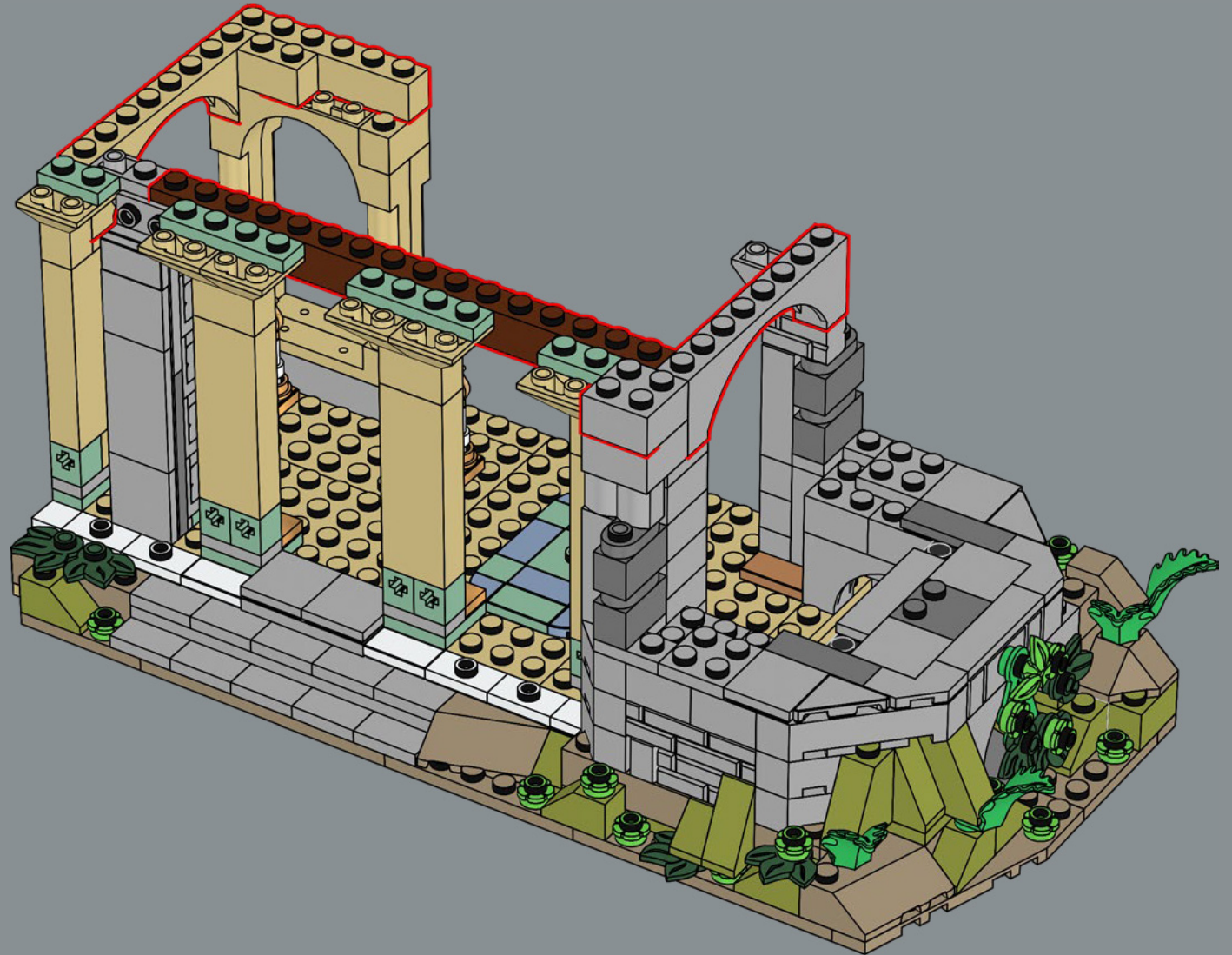

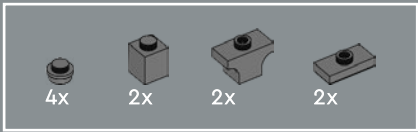

52

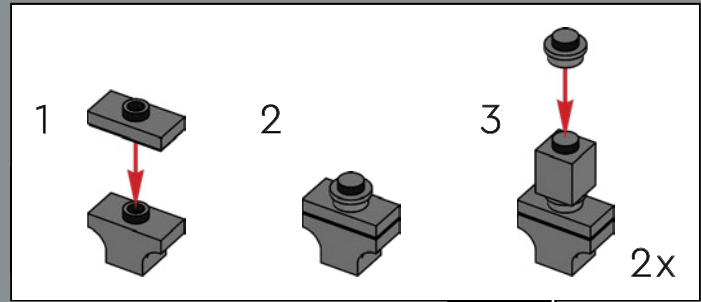
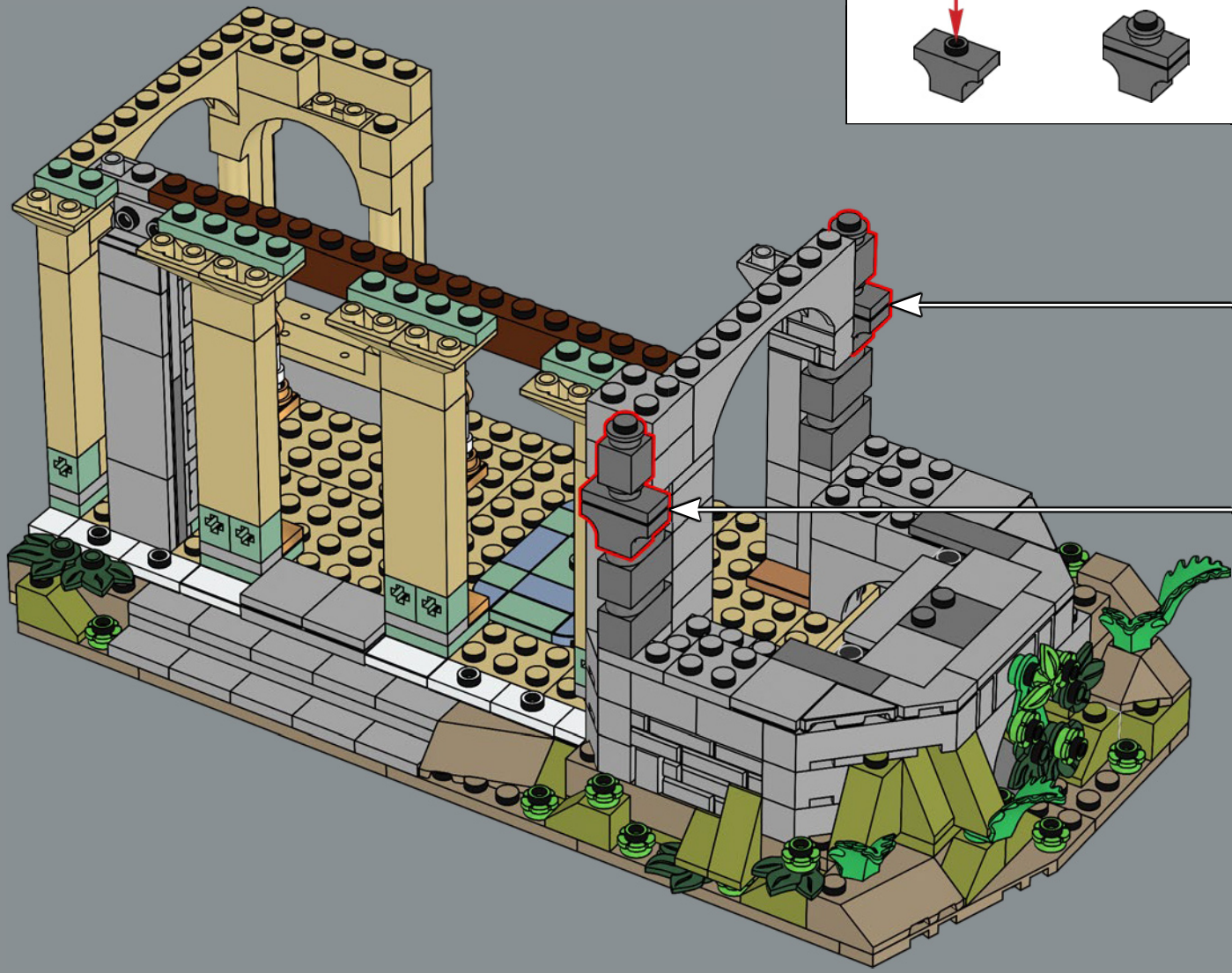

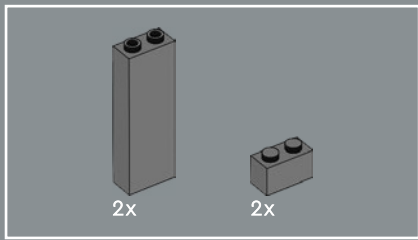

53

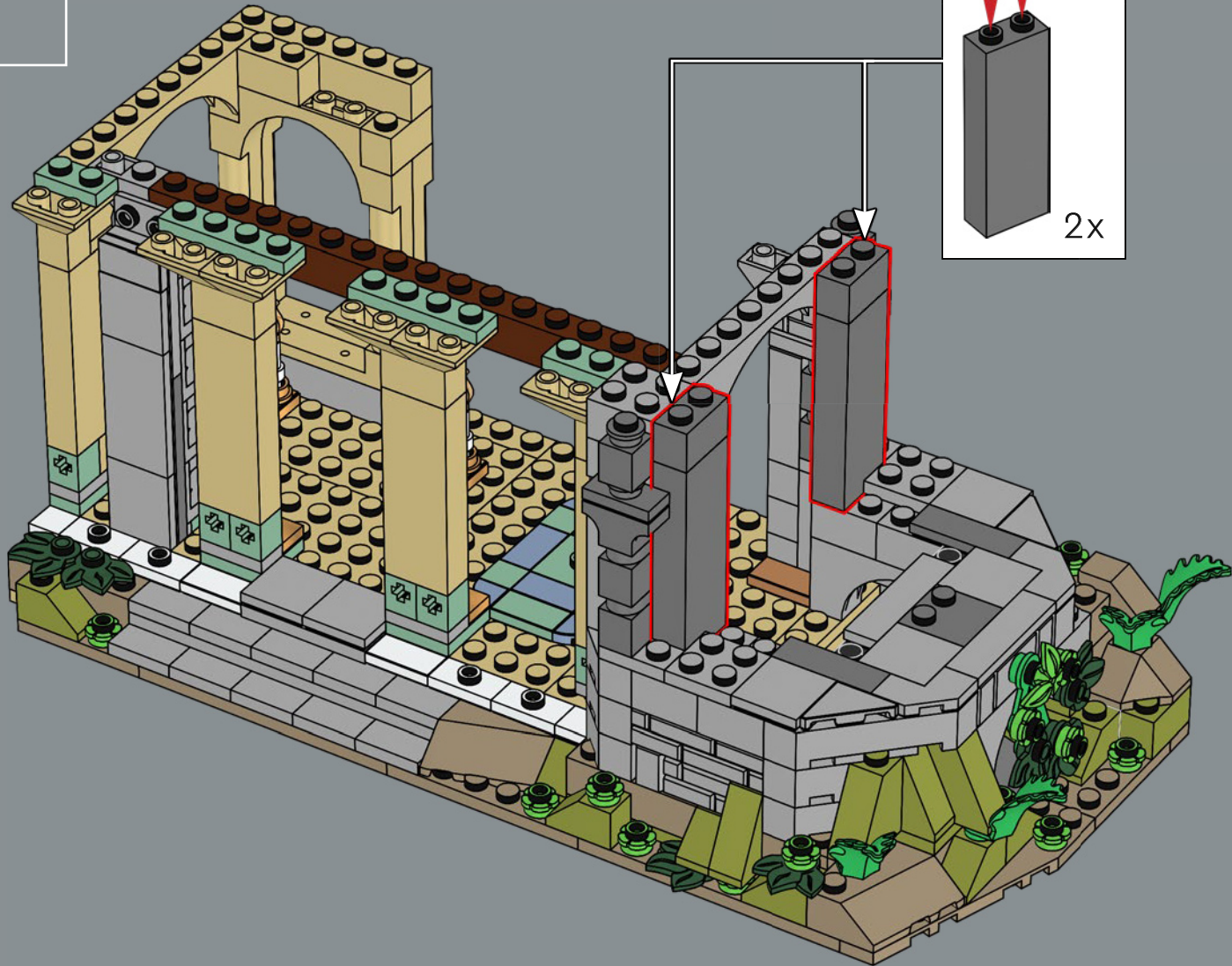



4x

54



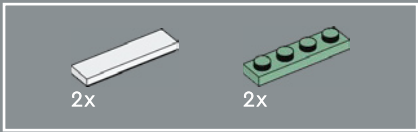

55

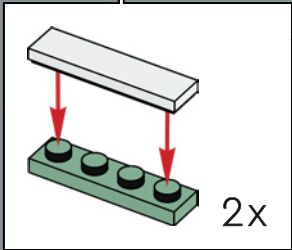
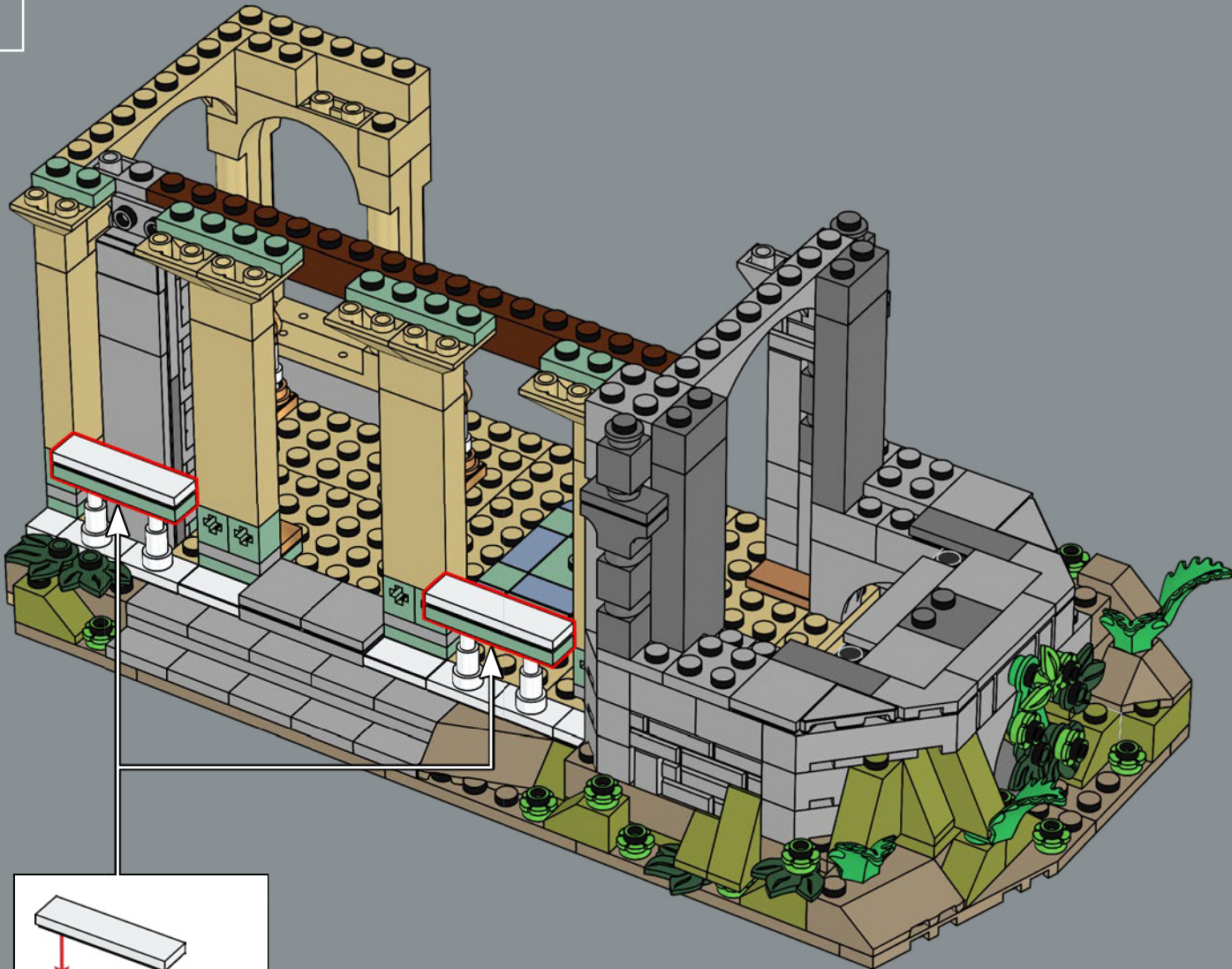

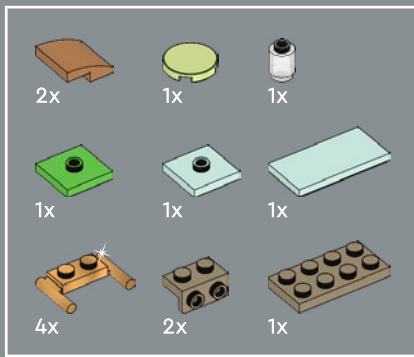

56

1



2

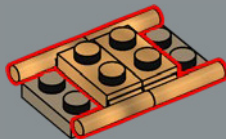

3

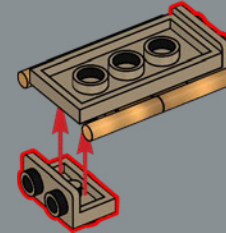

4

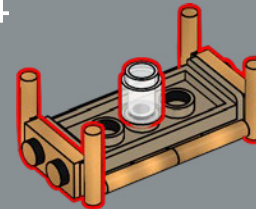

5

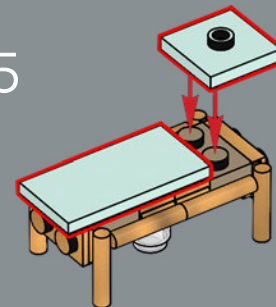

6

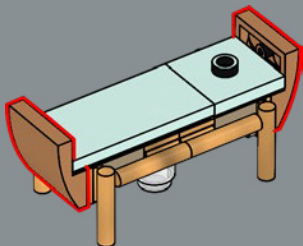

7

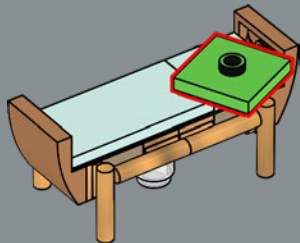

8

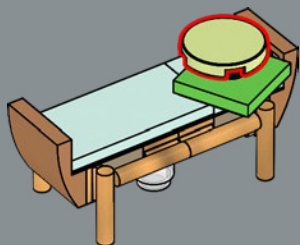

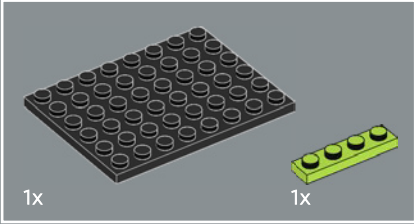
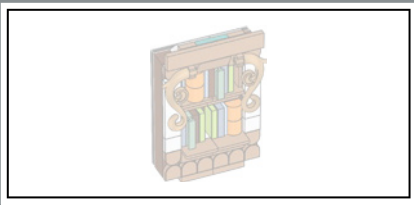

57

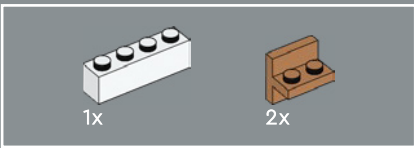
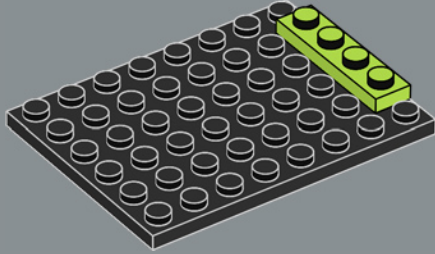

58

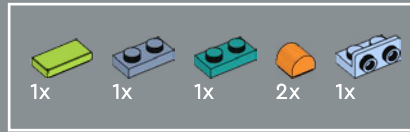
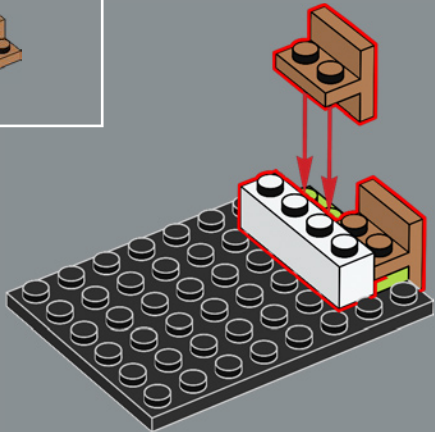

59

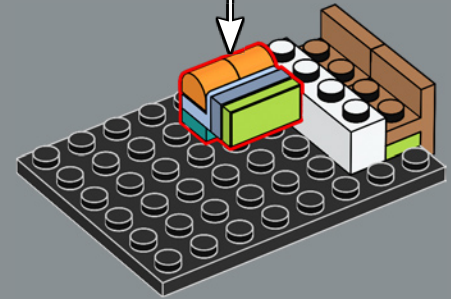
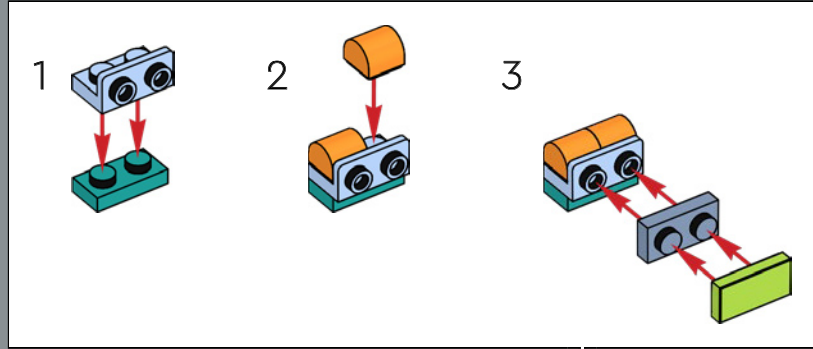

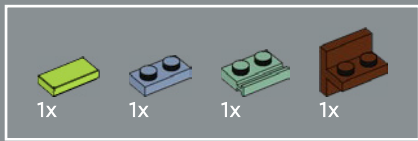

60

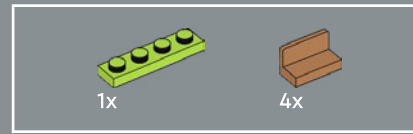
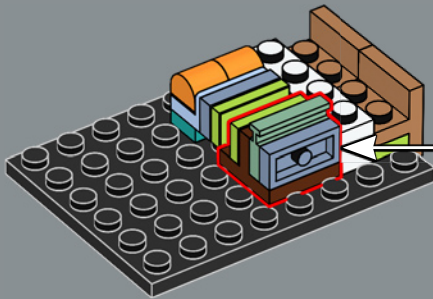
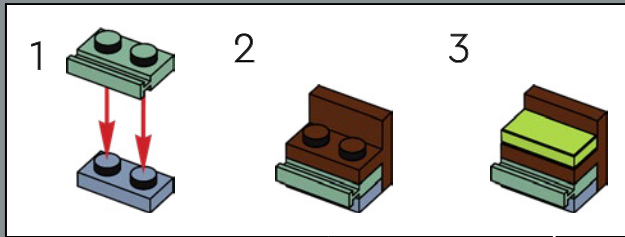

61

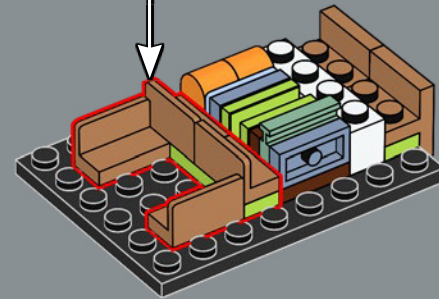
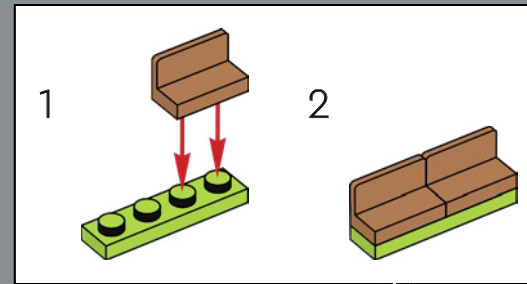

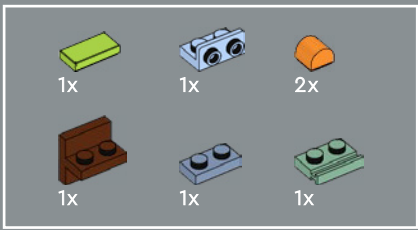

62

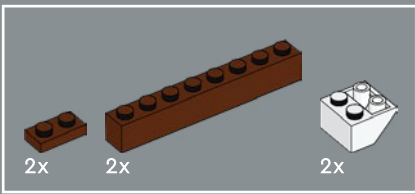
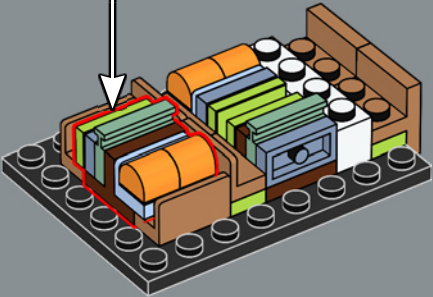
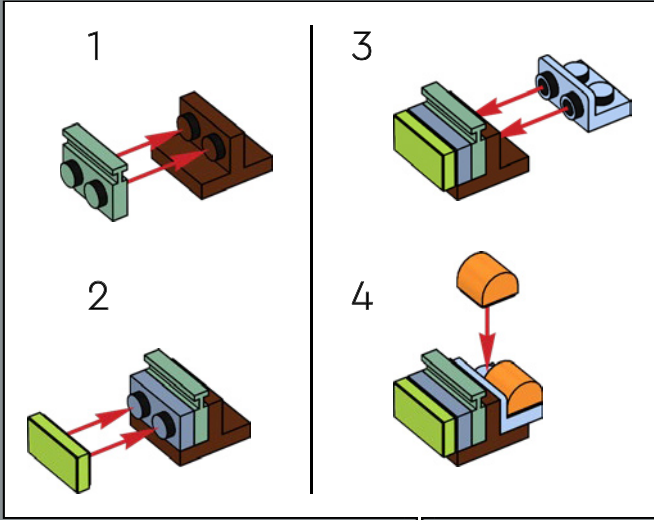

63

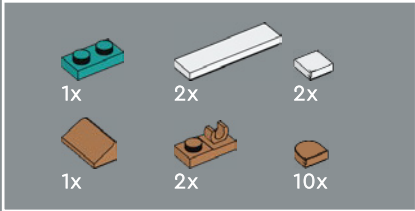
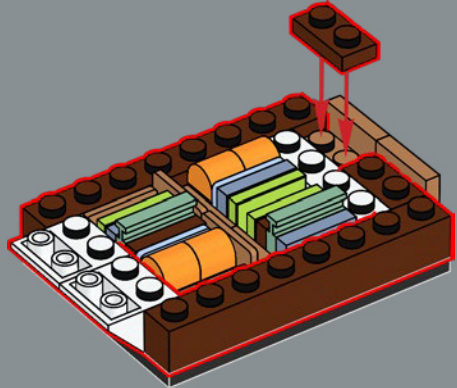

64

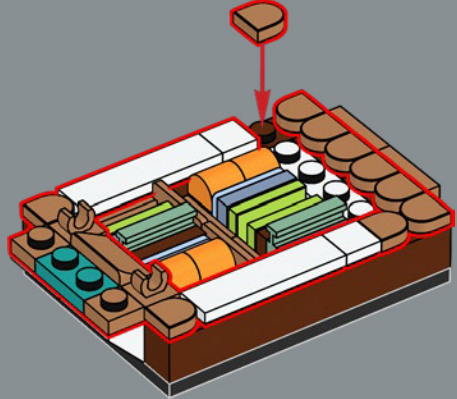

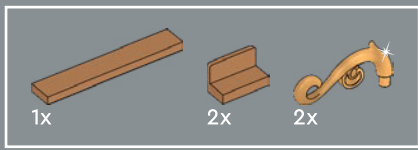

65

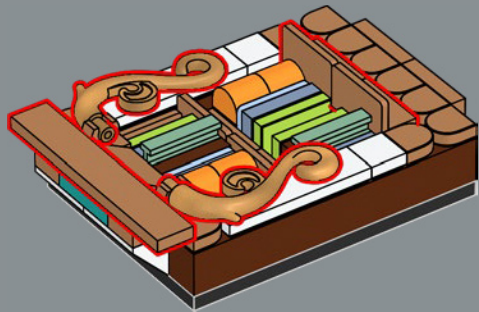

66

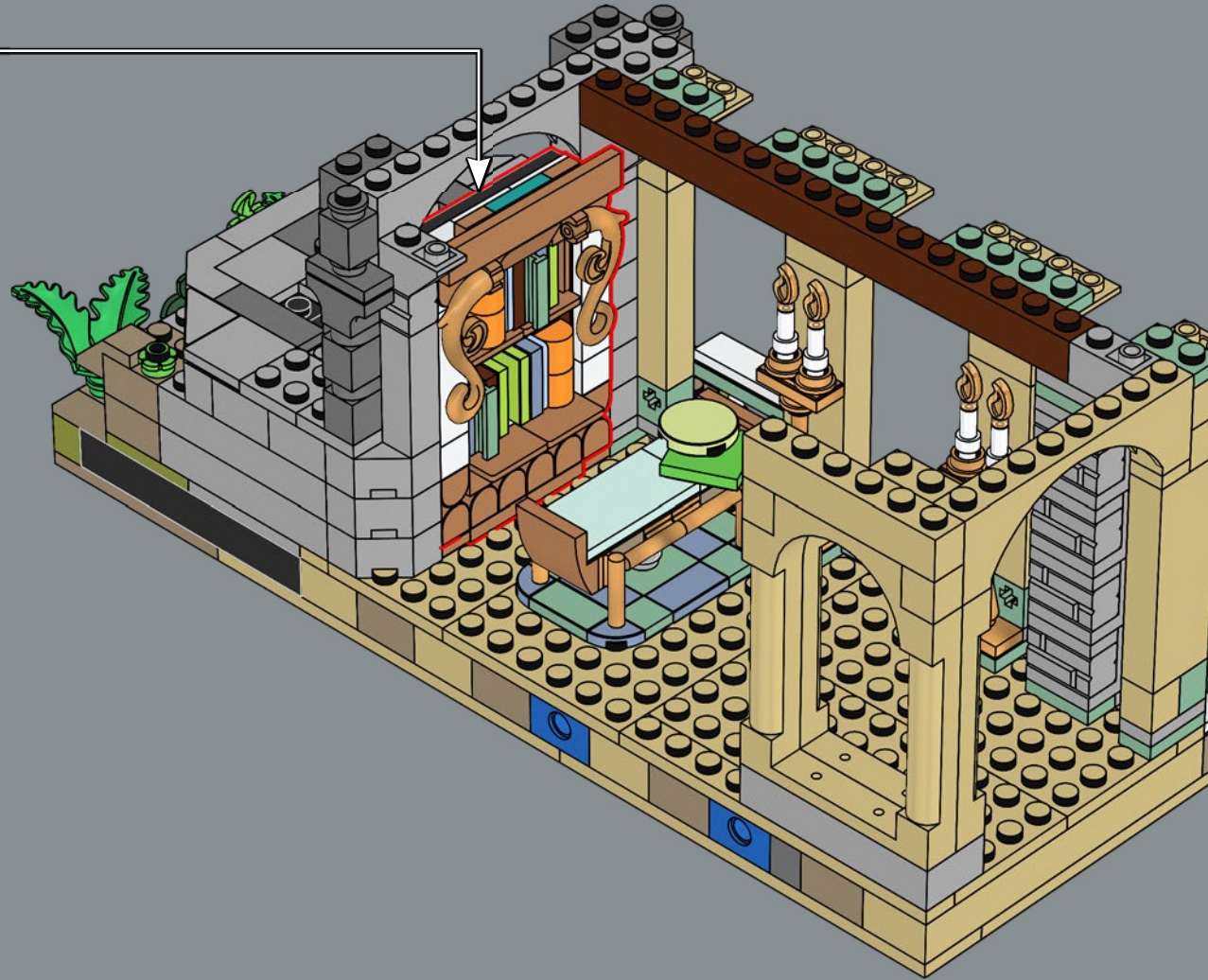

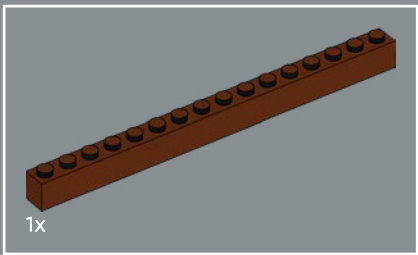

67



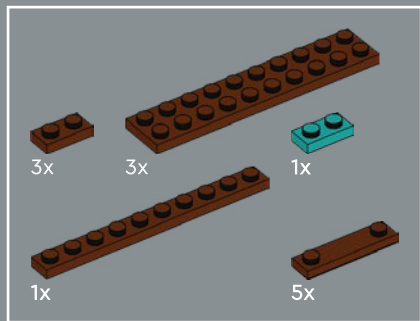

68

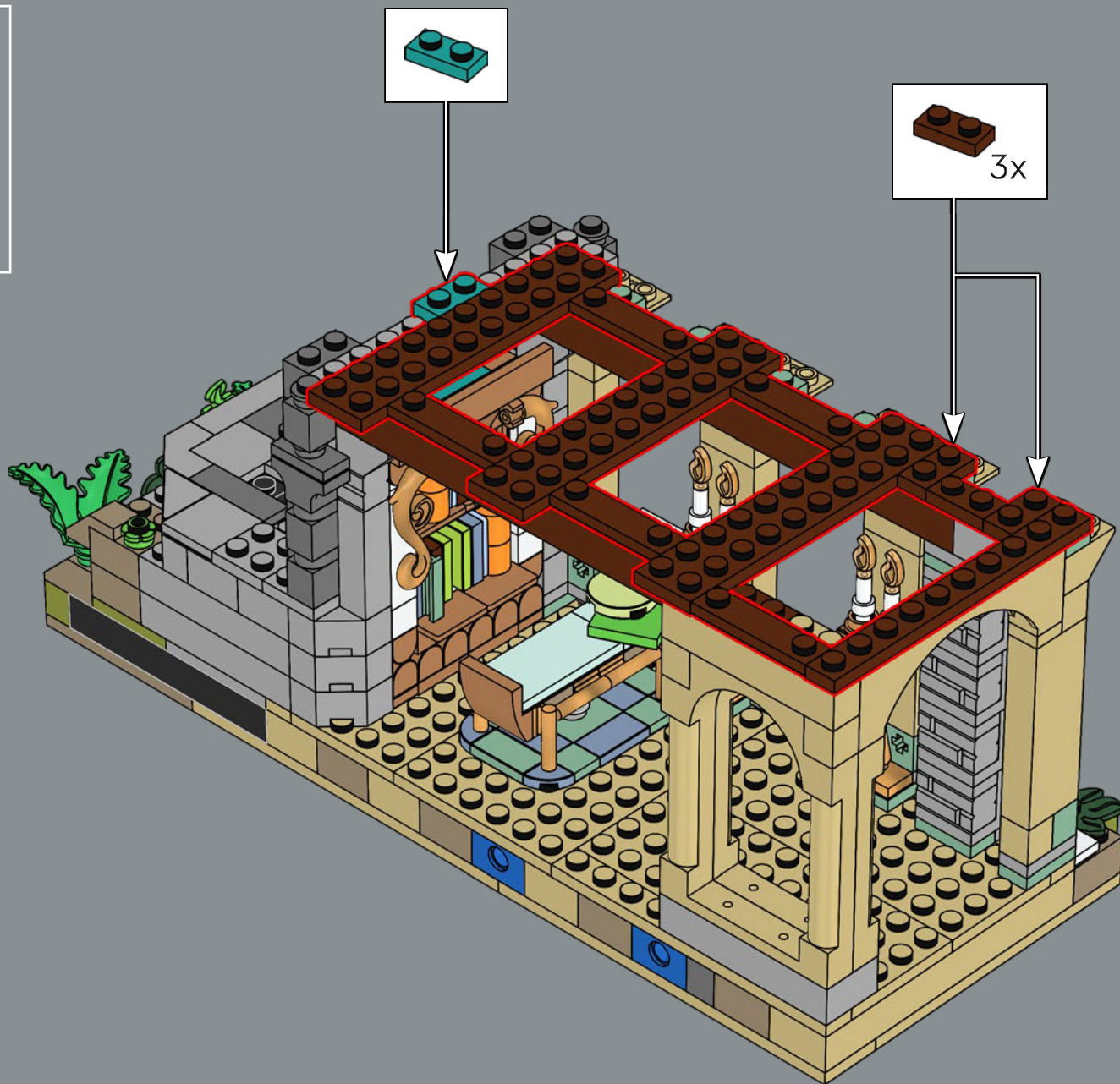

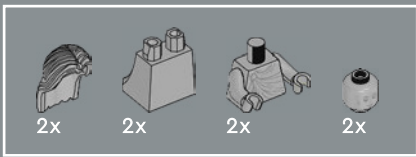

69

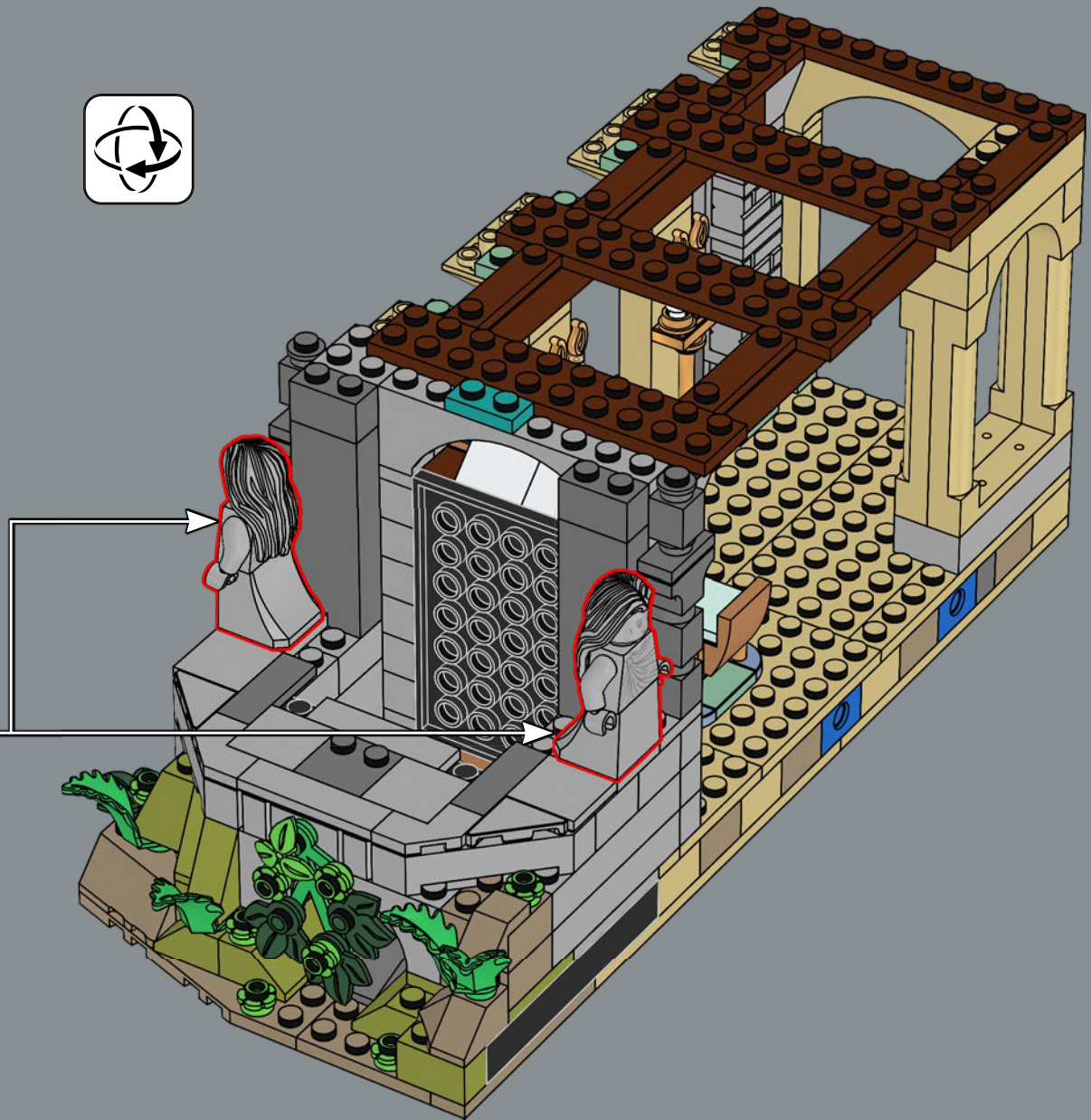
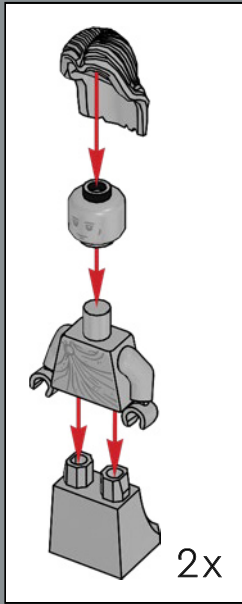

Le nuove decorazioni della testa per le statue presentano due espressioni distinte: faccia di pietra e sguardo duro!





70

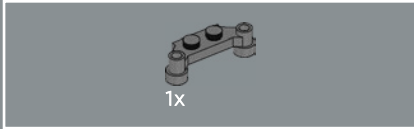
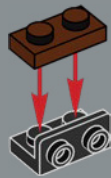

71

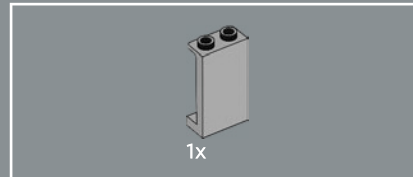
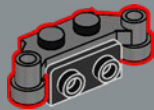

72

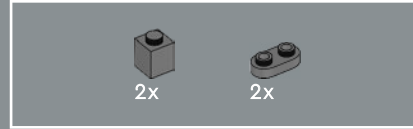
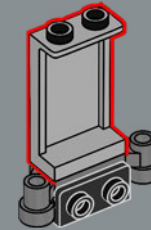

73

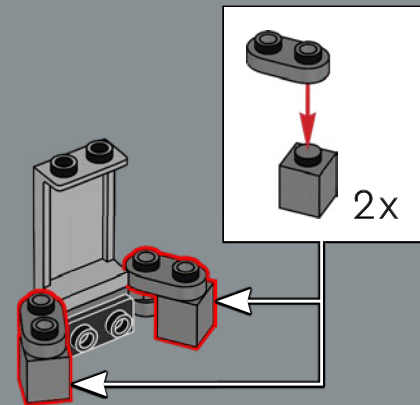



2x

74

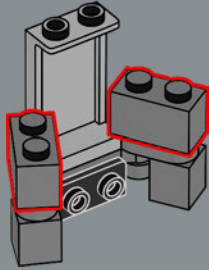

2x

75

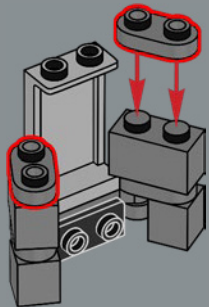

2x



2x

76

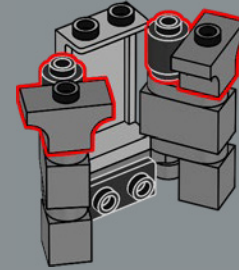

1x

77

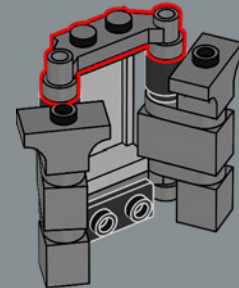

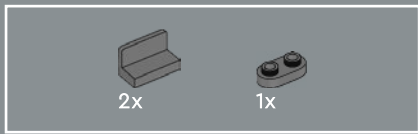

78

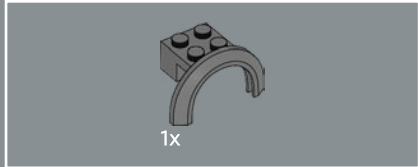
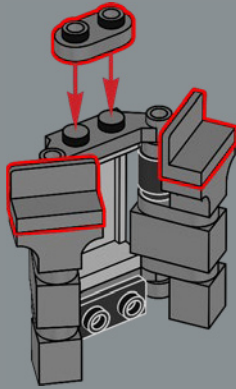

79

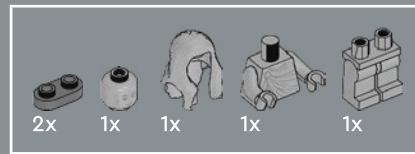
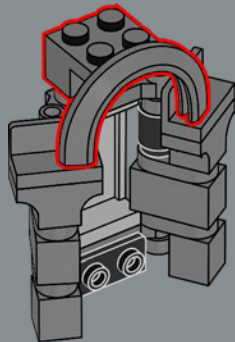

80

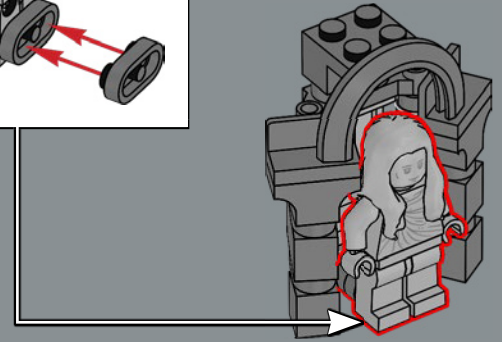
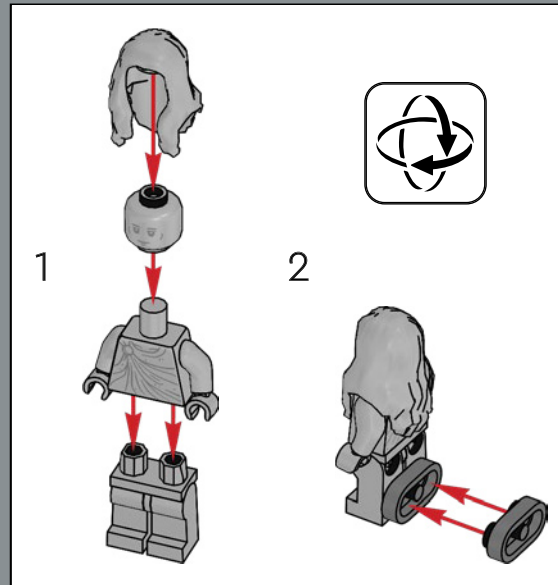



1x

81

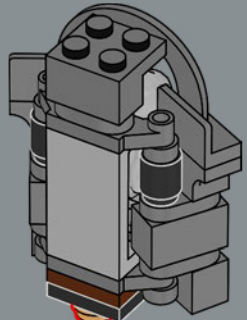

2x



82

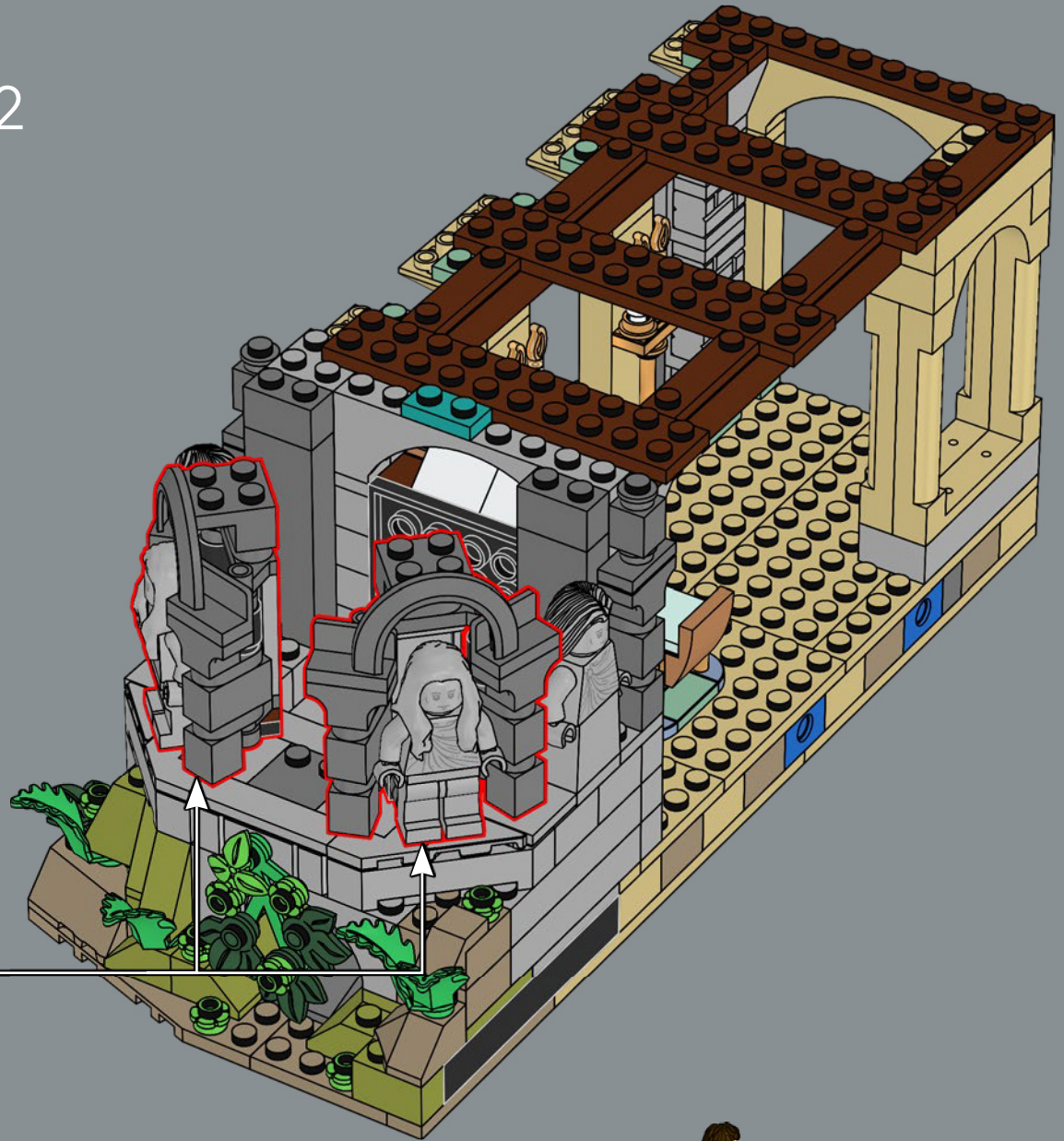

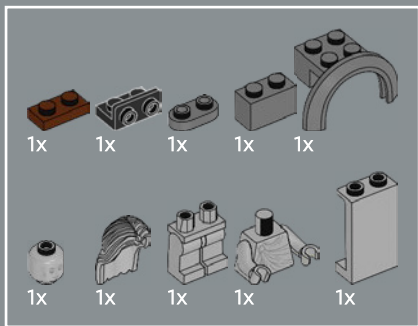

83

1

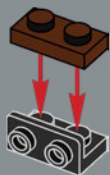

2

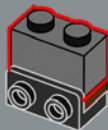

3

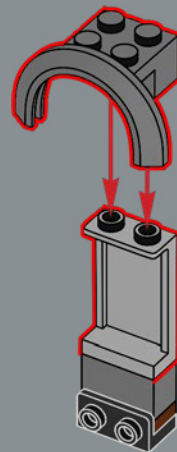

4

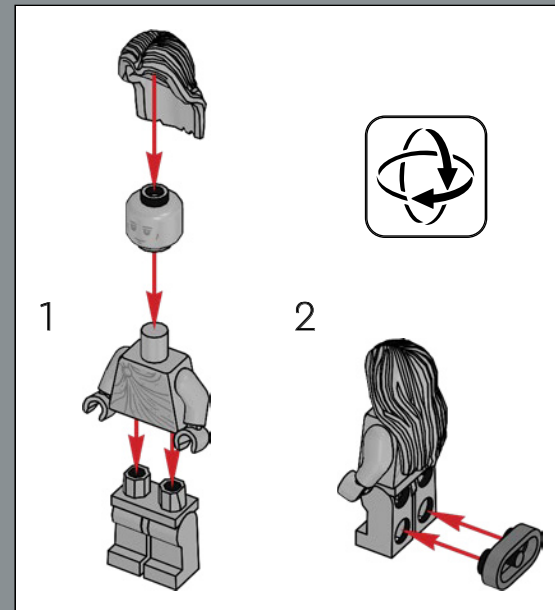

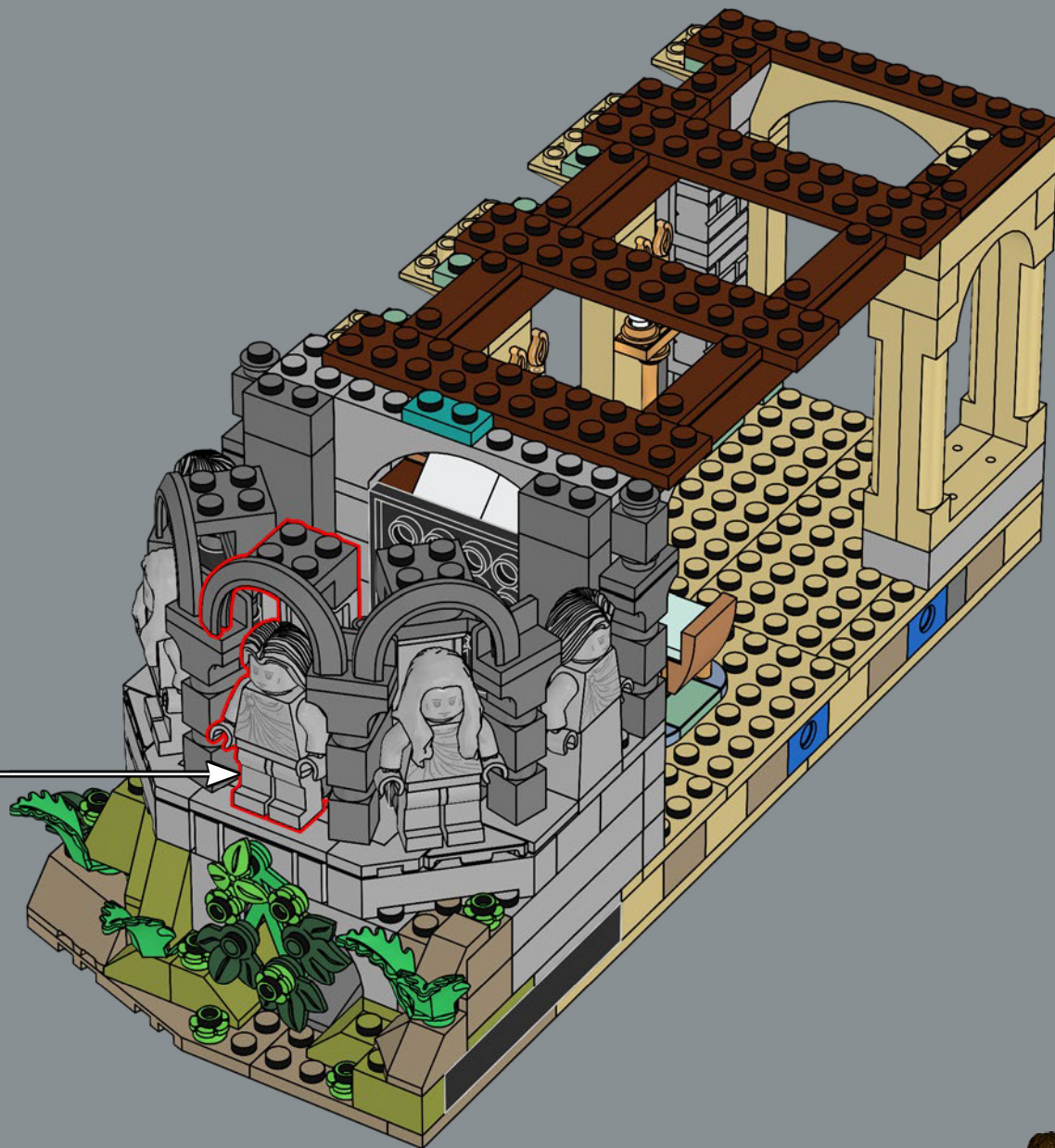

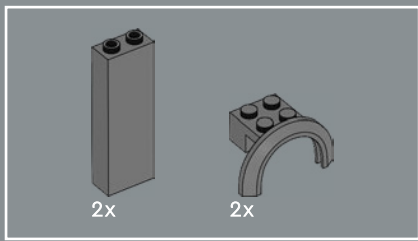

84

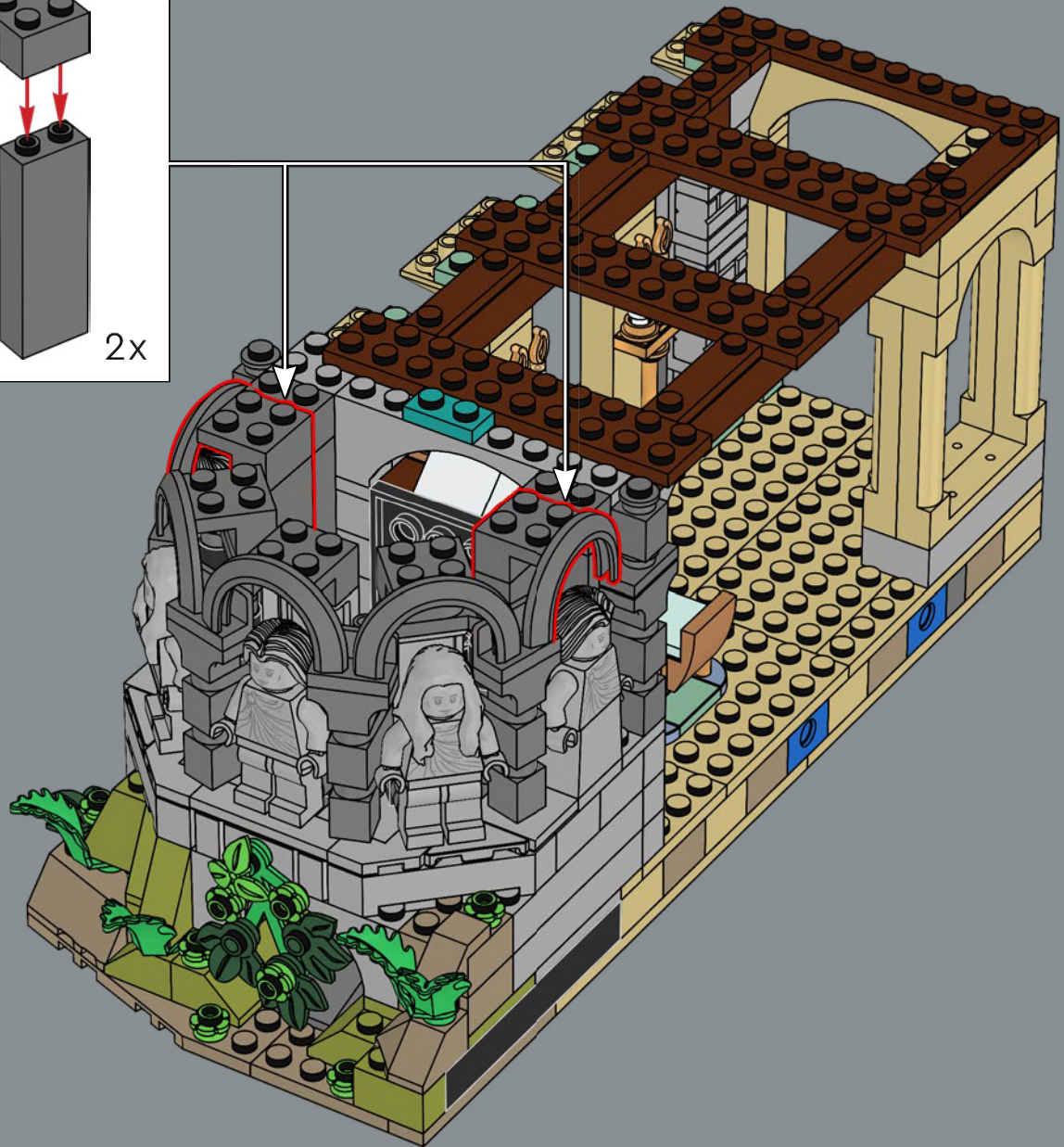
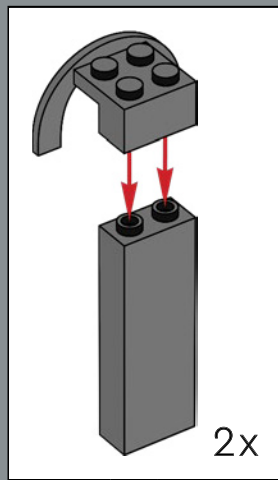

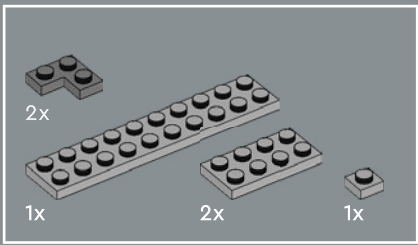

85

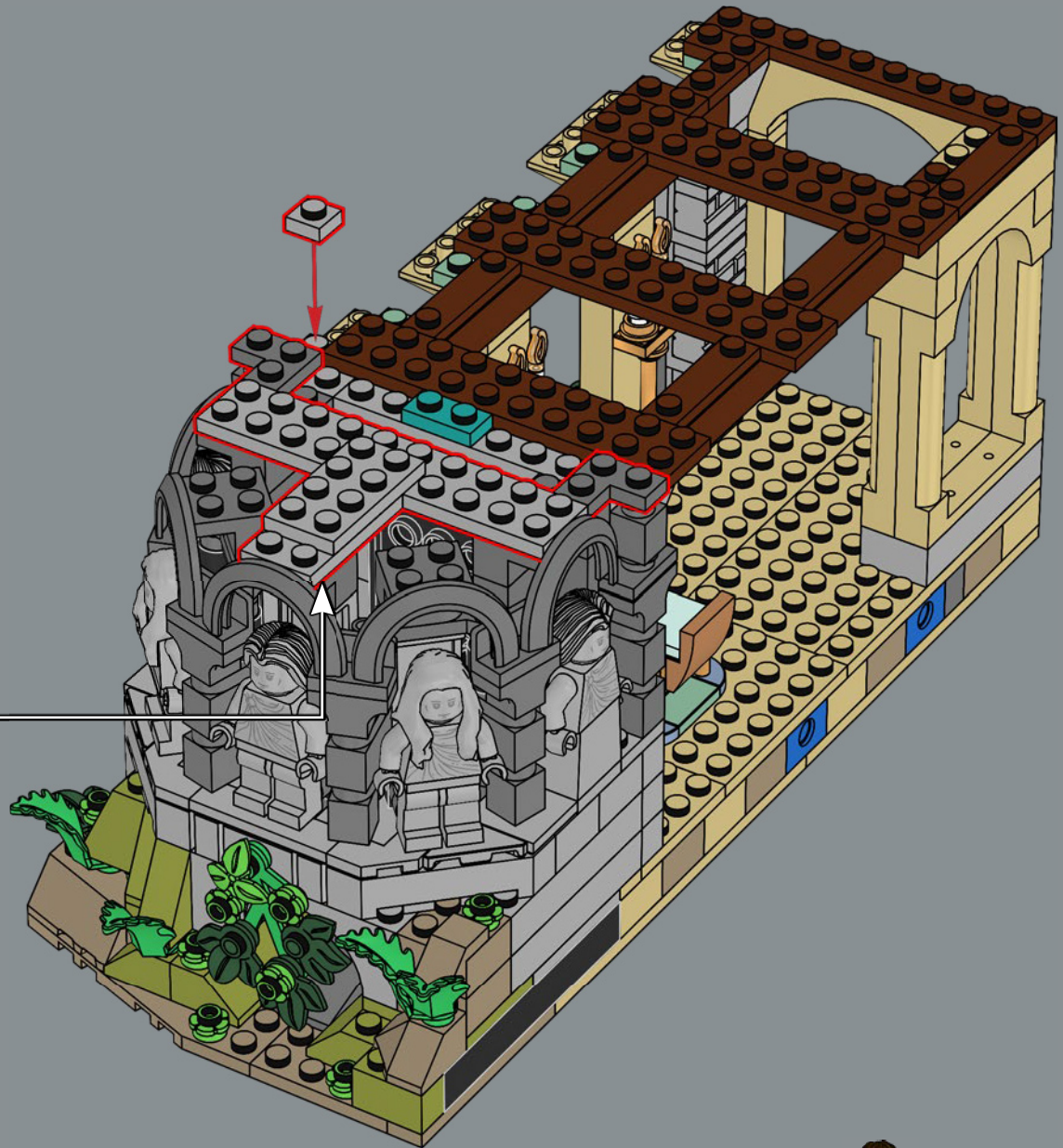
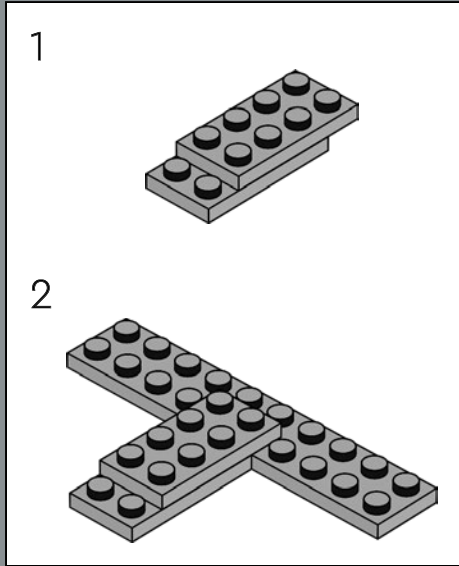

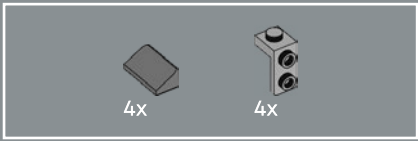

86

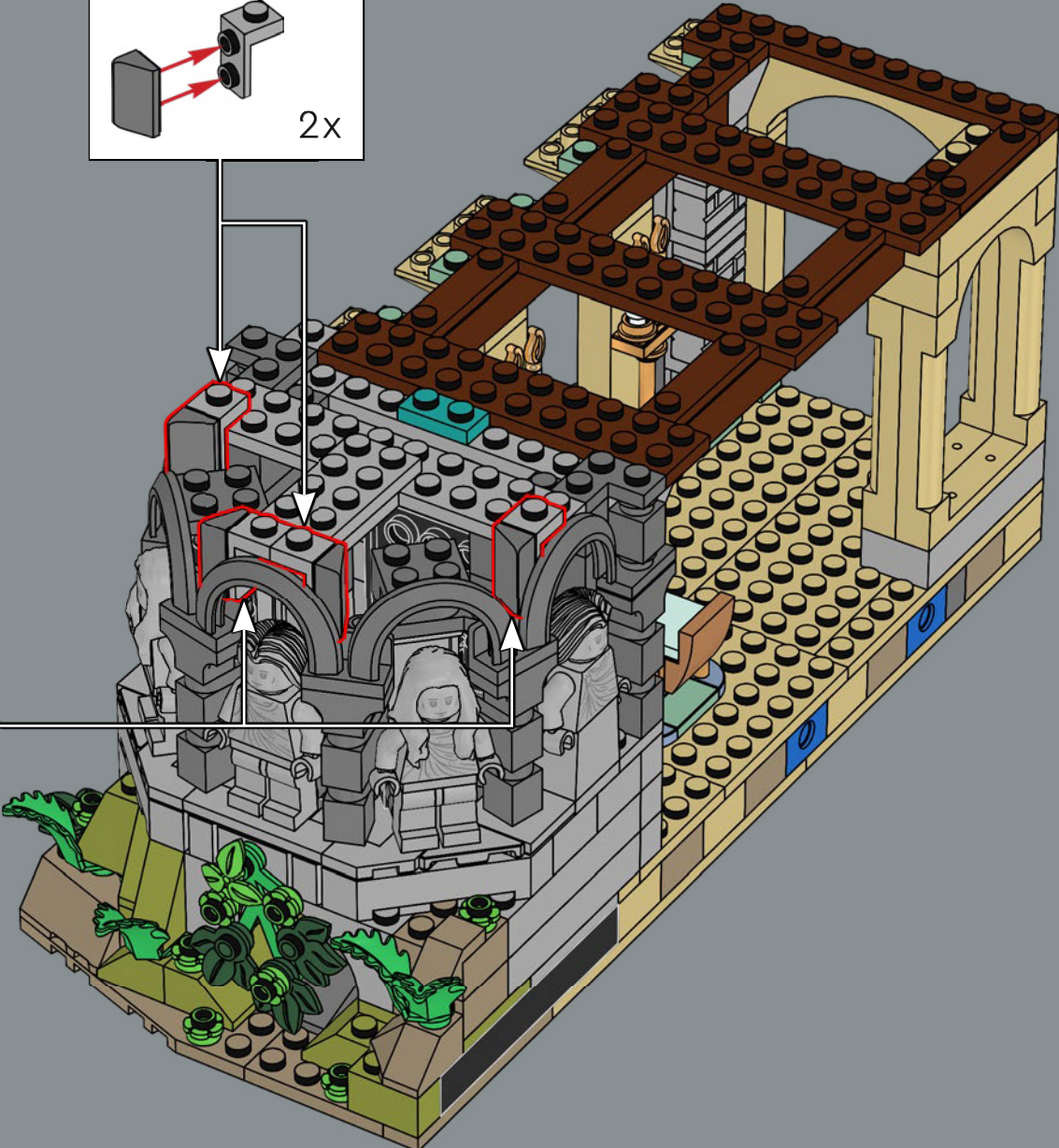
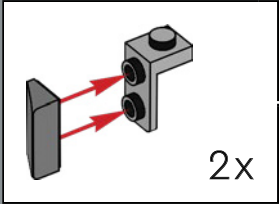
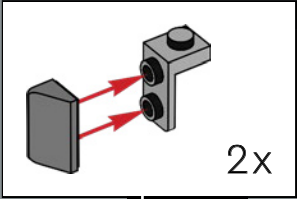

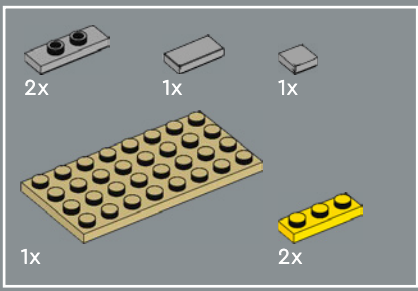

87



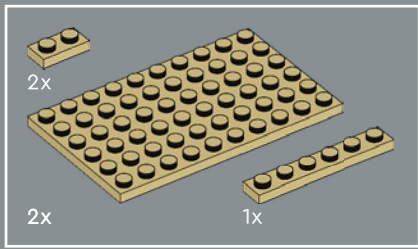

88



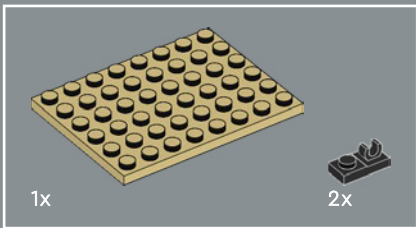
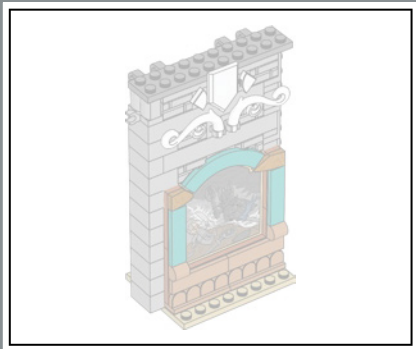

89

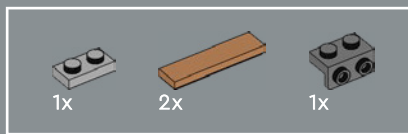
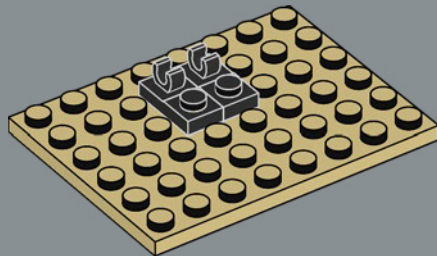

90

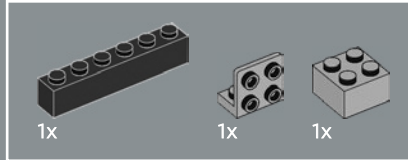
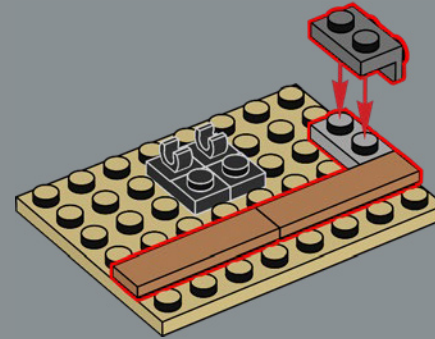

91

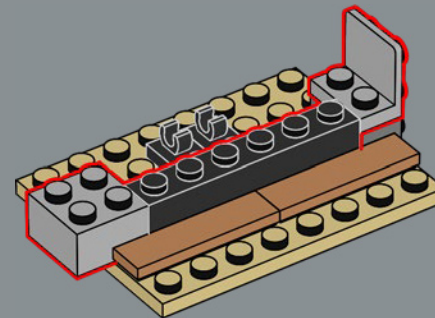

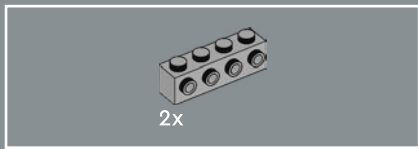

92

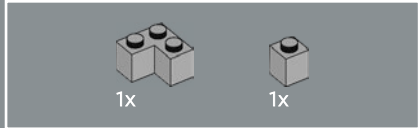
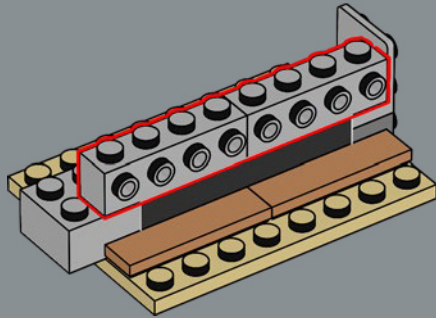

93

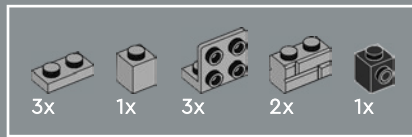
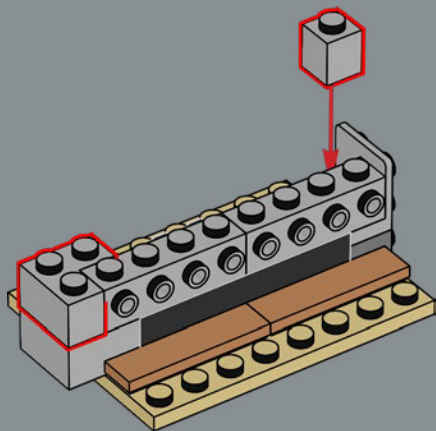

94

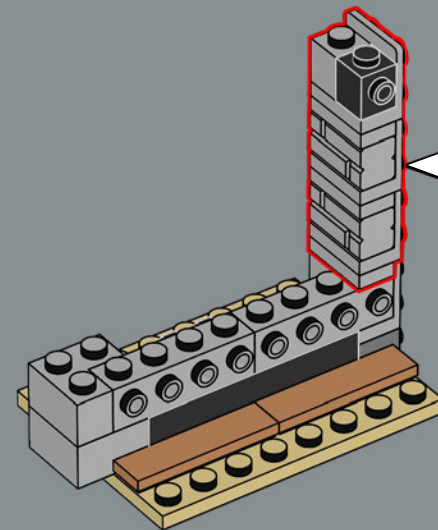
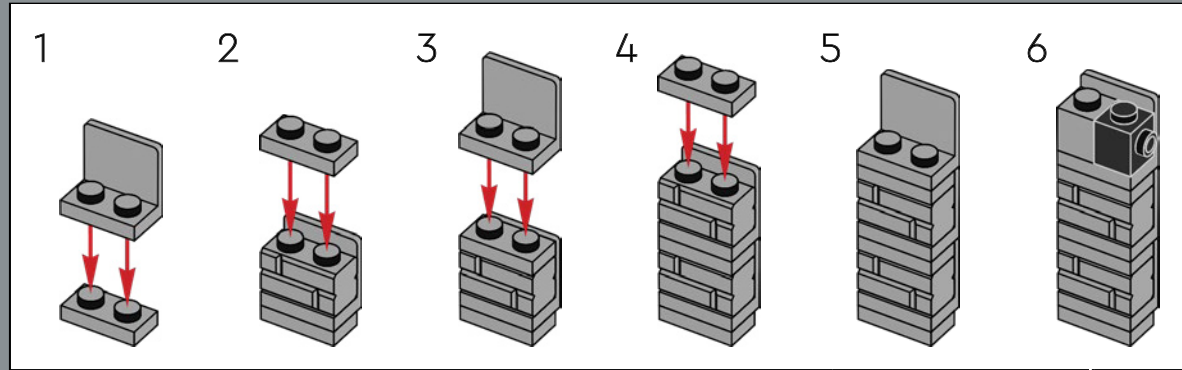

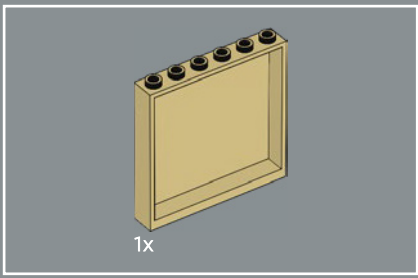

95

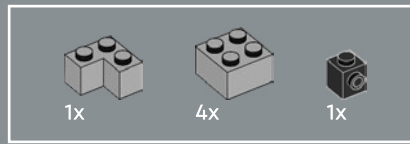
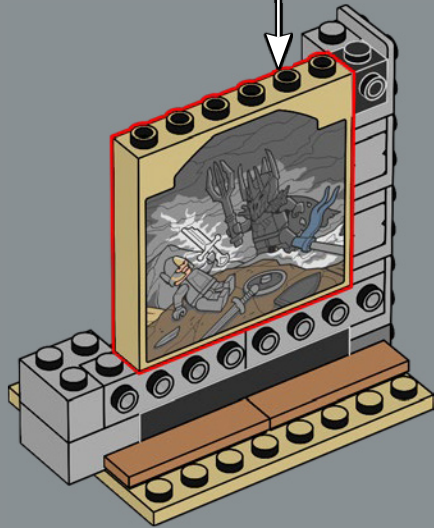
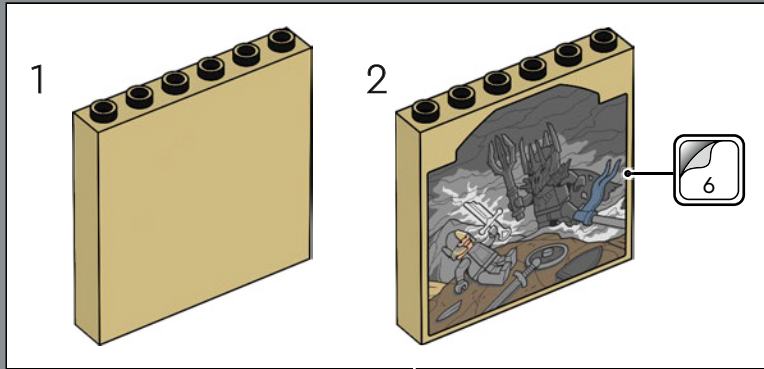

96

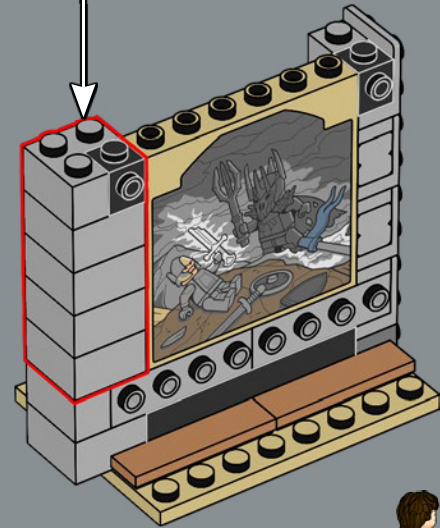
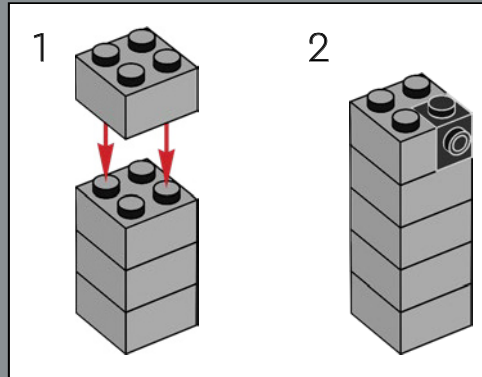

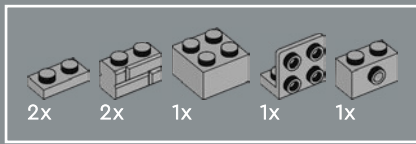

97

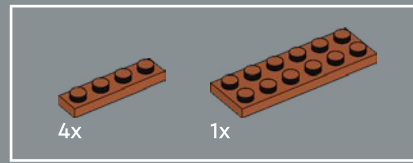
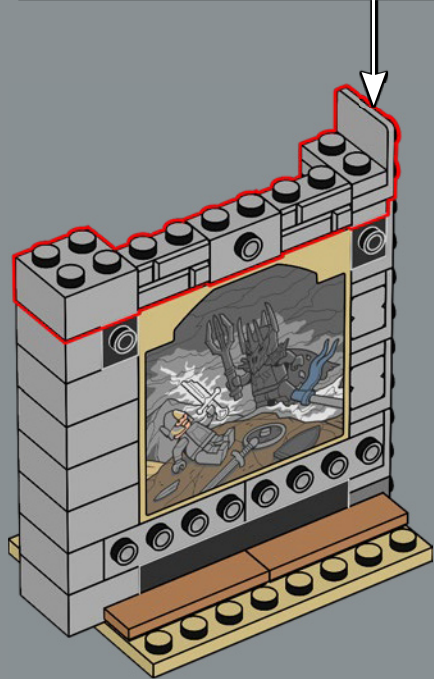
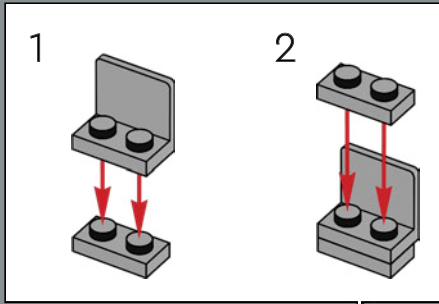

98

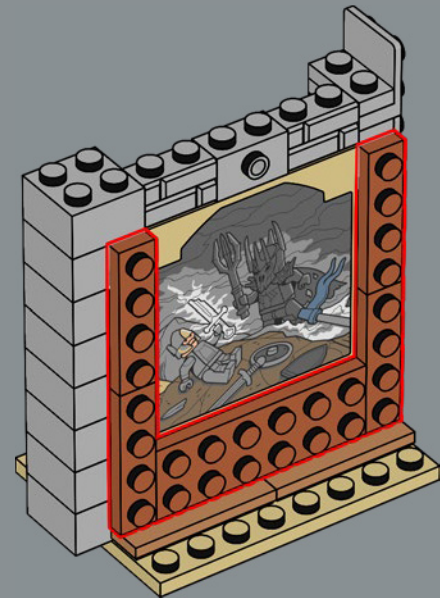

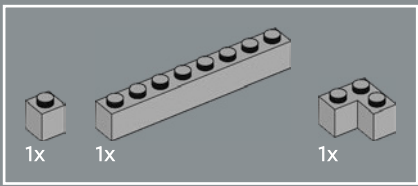

99

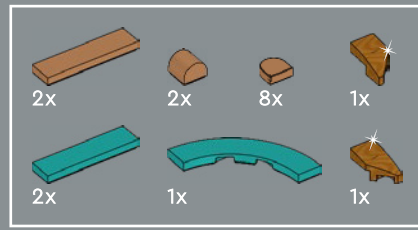
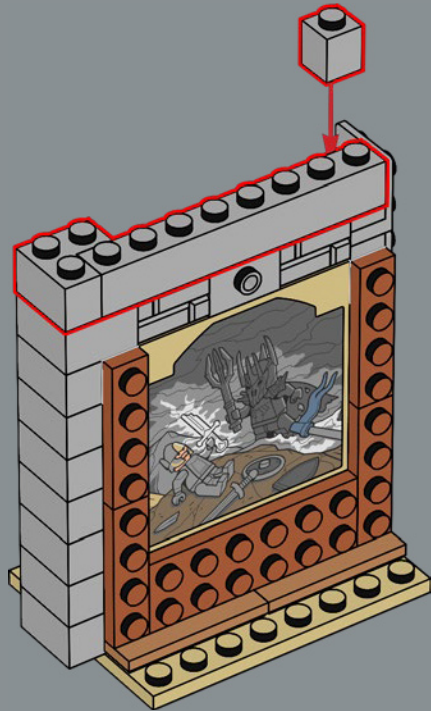

100

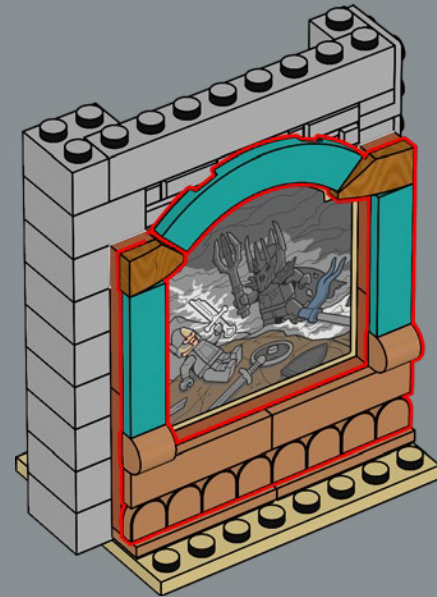

La distruzione di Sauron tradotta nell'universo LEGO®
 presenta l'elemento dell'elsa Narsil di nuova concezione
 e una splendida cornice verde acqua.



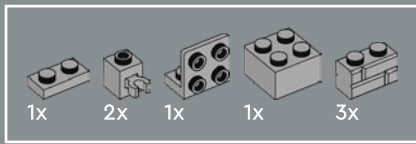

101

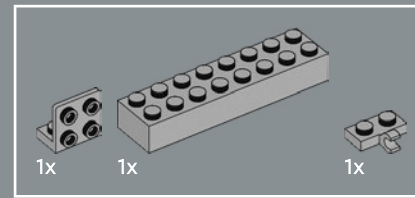
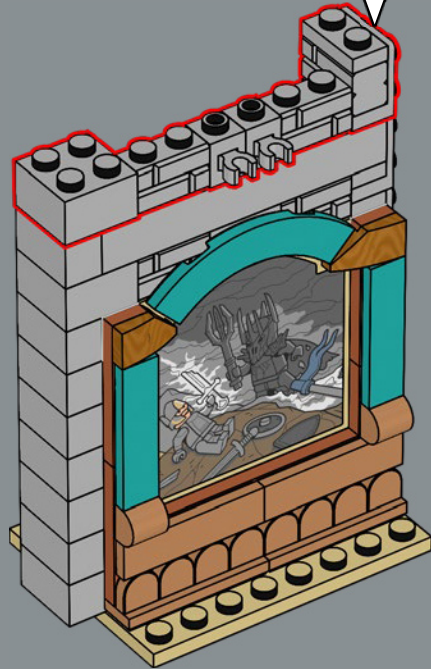
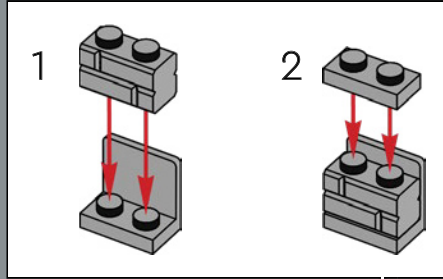

102

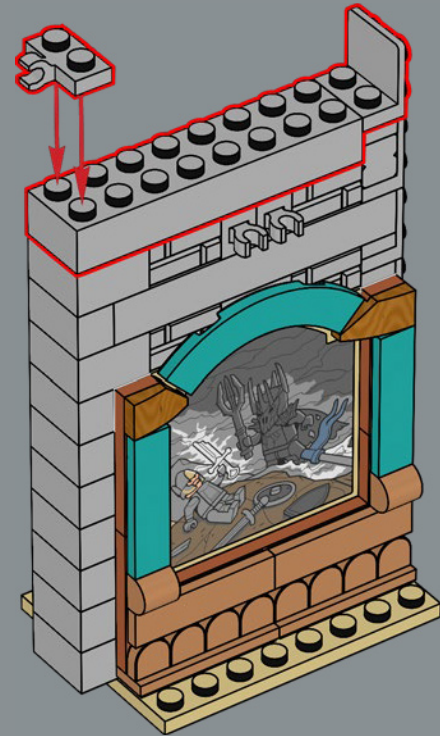

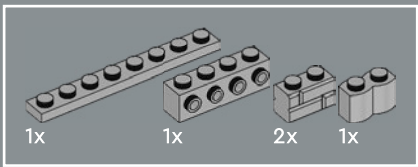

103

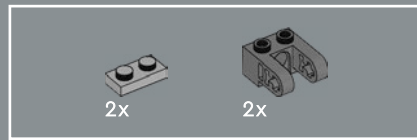
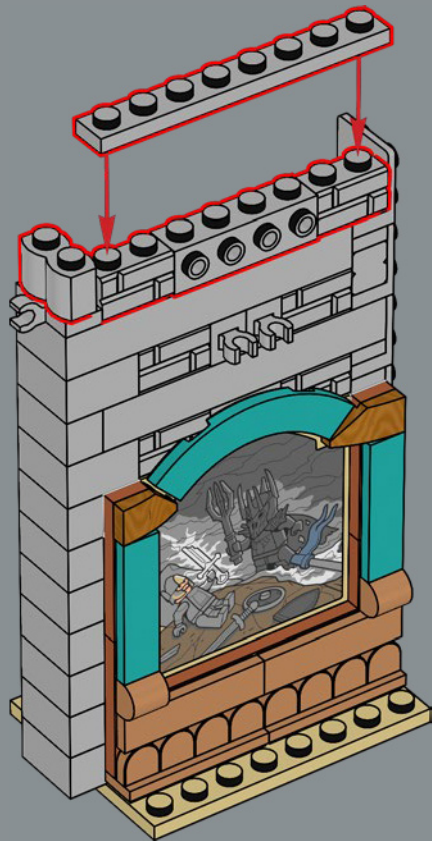

104

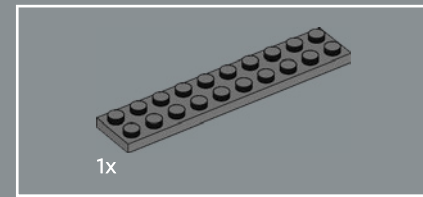
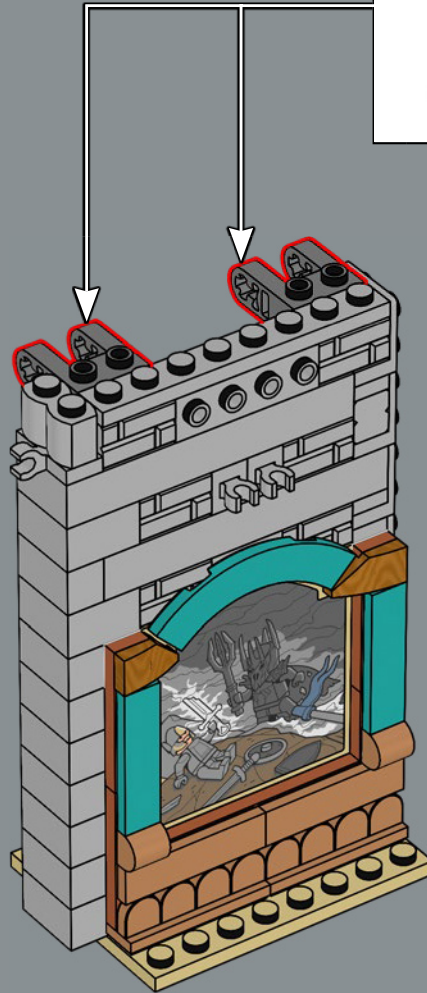
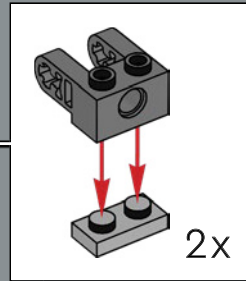

105

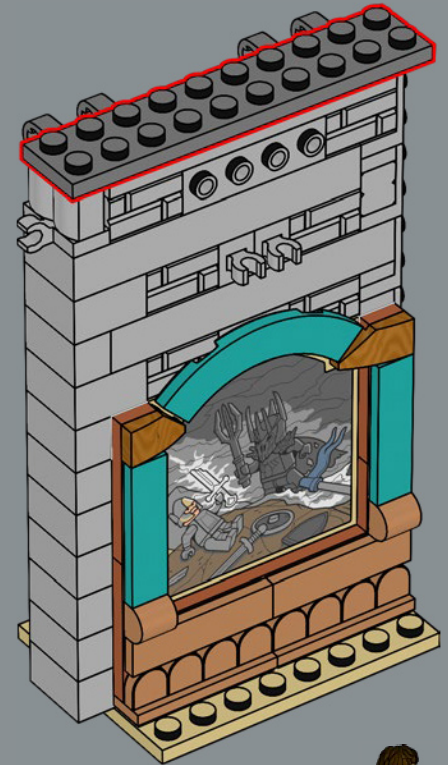



106



107

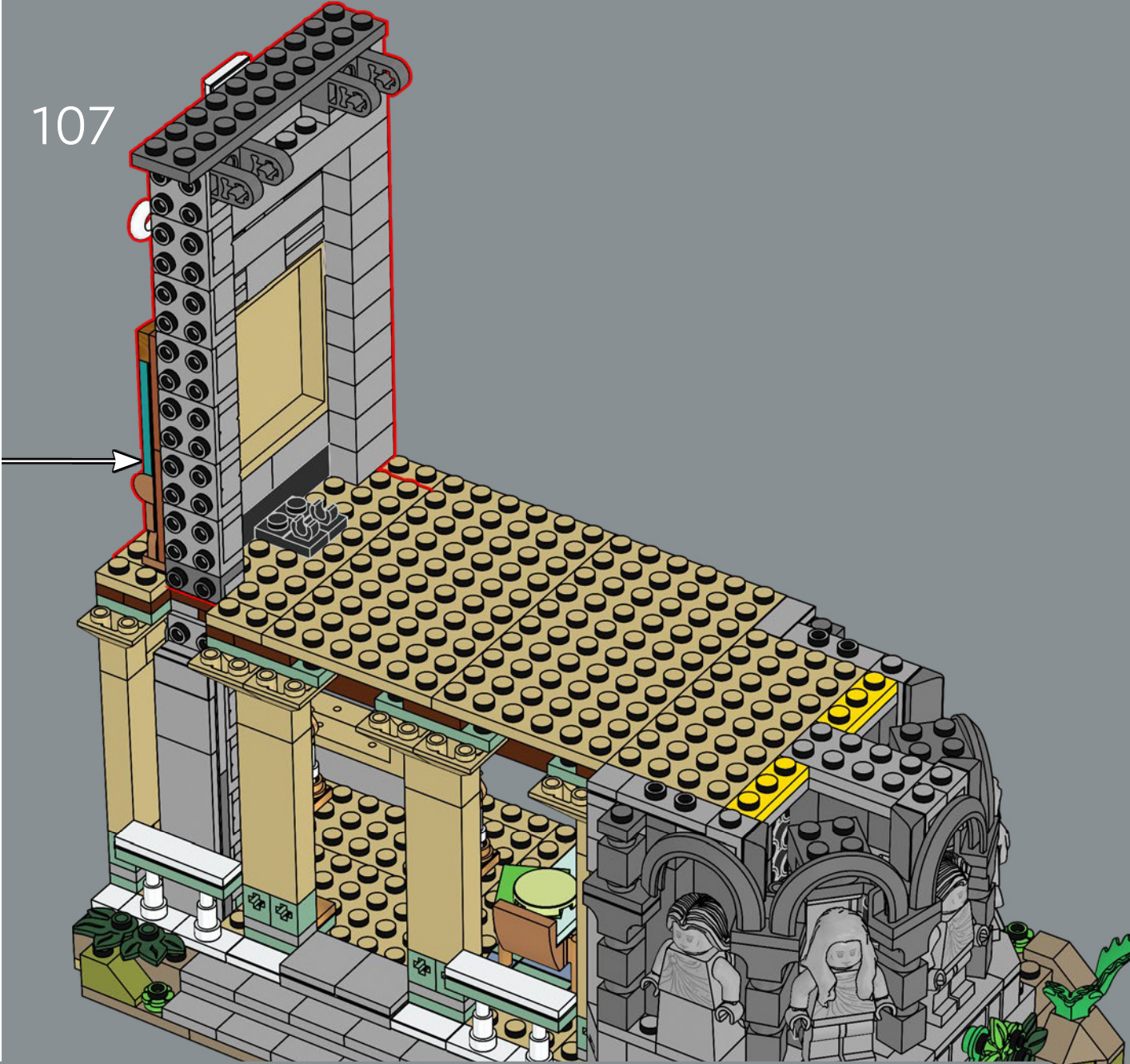

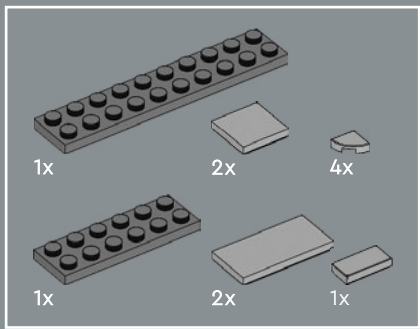

108

1

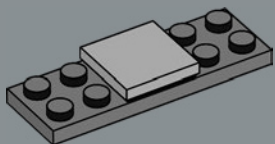

2

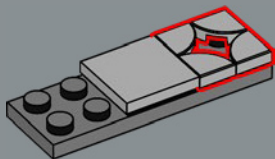

3

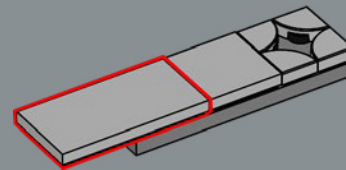

4

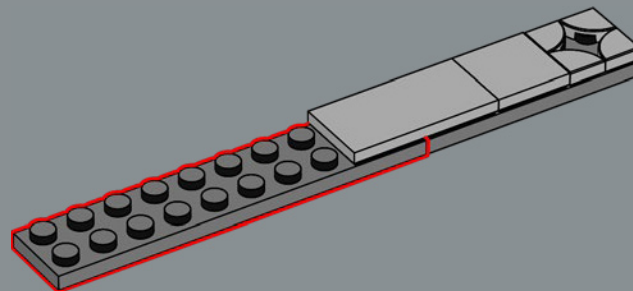

5

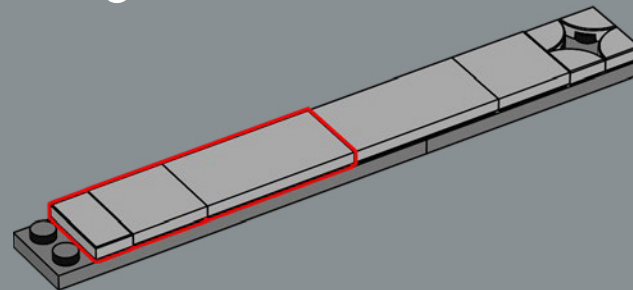

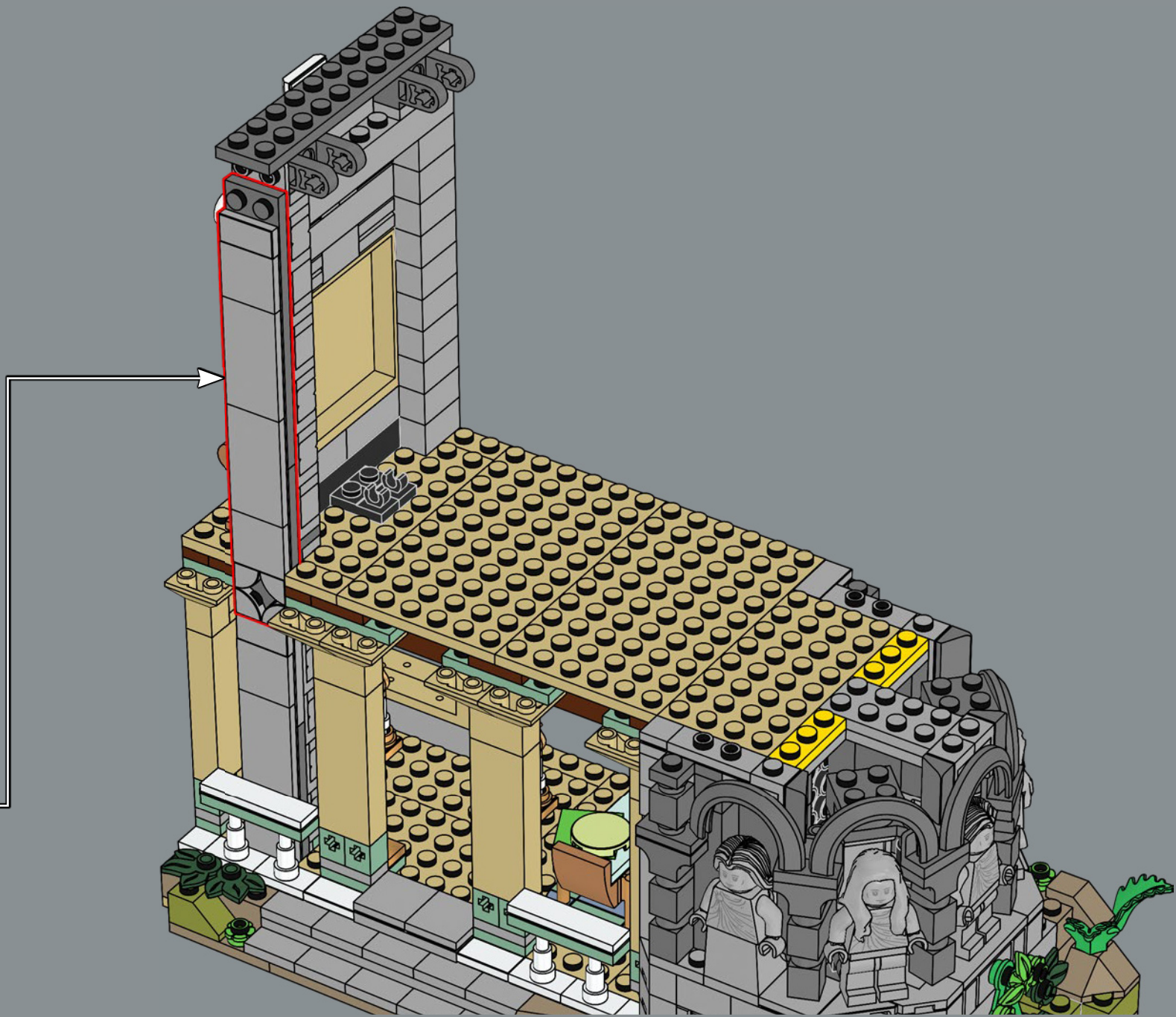

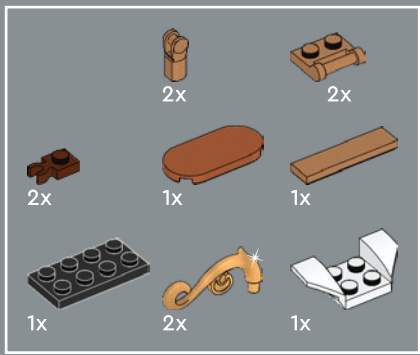

109

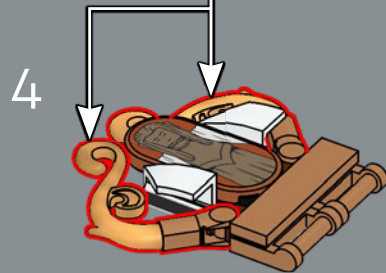
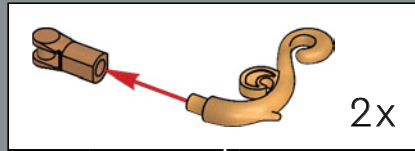
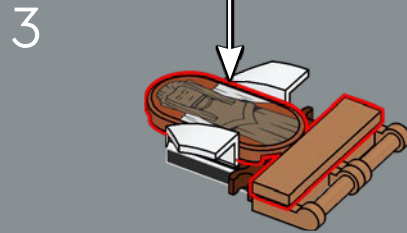
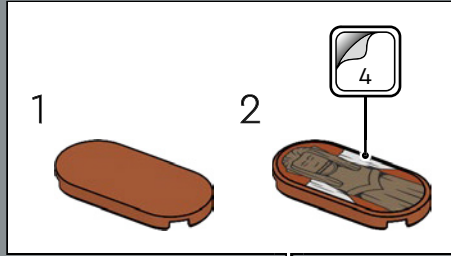
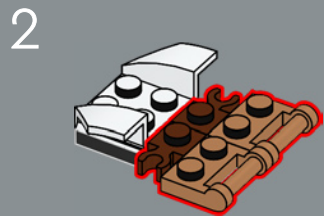
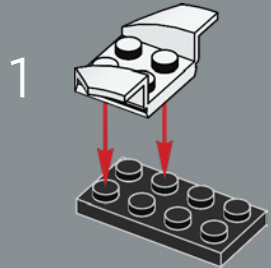

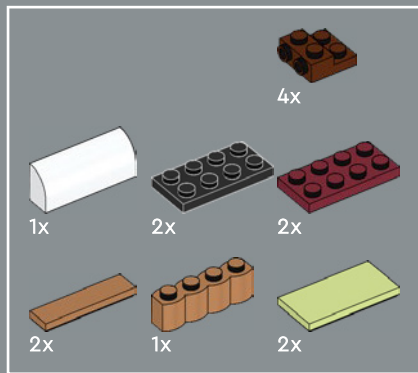

110

1



2

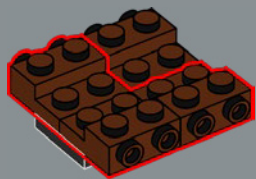

3

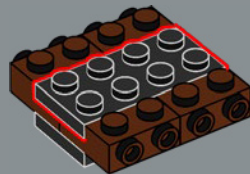

4



5



6

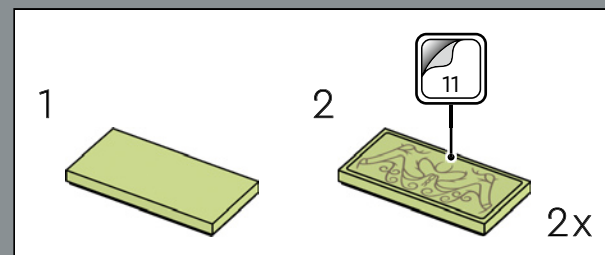
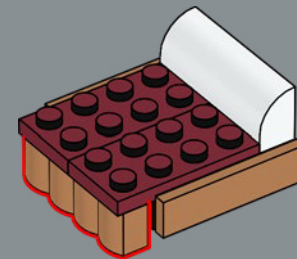

7

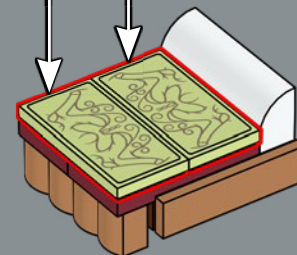

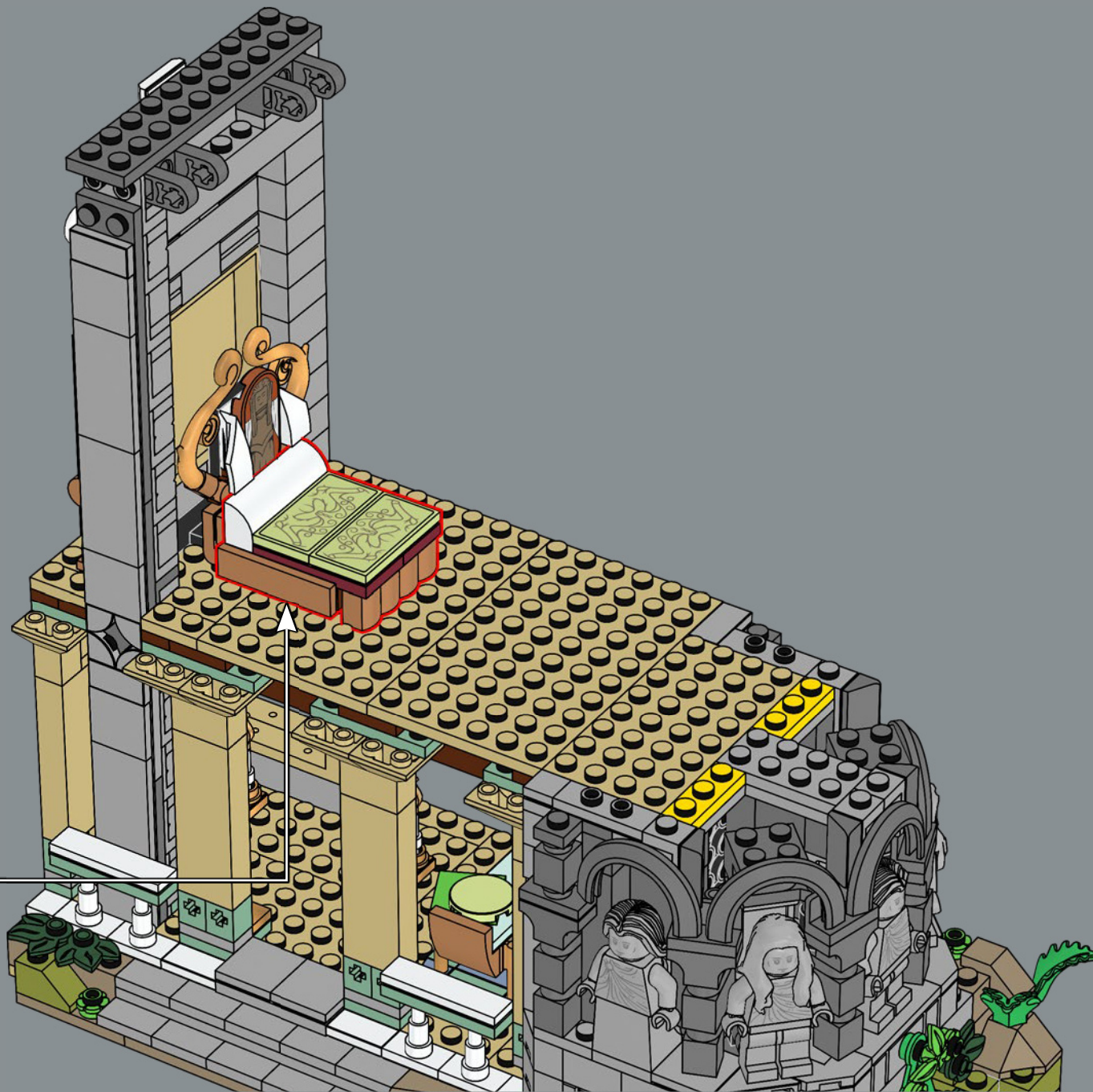



111

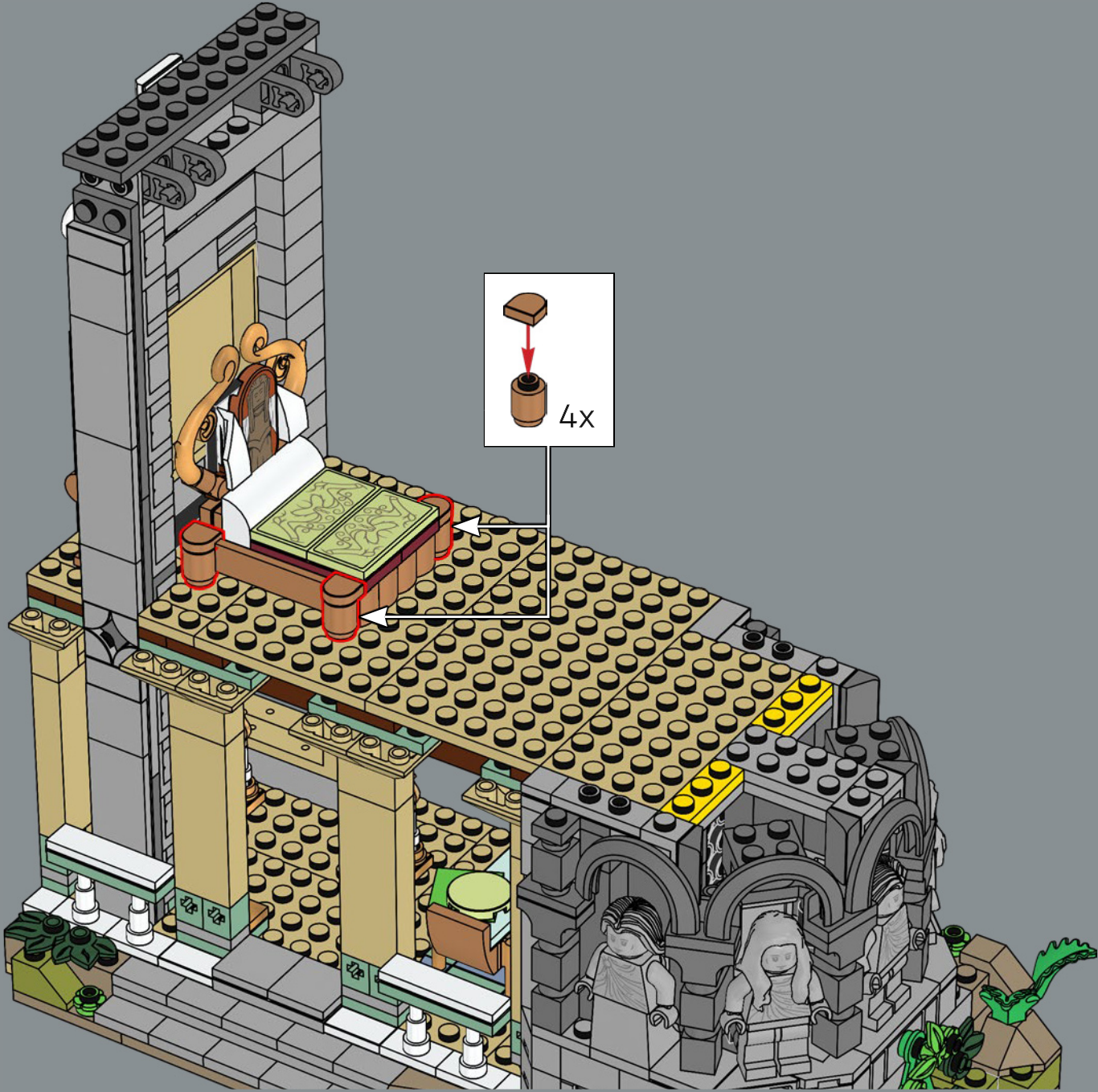

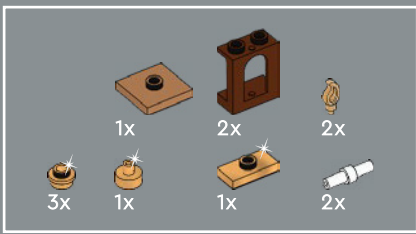

112

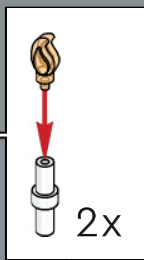
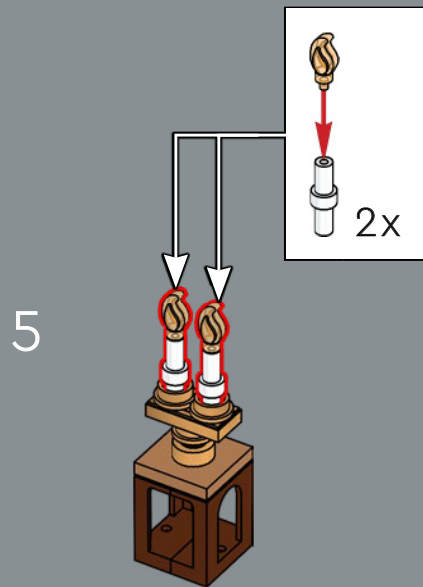
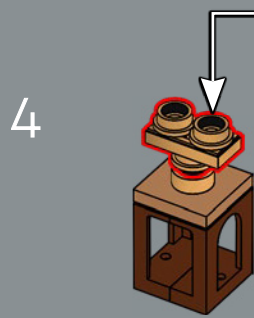
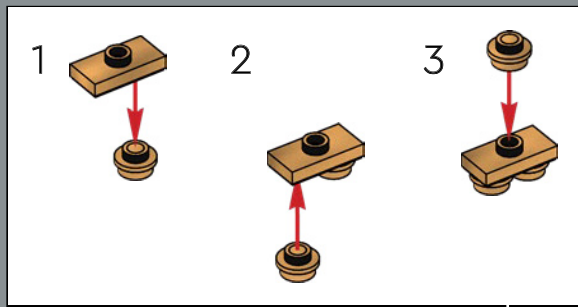
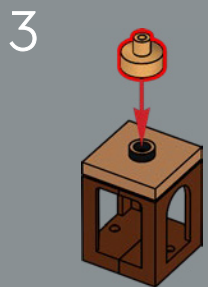
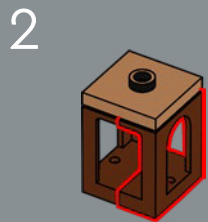
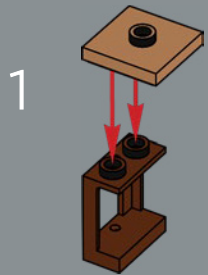

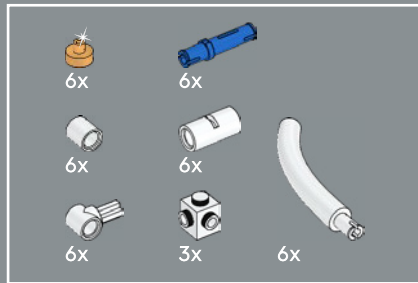
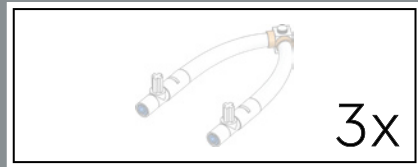

1



2



3

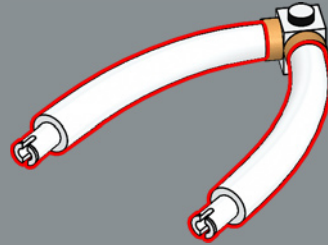

4

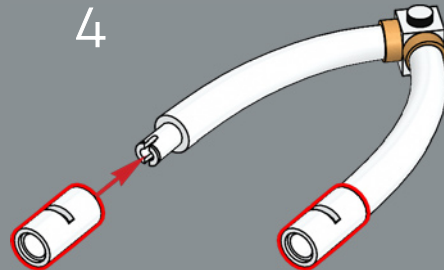

5

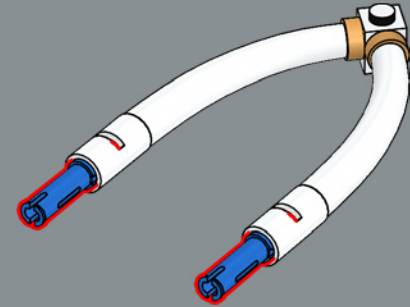

6

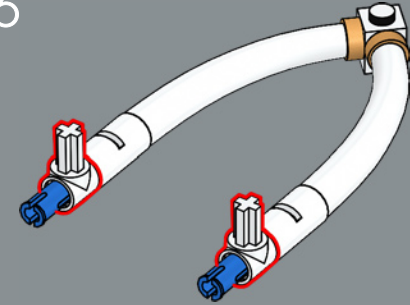

7

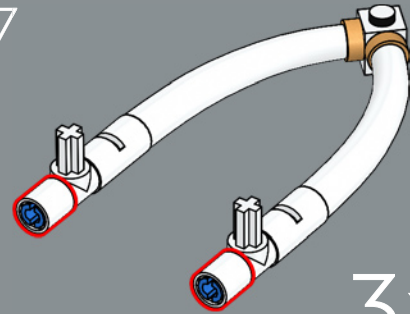

3x

113





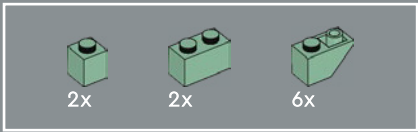

114



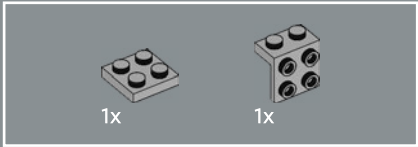
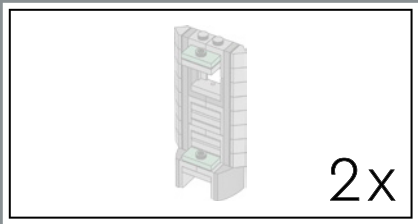

115

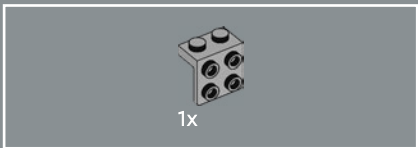
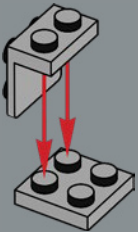

116

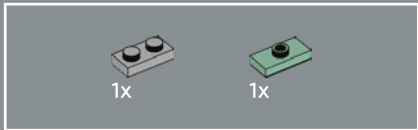
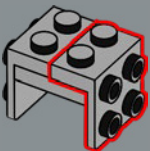

117

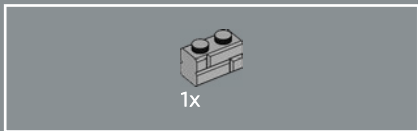
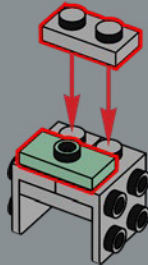

118

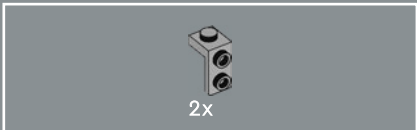
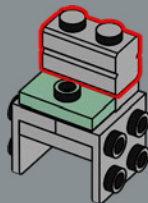

119

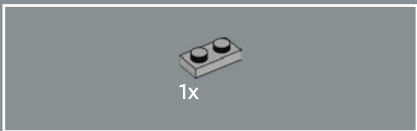
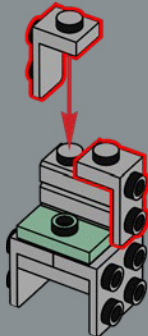

120

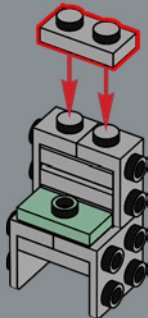

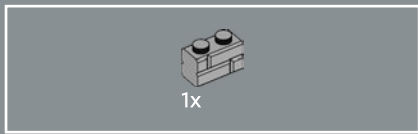

121

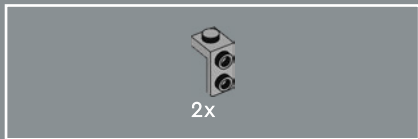
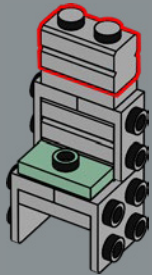

122

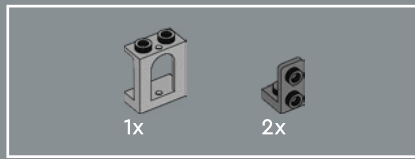
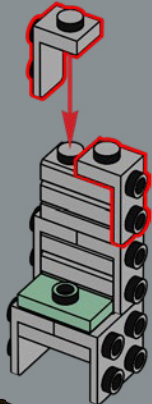

123

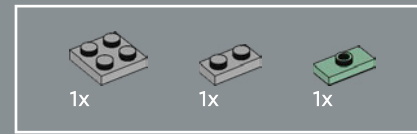
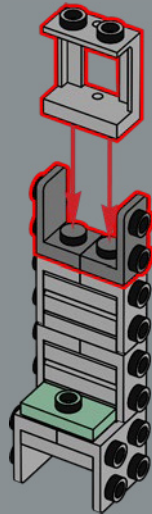

124

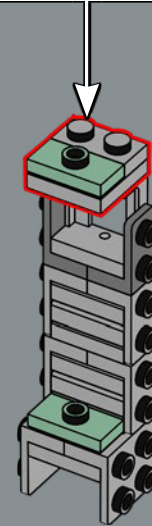
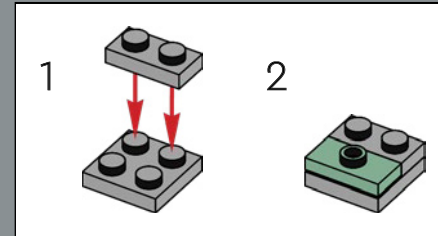



2x

125

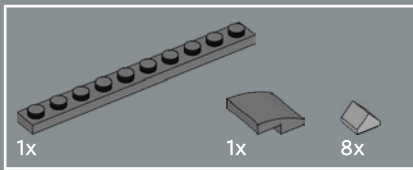
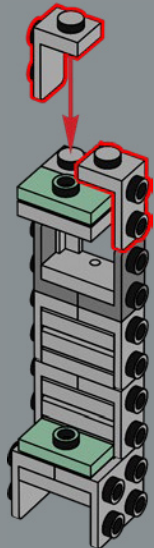

126

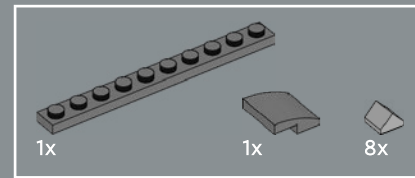
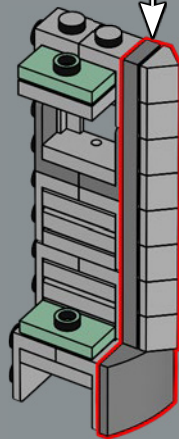
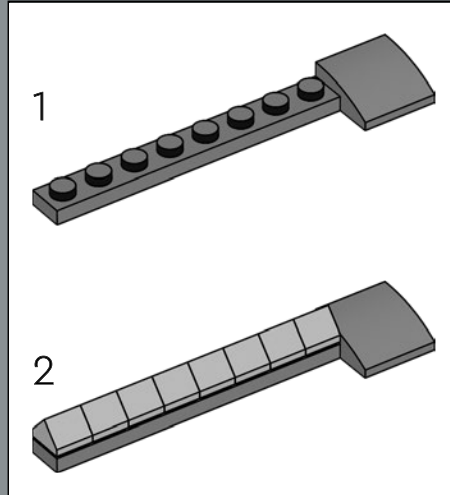

127

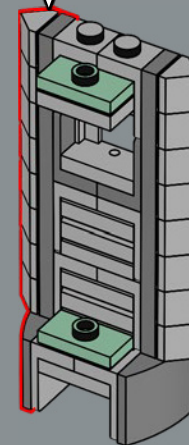
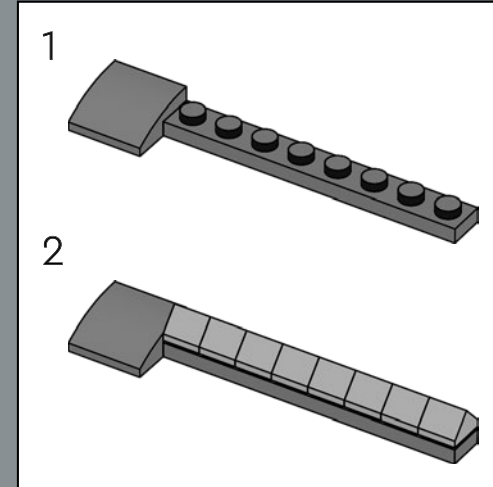

2x

128



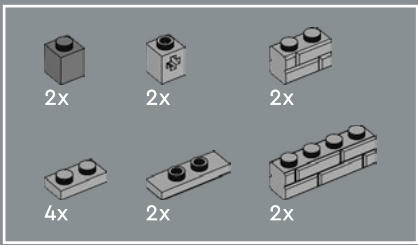

129

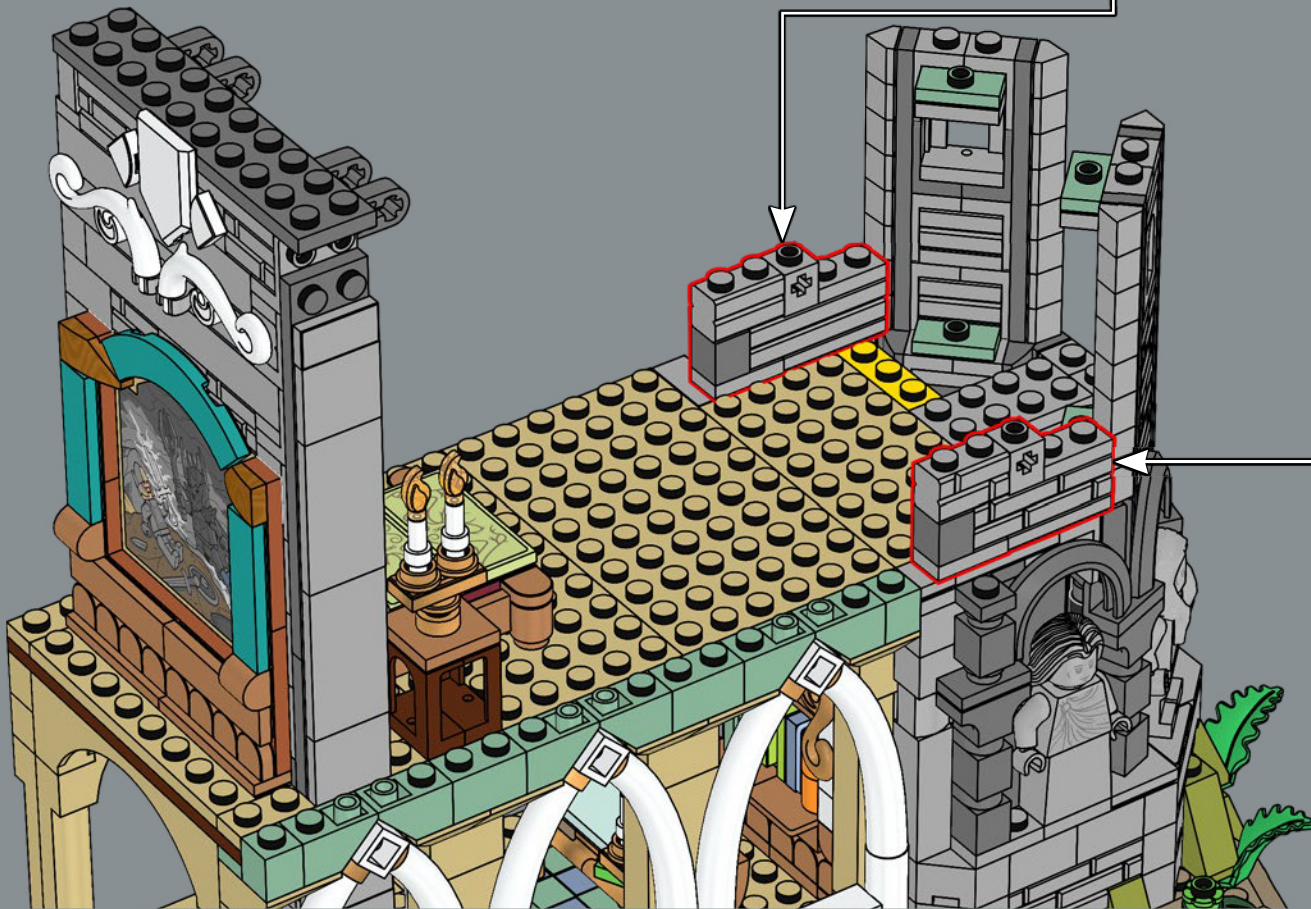
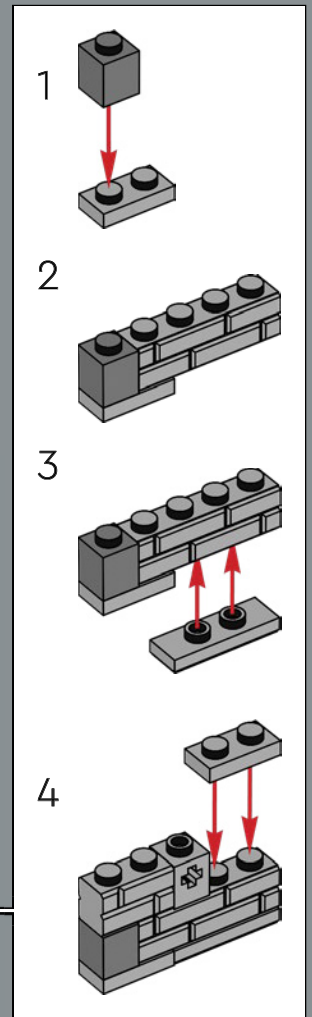
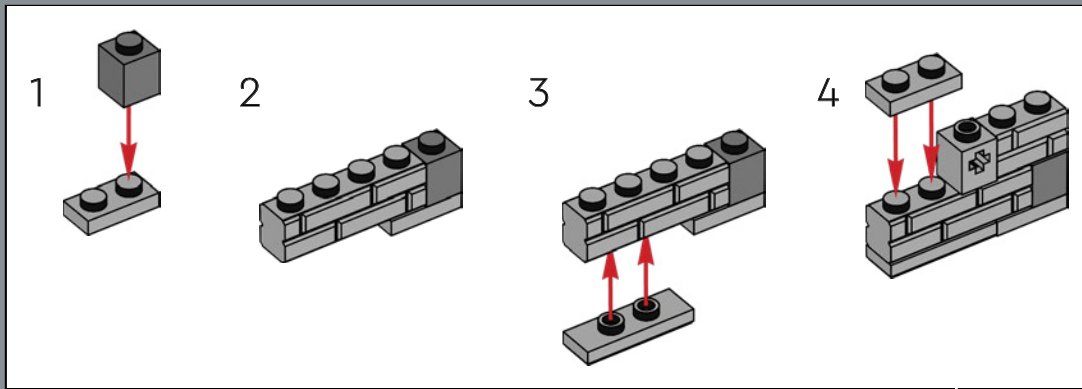

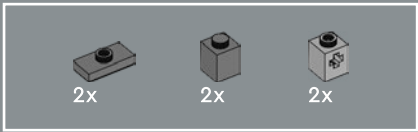

130

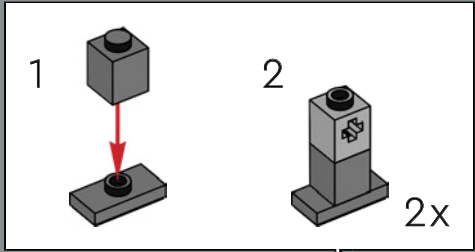

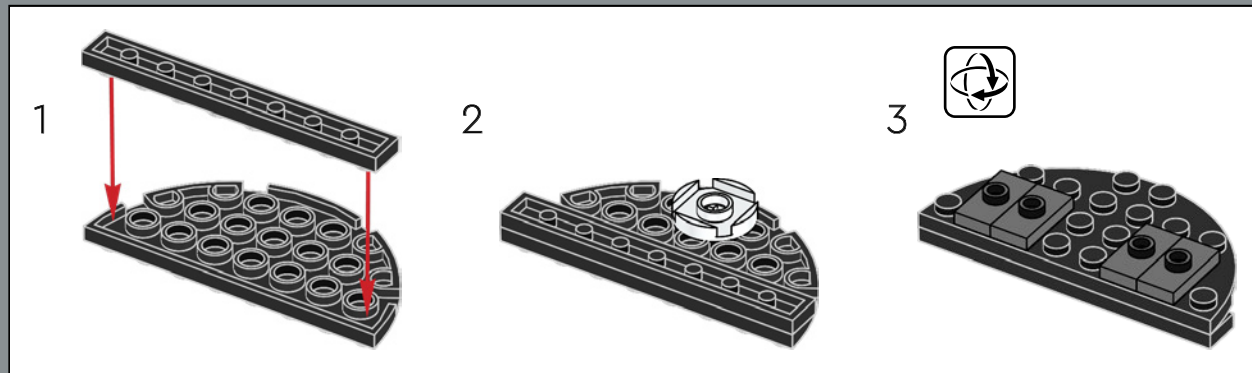
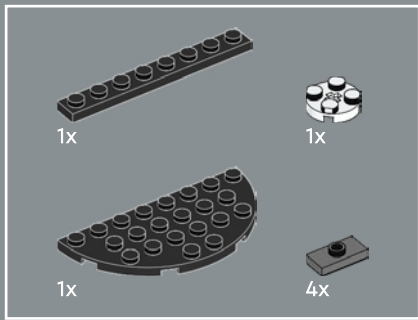

131

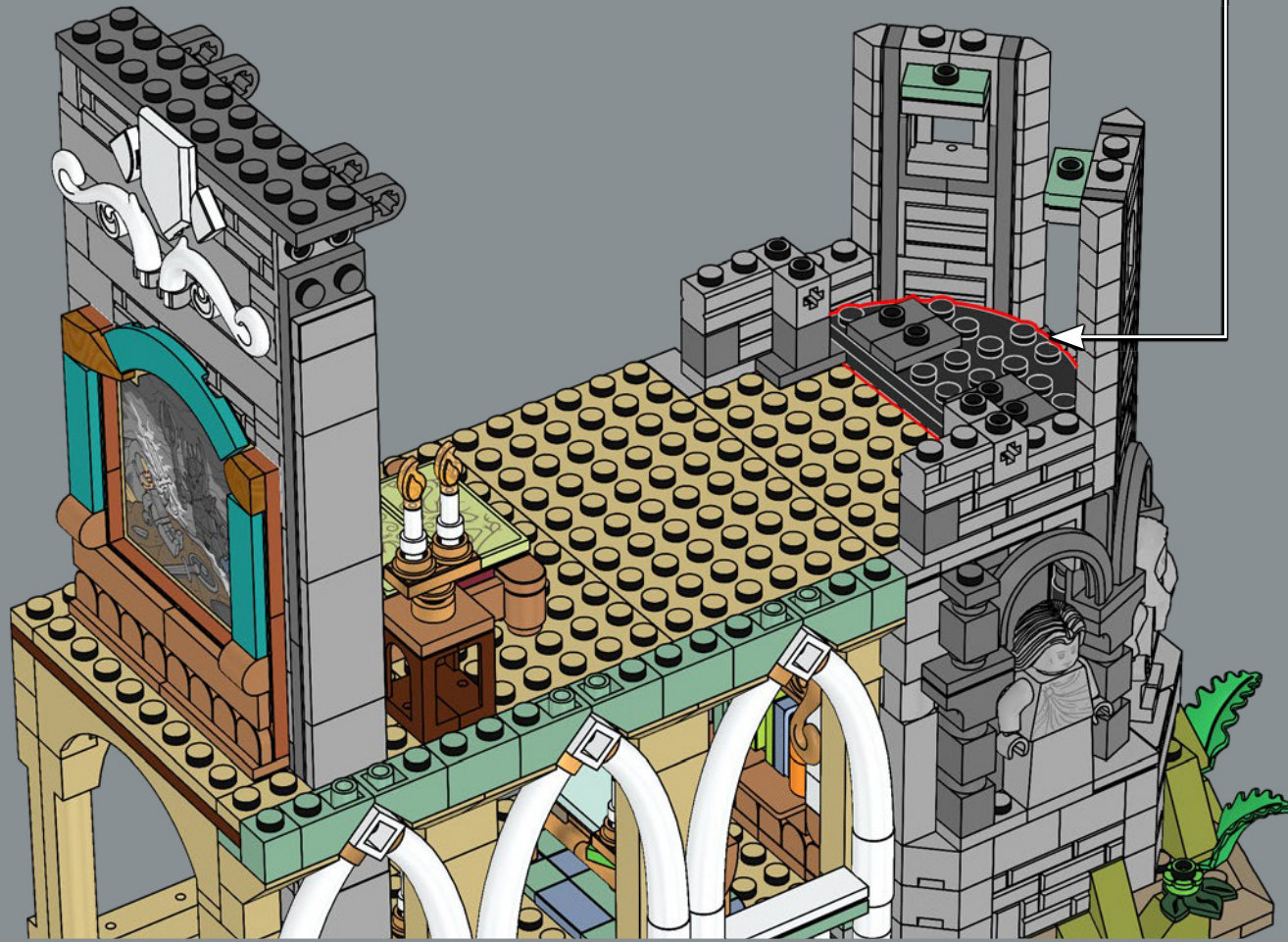

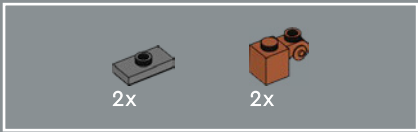

132

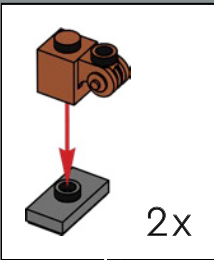

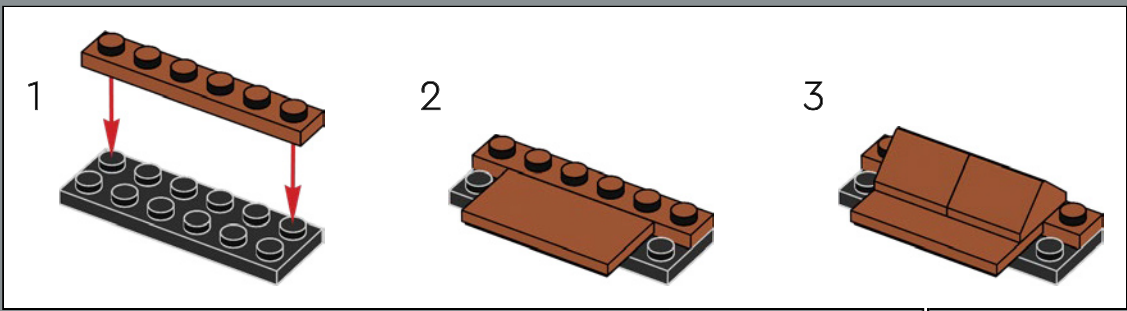
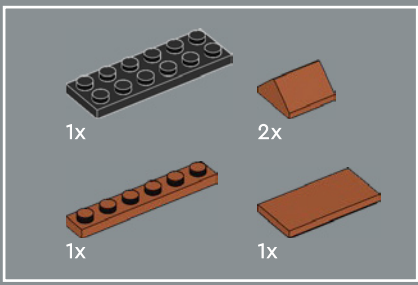

133



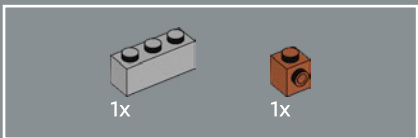

134

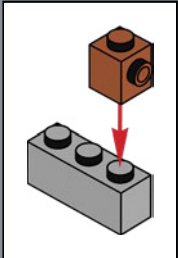



Non solo questo è un ottimo posto per scrivere un libro, ma questa scrivania fornisce anche una stabilità strutturale fondamentale per il tetto e la torre che verranno fissati in seguito.

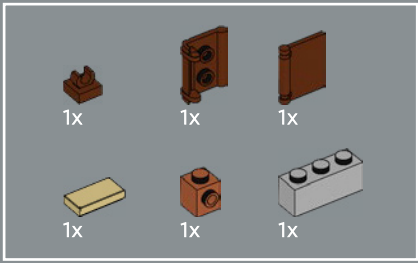

135

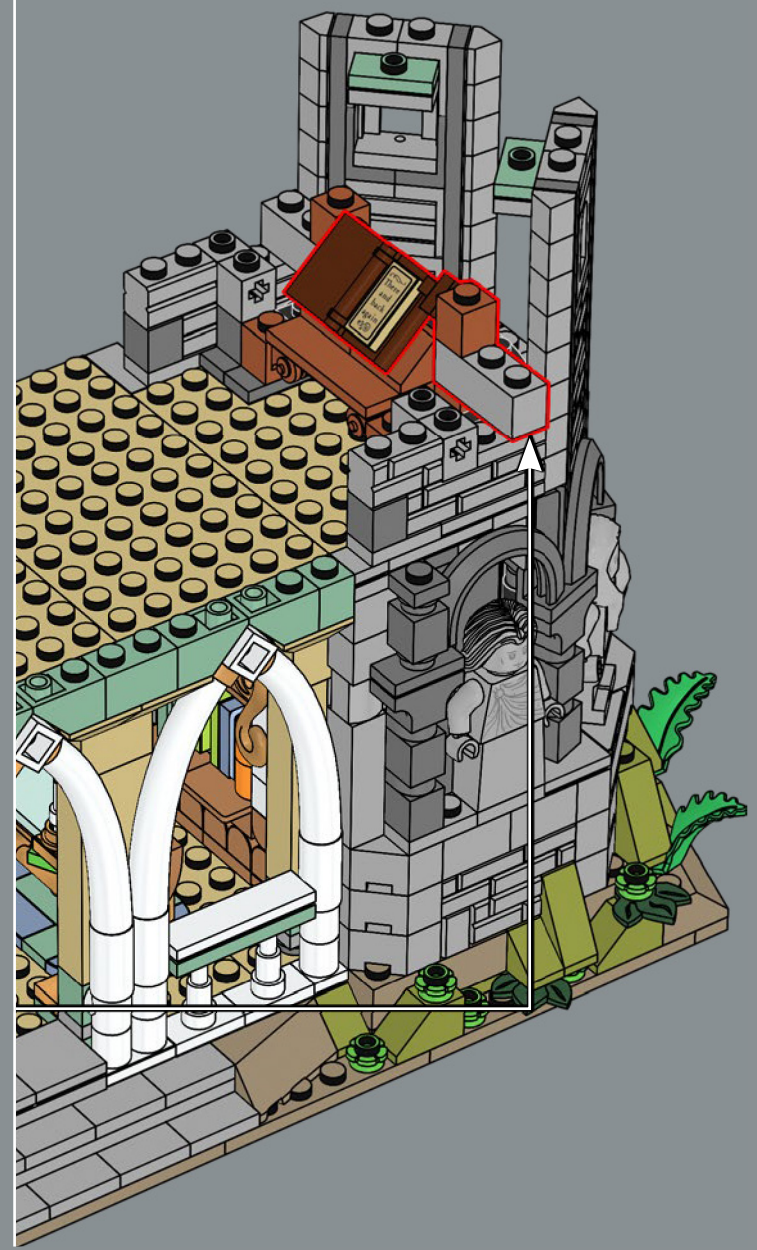
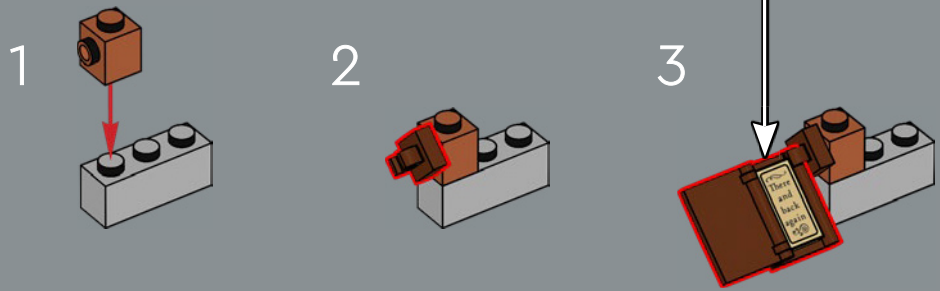
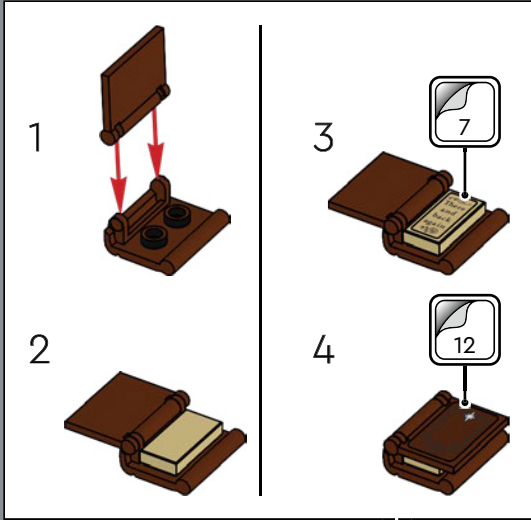

-  2x
-  1x
-  2x
-  1x
-  2x
-  2x
-  1x

136

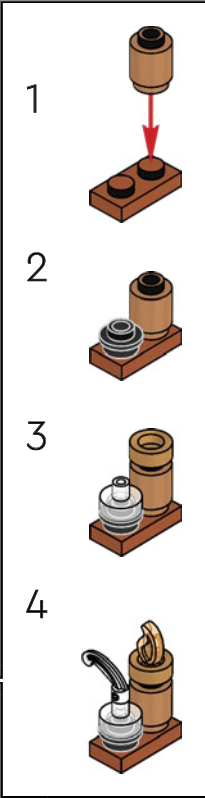
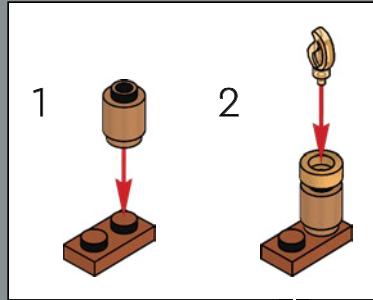

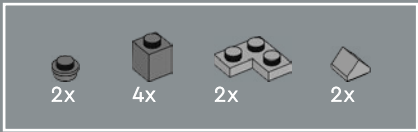

137

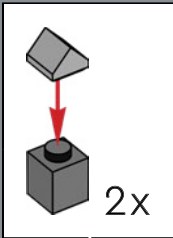



Questa è la prima volta che incontriamo Bilbo, che ha più di 111 anni, in un modello LEGO®. Non fargli vedere l'Anello o potrebbe perdere la testa!

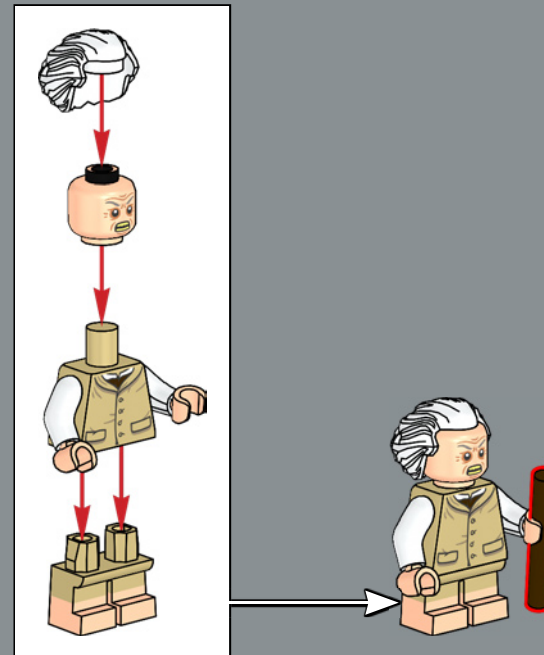

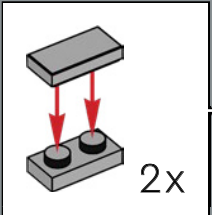
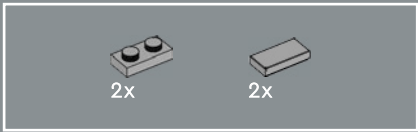

138

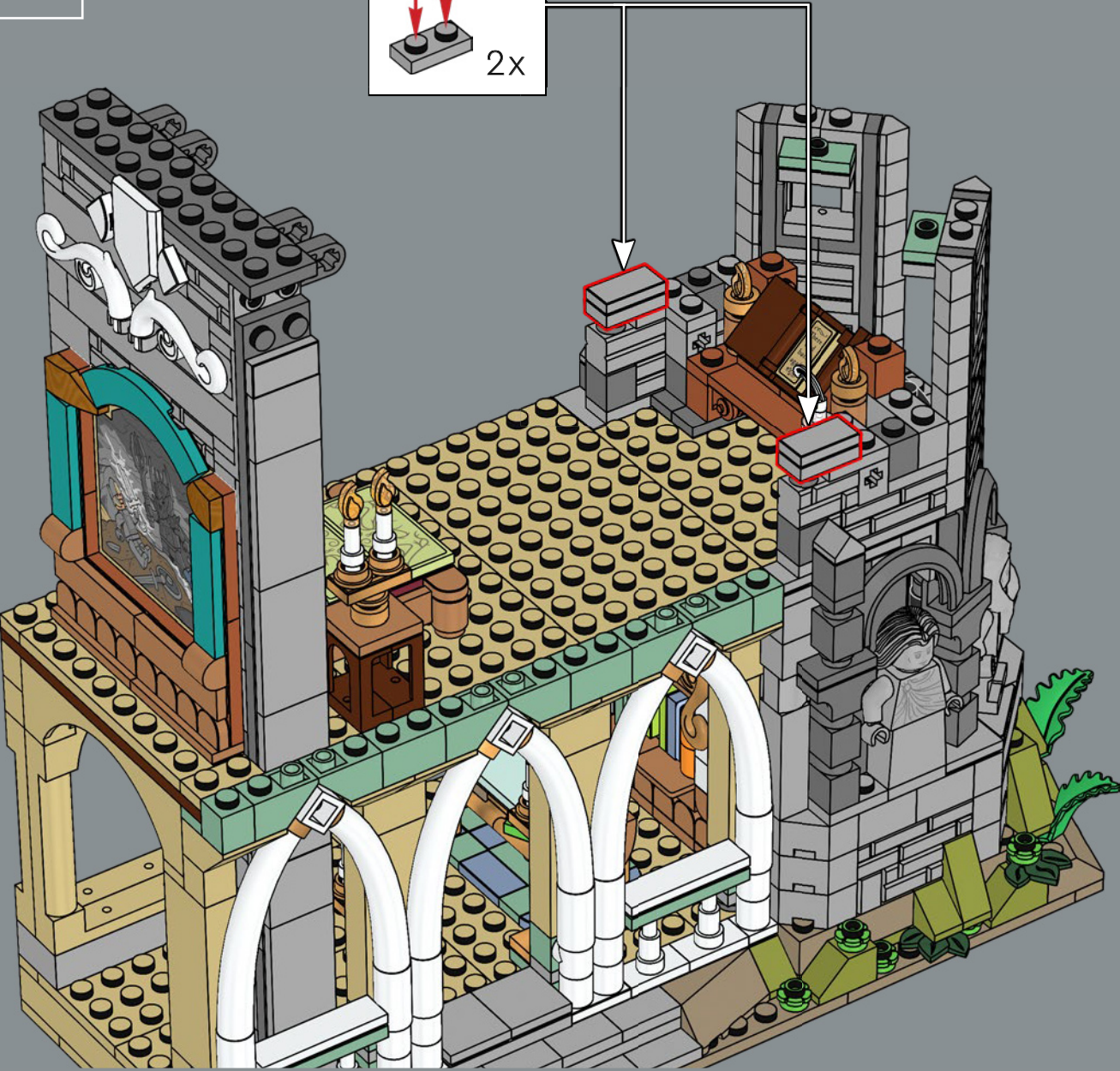

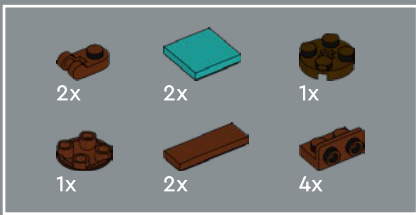

139

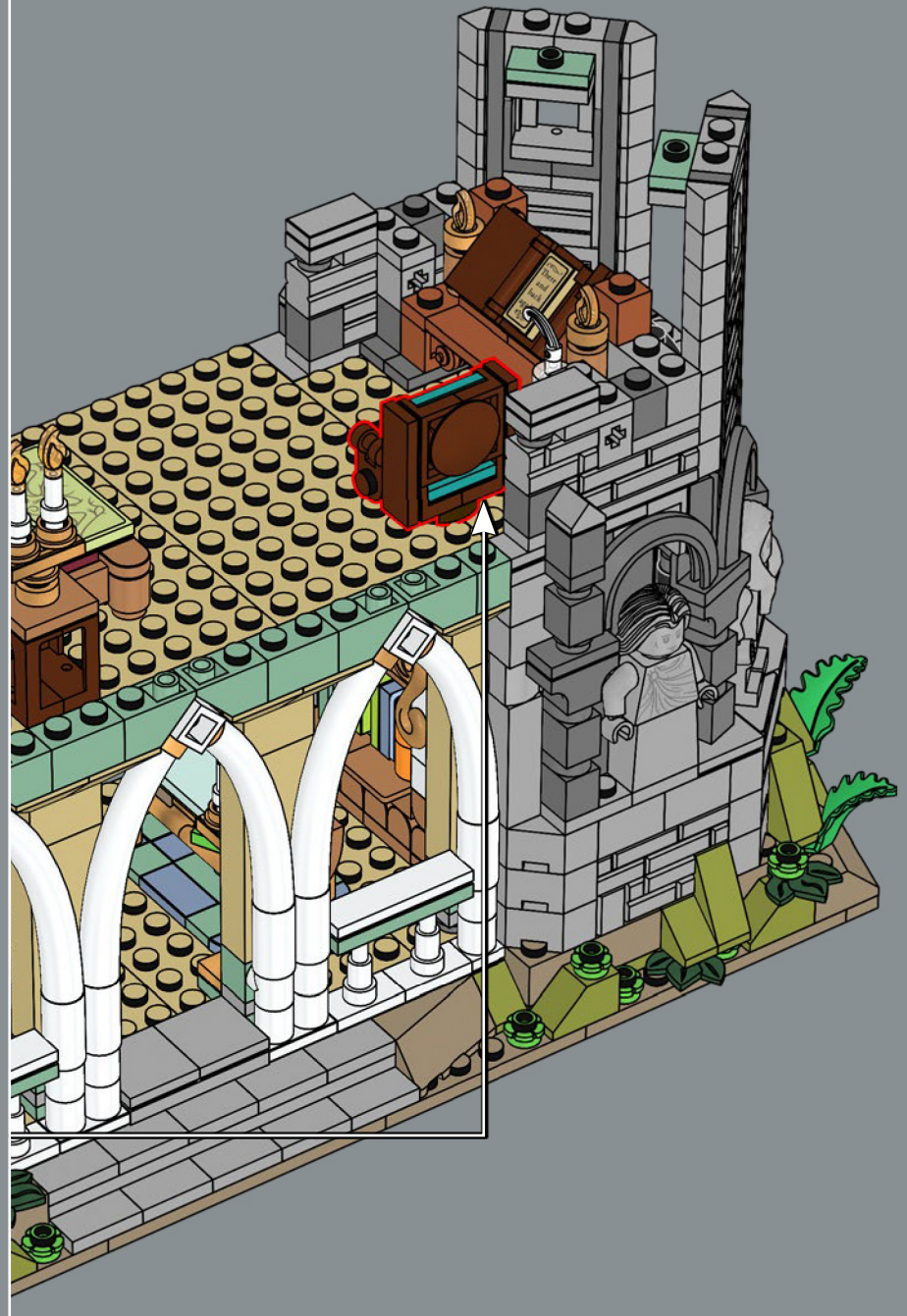
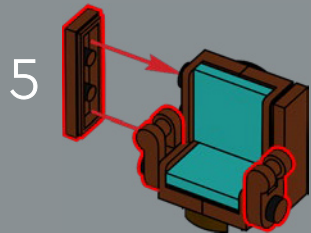
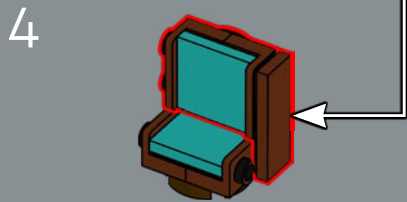
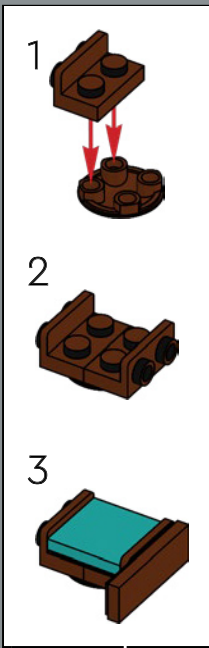
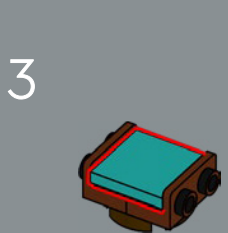
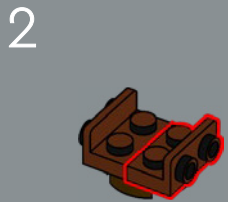
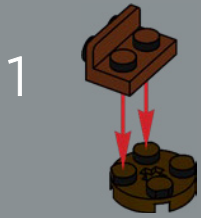

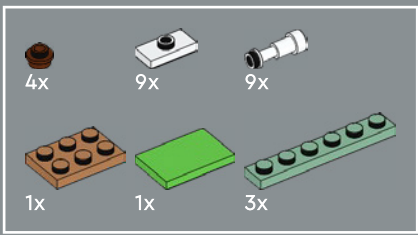

140

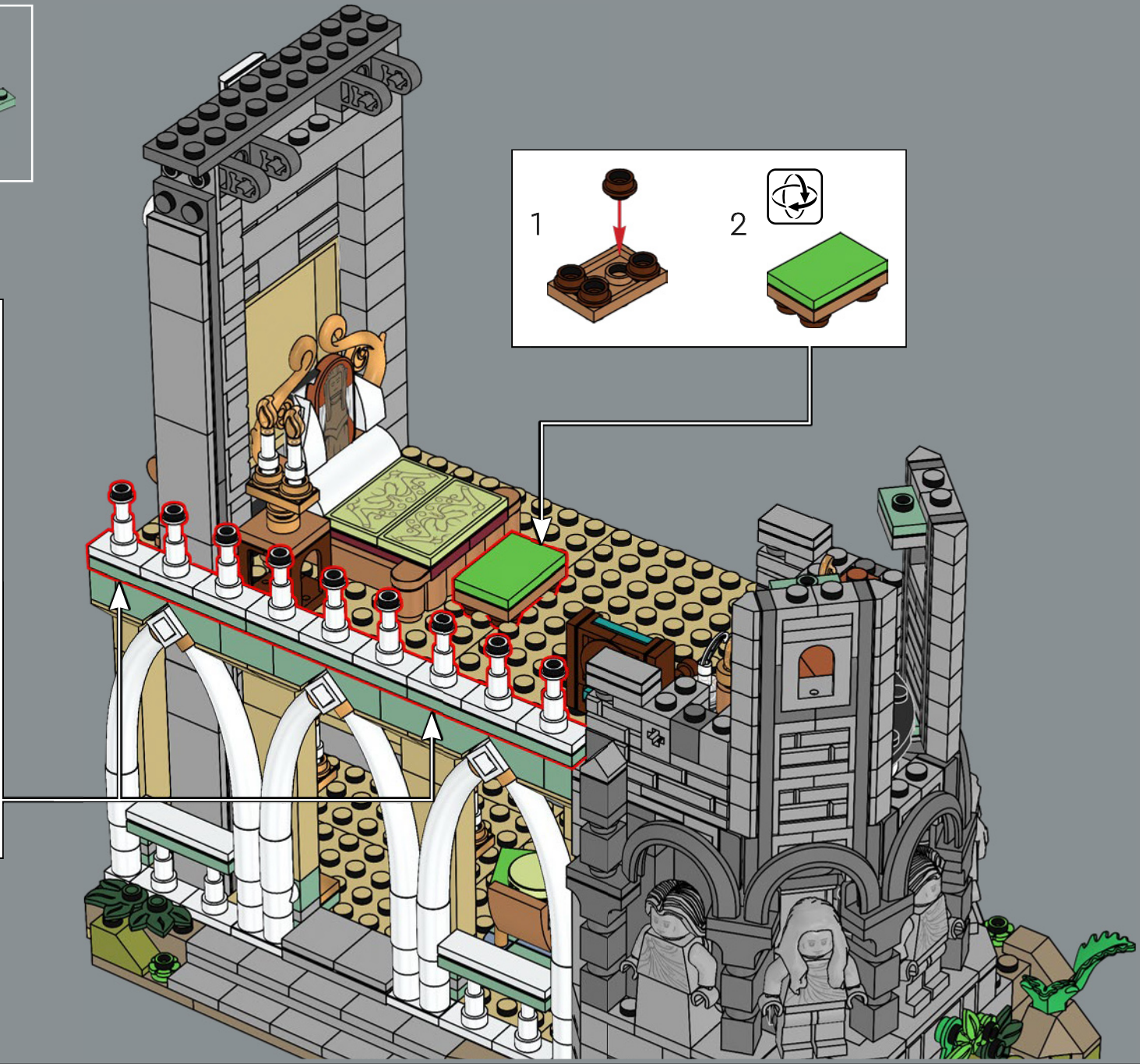
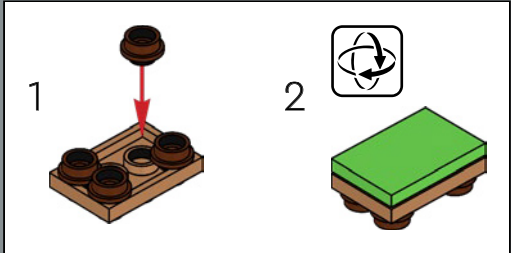
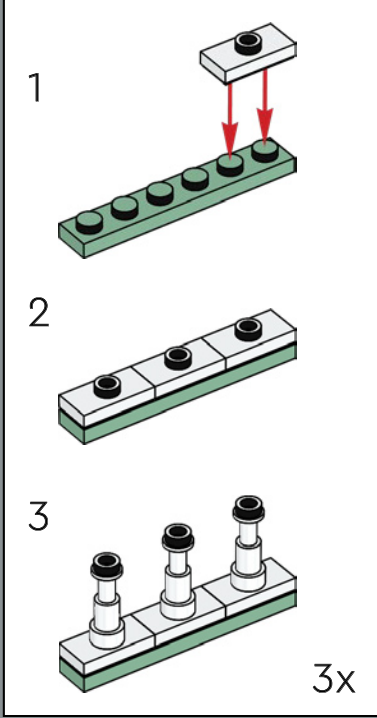

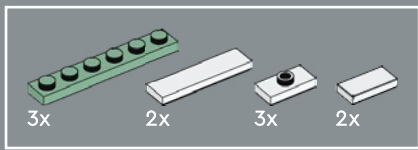

141

1

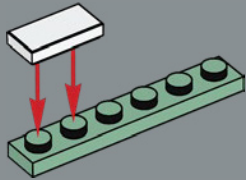

2

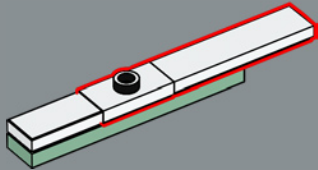

3

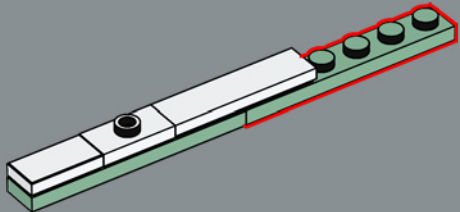

4

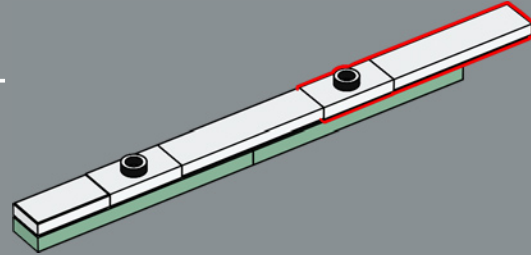

5

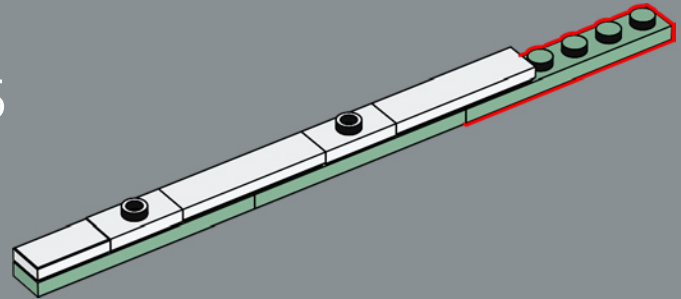

6

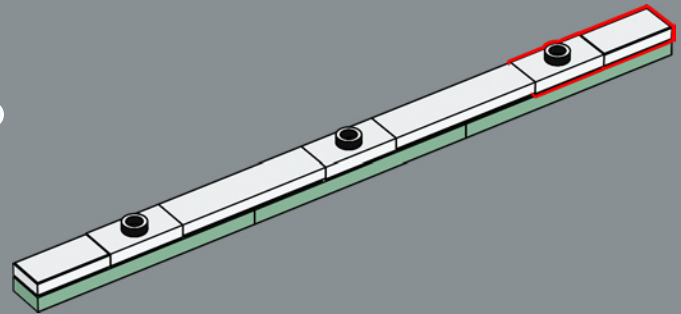



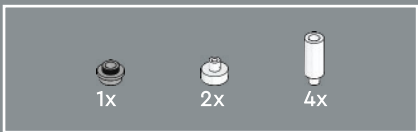

142

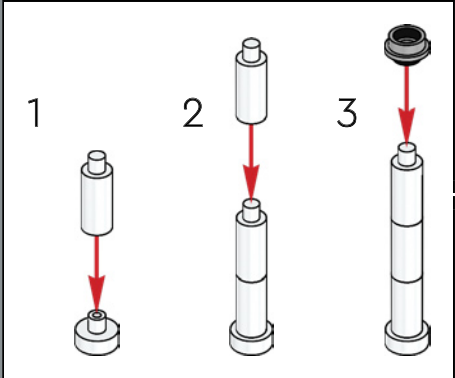

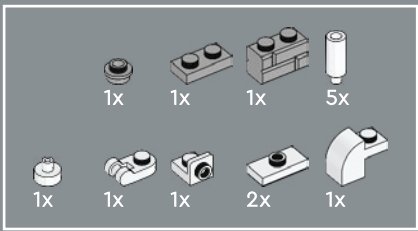

143

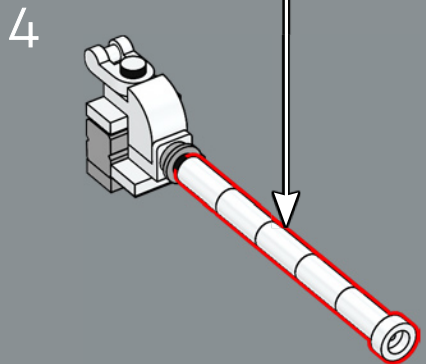
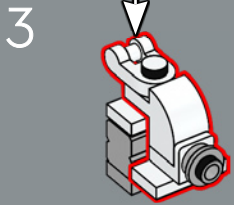
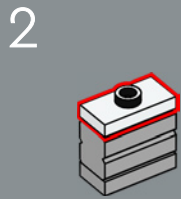
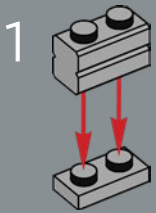
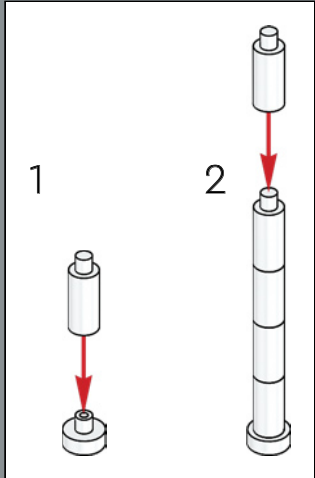
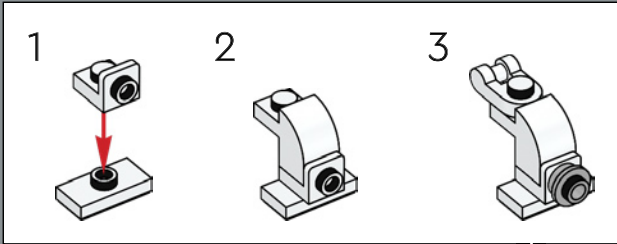

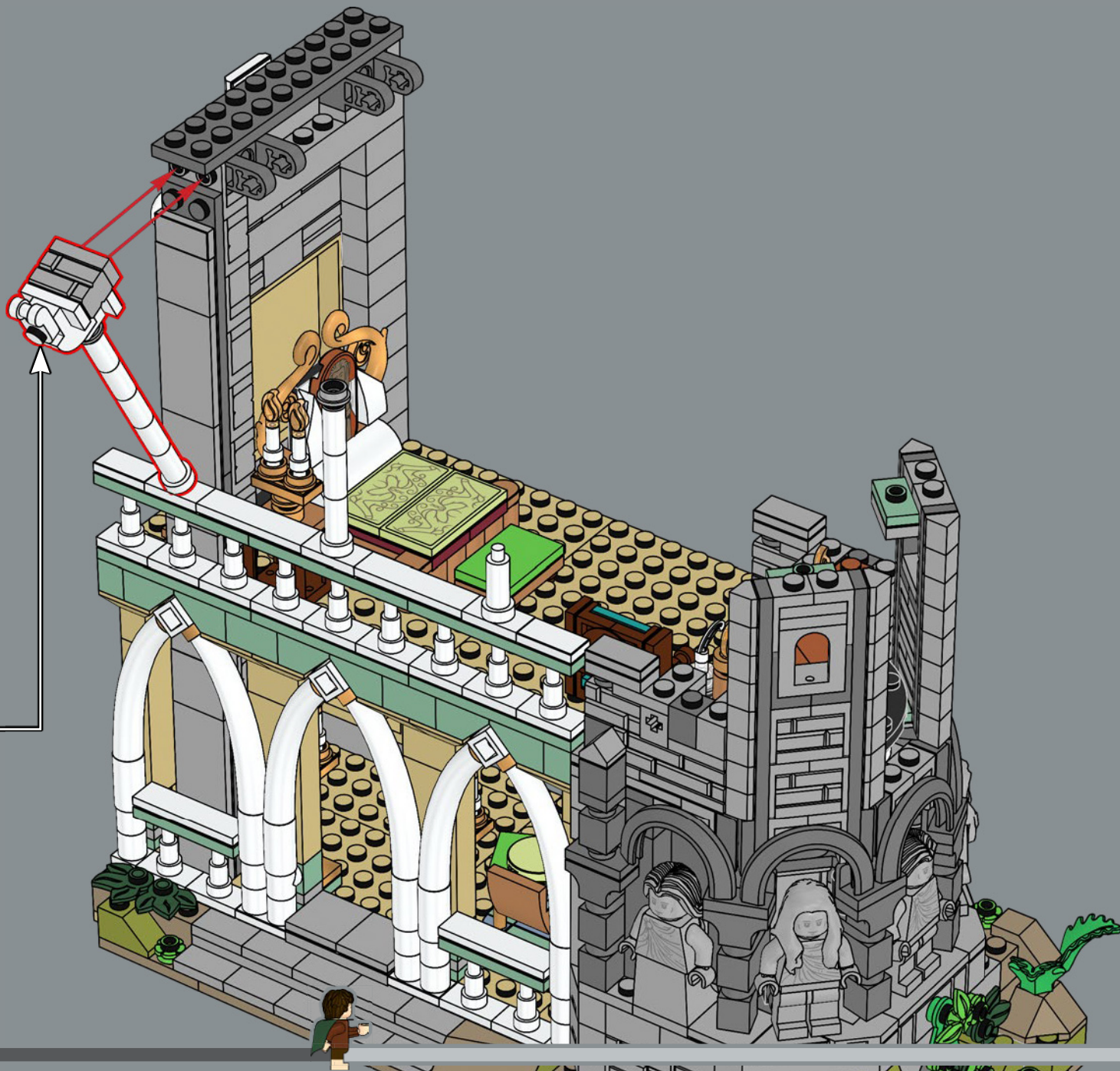

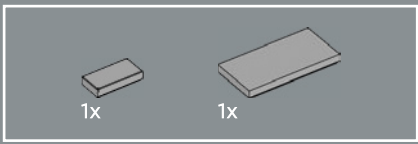

144



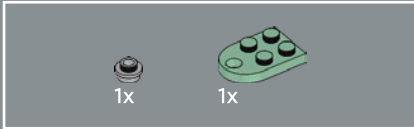
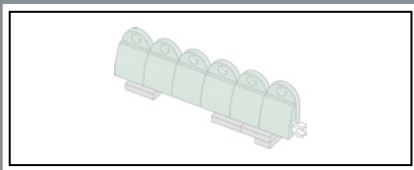

145

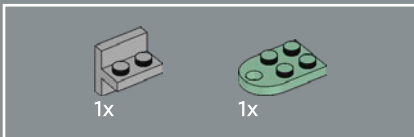
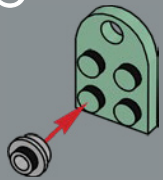

146

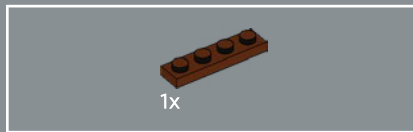
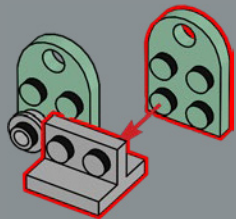

147

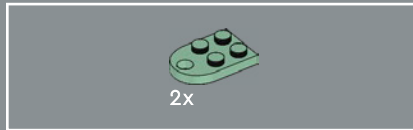
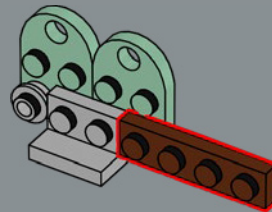

148

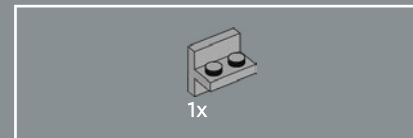
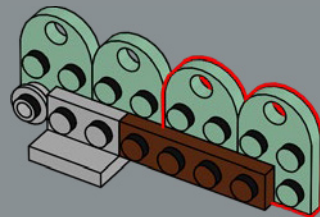

149

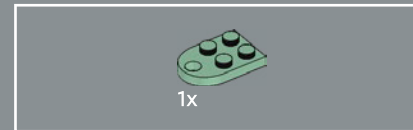
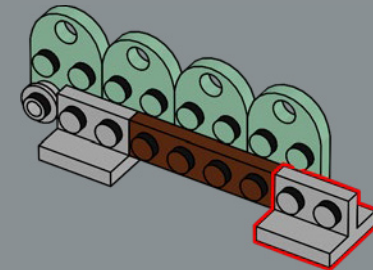

150

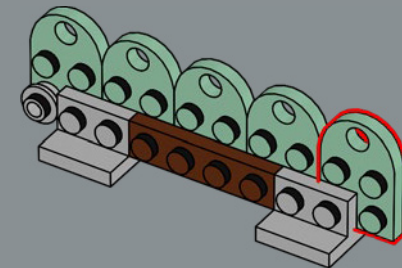



1x

151

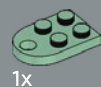
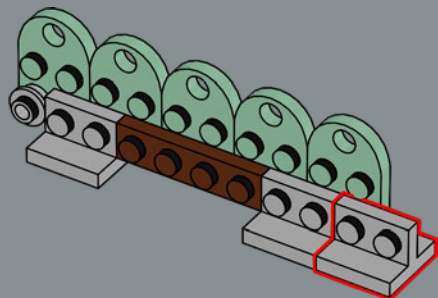

1x



1x

152

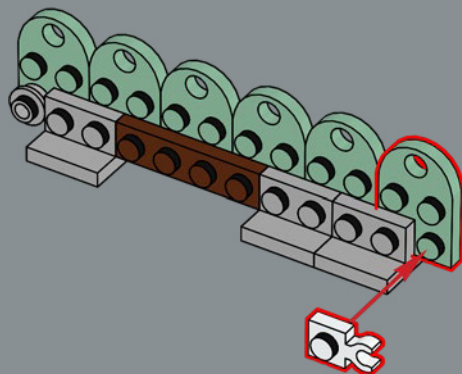

6x

153

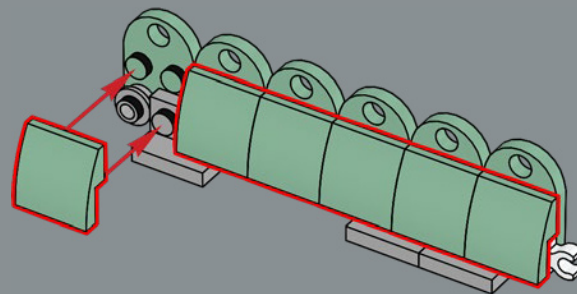

1x

154

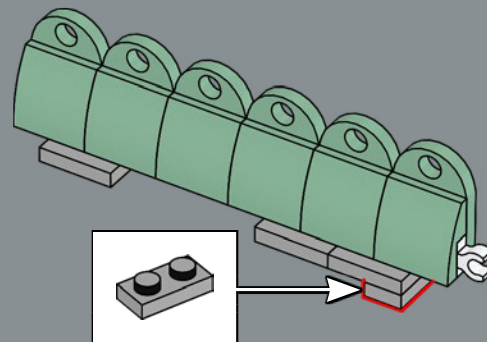

155



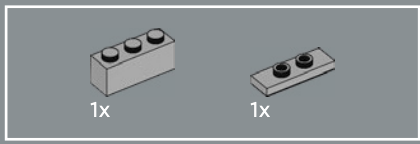

156

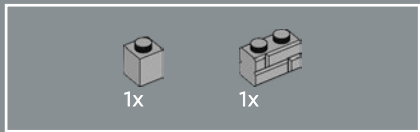
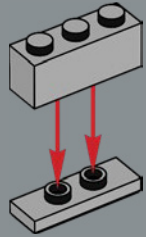

157

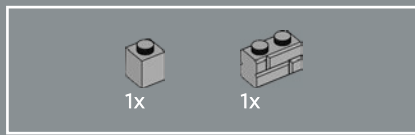
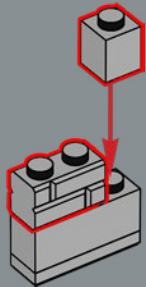

158

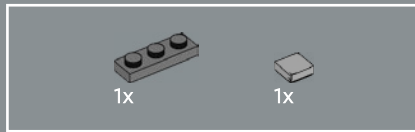
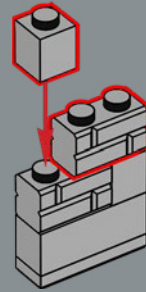

159

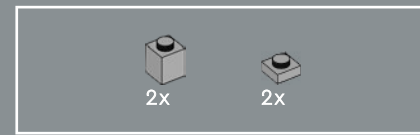
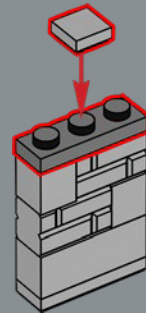

160

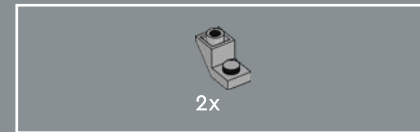
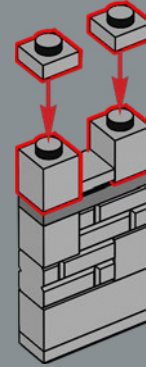

161

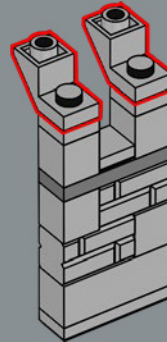

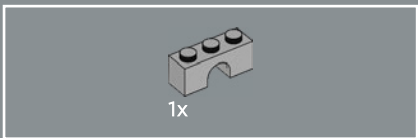

162

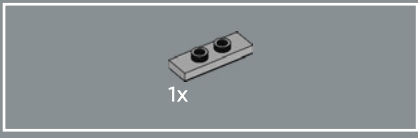
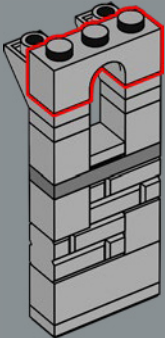

163

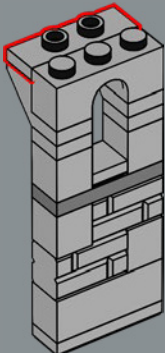

164

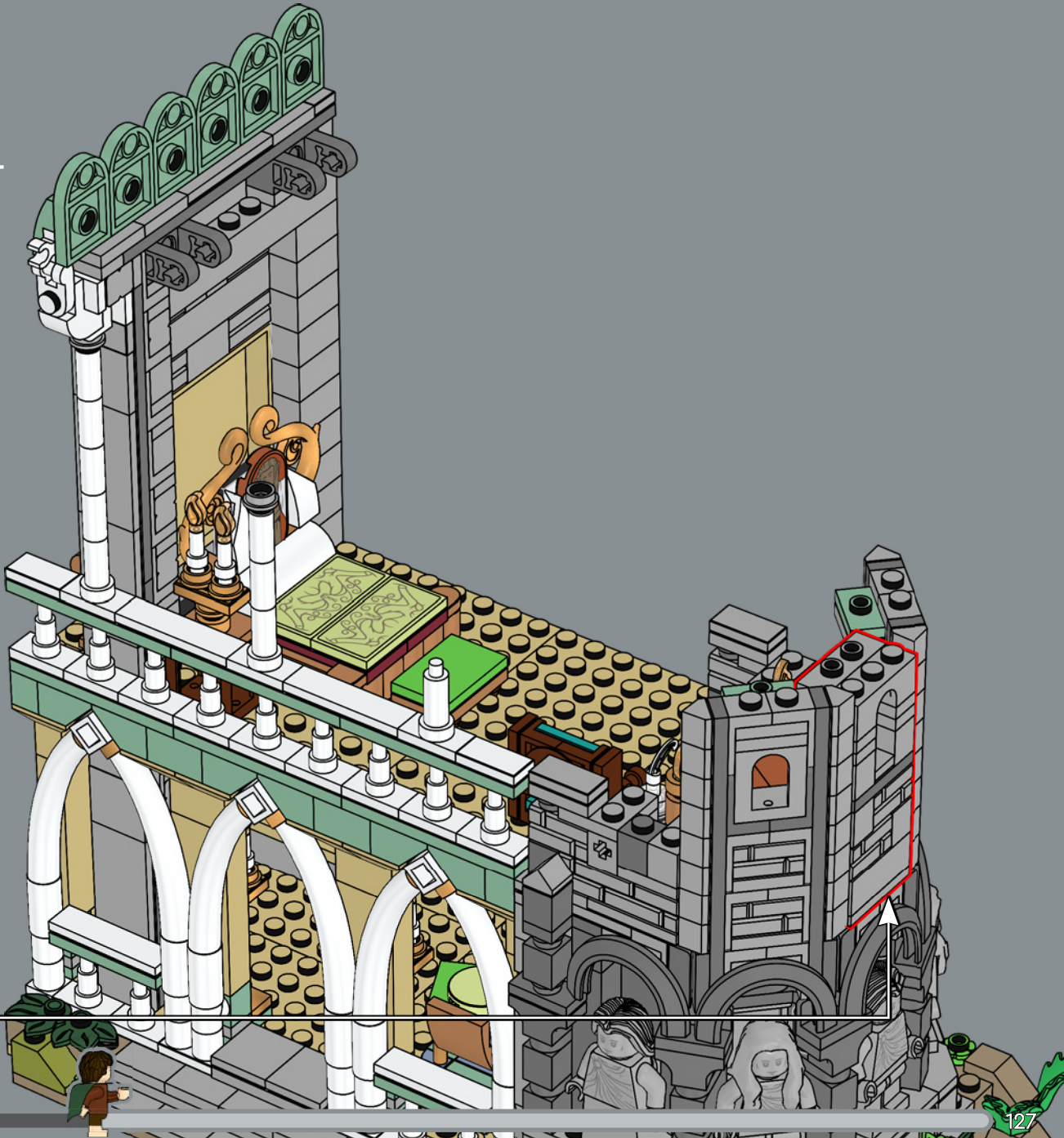

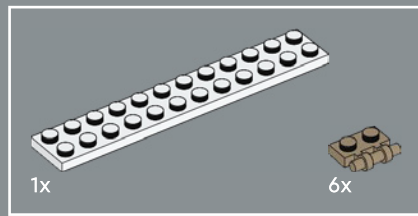

165

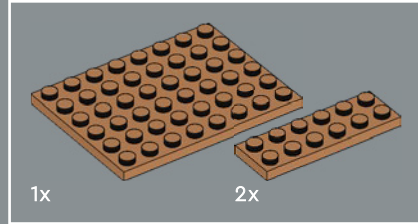
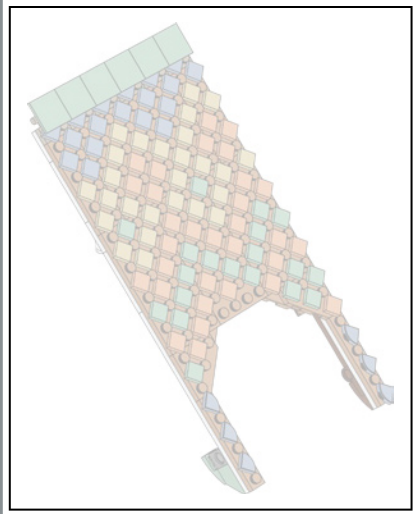
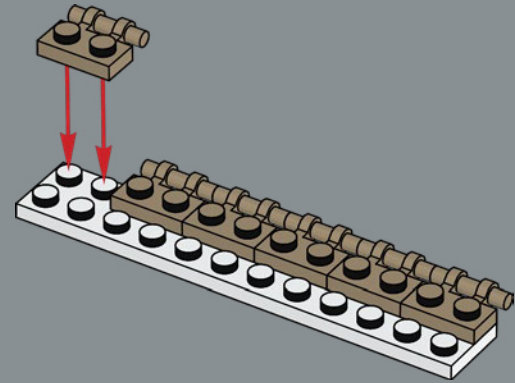

166

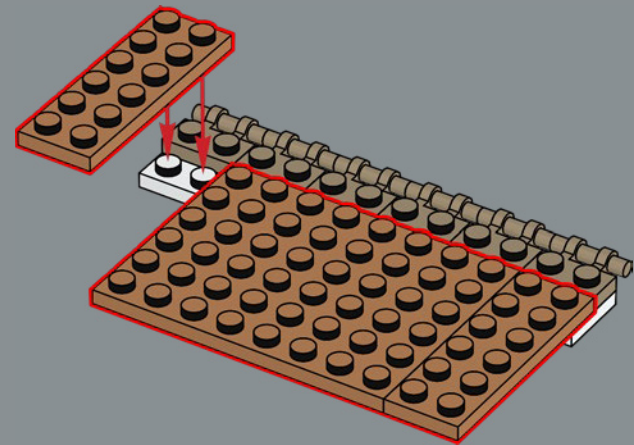

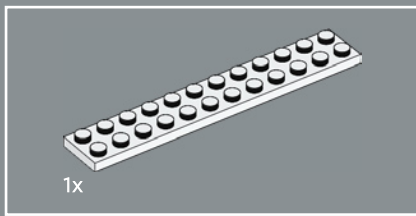

167

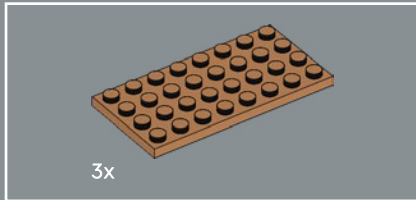
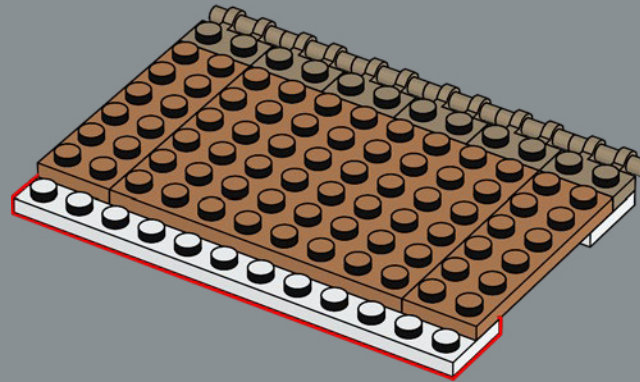

168

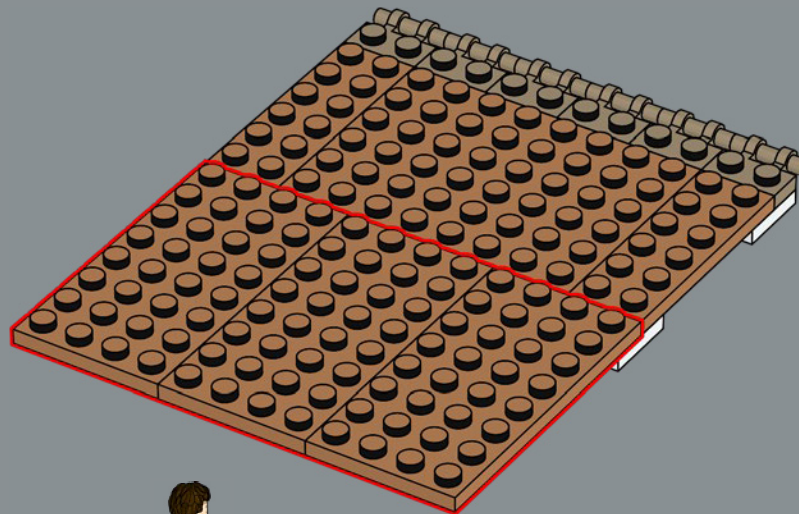

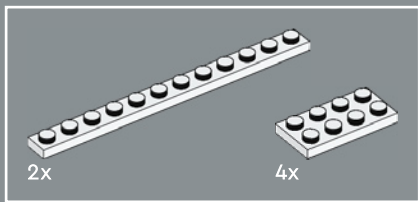

169

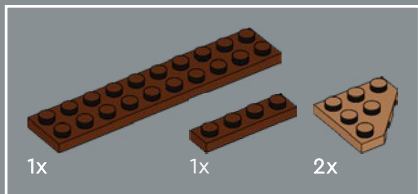
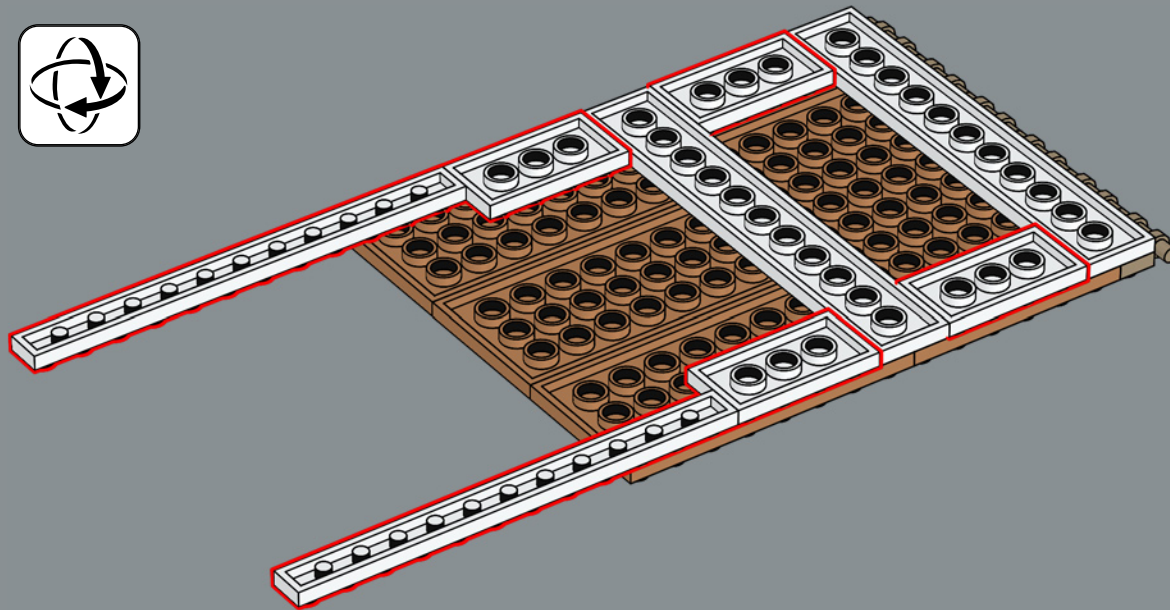

170

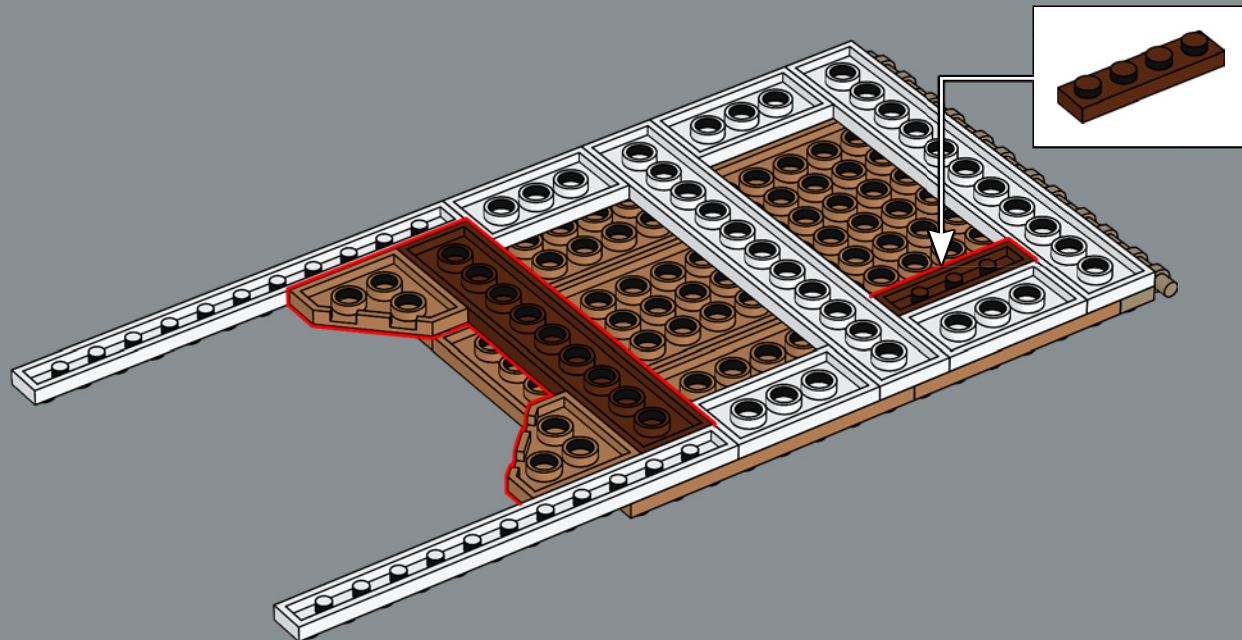

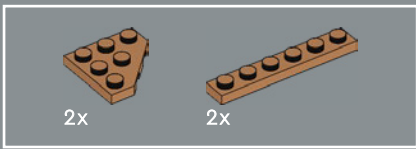

171

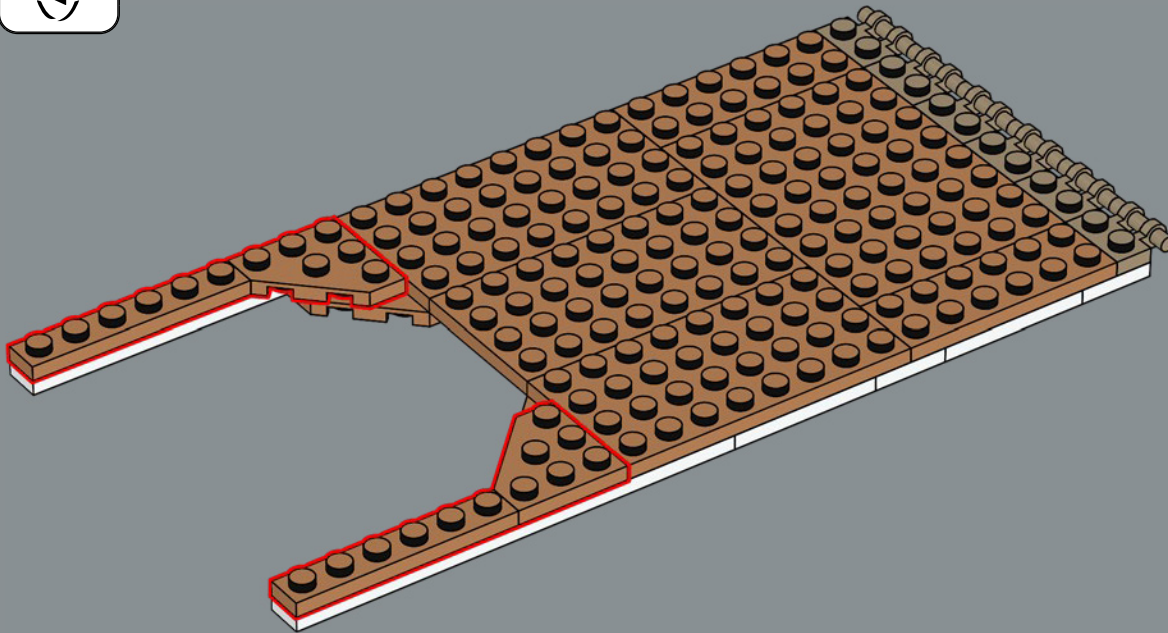



18x



172

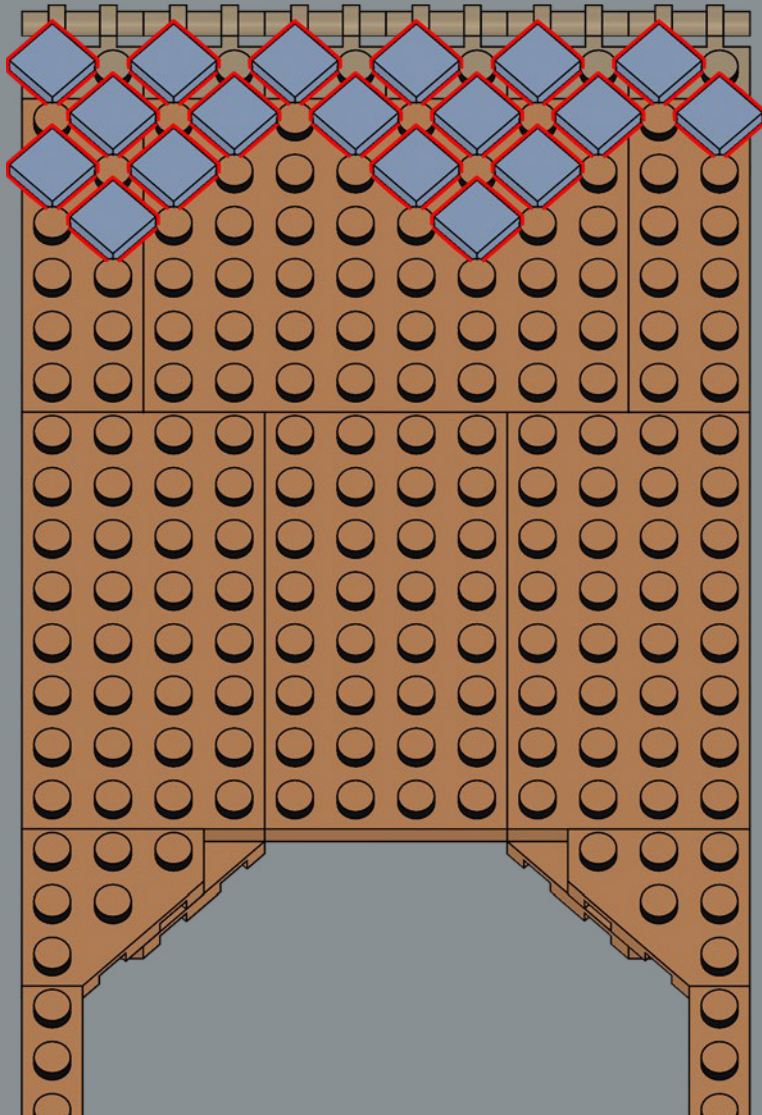

12x



8x

173

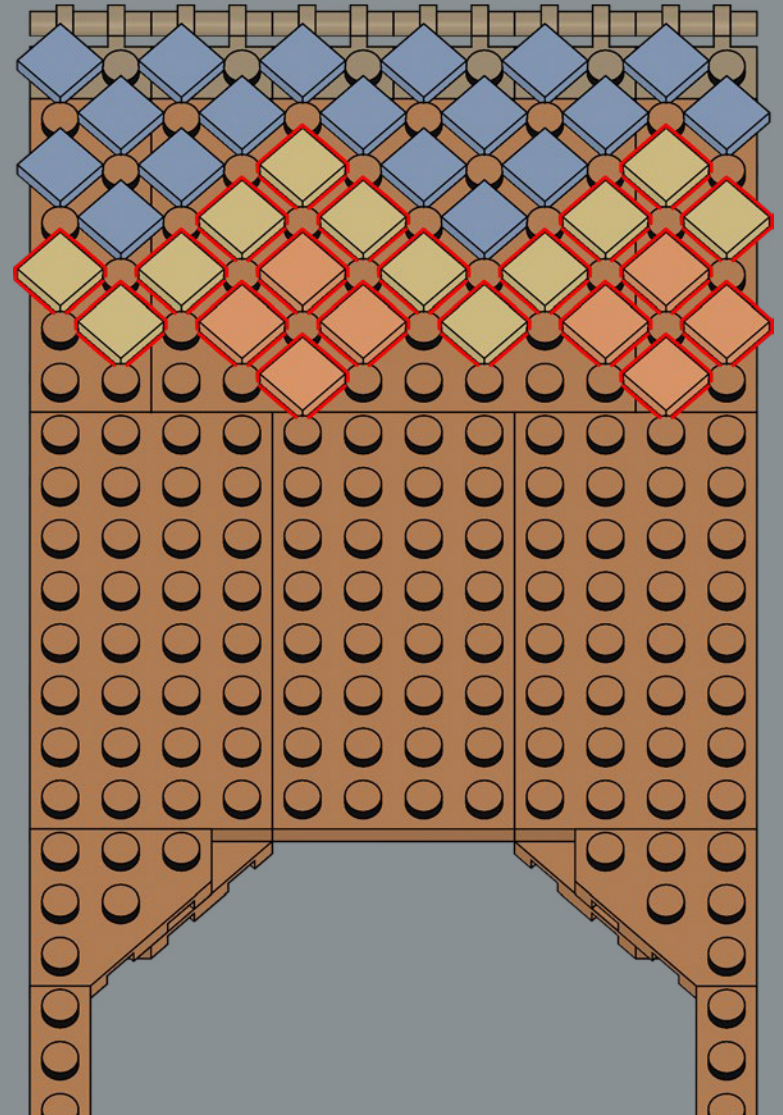

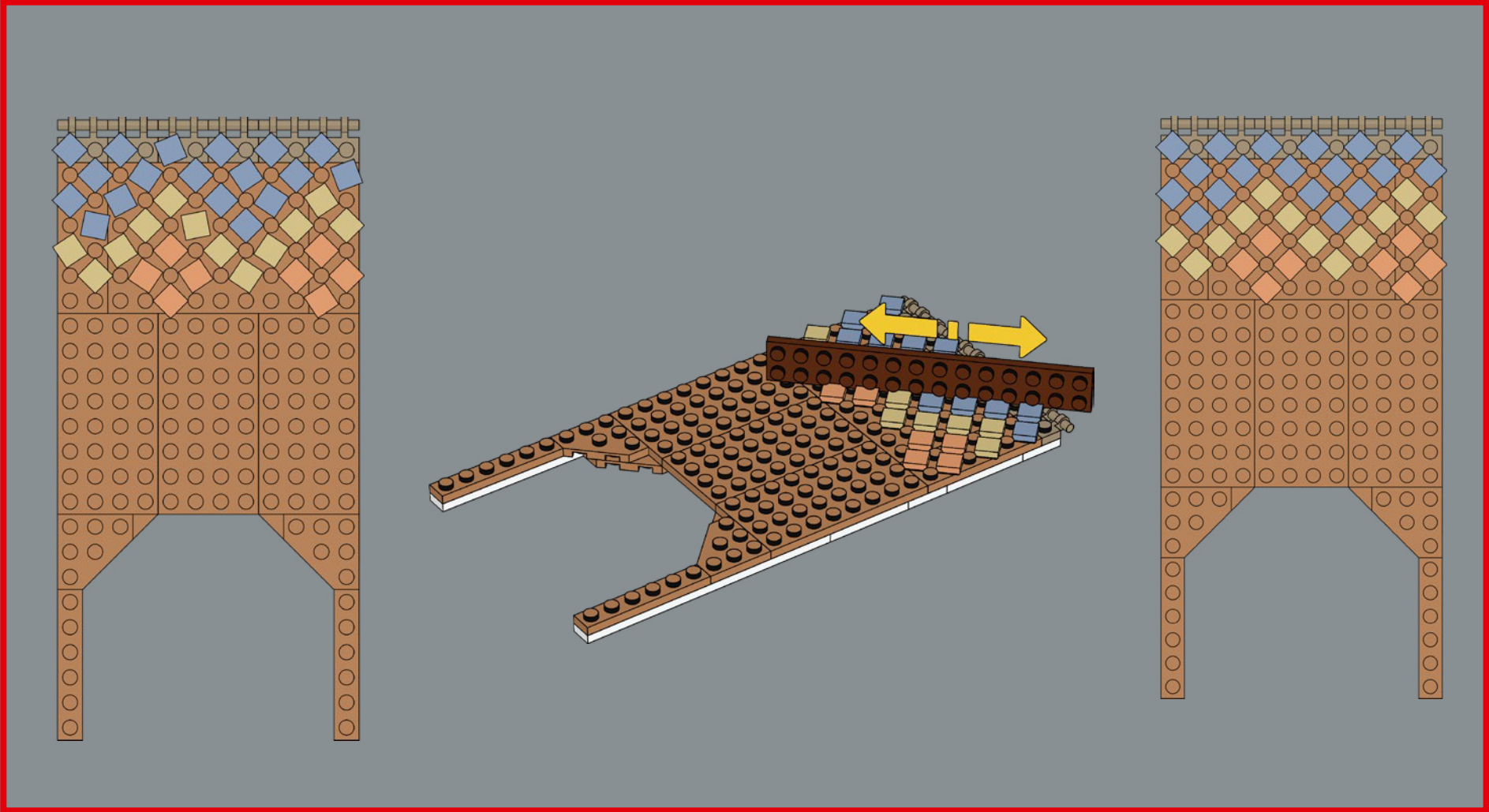



176

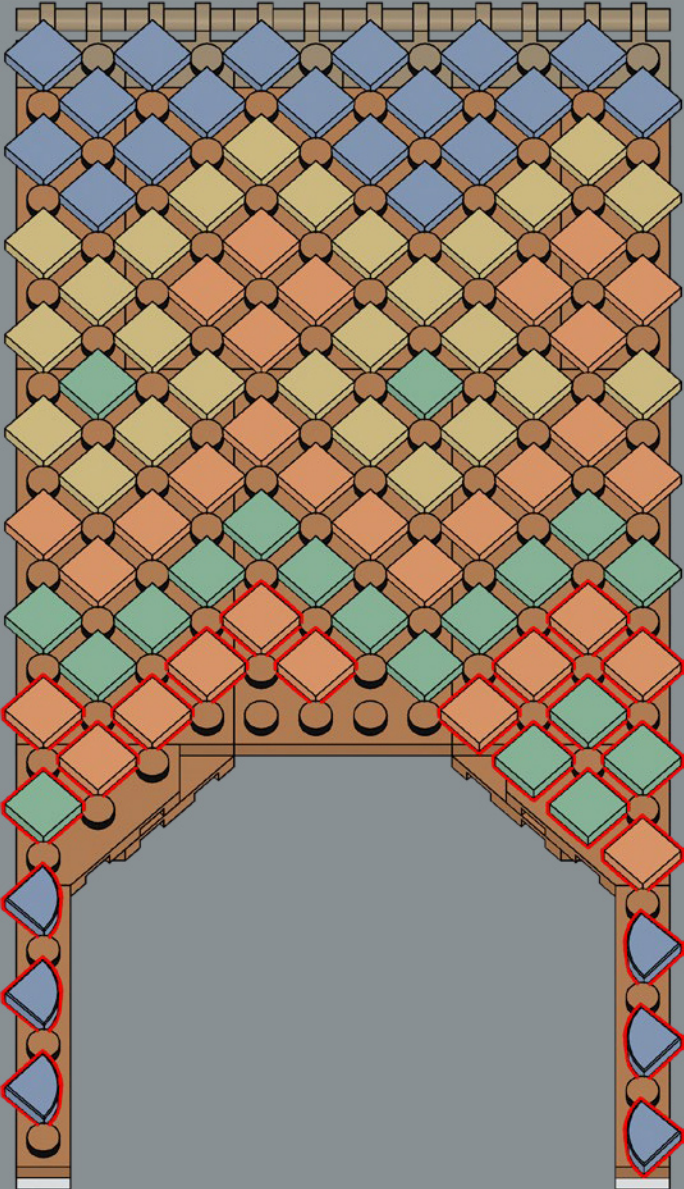

Ciascuna delle 94 tegole 1x1 del tetto deve essere montata a un angolo di 45 gradi. Posizionare una lunga base o tessera attraverso le scanalature una volta che le parti sono state installate è un ottimo modo per allinearle tutte.





6x

177

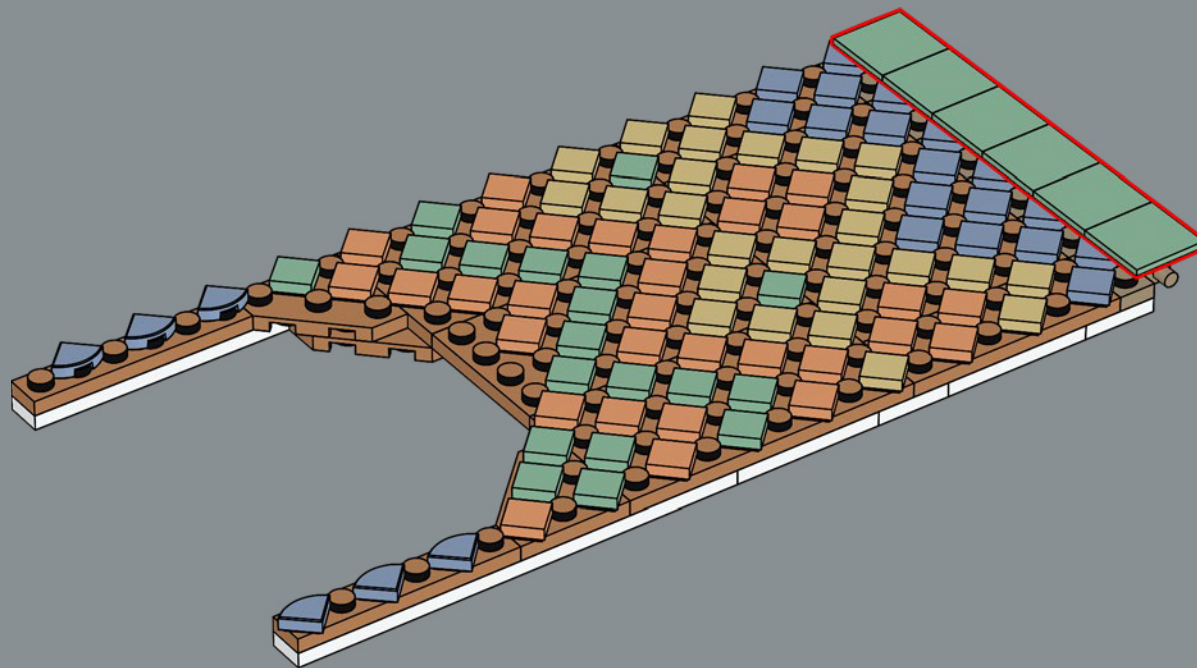

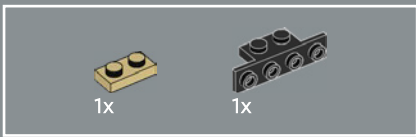

178

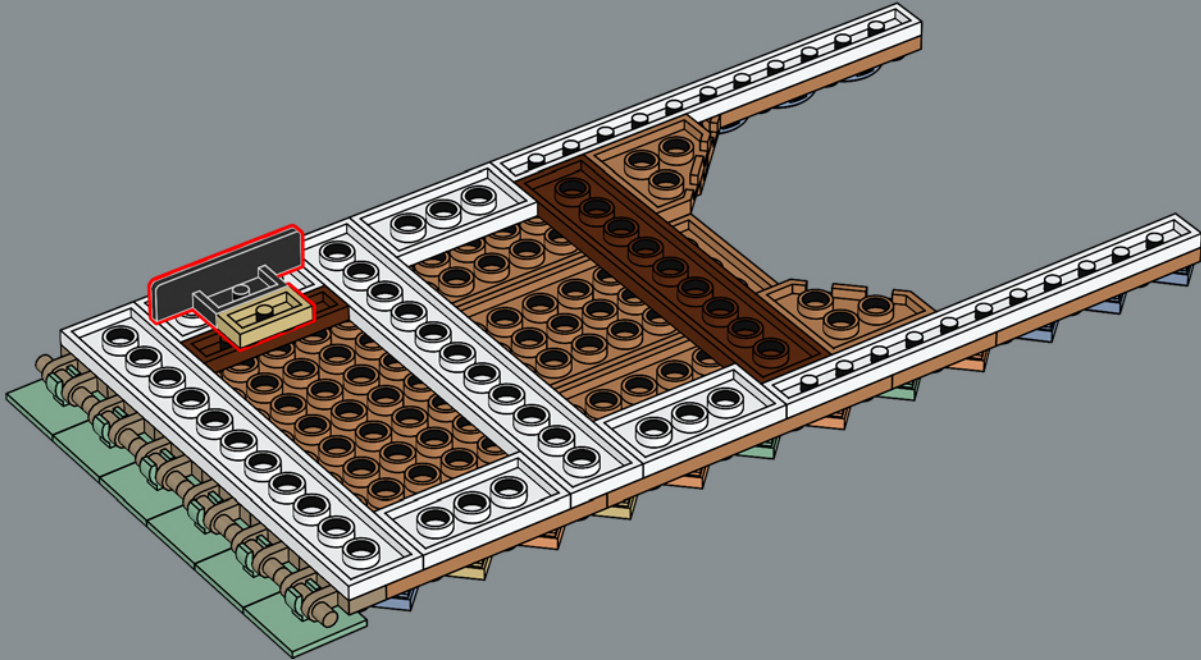



179

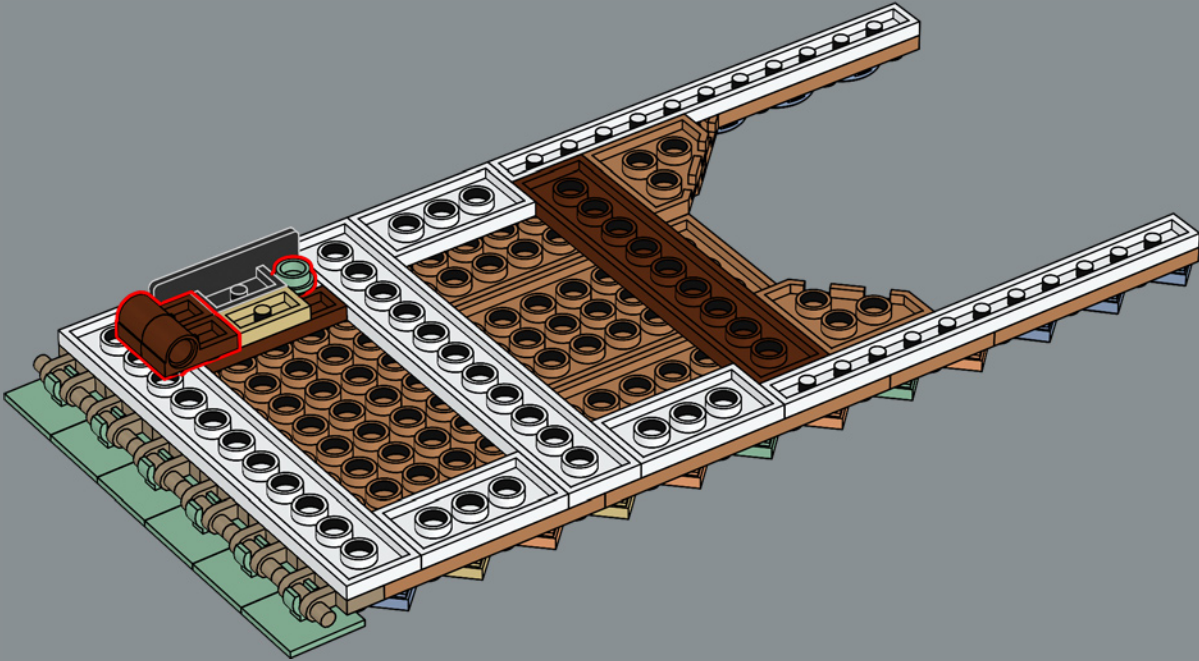

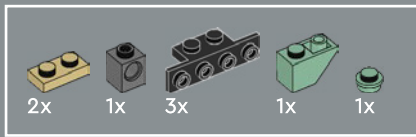

180

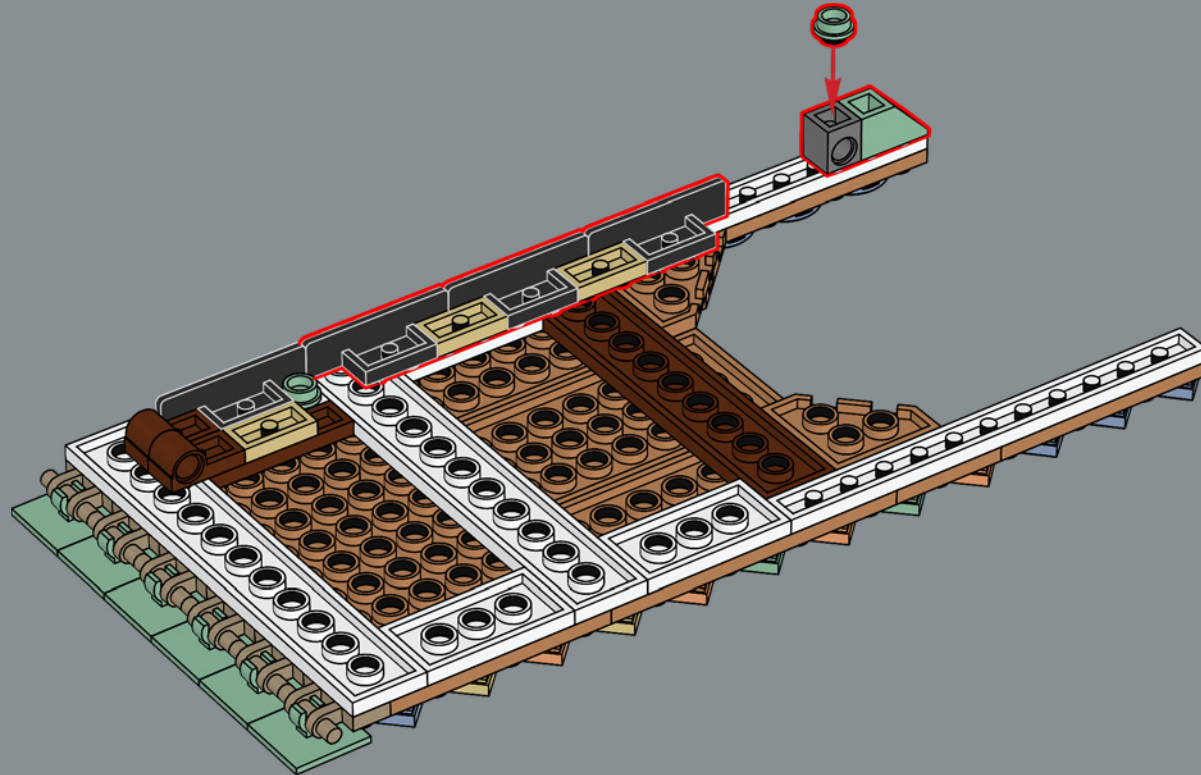

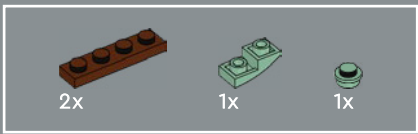

181

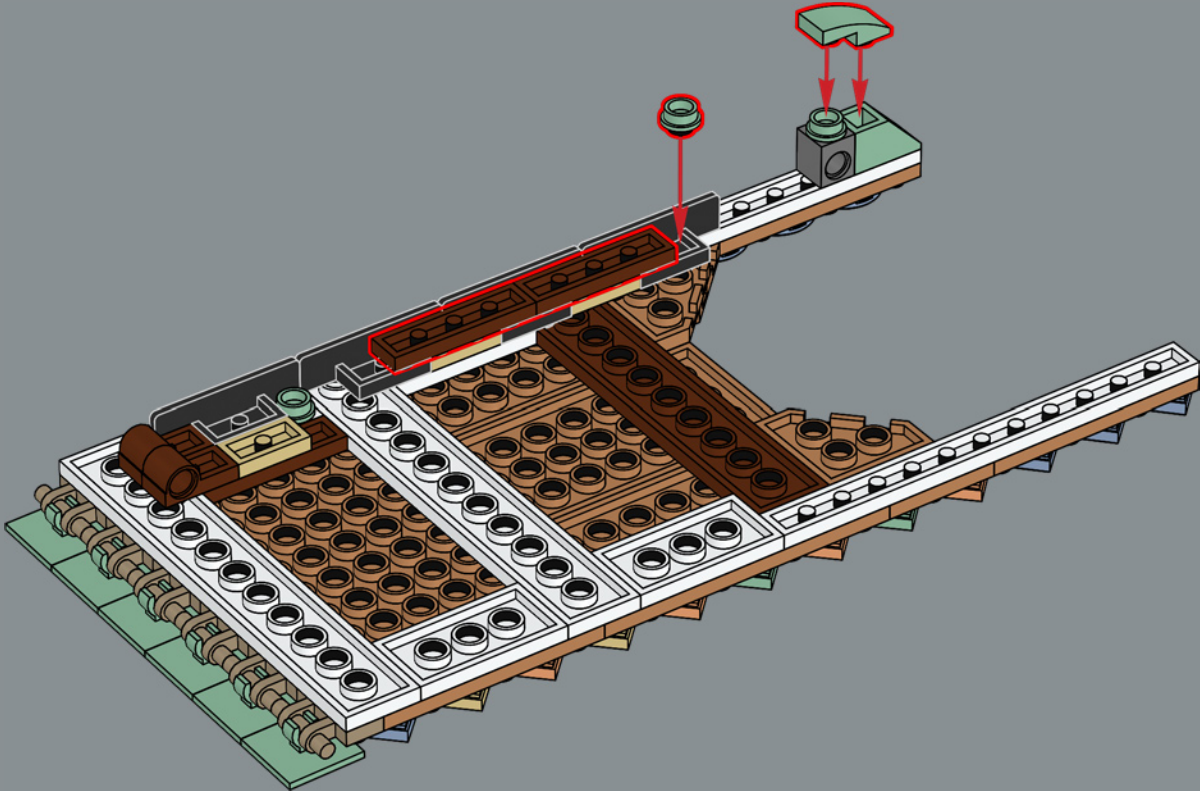

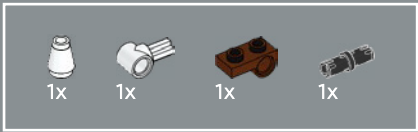

182

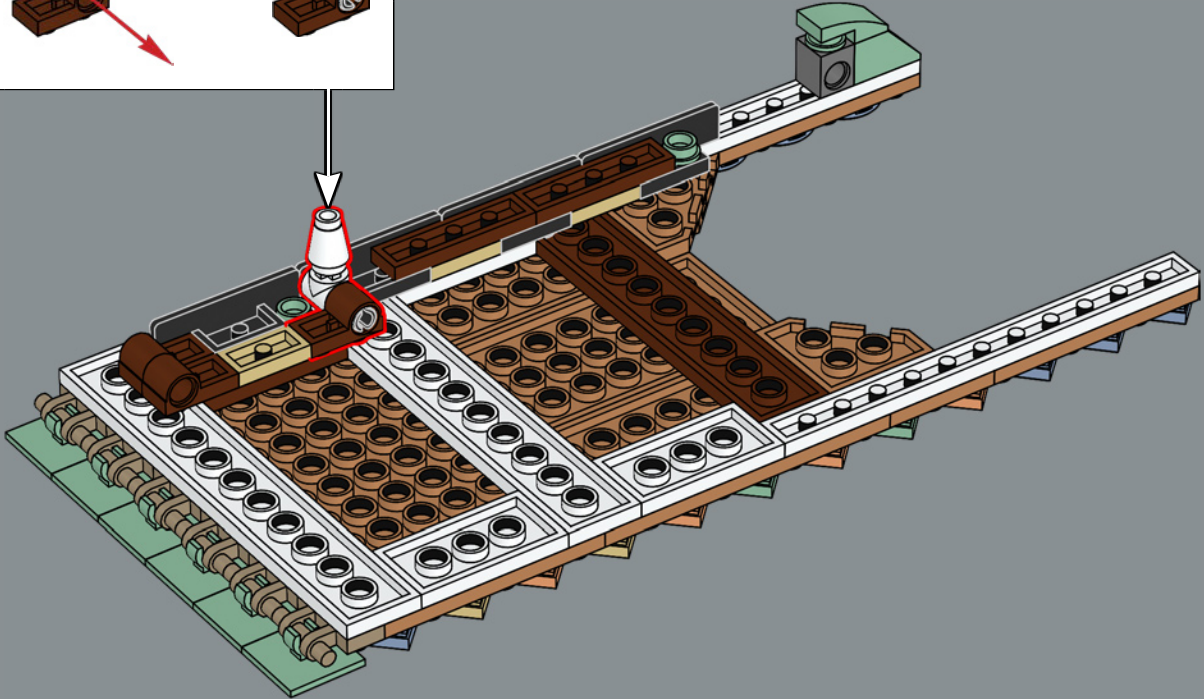
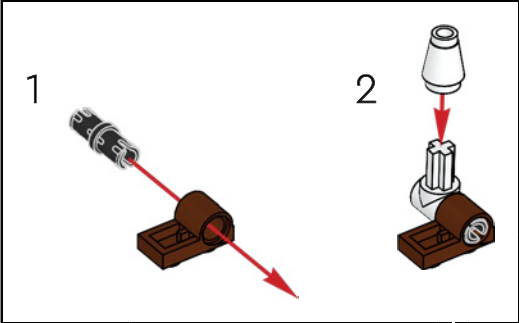

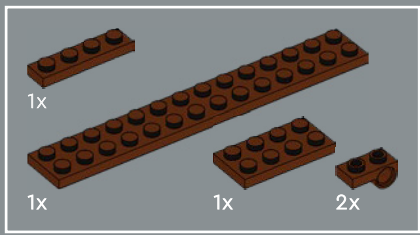

183

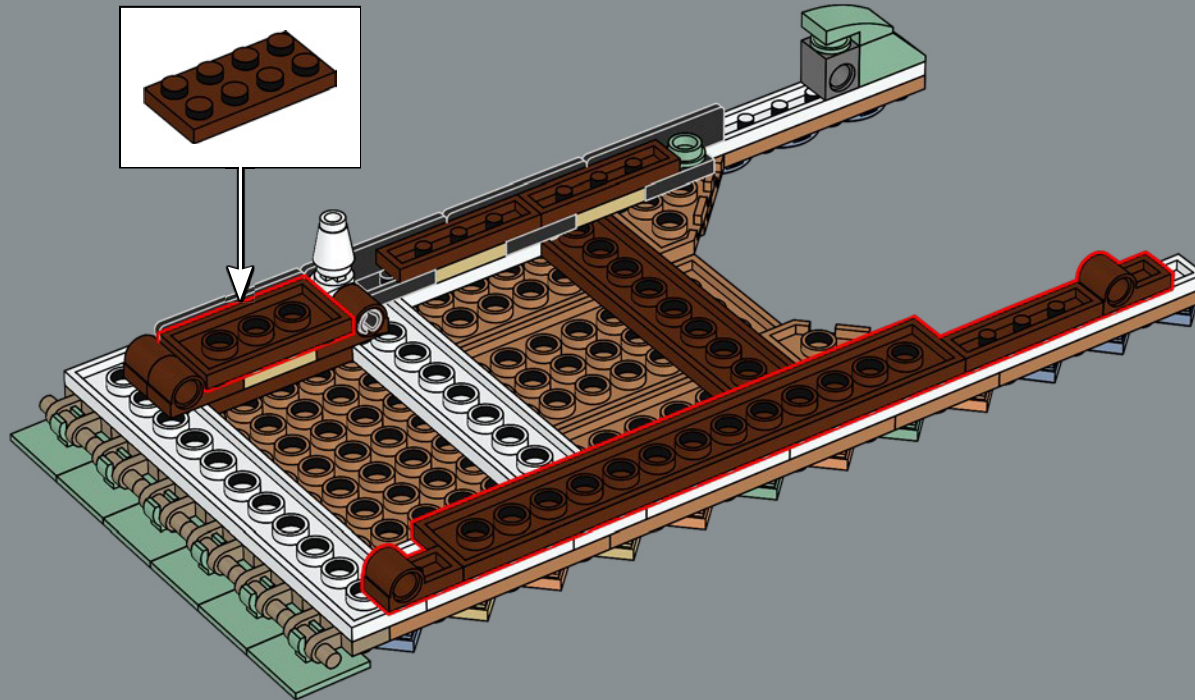

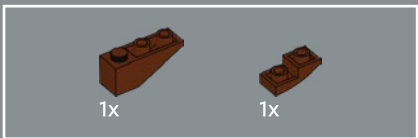

184

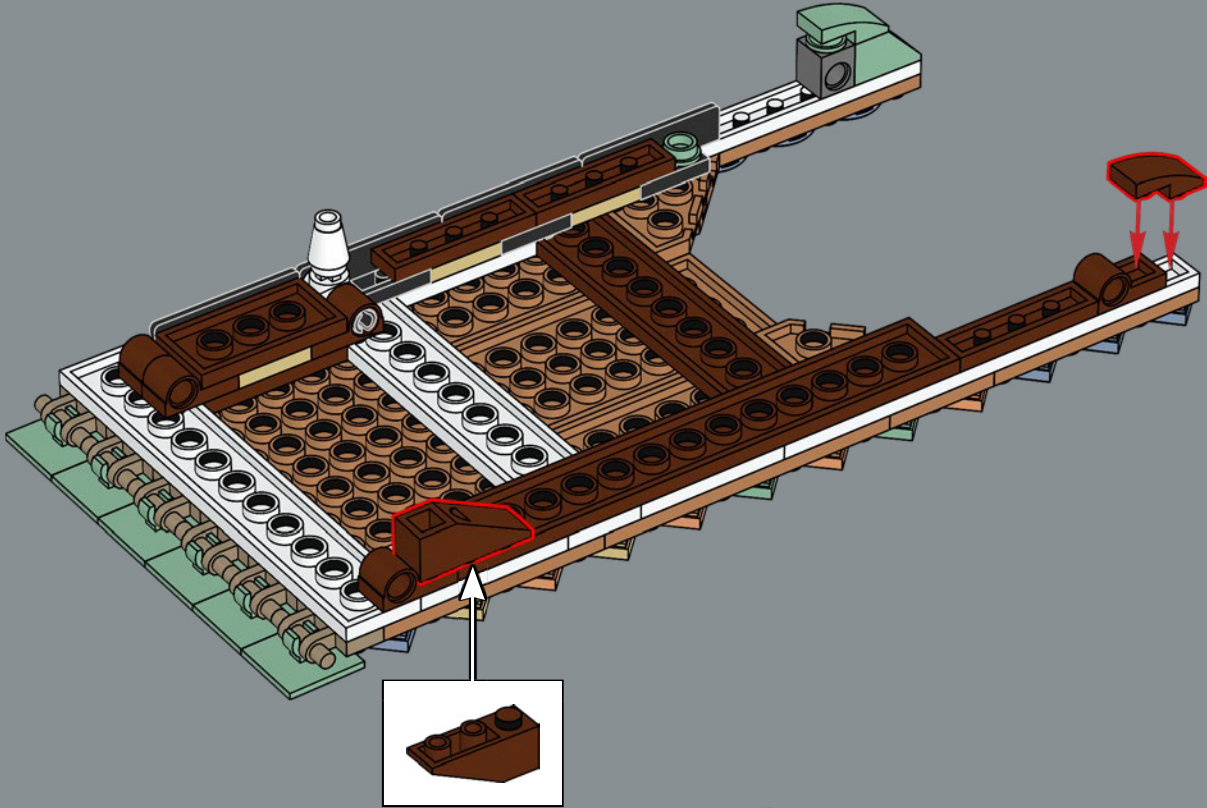

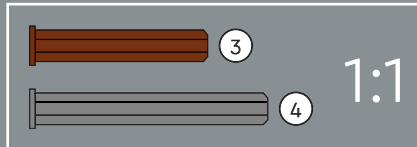
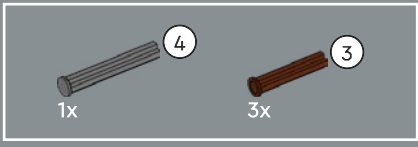

185

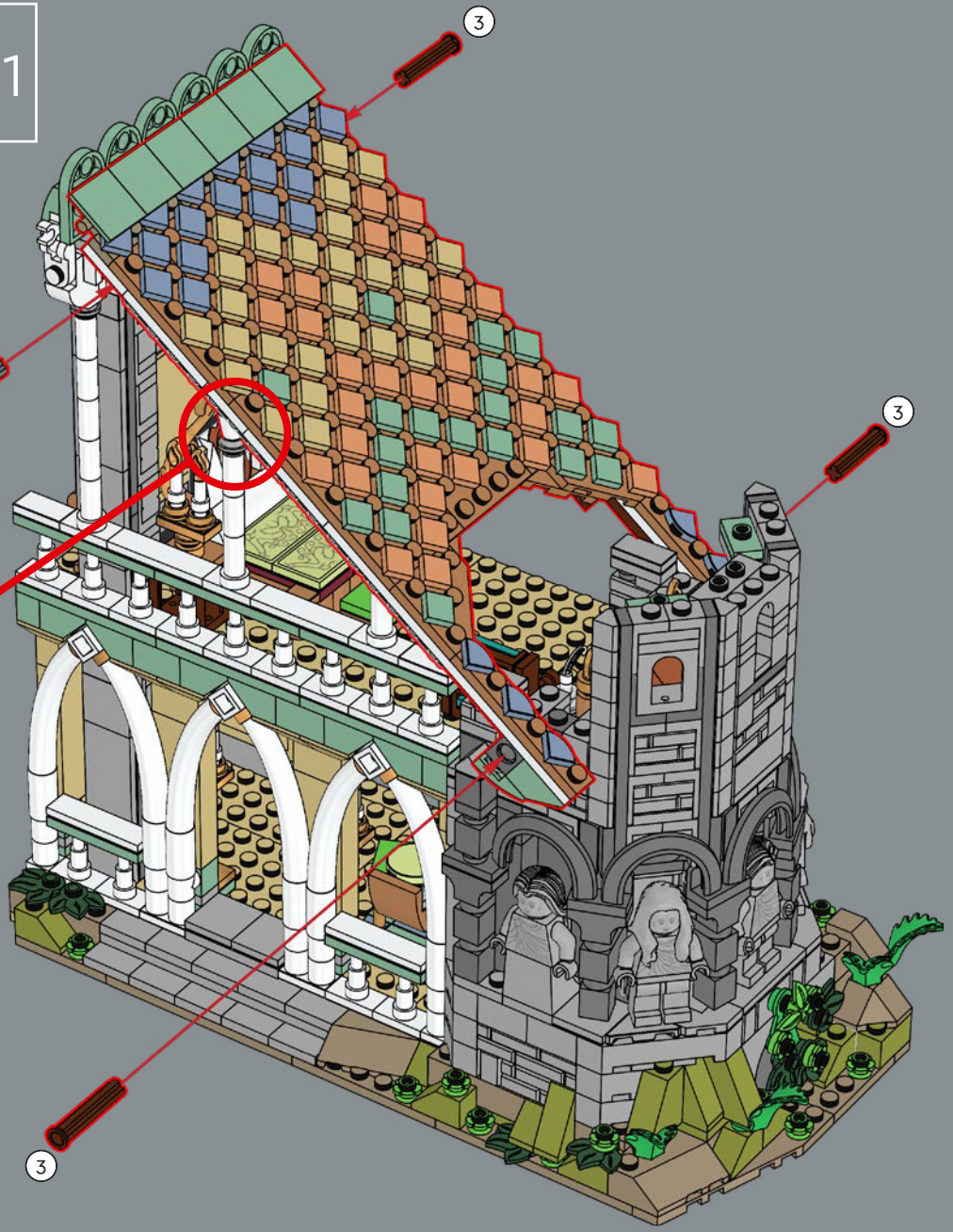
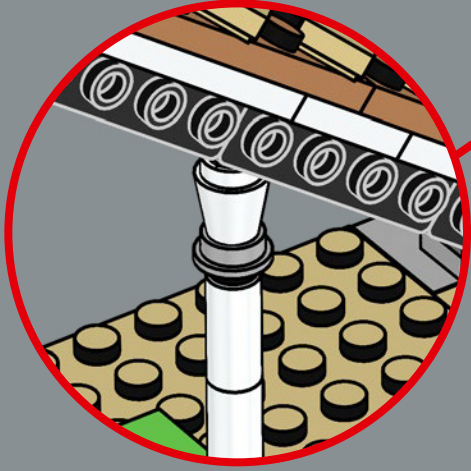
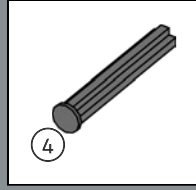

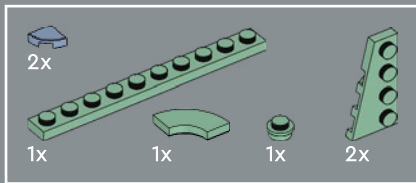

186

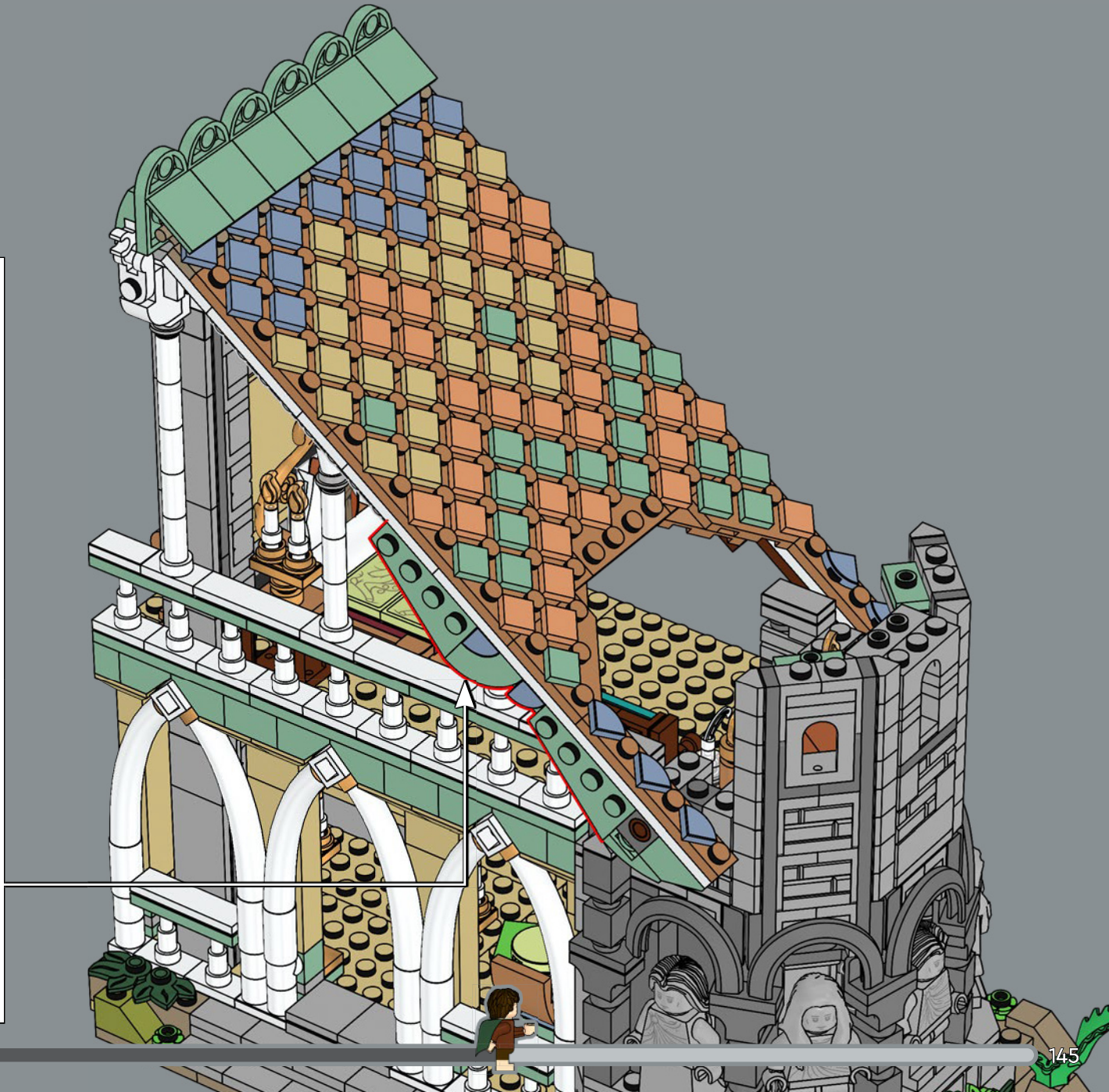
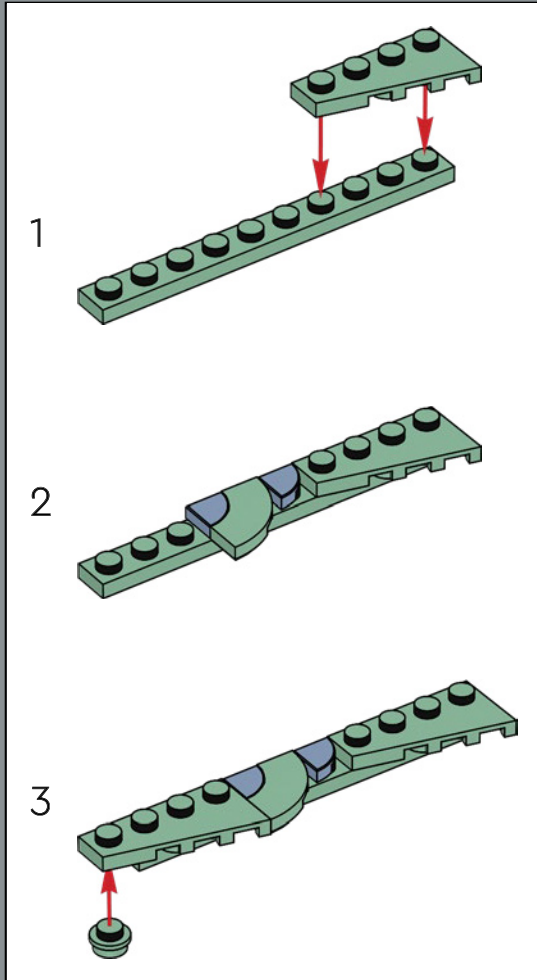

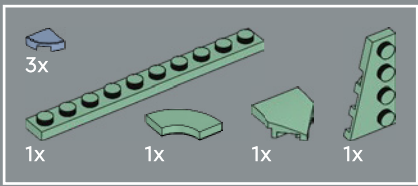

187

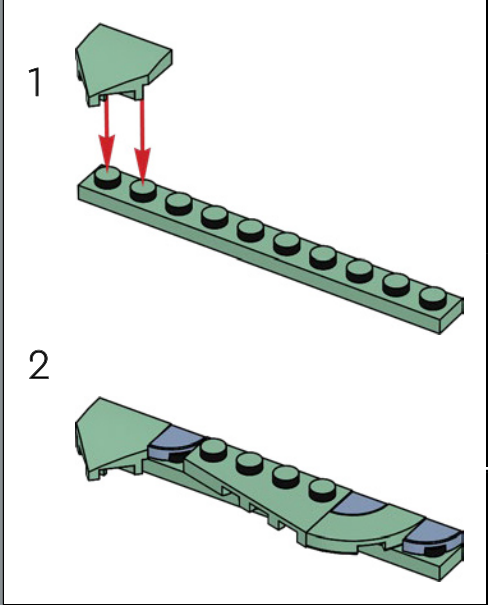

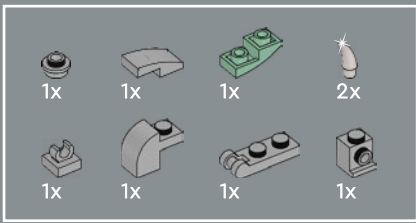

188

1

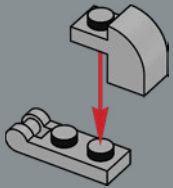

2

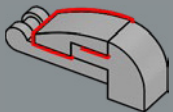

3

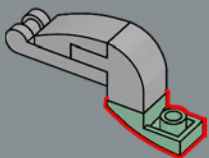

4

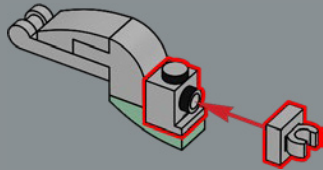

5

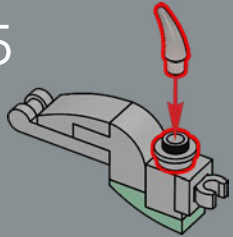

6

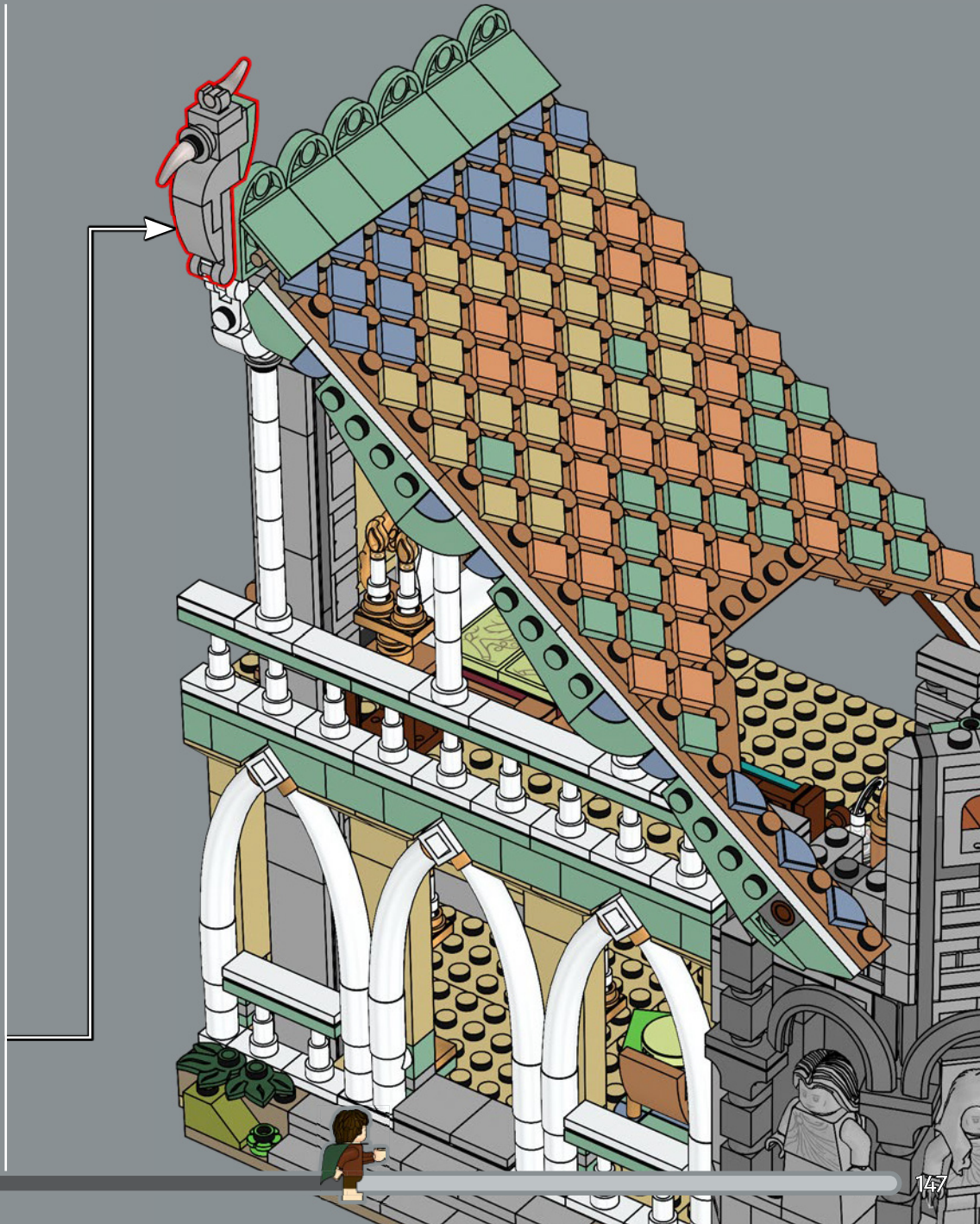
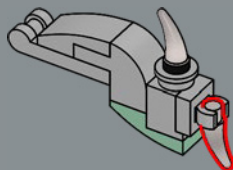

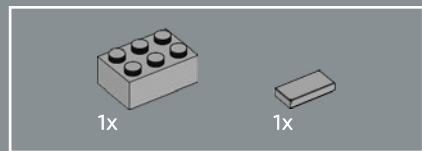

189

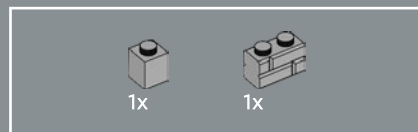
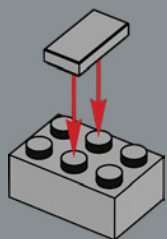

190

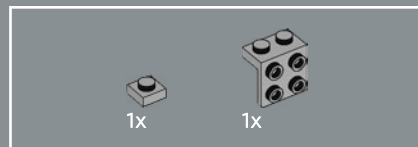
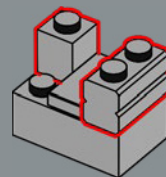

191

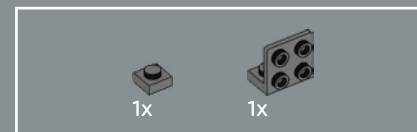
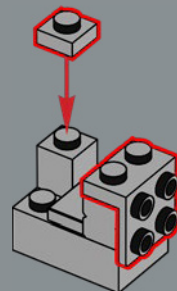

192

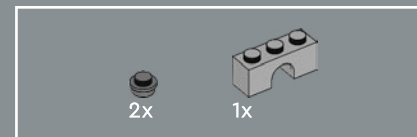
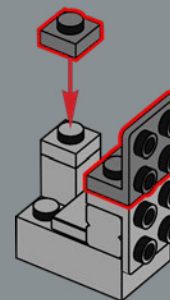

193

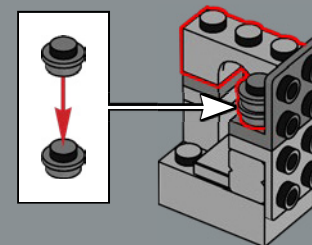

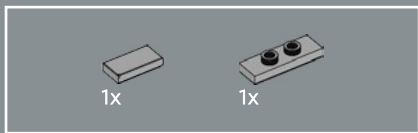

194

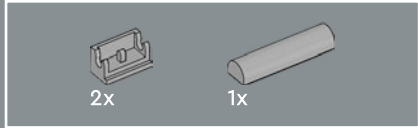
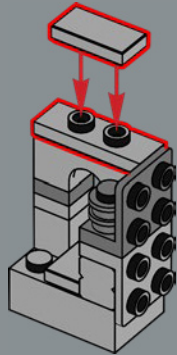

195

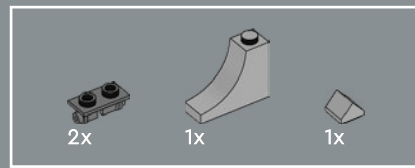
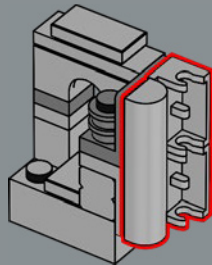

196

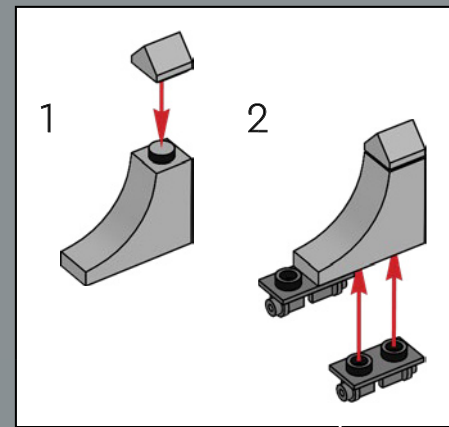
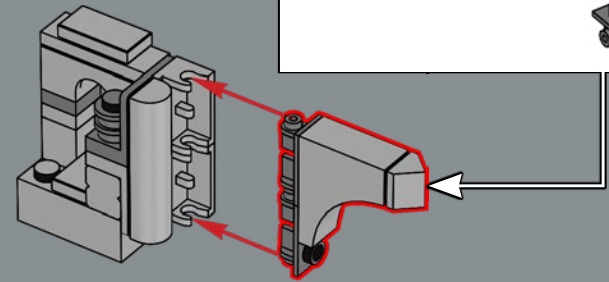

197

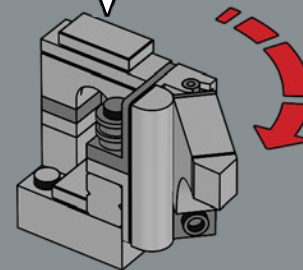

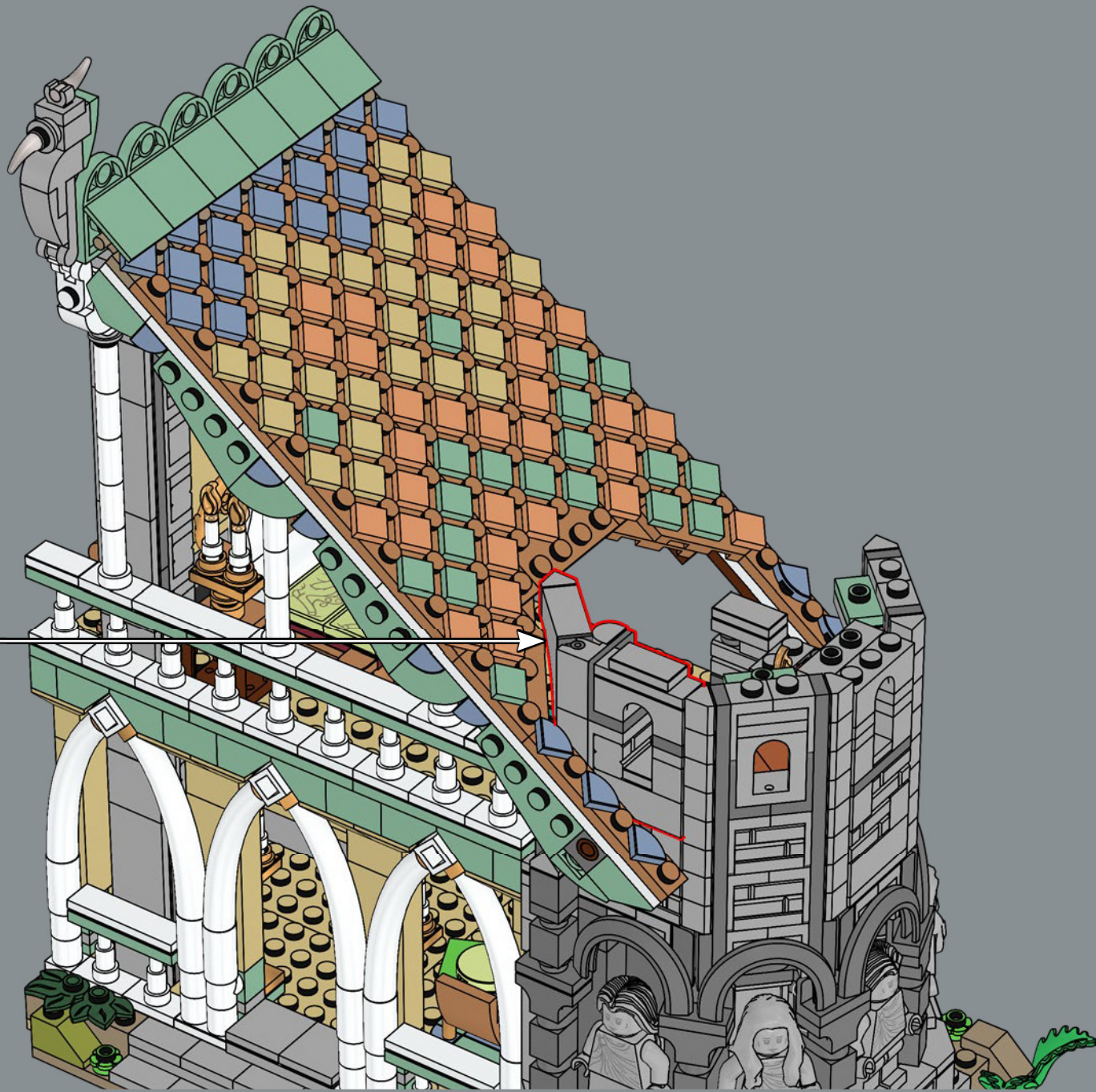

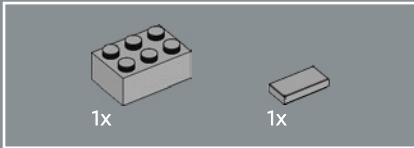
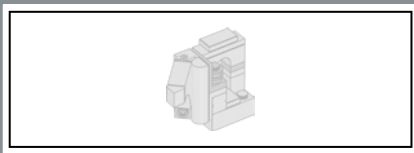

199

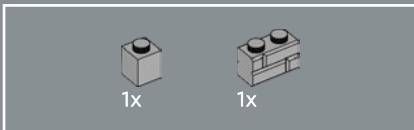
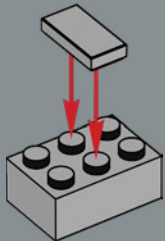

200

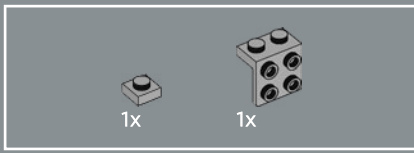
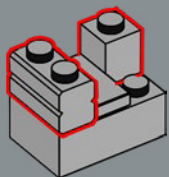

201

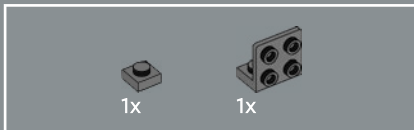
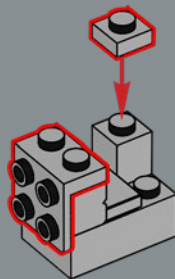

202

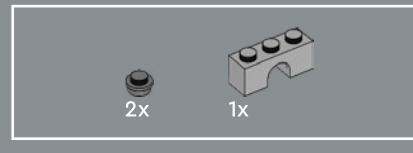
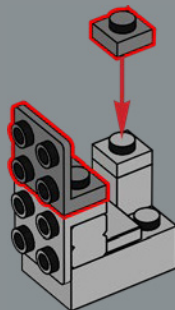

203

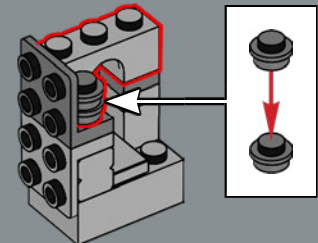

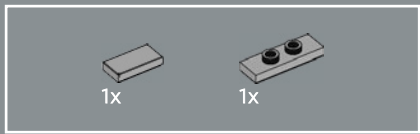

204

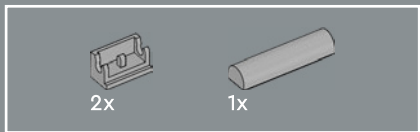
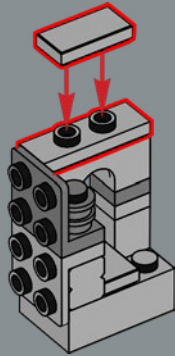

205

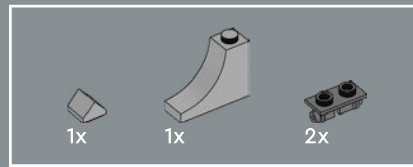
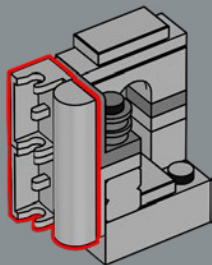

206

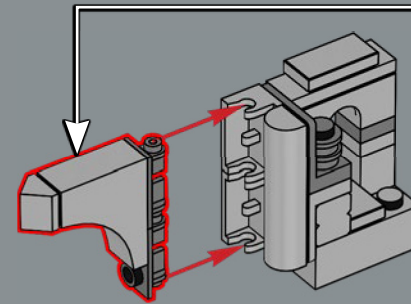
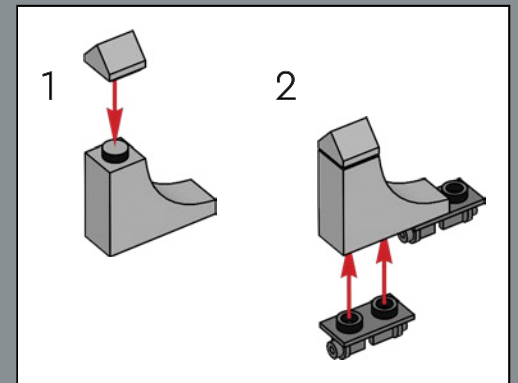

207

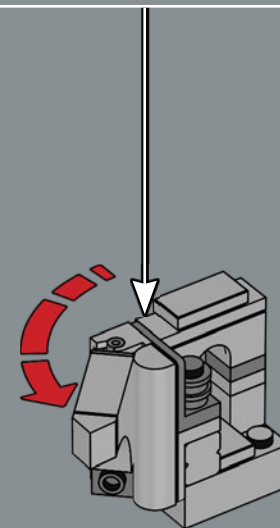

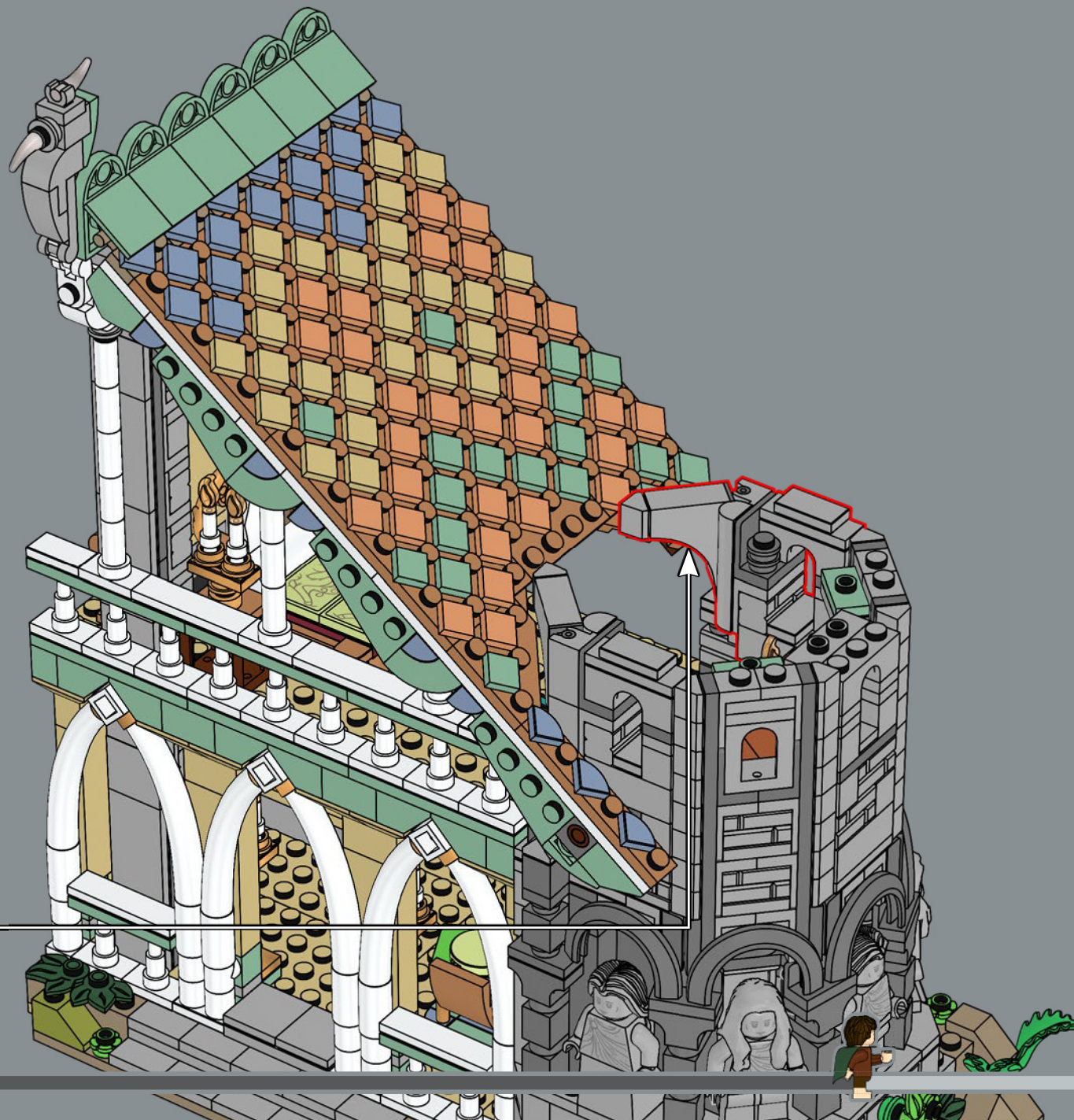

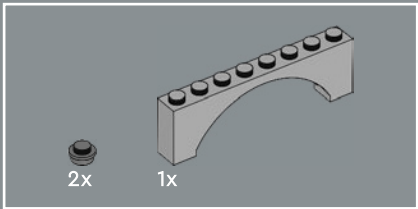

209

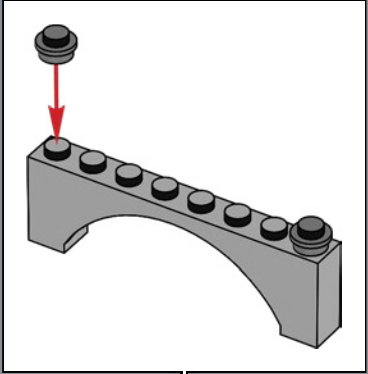
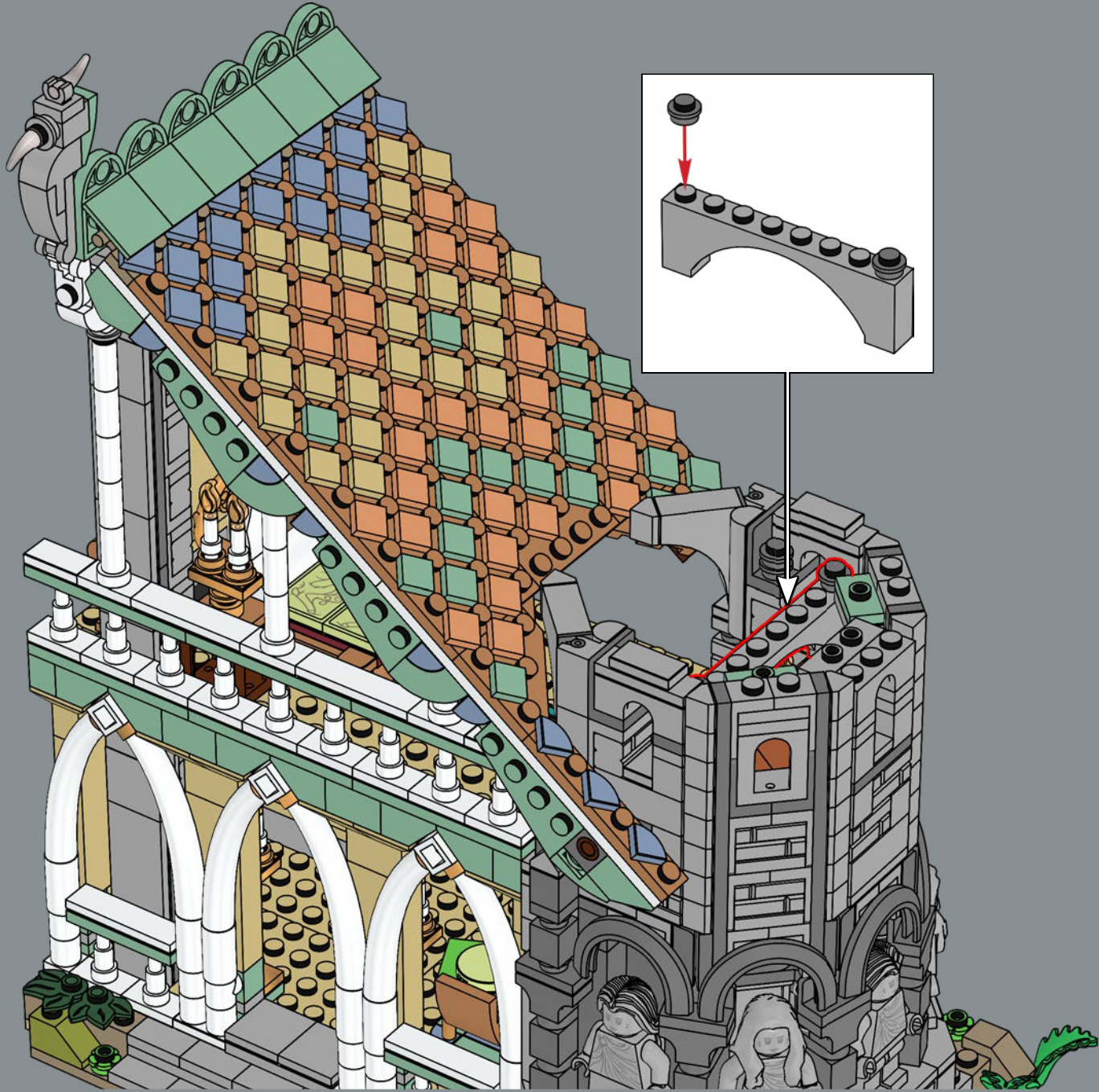

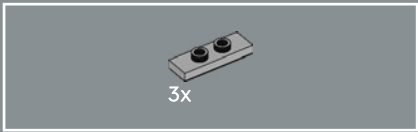

210

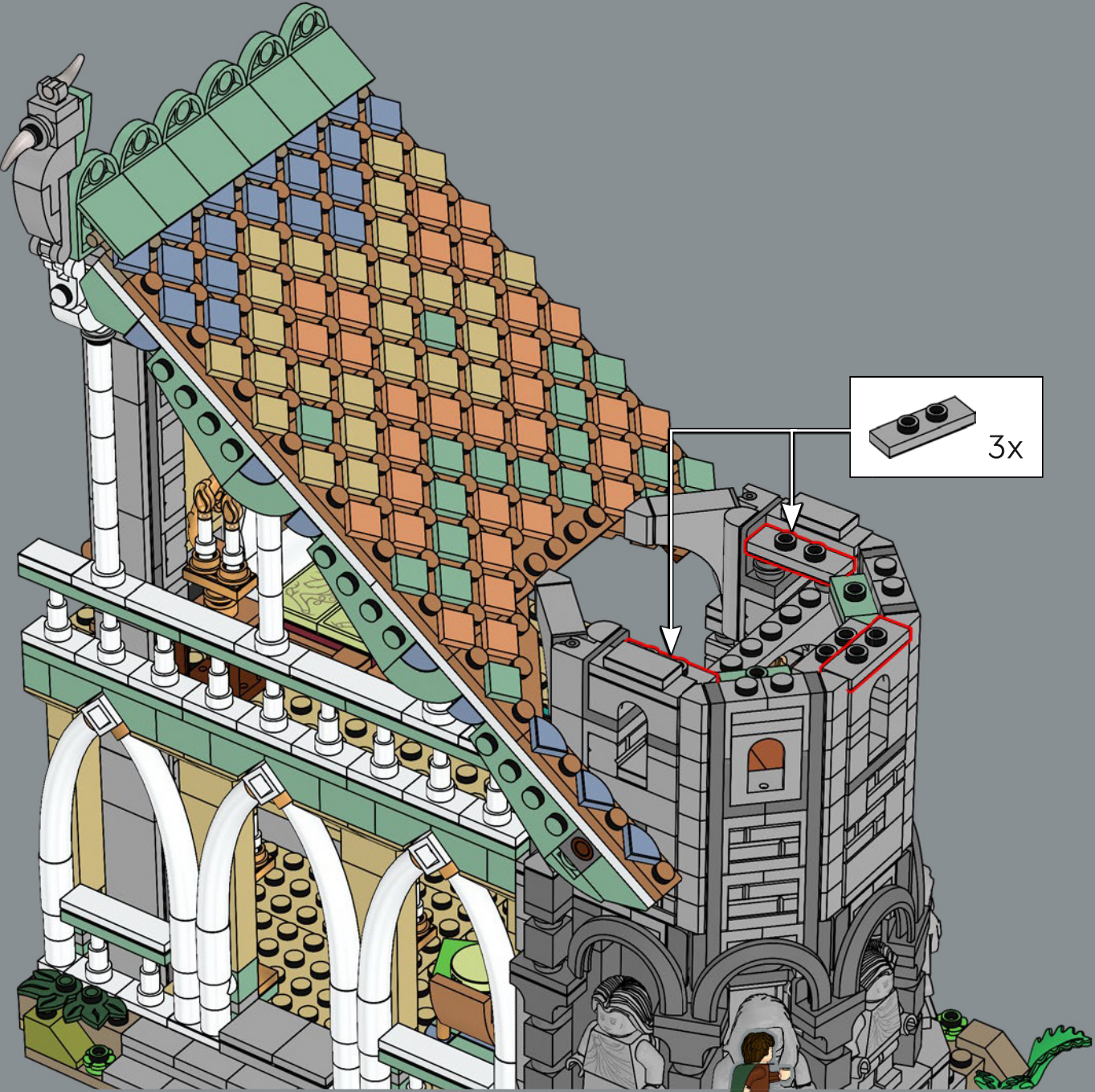



211

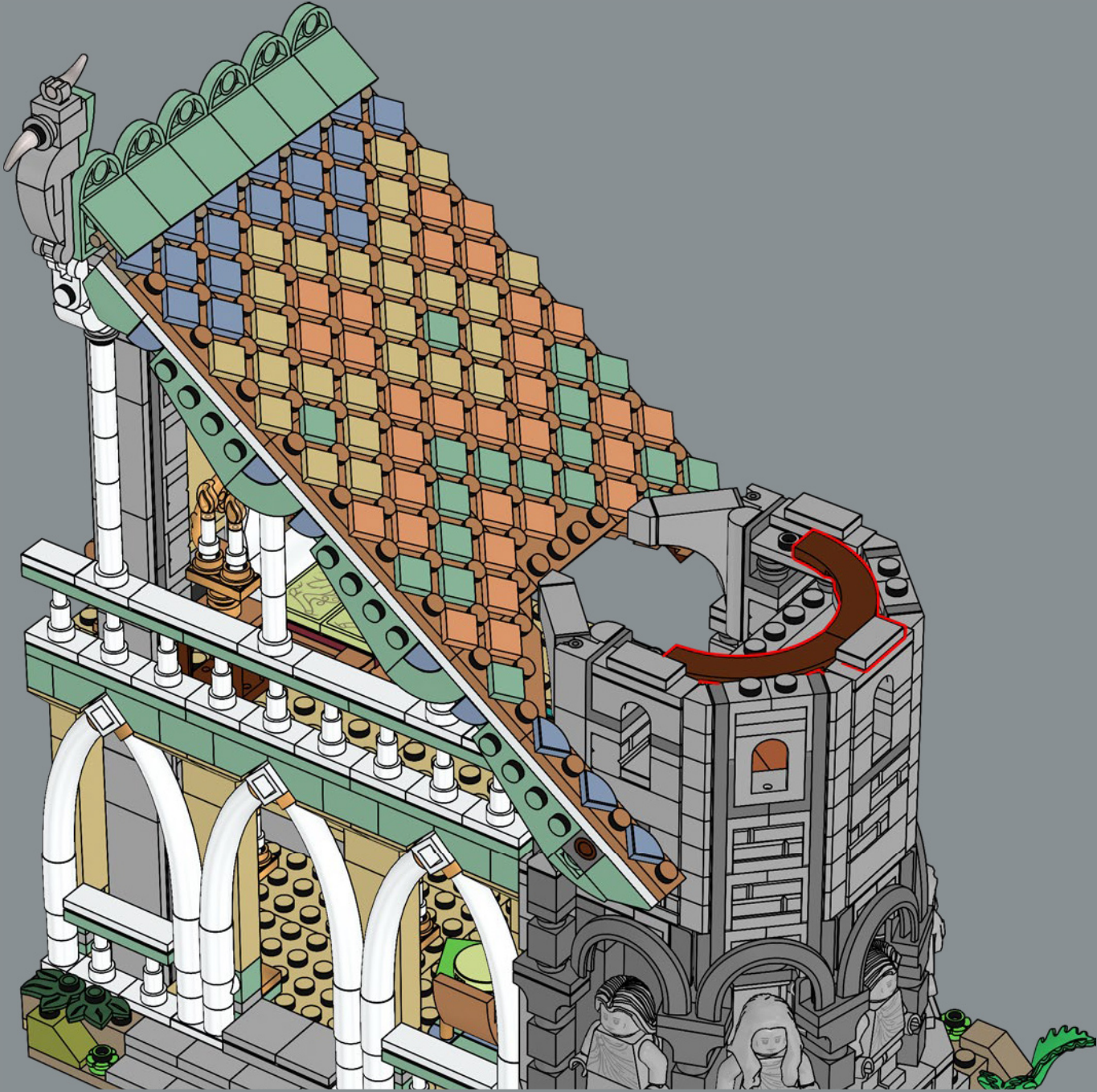

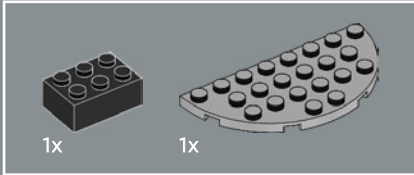
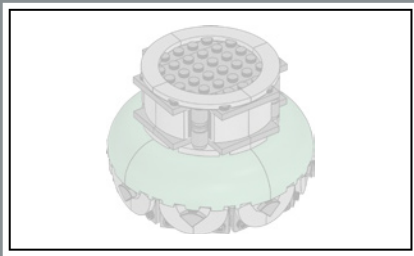

212

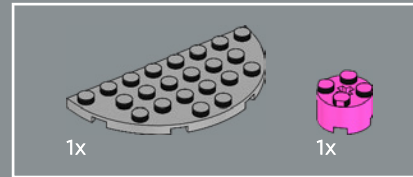
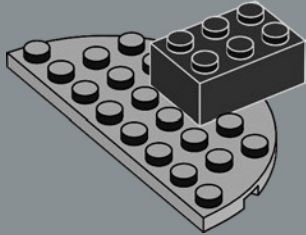

213

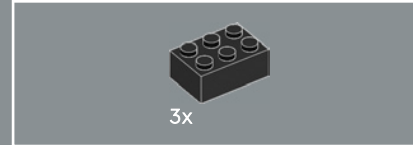
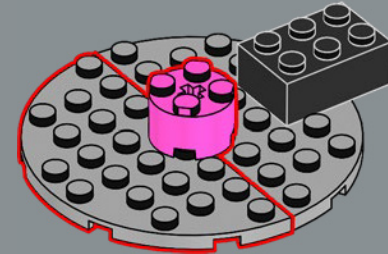

214

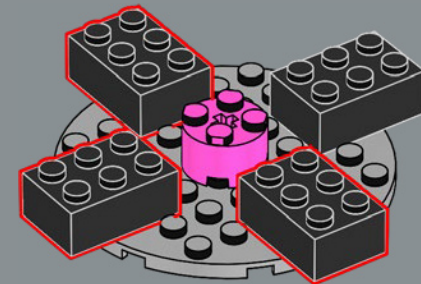

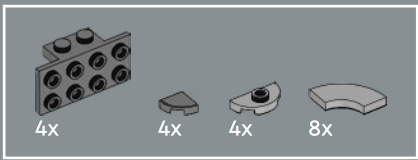

215

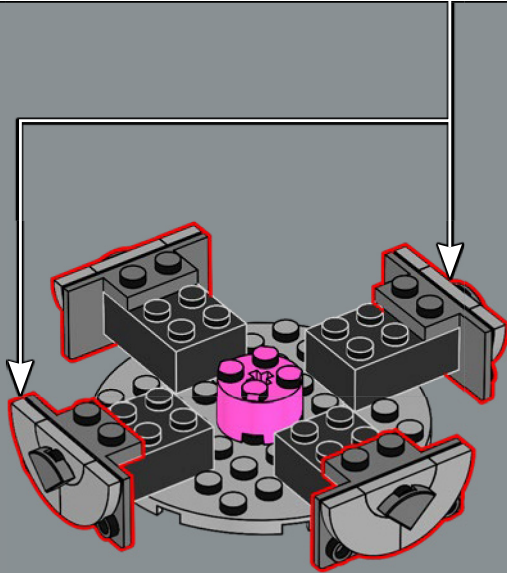
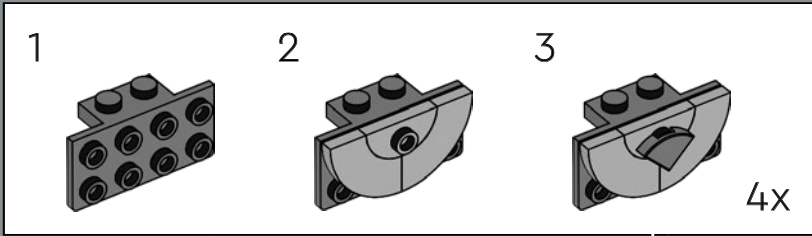

216

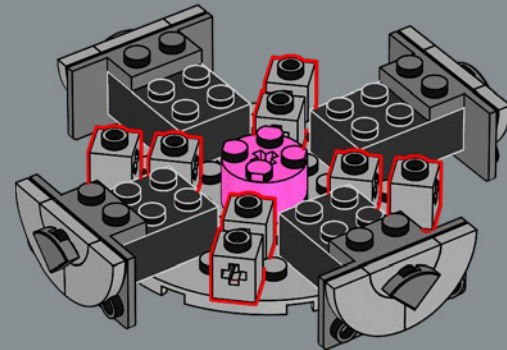

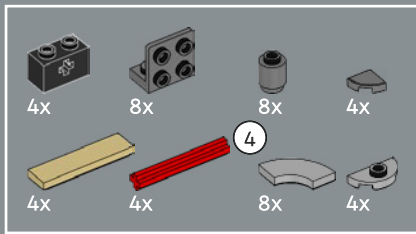

217

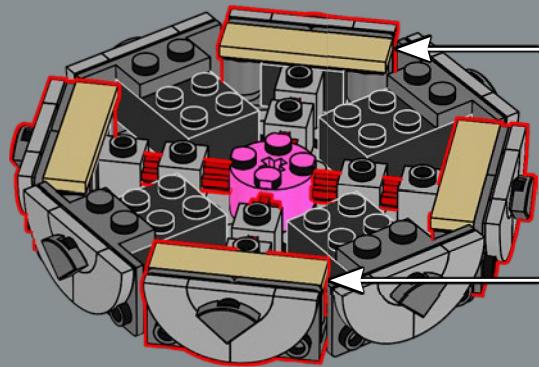
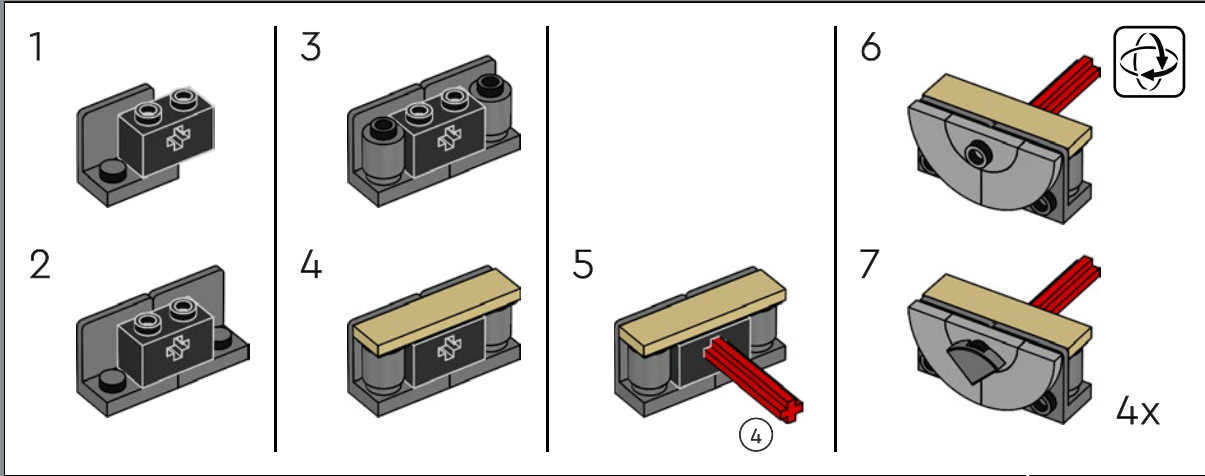

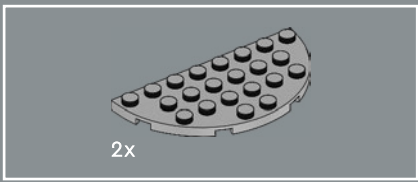

218

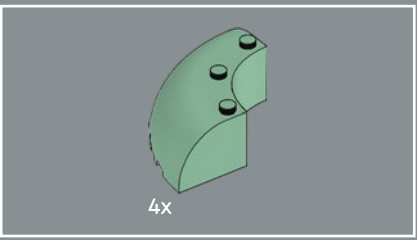
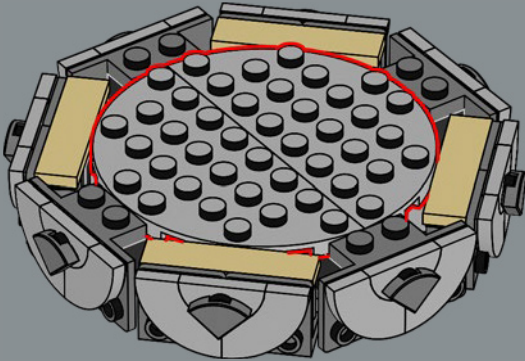

219

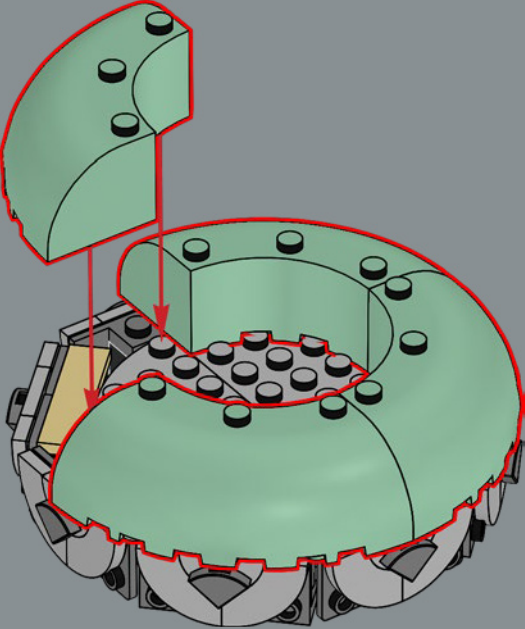

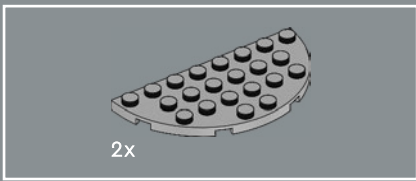

220

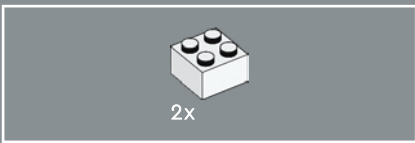
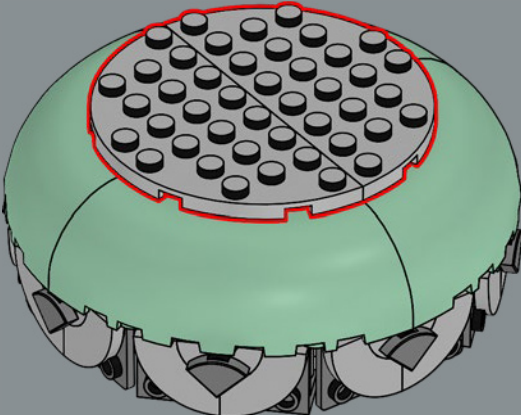

221

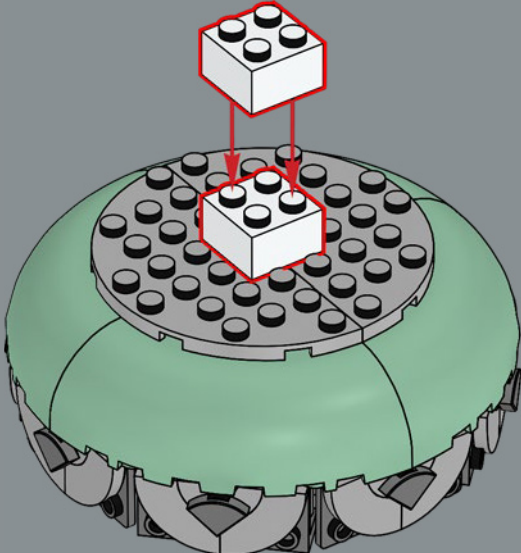

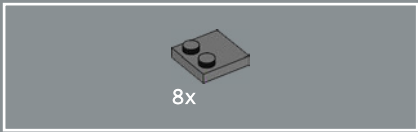

222

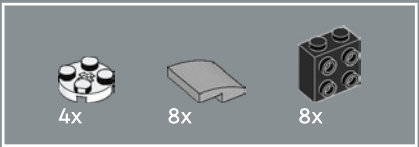
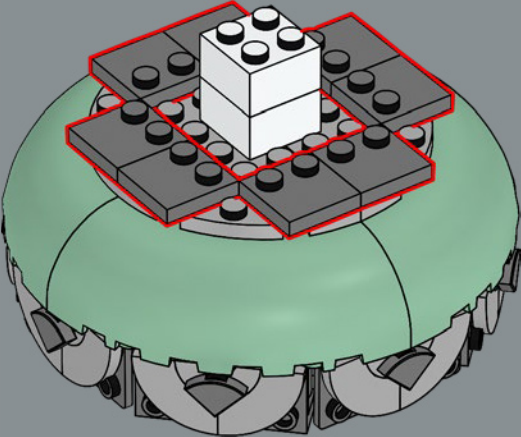

223

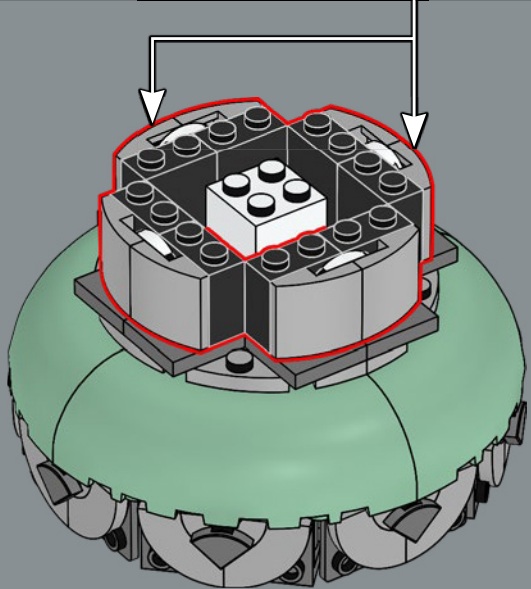
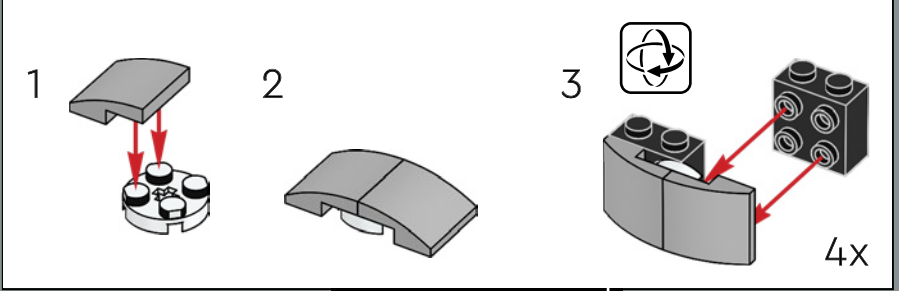

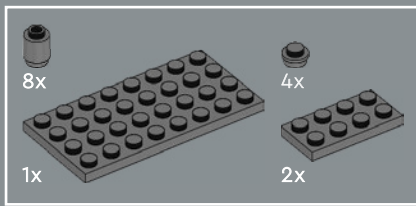

224

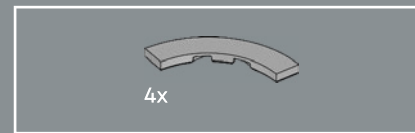
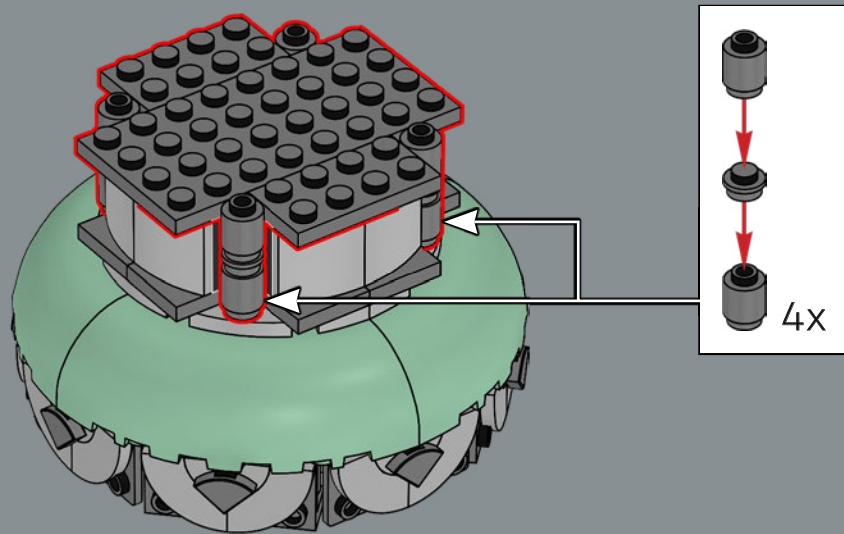

225

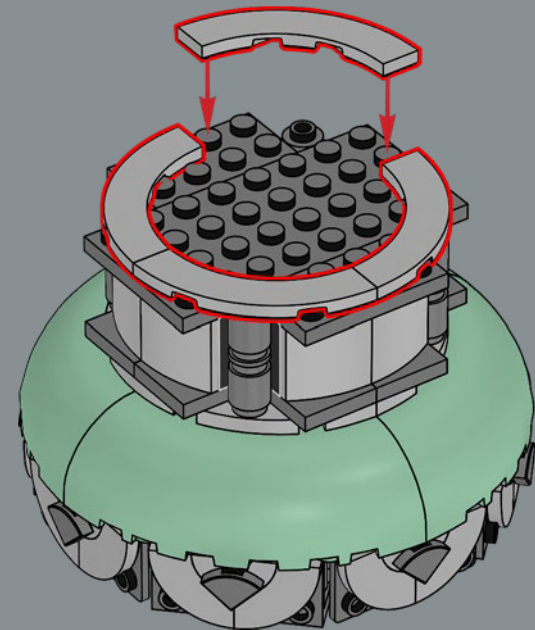



Il tetto della torre è progettato per essere
rimovibile e consentire di dare un'occhiata
ai progressi nella scrittura di Bilbo.

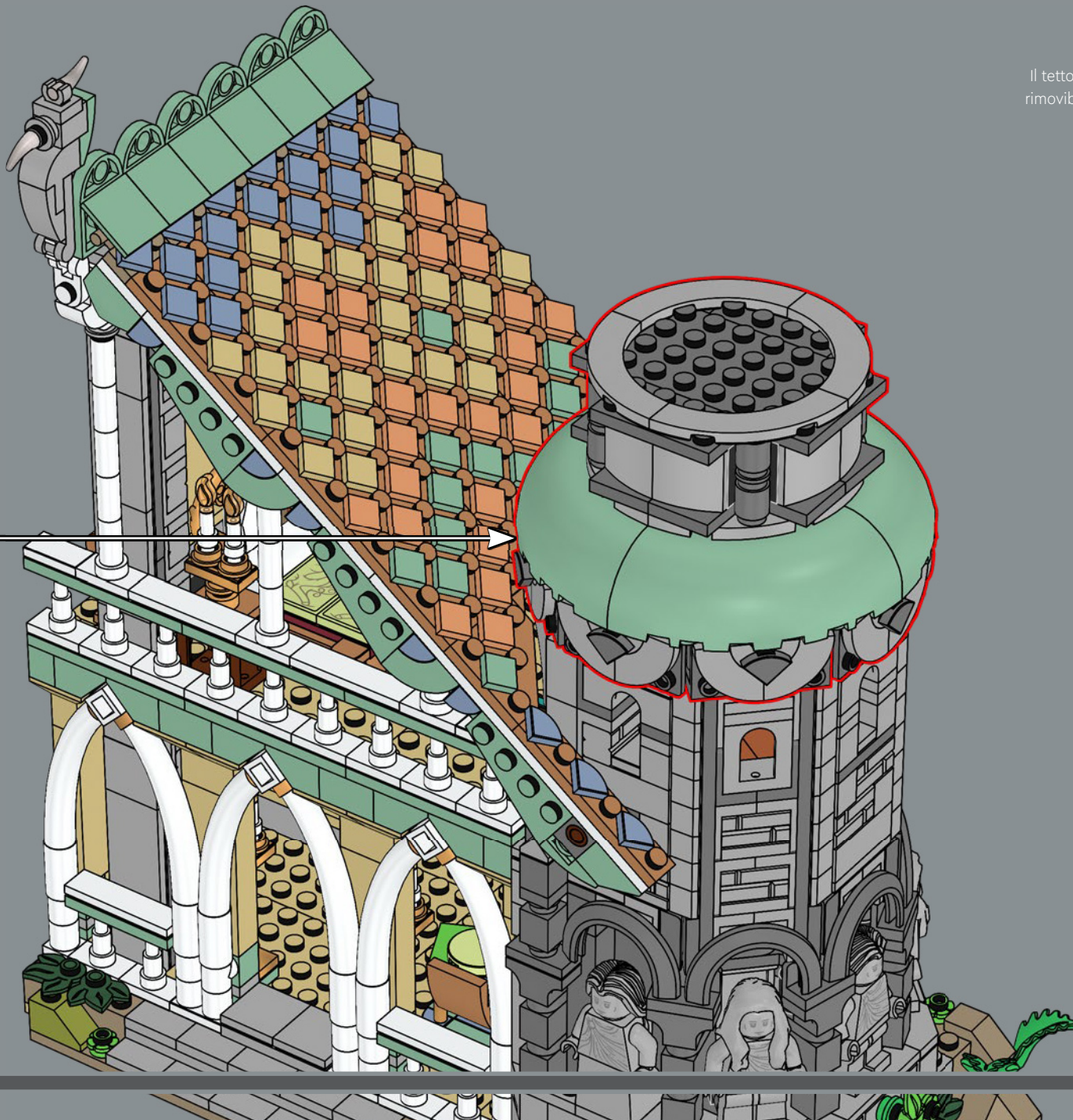



227

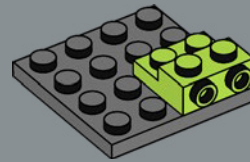

229

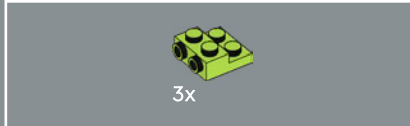
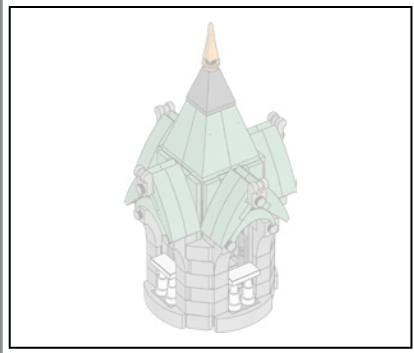
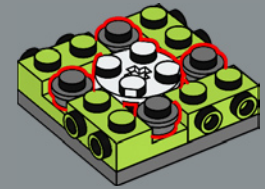

228

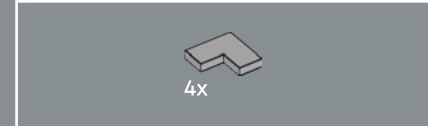
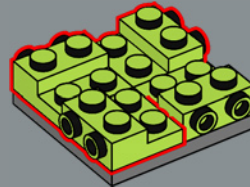

230

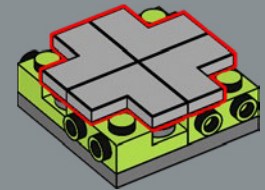



4x

231

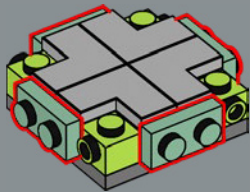

4x



8x



8x



4x

232

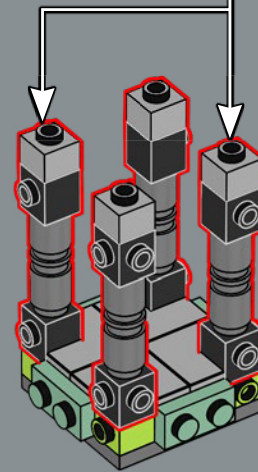
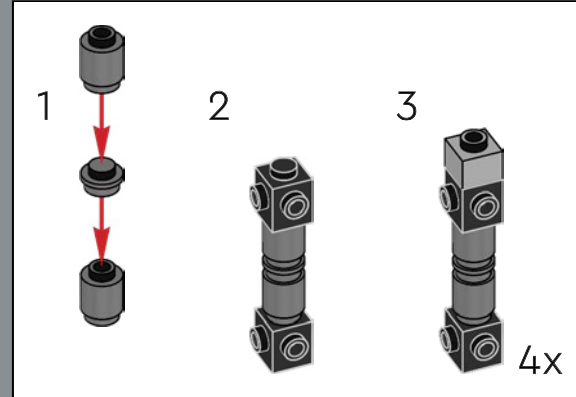

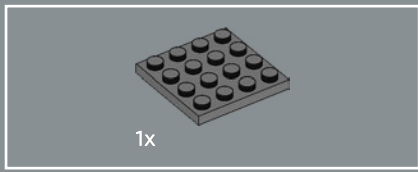

233

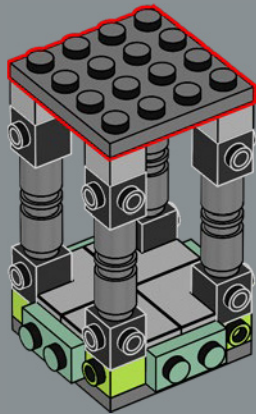

234

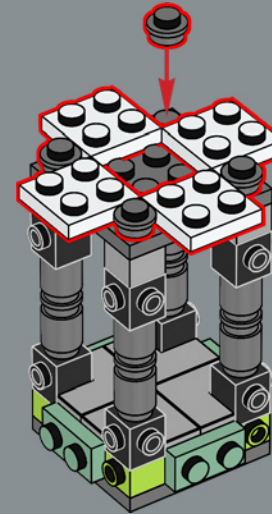

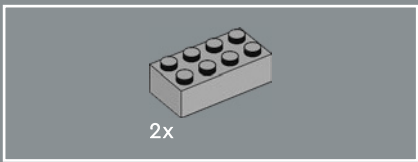

235

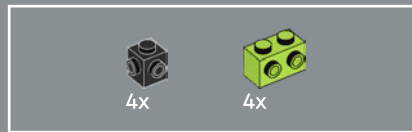
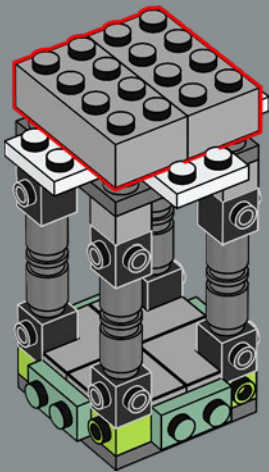

236

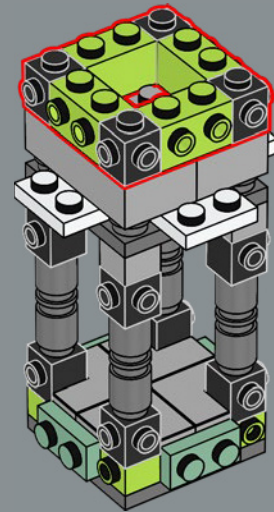

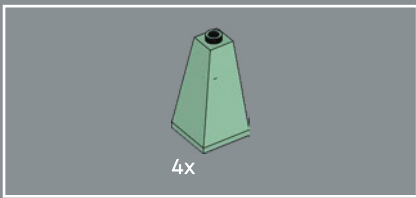

237

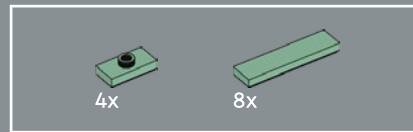
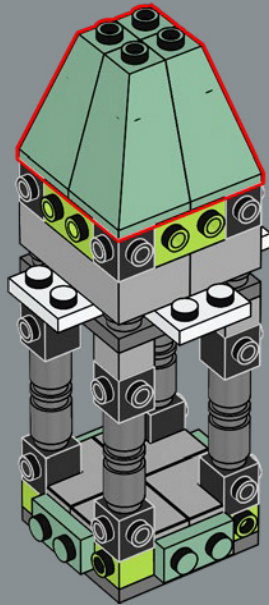

238

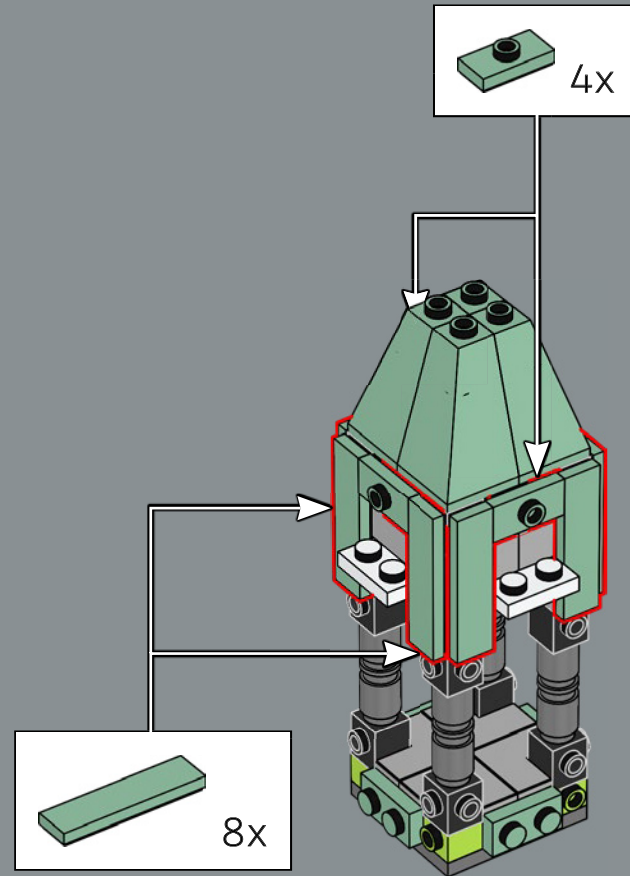

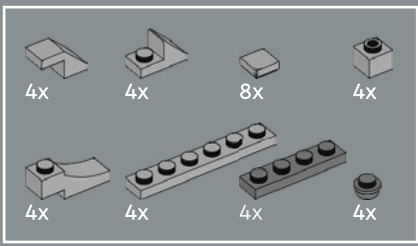

239

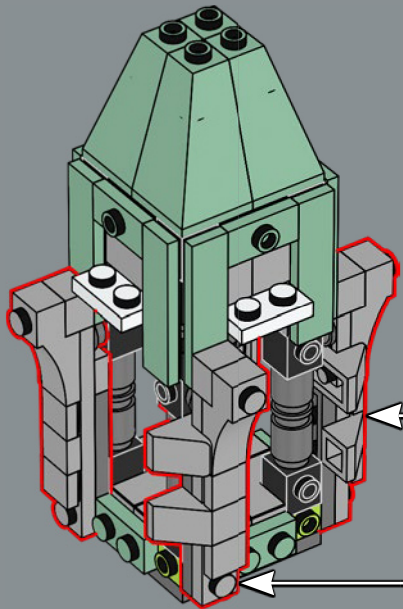
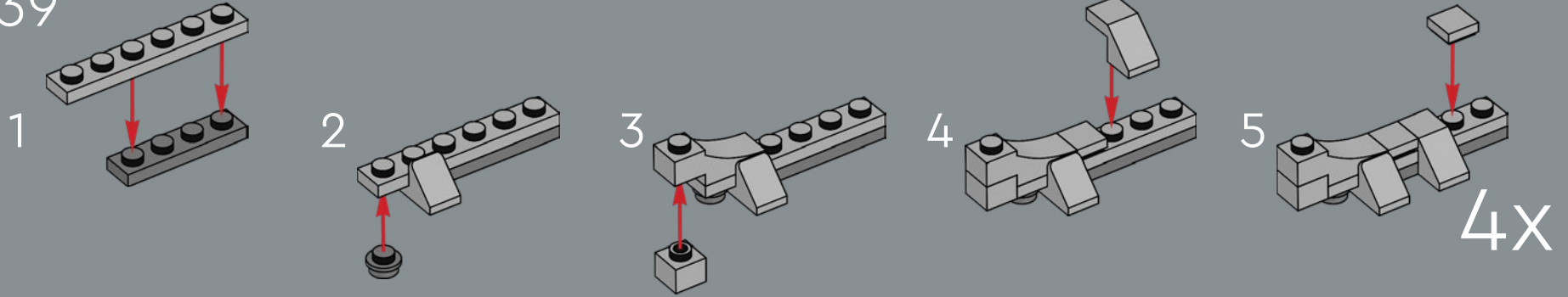

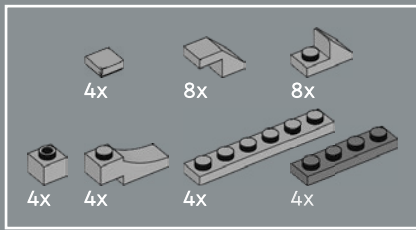

240

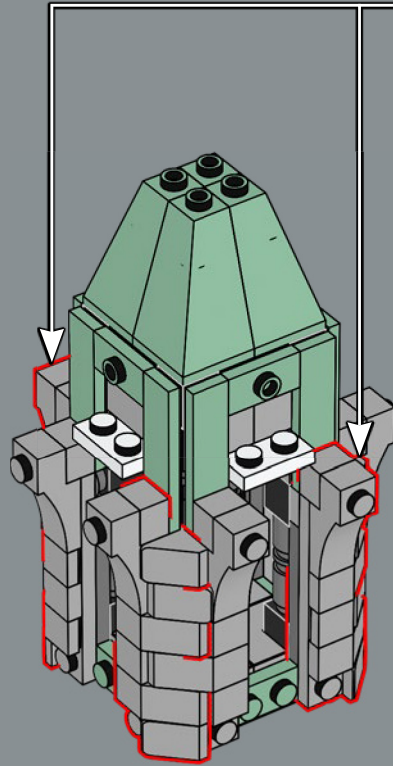
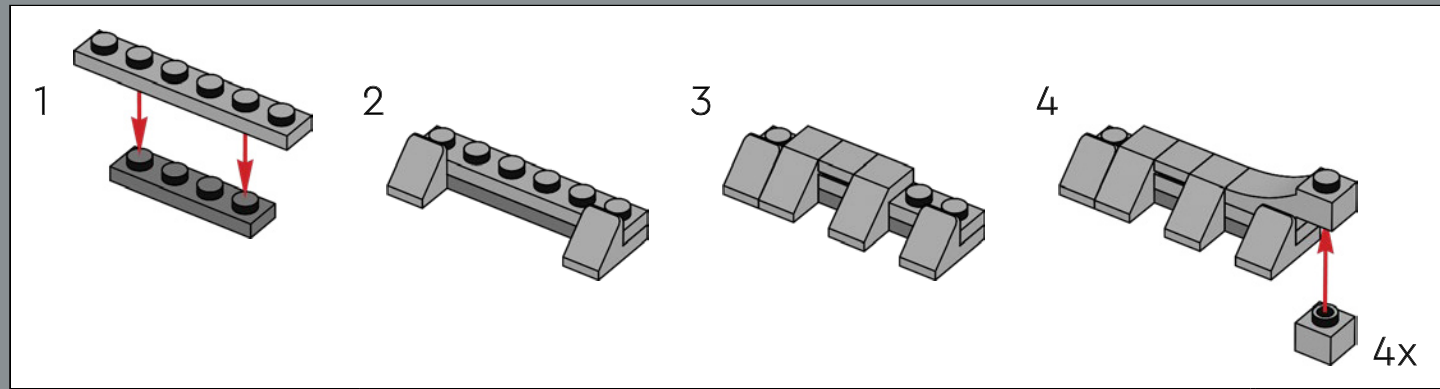



241

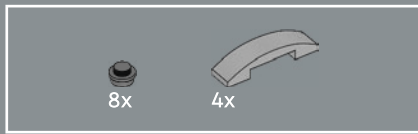
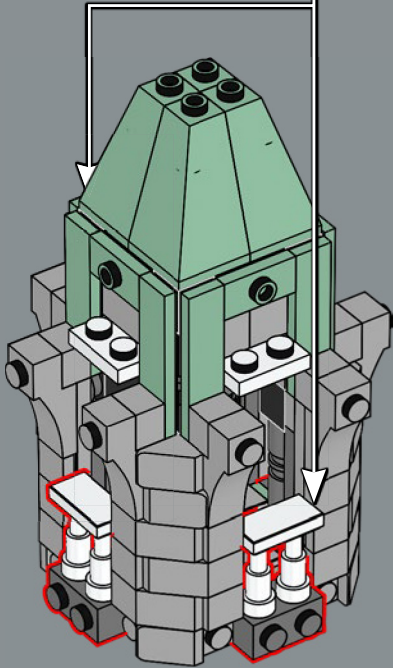
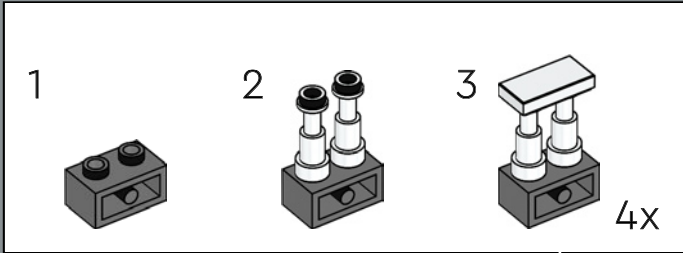

242

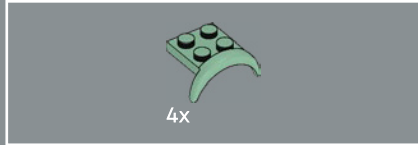
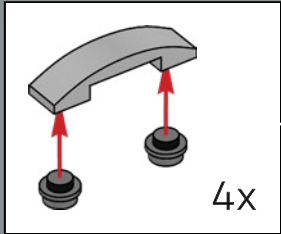

243

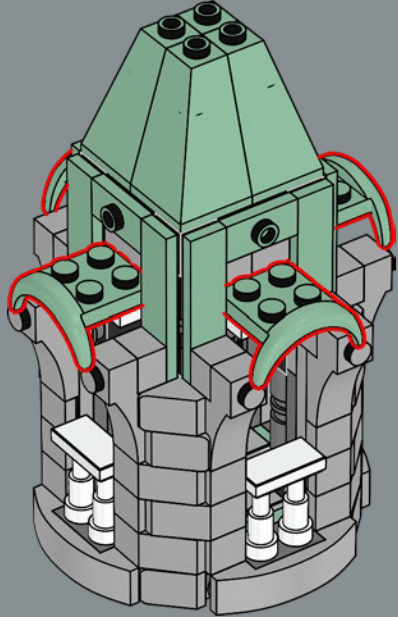
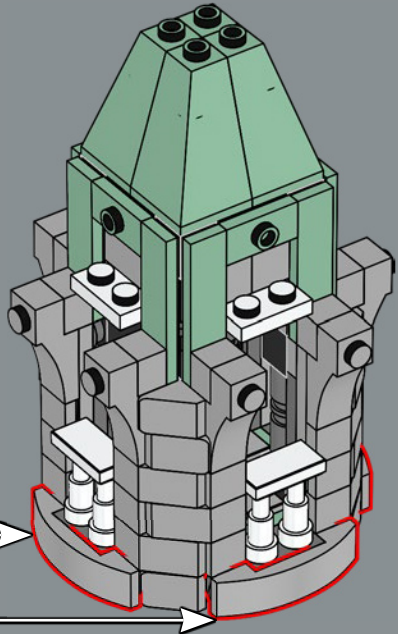

L'elemento verde utilizzato come parte superiore di questo arco finestra è stato originariamente sviluppato come passaruota per un'auto.

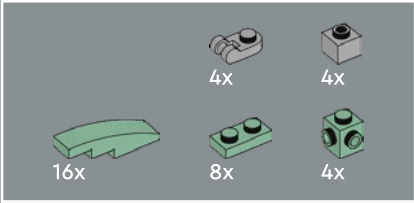

244

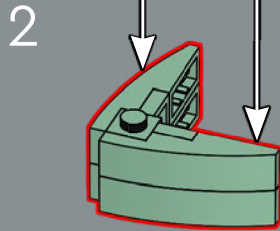
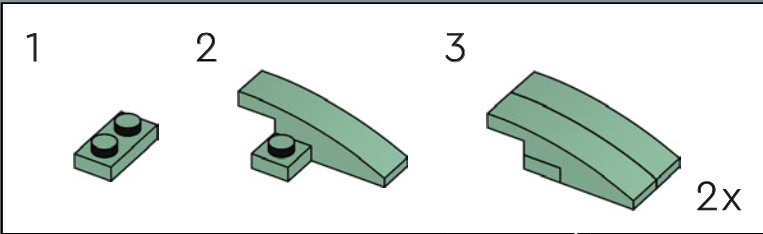
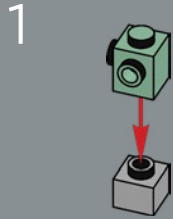

3

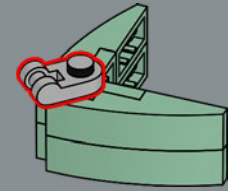

4x

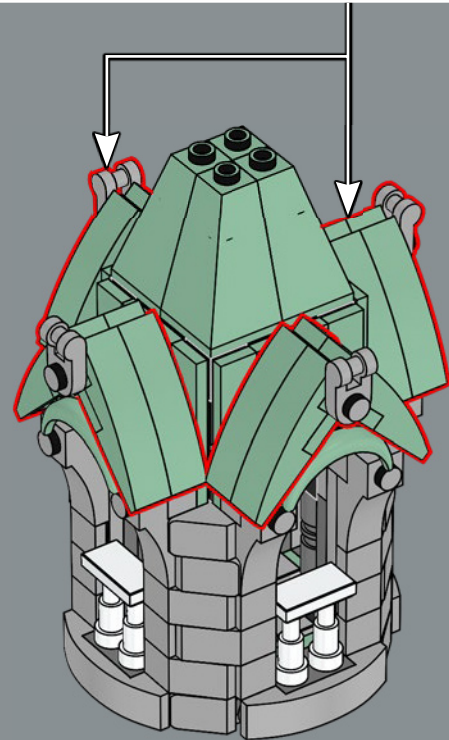



245

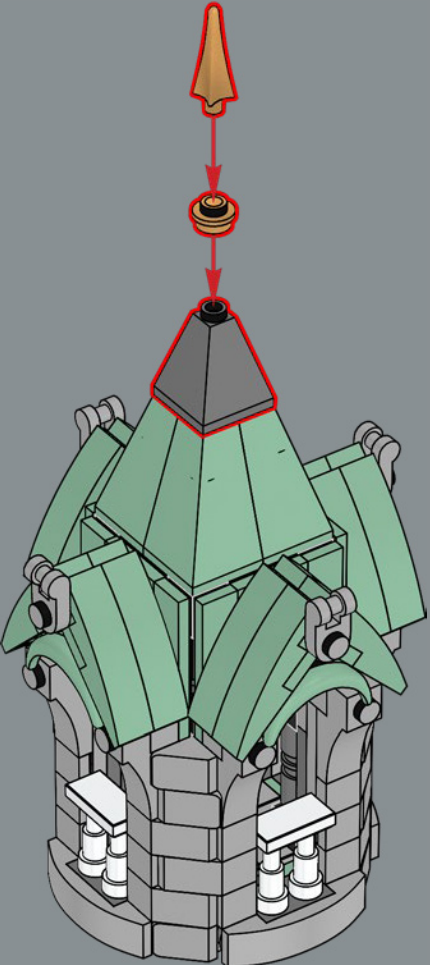

246

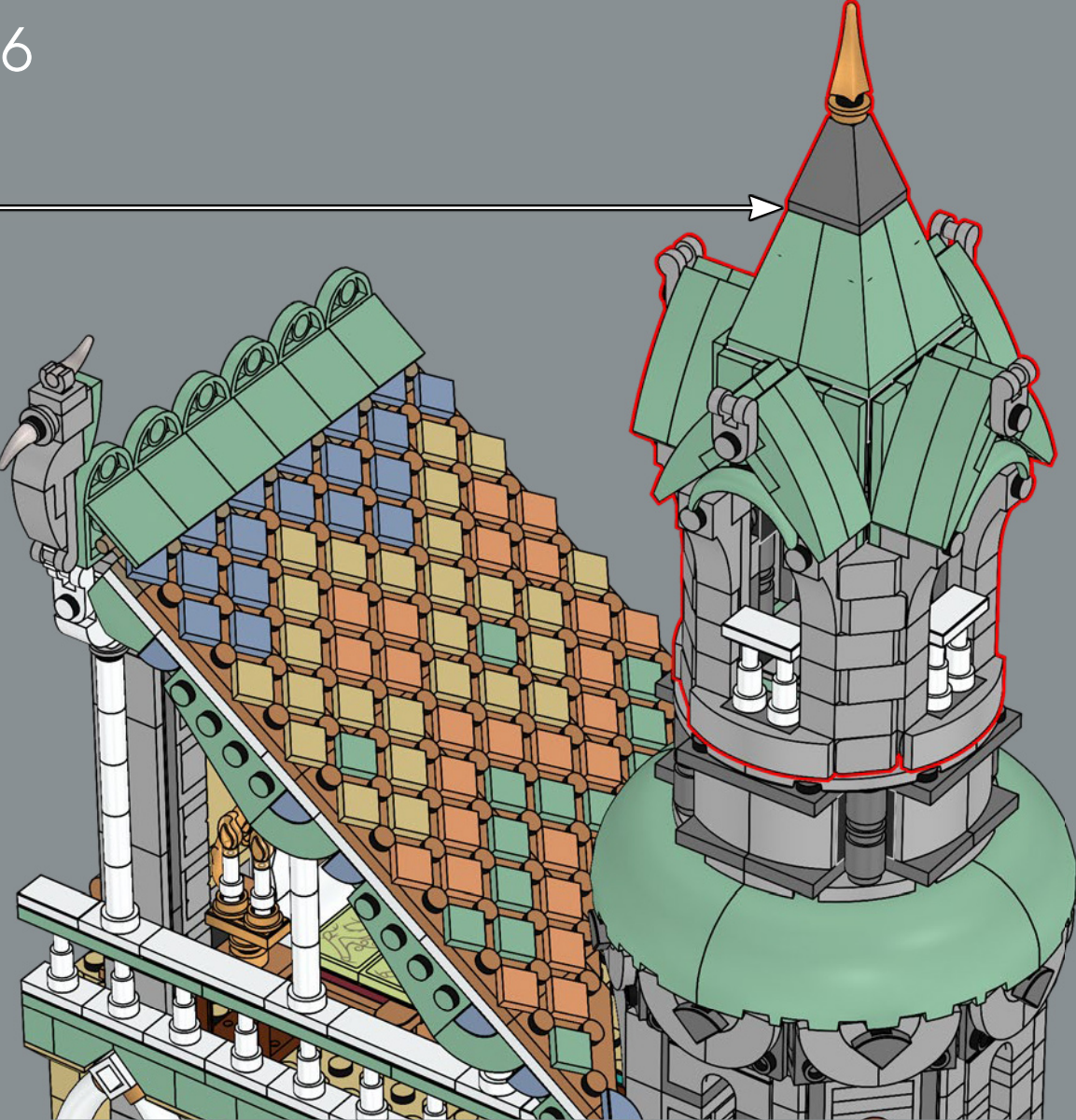

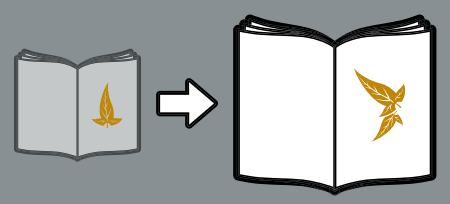

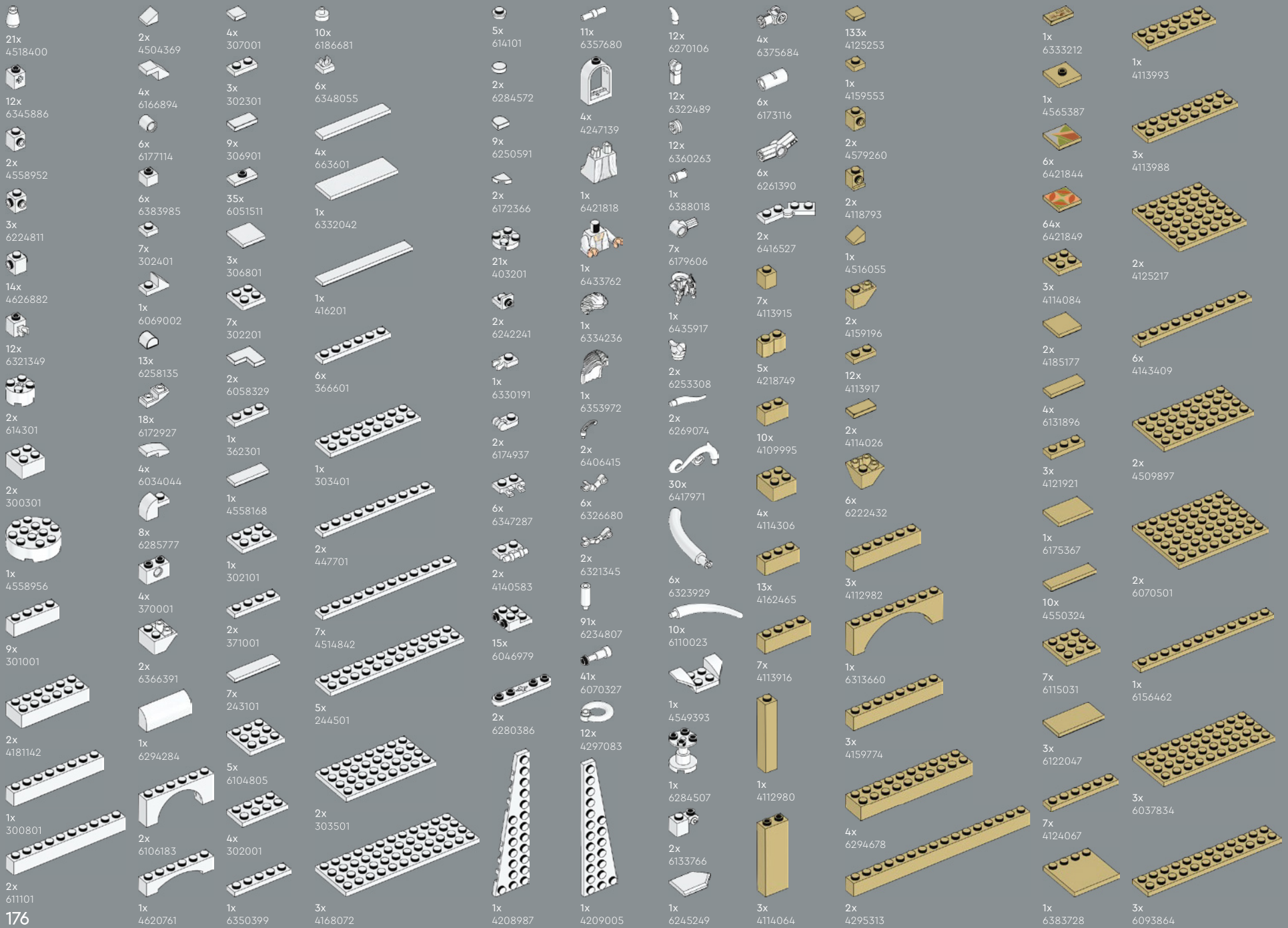

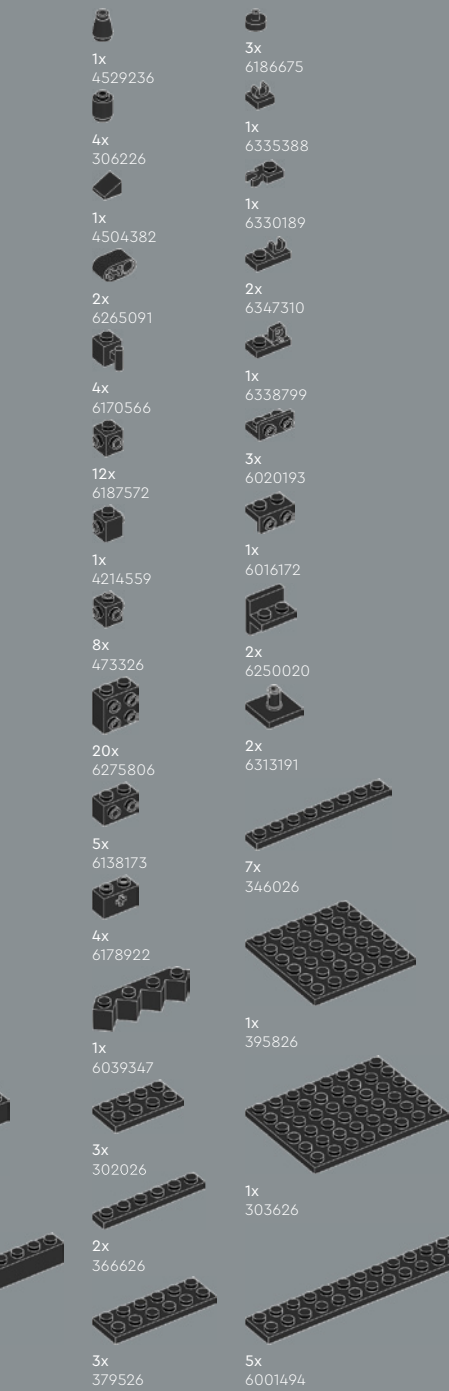
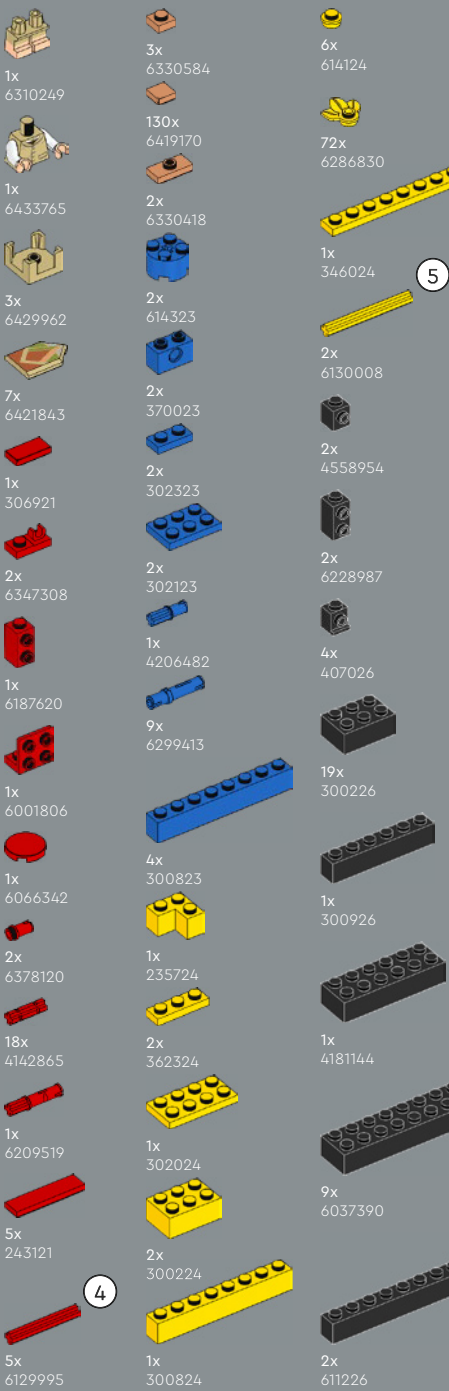
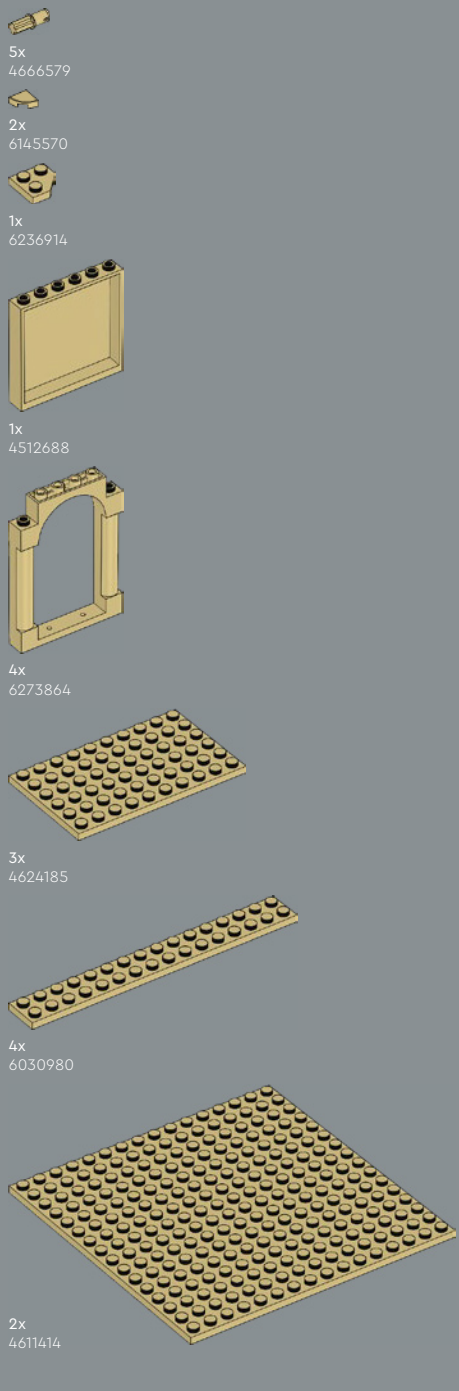





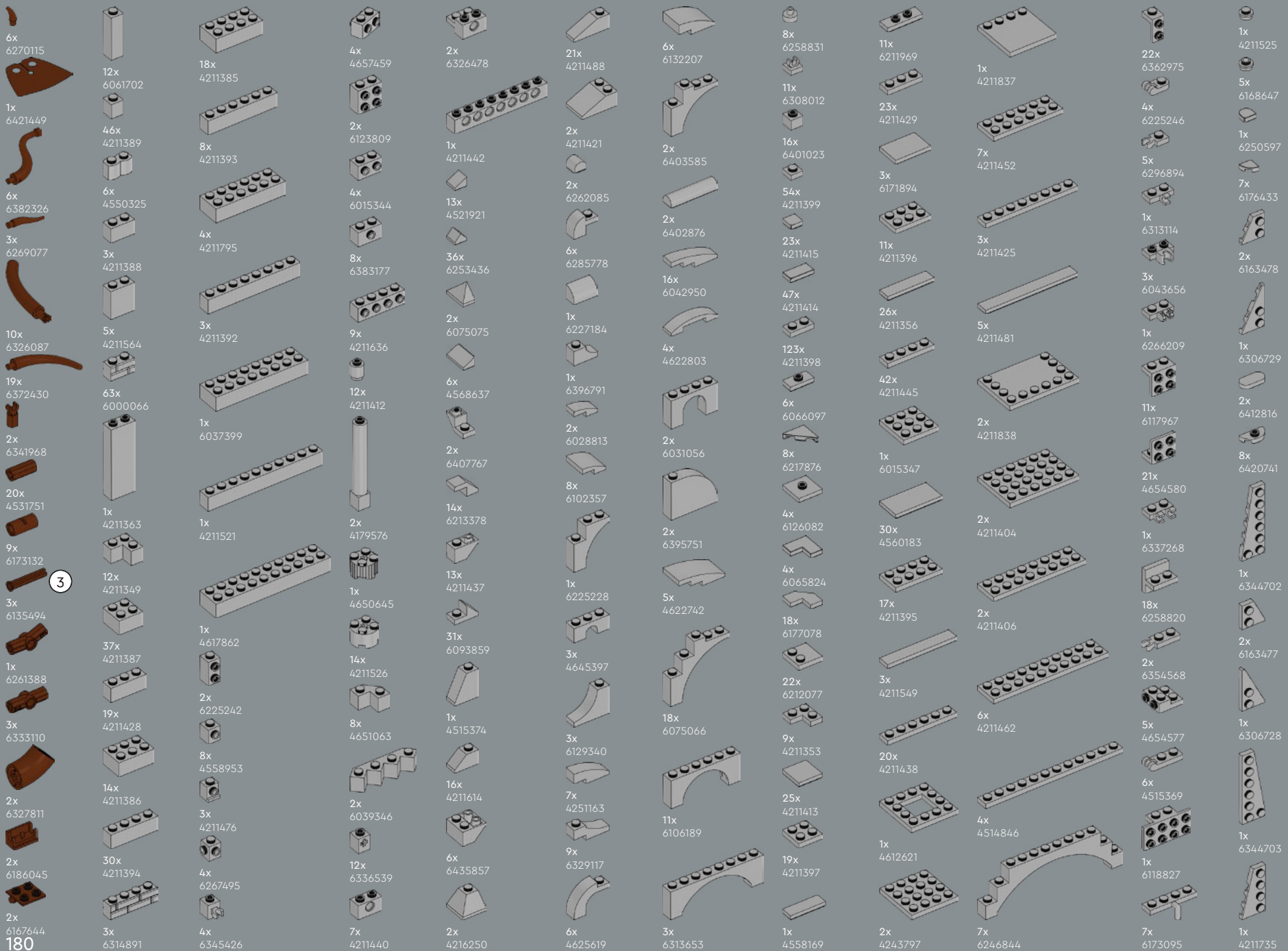

3



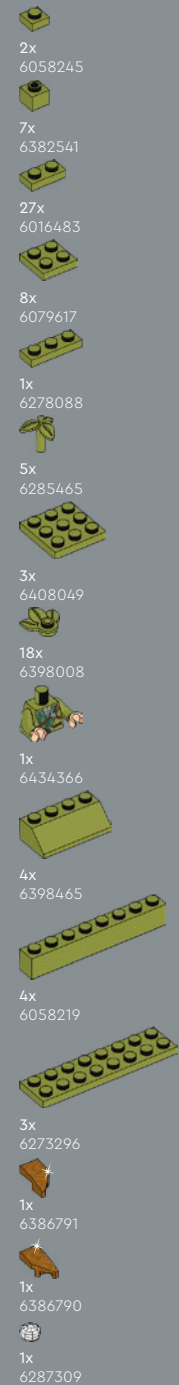
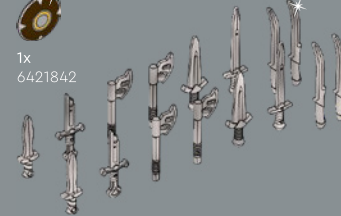
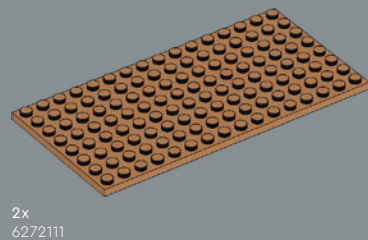

LEGO.com/service



YOU COULD WIN



YOU COULD WIN

Your feedback will help shape the future development of this product series.

Visit:

DU KÖNNTEST GEWINNEN

Dein Feedback trägt zur Weiterentwicklung dieser Produktreihe bei.

Geh auf:

VOUS POURRIEZ GAGNER

Vos commentaires nous aideront à concevoir les futurs produits de cette gamme.

Visitez :

POTRESTI VINCERE TU

La tua opinione ci aiuterà a migliorare la creazione futura di questa linea di prodotti.

Visita:

PUEDES GANAR

Tu opinión contribuirá al futuro de esta serie de productos.

Visita:

轻松获奖

您的反馈将有助于我们在今后改进本产品系列。

请访问:

[LEGO.com/productfeedback](https://www.lego.com/productfeedback)

You also have the chance to win a LEGO® set.

Terms and conditions apply.*

Außerdem hast du die Chance, ein LEGO® Set zu gewinnen.

Es gelten die Teilnahmebedingungen.*

Vous pourriez également gagner un ensemble LEGO®.

Des conditions s'appliquent.*

Hai anche la possibilità di vincere un set LEGO®.

Termini e condizioni sono applicabili.*

También tienes la oportunidad de ganar un set LEGO®.

Aplican términos y condiciones.*

您还有机会赢取乐高®套装。

条款和条件适用。*

*[LEGO.com/productfeedback-terms](https://www.lego.com/productfeedback-terms)

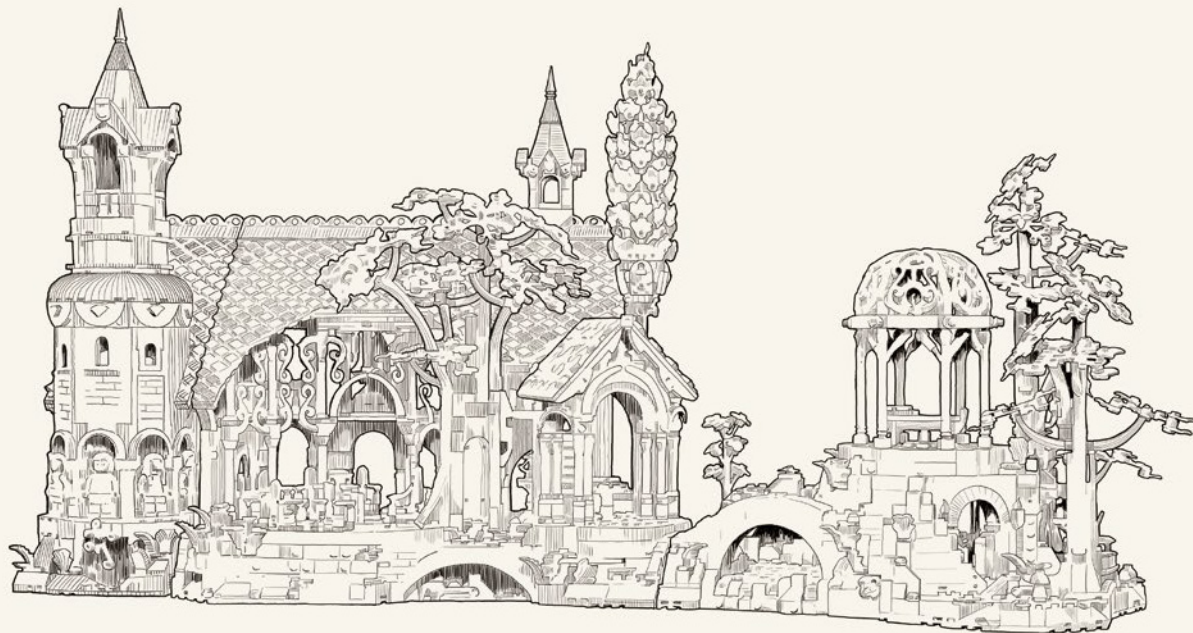

LEGO and the LEGO logo are trademarks of the LEGO Group. ©2023 The LEGO Group.

© 2023 New Line Productions, Inc. All rights reserved. The Lord of the Rings: The Fellowship of the Ring, The Lord of the Rings: The Two Towers, The Lord of the Rings: The Return of the King and the names of the characters, items, events and places therein are trademarks of The Saul Zaentz Company d/b/a Middle-earth Enterprises under license to New Line Productions, Inc. (s23)