





## FLUSS, SCHMIEDE UND WAFFENKAMMER

Bilbo und Frodo treffen sich im Pavillon. Als die vom Rat eingeladenen Gesandten eintreffen, geben sie ihre Ausrüstung zur Aufbewahrung in der Waffenkammer an der Schmiede ab. Arwen und Aragorn treffen sich heimlich, bevor die Gemeinschaft zur ihrer gefährlichen Reise aufbricht.



*Arwen erscheint in ihrem Elben-Gewand und trägt ihren Abendstern-Anhänger, den sie Aragorn in Die Gefährten schenkt.*

**ARWEN**



*Gimli trägt seinen verzierten Helm und schwingt seine brandneuen Äxte. Gimli wurde größer als ein Hobbit und kleiner als ein Elbe dargestellt.*

**GIMLI**







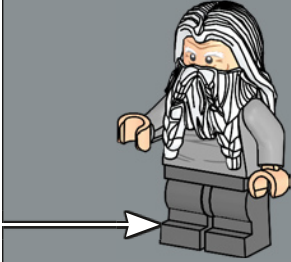
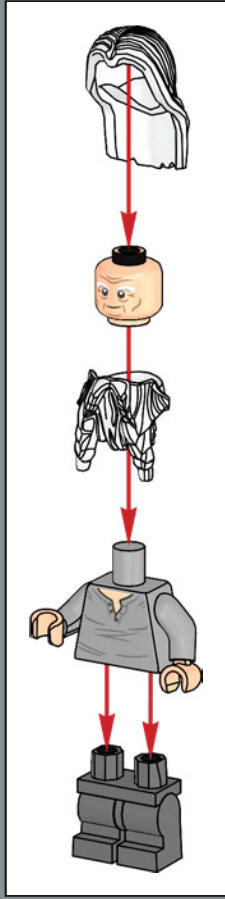
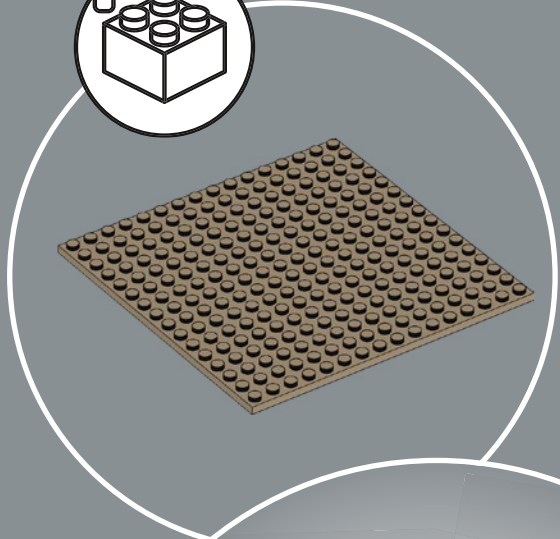
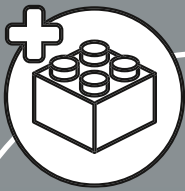

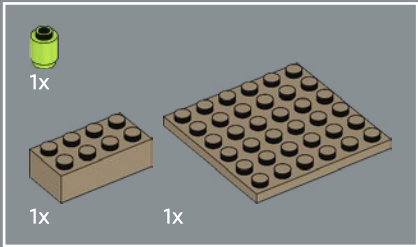
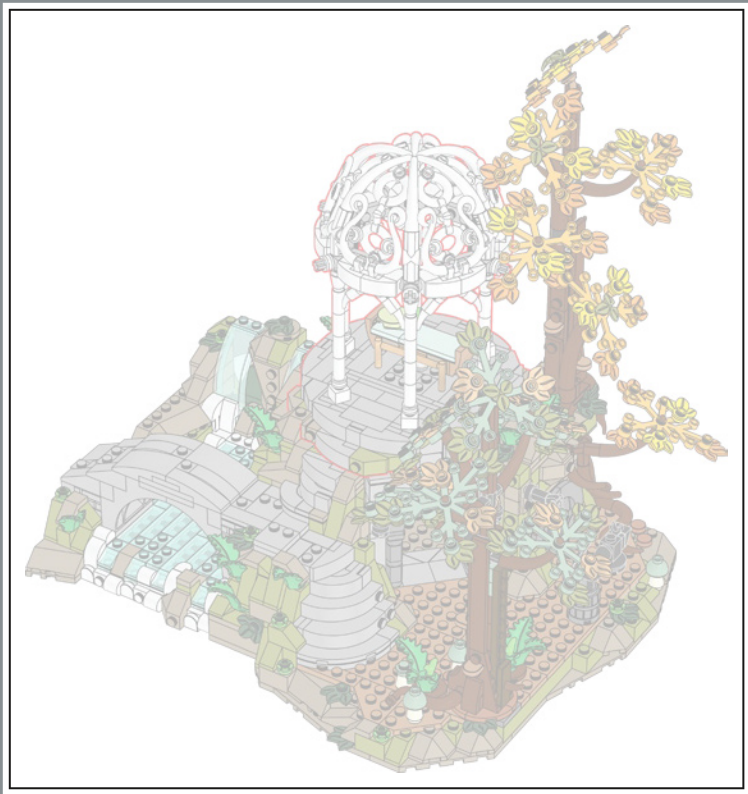

1

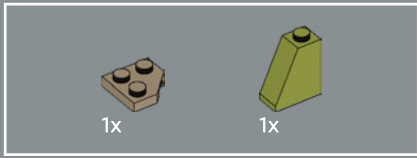
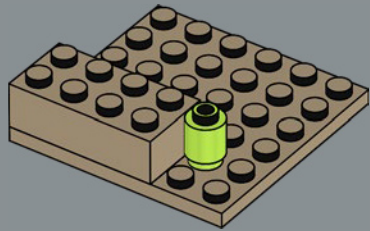

2

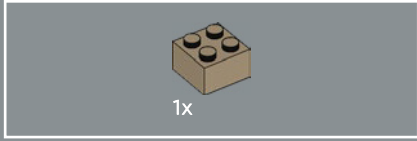
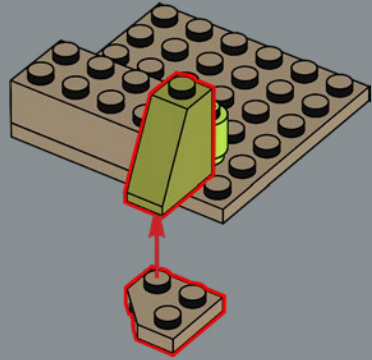

3

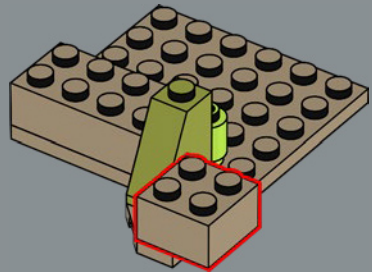

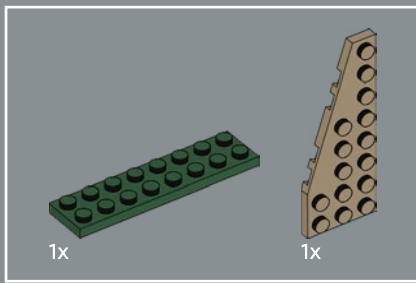

4

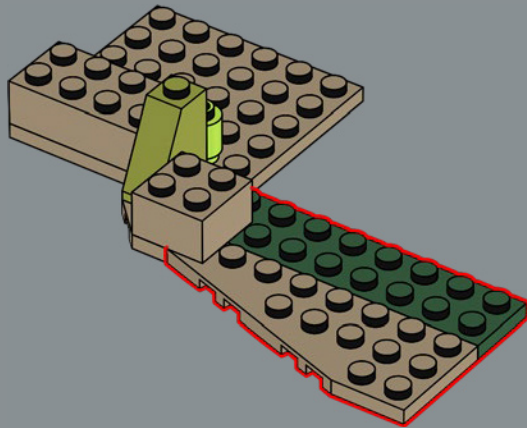

In dem Modell verwenden wir Dutzende linke und rechte Elemente, um eine Landschaft zu erschaffen, die ganz natürlich aussieht. Wir haben darauf geachtet, dass in dem Set jede Form in gleicher Zahl vorhanden ist. Findest du heraus, wo all diese Elemente versteckt sind?

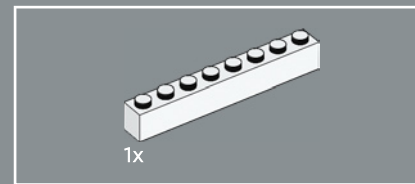

5

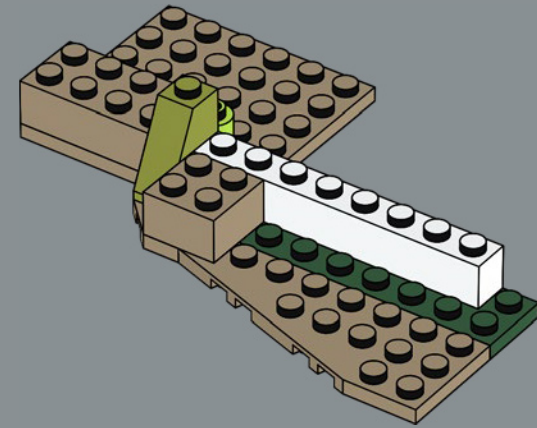

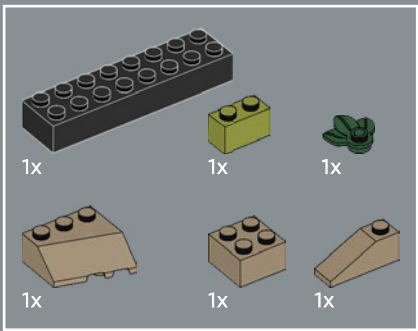

6

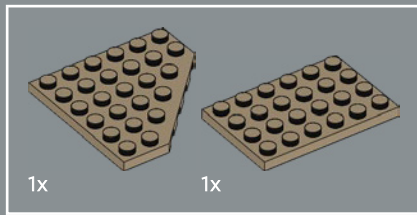
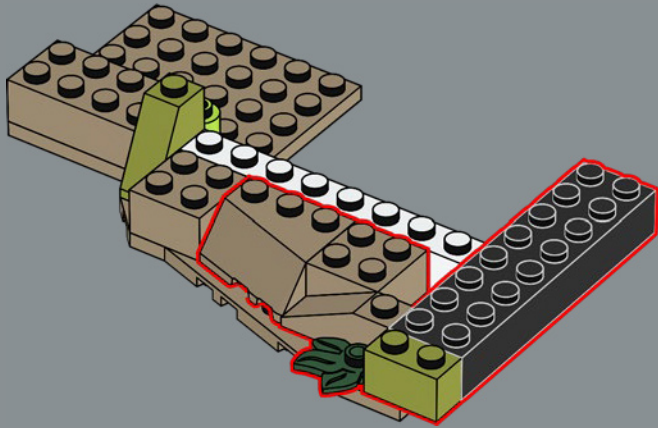

7

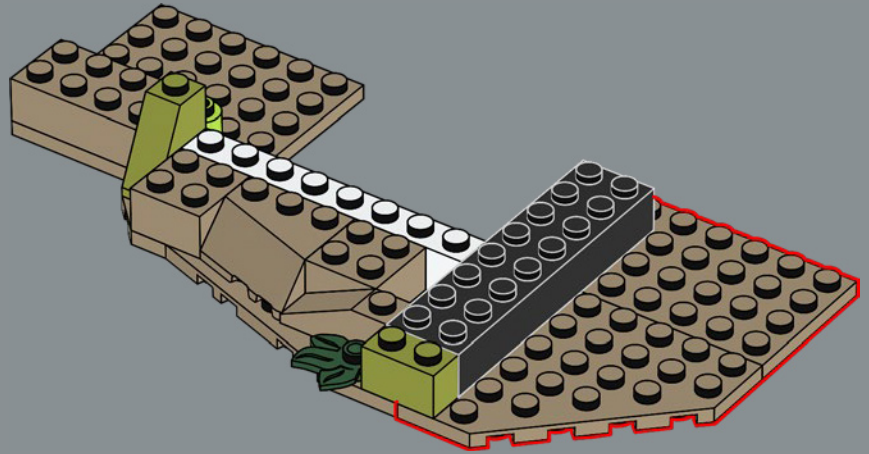



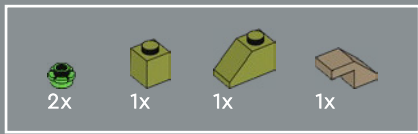

8

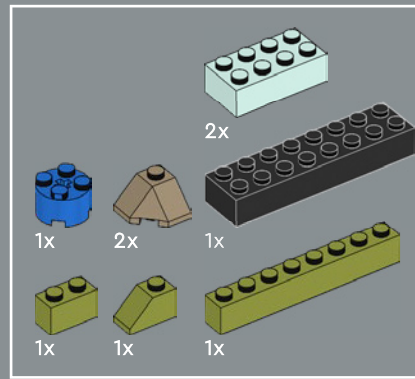
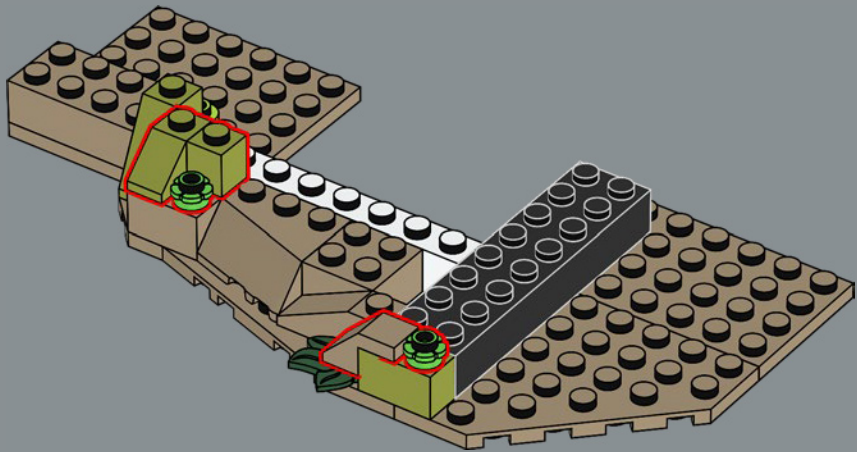

9

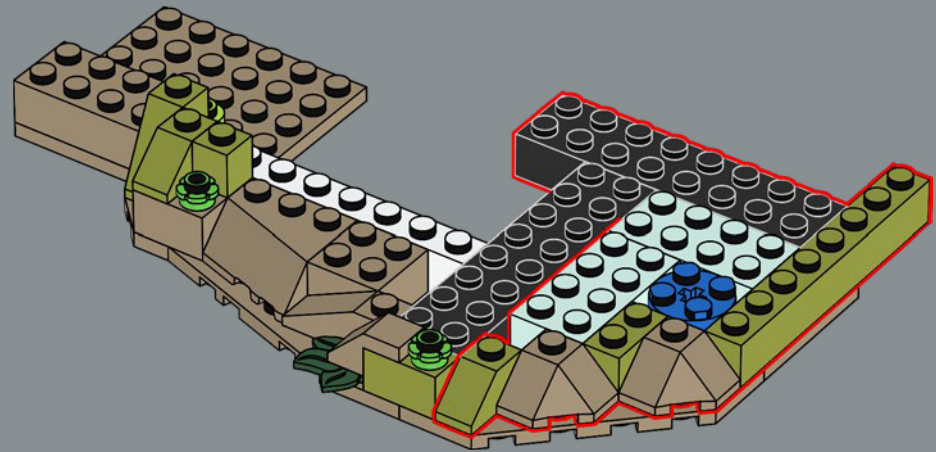

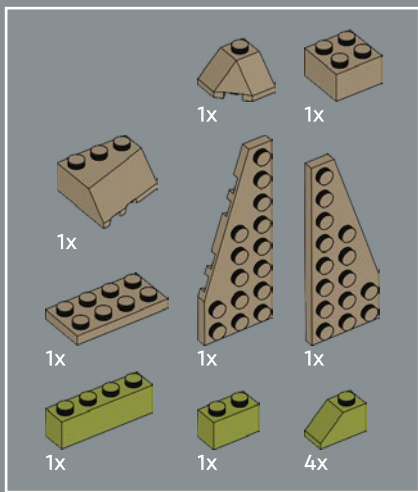

10

1

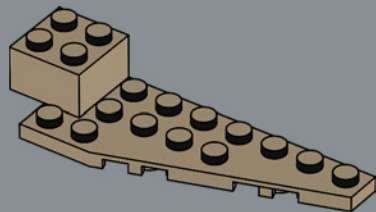

2

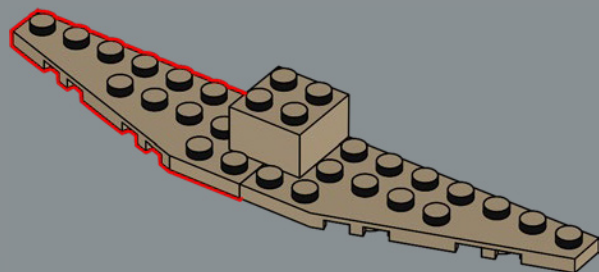

3

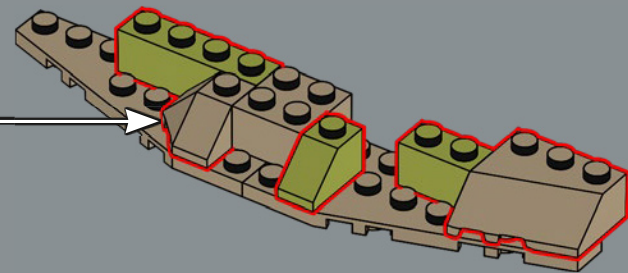

4

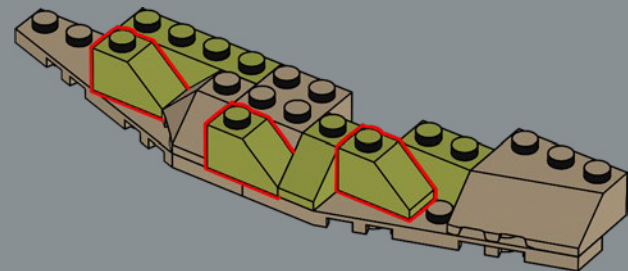

5

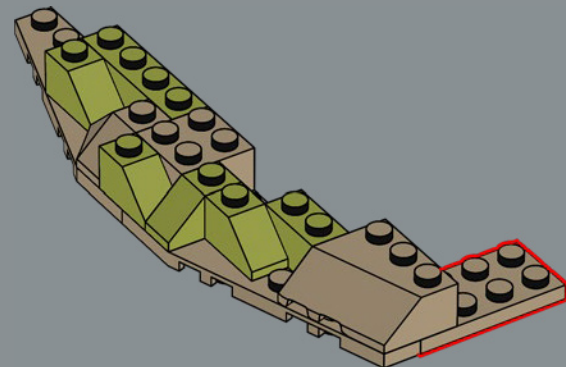

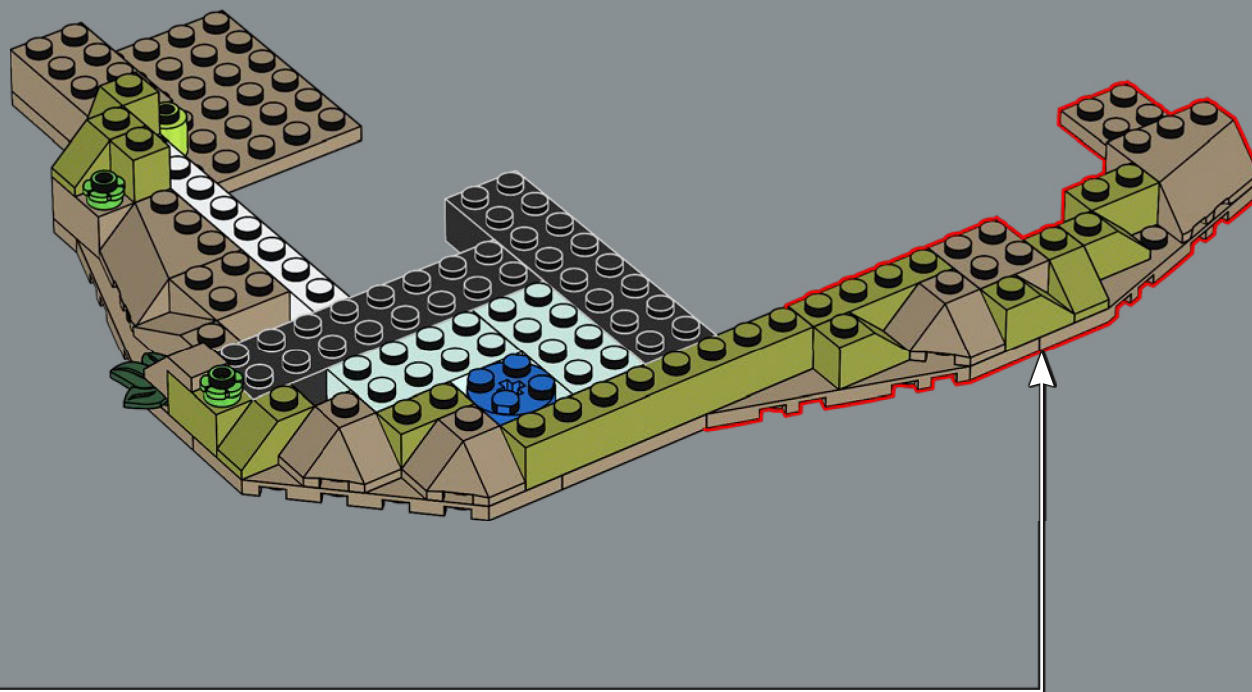



11

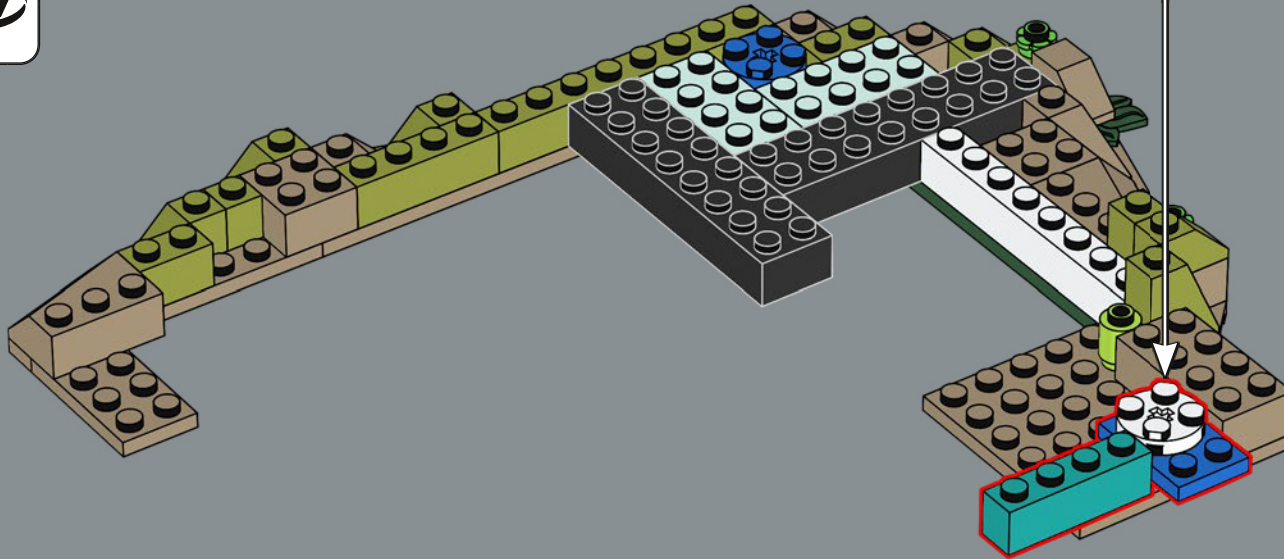
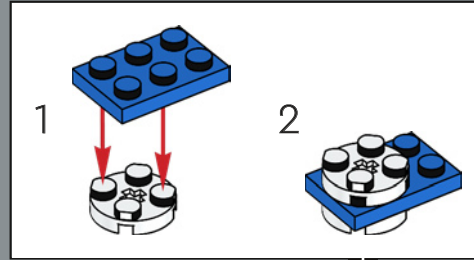

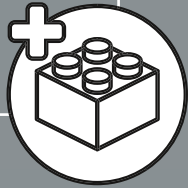
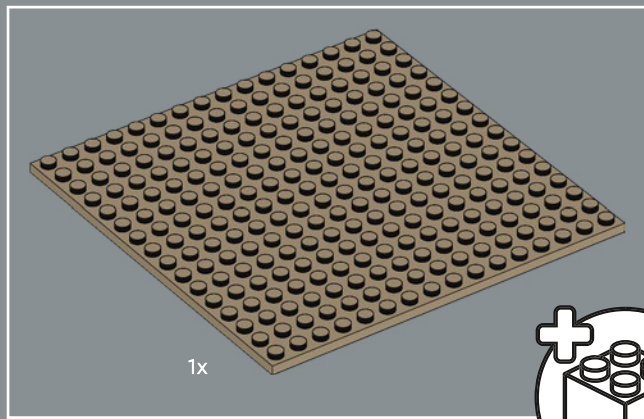

12

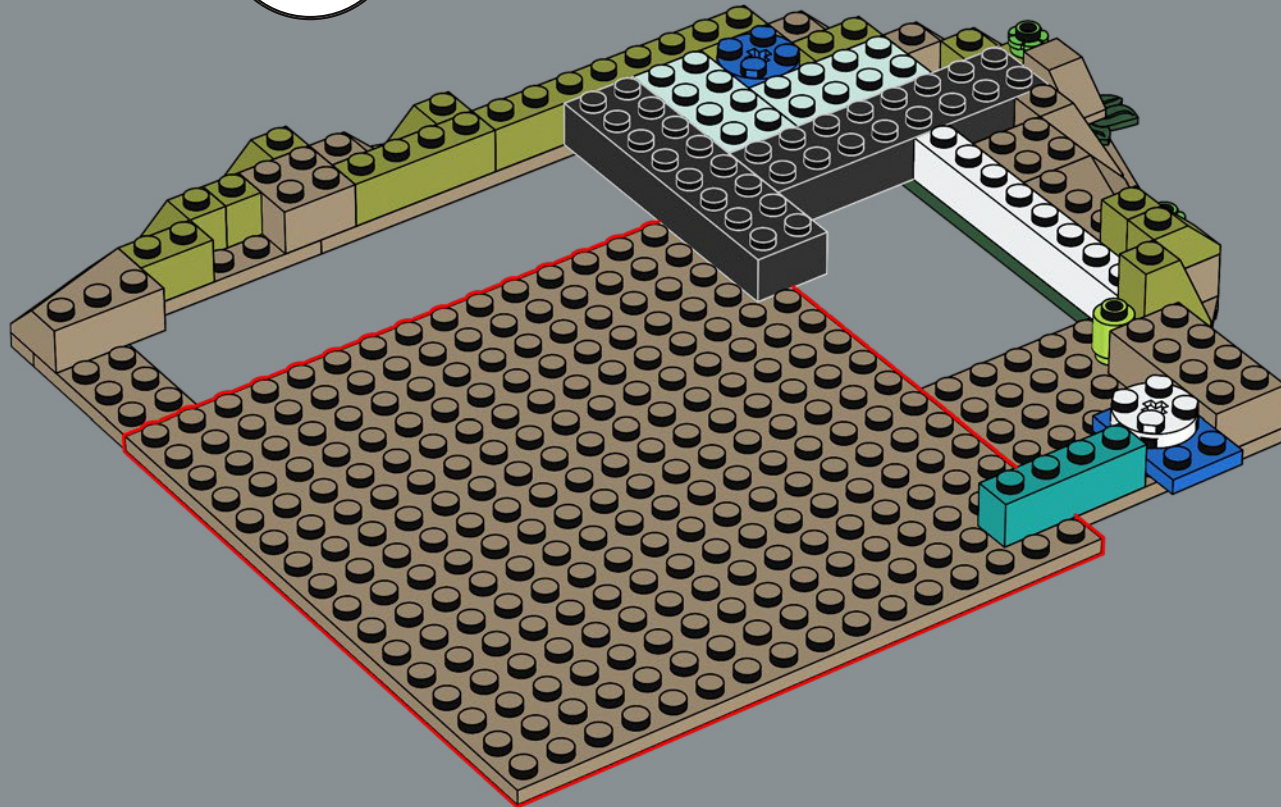

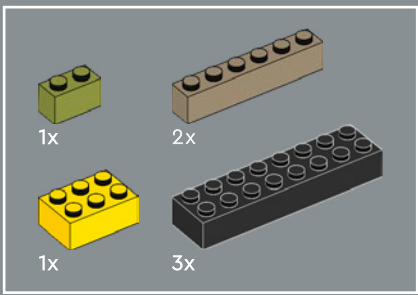

13

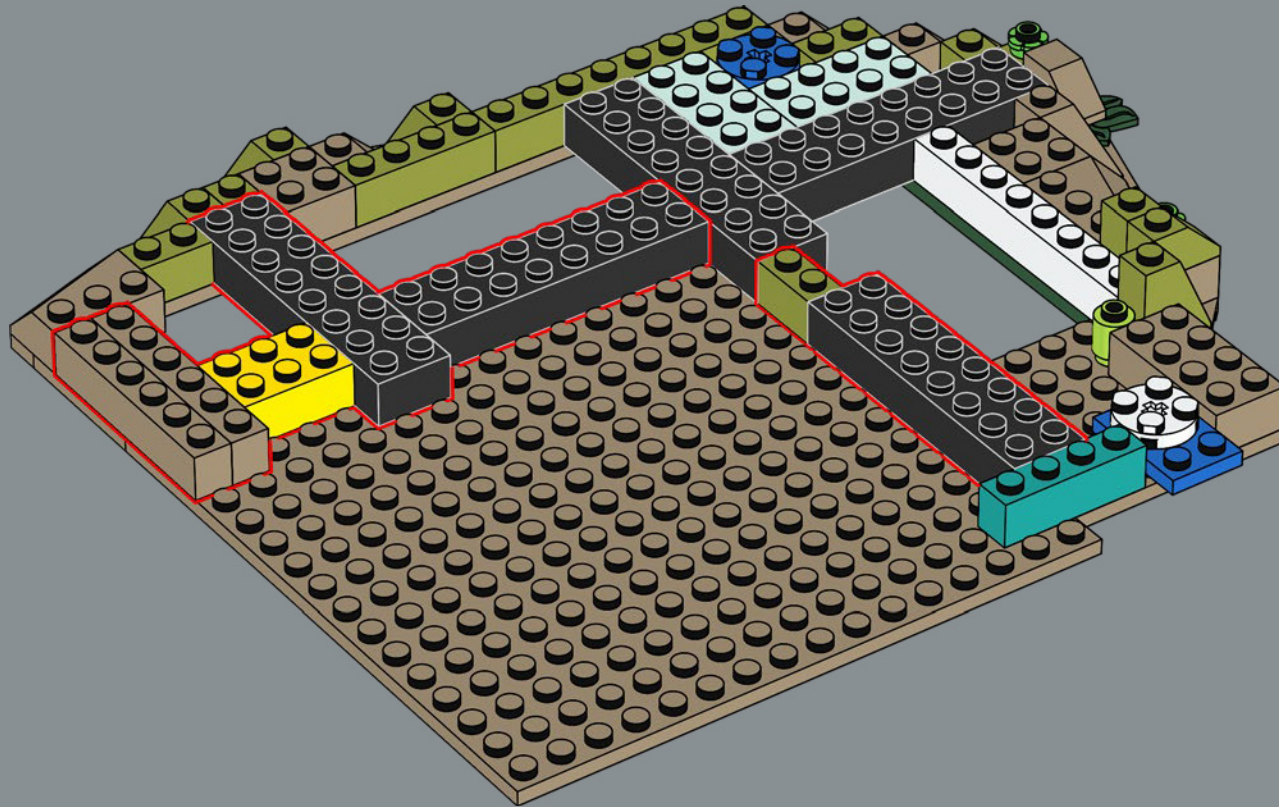

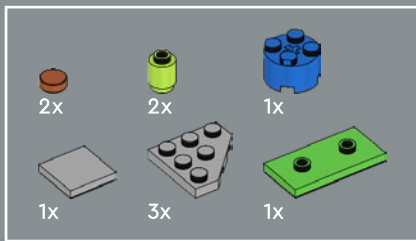

14

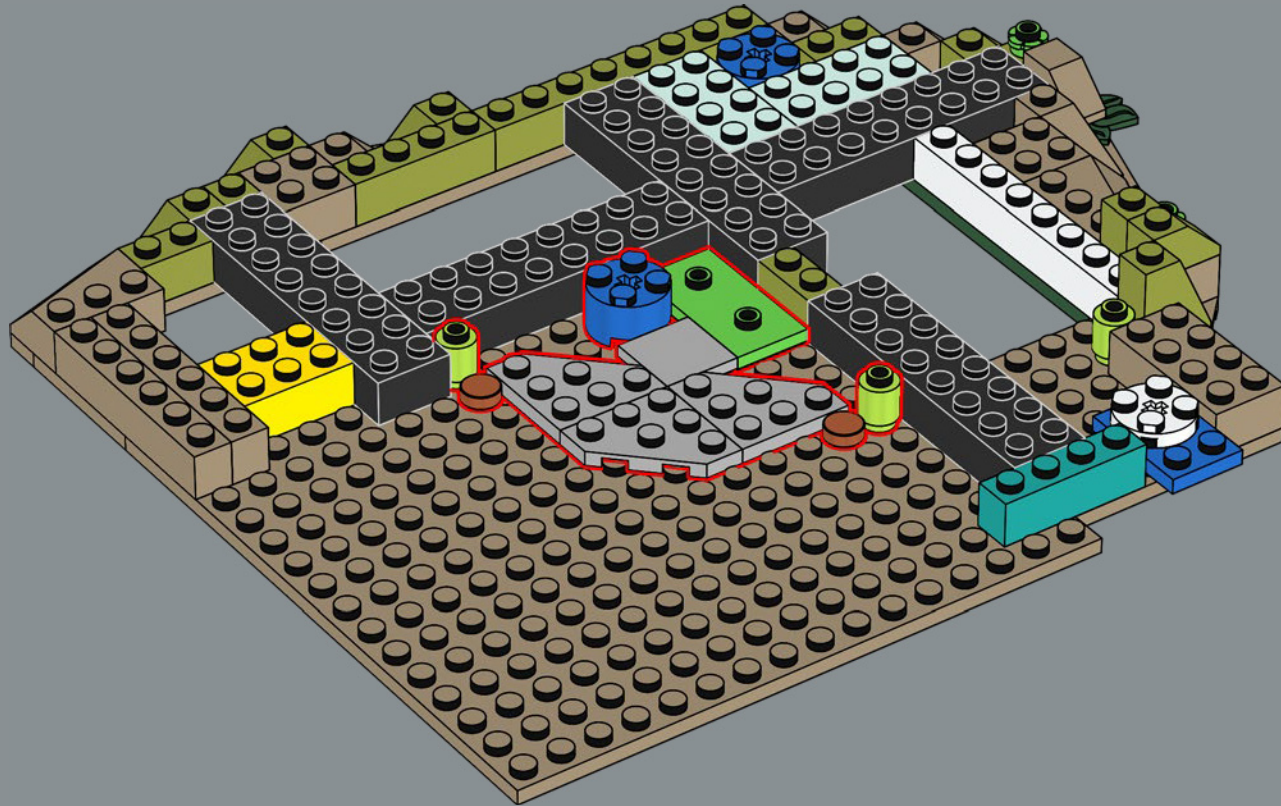

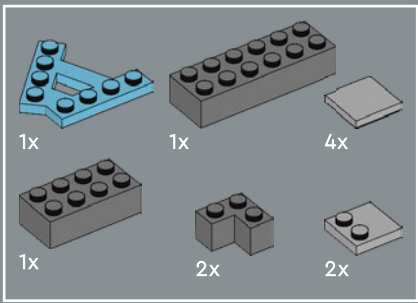

15

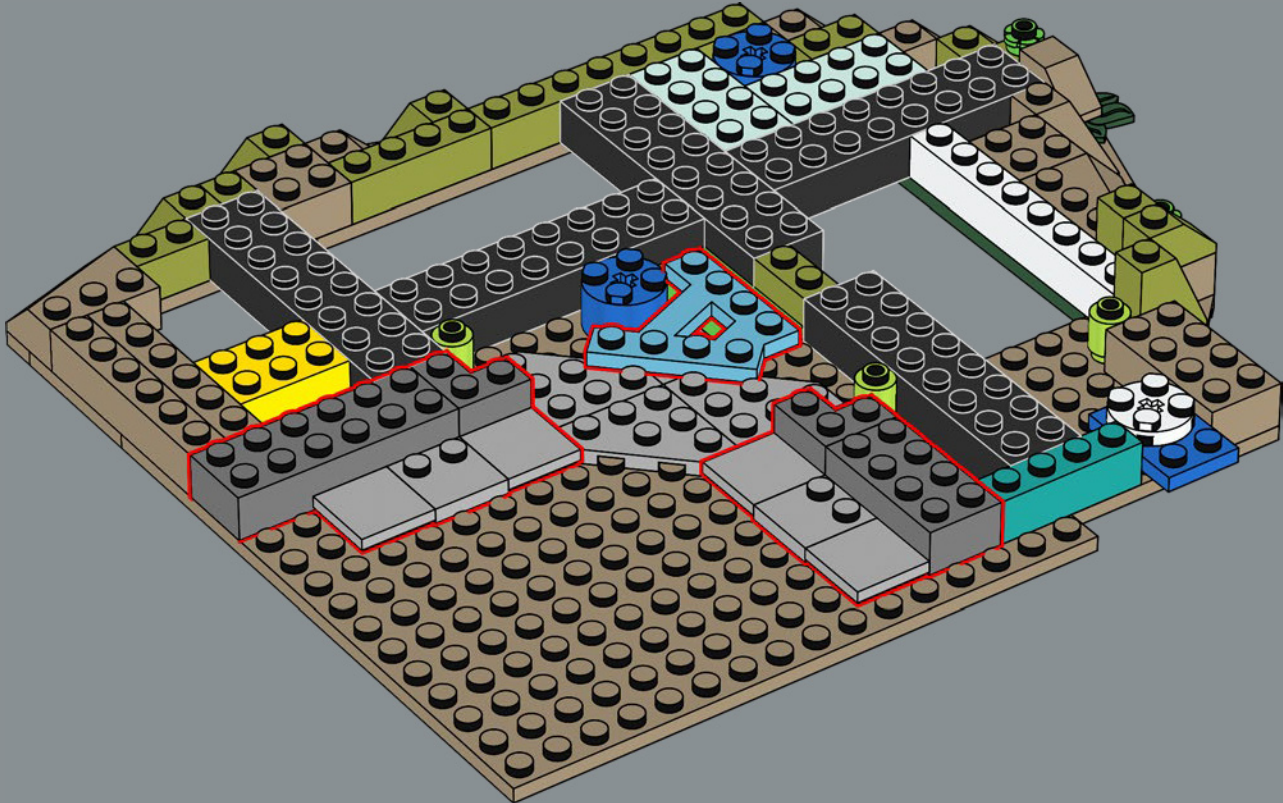





16

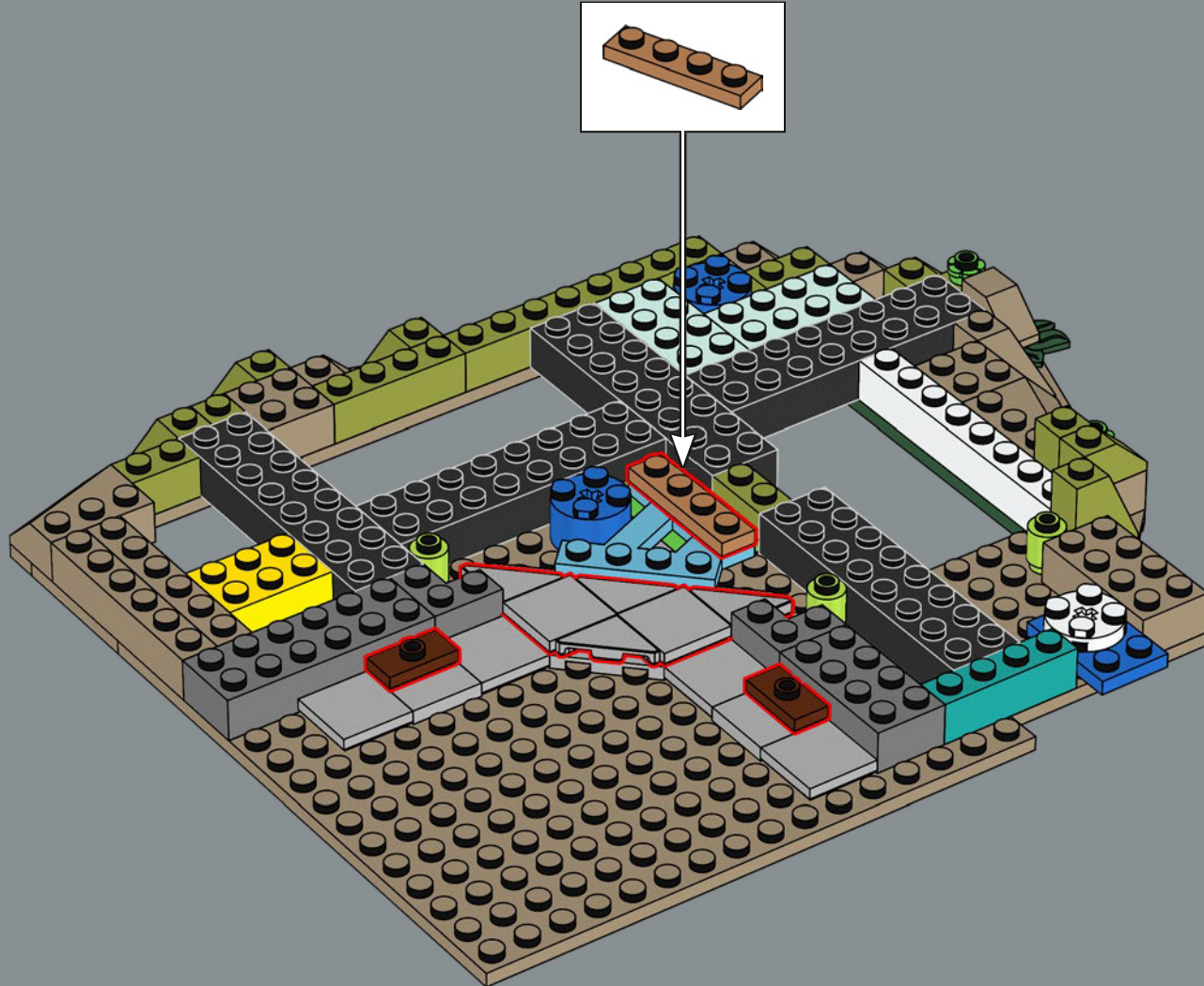

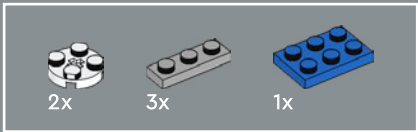

17

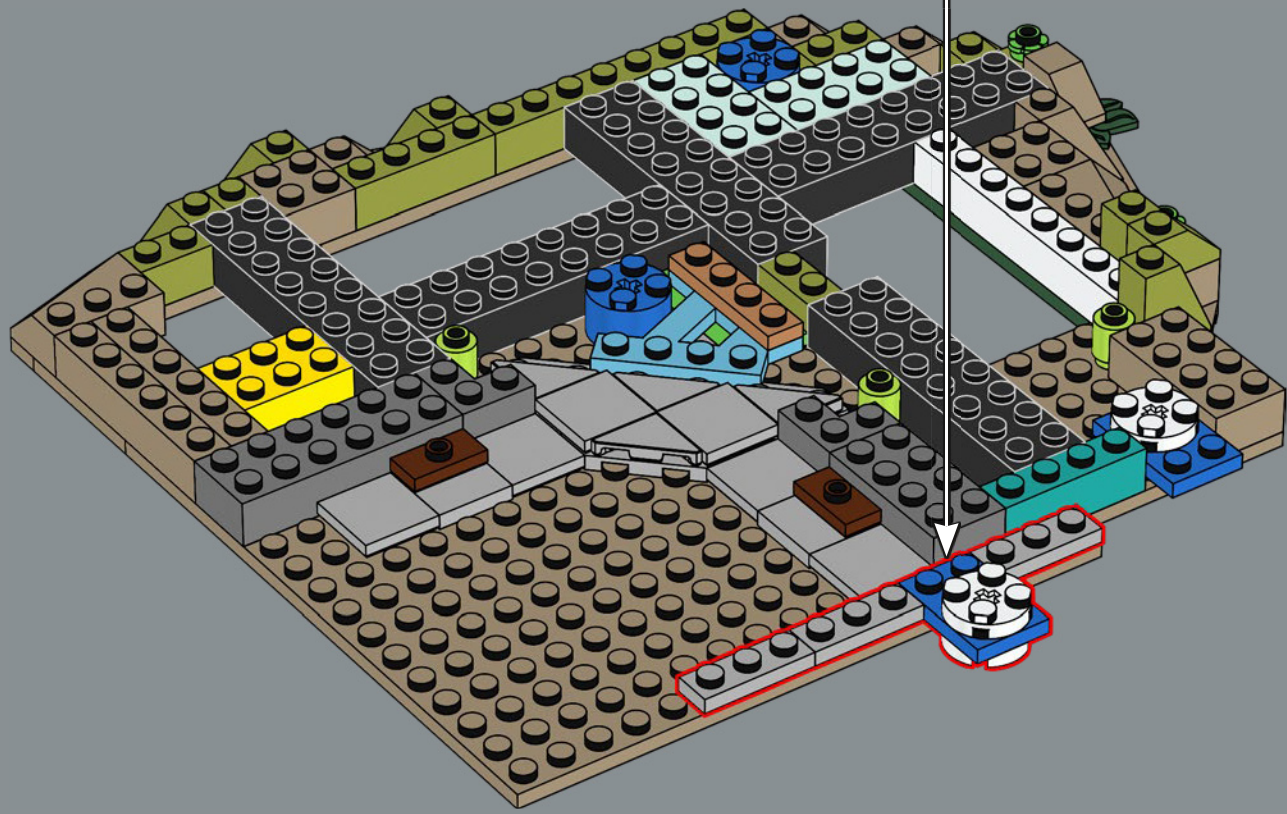
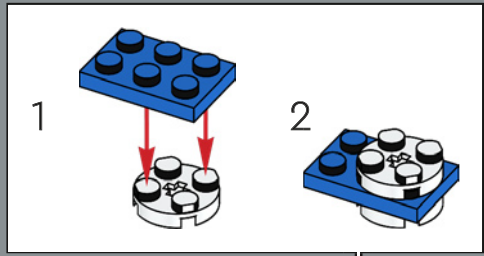

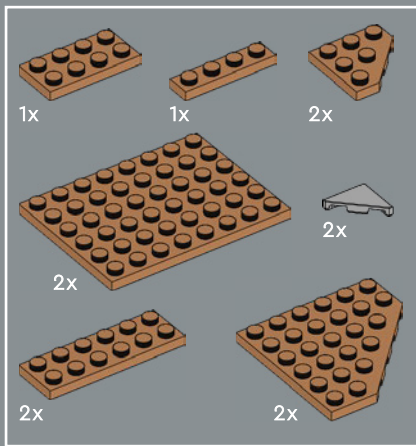

18

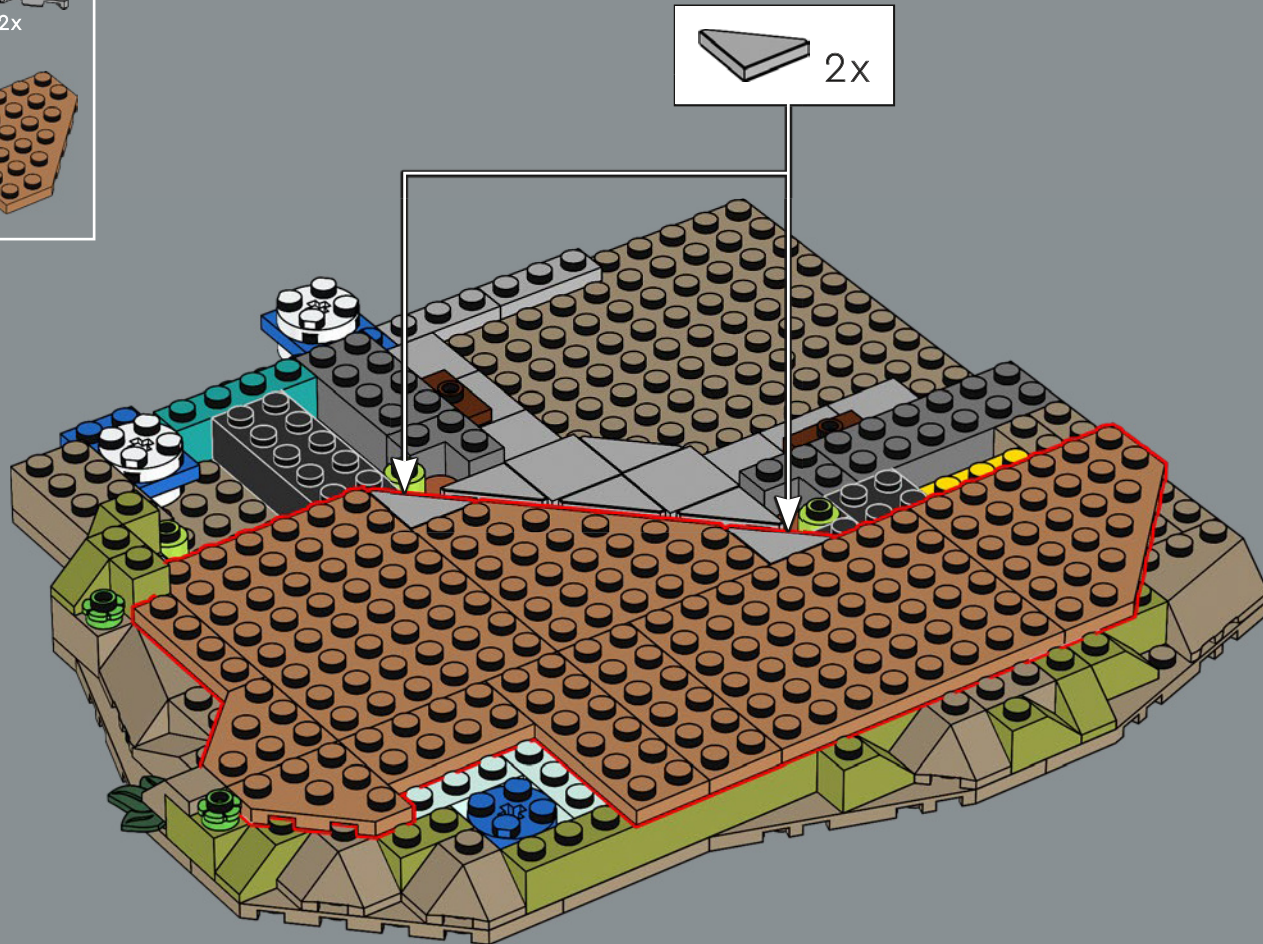

- 2x 
- 1x 
- 2x 
- 1x 
- 1x 

19

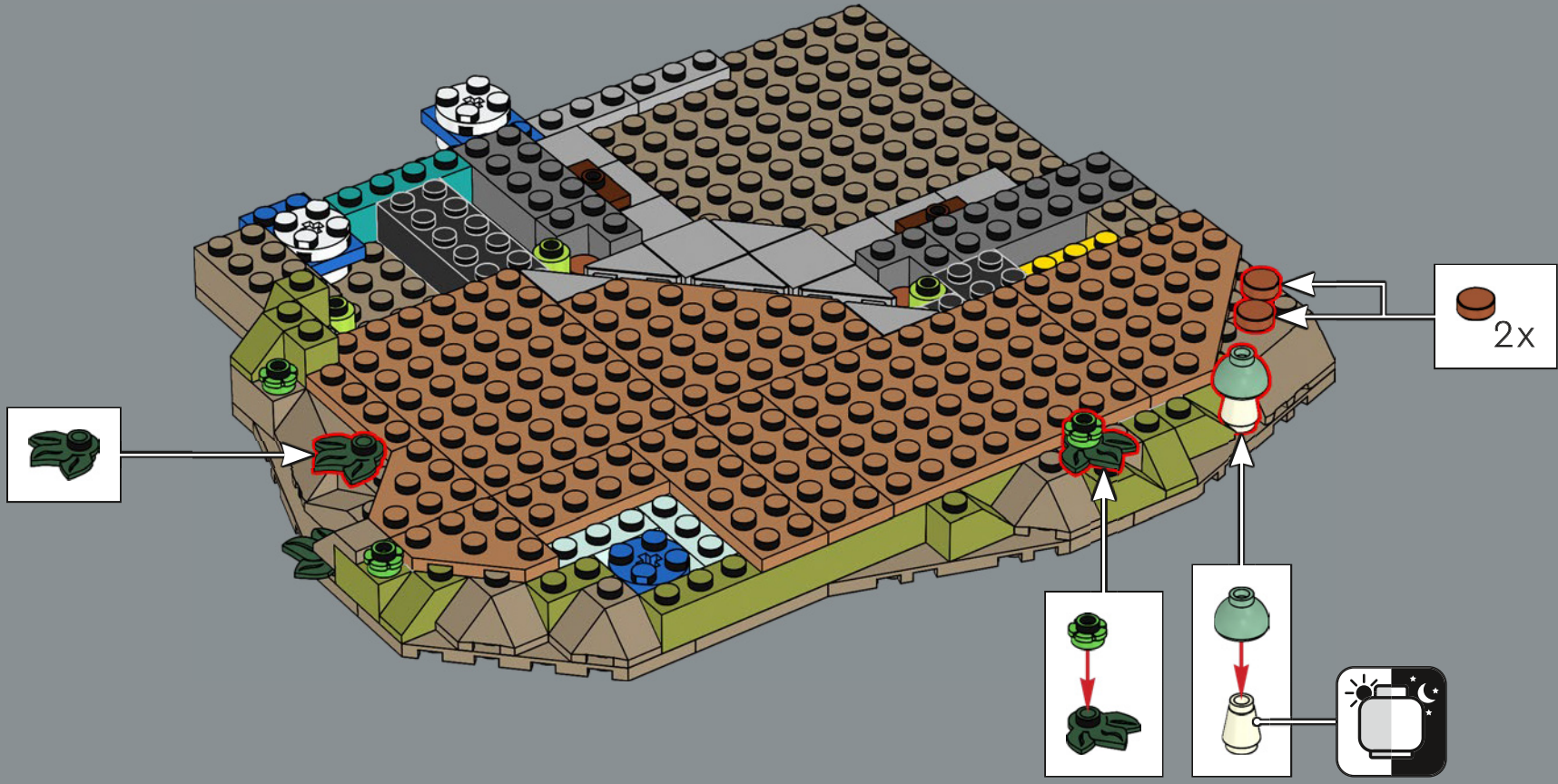

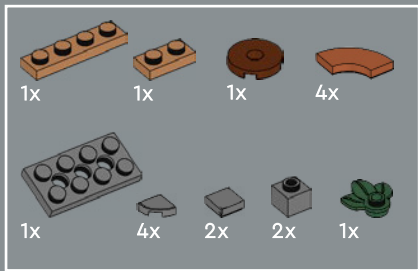

20

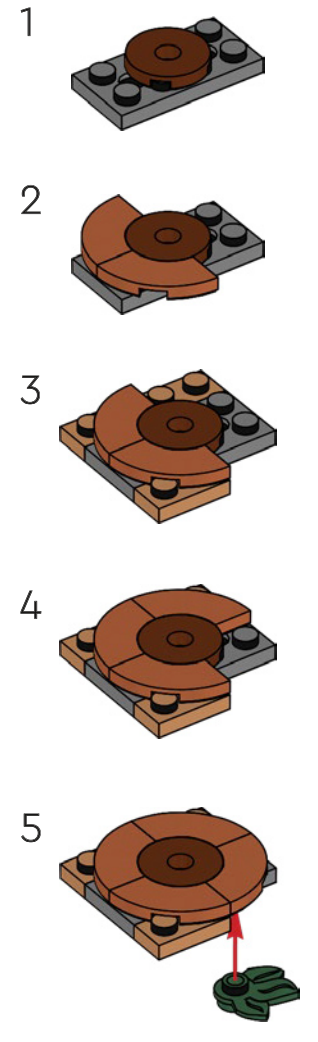
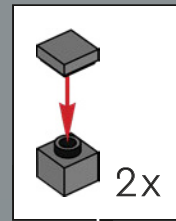
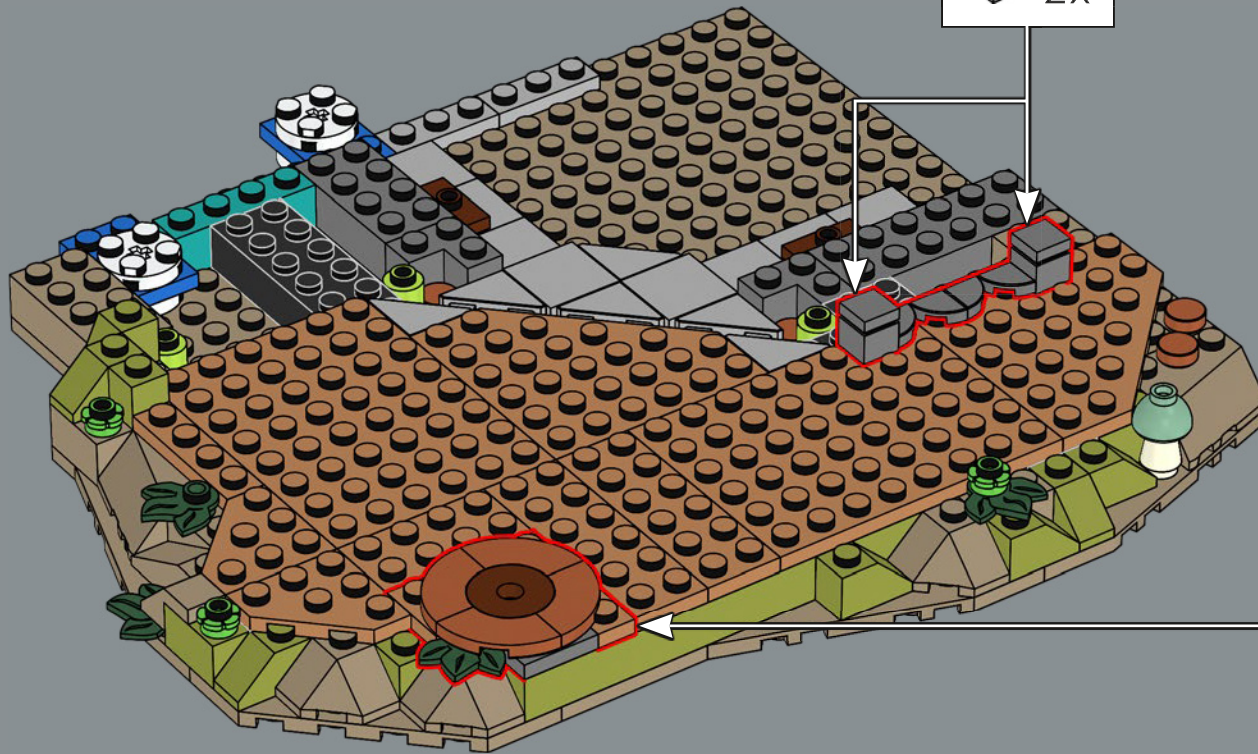

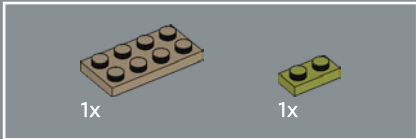
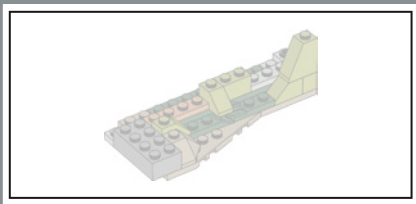

21

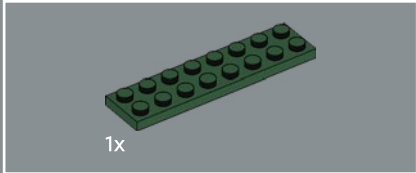
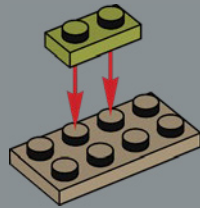

22

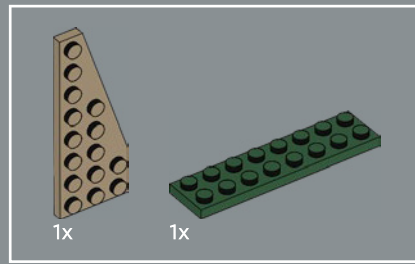
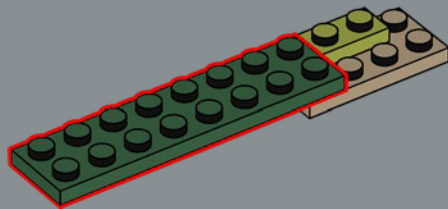

23

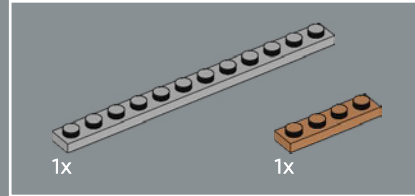
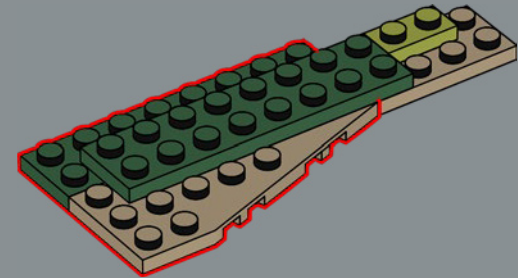

24

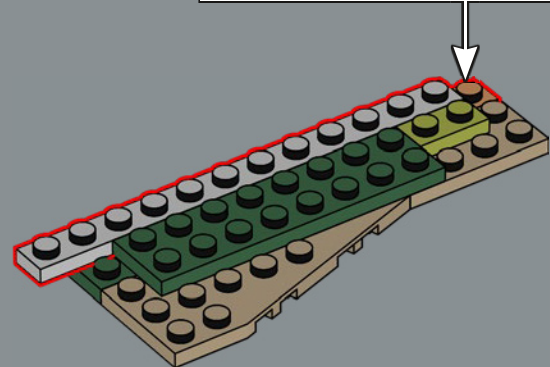
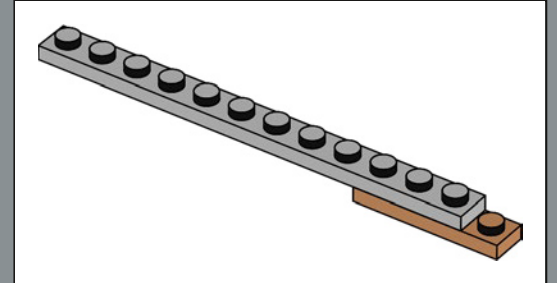

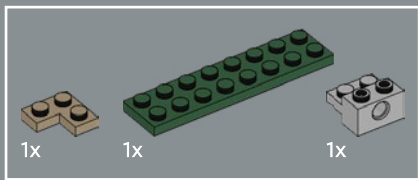

25

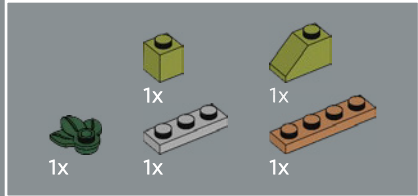
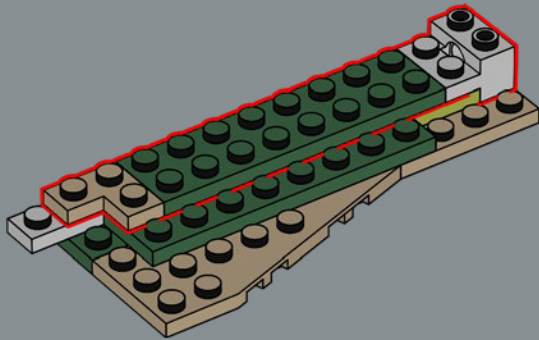

26

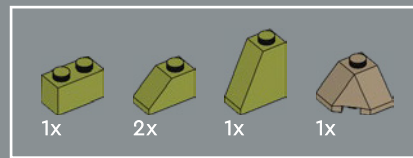
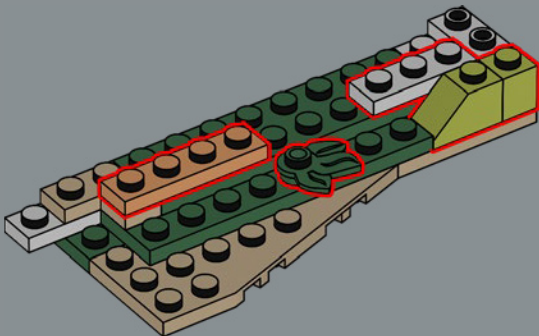

27

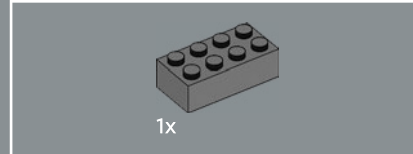
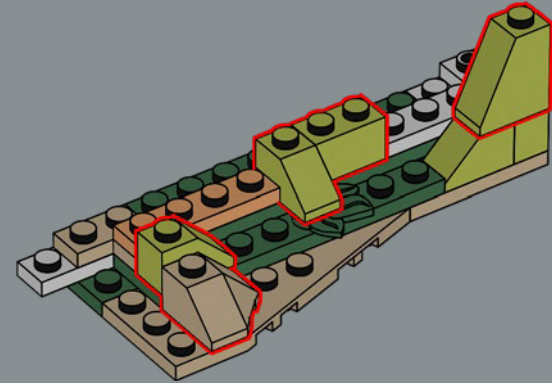

28

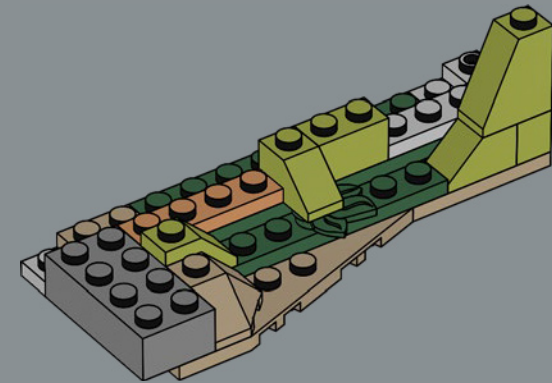

29

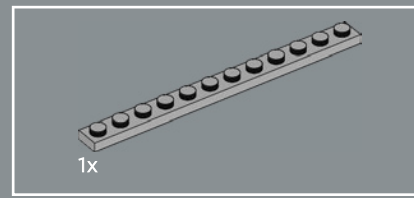
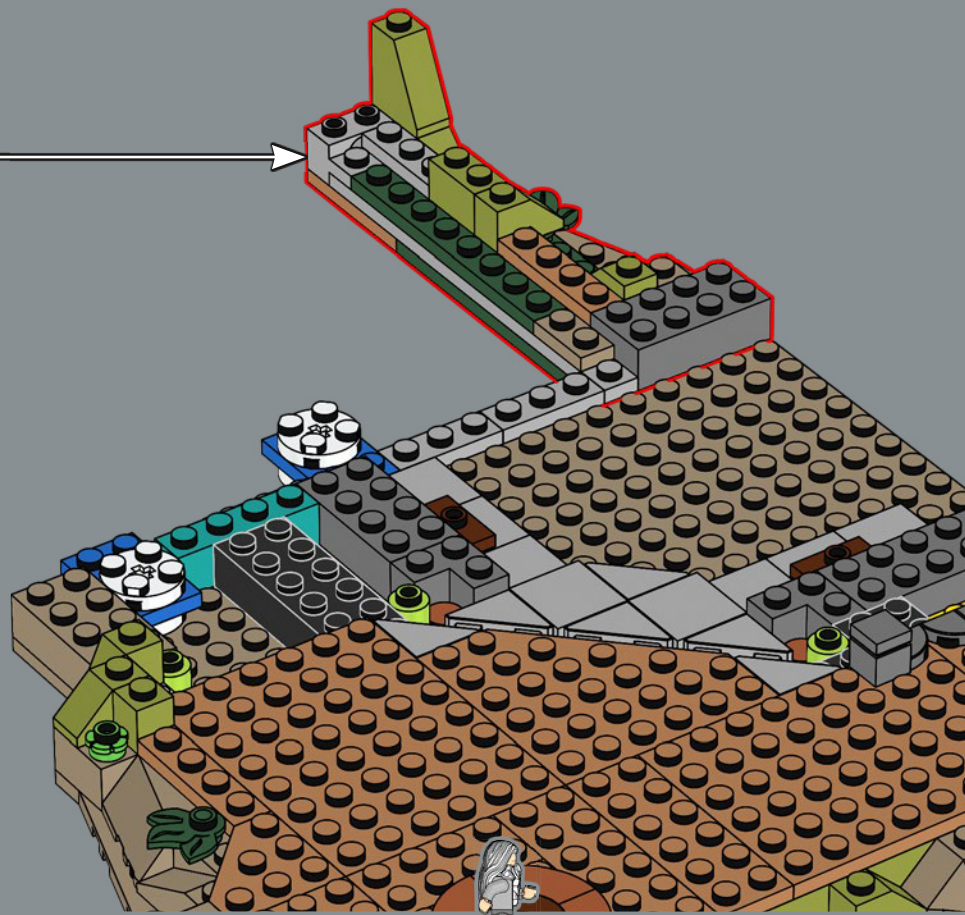

30

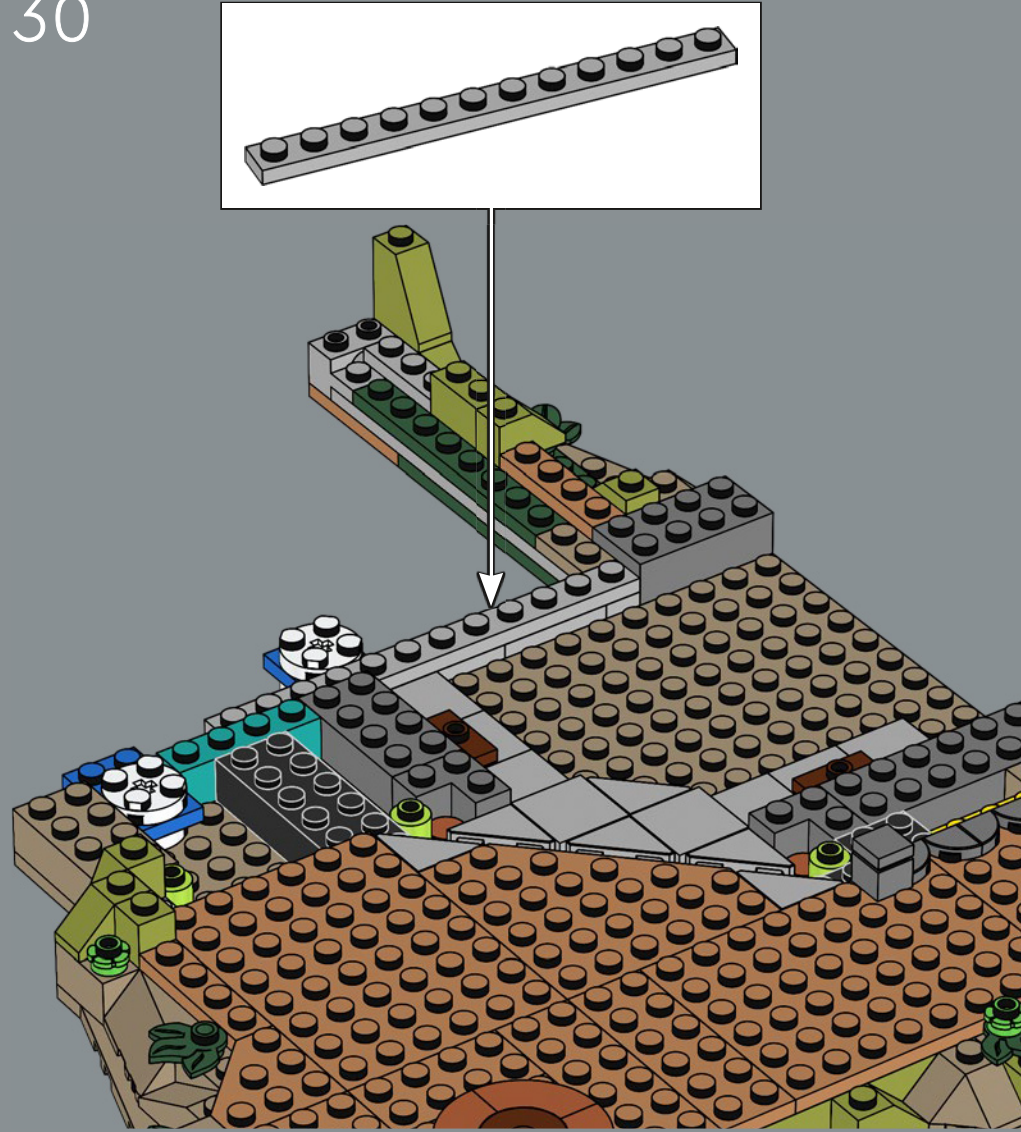



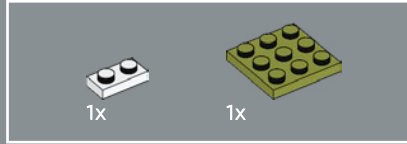
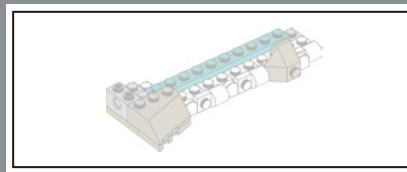
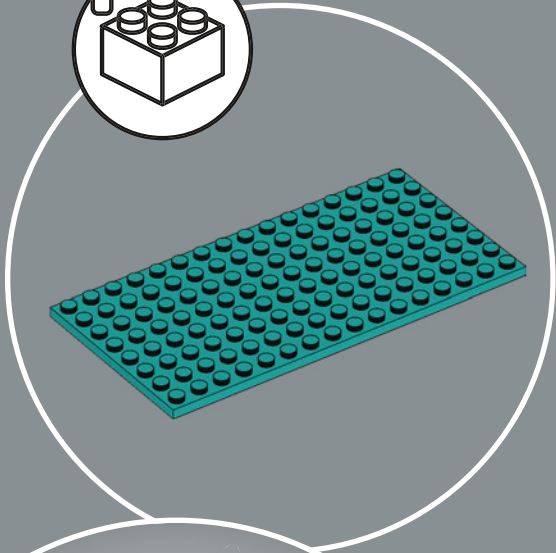
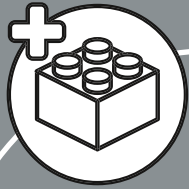

31

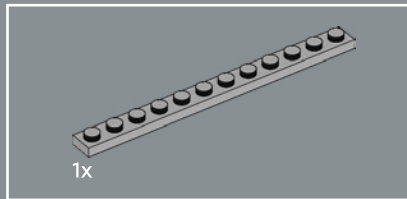
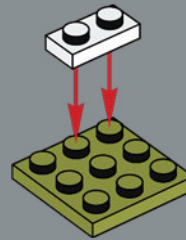

32

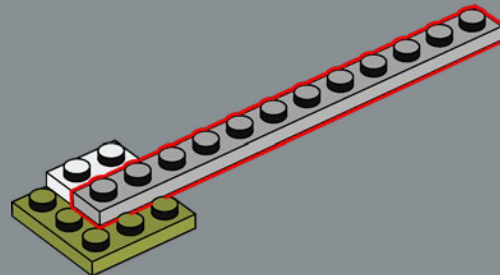



1x

33

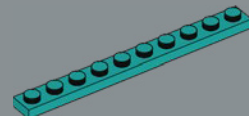
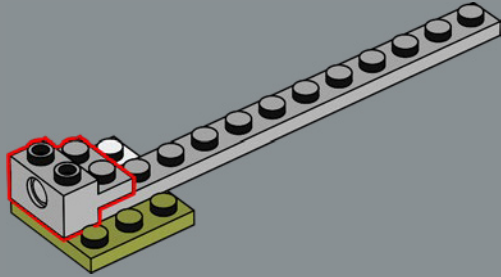

1x

35

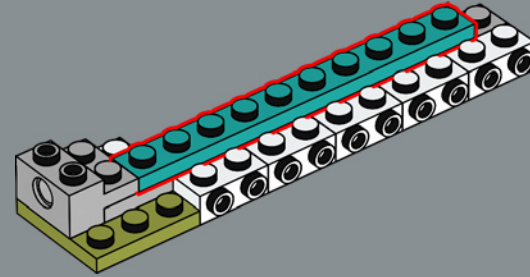

5x

34

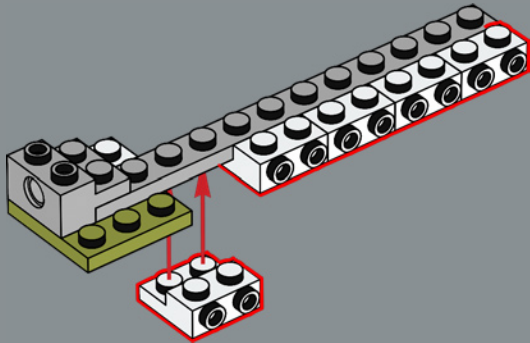

1x



1x



1x

36

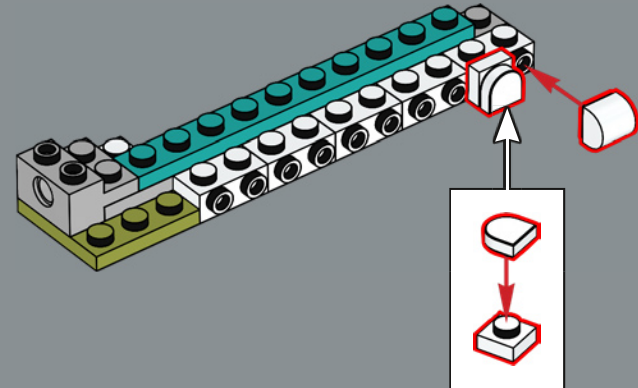



37

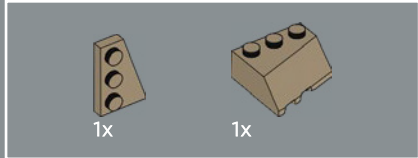
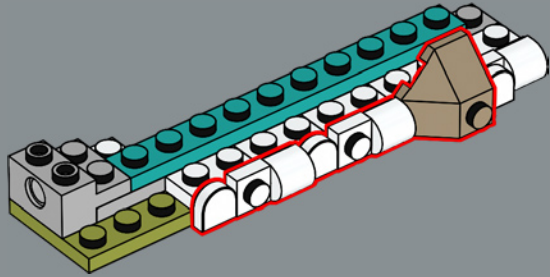

38

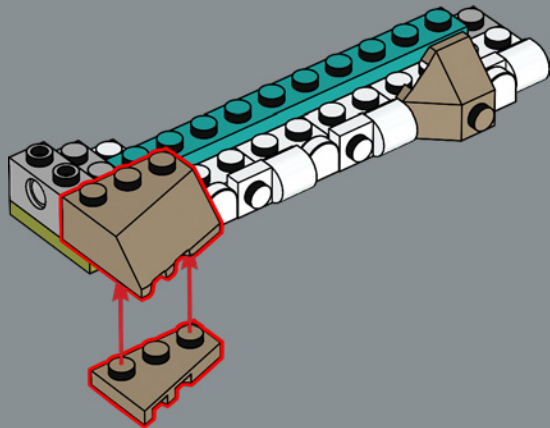

39

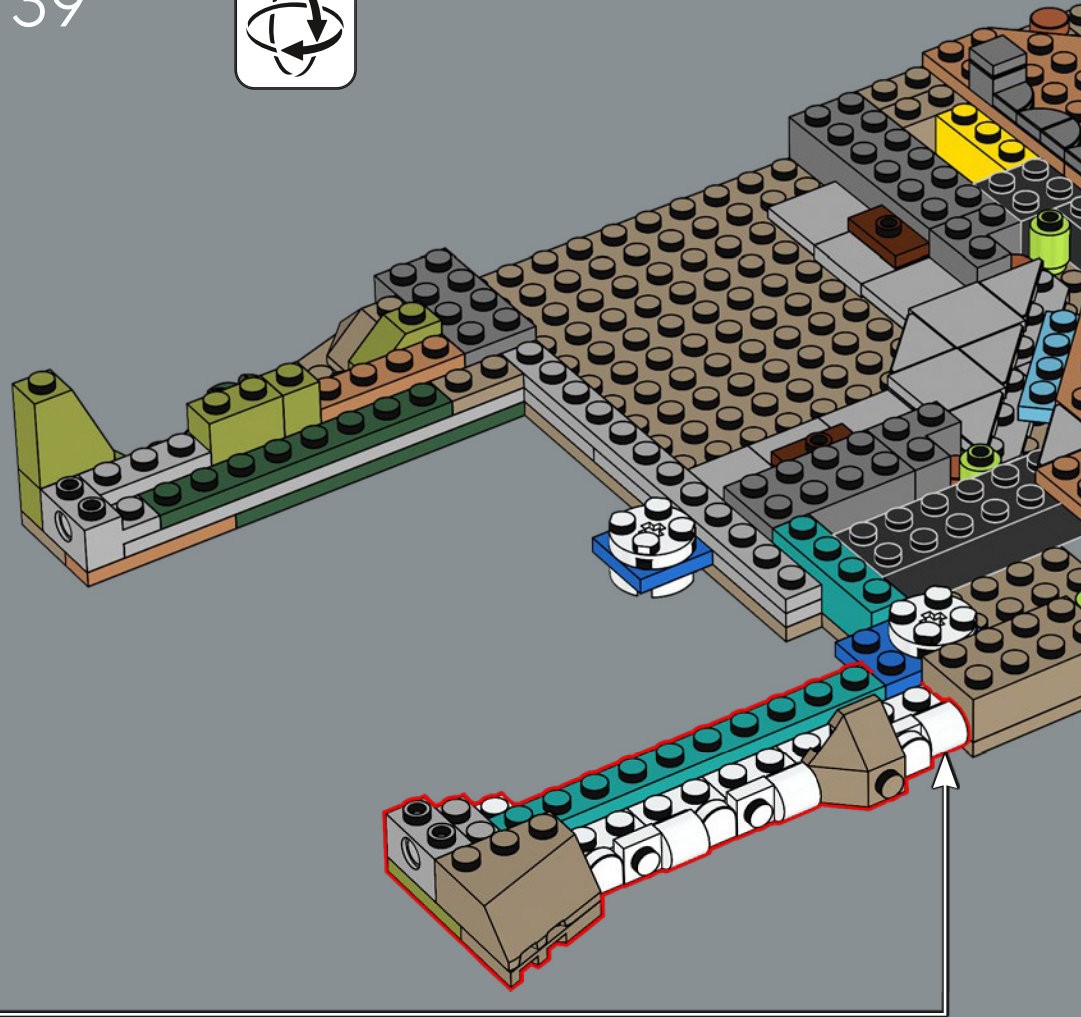

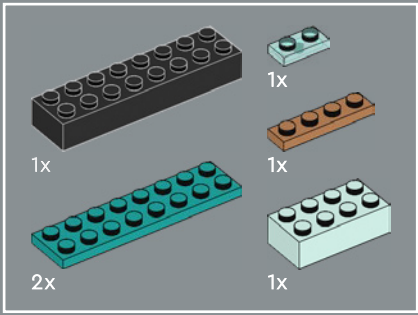

40

1

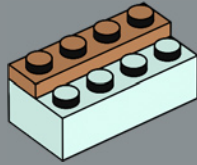

2

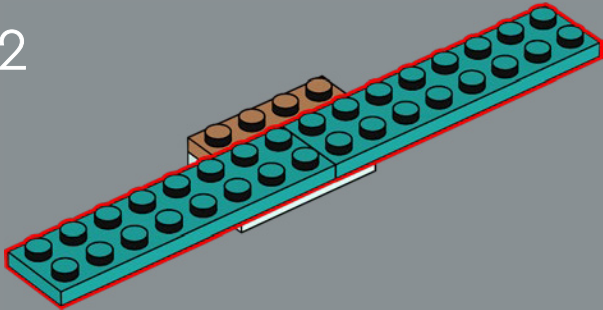

3

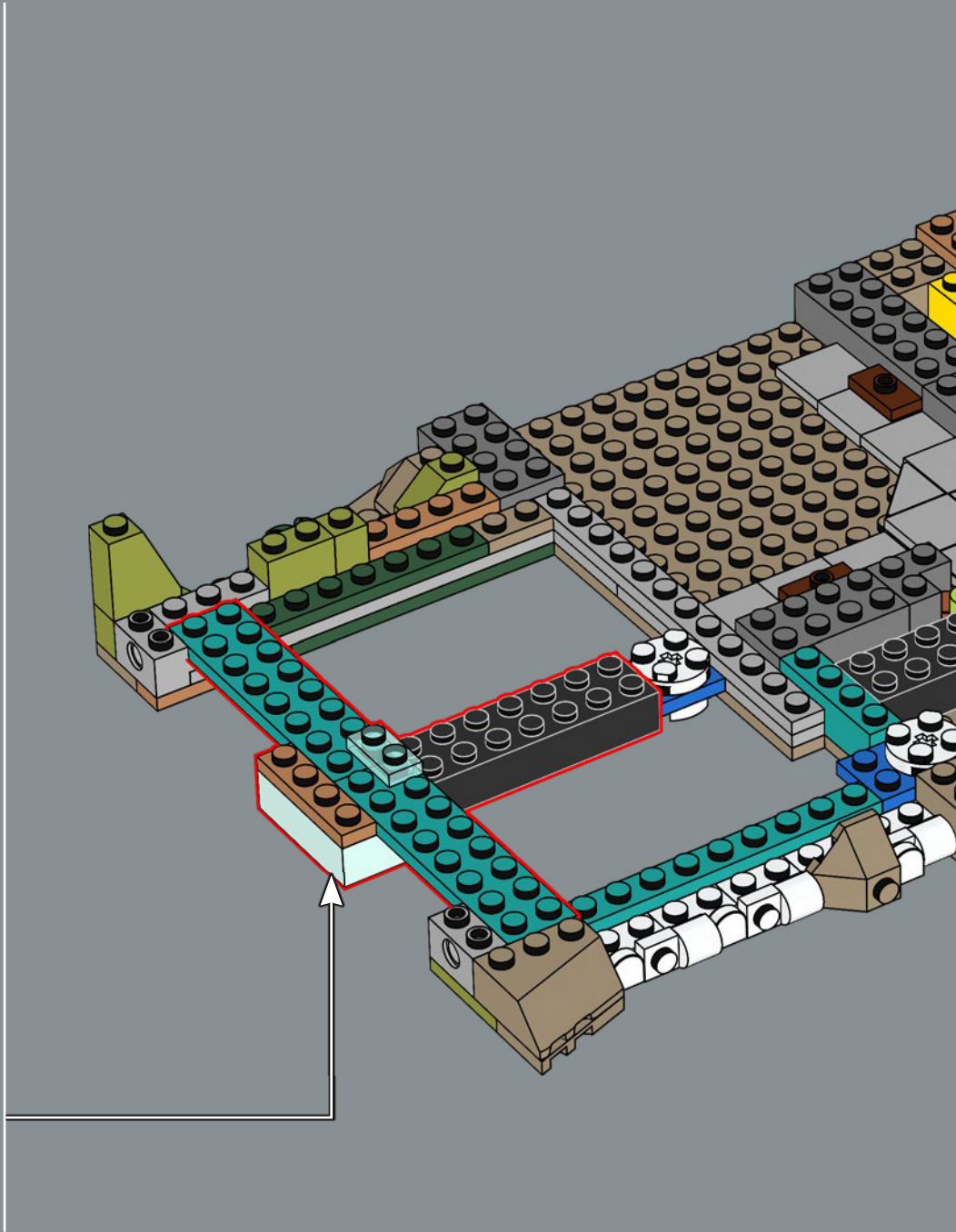
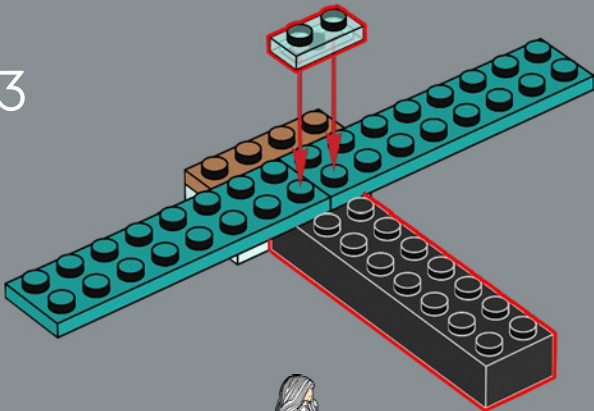

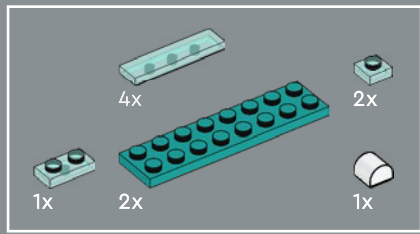

41

1

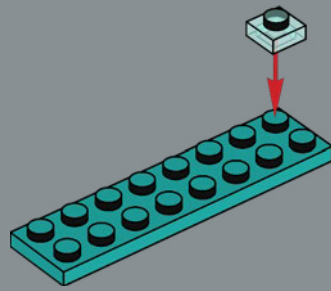

2

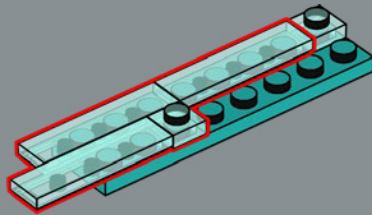

3

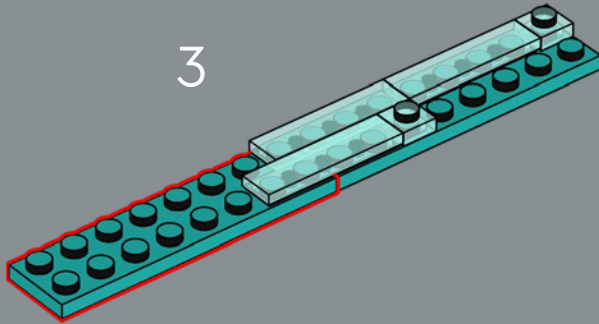

4

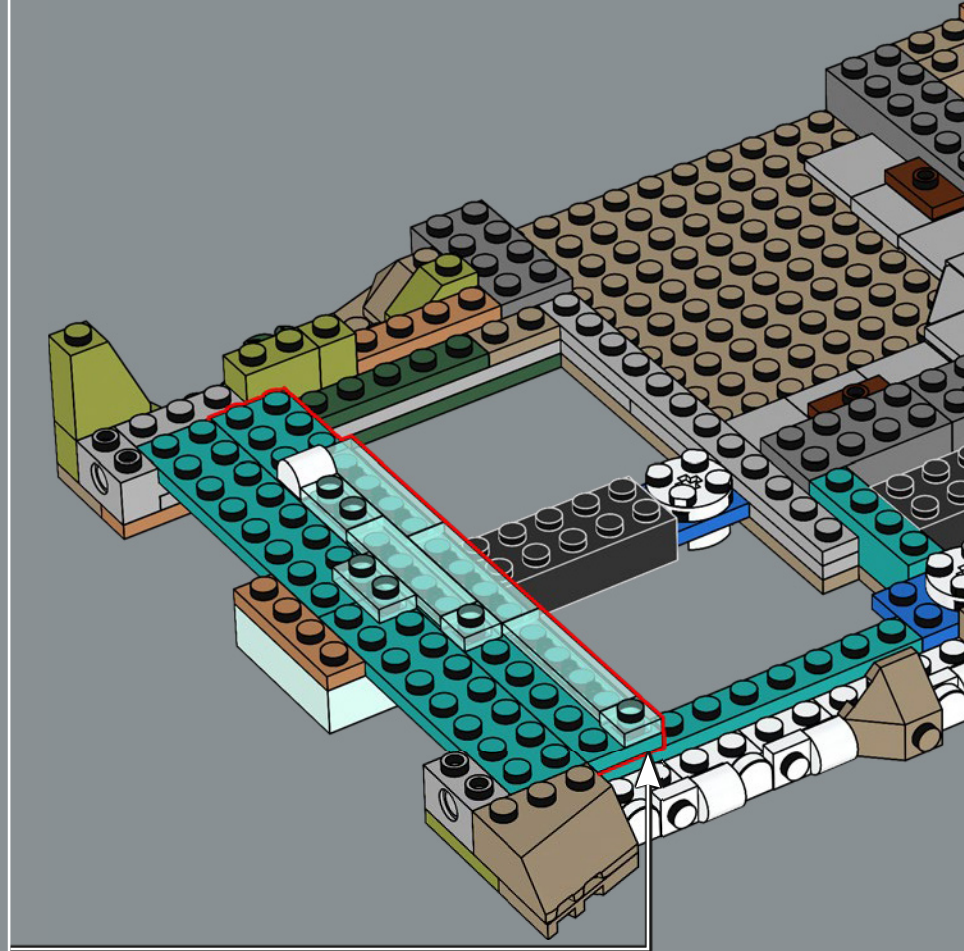
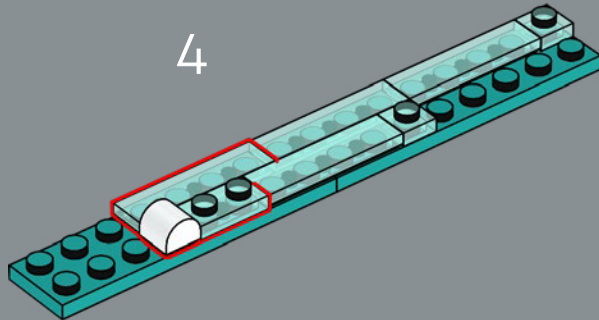

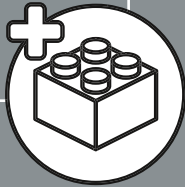
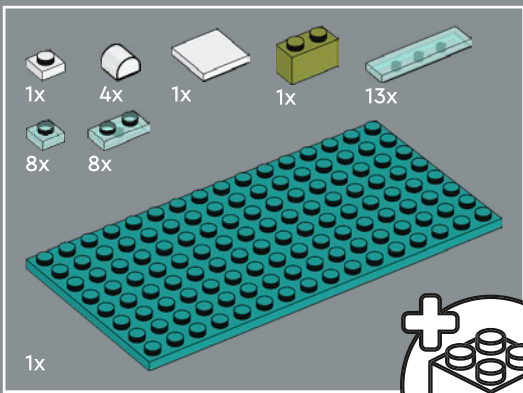

42

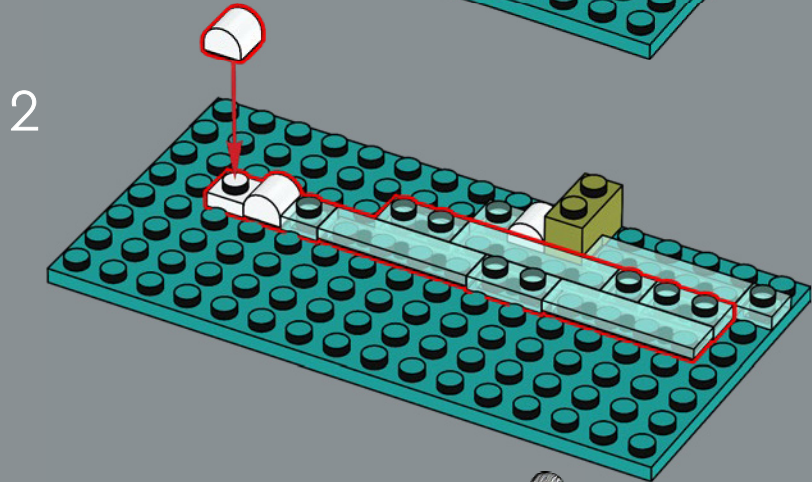
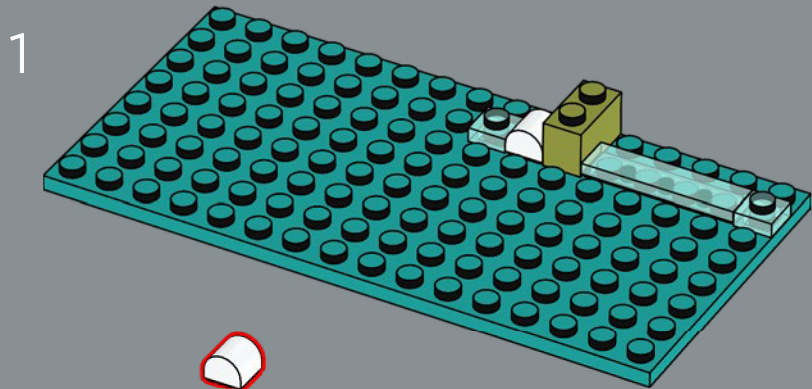

3

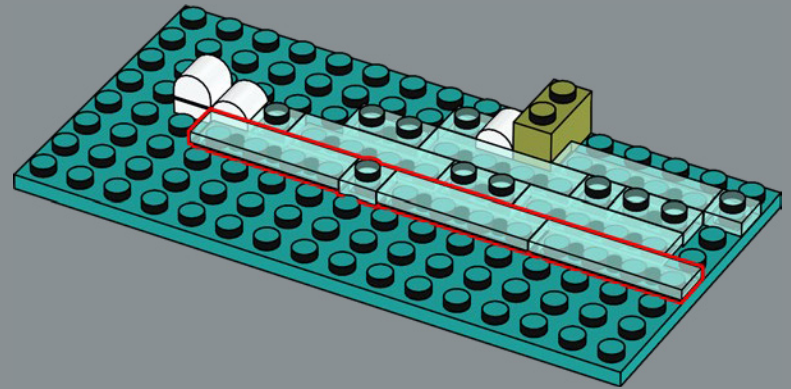

4

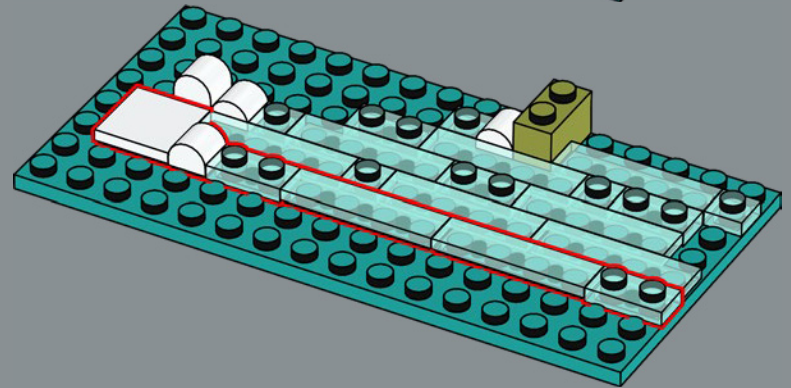

5

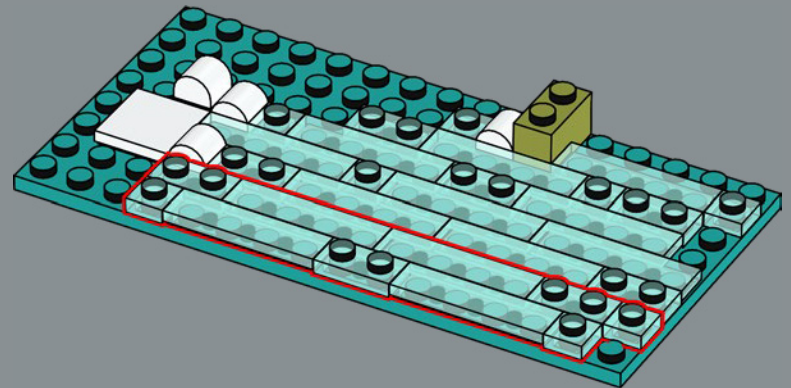

43

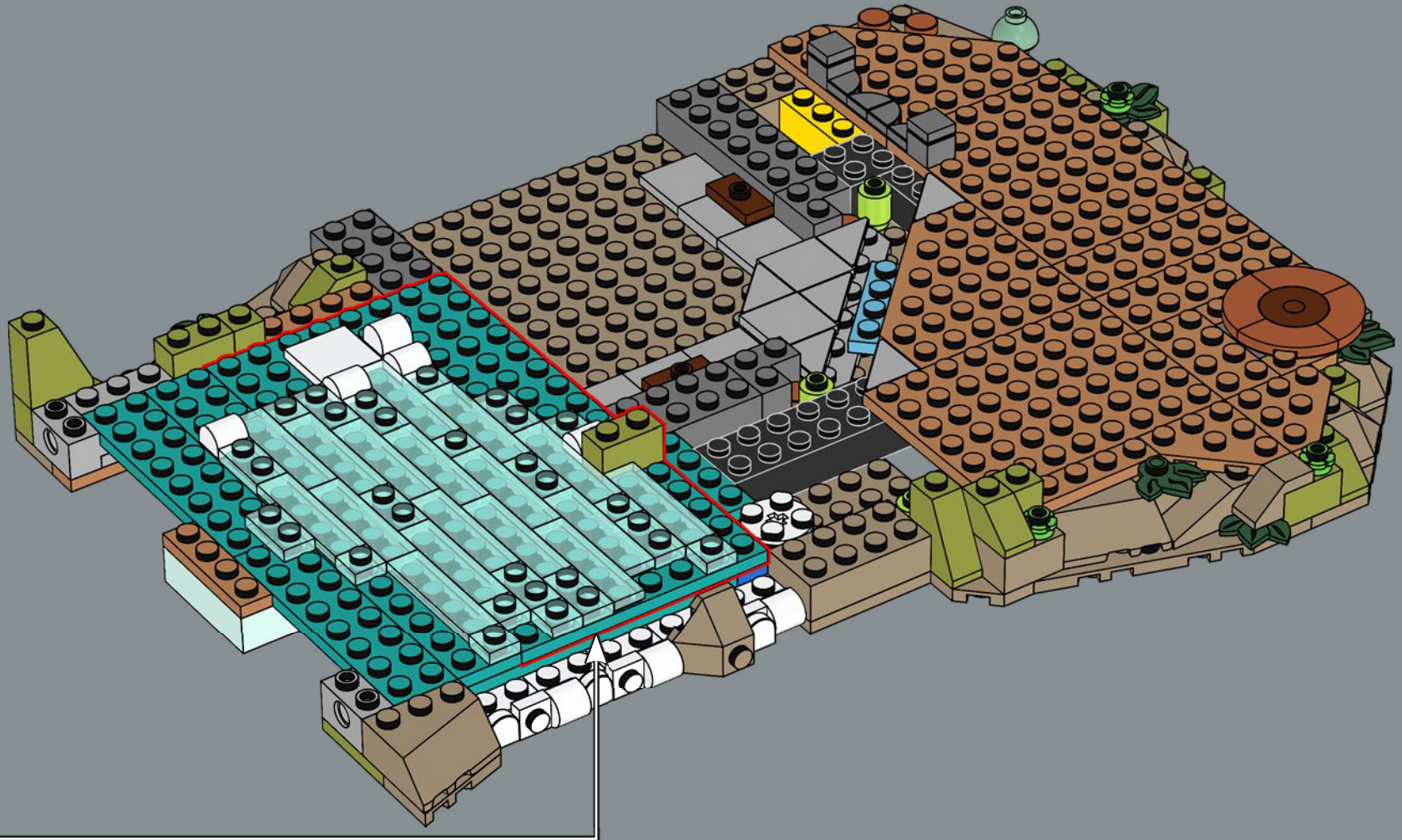

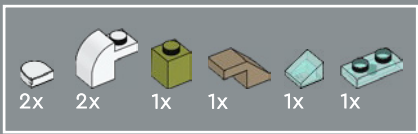

44

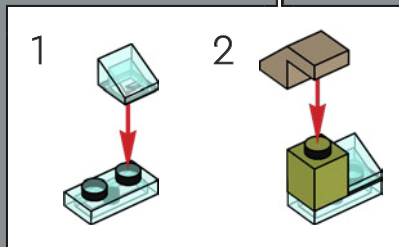
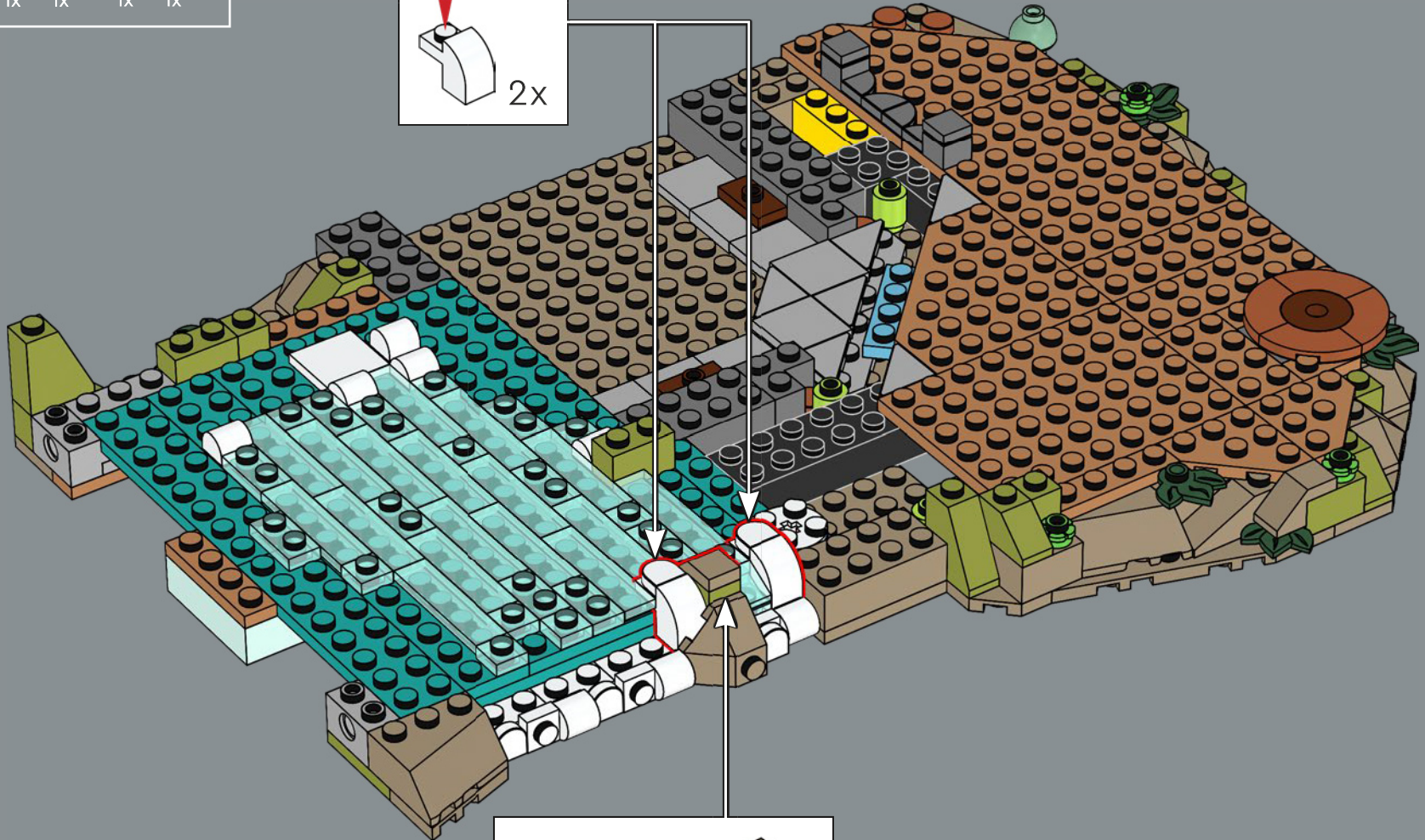
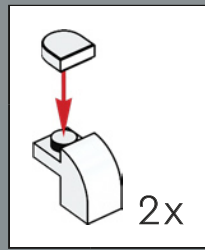



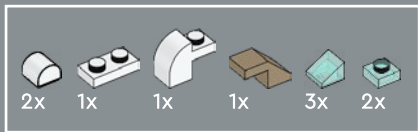

45

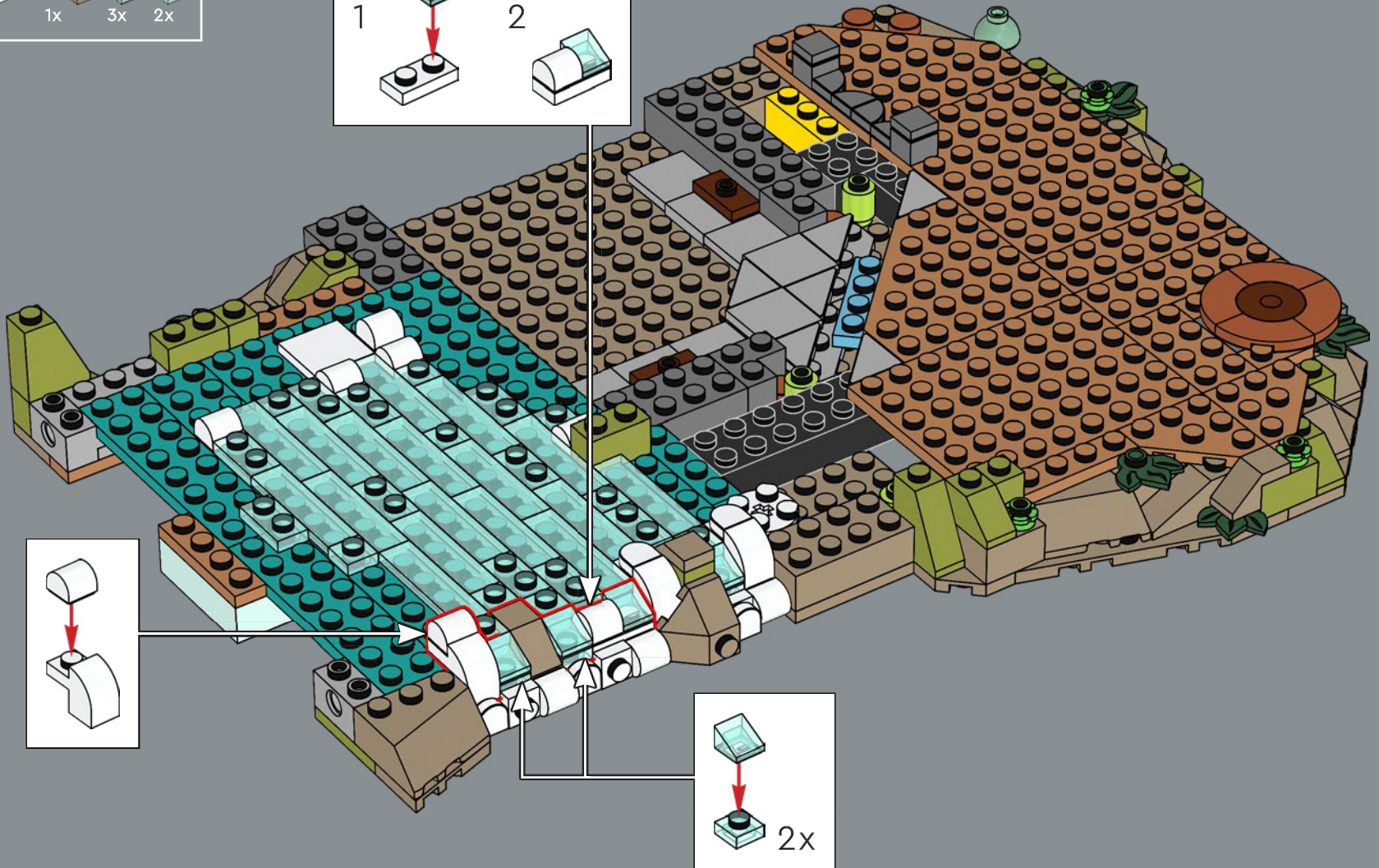
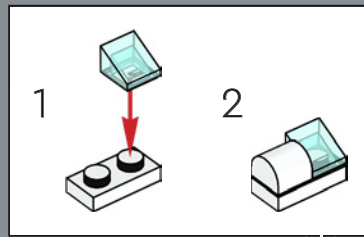



46

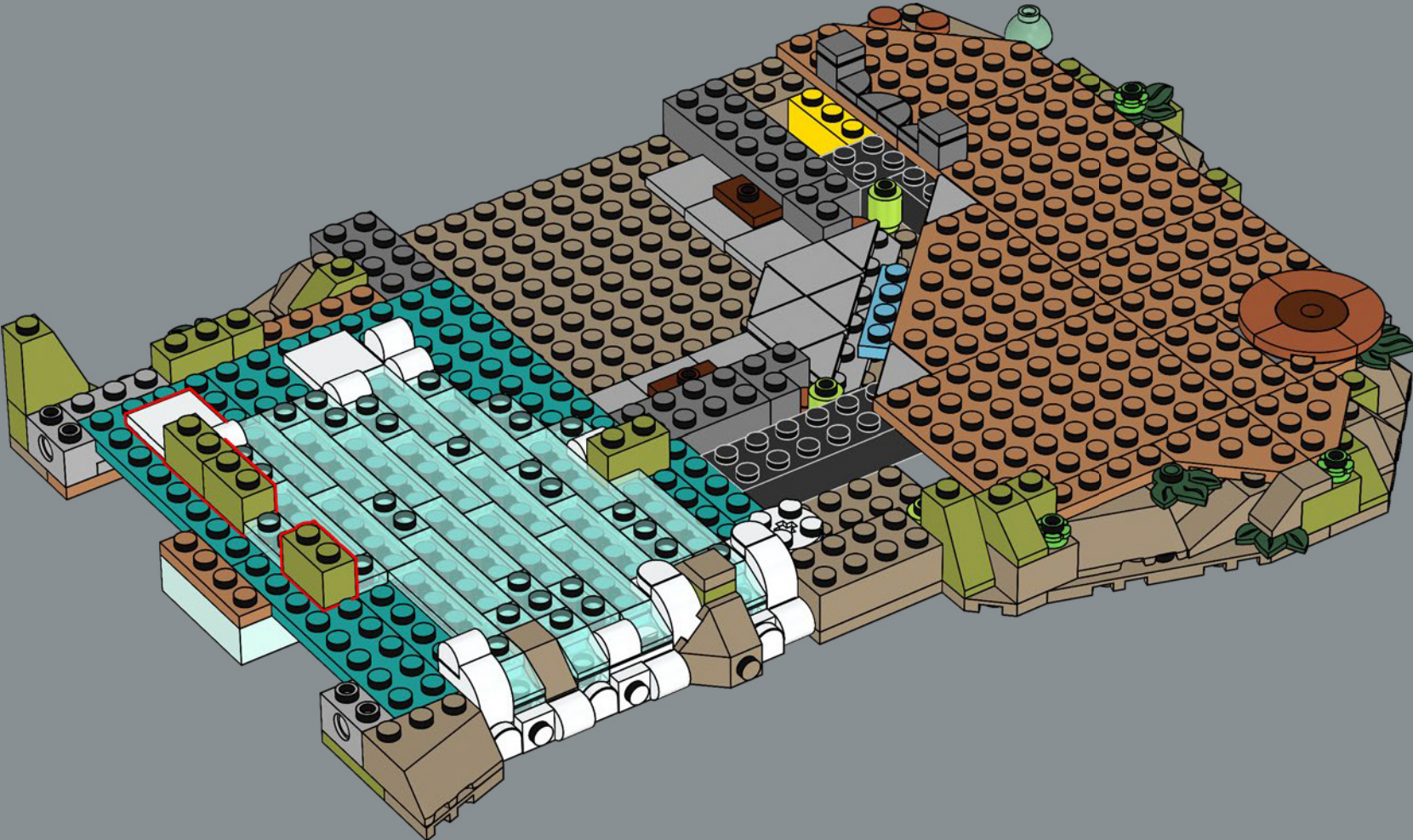

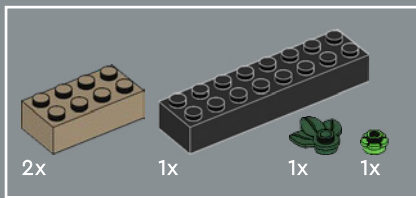

47



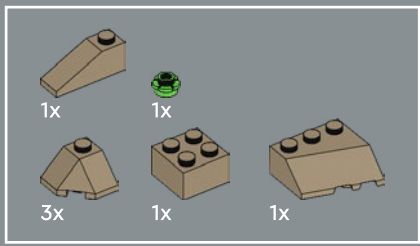

48

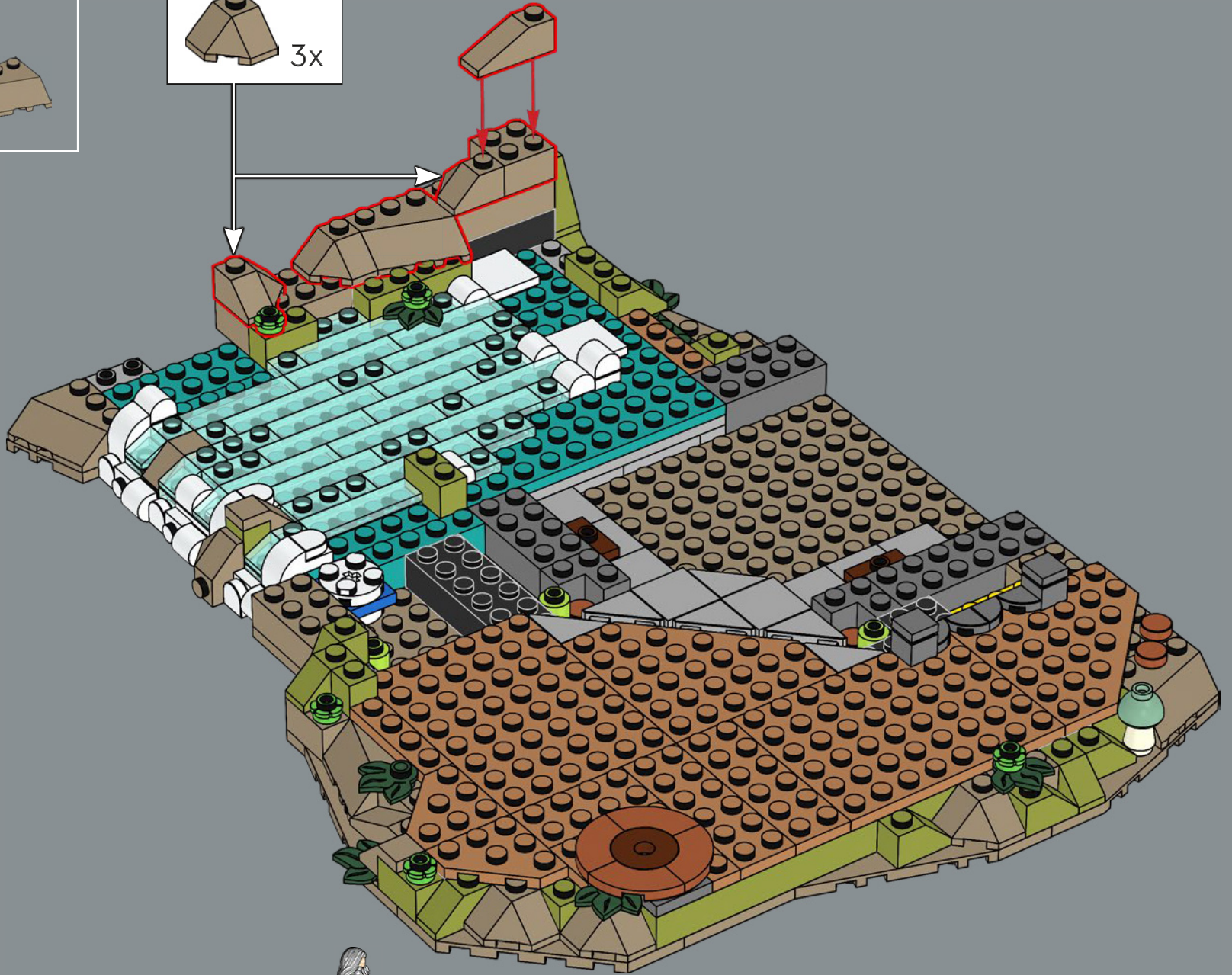

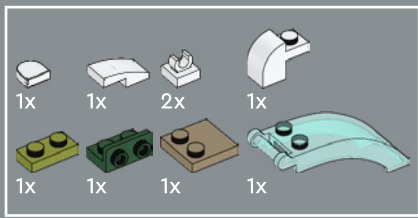

49

1

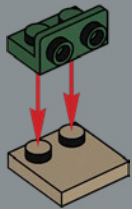

2

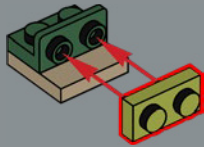

3

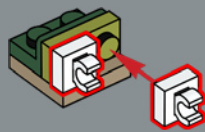

4



5



6

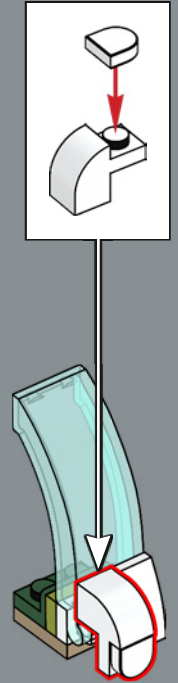

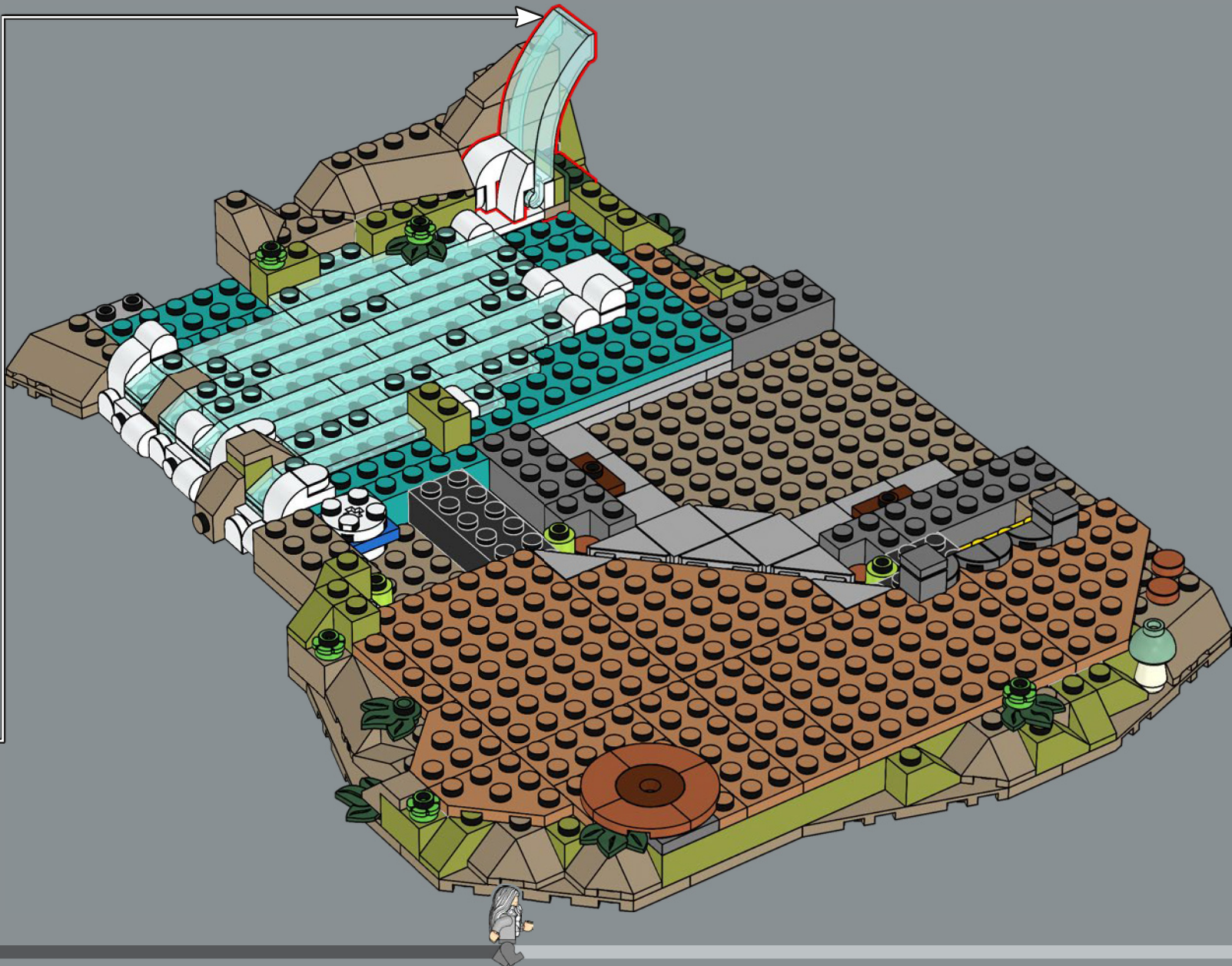

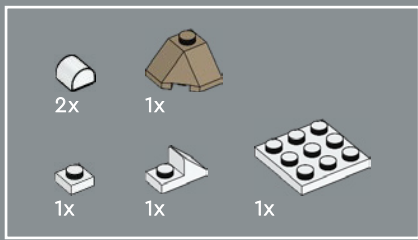

50

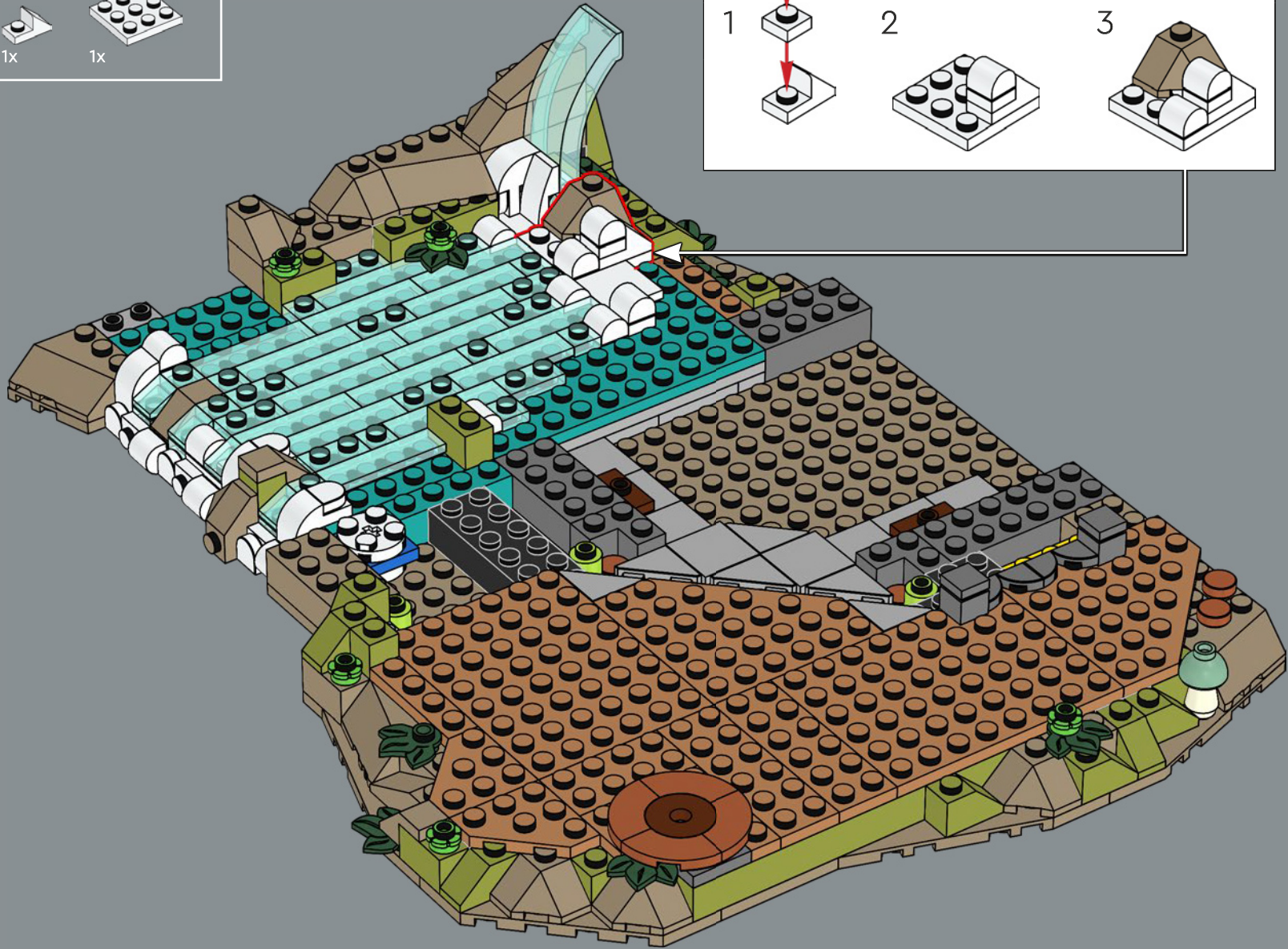
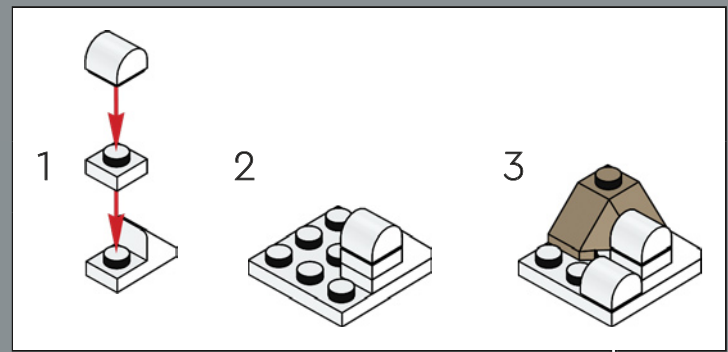

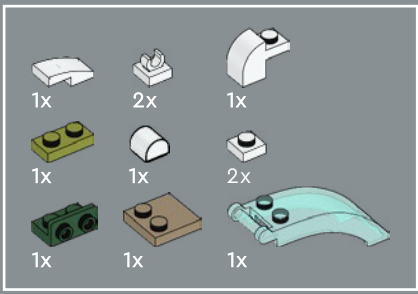

51

1

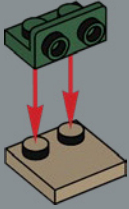

2

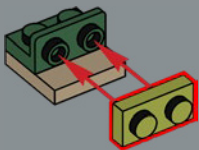

3

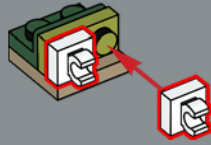

4



5

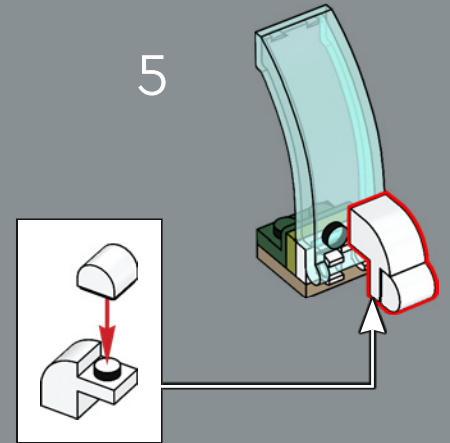

6

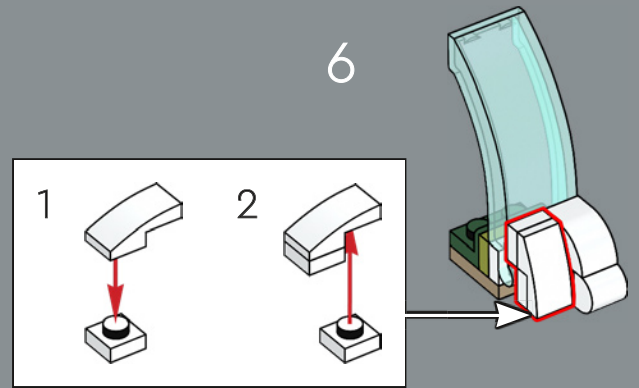



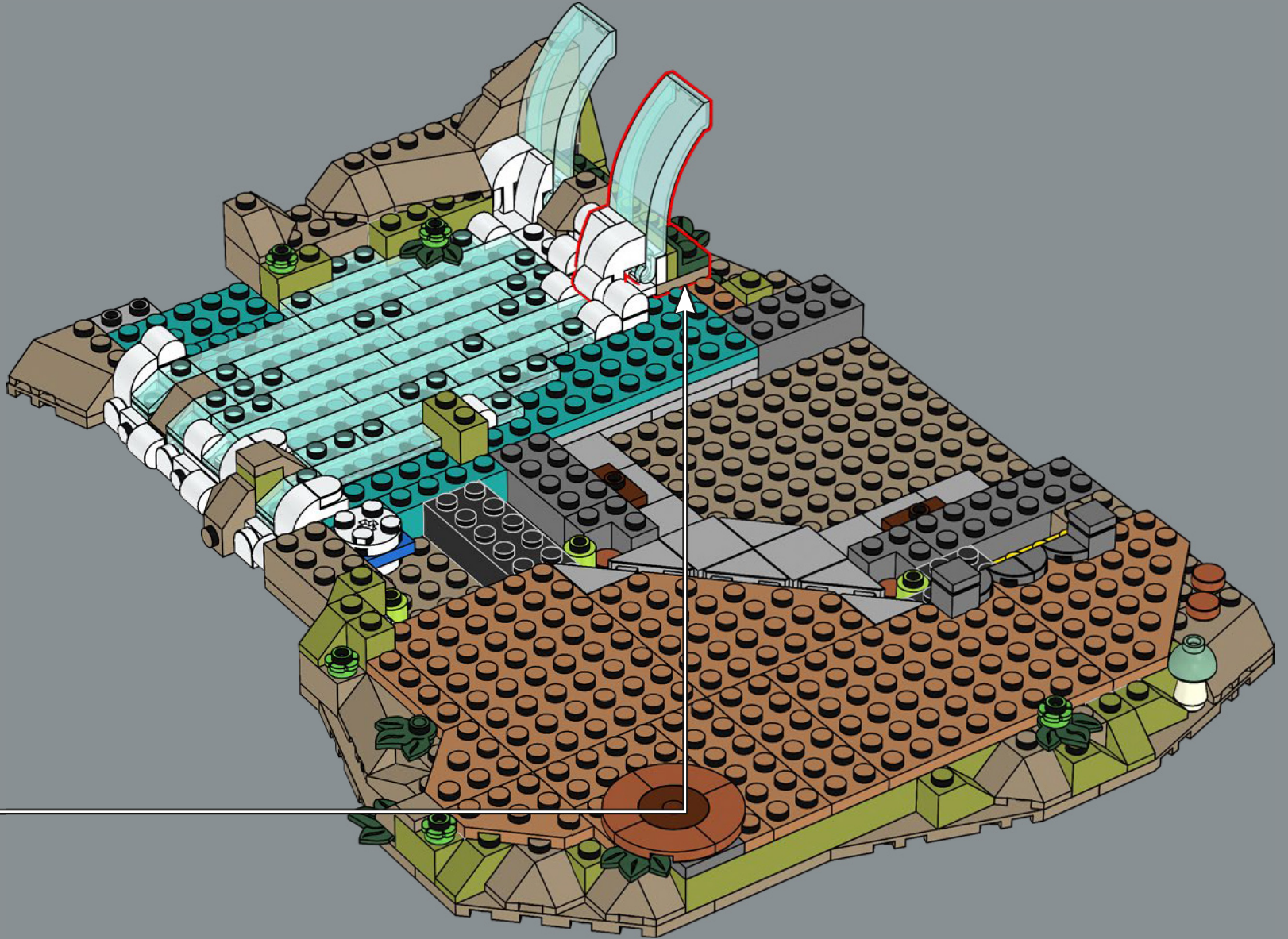

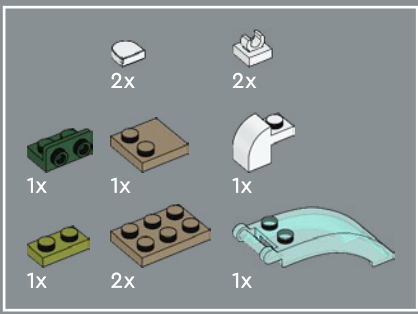

# 52

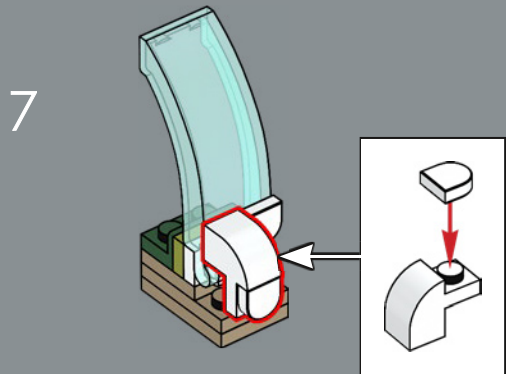
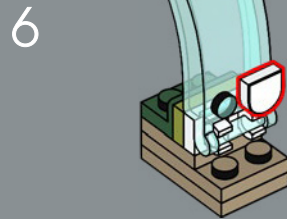
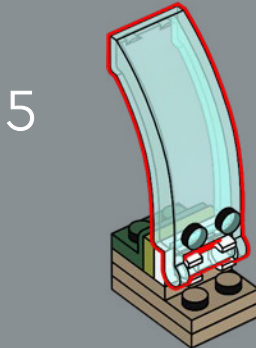
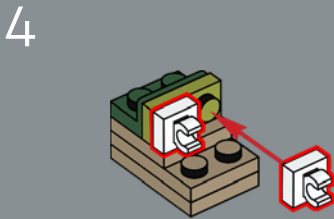
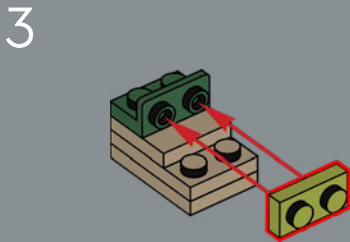
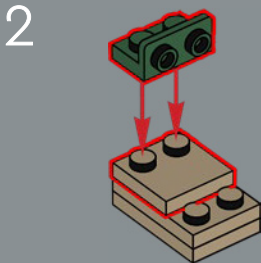
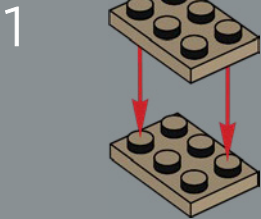

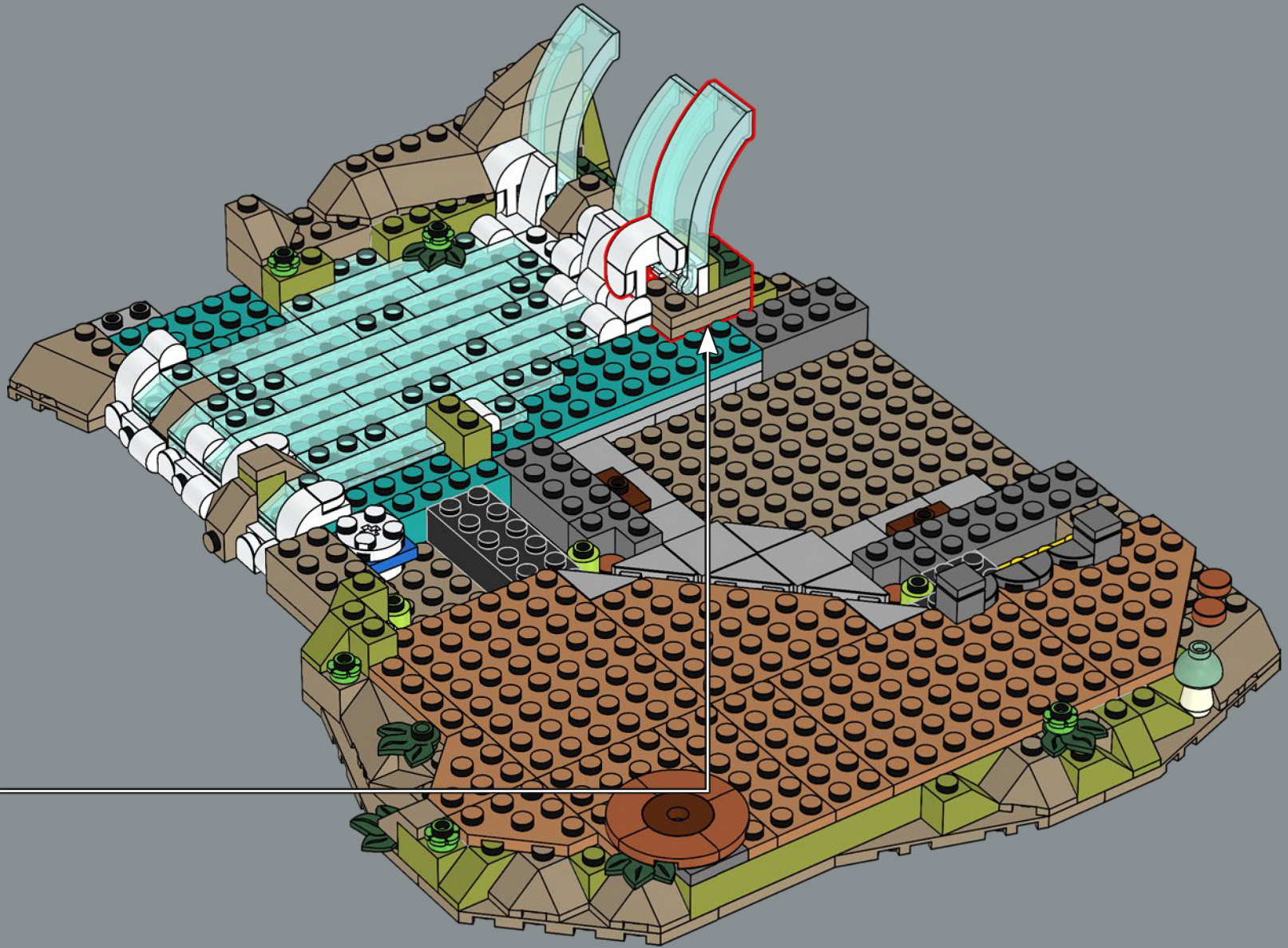

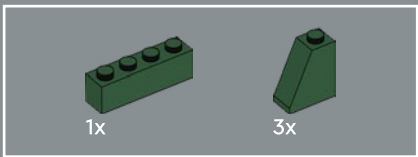

53

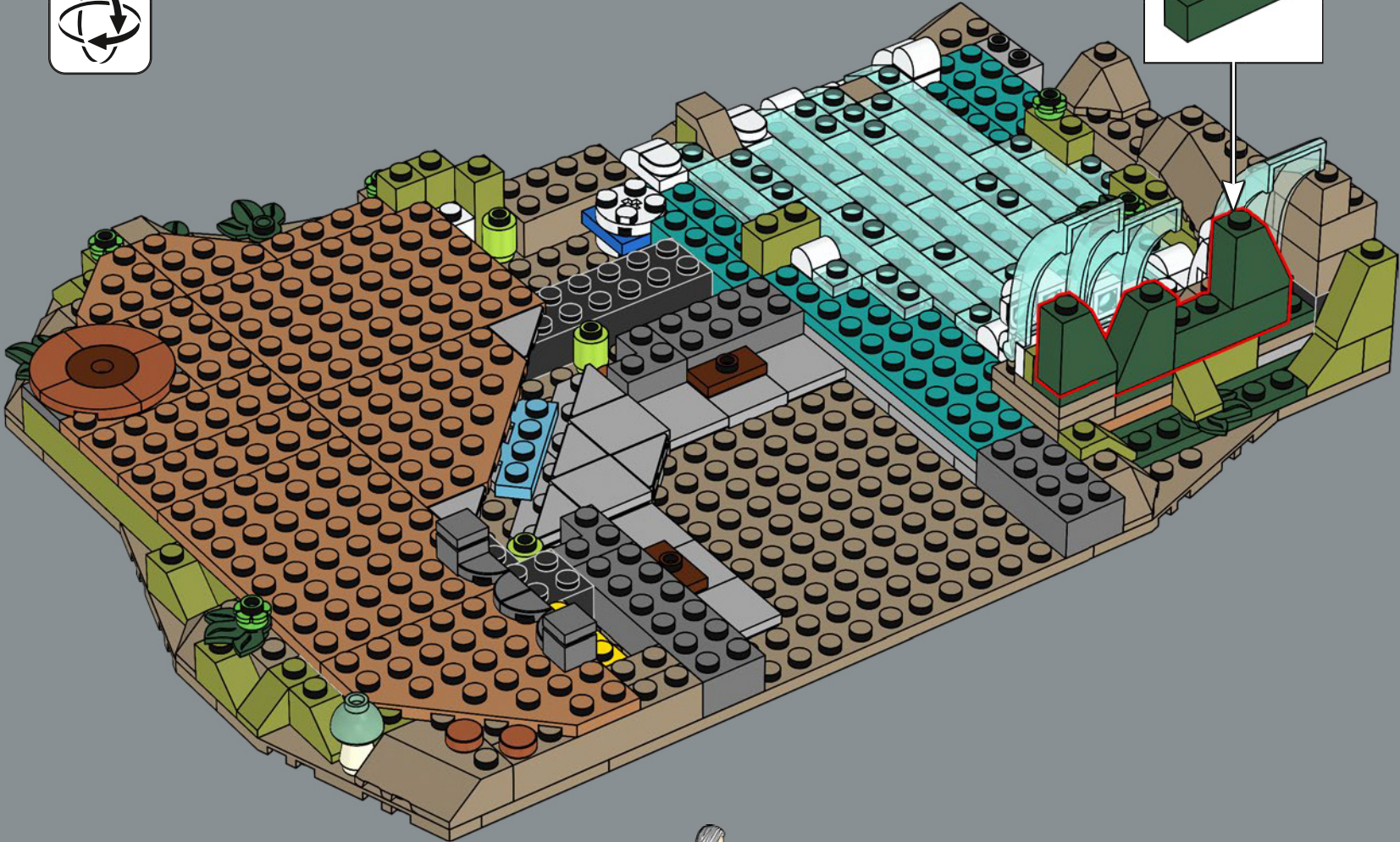
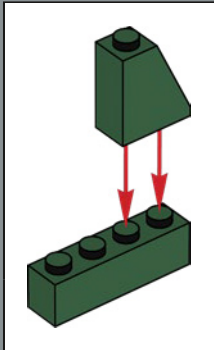



54

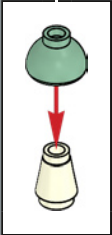
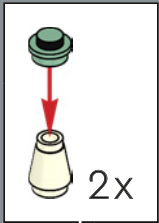
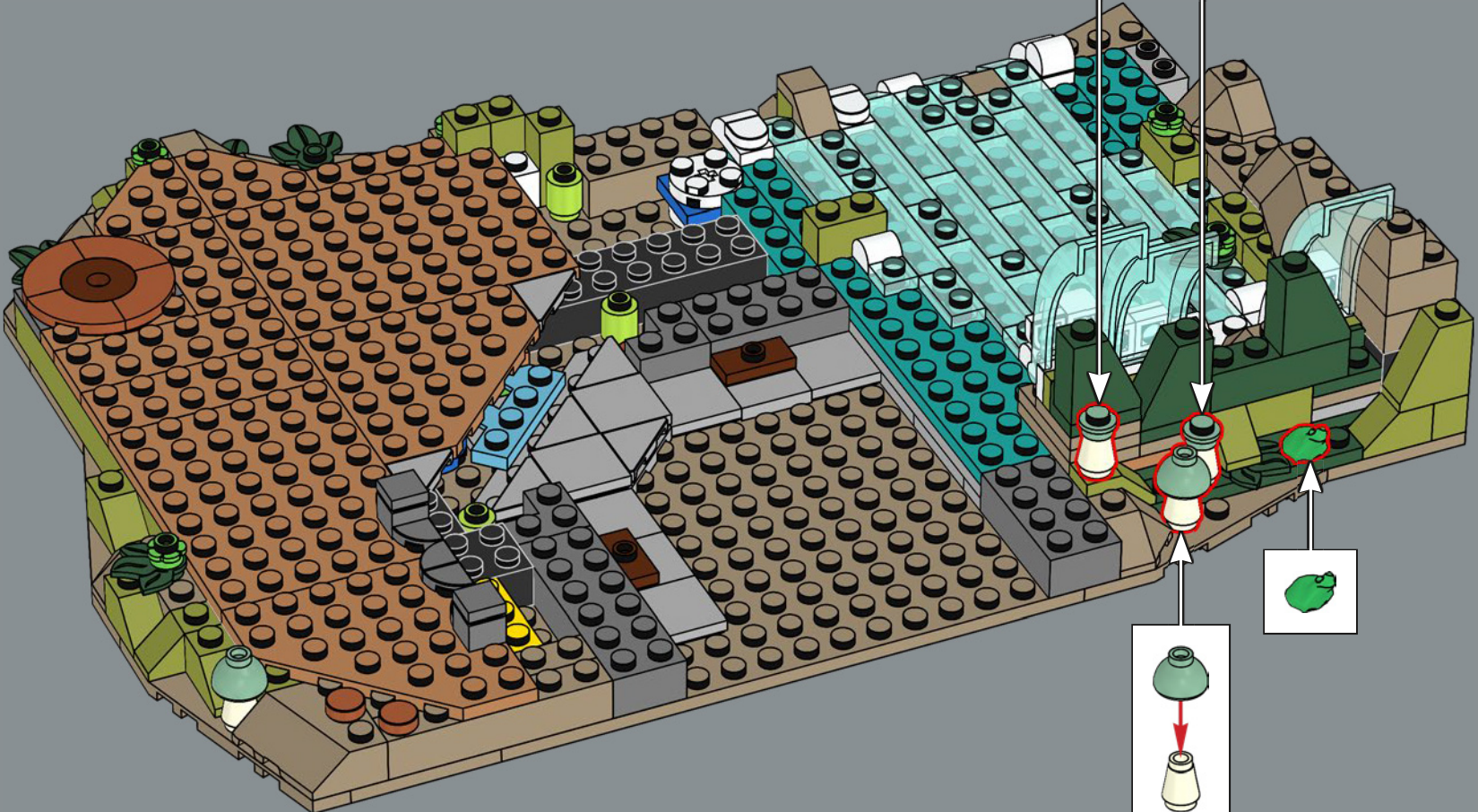

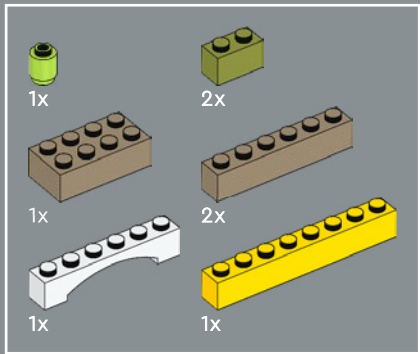
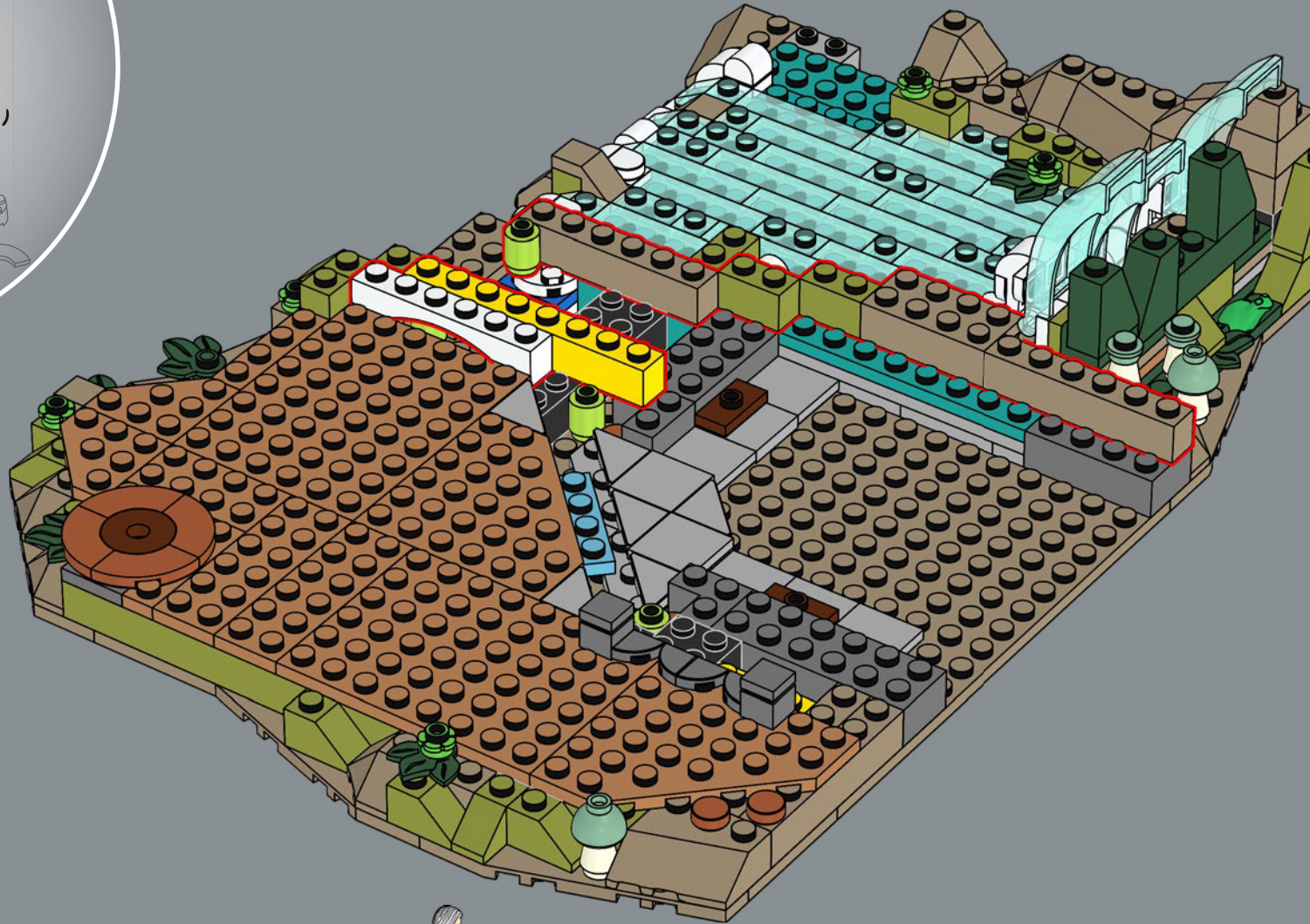

55



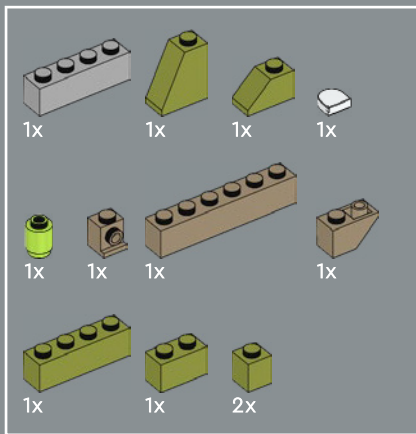

56

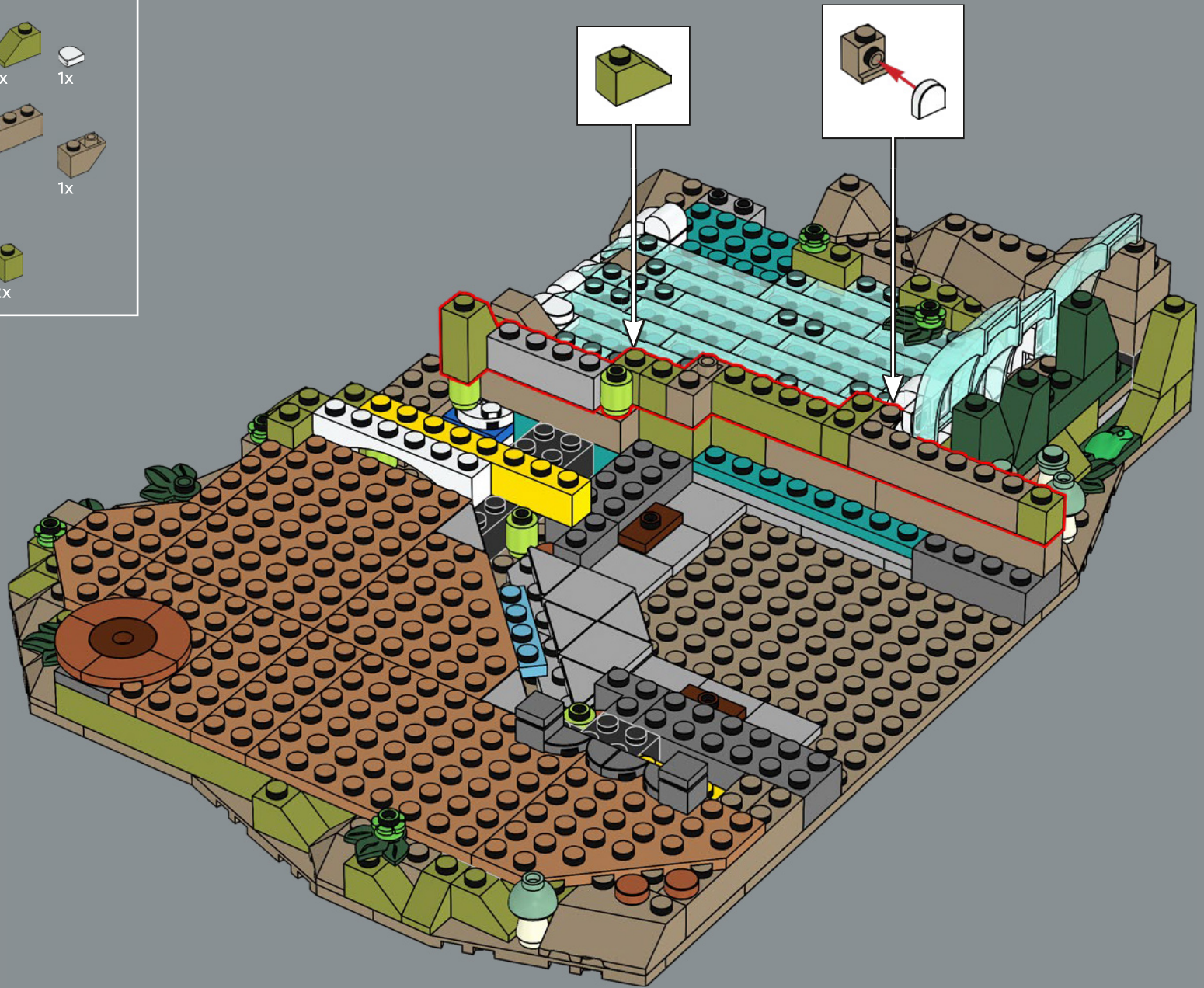

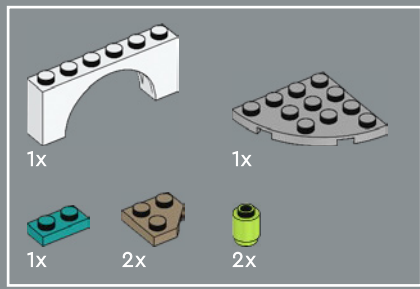

57

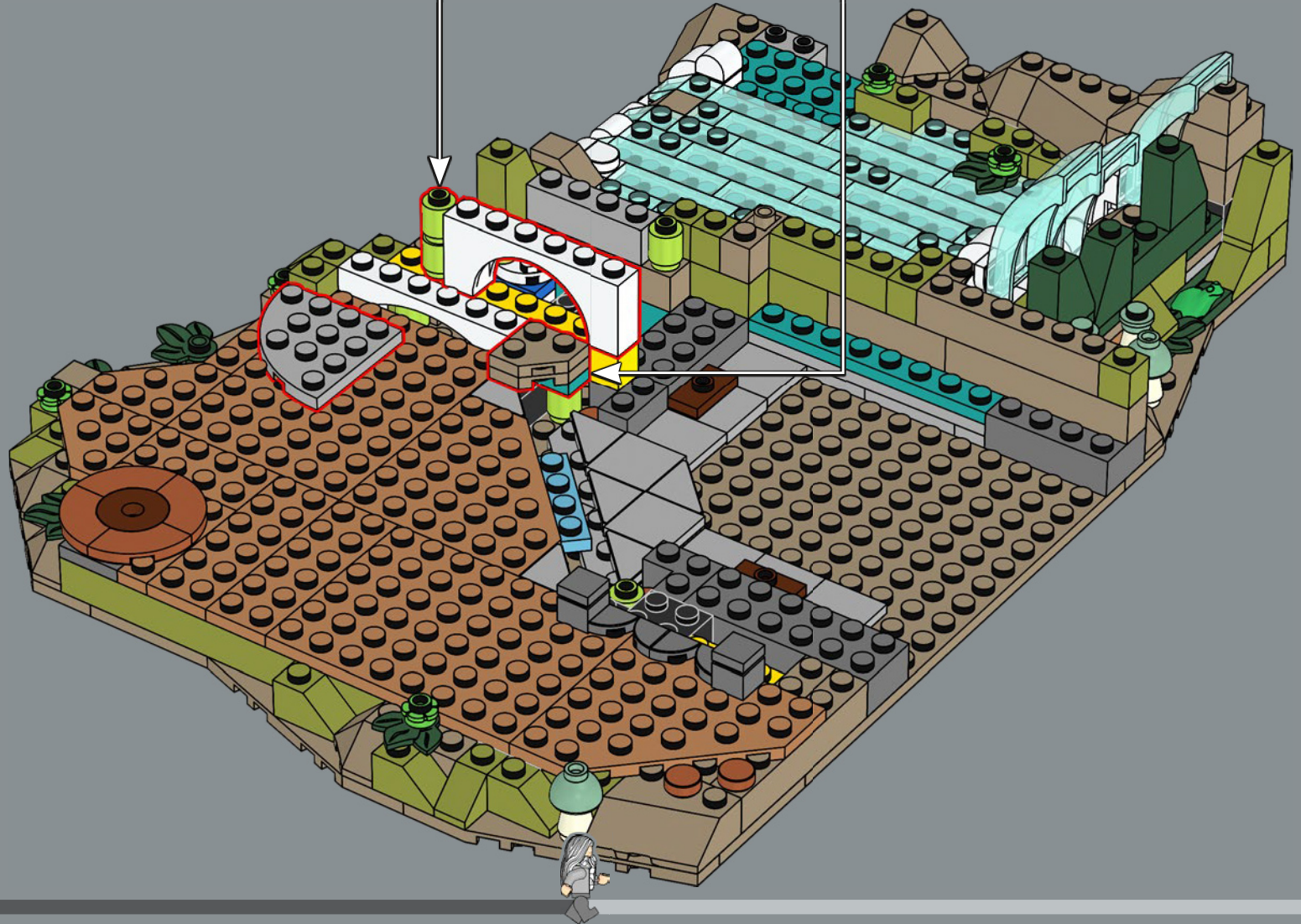
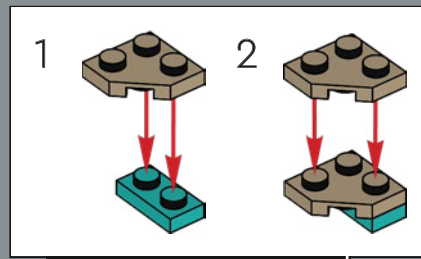
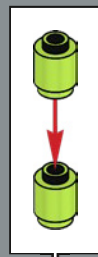



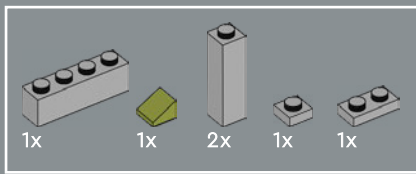

58

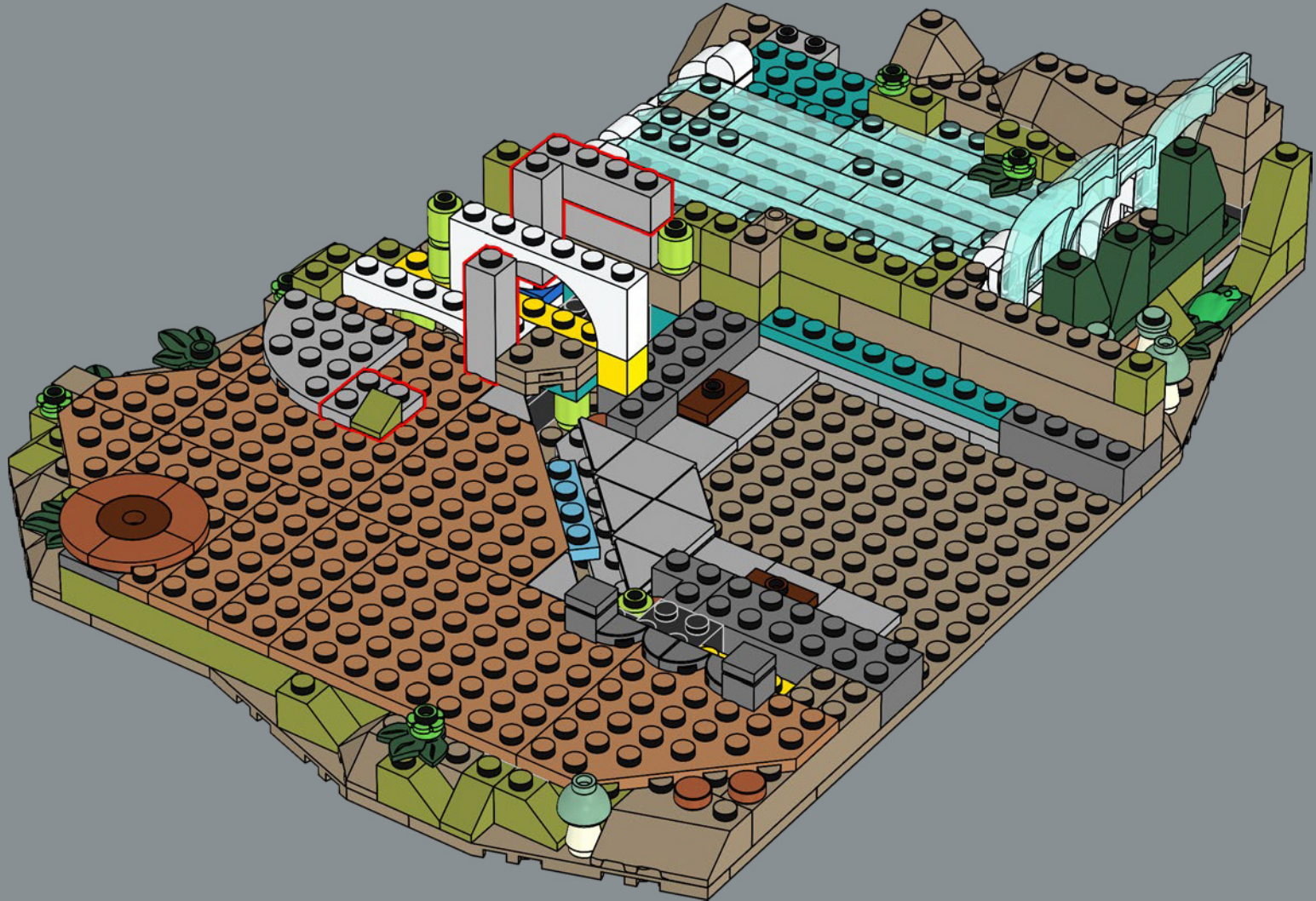

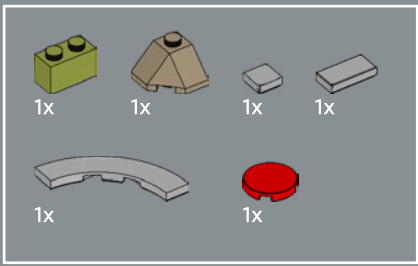

59

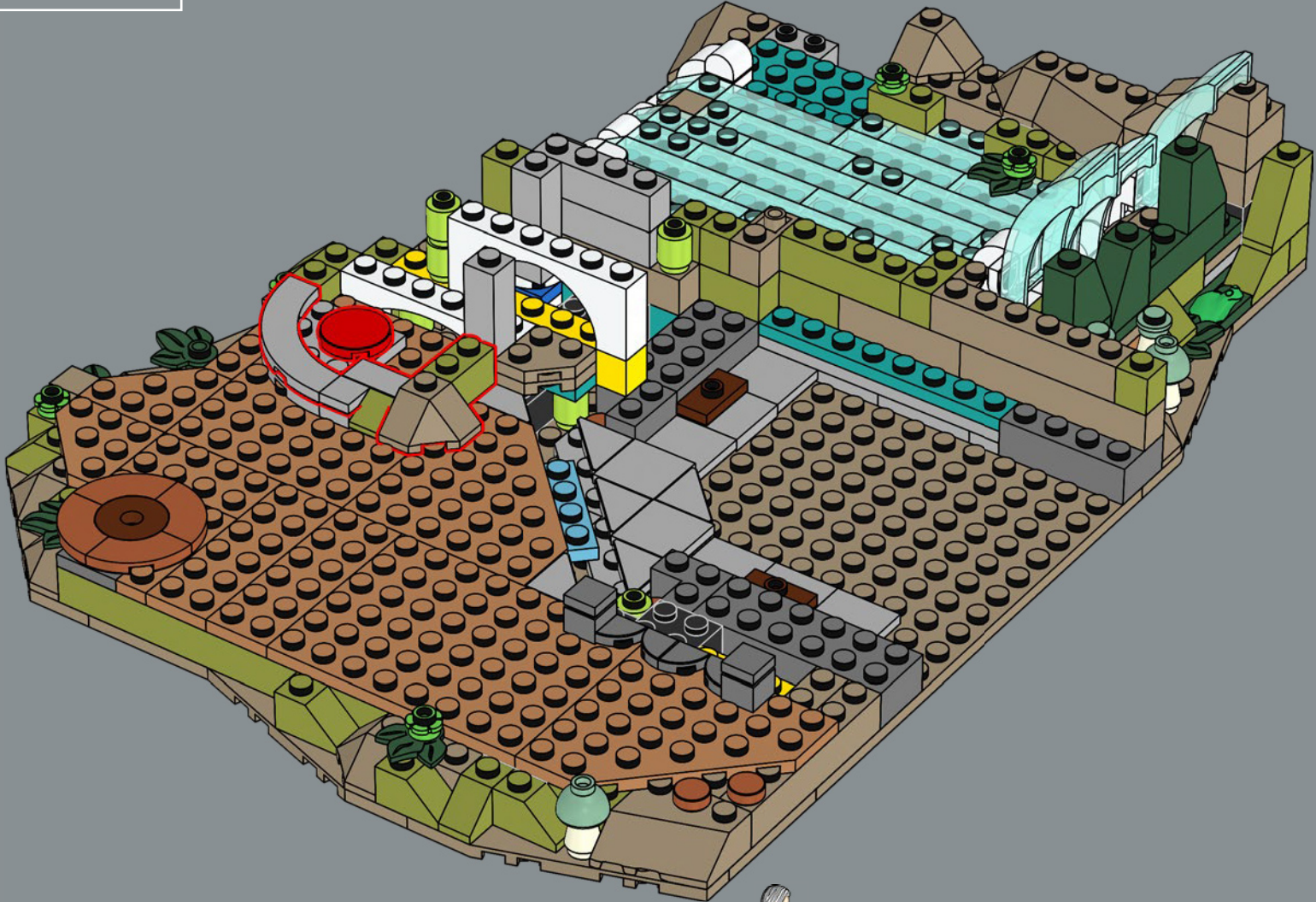

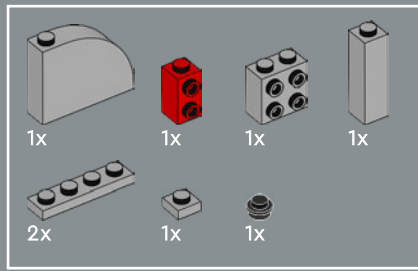

60

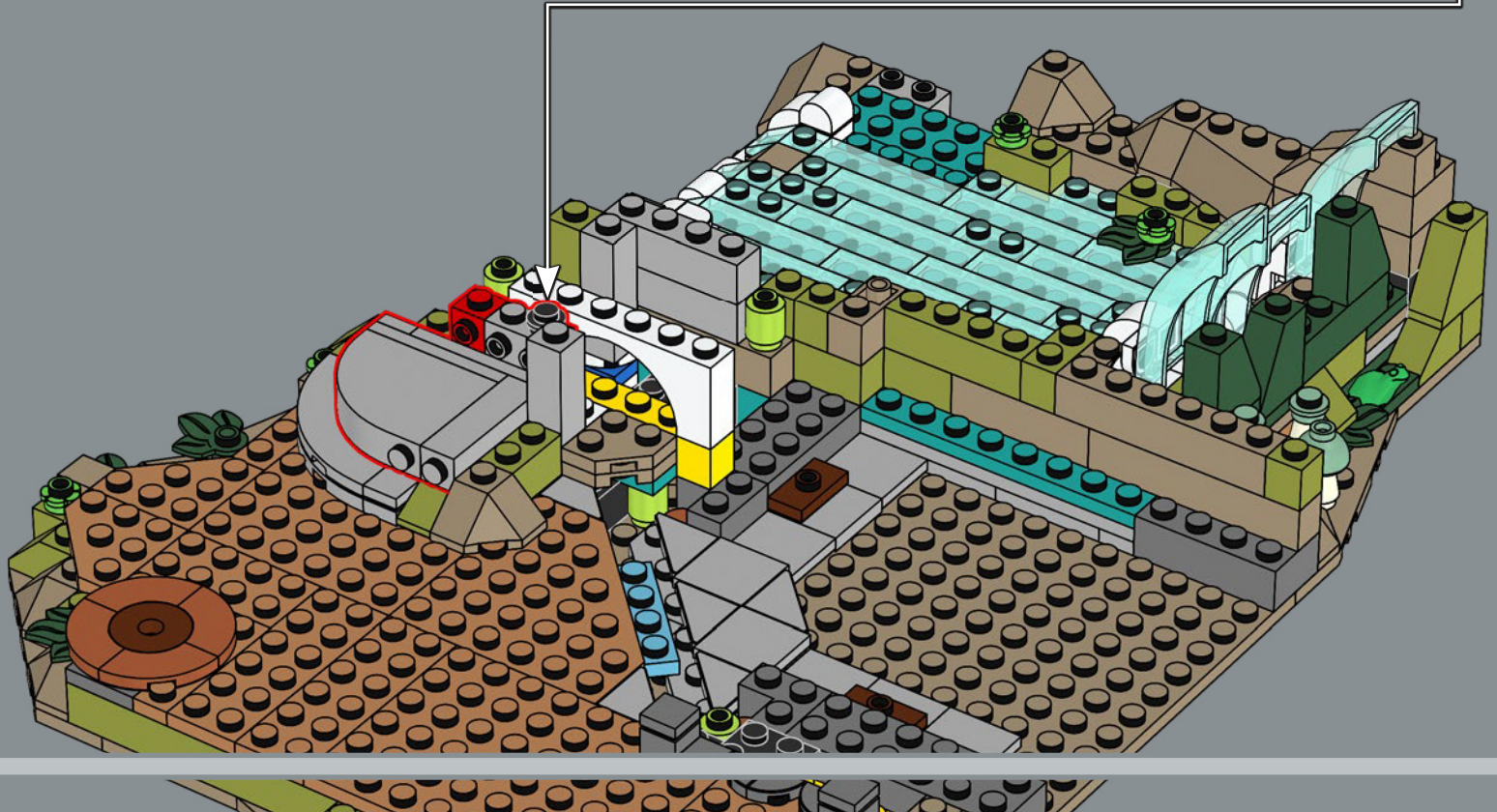
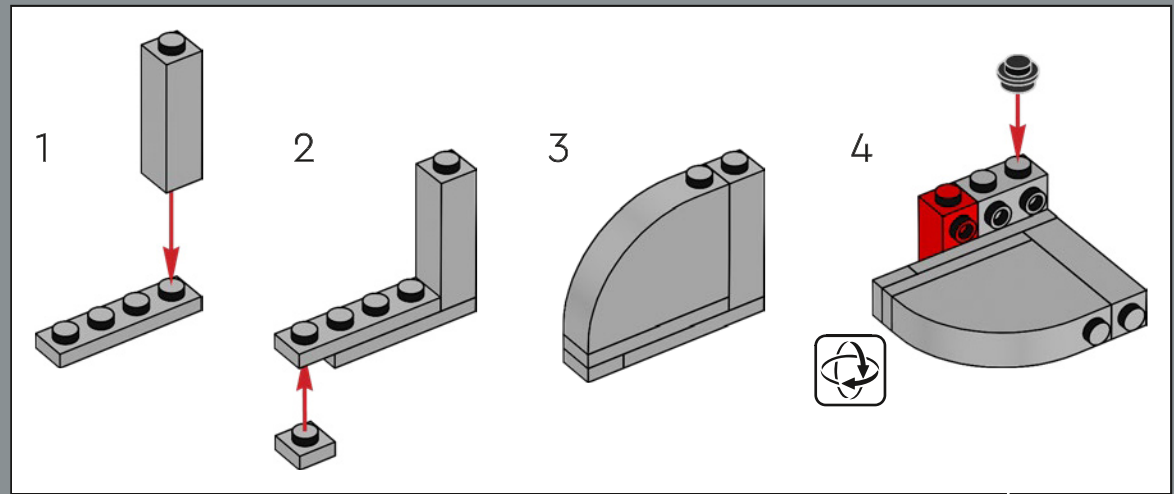

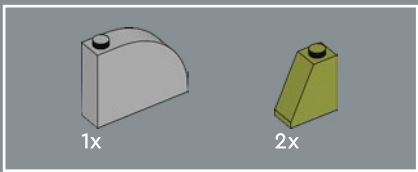

61

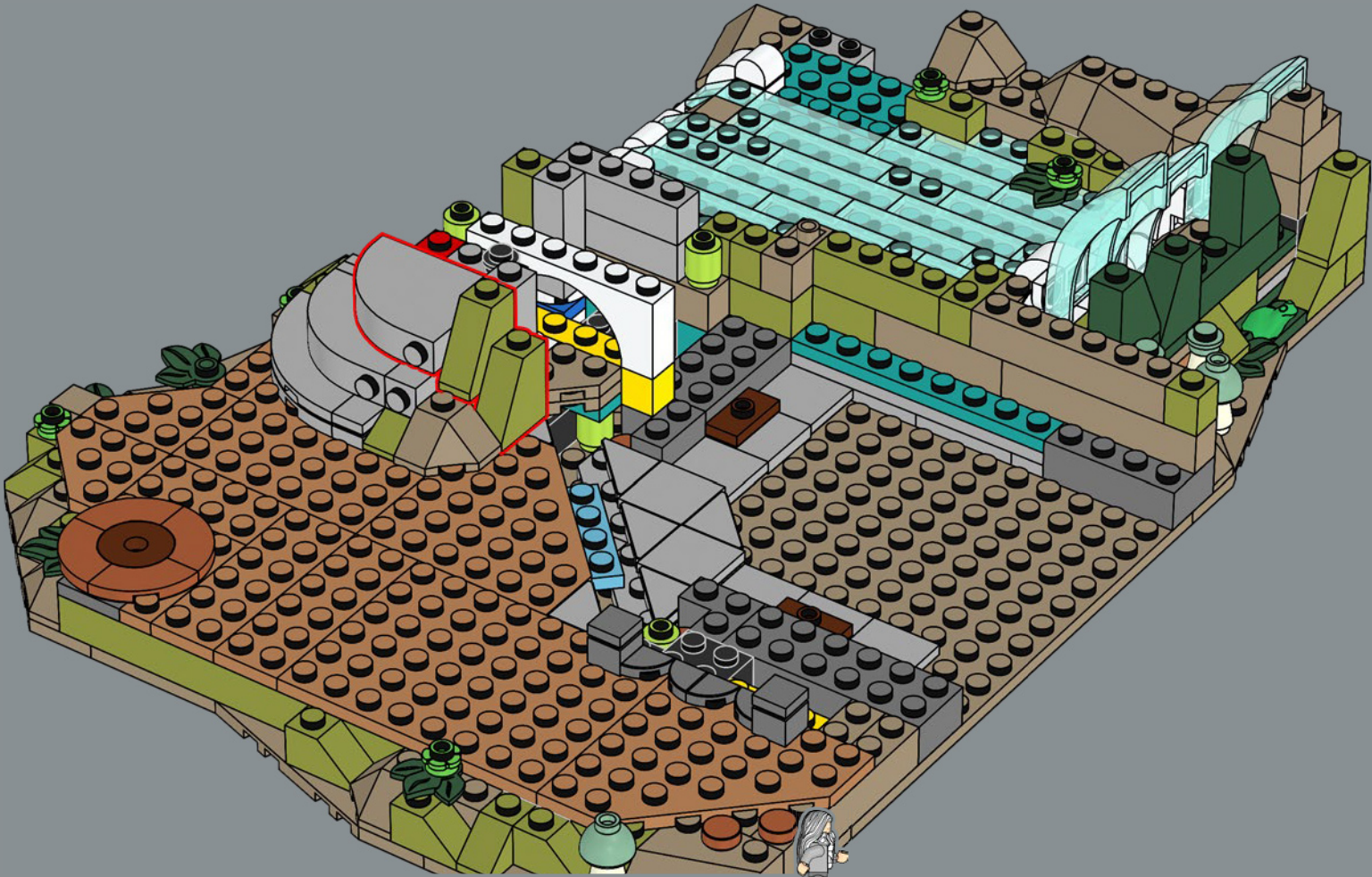

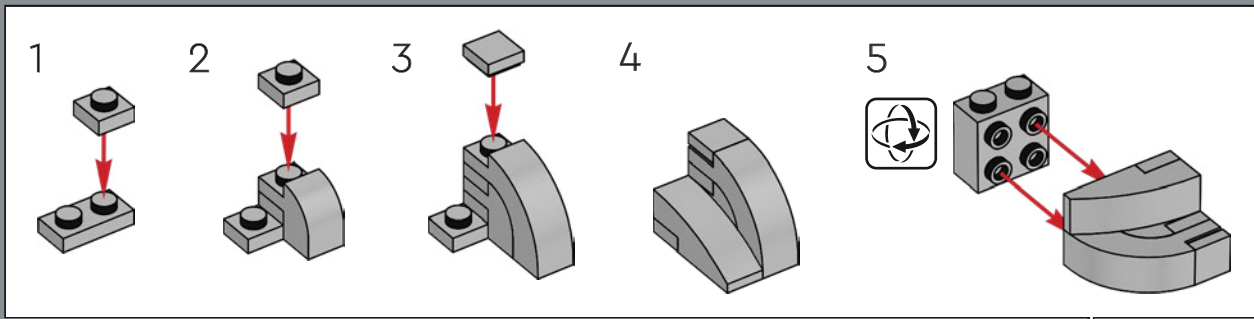
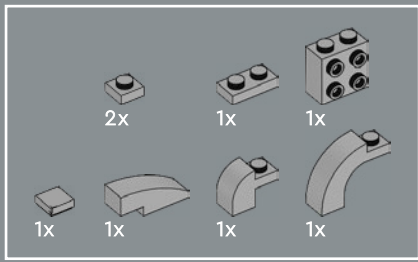

62

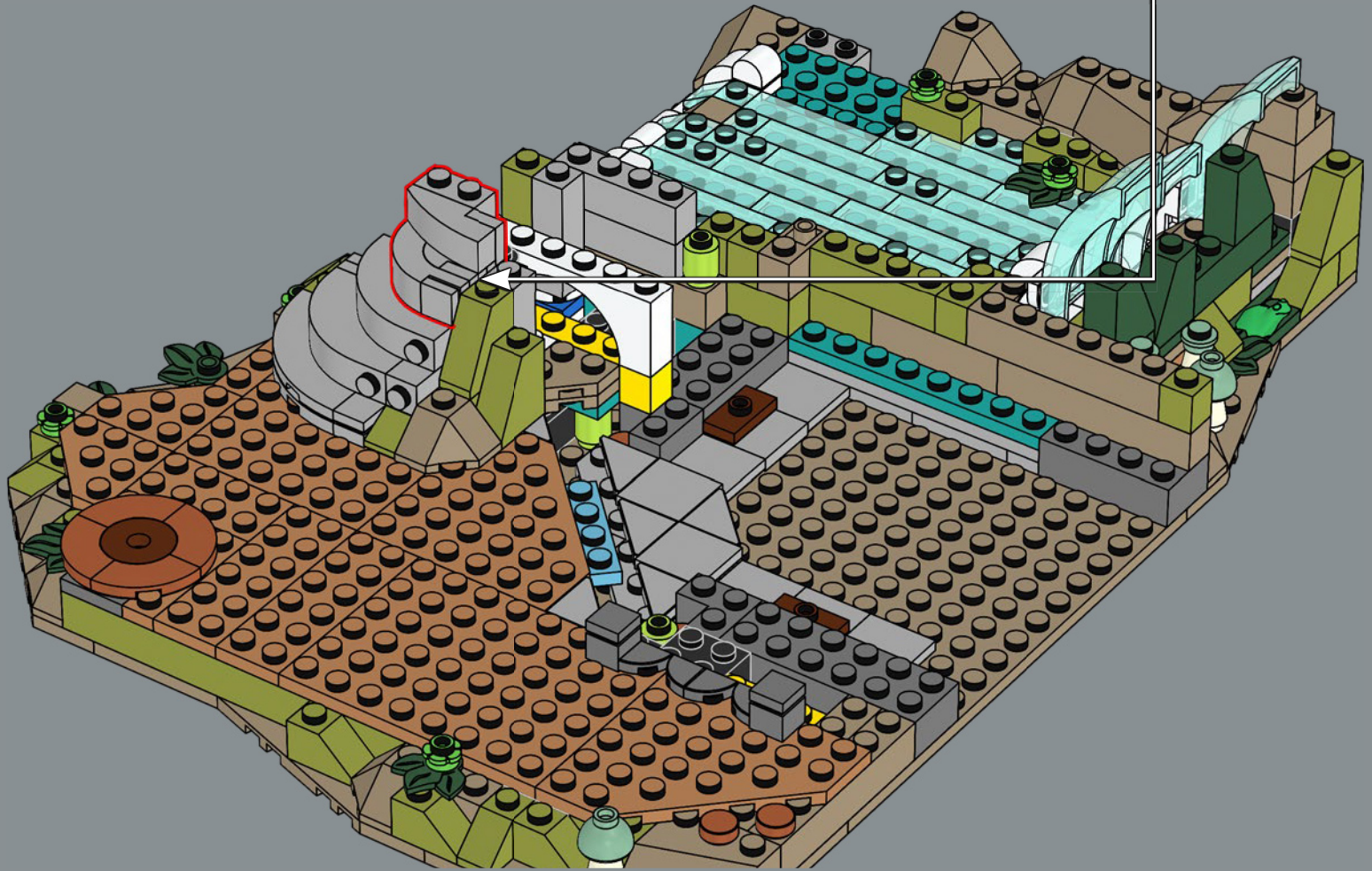

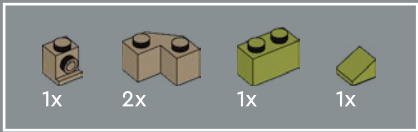

63

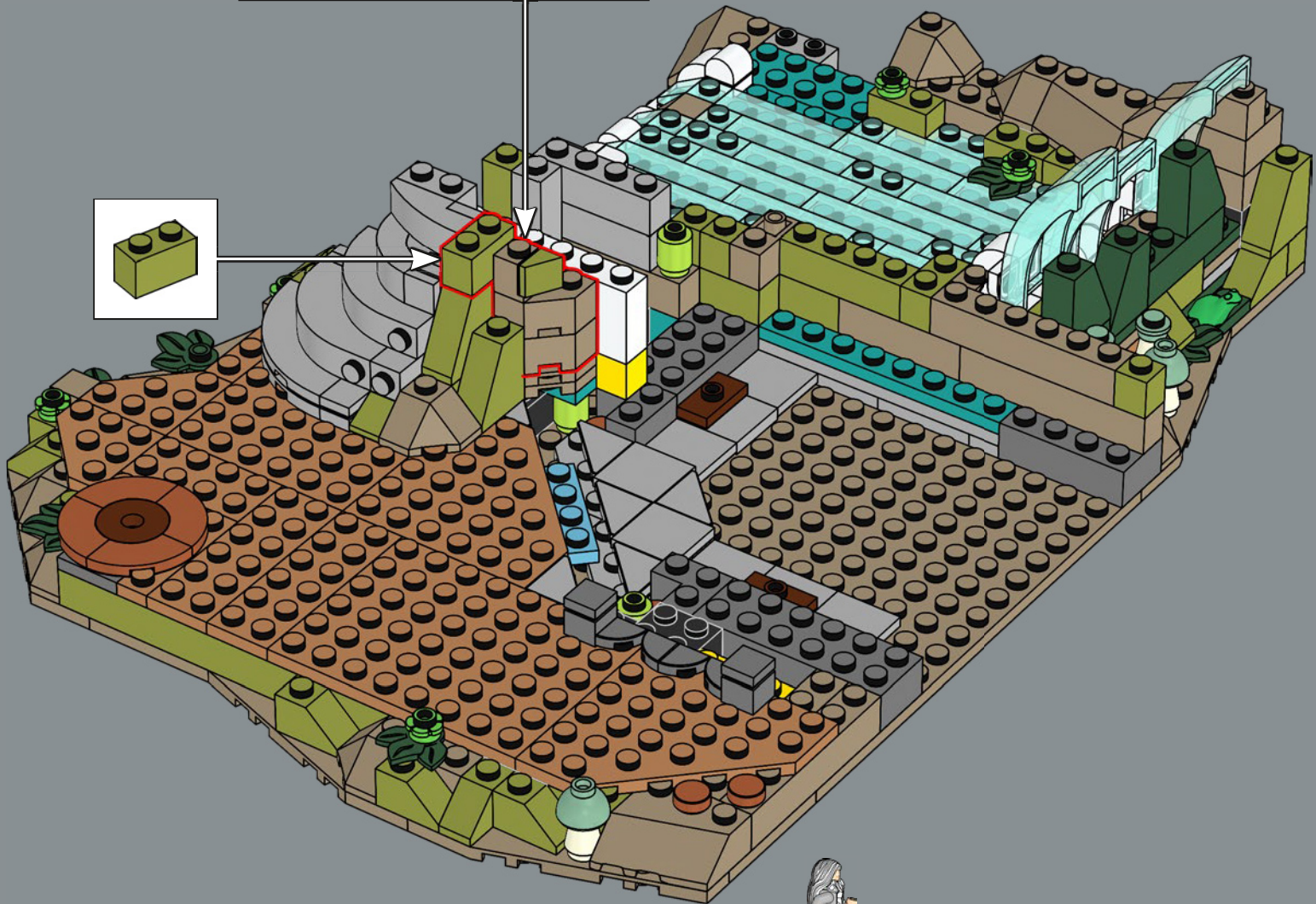
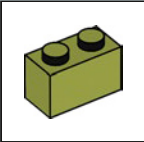
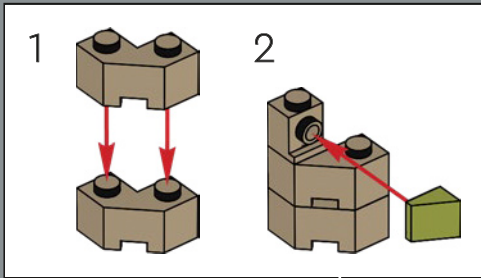

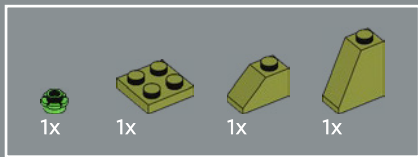

64

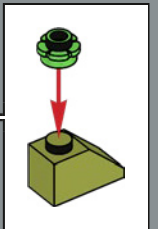
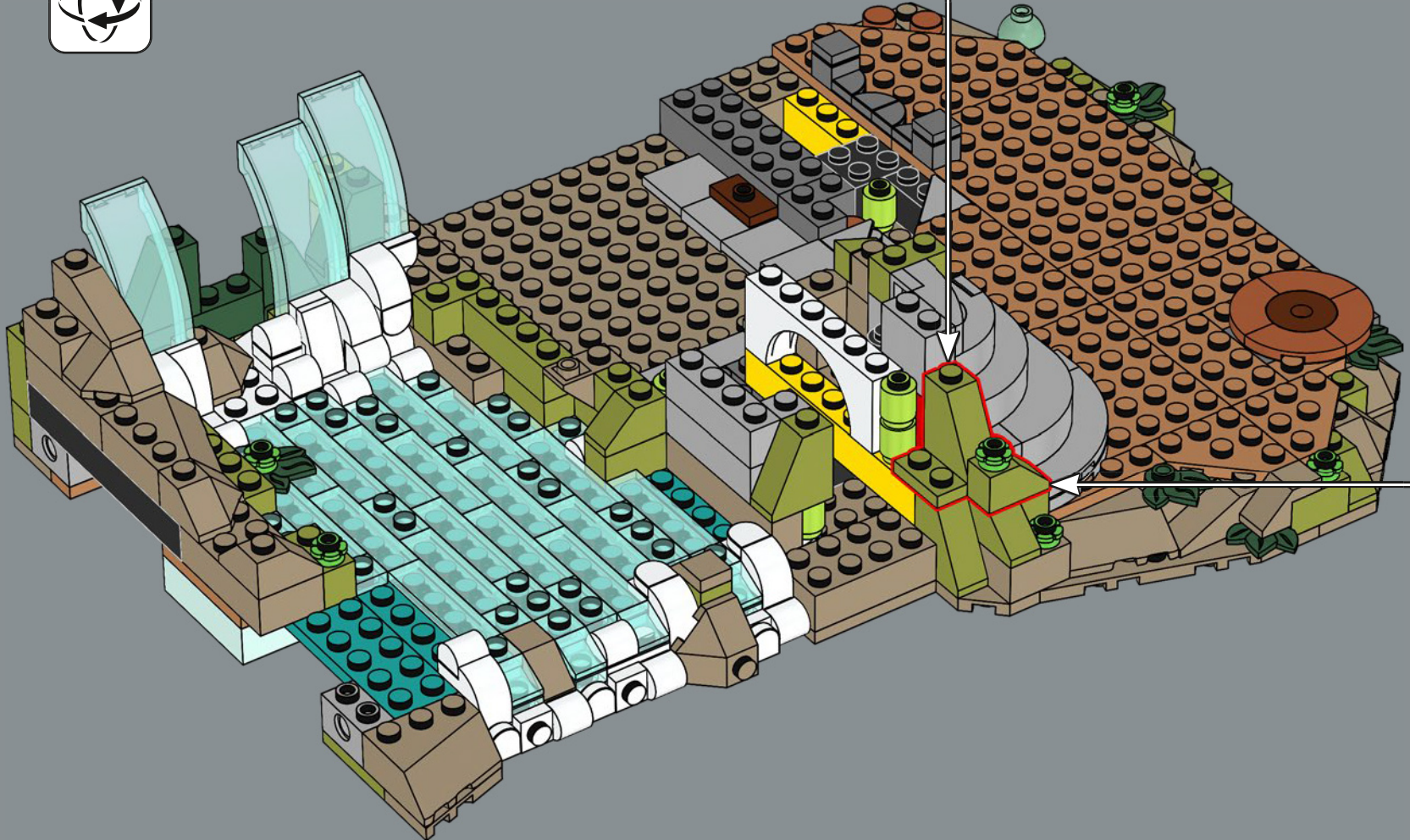
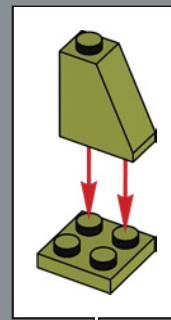

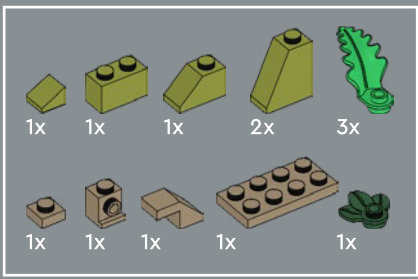

# 65

1

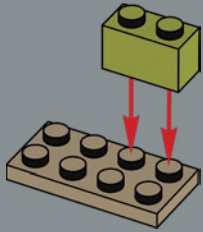

2

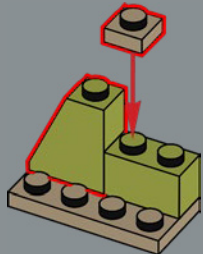

3

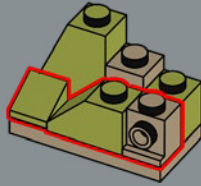

4

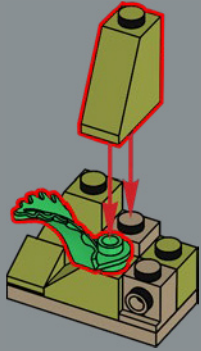

5

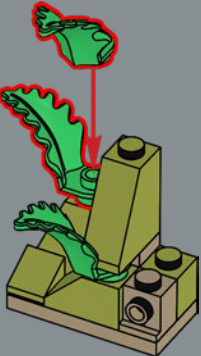

6

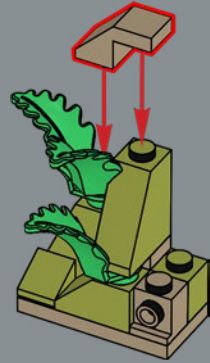

7

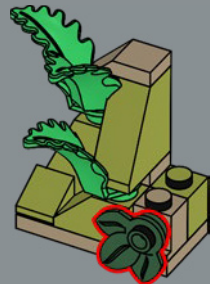



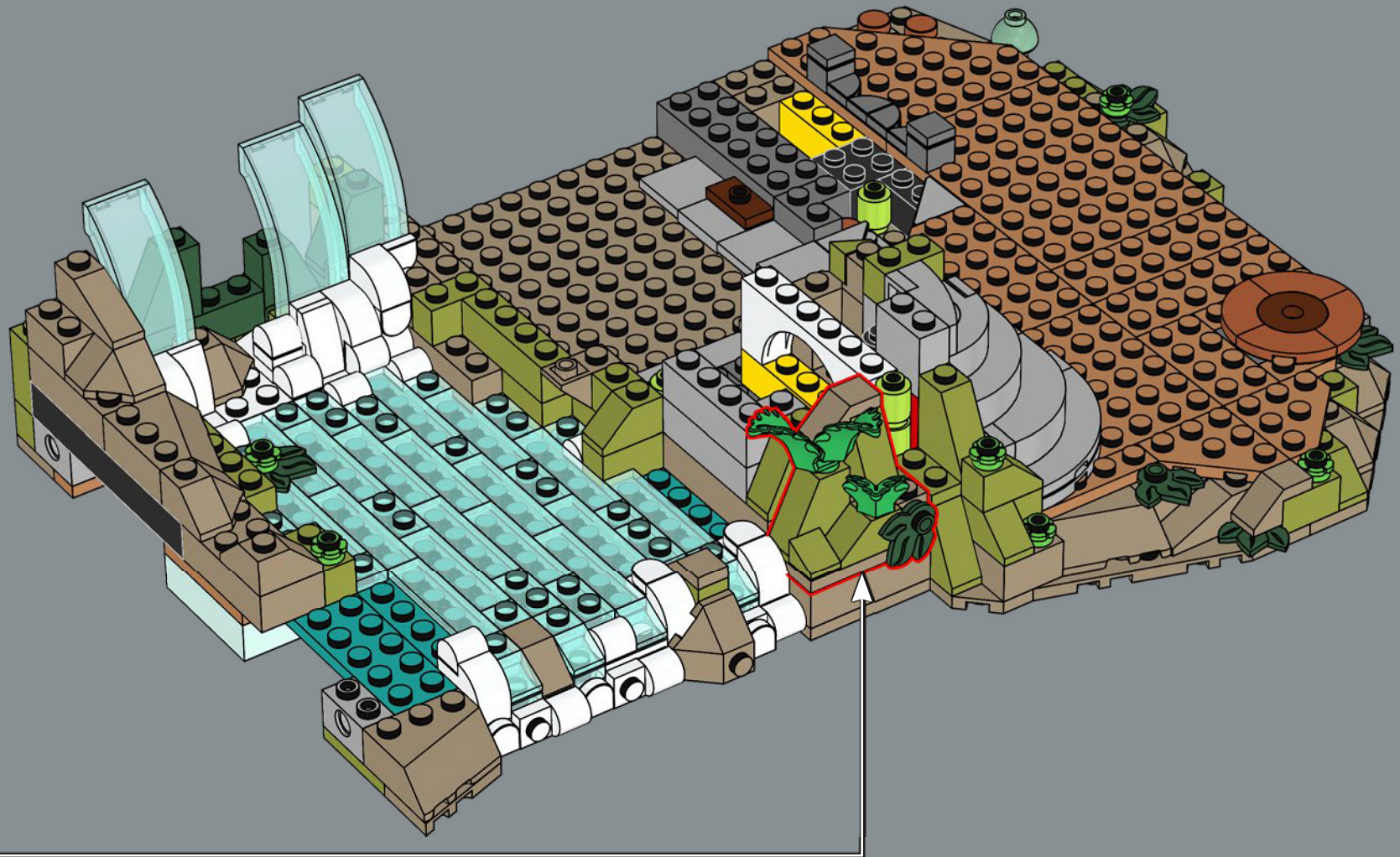

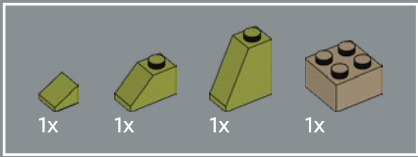

66

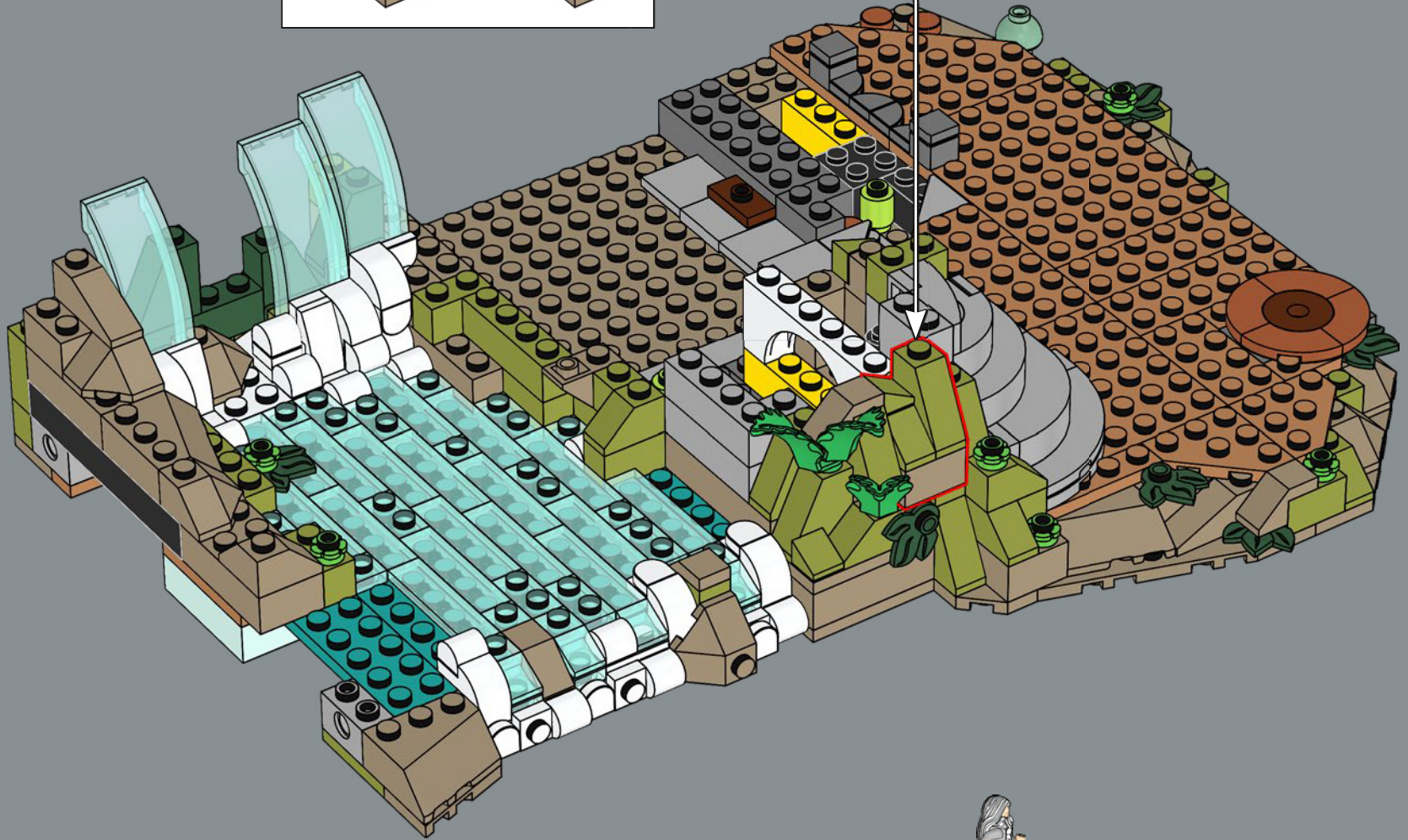
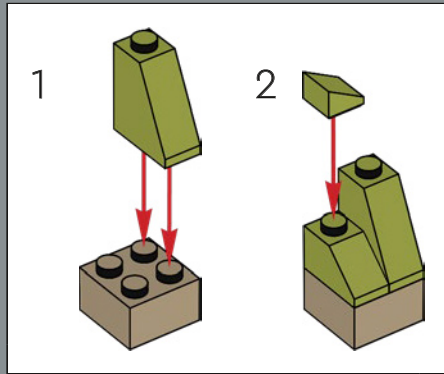

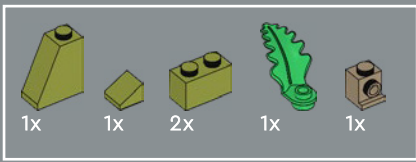

67

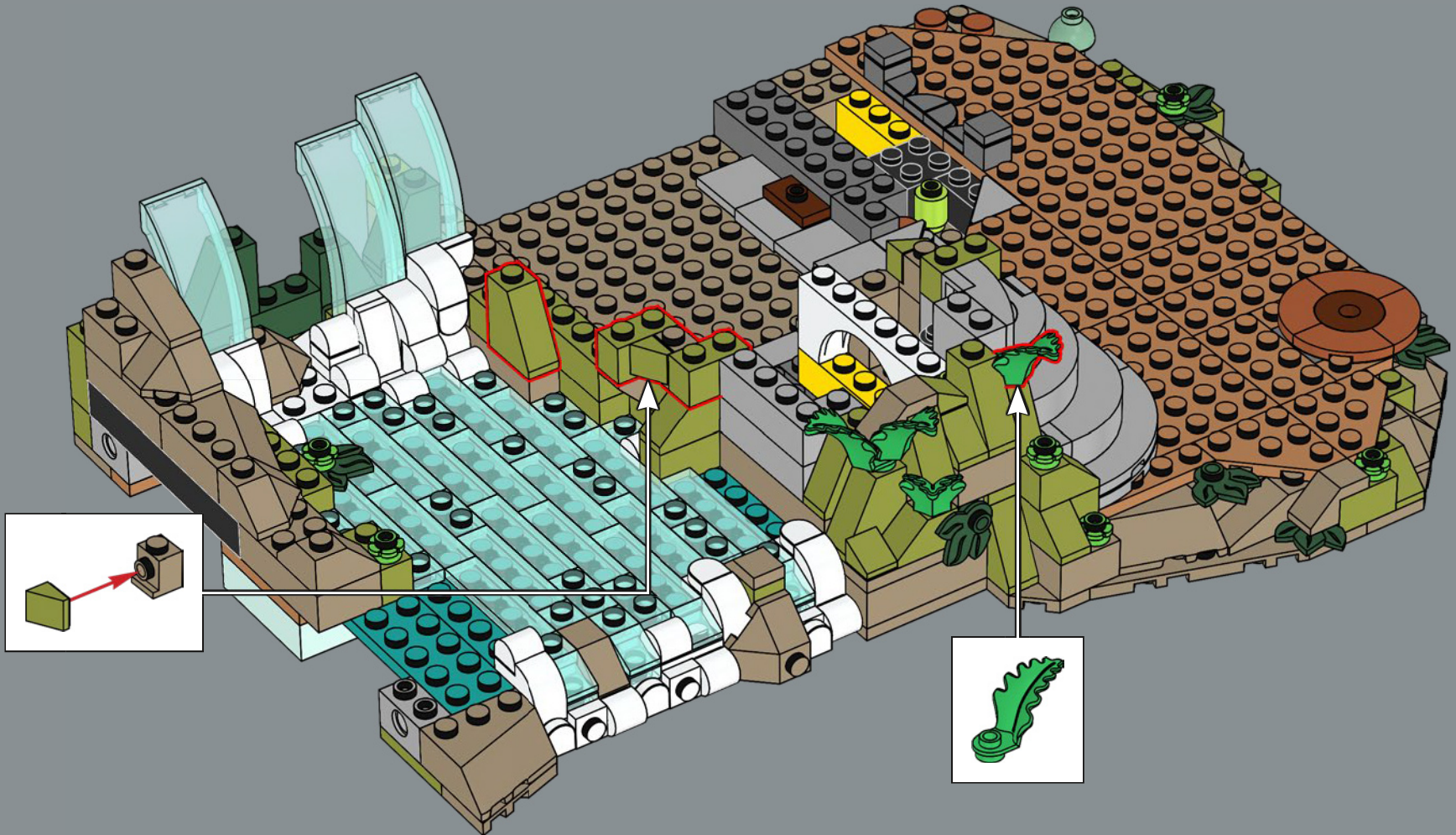

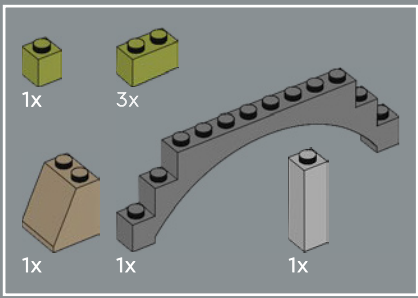

68



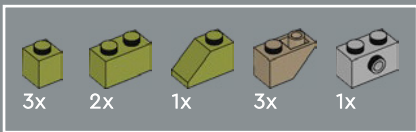

69

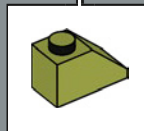
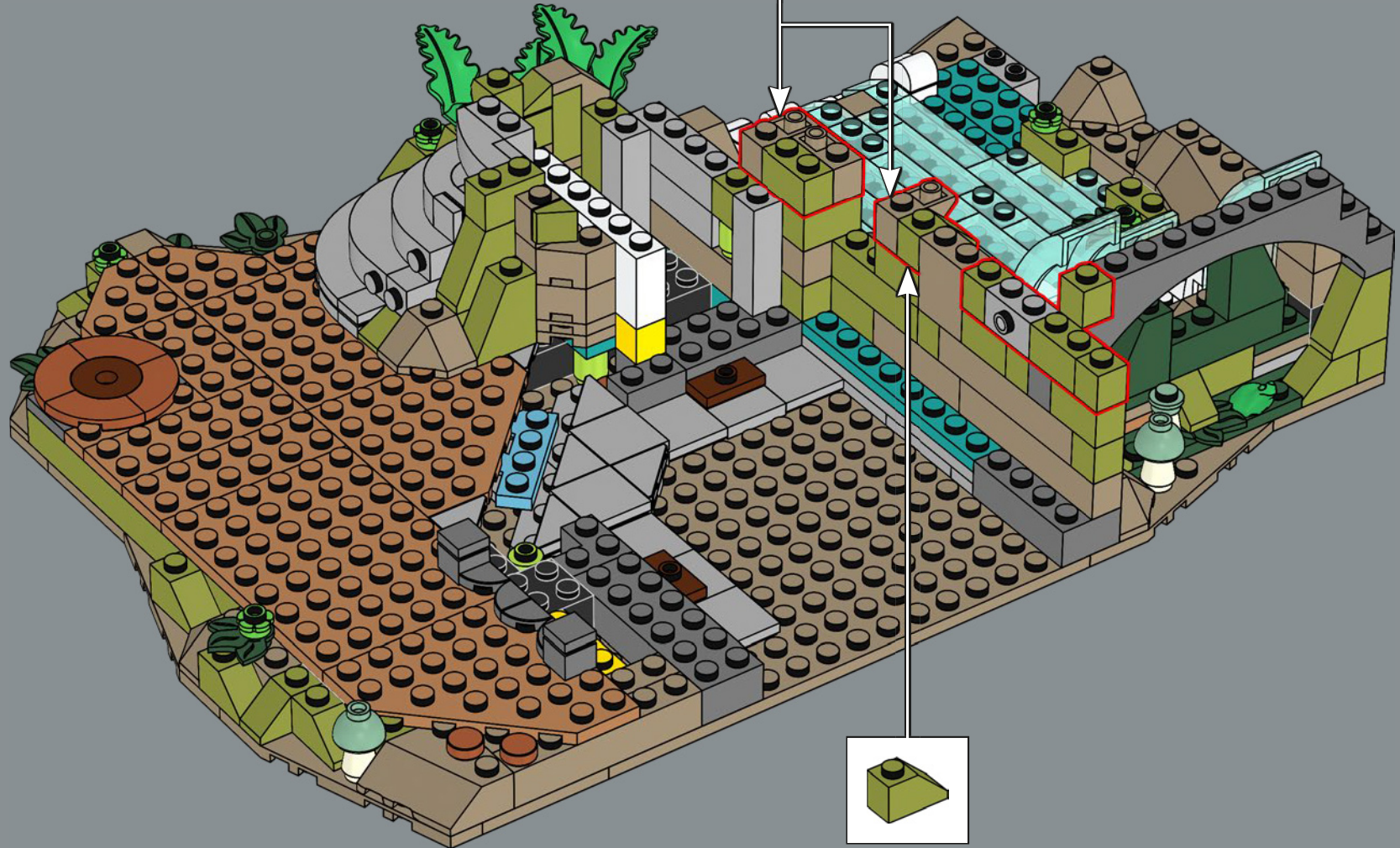
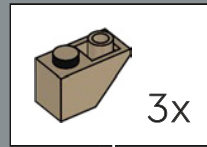

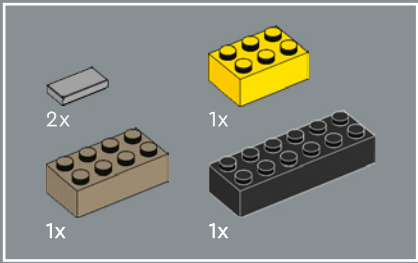

70

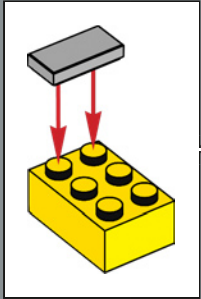
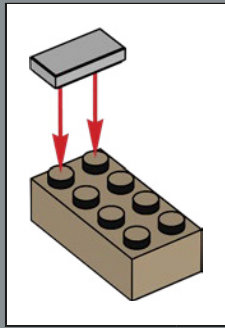

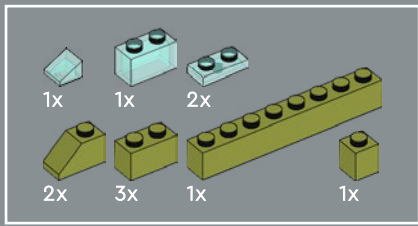

71



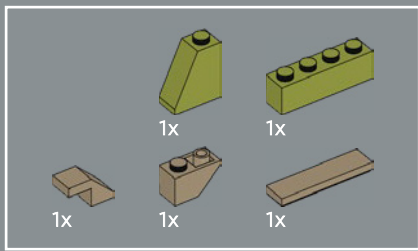

72





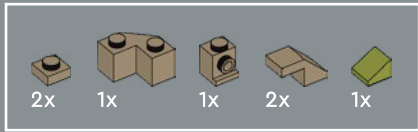

73

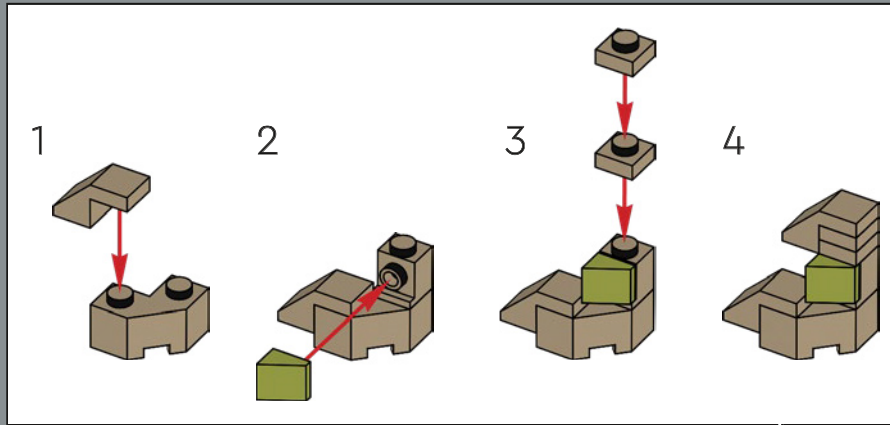

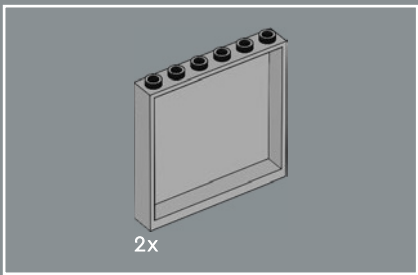

74

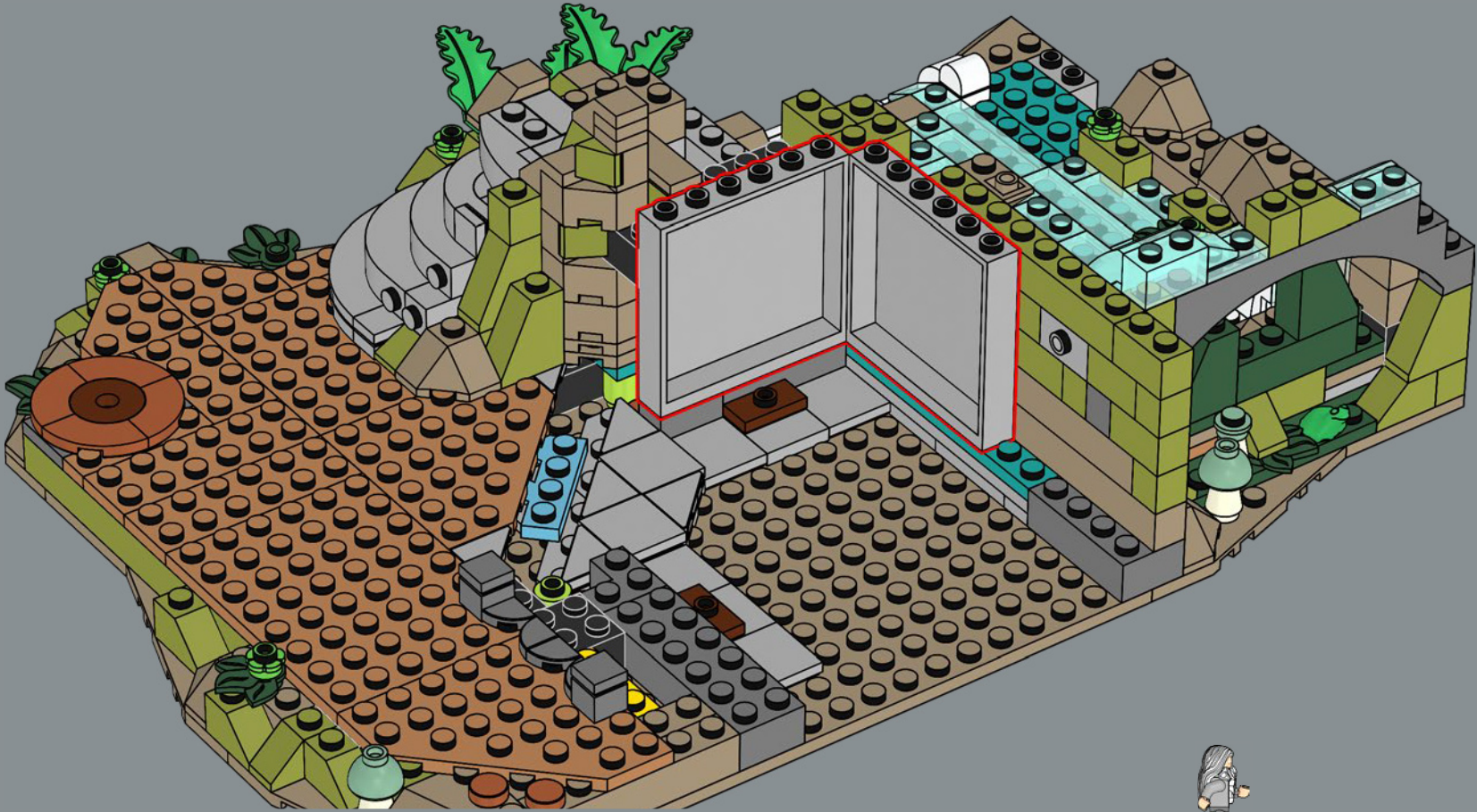

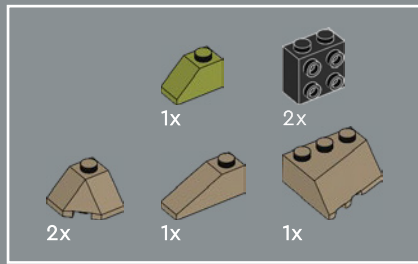

75

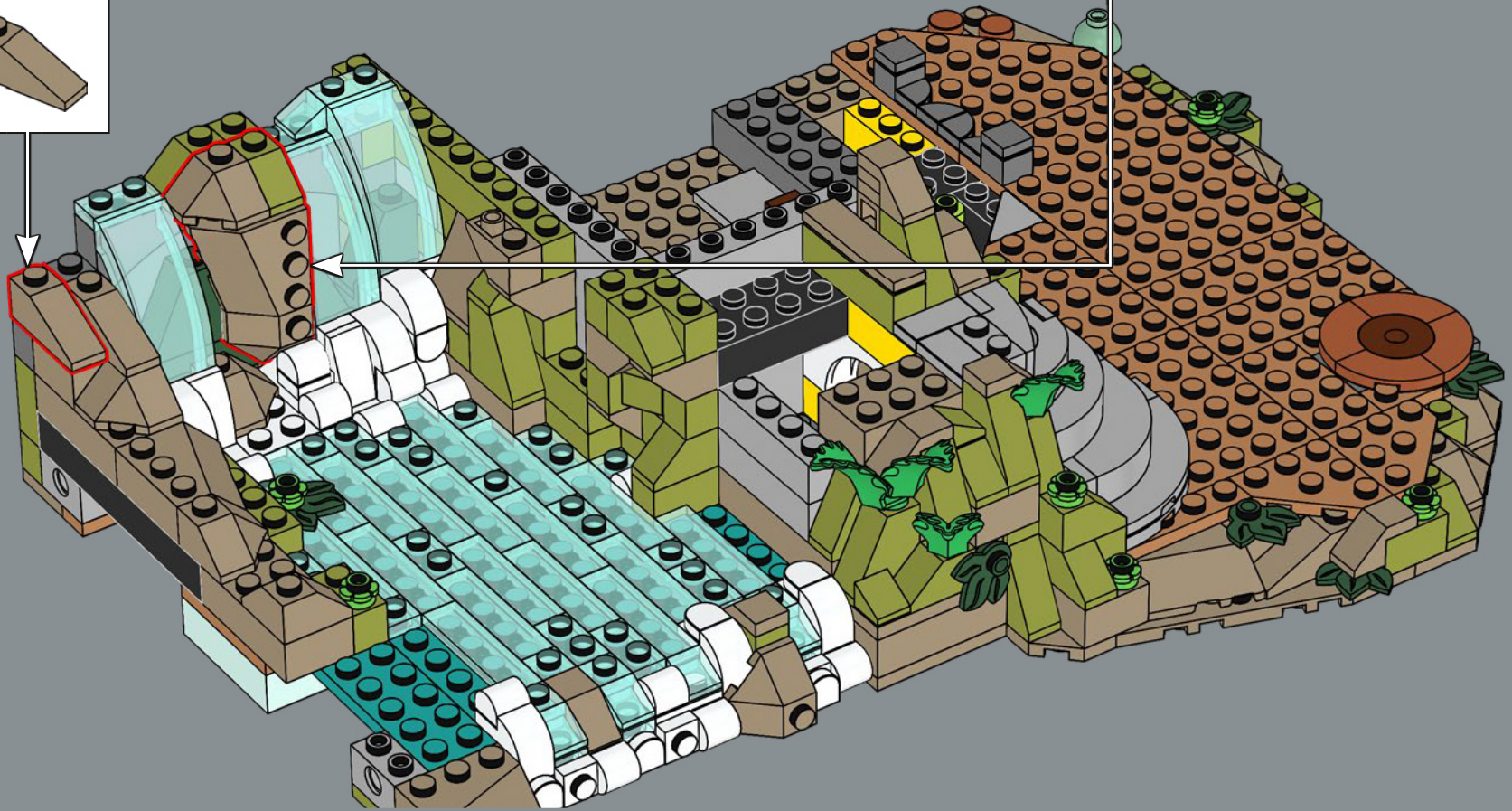
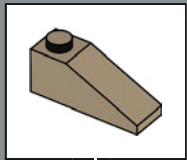
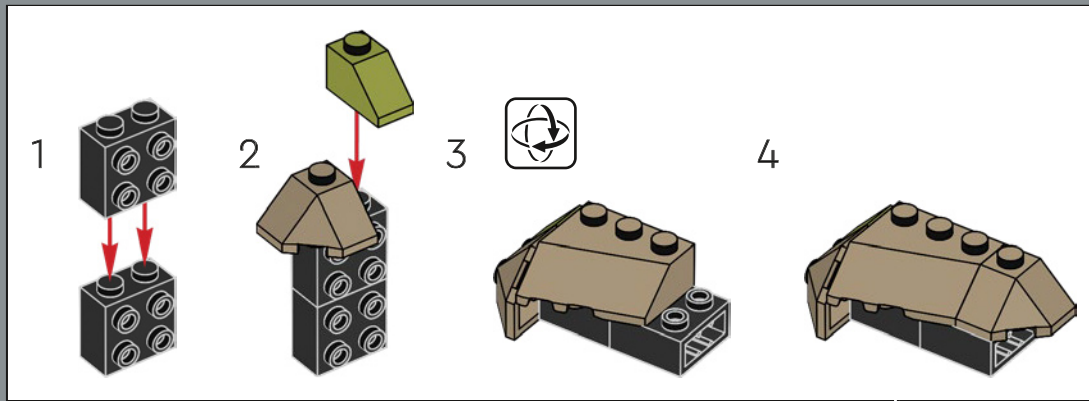

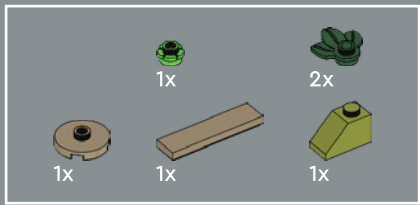

76

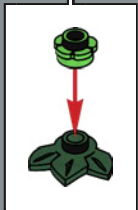
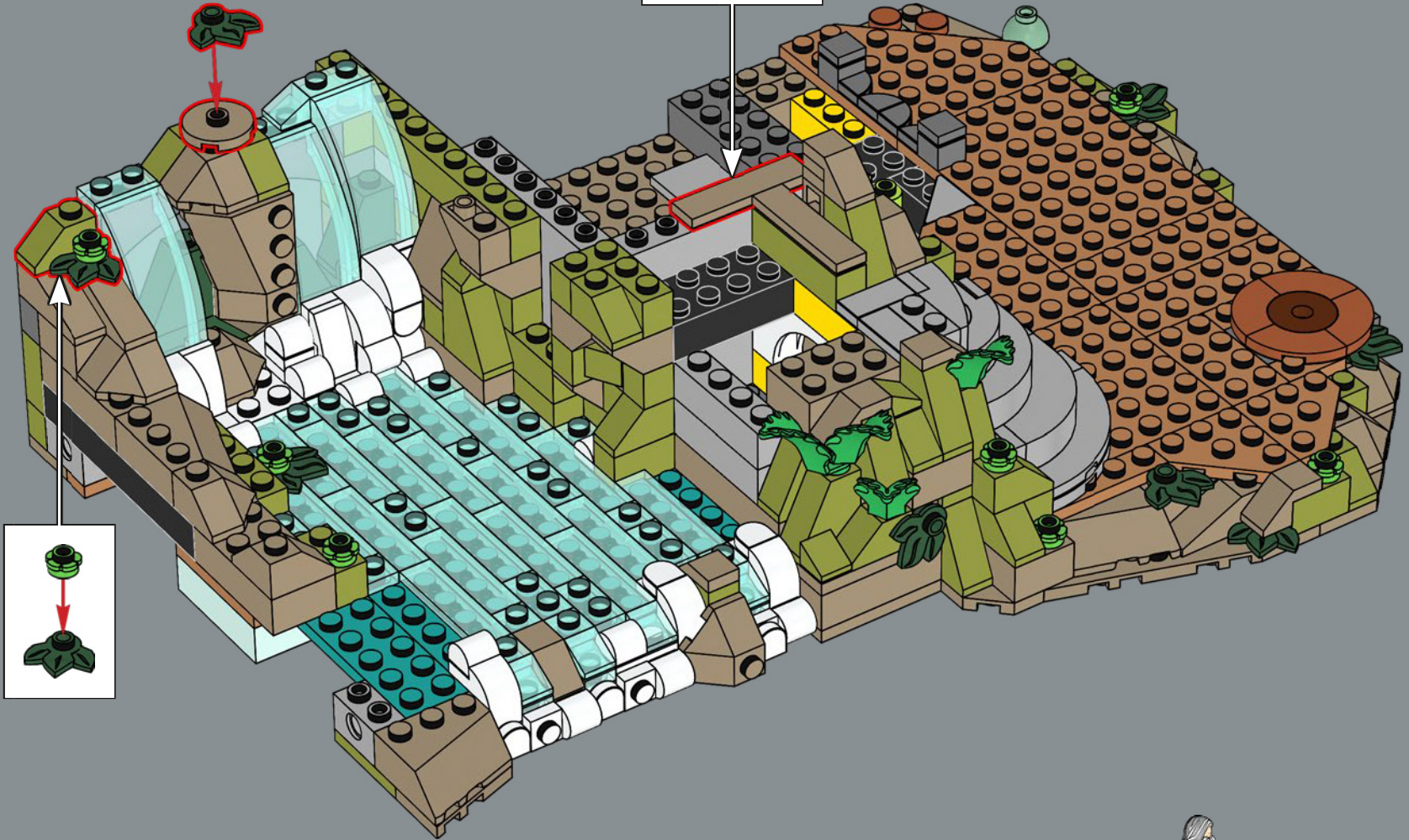
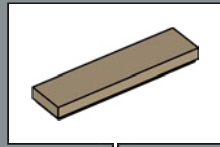

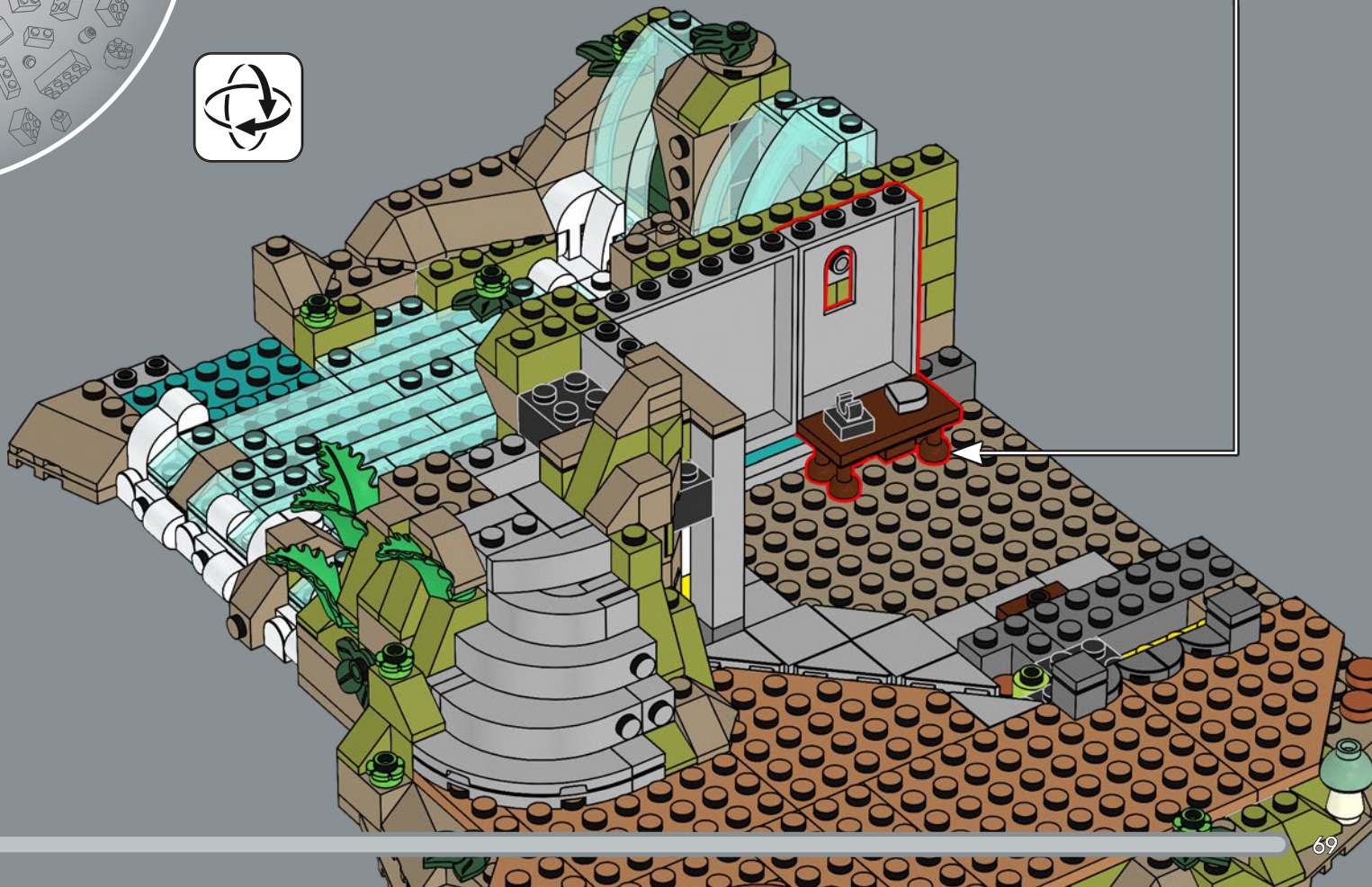
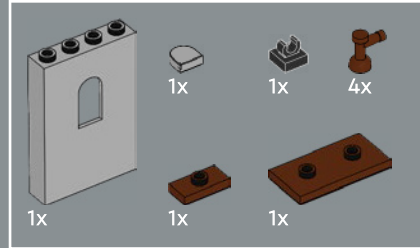
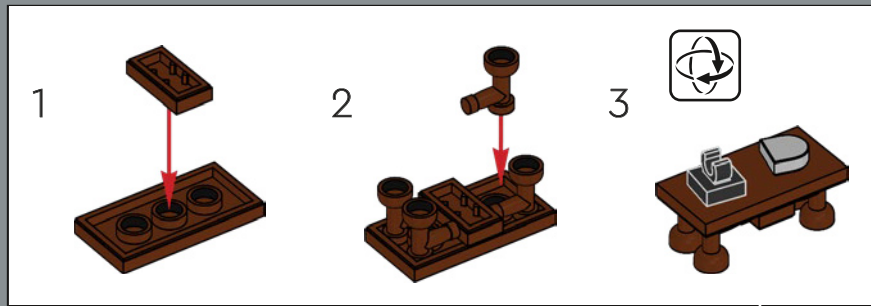

77

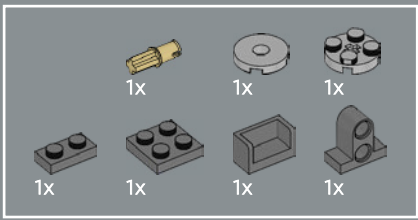

78

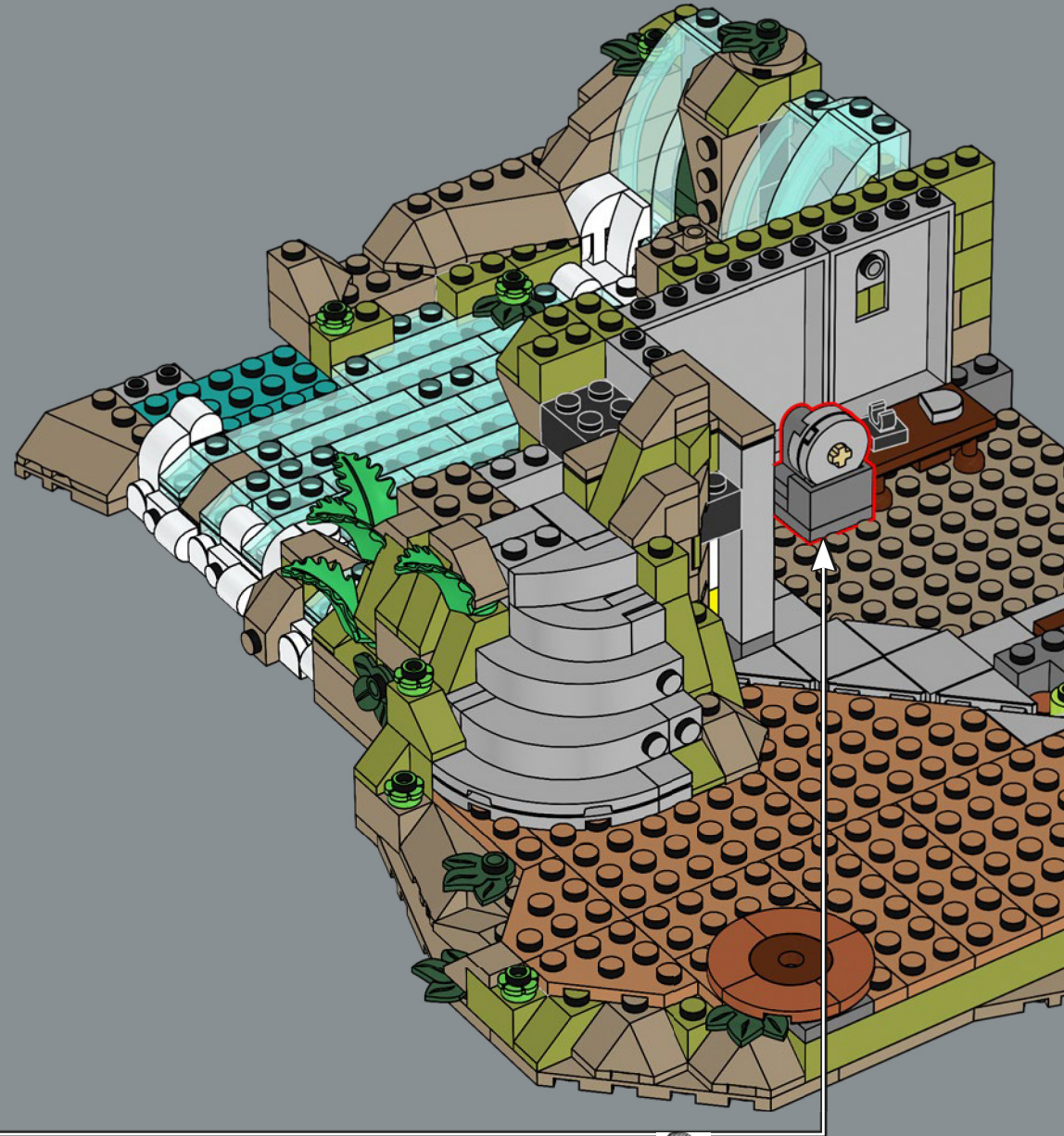
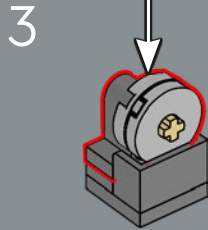
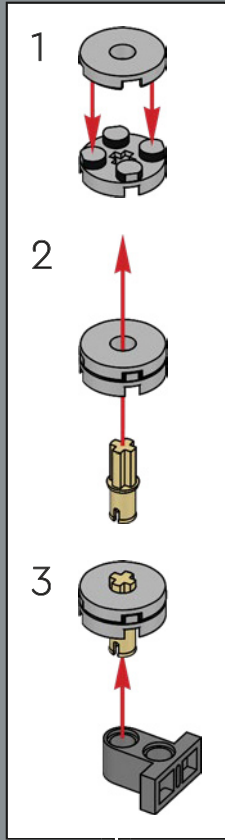
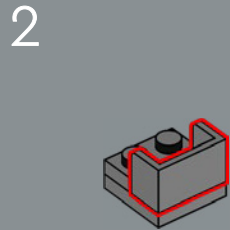
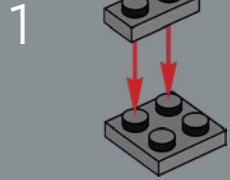



79

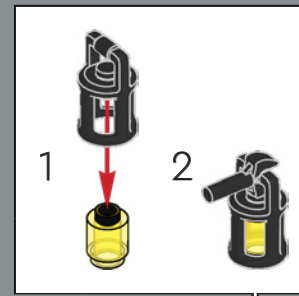

Das Fenster in diesem 1×4×6 Wandelement ist zwar verbaut, lässt aber dennoch Licht in dieses Zimmer.

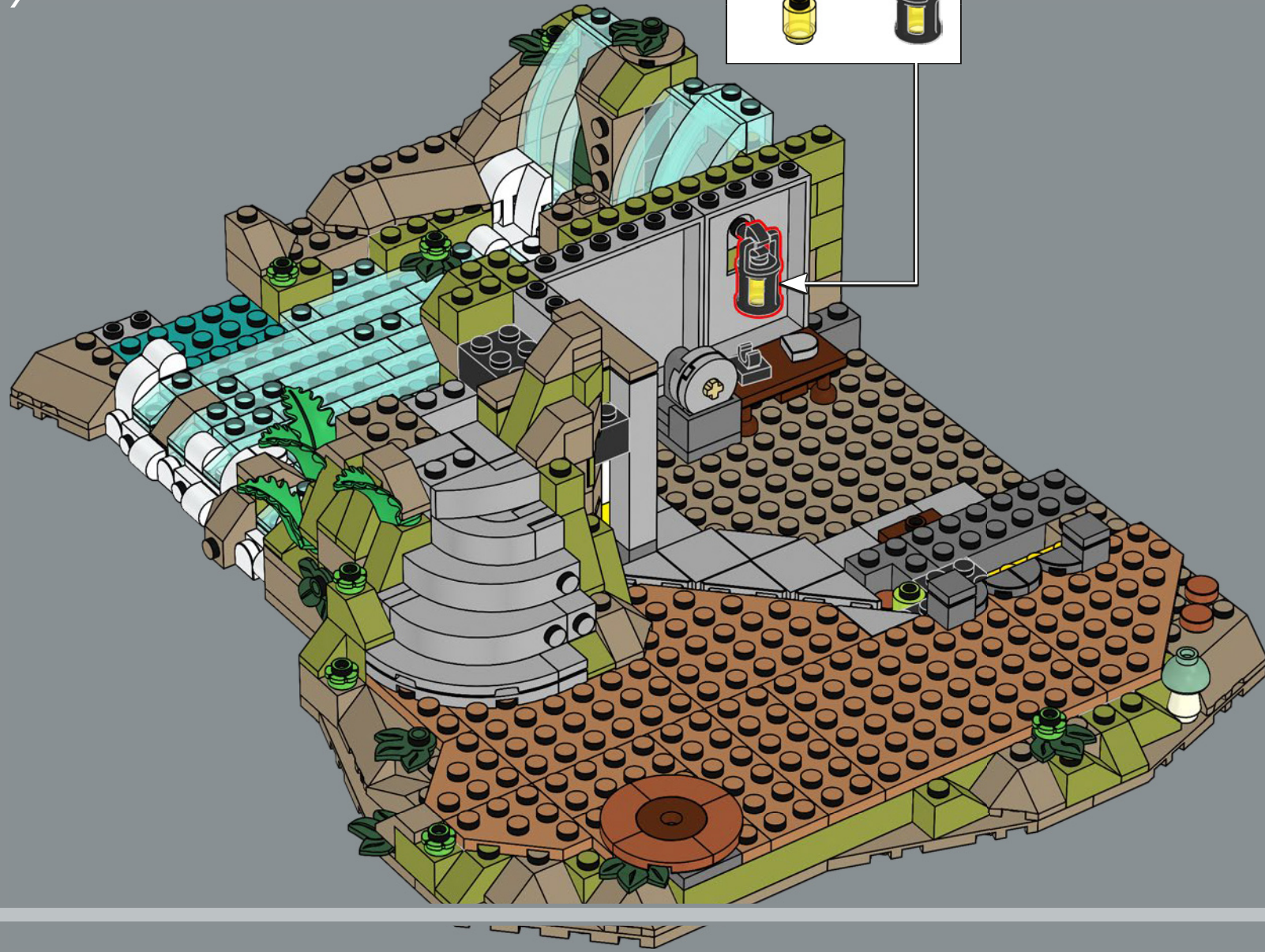

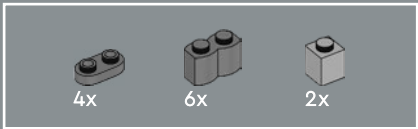

80

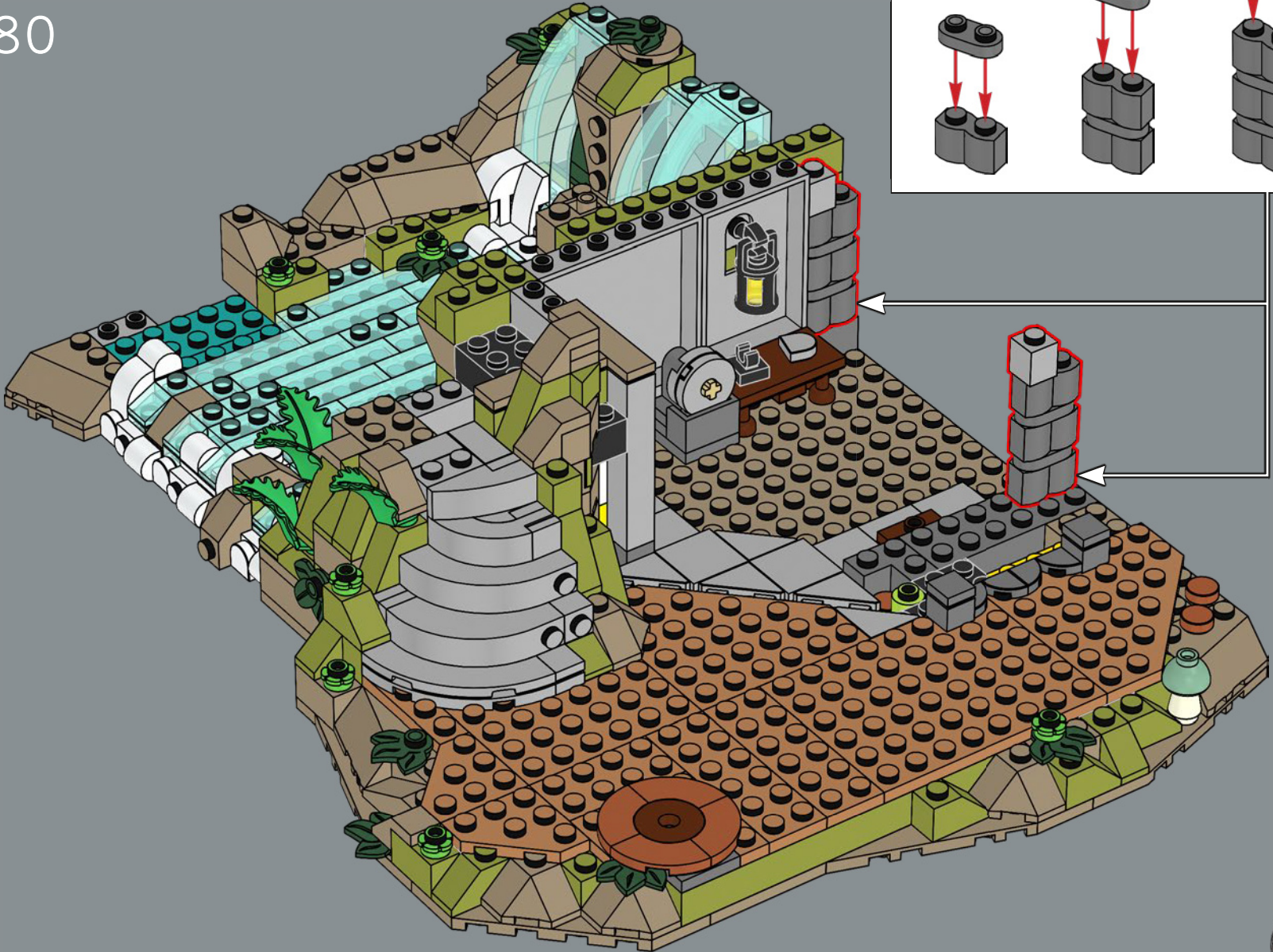
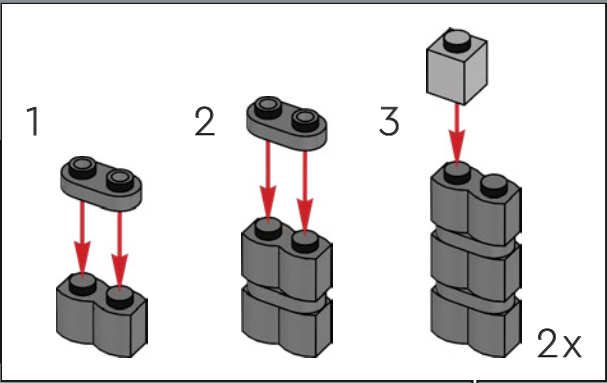



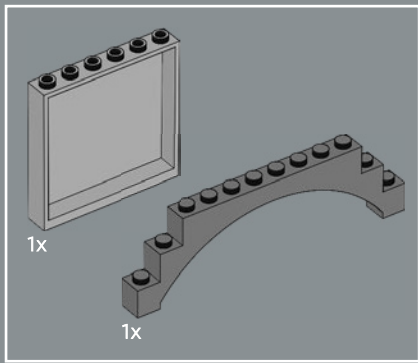

81

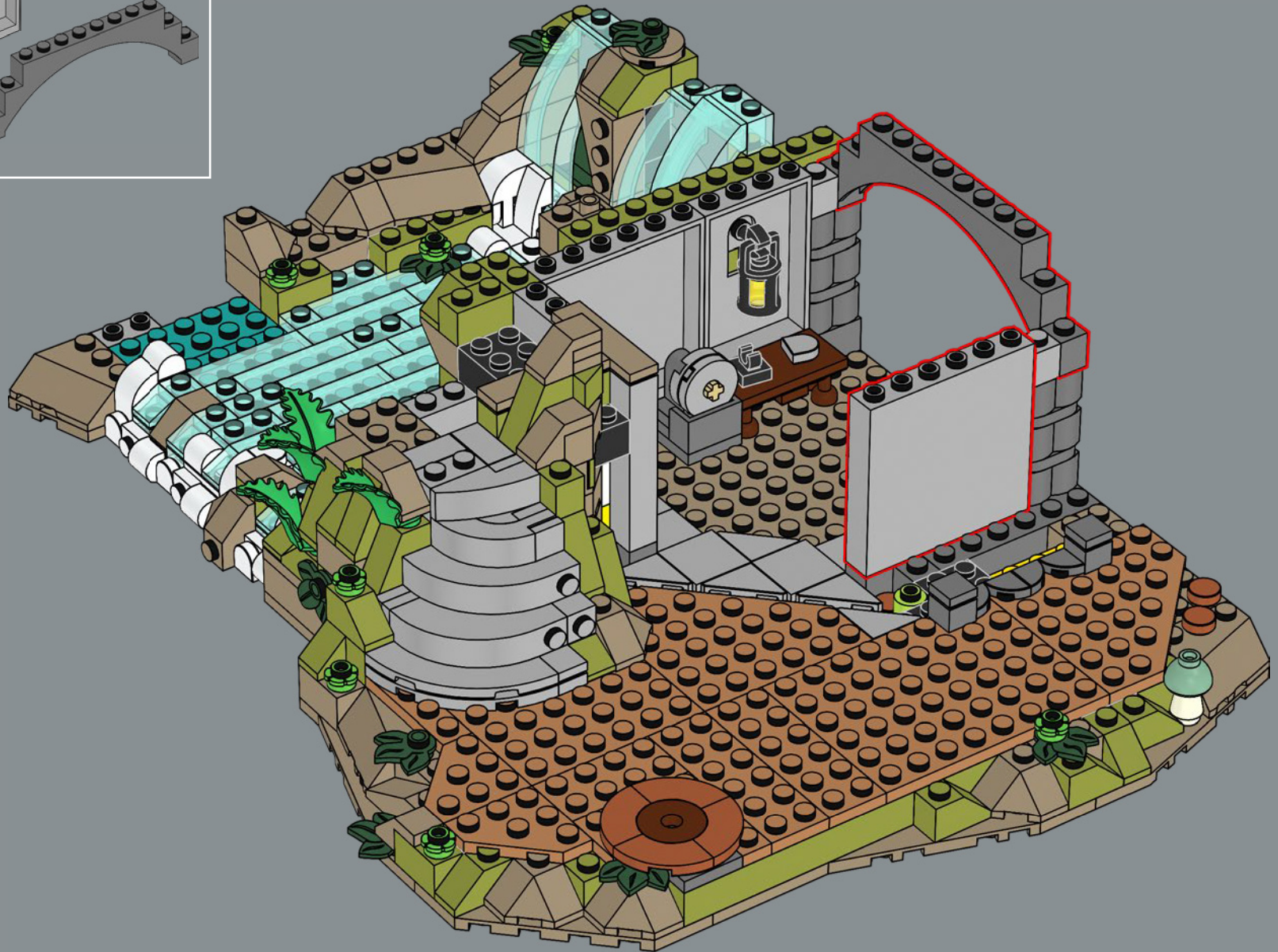

1x 2x 1x

82

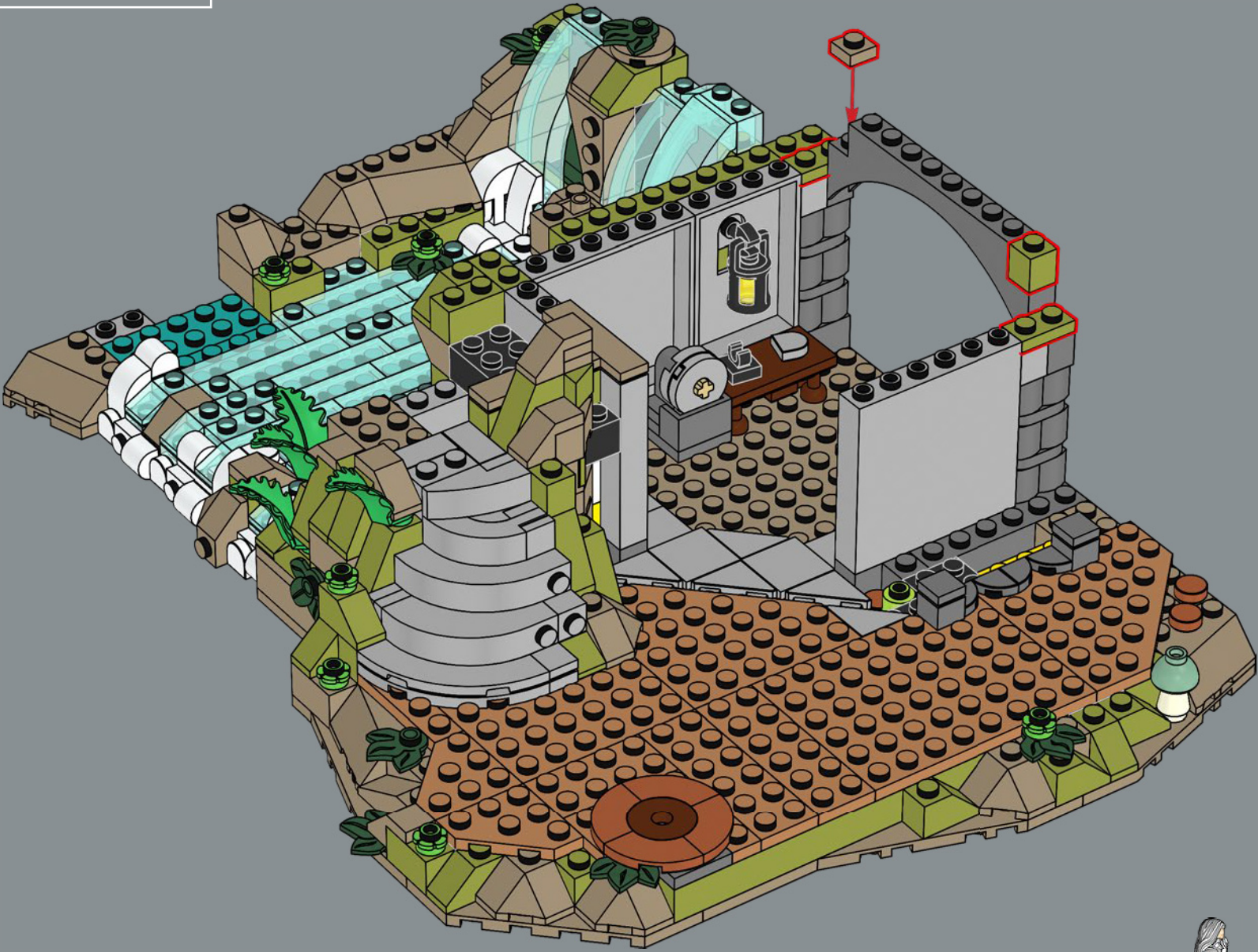

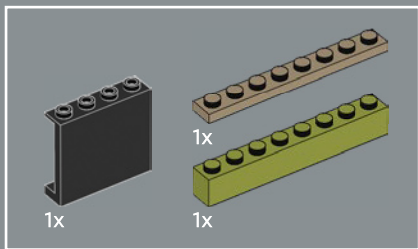

83

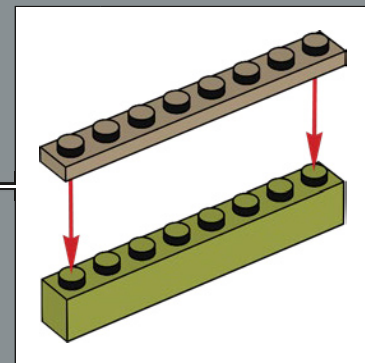
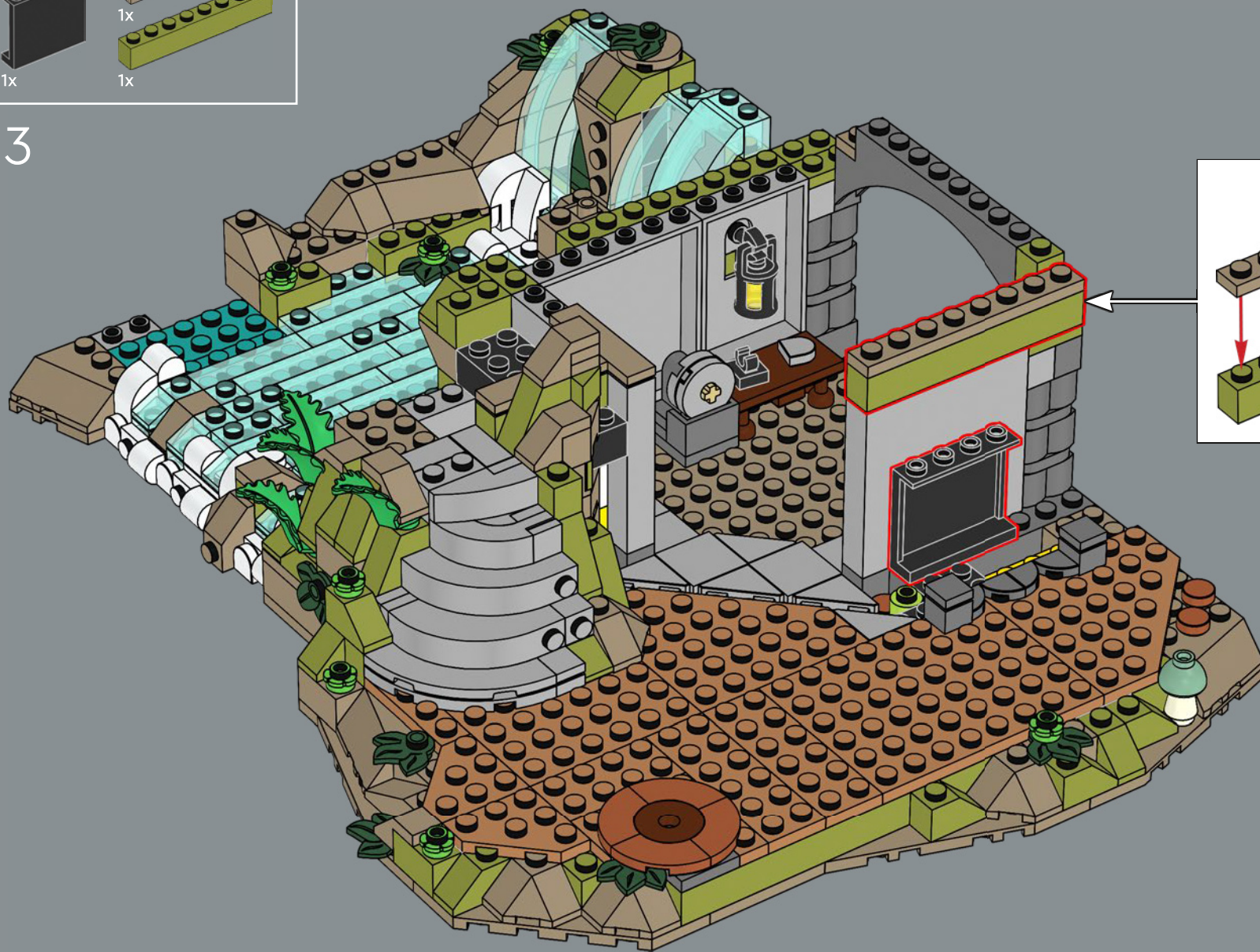

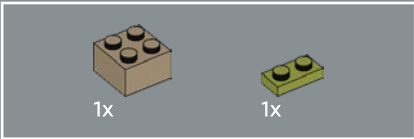
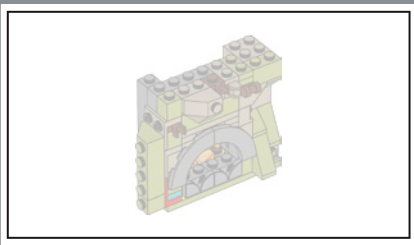

84

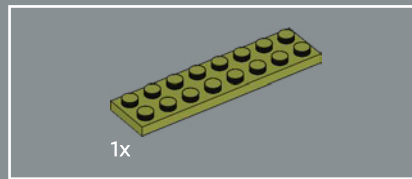
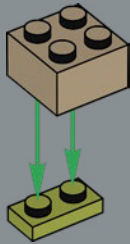

85

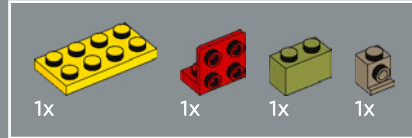
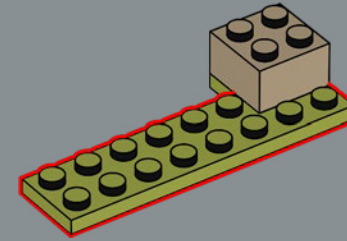

86

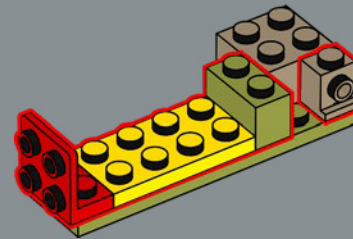



87

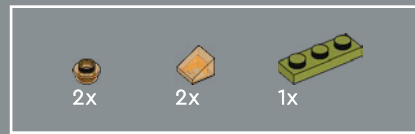
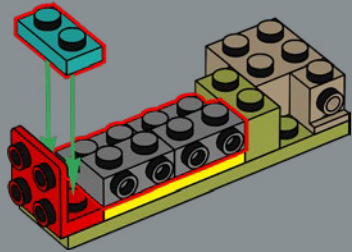

88

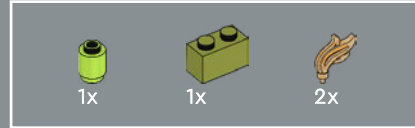
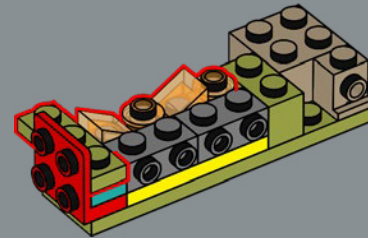

89

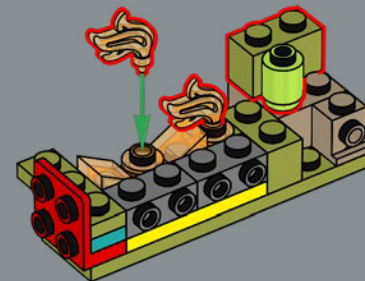

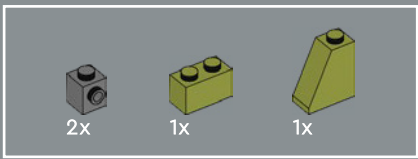

90

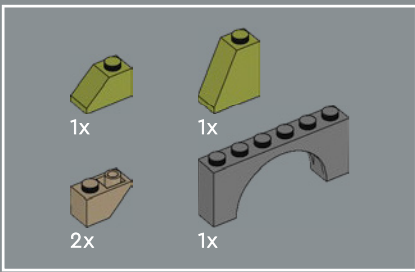
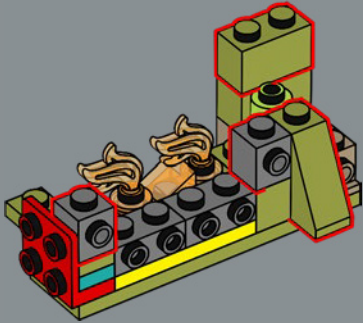

91

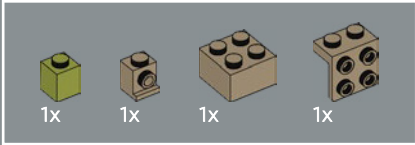
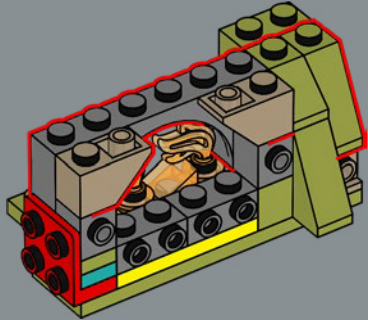

92

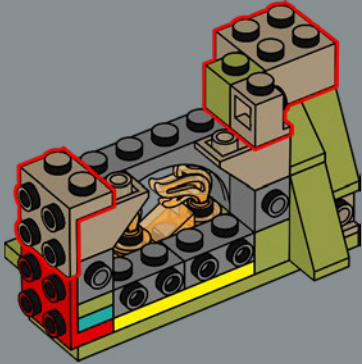

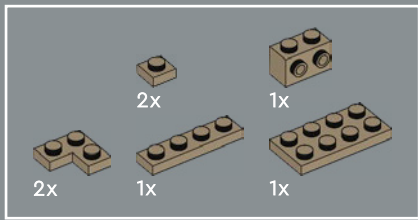

93

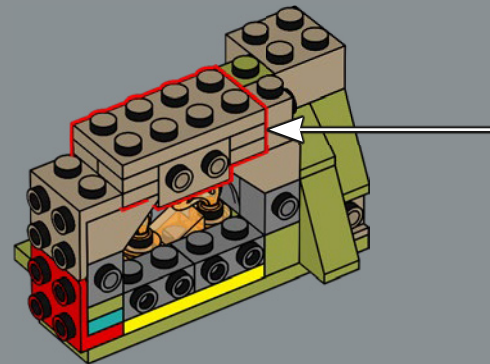
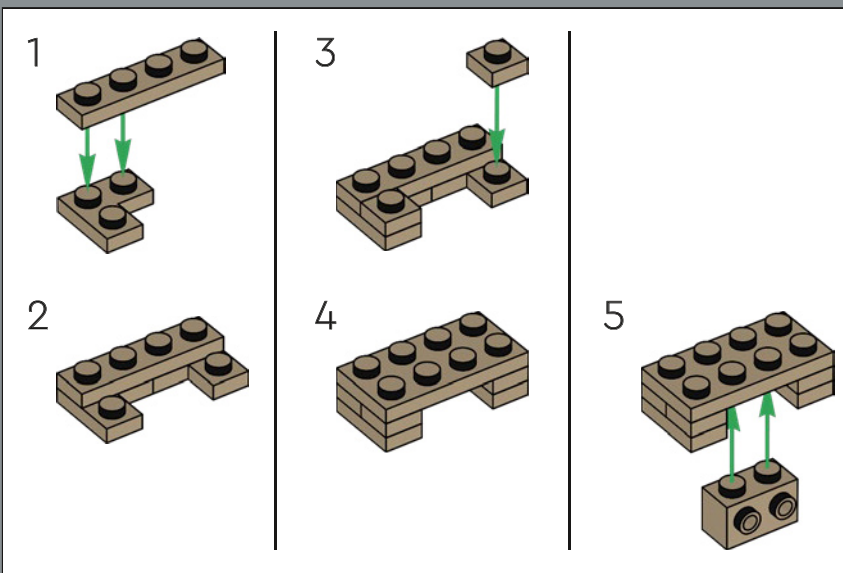

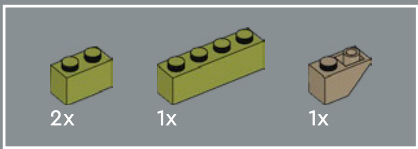

94

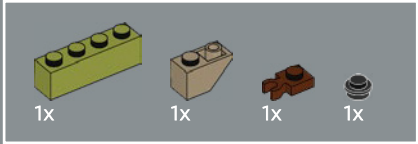
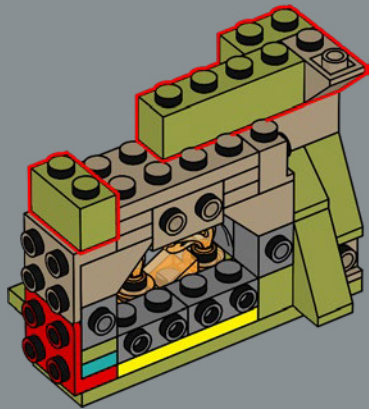

95

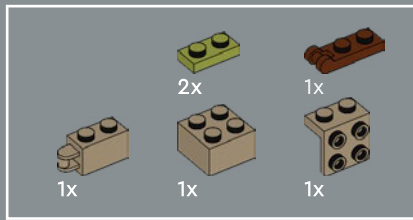
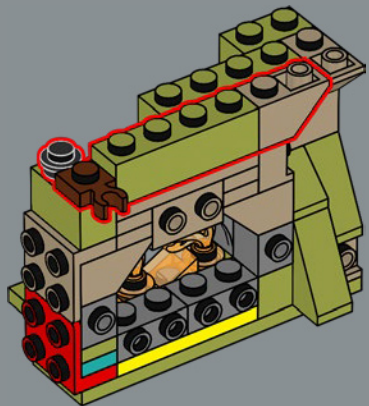

96

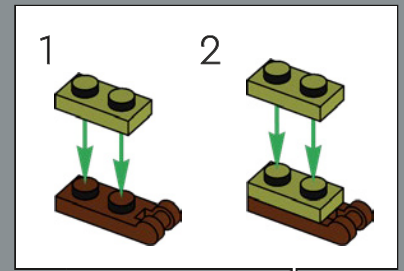
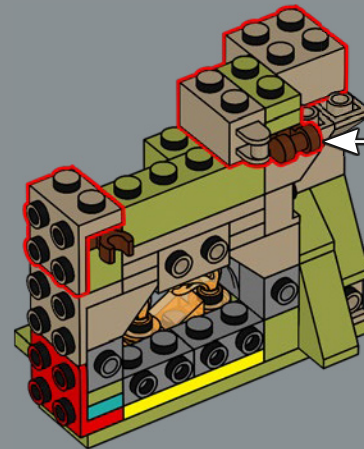



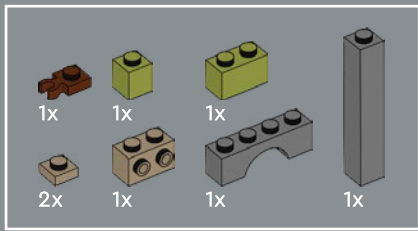

97

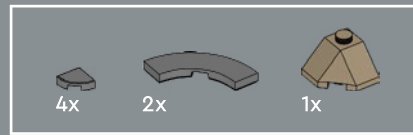
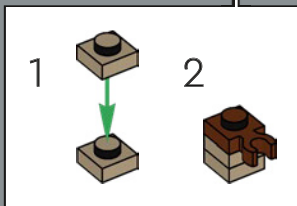
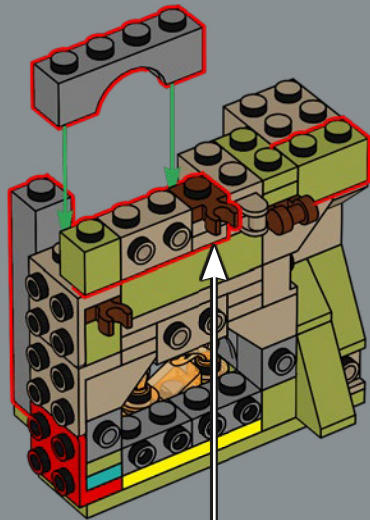

98

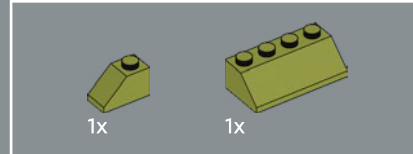
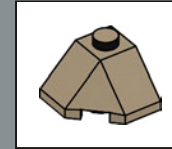
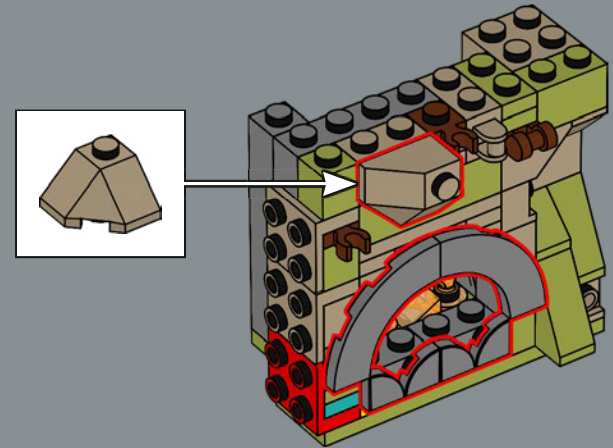

99

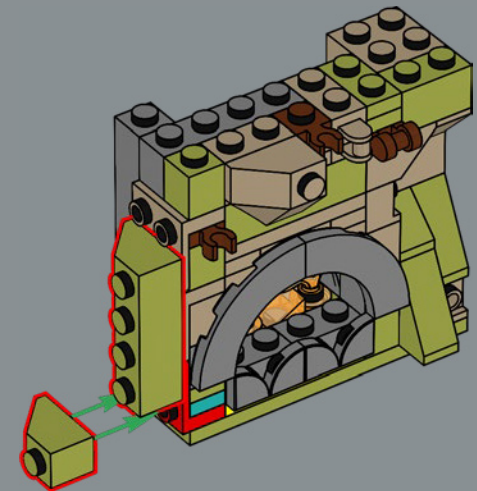

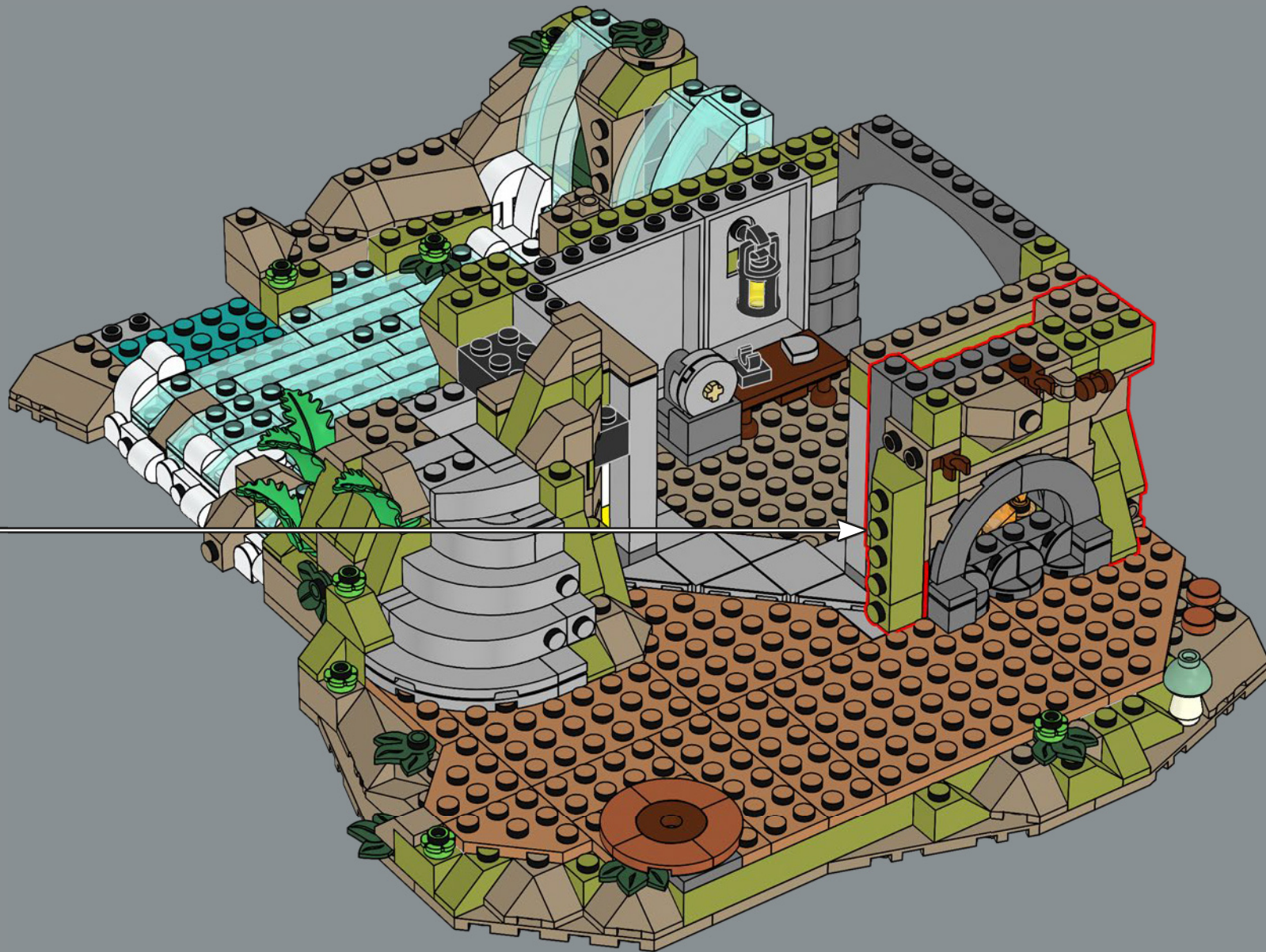

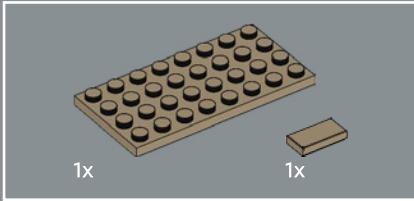
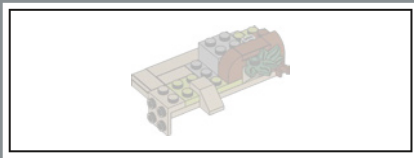

101

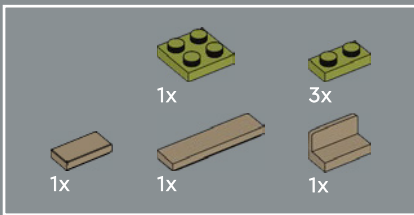
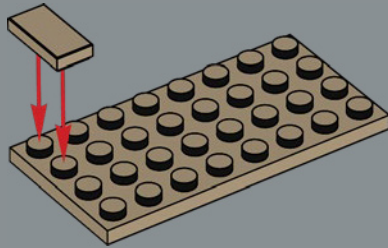

102

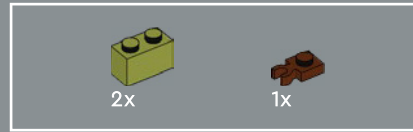
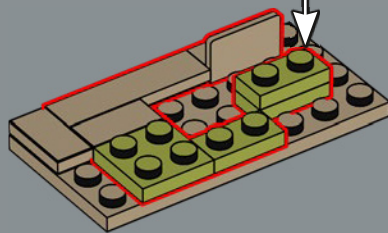
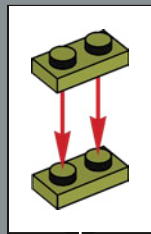

103

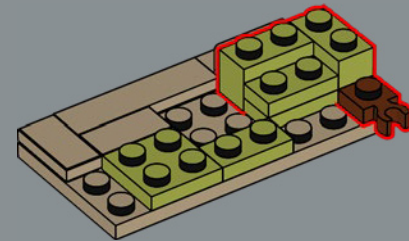

104

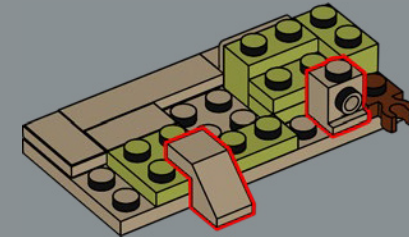

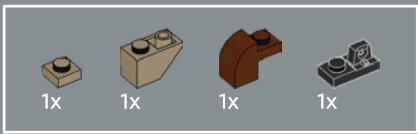

105

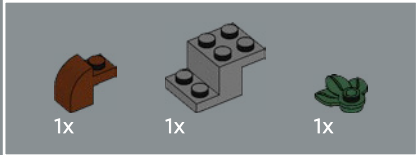
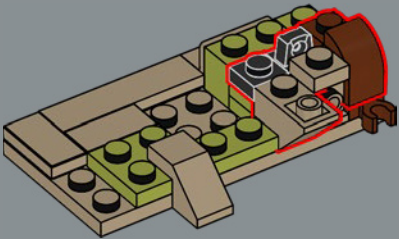

106

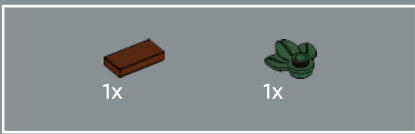
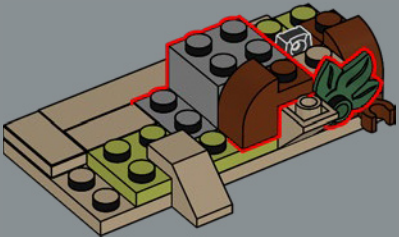

107

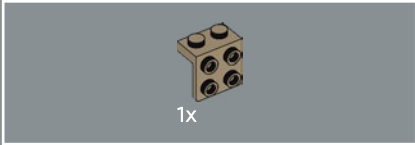
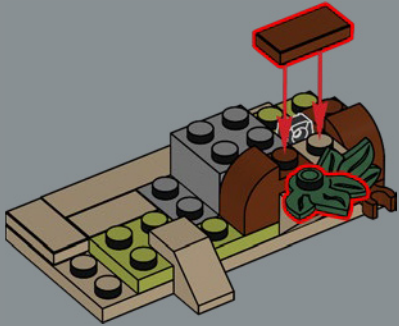

108

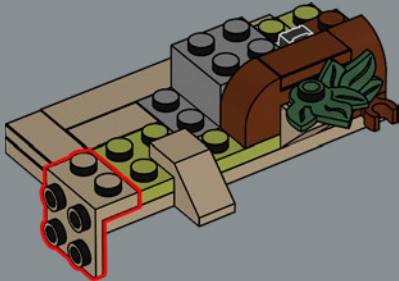

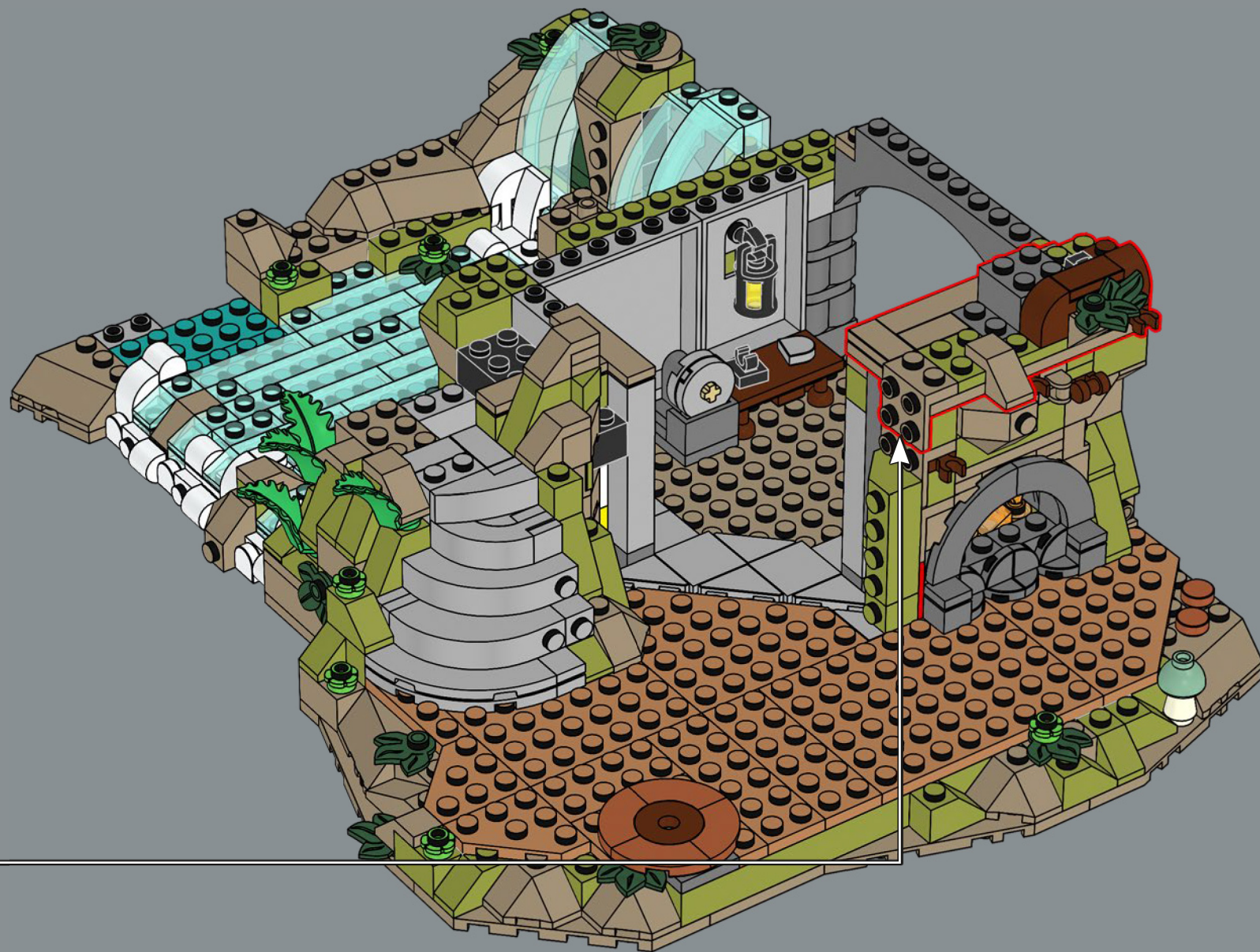

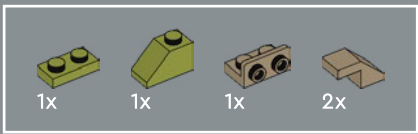

110

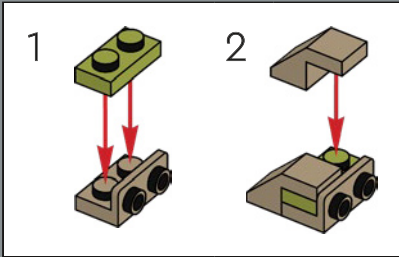
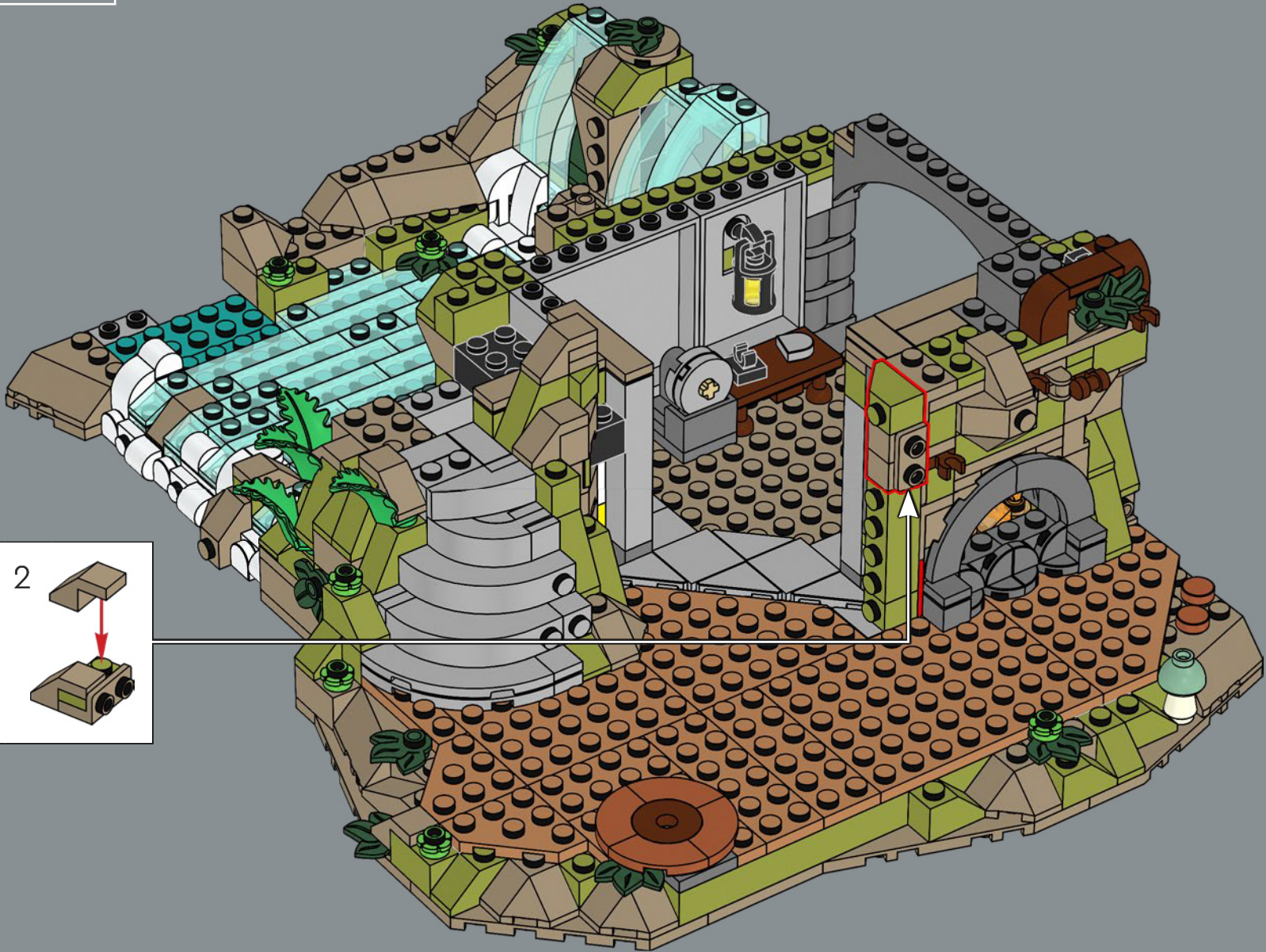

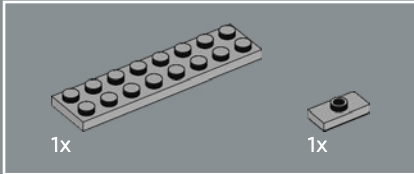
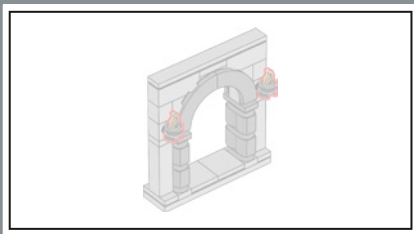

111

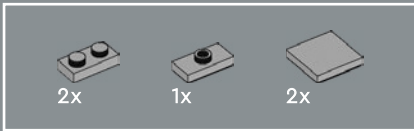
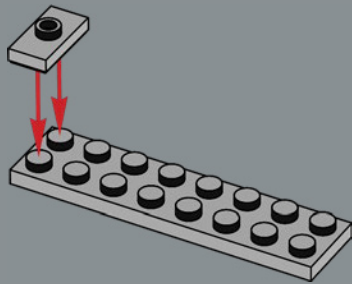

112

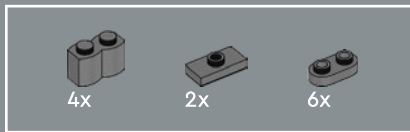
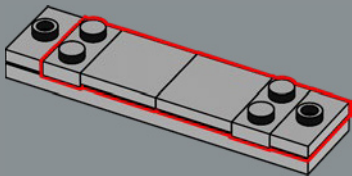

113

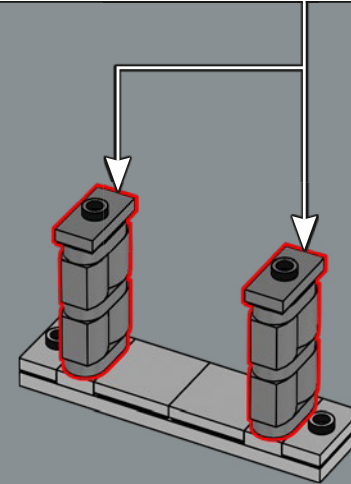
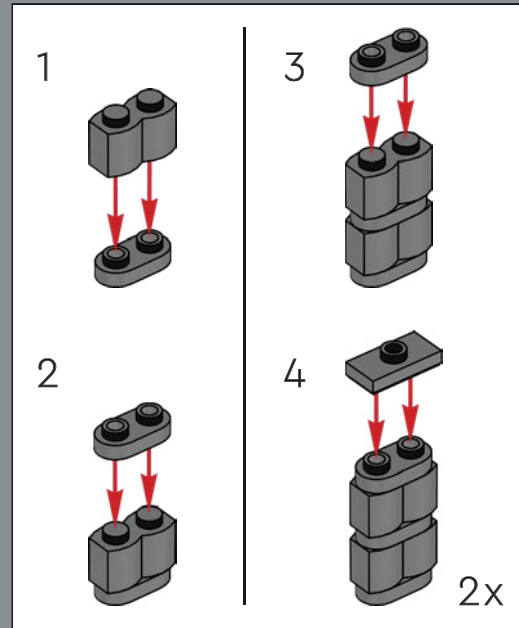

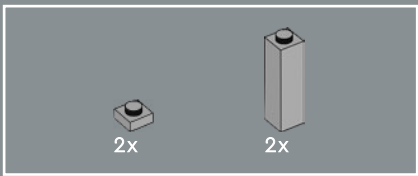

114

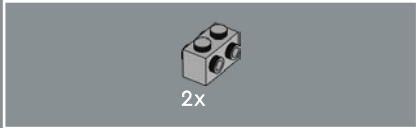
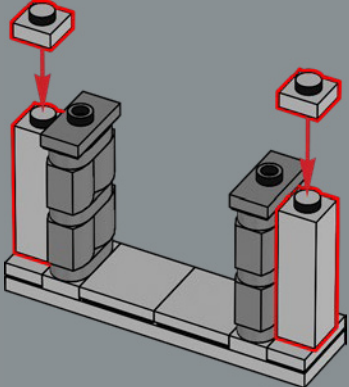

115

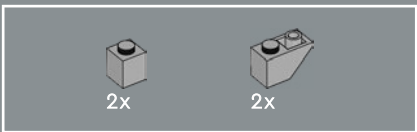
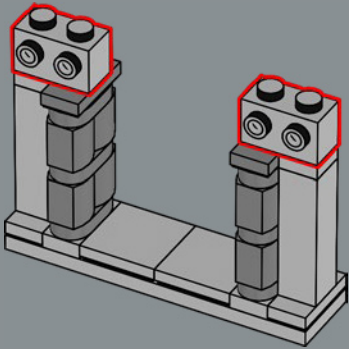

116

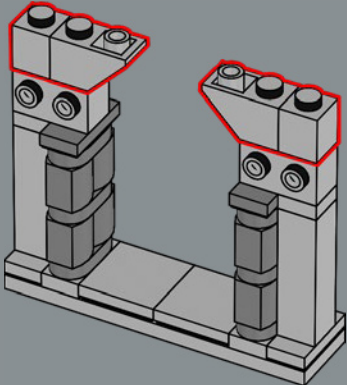



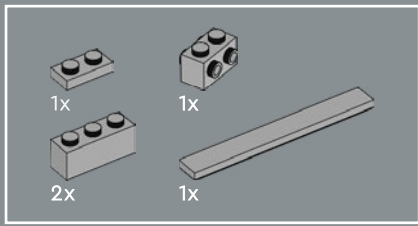

117

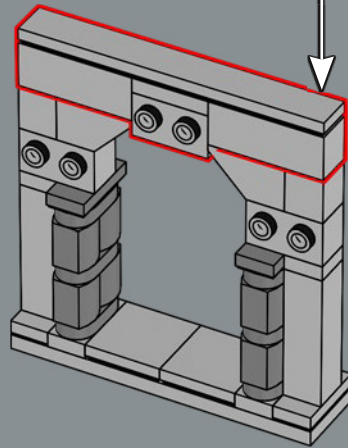
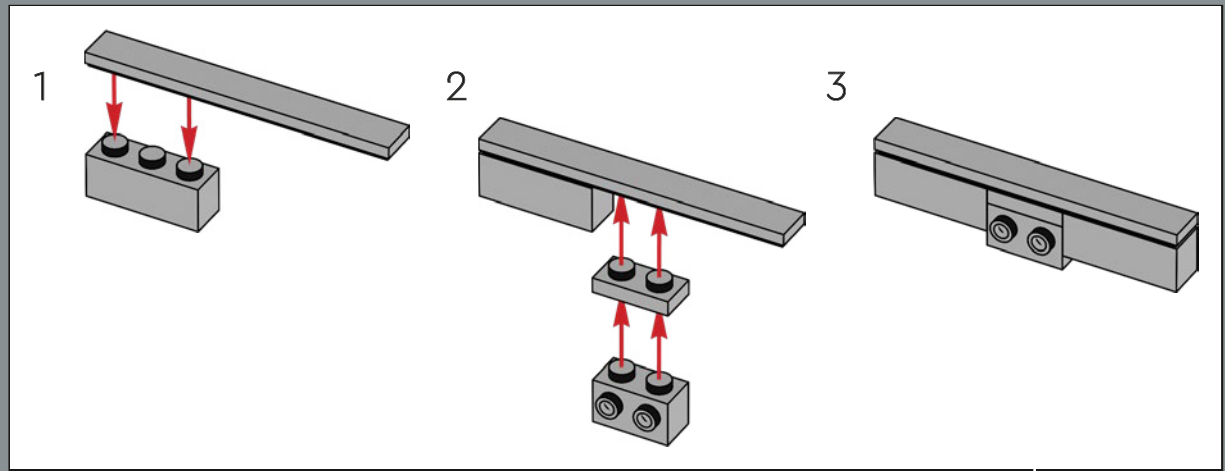

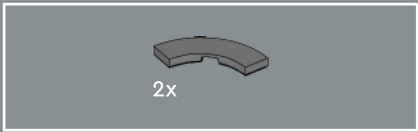

118

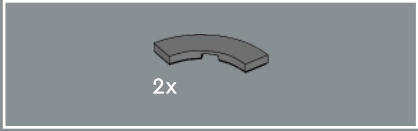
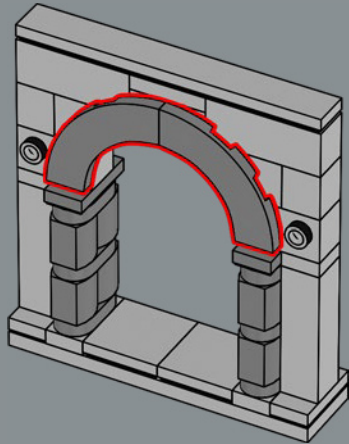

119

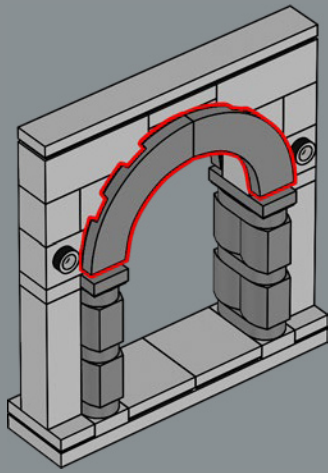

120

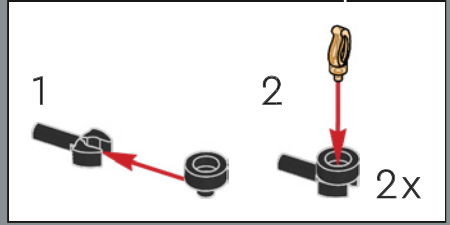
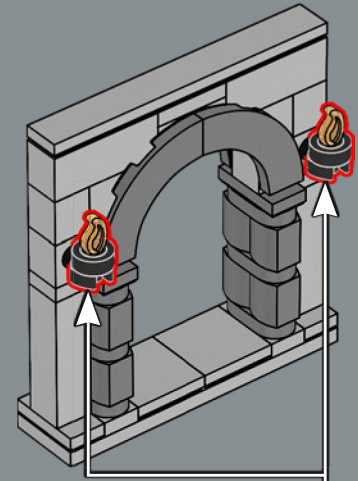

121

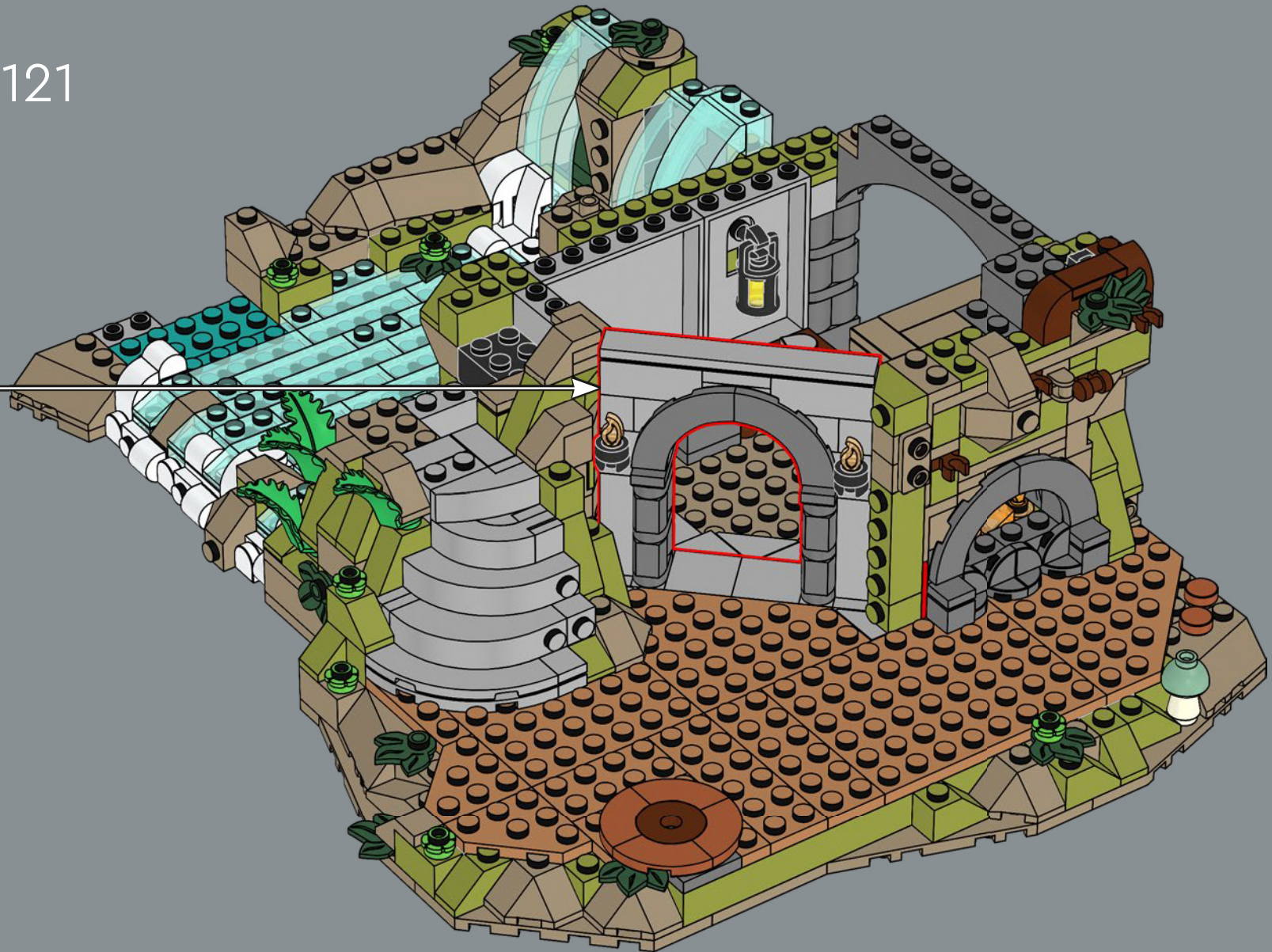

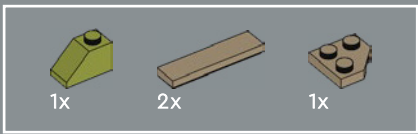

122

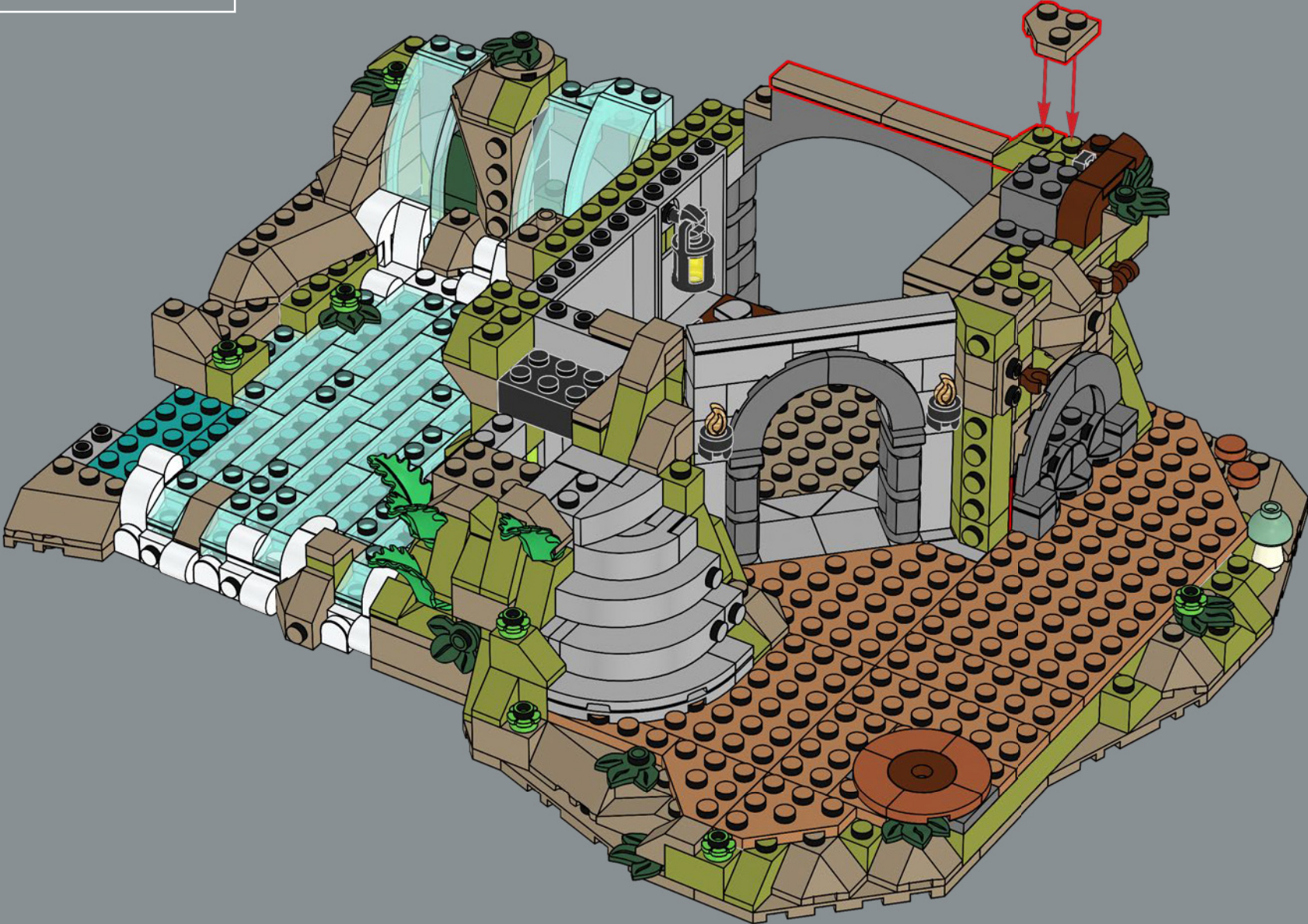

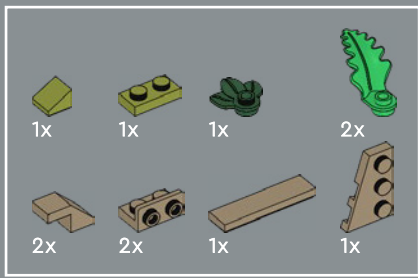

123

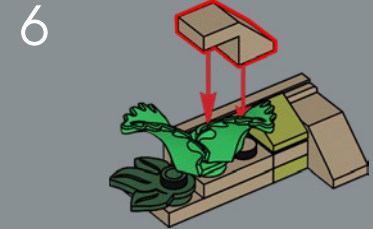
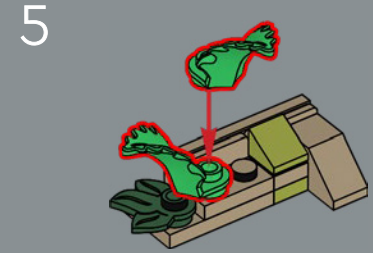
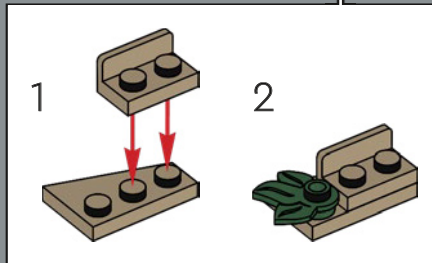
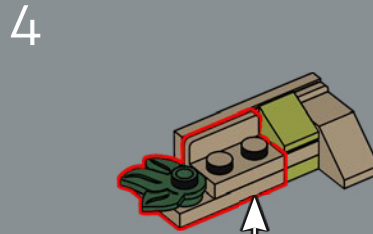
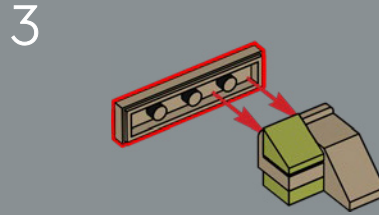
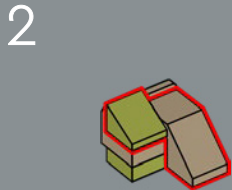
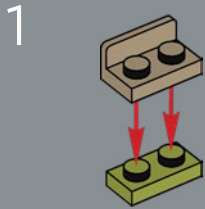

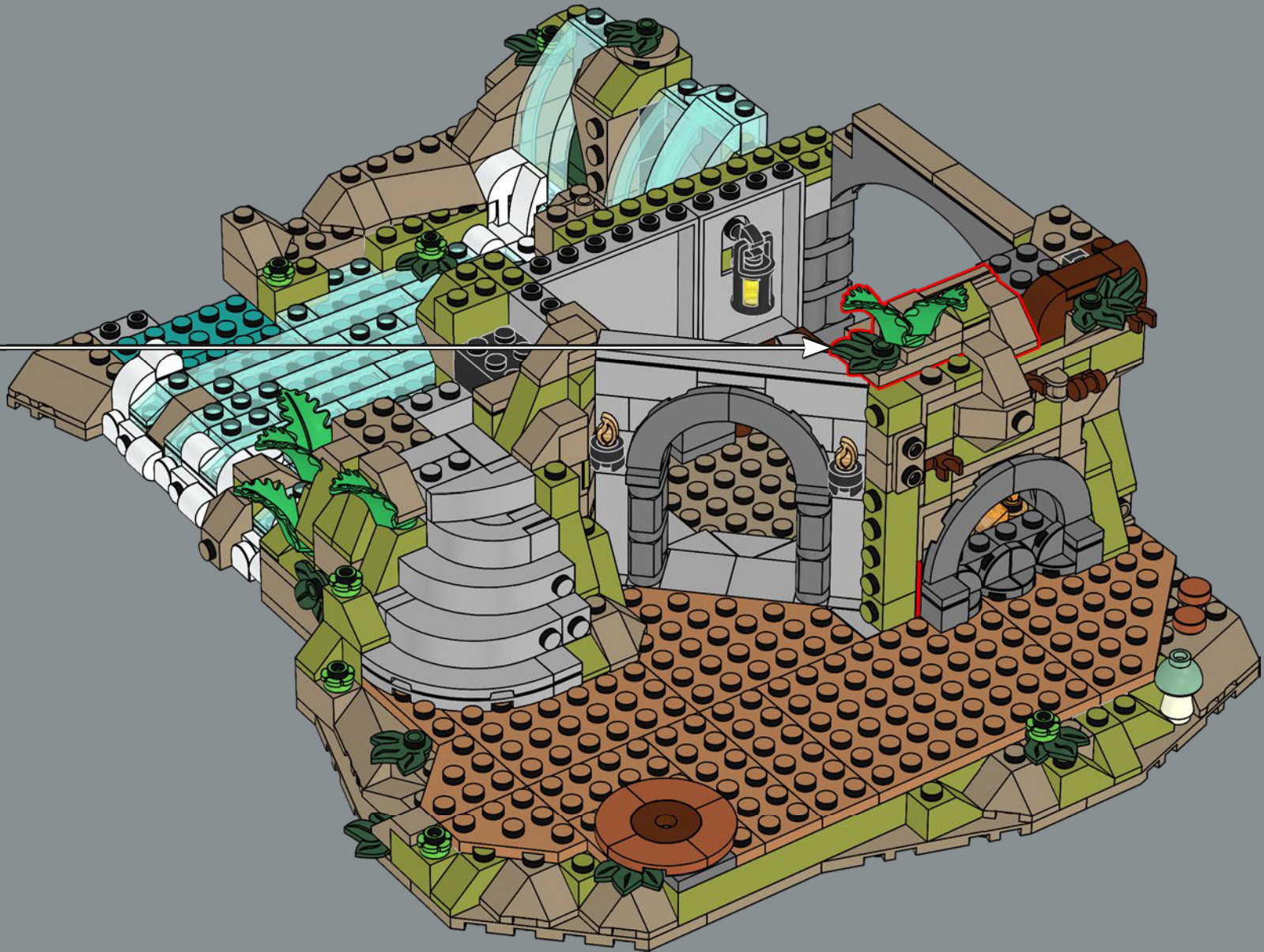

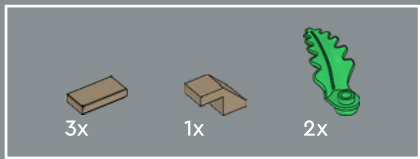

124

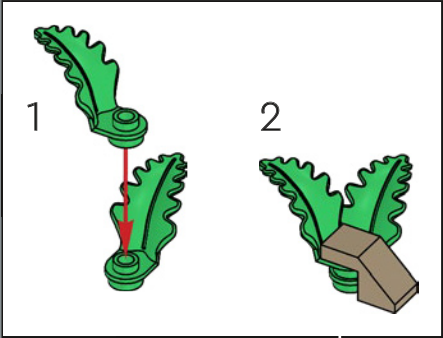
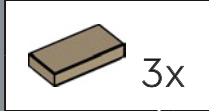
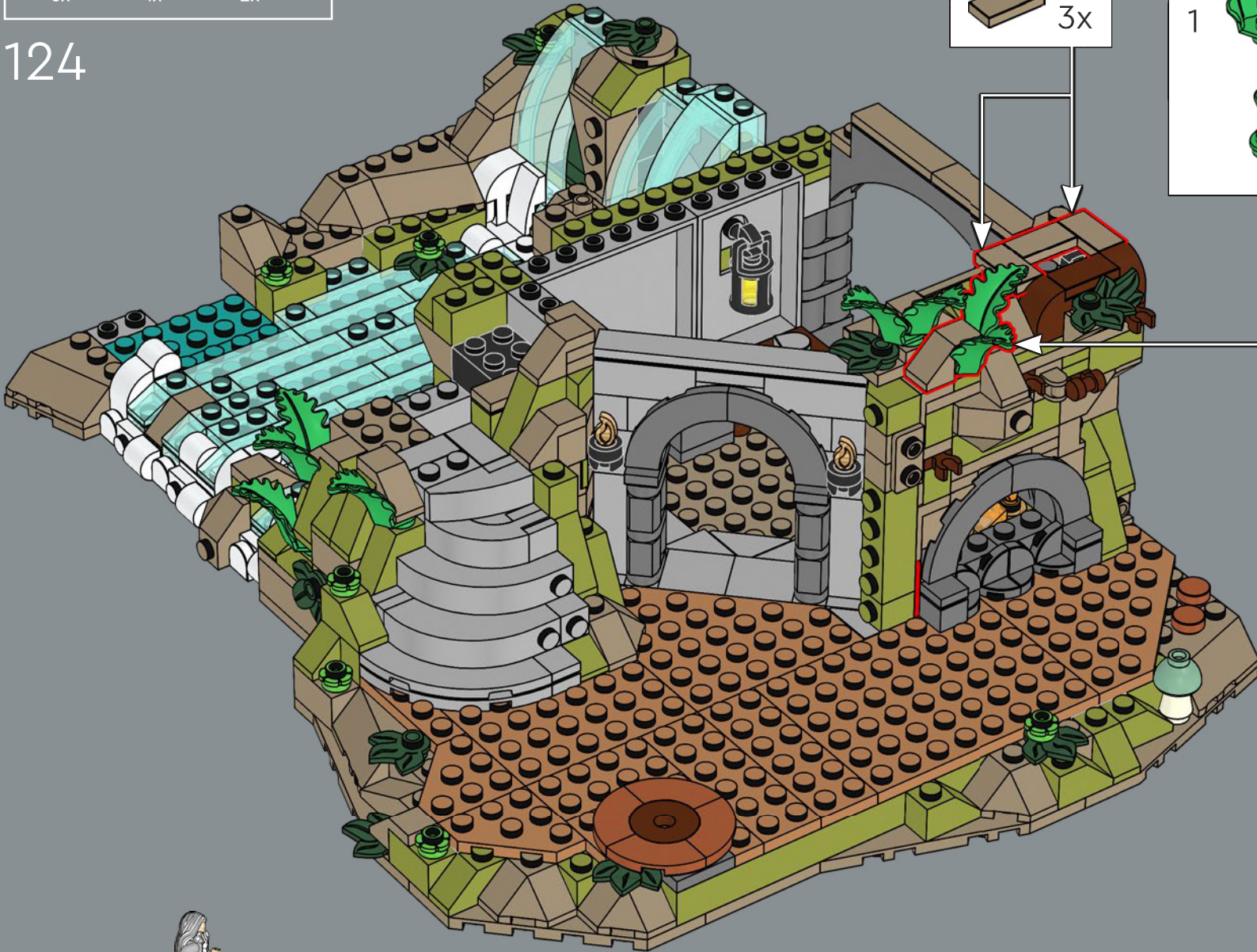

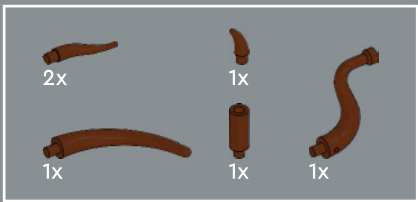

125

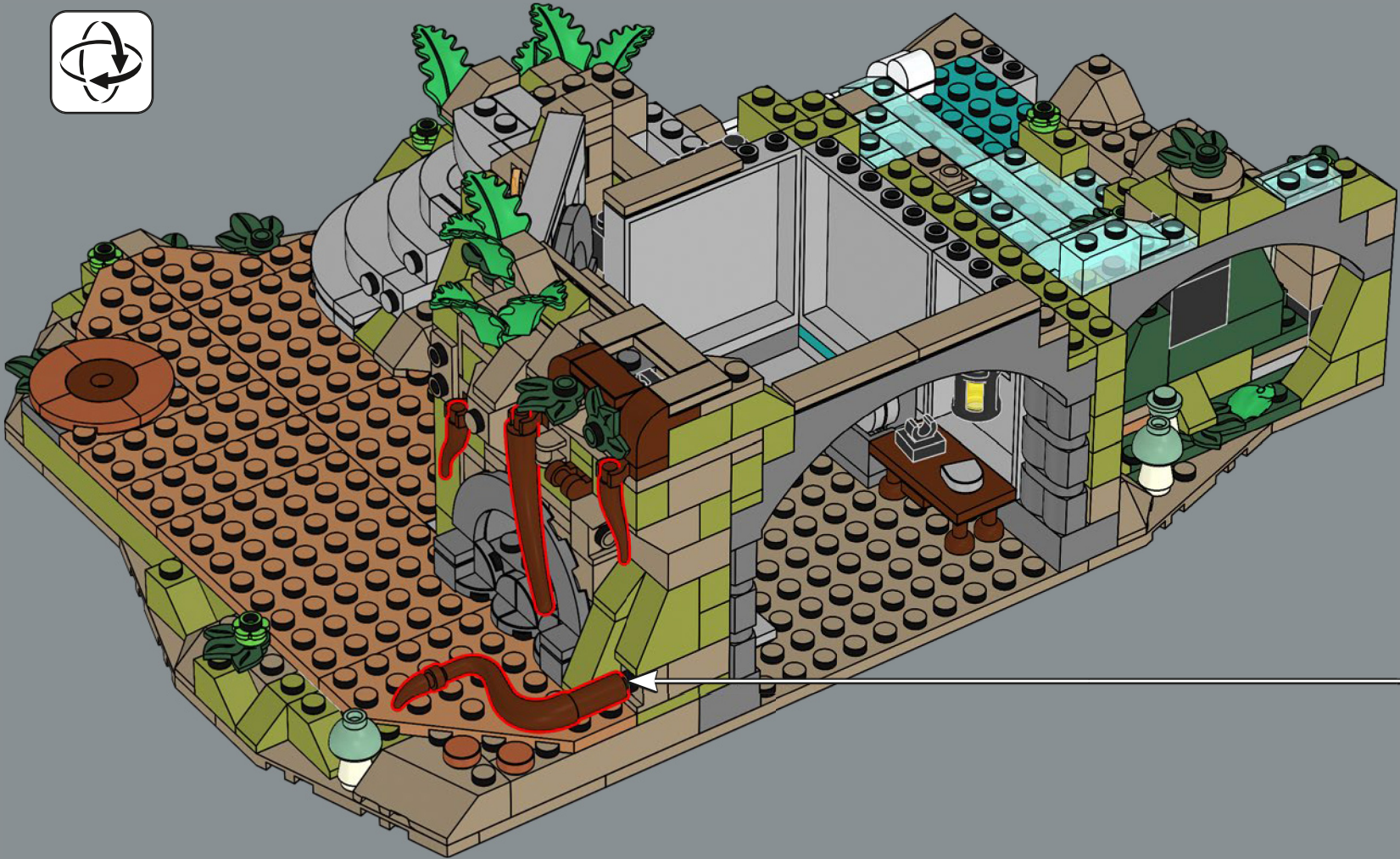
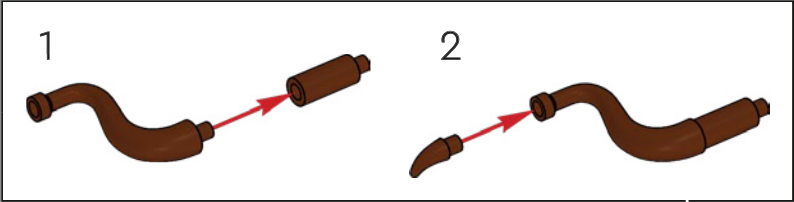



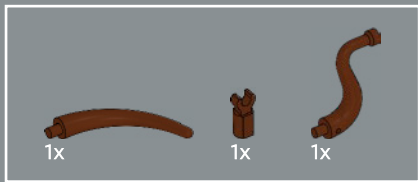

126

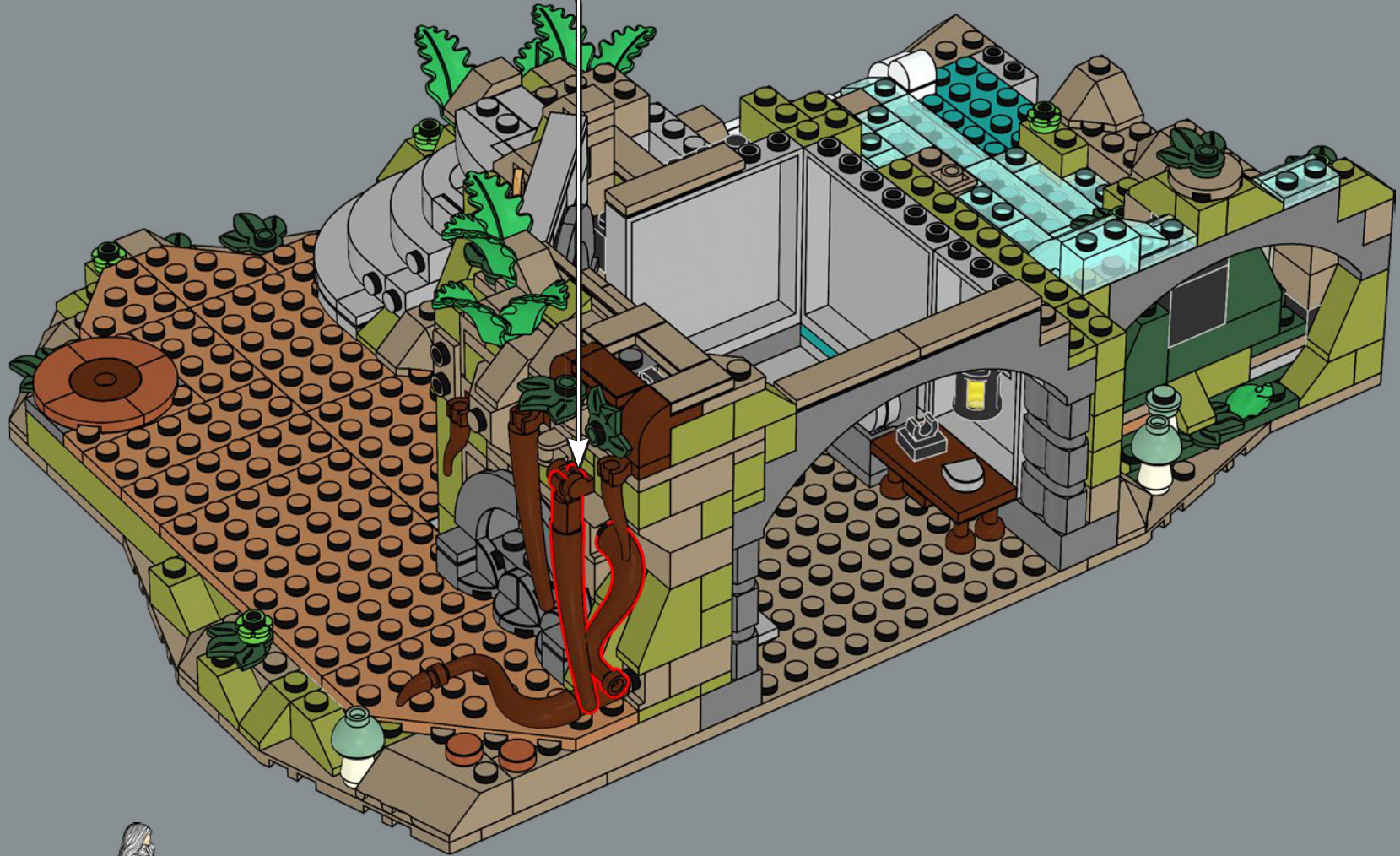
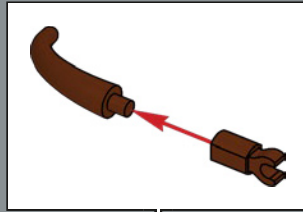

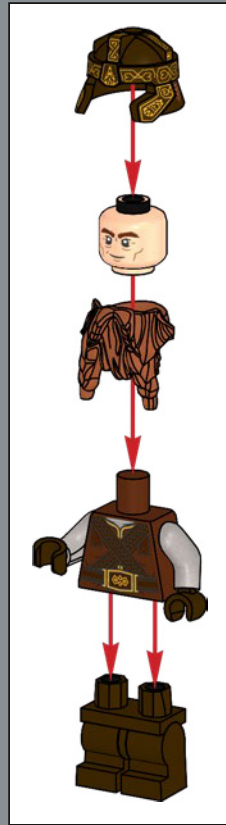
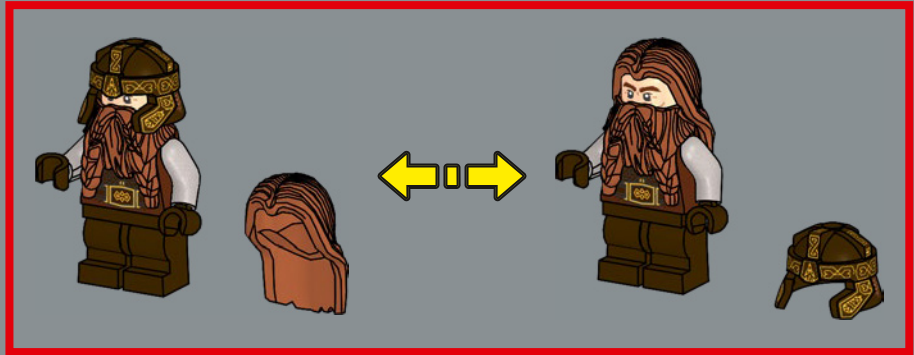

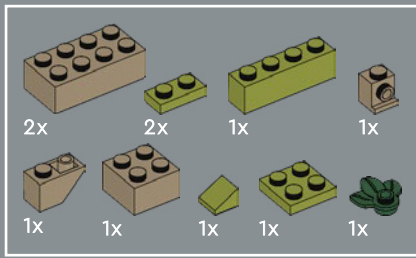

127

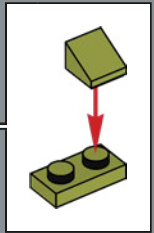
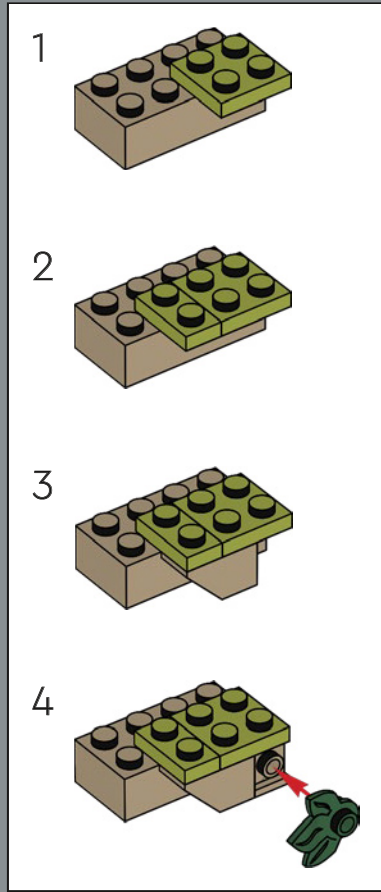

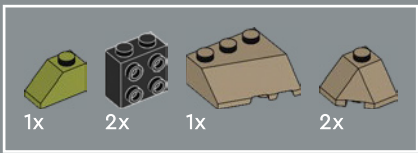

128

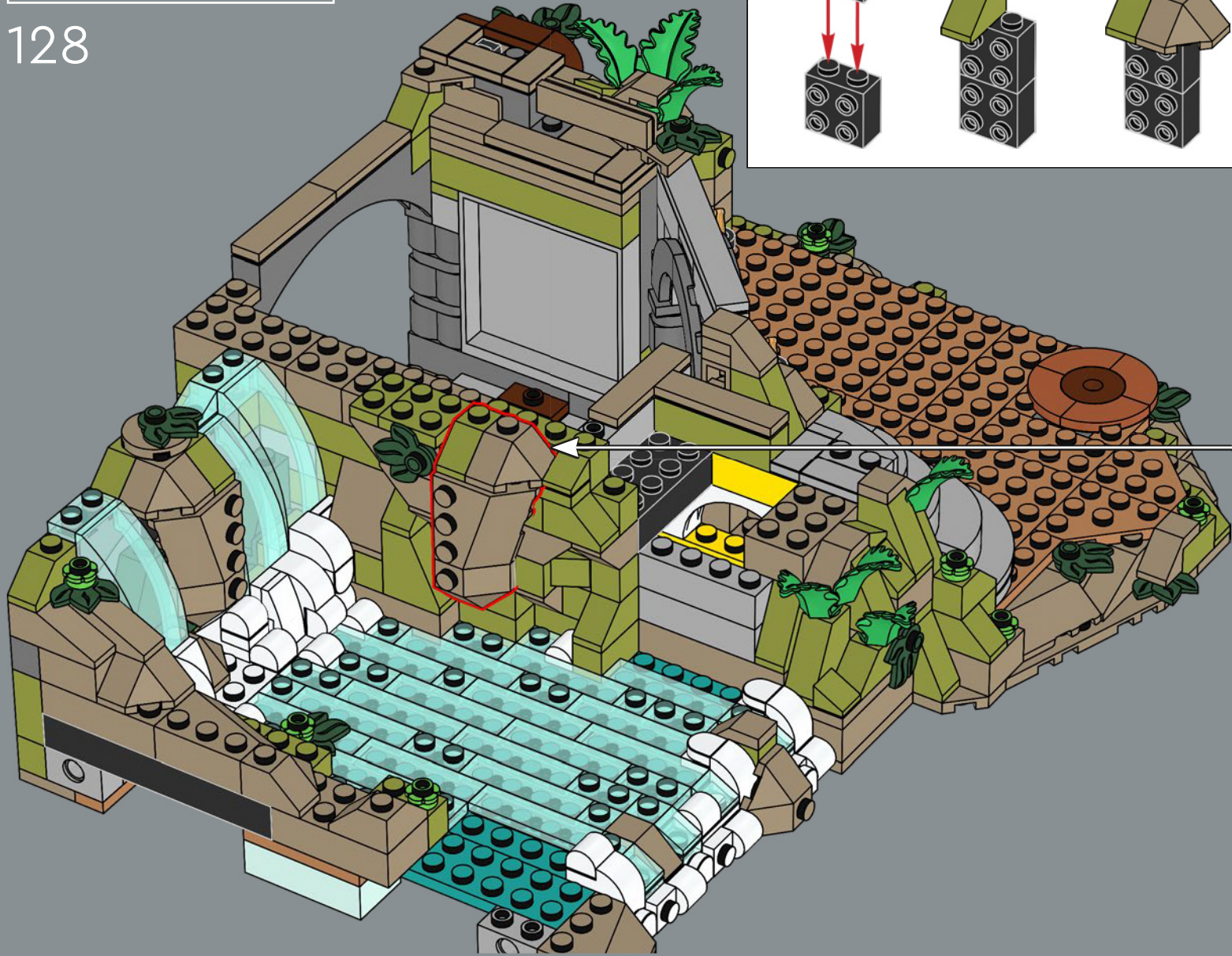
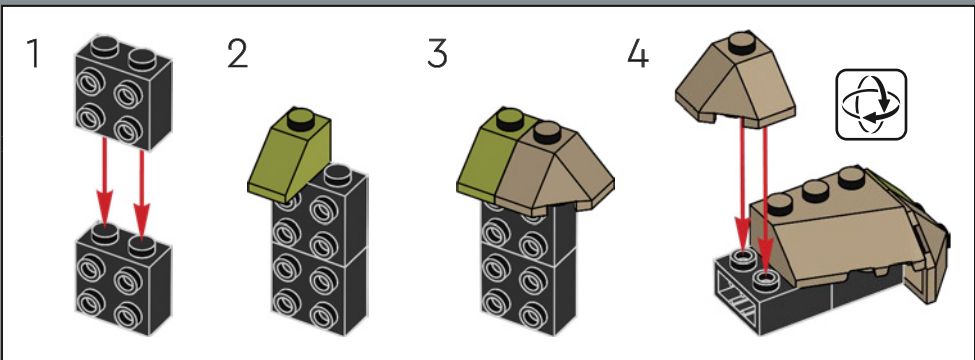

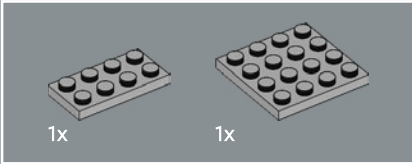
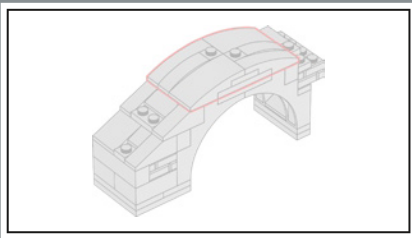

129

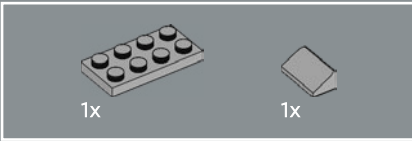
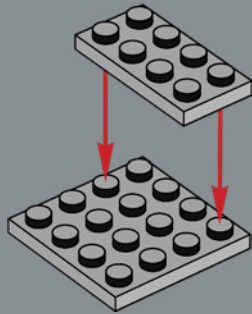

130

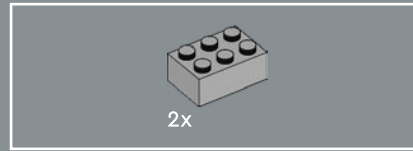
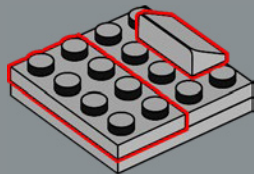

131

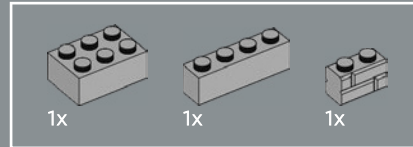
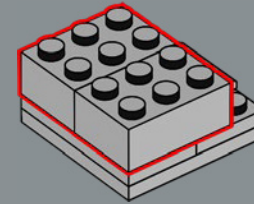

132

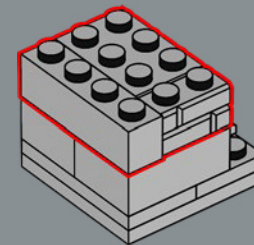

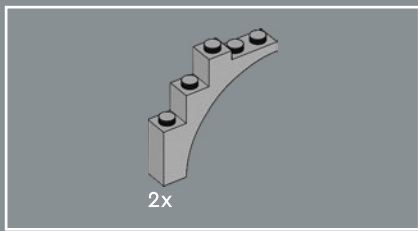

133

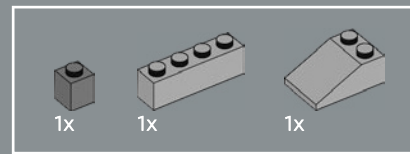
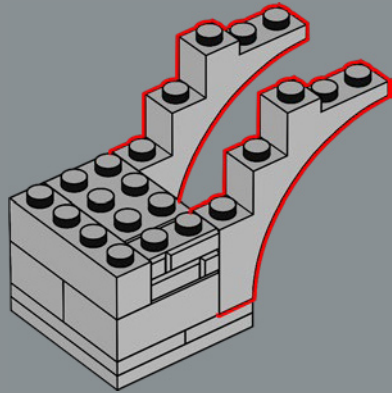

134

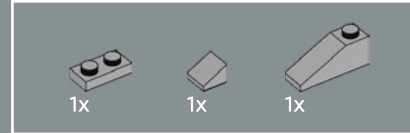
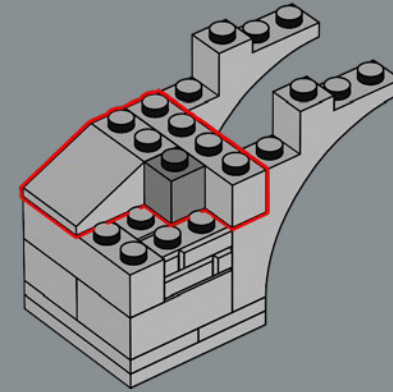

135

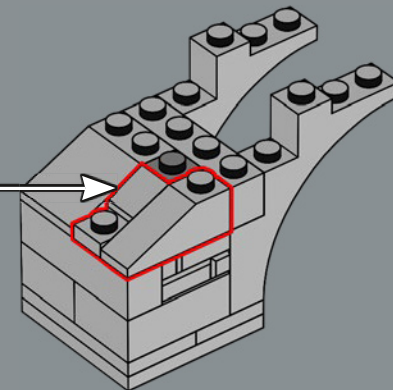
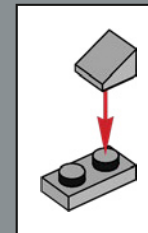

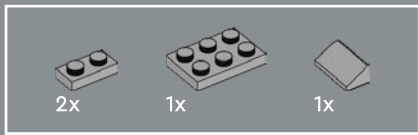

136

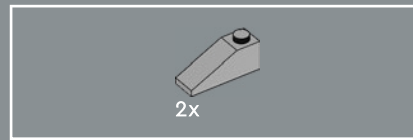
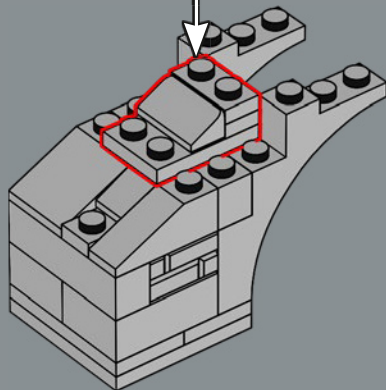
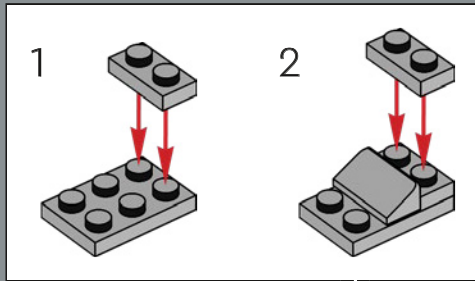

137

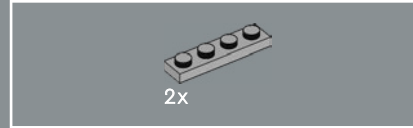
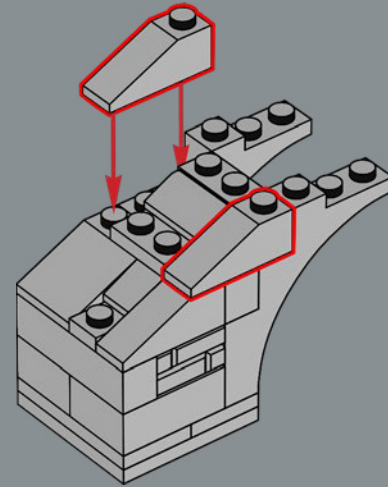

138

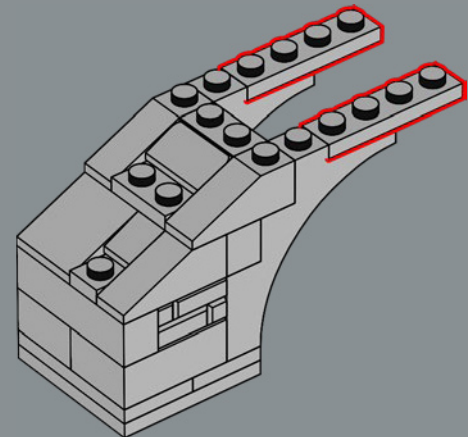

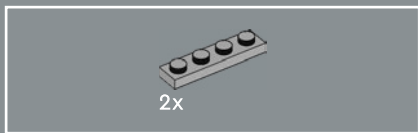

139

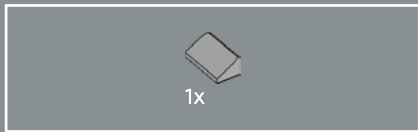
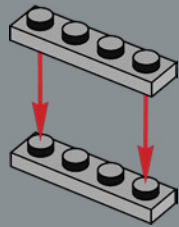

140

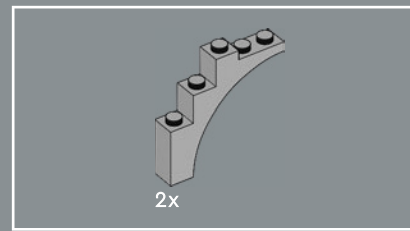
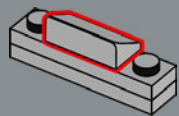

141

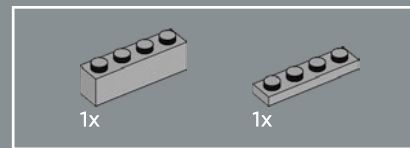
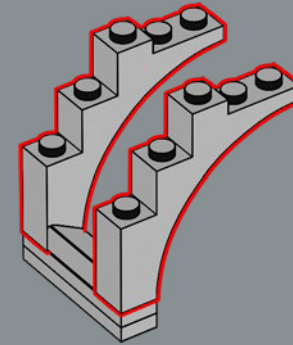

142

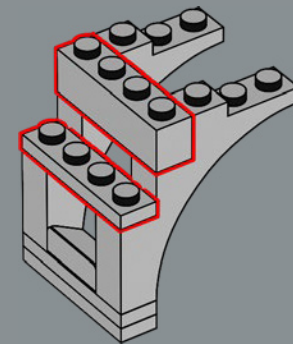



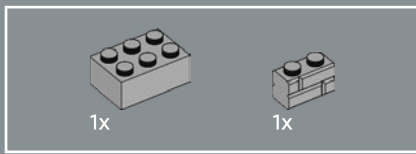

143

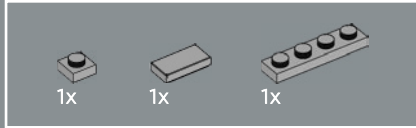
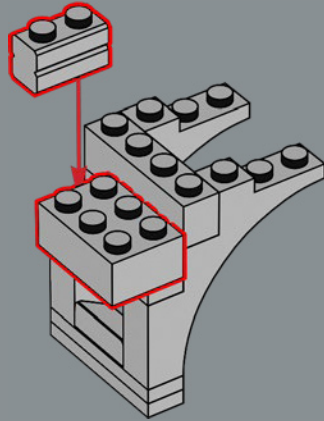

144

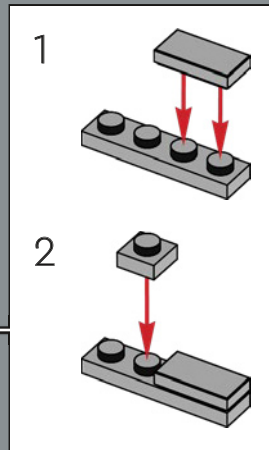
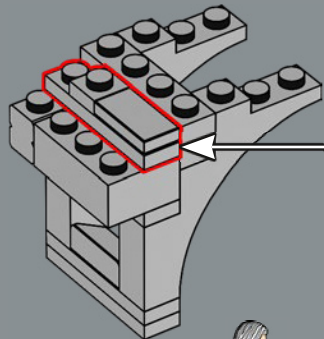

145

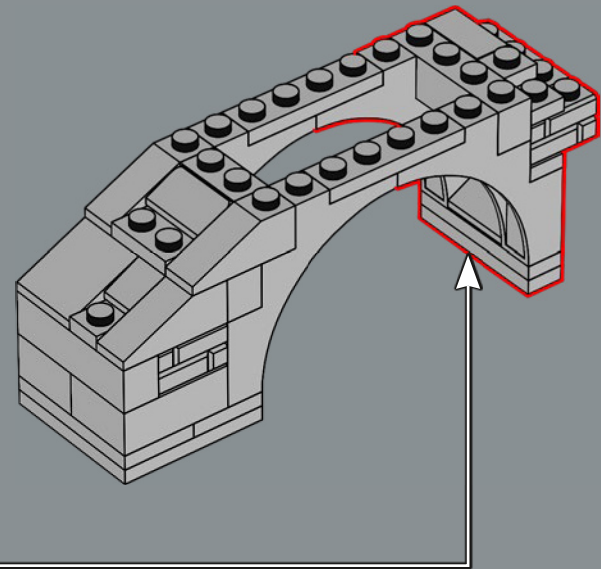

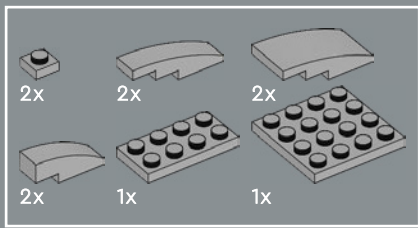

146

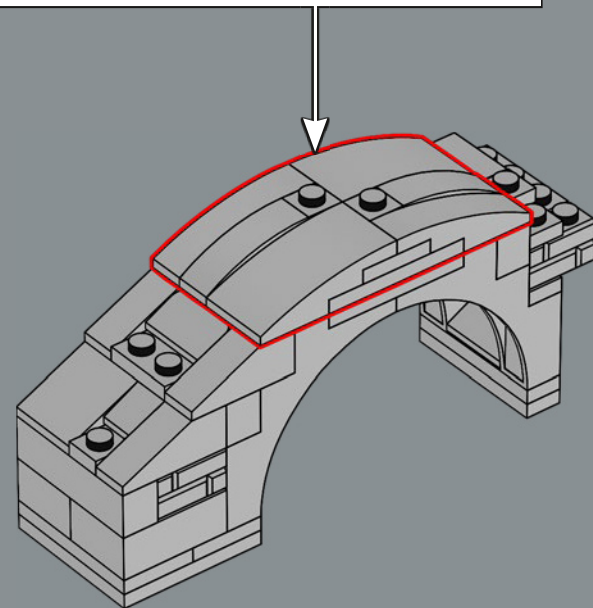
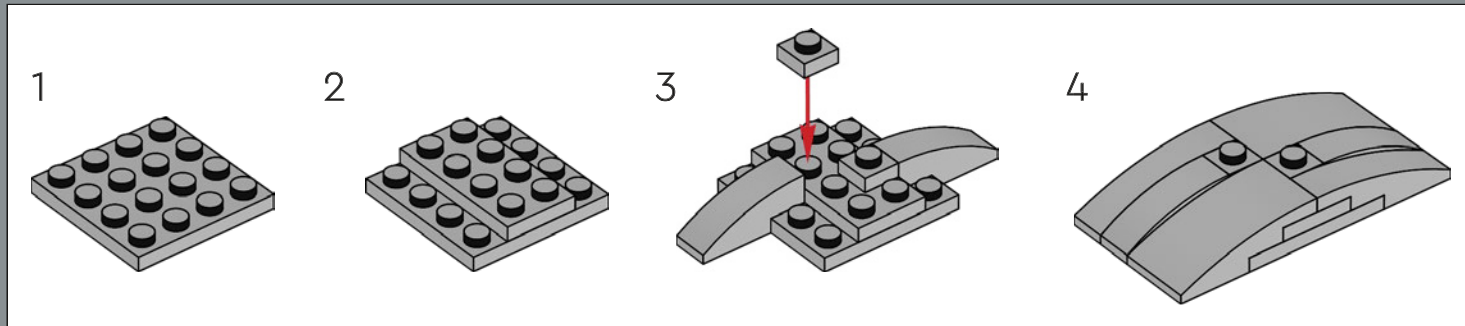

Da auf dieser Brücke die Geländer fehlen, haben wir die Oberfläche mit einigen Noppen versehen, damit die Minifiguren die Brücke sicher überqueren können.

147

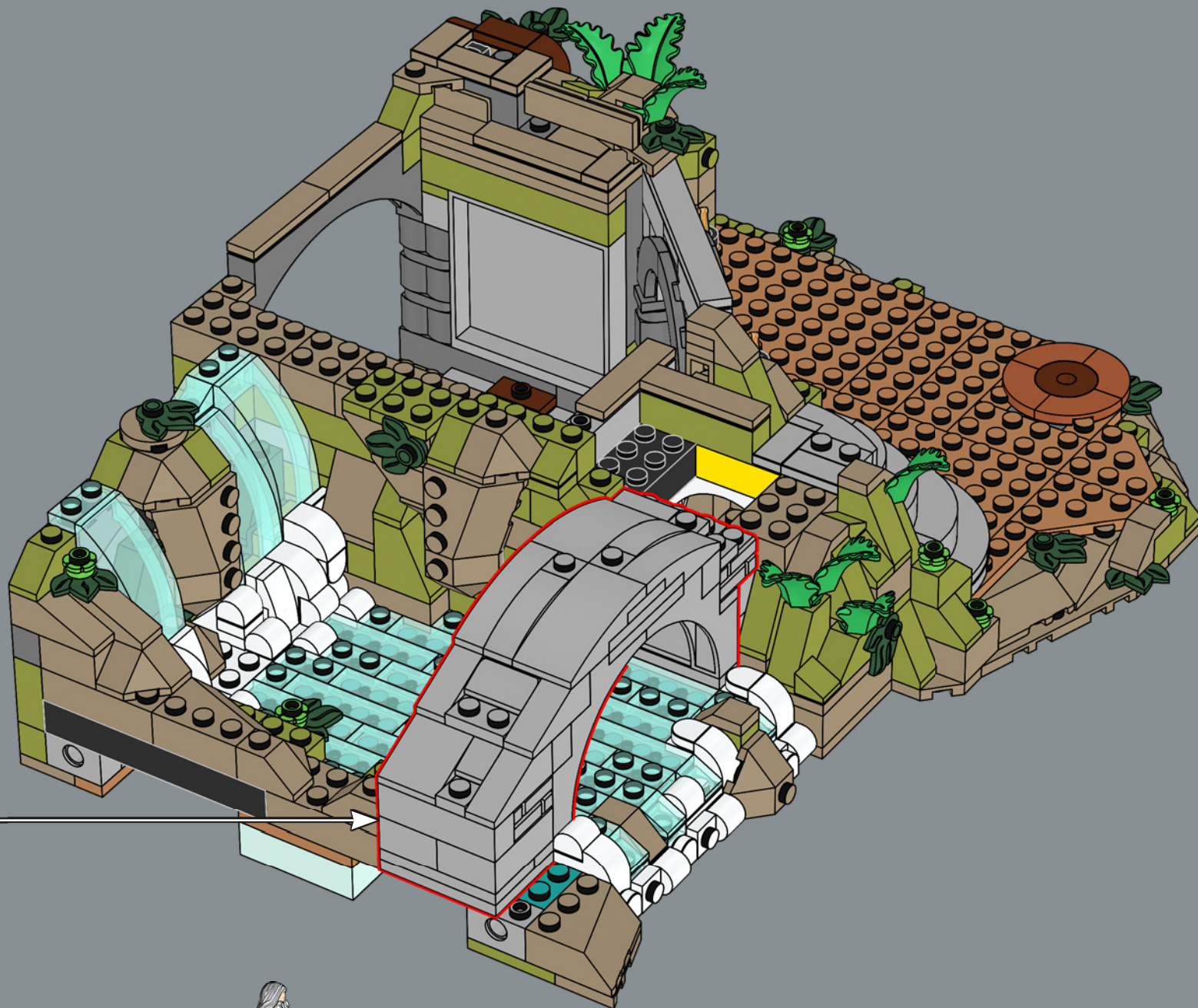

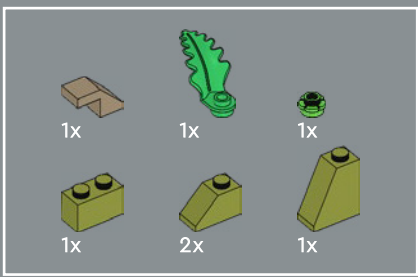

148

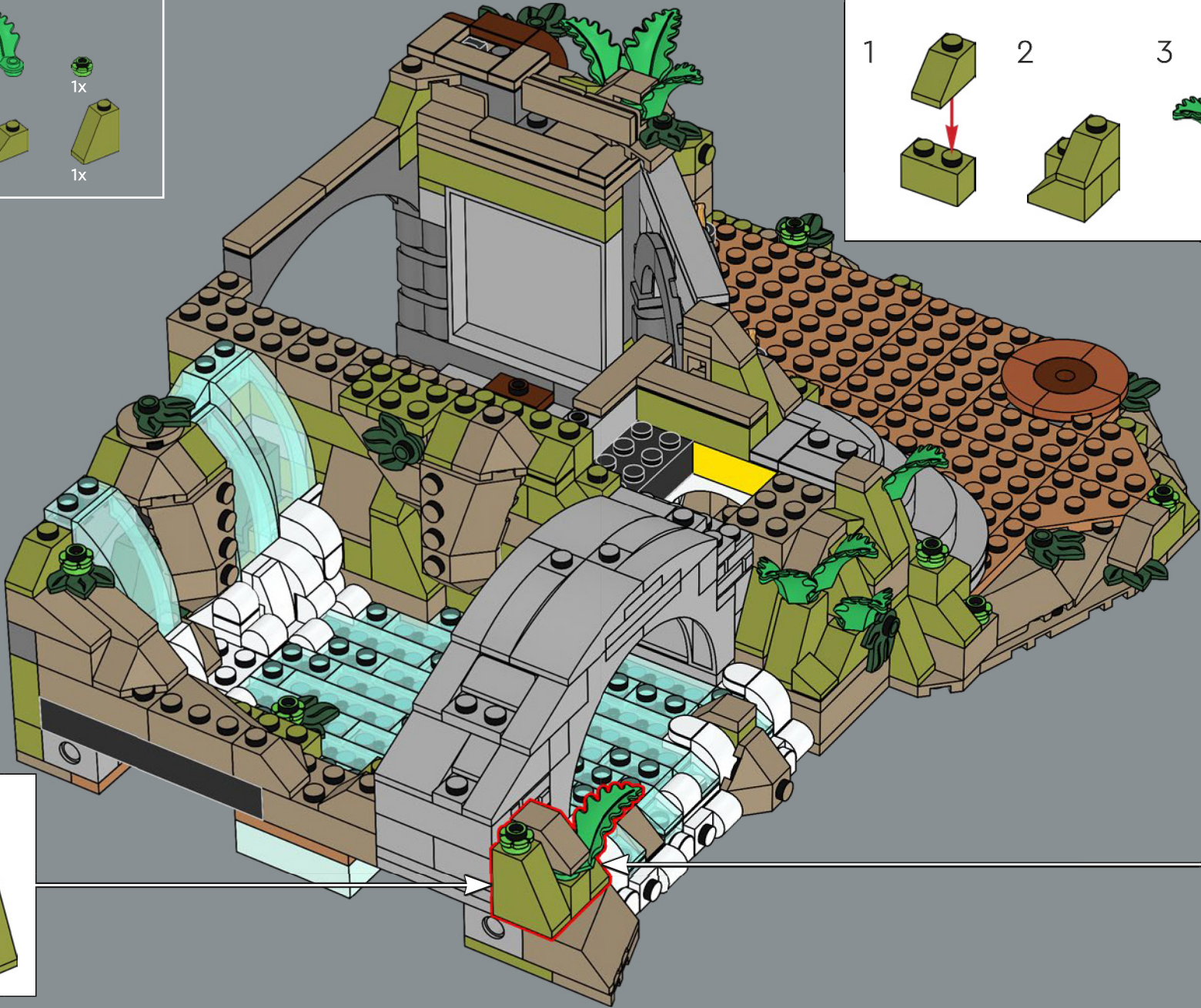
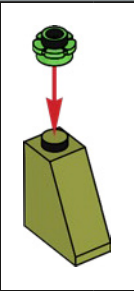
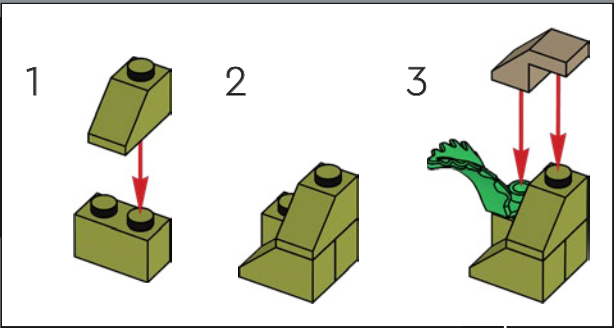

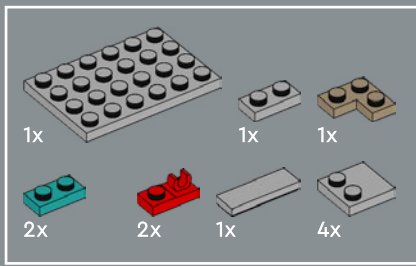

149

1

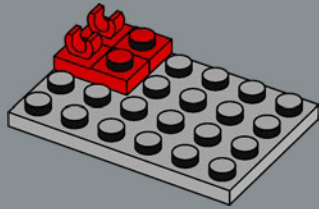

2

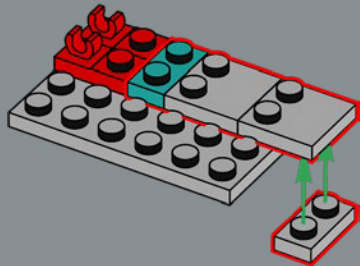

3

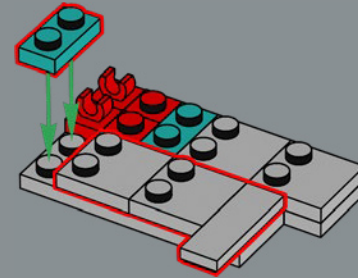

4

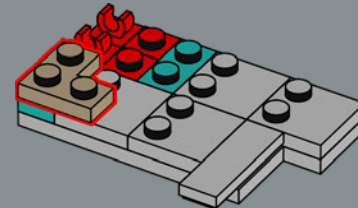

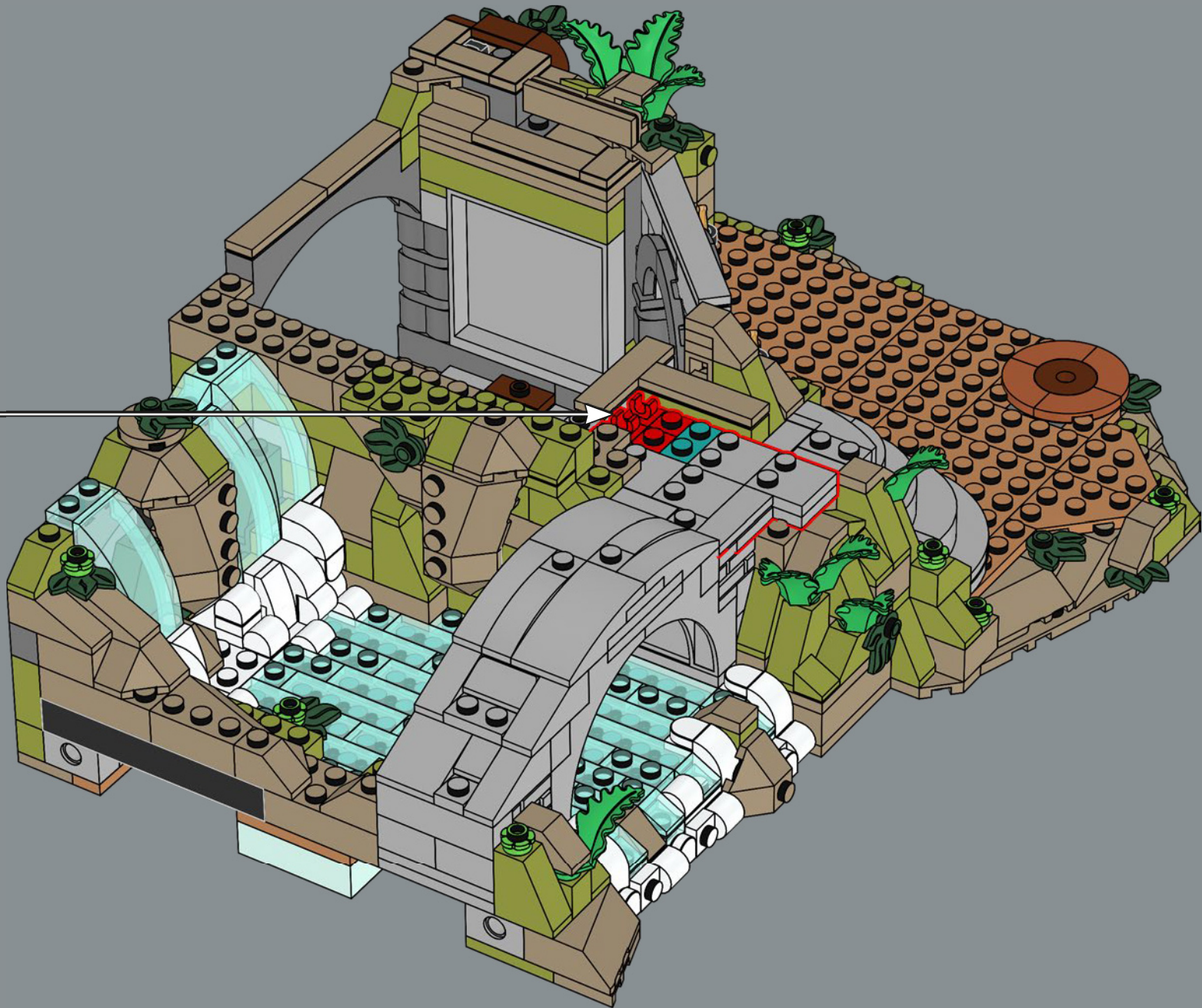



150

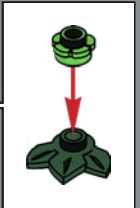
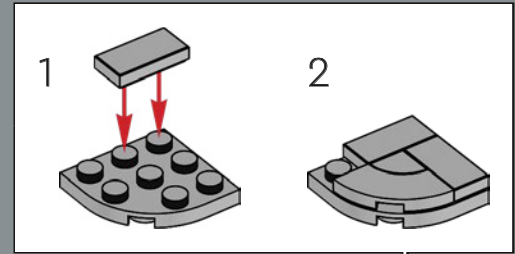
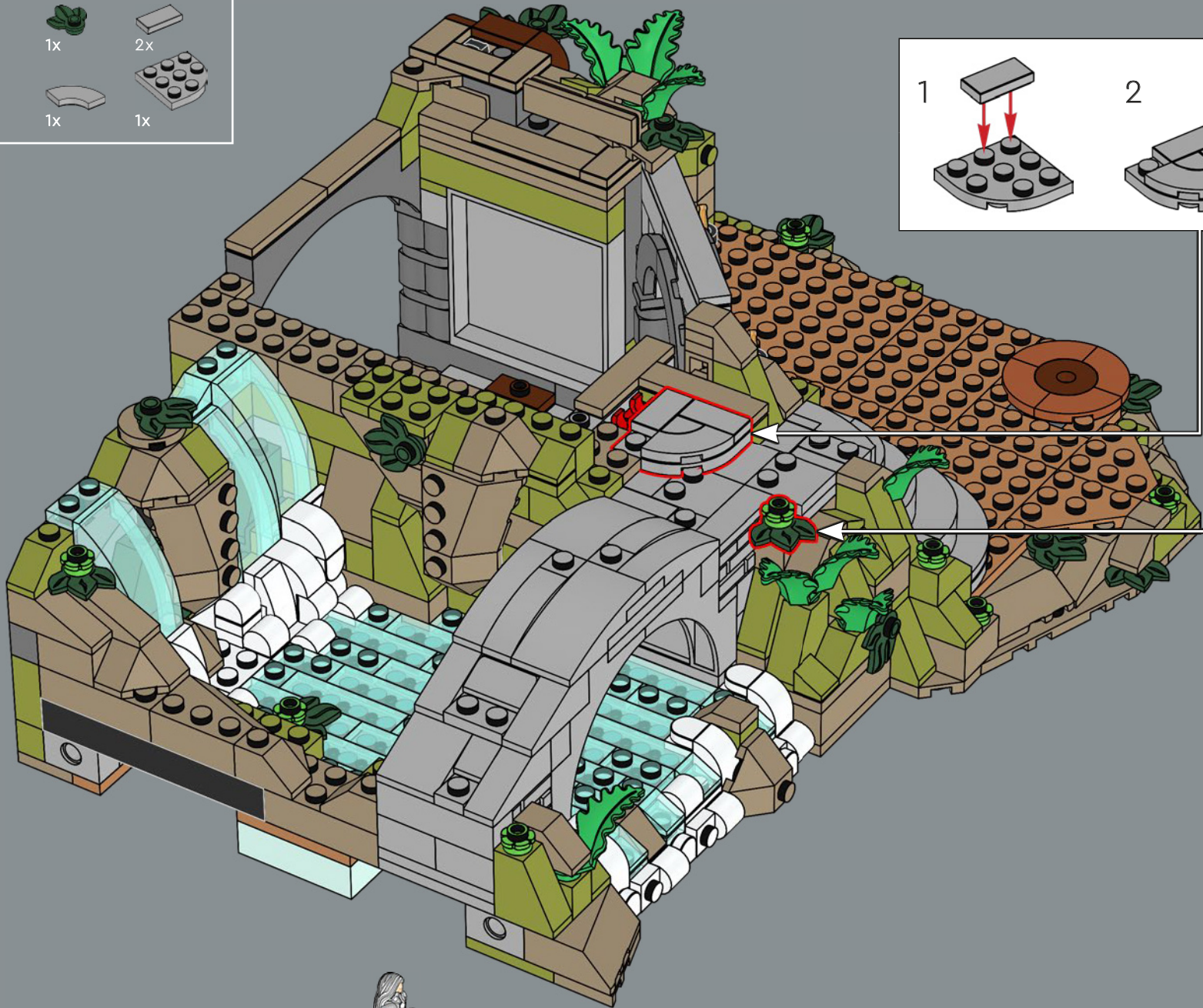

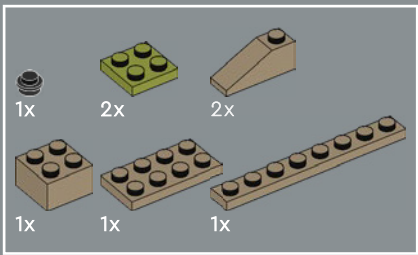

151

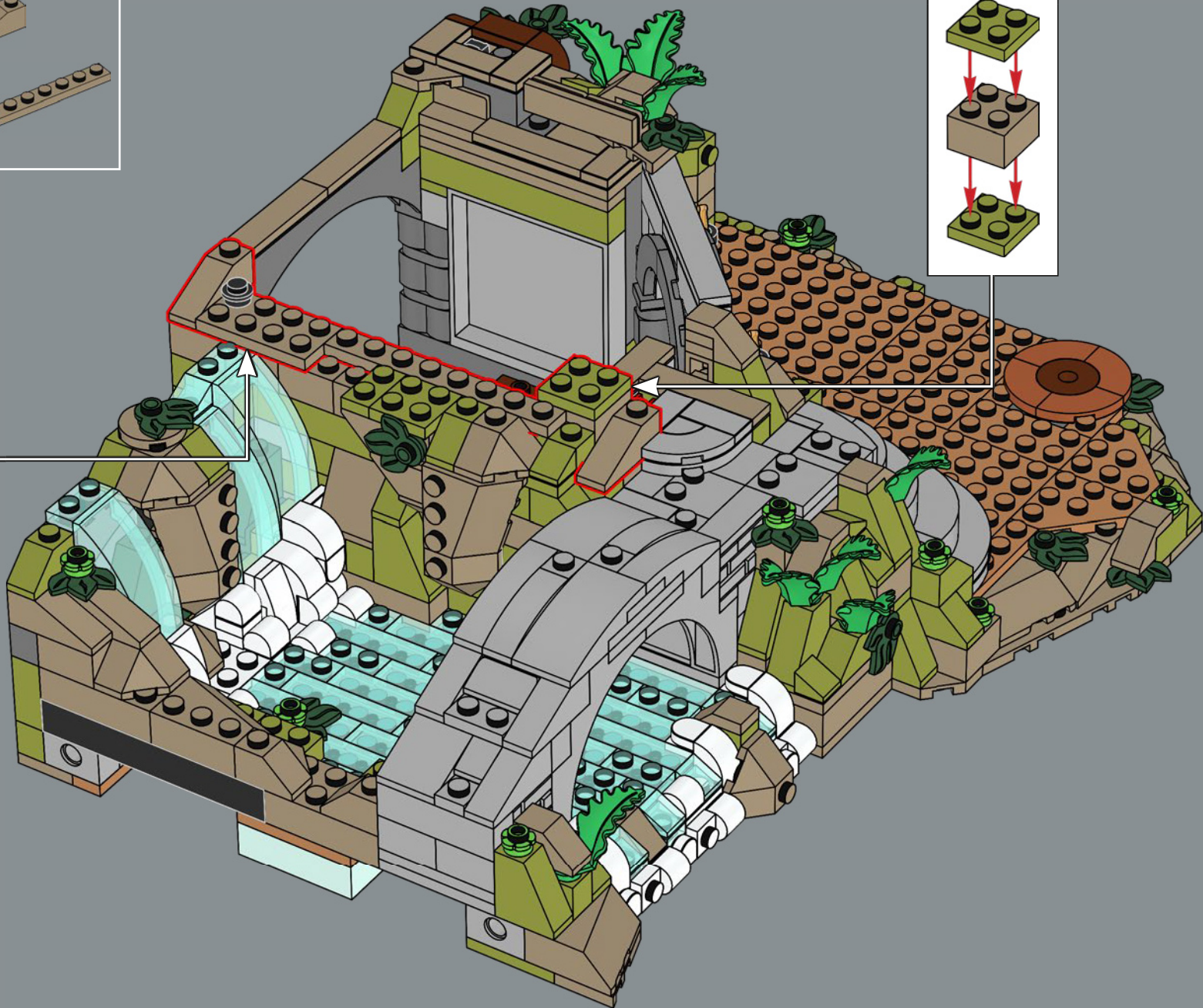
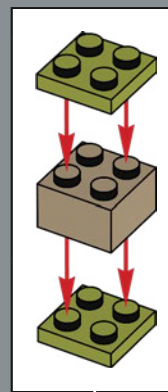
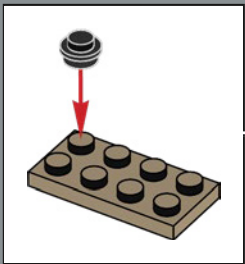



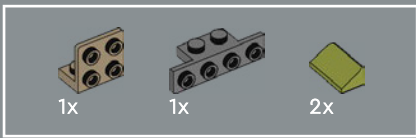

152

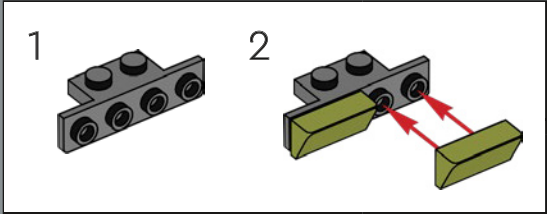

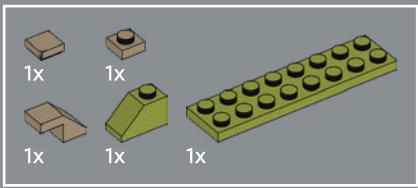

153

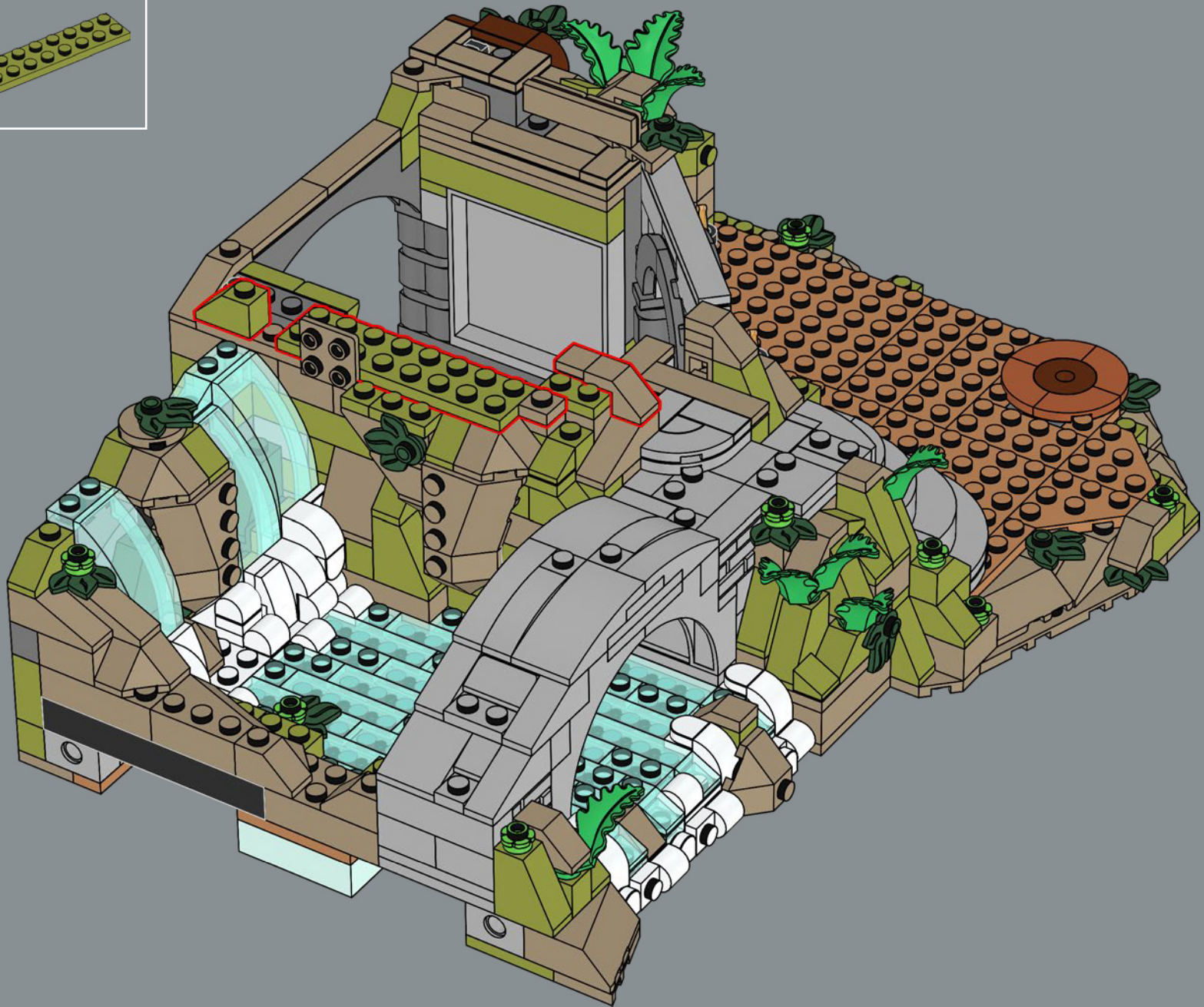

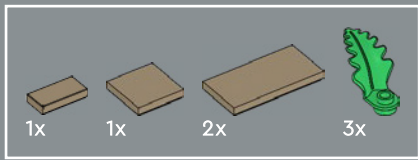

154

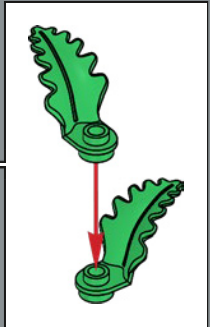
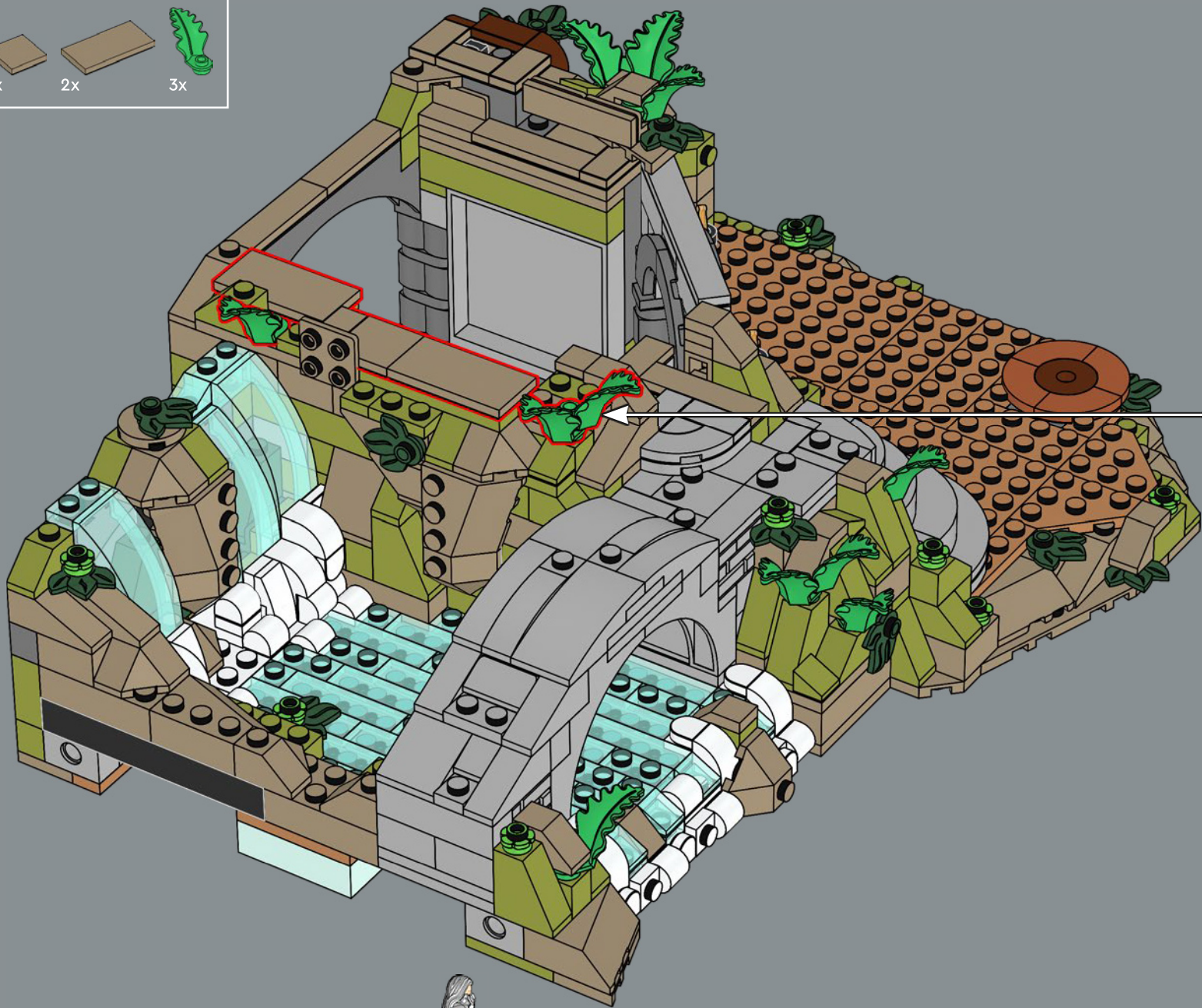

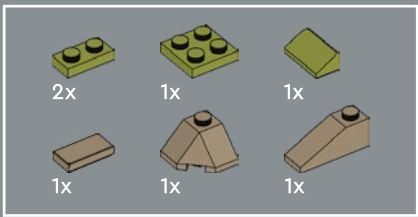

155

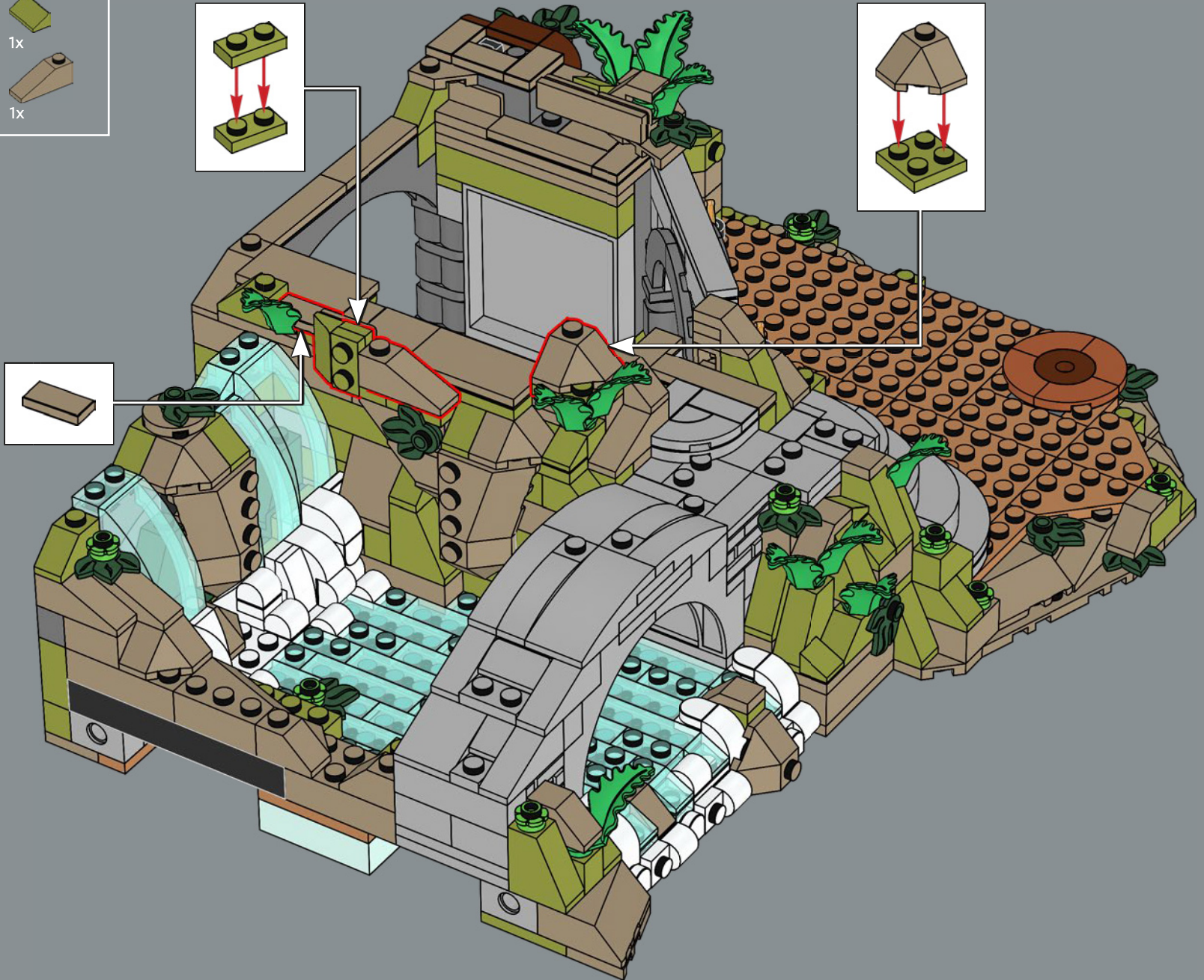
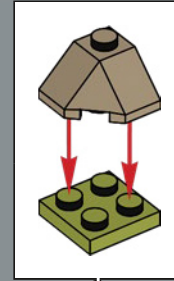
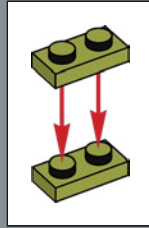

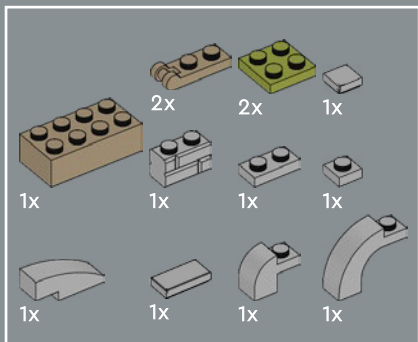

156

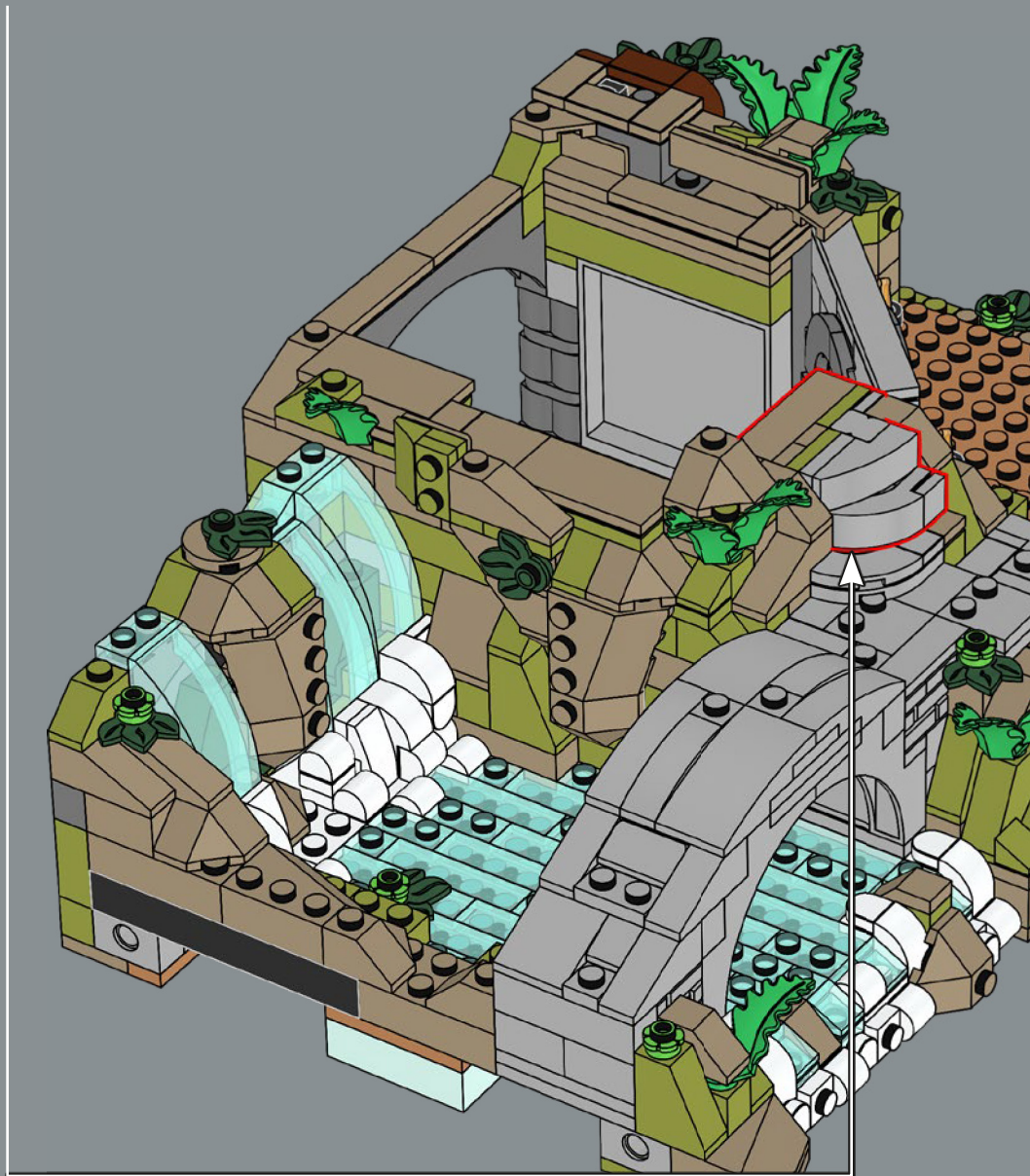
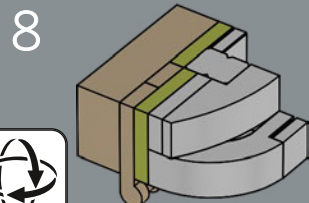
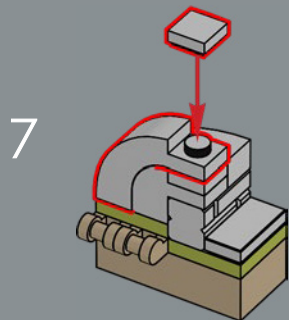
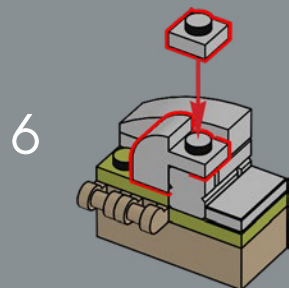
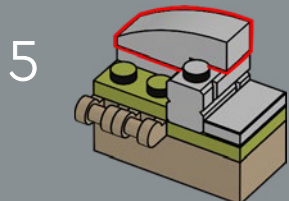
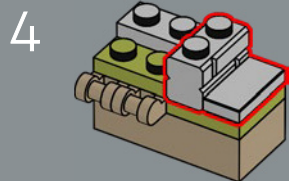
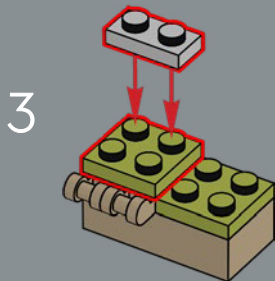
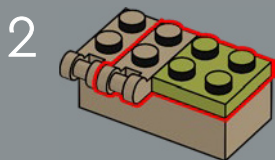
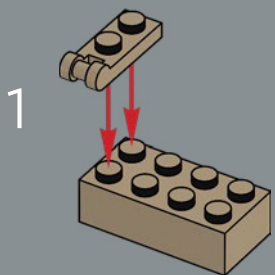



Das Elben-Haarteil ist ein brandneues Element für dieses Set und wird aus zwei verschiedenen Materialien geformt, um die Ohren farblich von den Haaren abzusetzen.

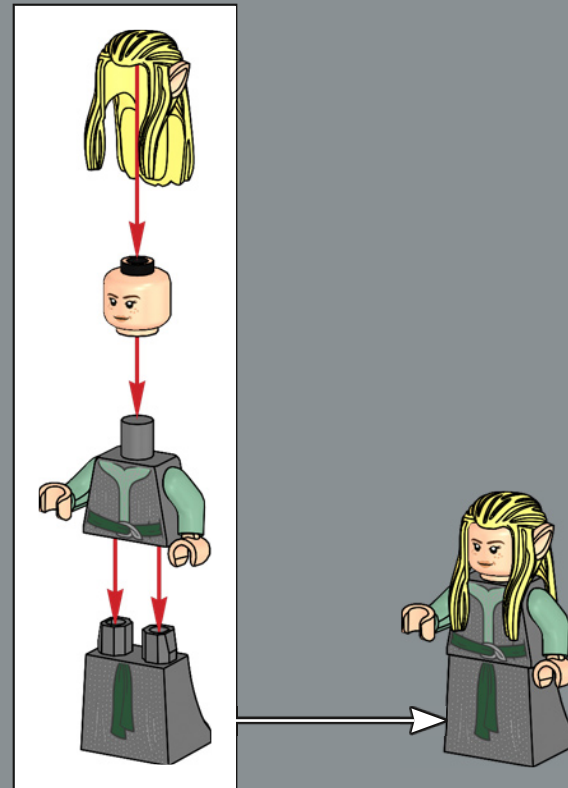

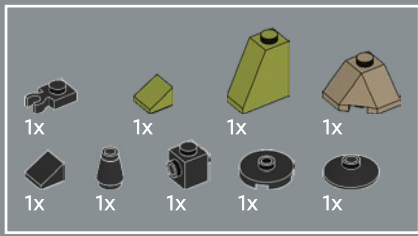

157

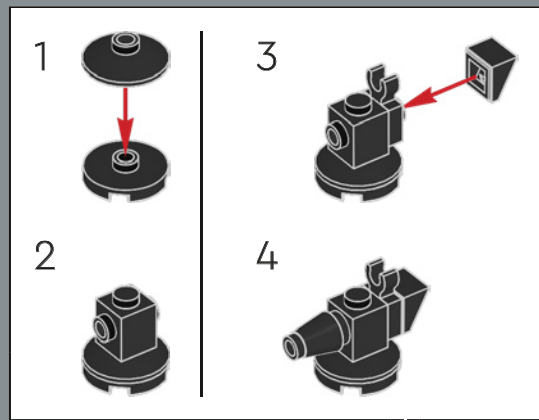

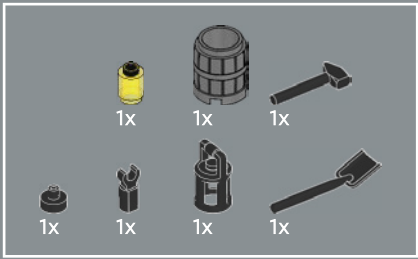

158

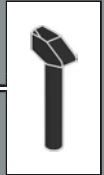
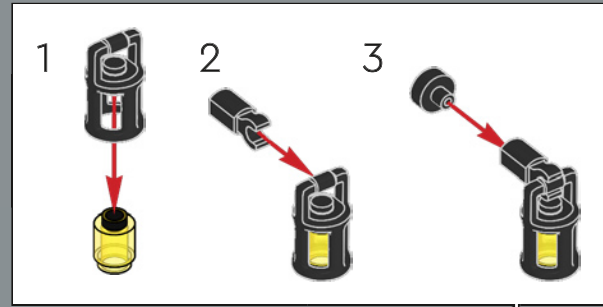



-  2x
-  2x
-  3x
-  2x
-  1x

159

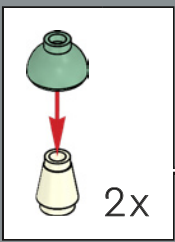
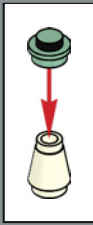
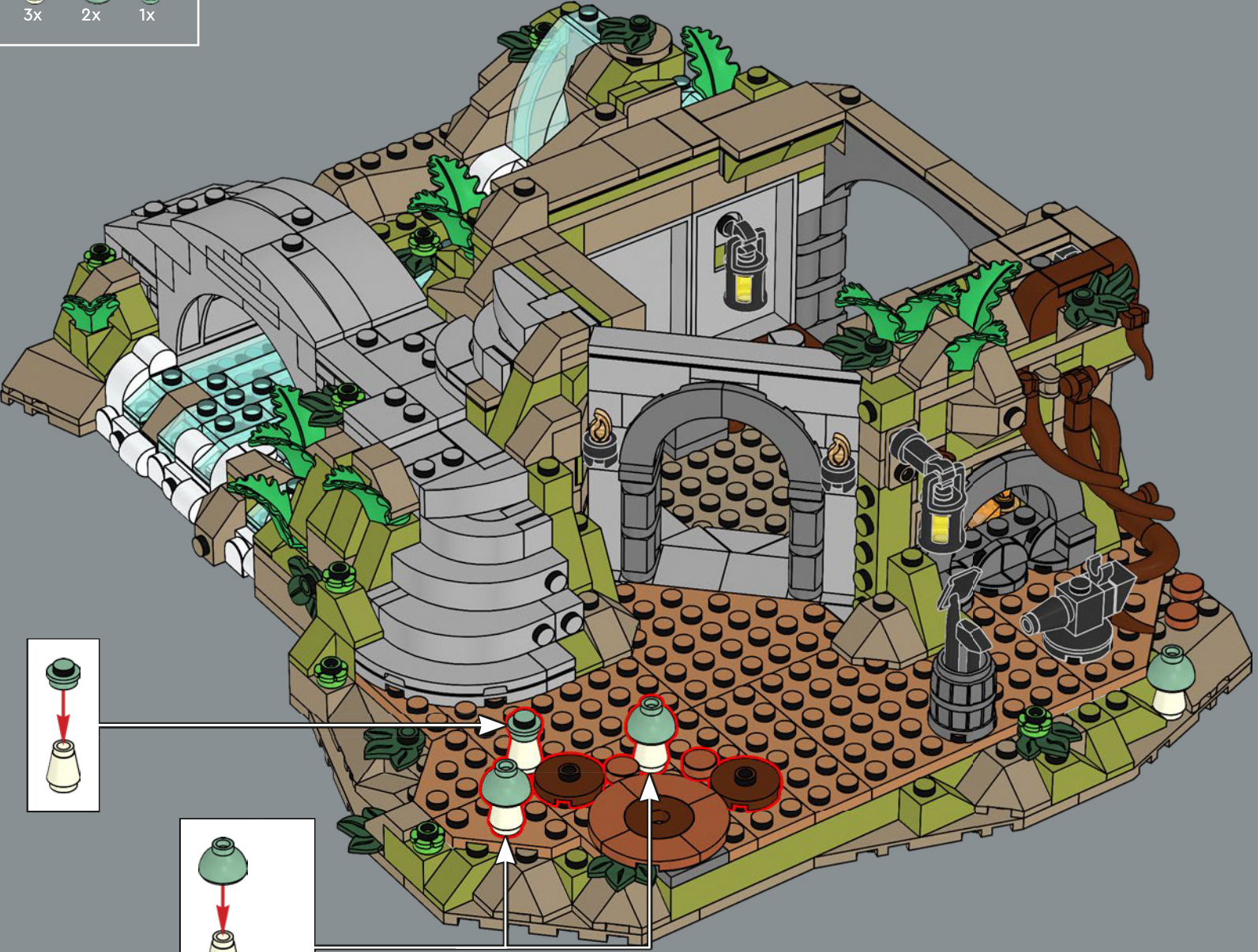

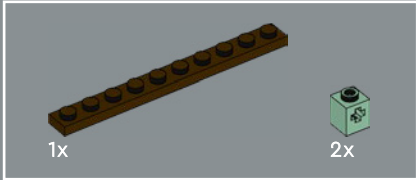
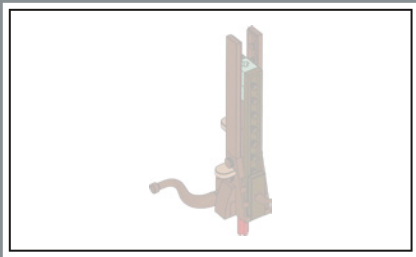

160

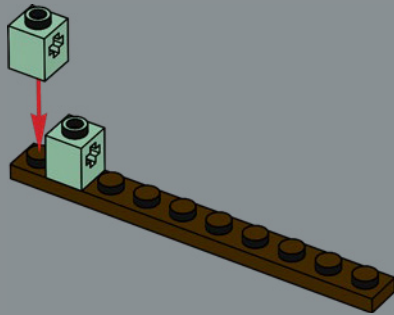

161

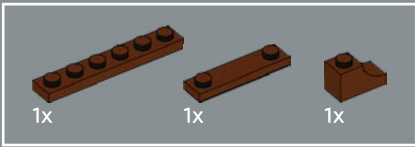
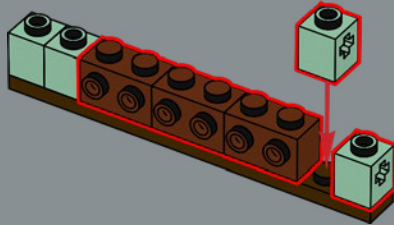

162

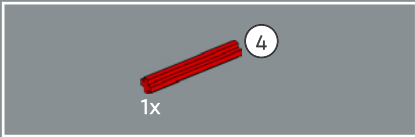
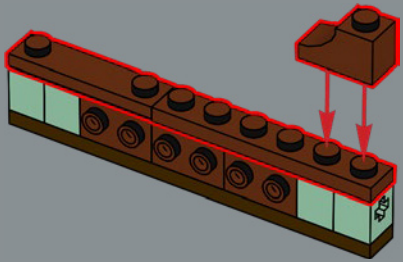

163

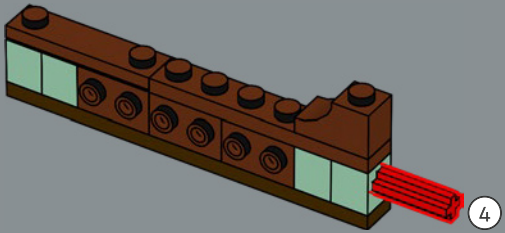

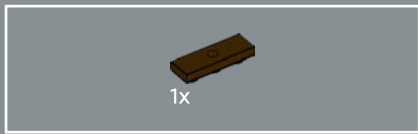

164

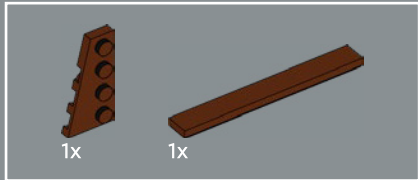
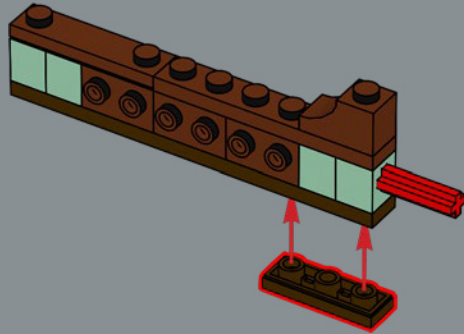

165

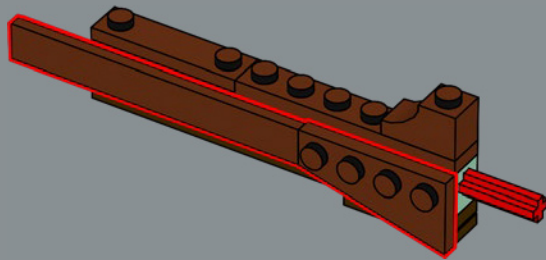

166

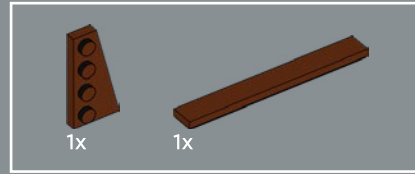
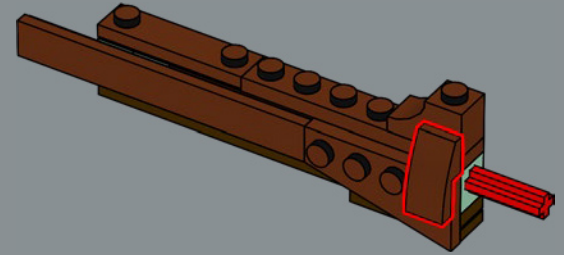

167

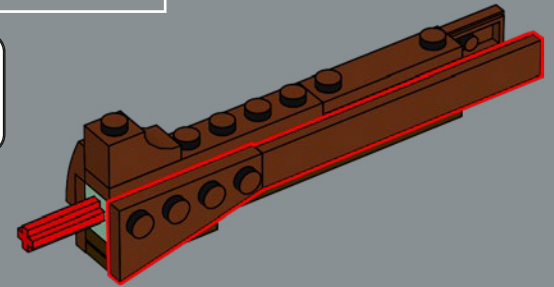



168

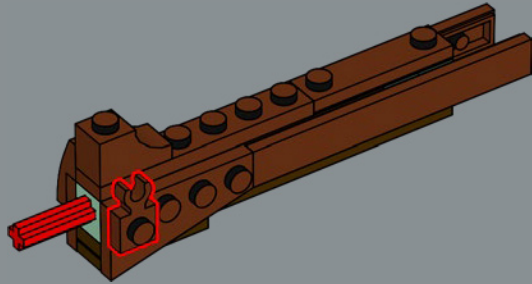

169

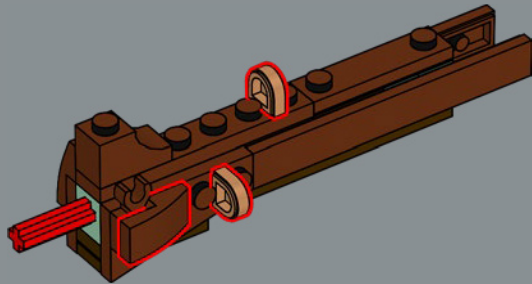

170

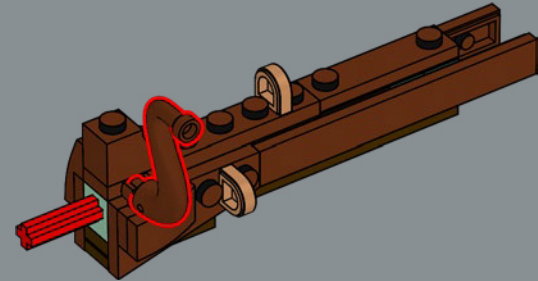

171

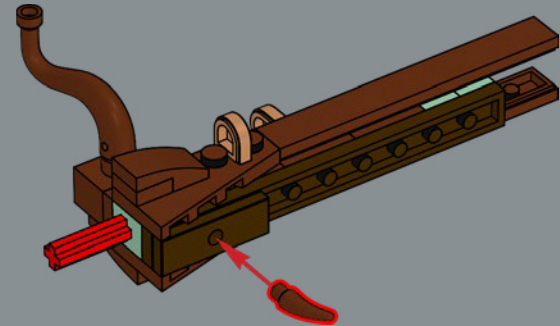



In dem Set befinden sich drei verschiedene Pilz-Modelle,  
darunter auch einteiliger Pilz.

172

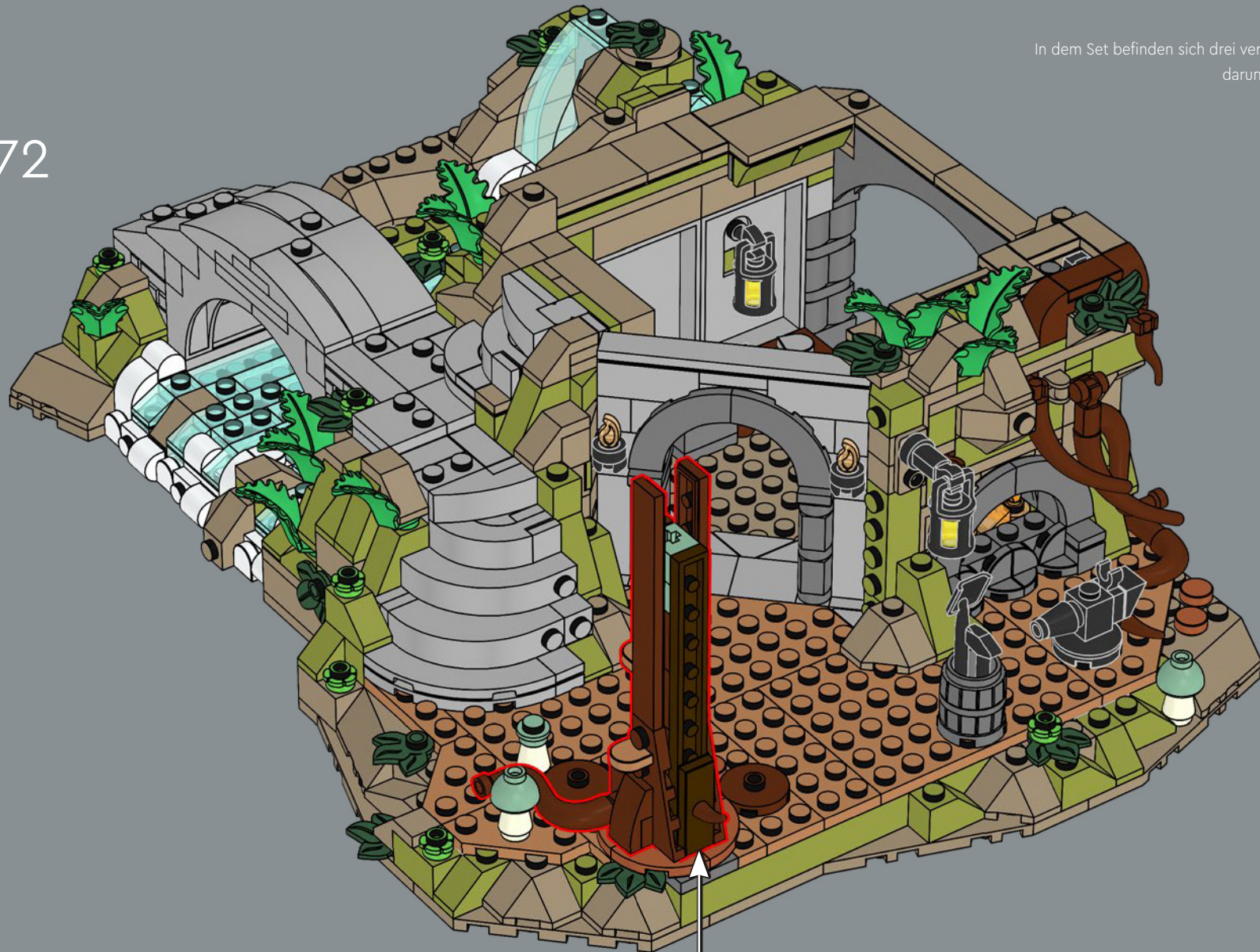



173

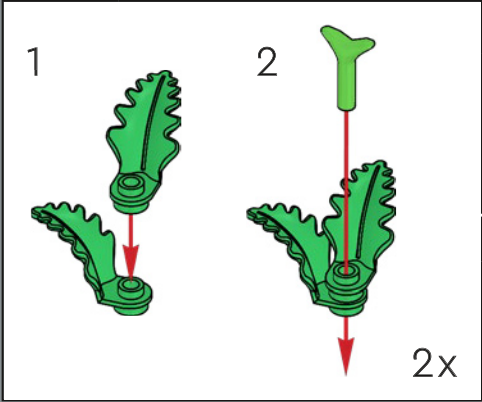
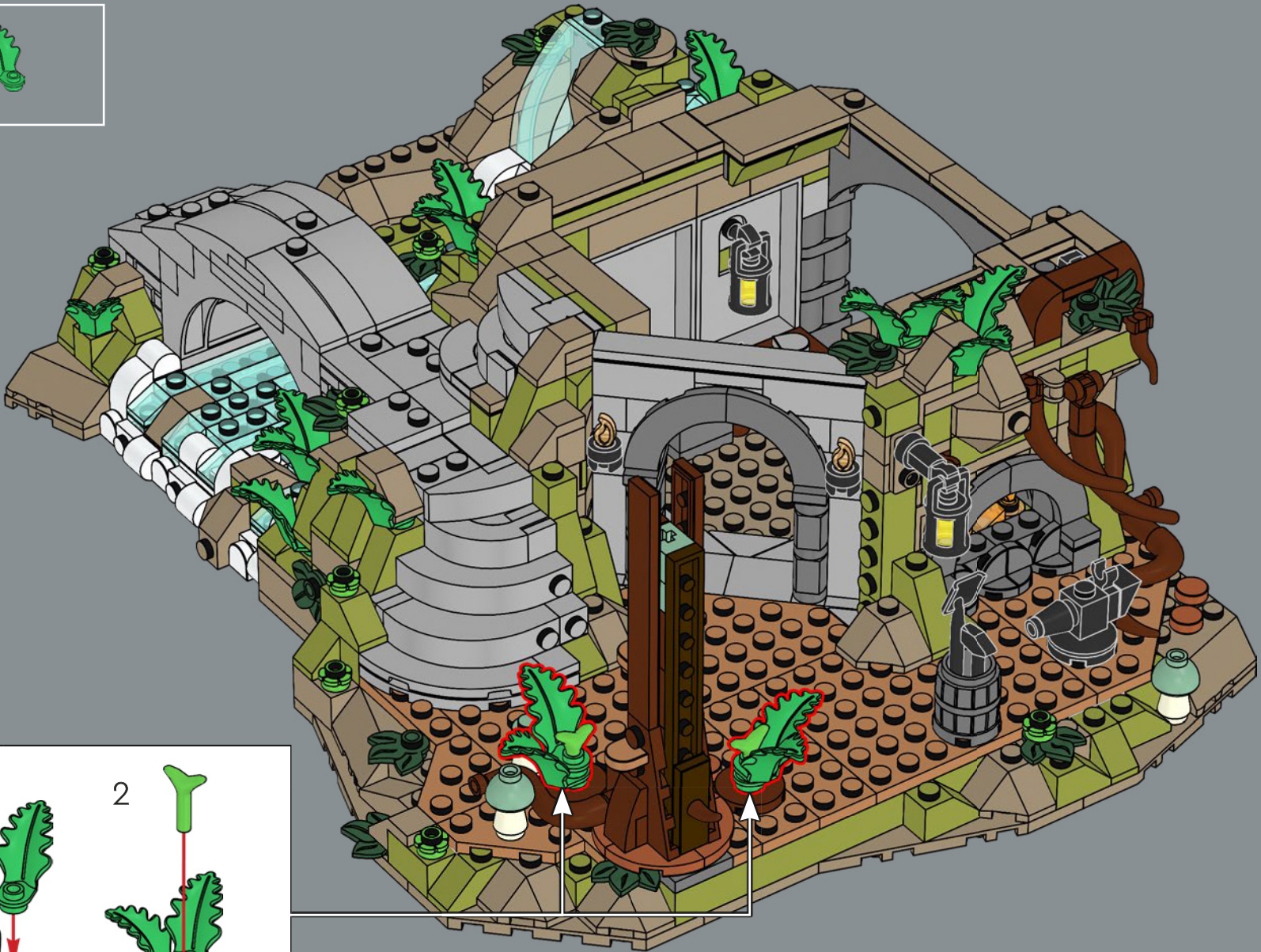

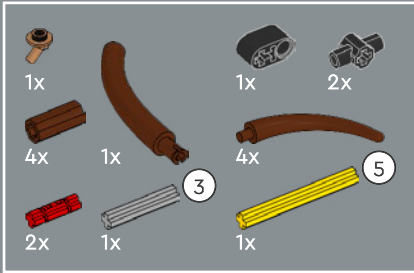
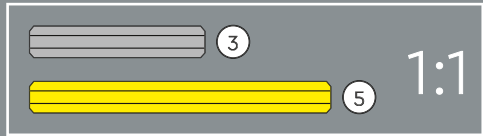
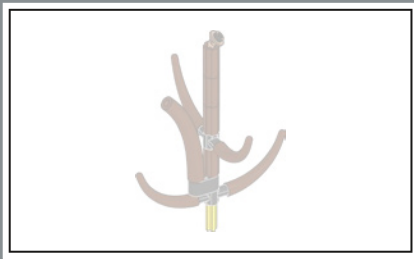

174

1



3

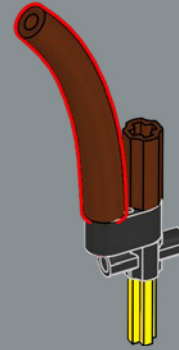

5

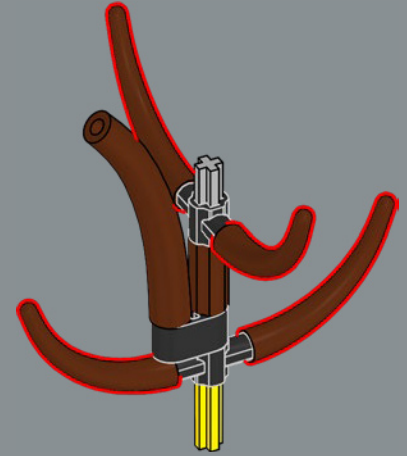

2

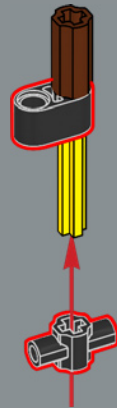

4

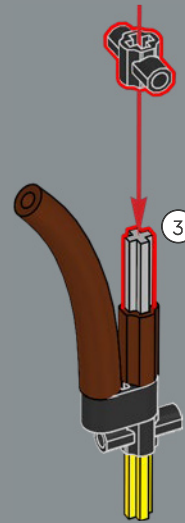

6

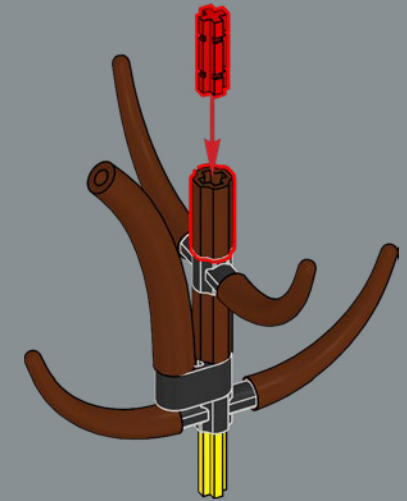

7

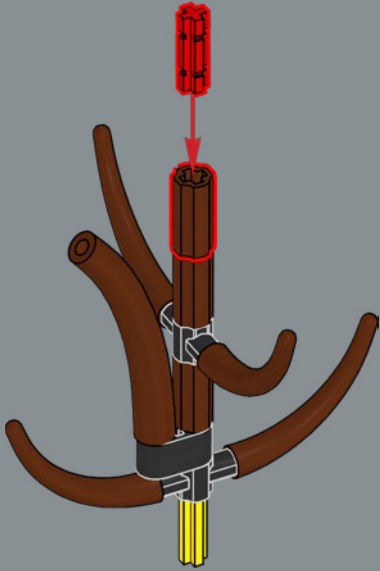

8

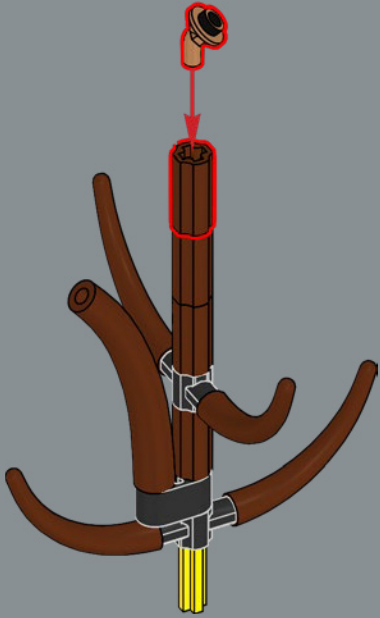





175

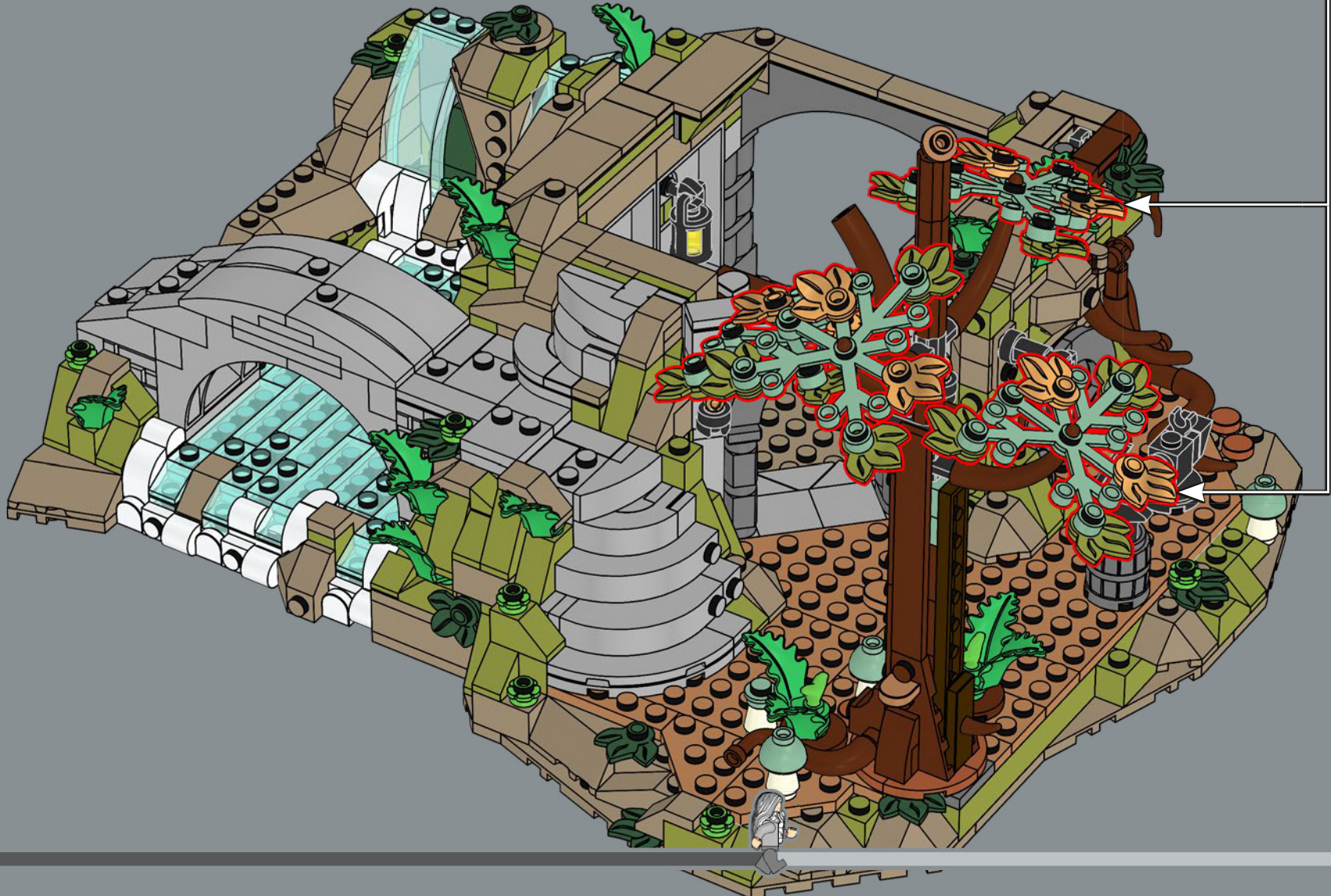
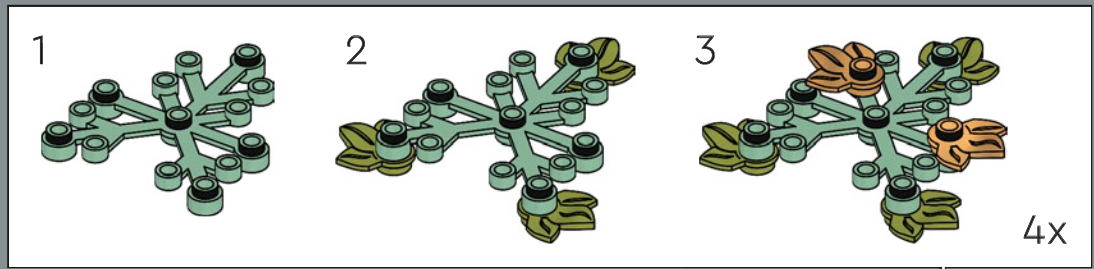

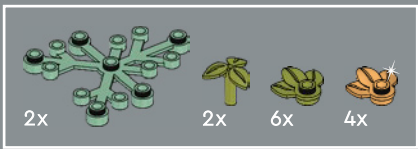

176

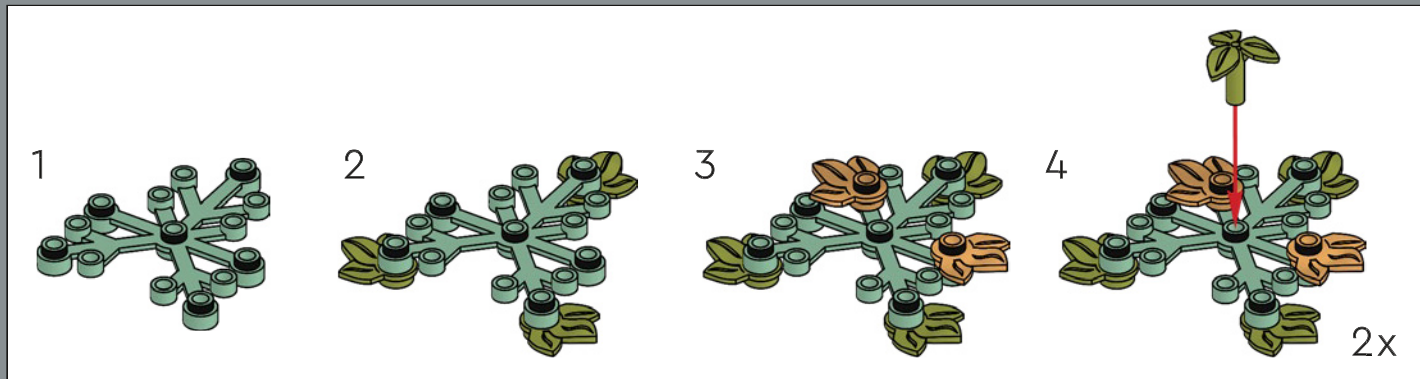

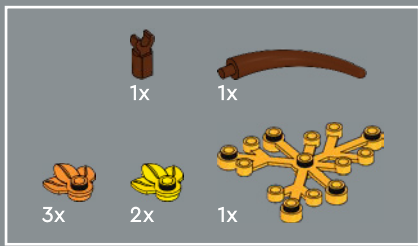

177

1

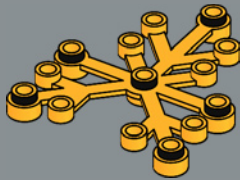

2

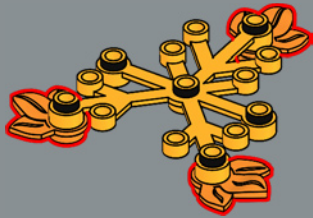

3

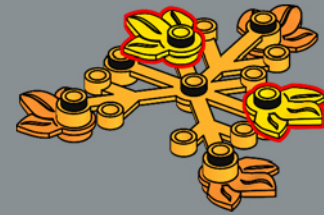

4

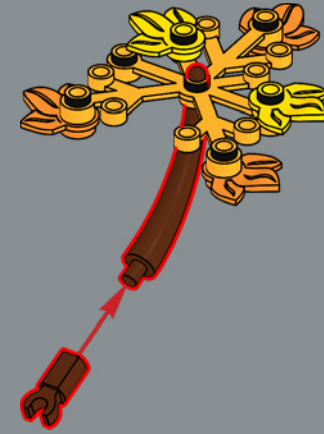

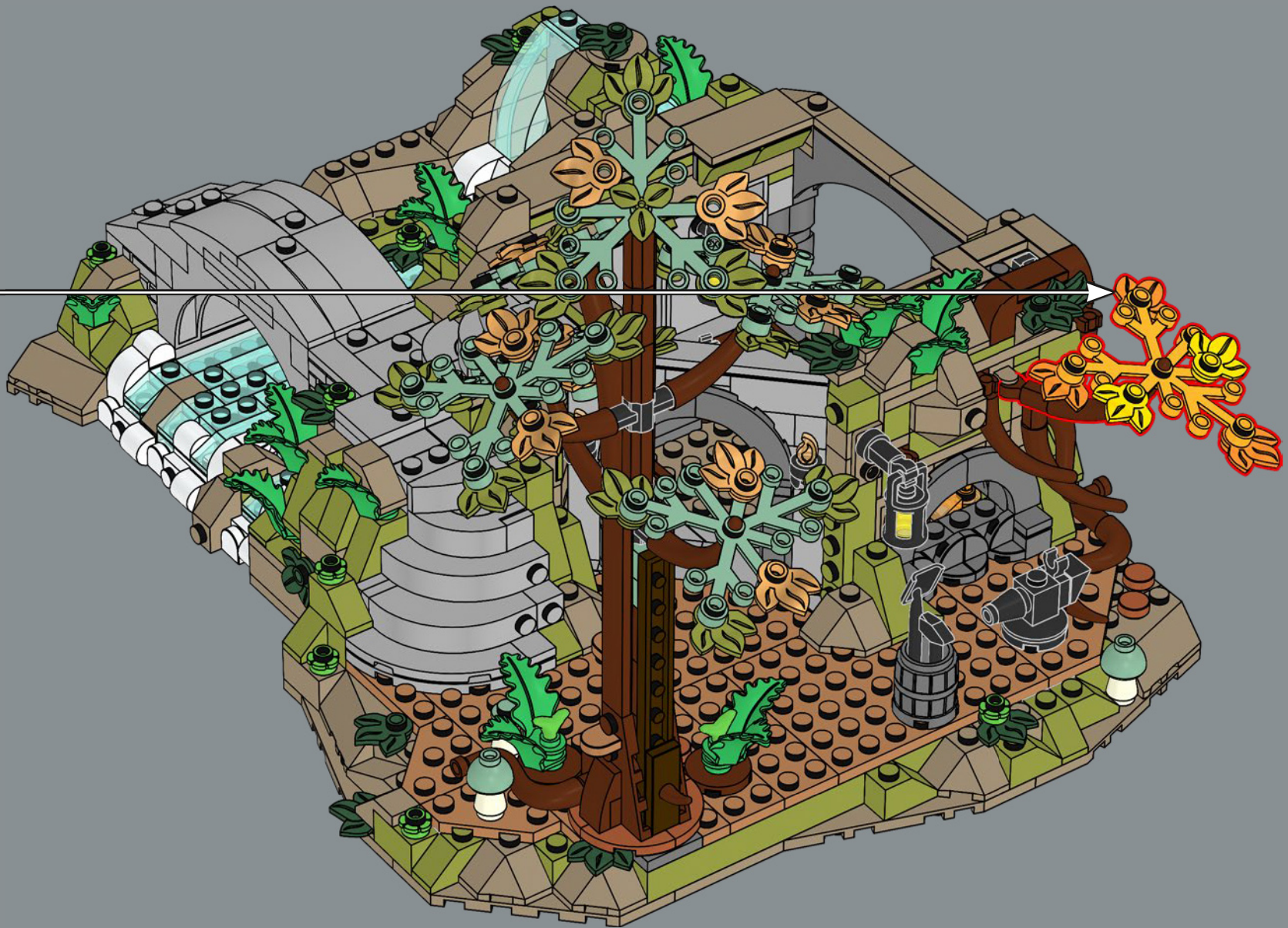

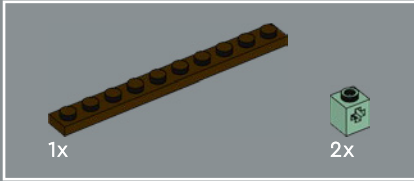
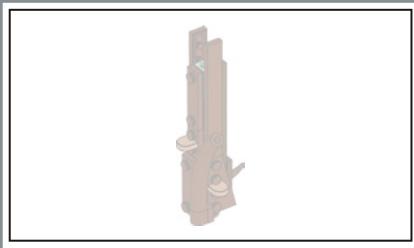

178

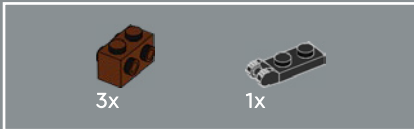
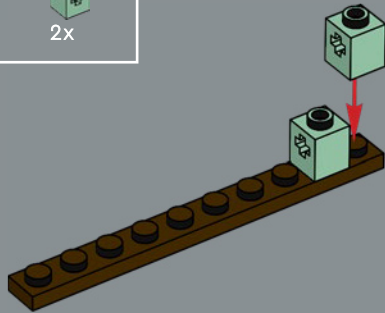

179

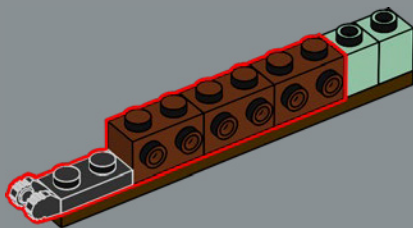

180

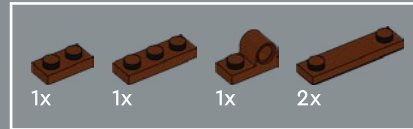
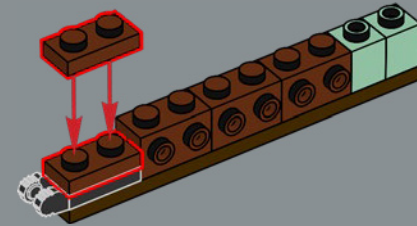

181

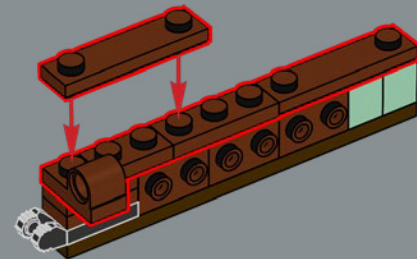

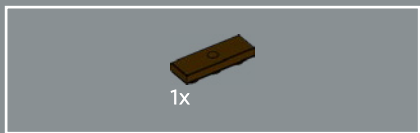

182

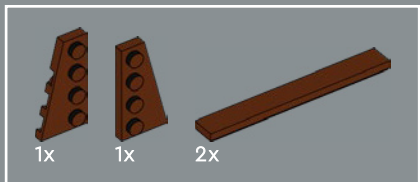
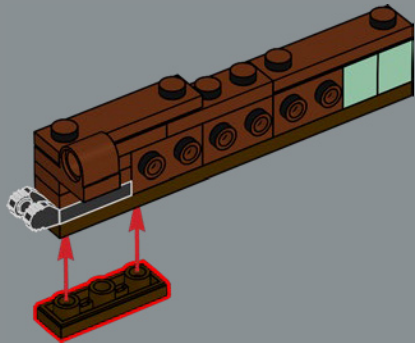

183

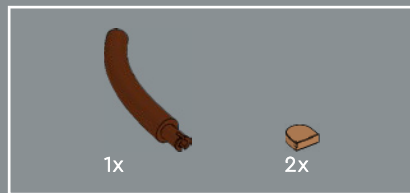
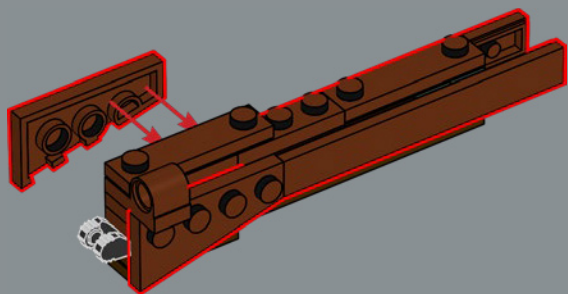

184

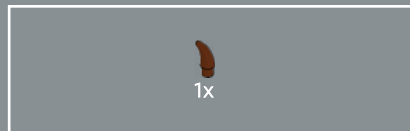
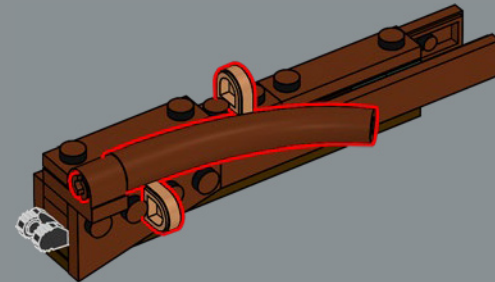

185

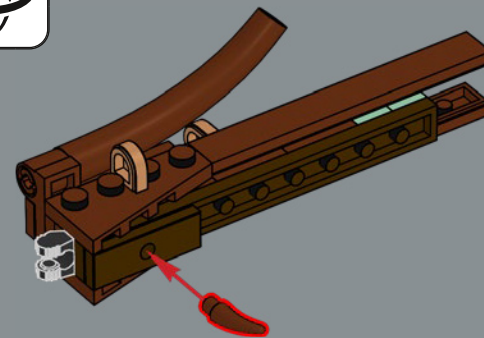

186



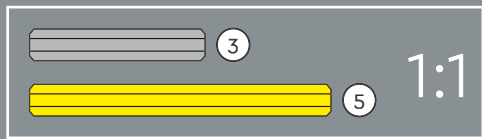
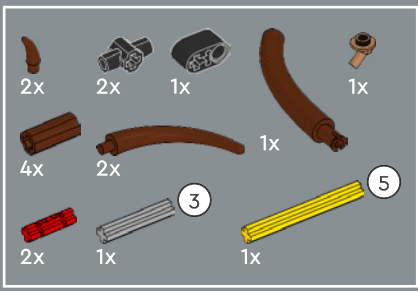

187

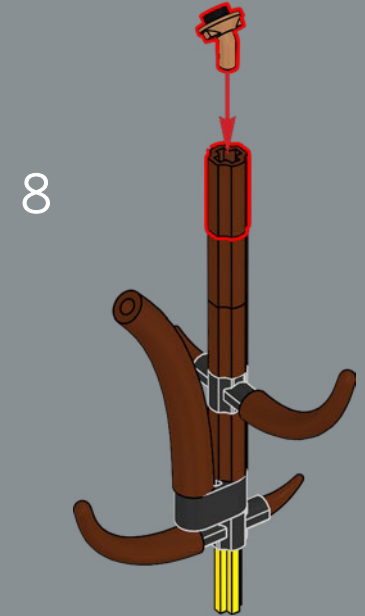
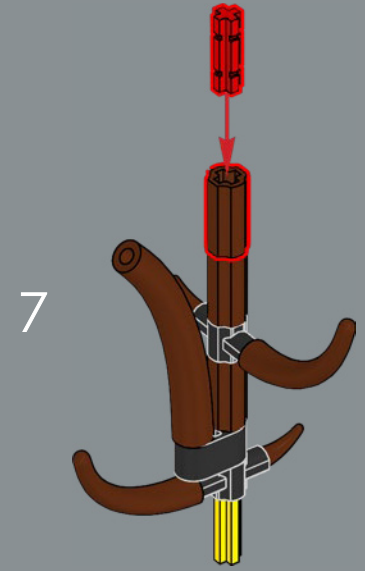
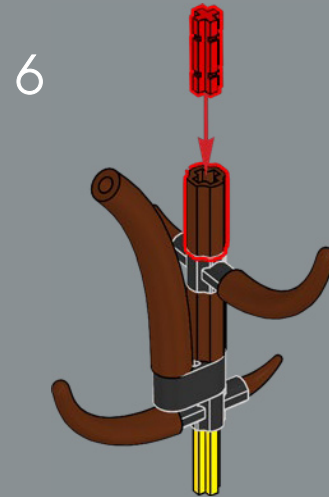
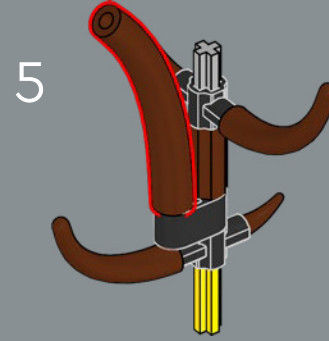
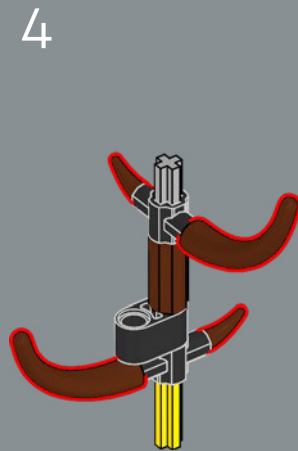
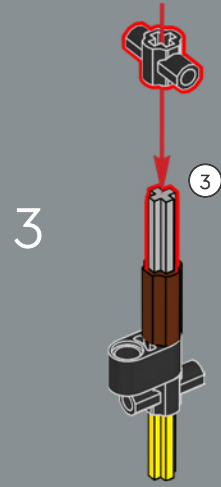
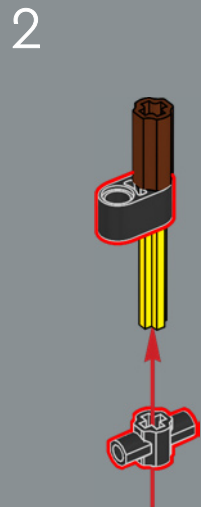
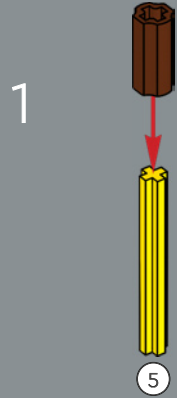







188

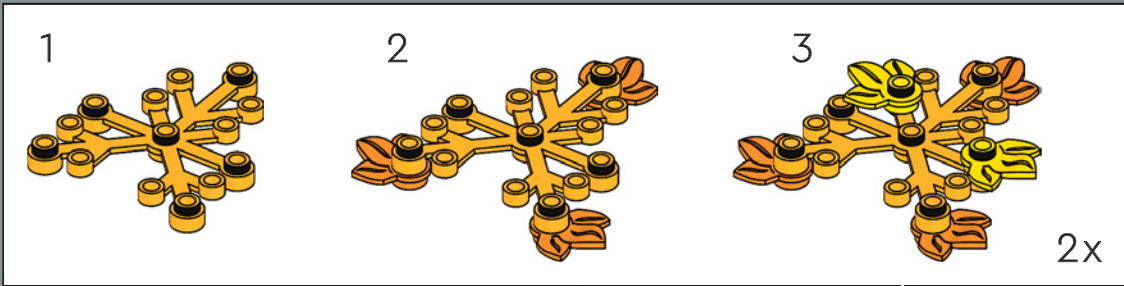



189

1

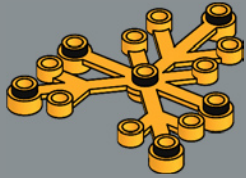

2

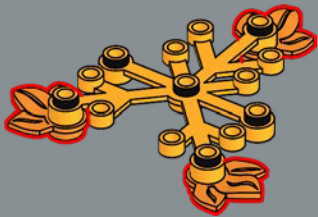

3

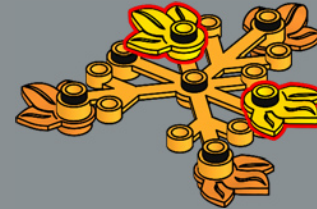

4

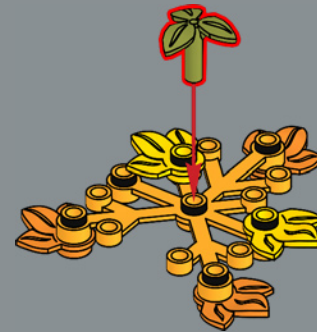

3x



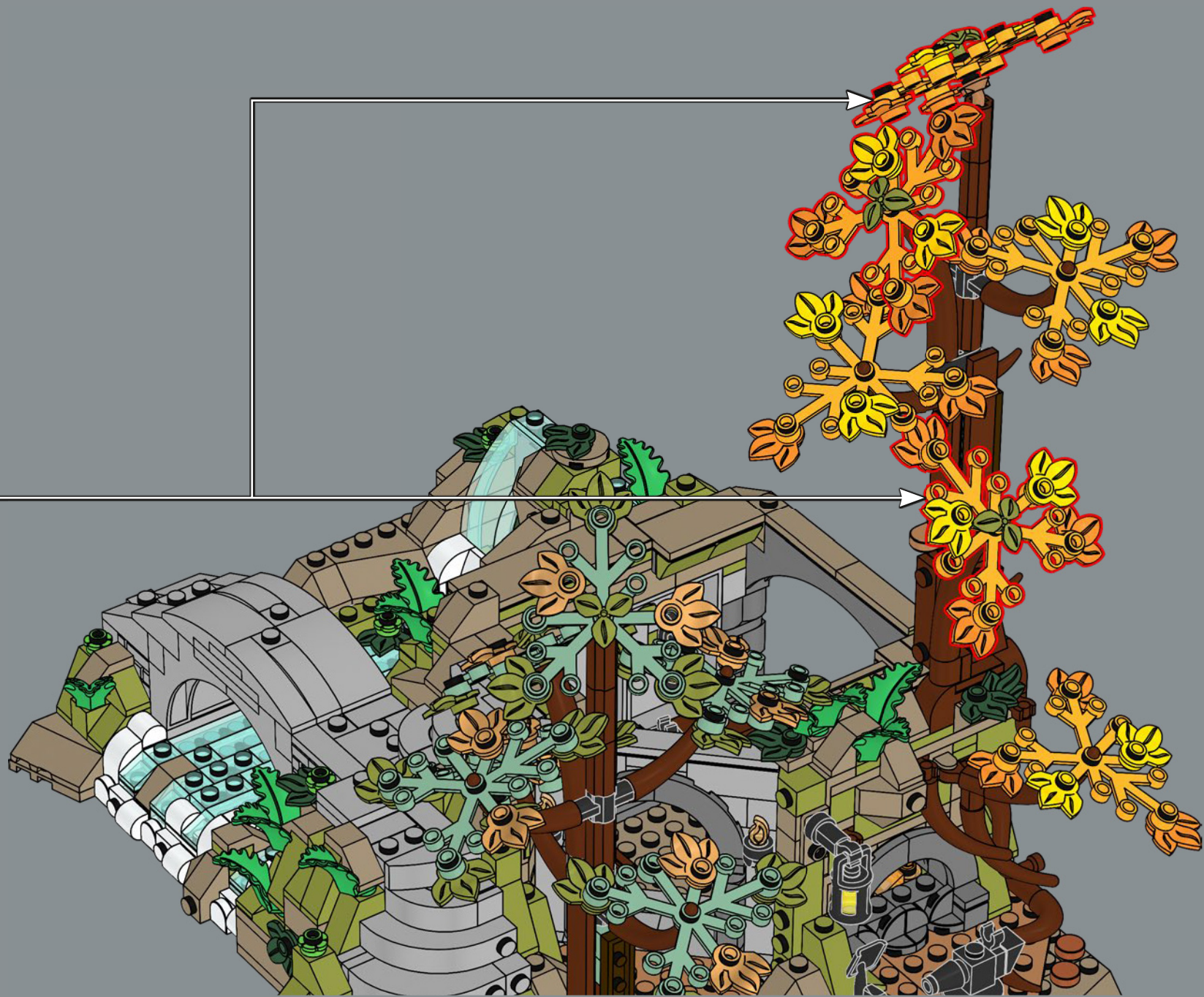

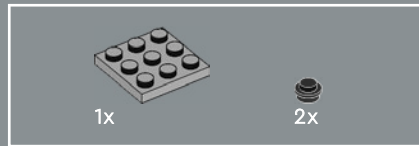
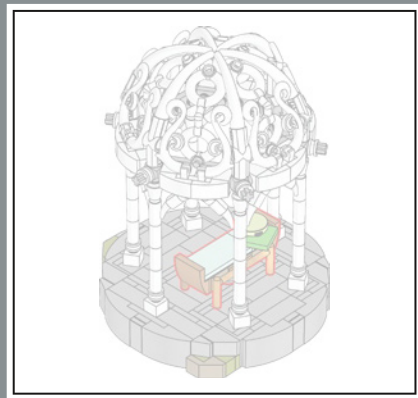

190

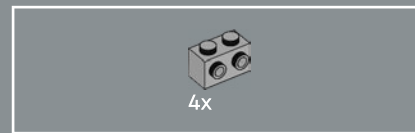
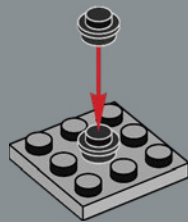

191

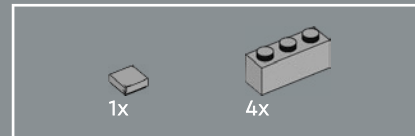
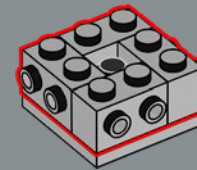

192

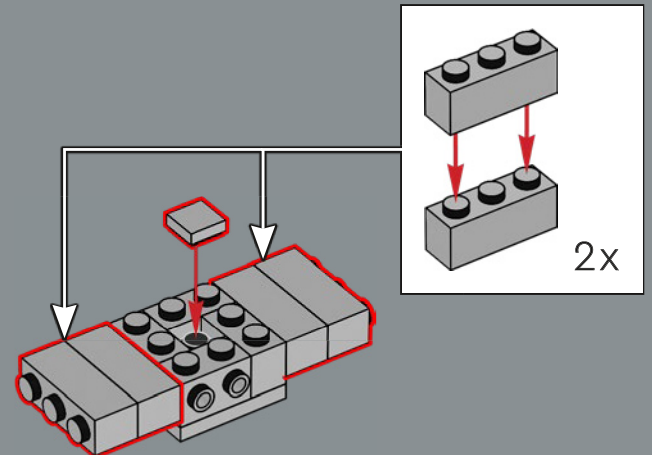

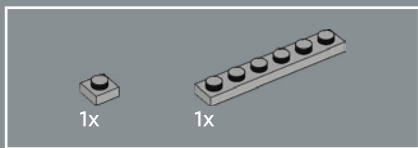
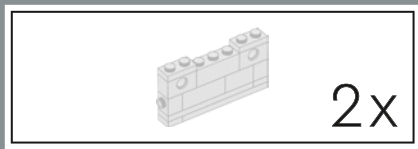

193

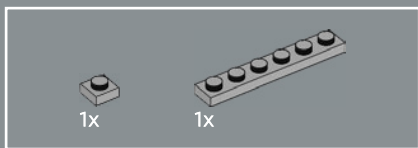
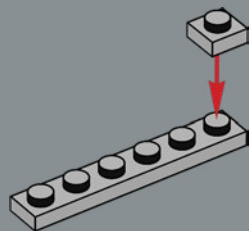

194

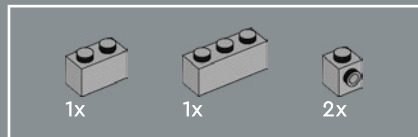
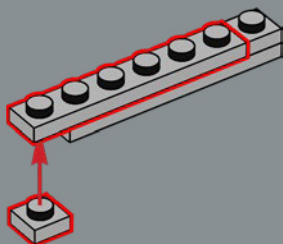

195

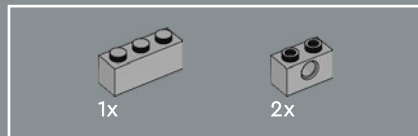
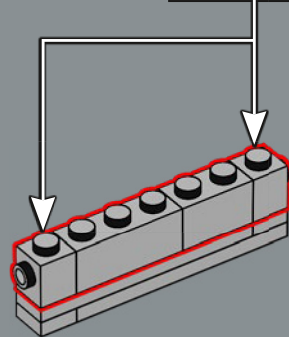

196

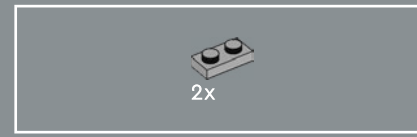
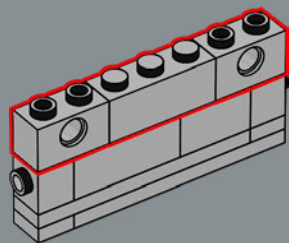

197

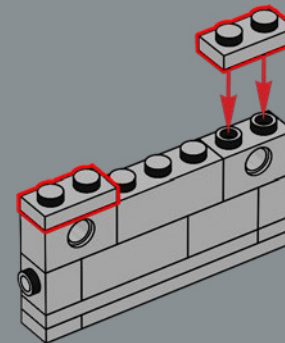

2x

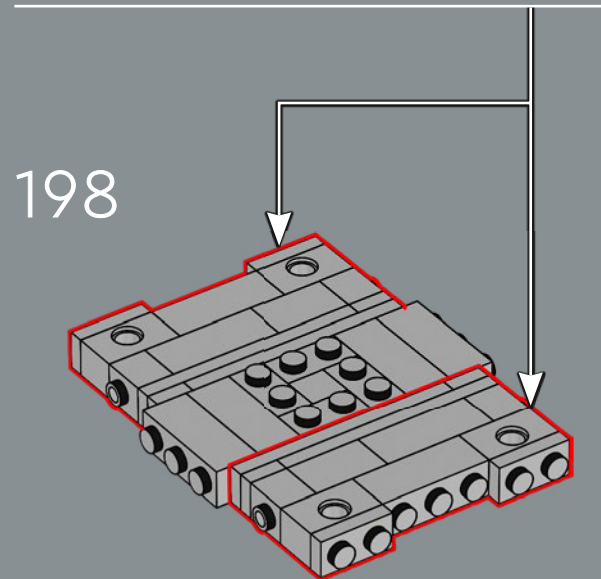

198

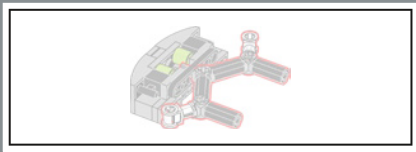

199

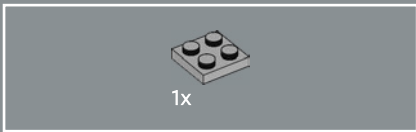
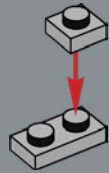

200

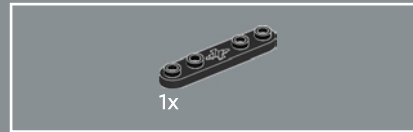
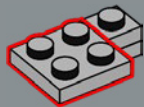

201

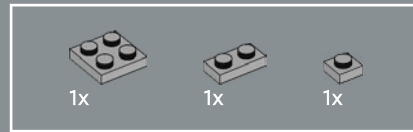
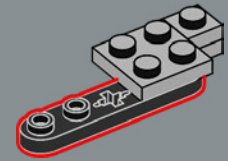

202

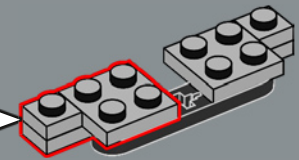
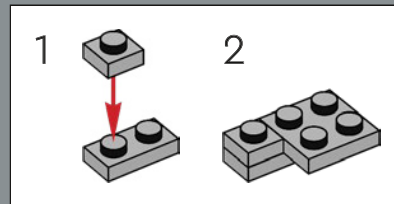

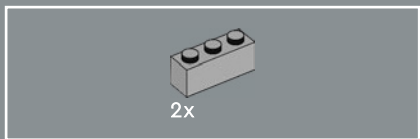

203

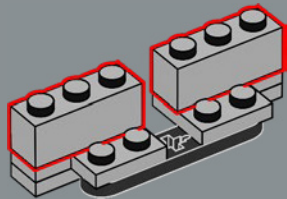

204

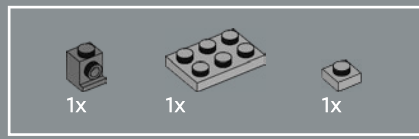
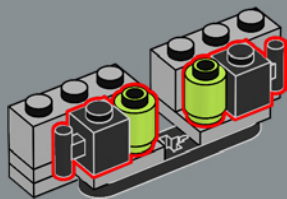

205

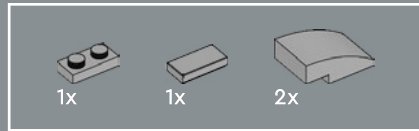
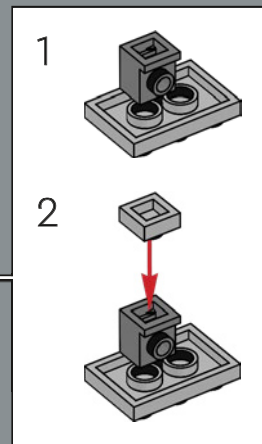
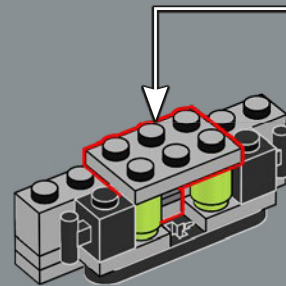

206

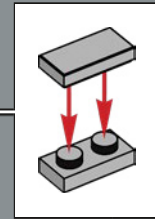
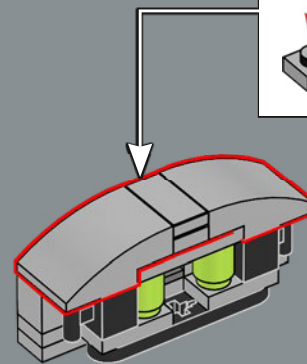





Der Boden des Pavillons war für uns eines der kniffligsten geometrischen Puzzles bei der Entwicklung dieses Modells.



# 207

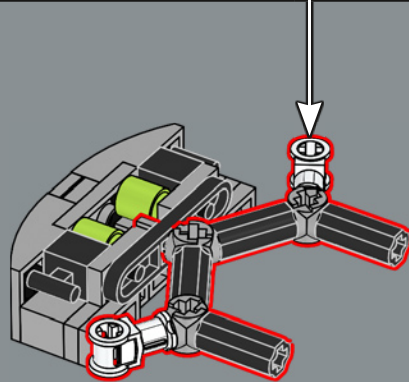
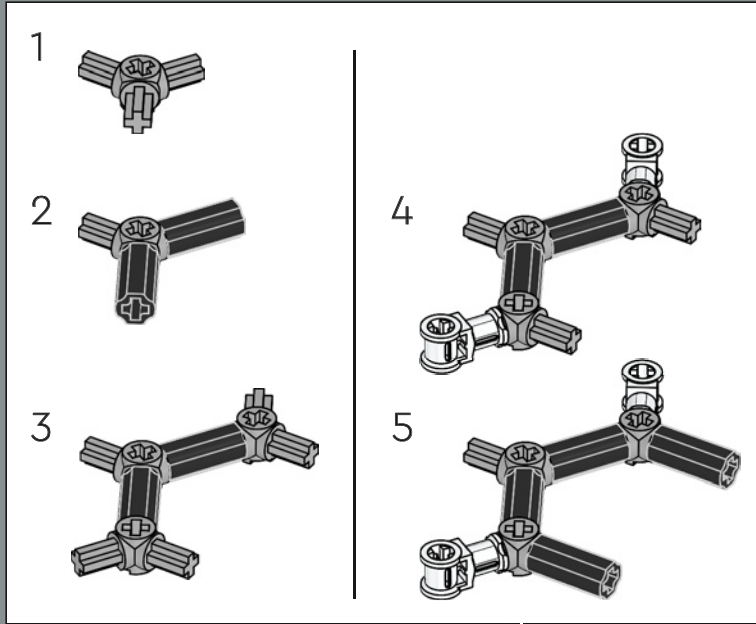

# 208

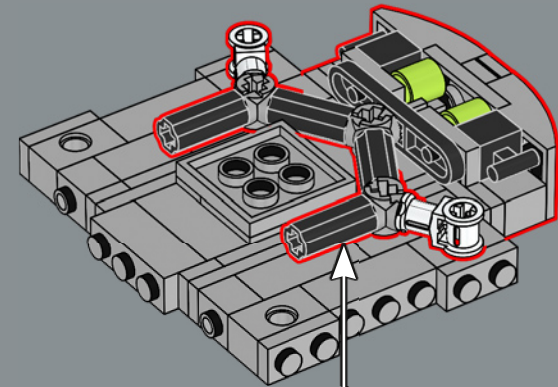

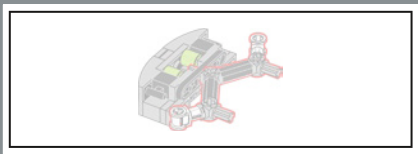

209

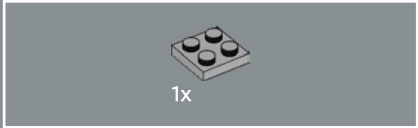
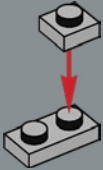

210

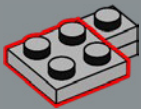

211

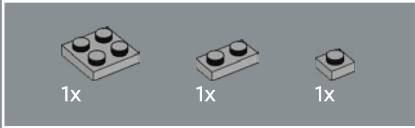
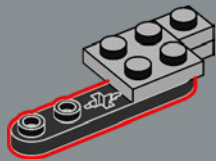

212

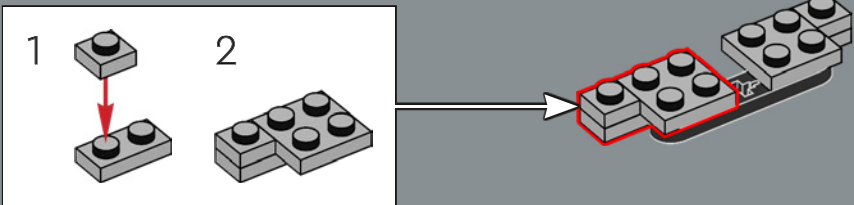

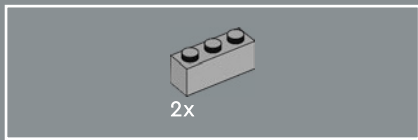

213

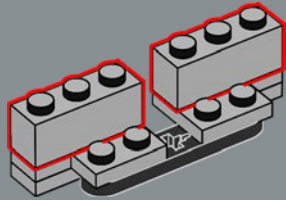

214

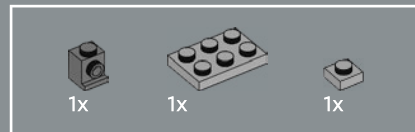
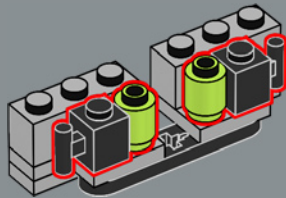

215

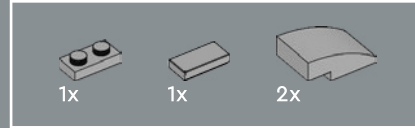
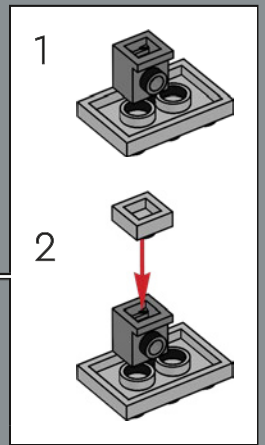
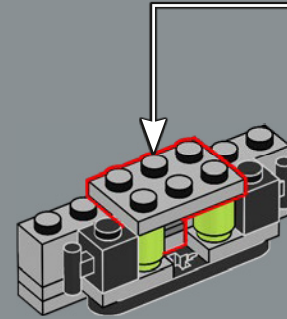

216

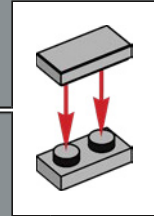
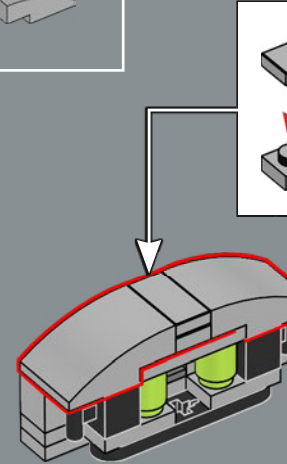



217

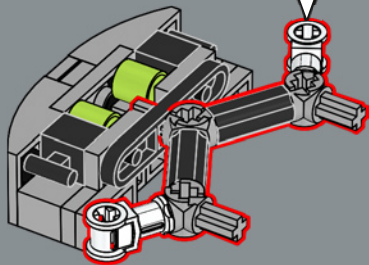
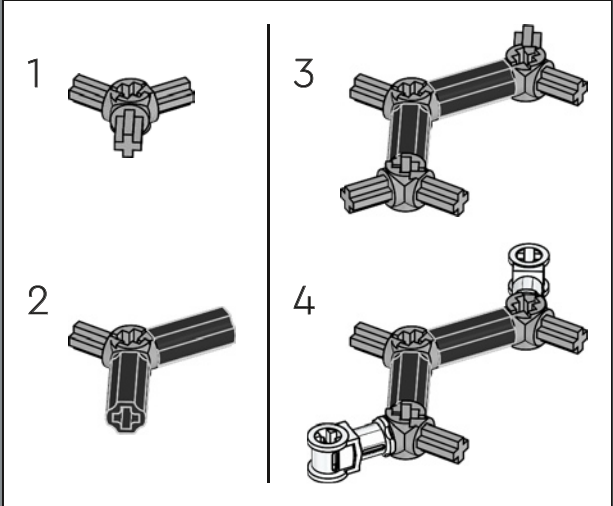

218

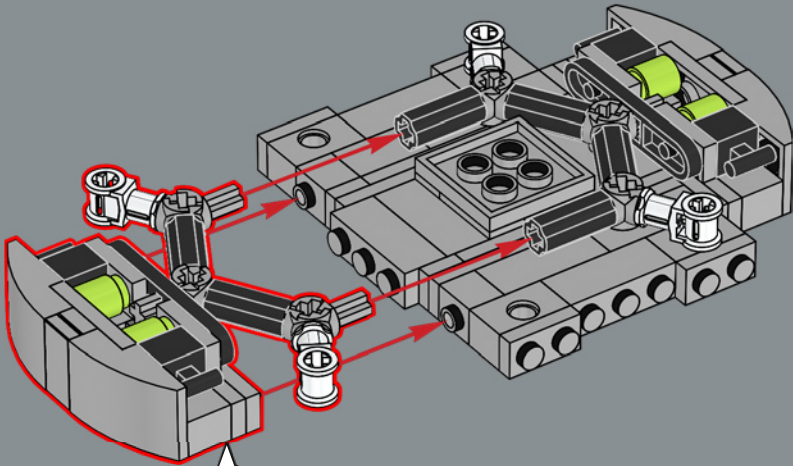

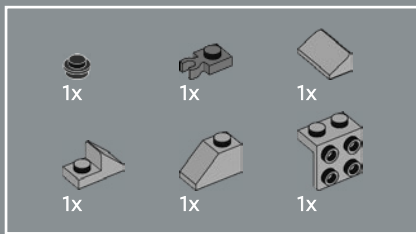

219

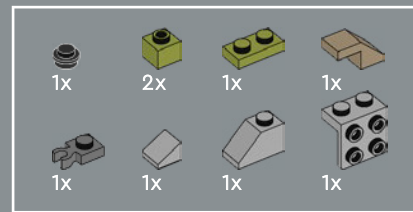
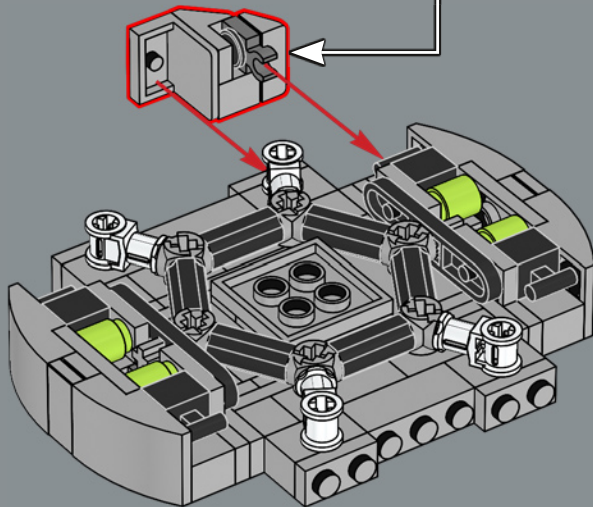
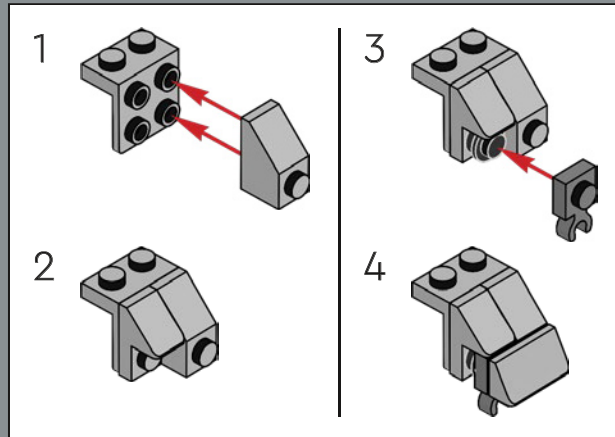

220

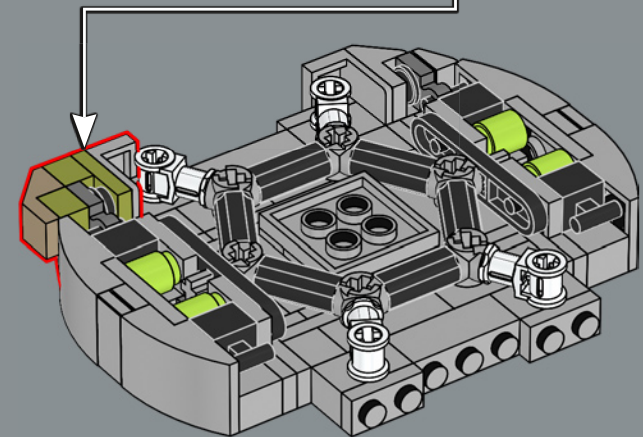
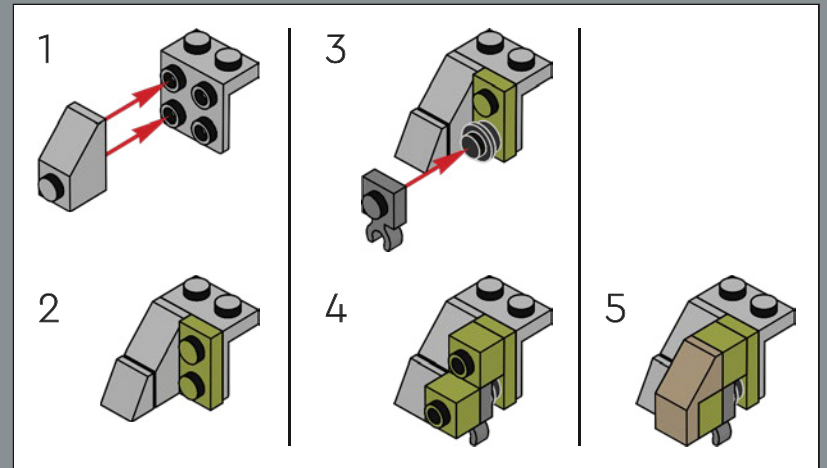



221

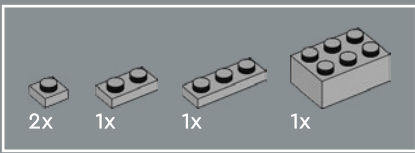
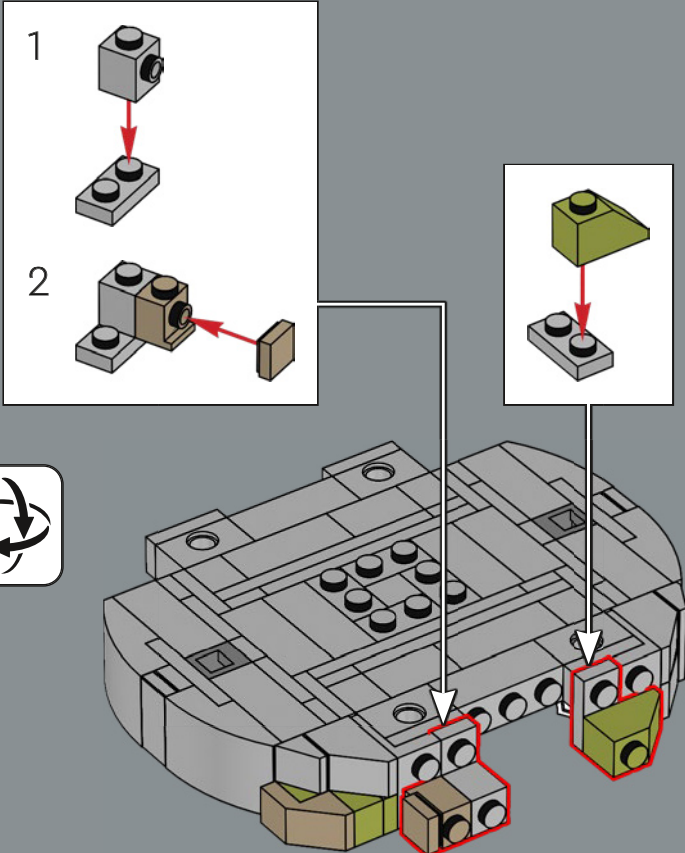

222

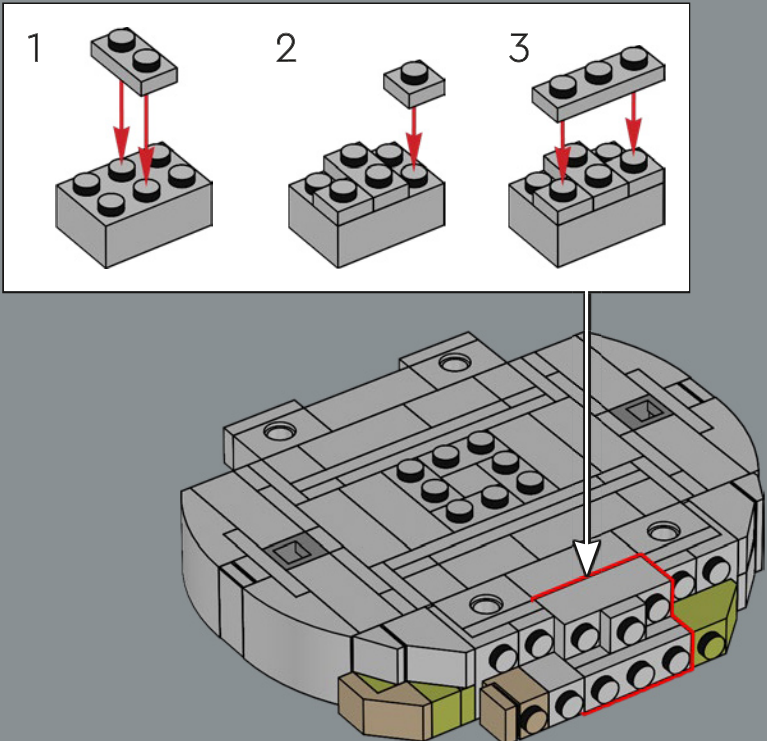

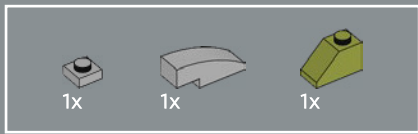

223

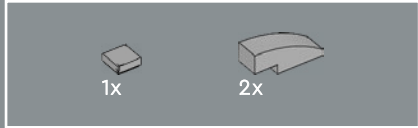
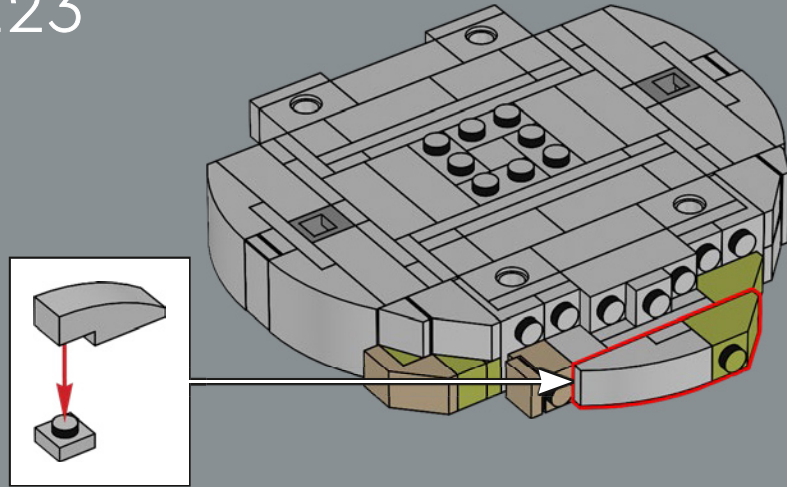

224

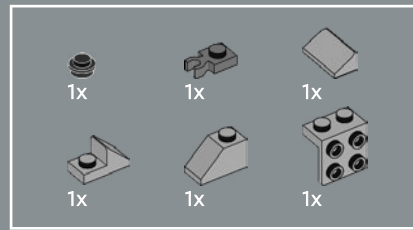
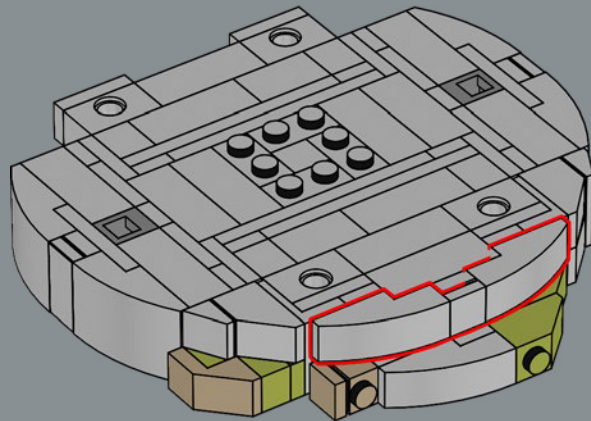

225

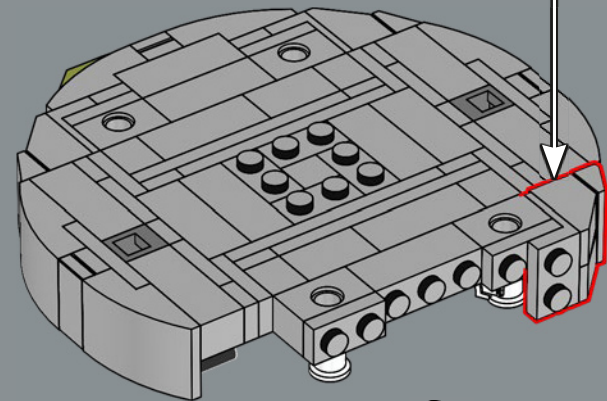
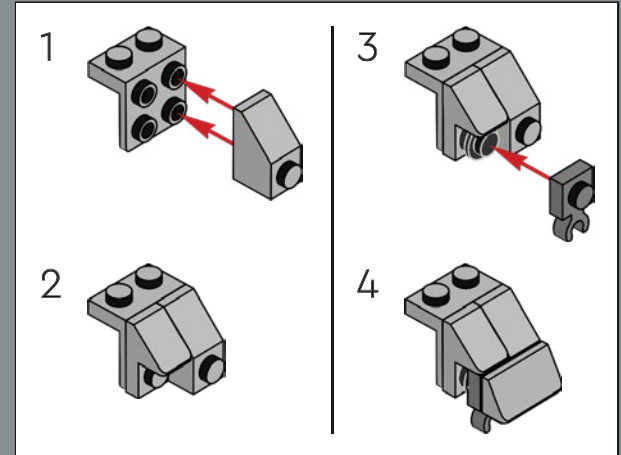

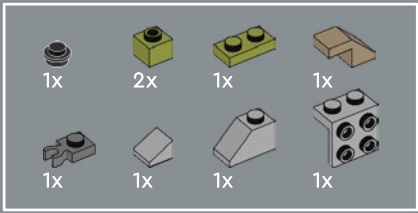

226

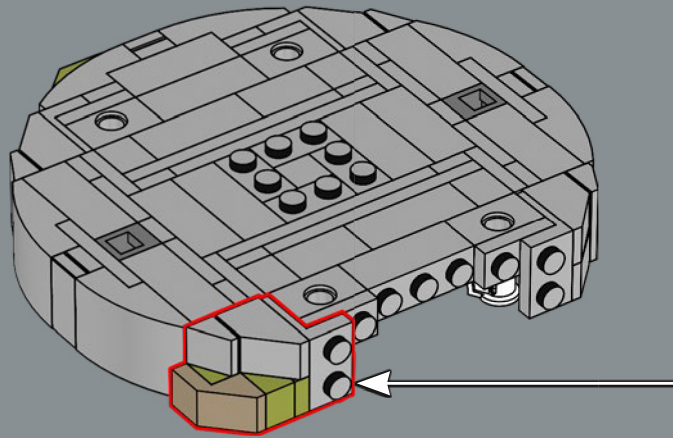
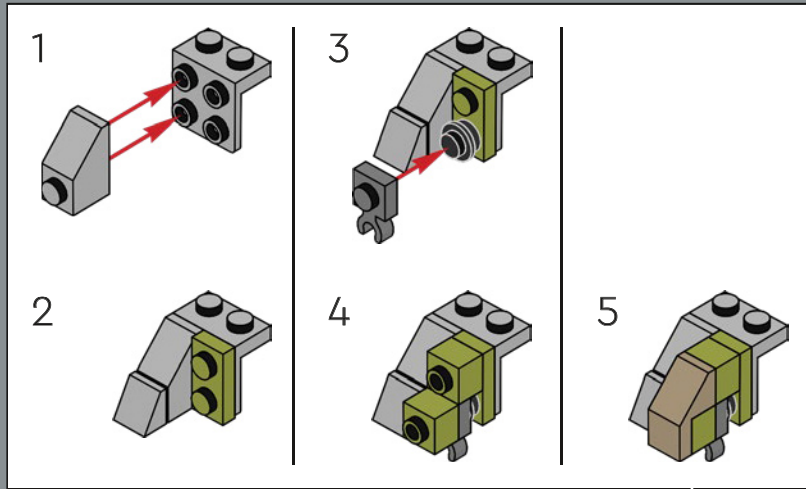



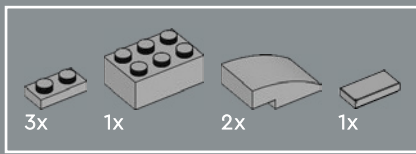

227

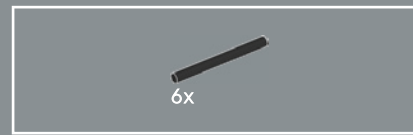
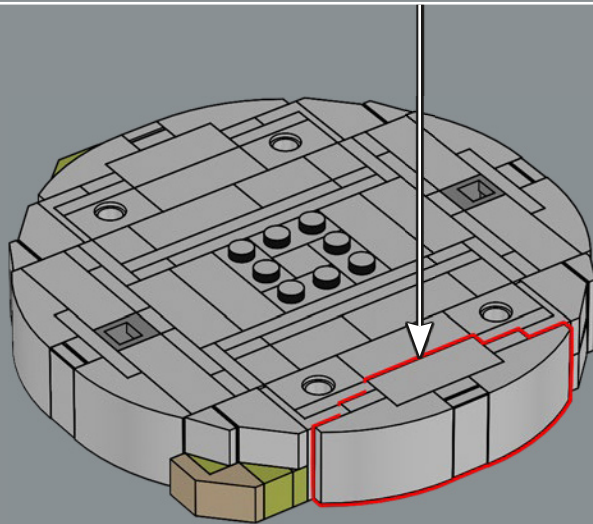
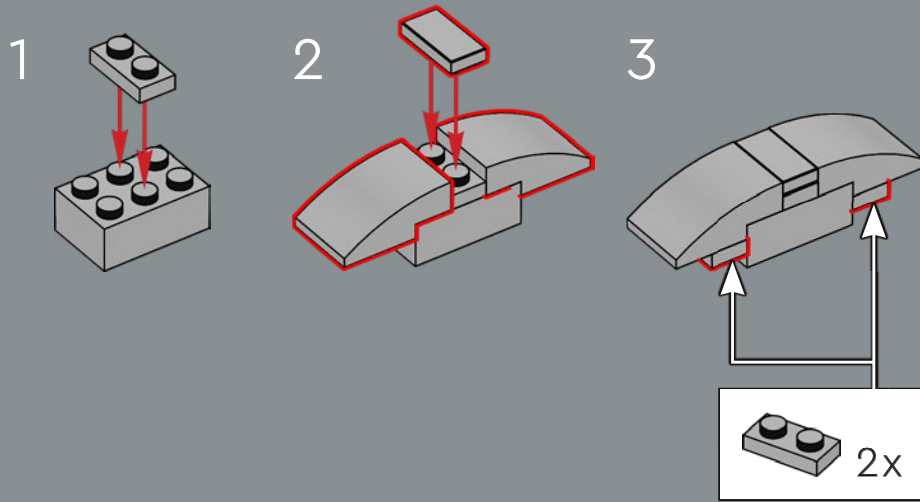

228

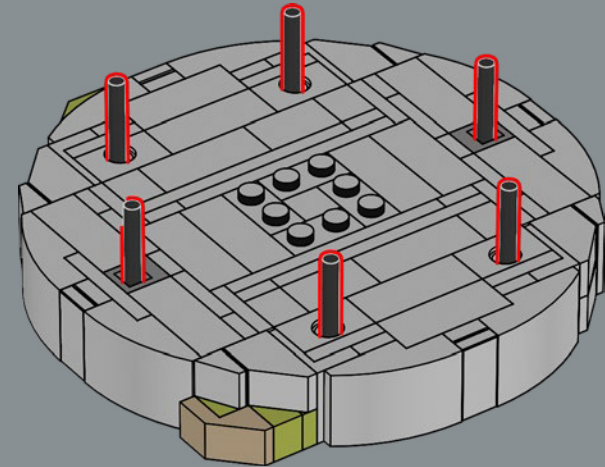



6x

229

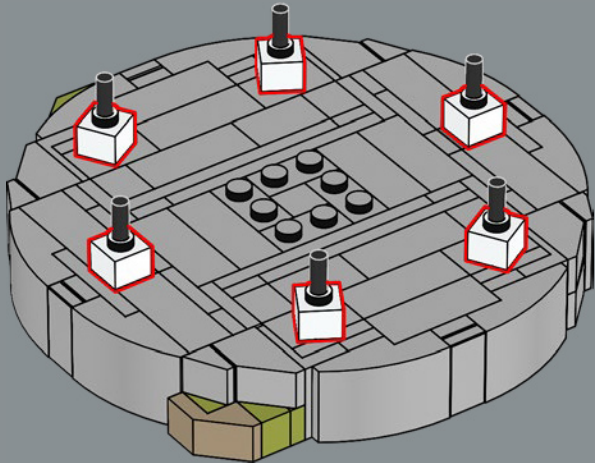

6x

230

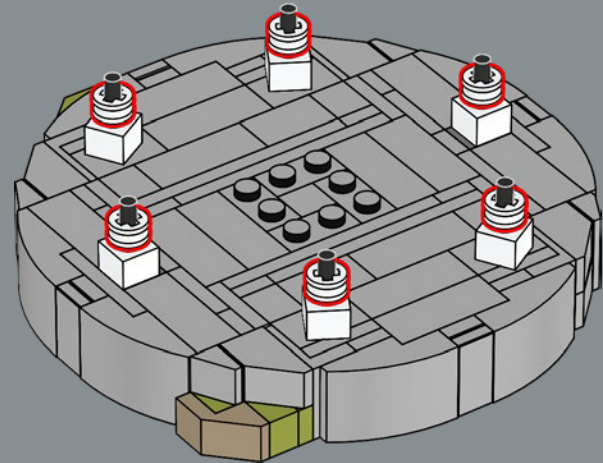

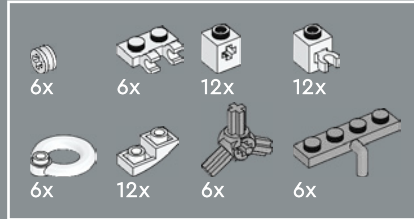
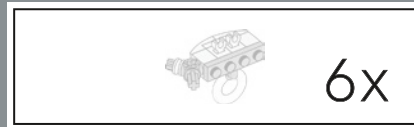
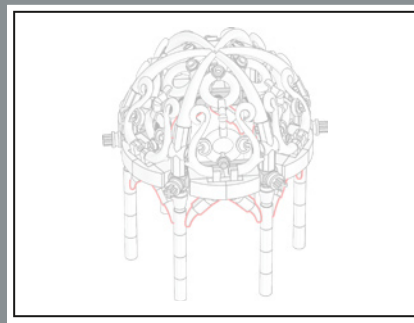

231

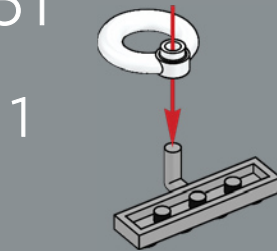

2

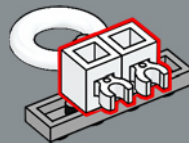

3

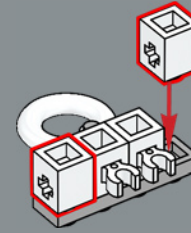

4

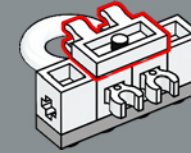

5

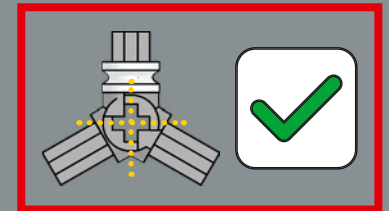
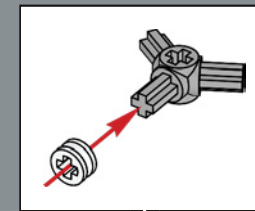
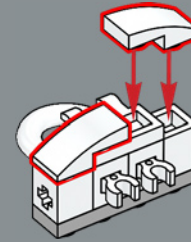

6

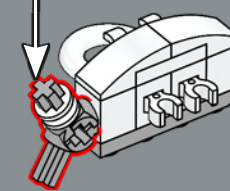

6x



Die Ringe, die das Dach des Pavillons verzieren, dienten 1999 ursprünglich den Minifiguren als Rettungsringe.



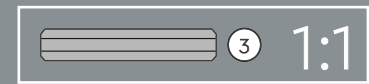
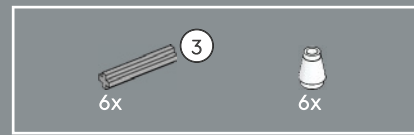
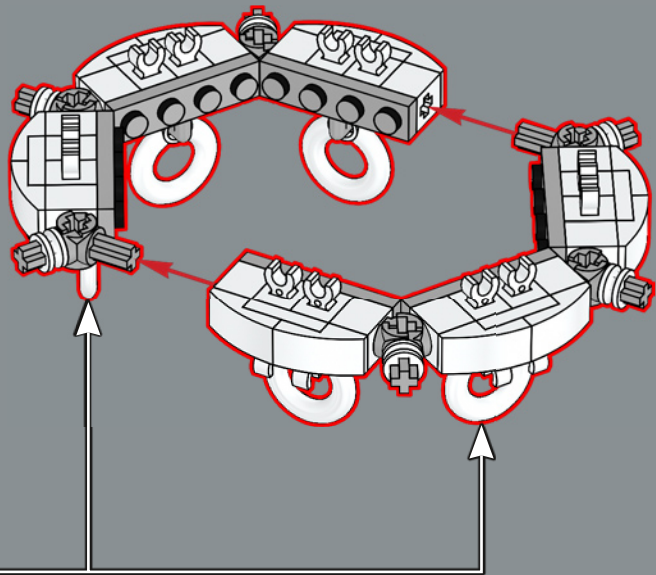

232

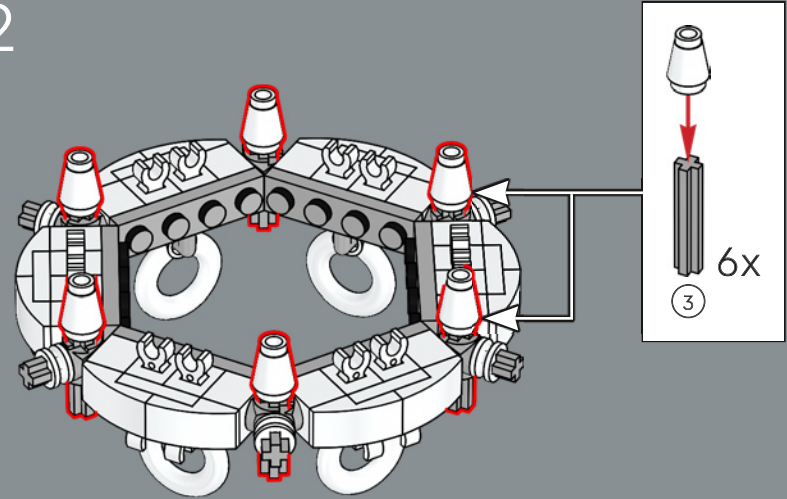

233

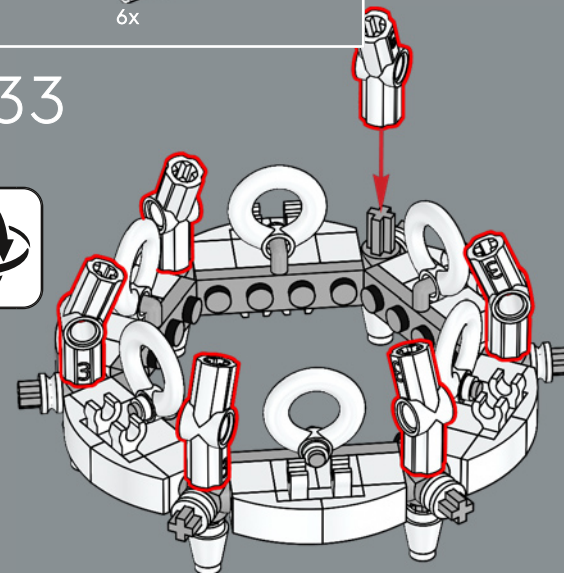

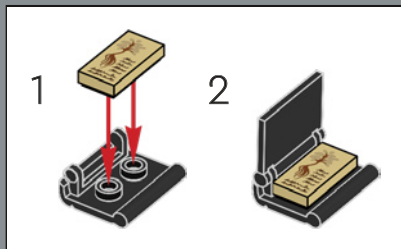
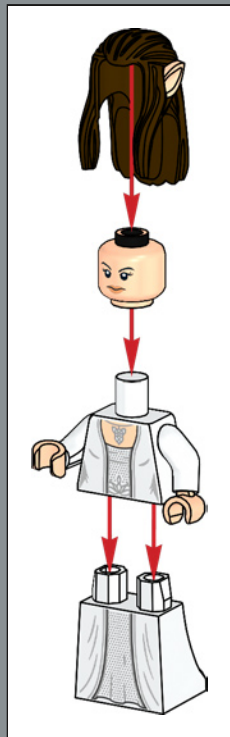

234

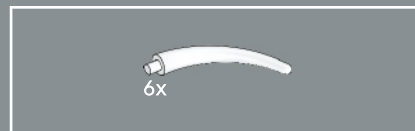
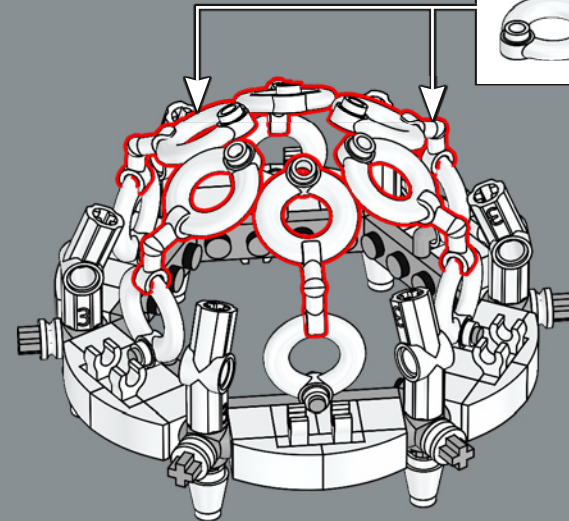
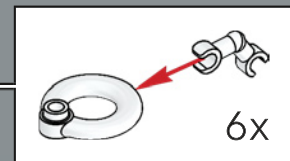

235

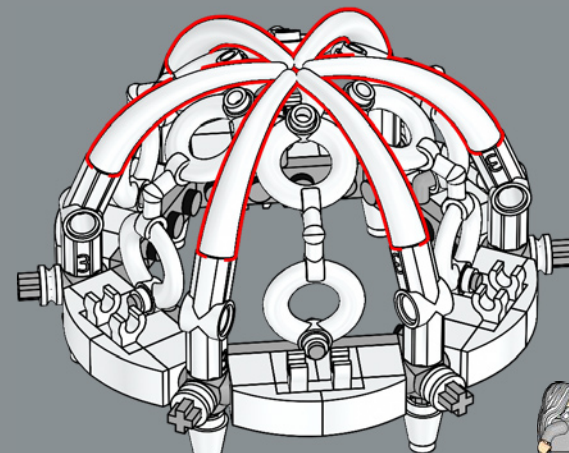



12x

236

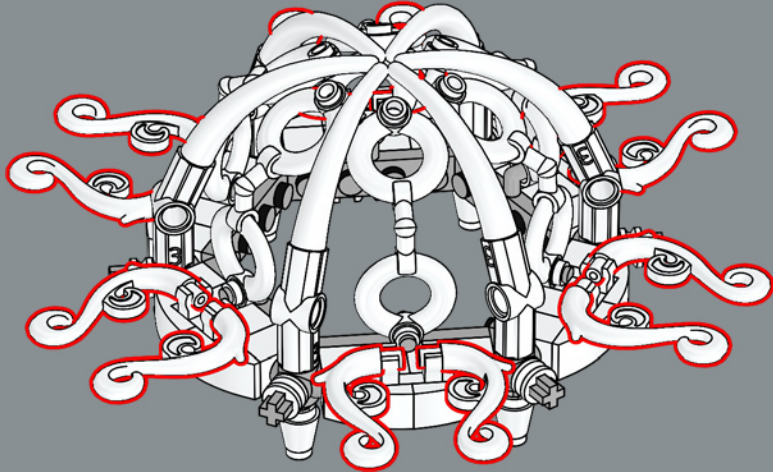

237

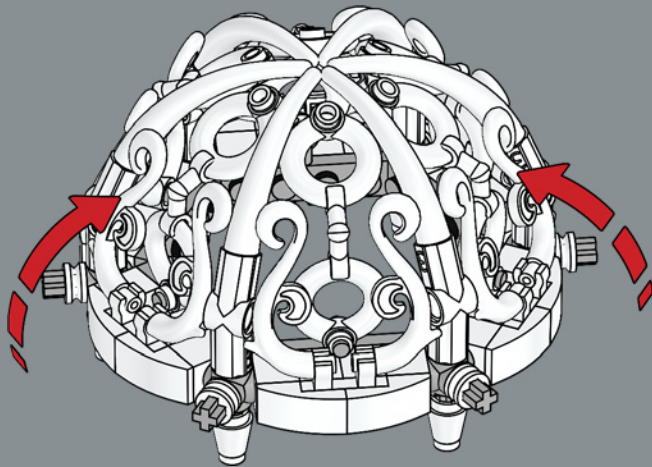

24x

238

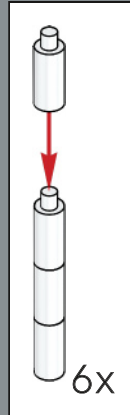
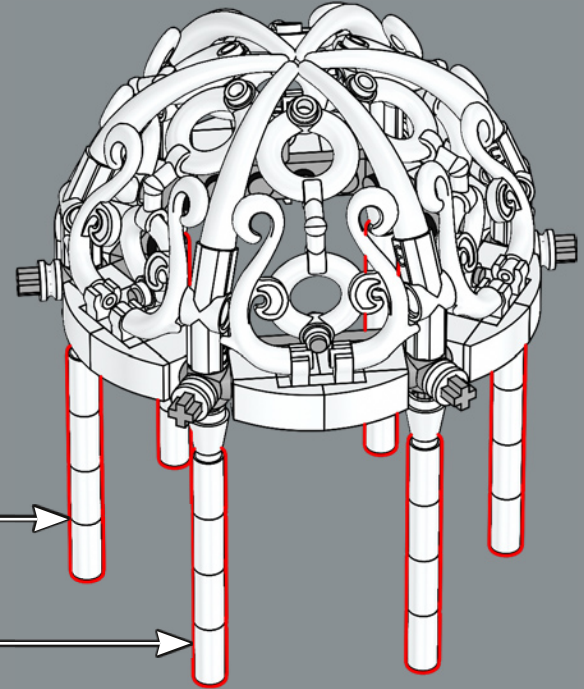

6x



Ursprünglich stellten diese Elemente Kerzen dar.  
91 dieser weißen Teile sind in dem Modell verbaut.  
Allerdings dienen hier nur vier von ihnen als Kerzen.



239

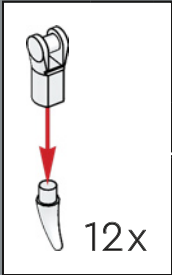
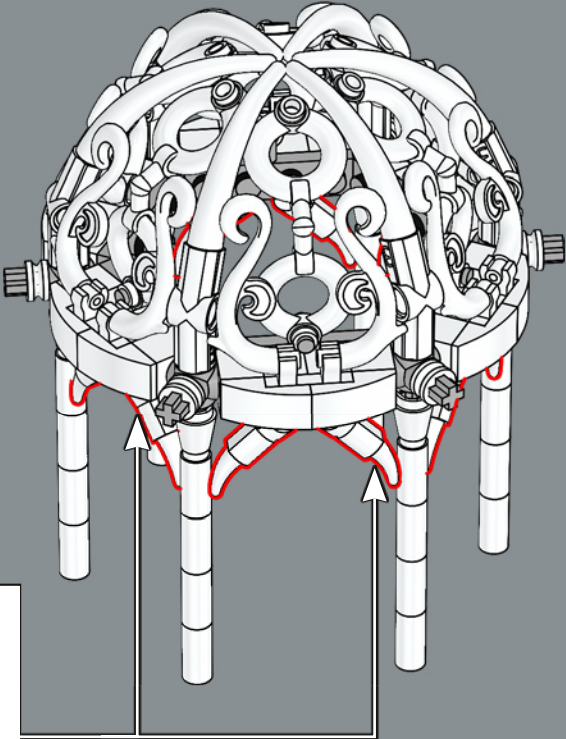

240

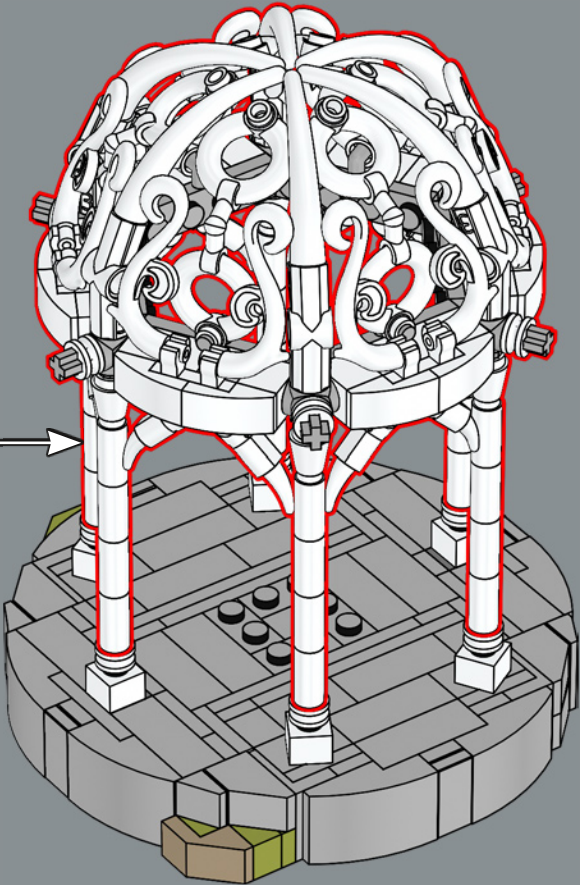

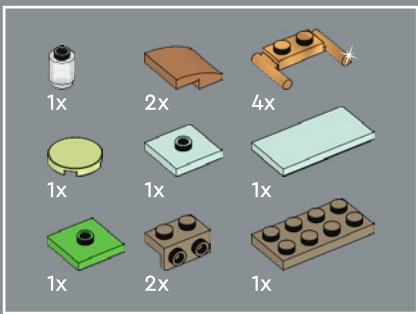

241

1



2

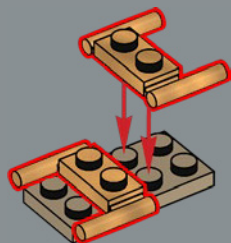

3

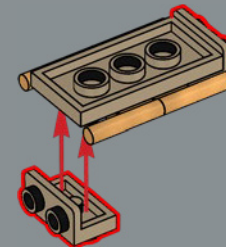

4

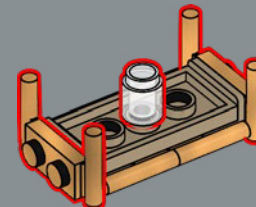

5

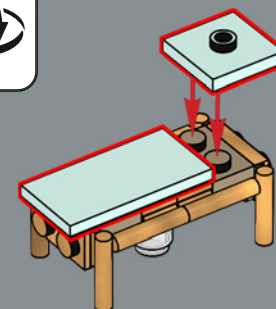



6

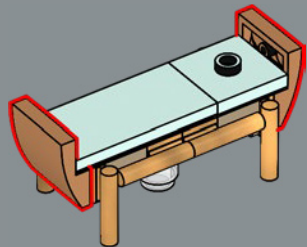

7

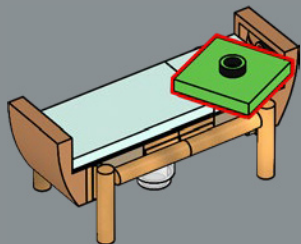

8

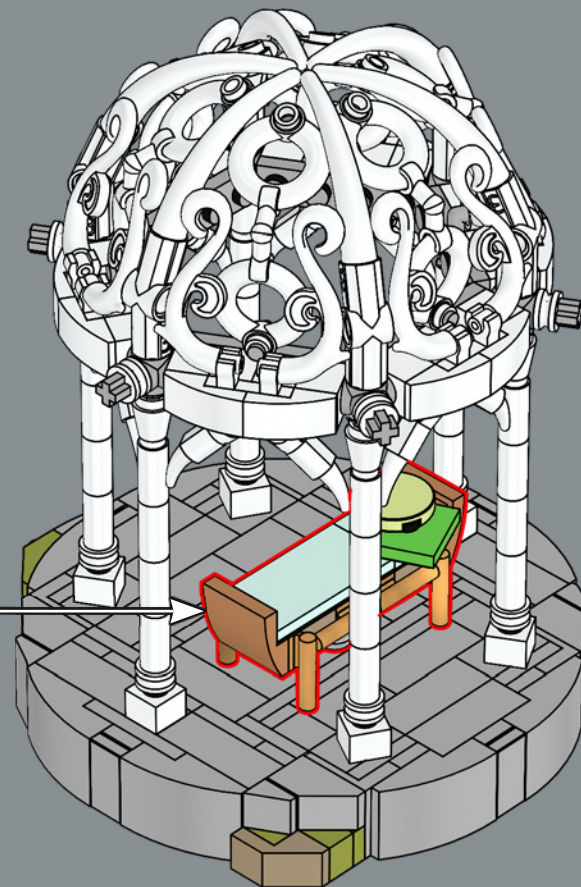
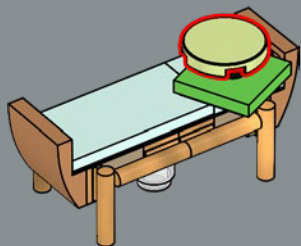

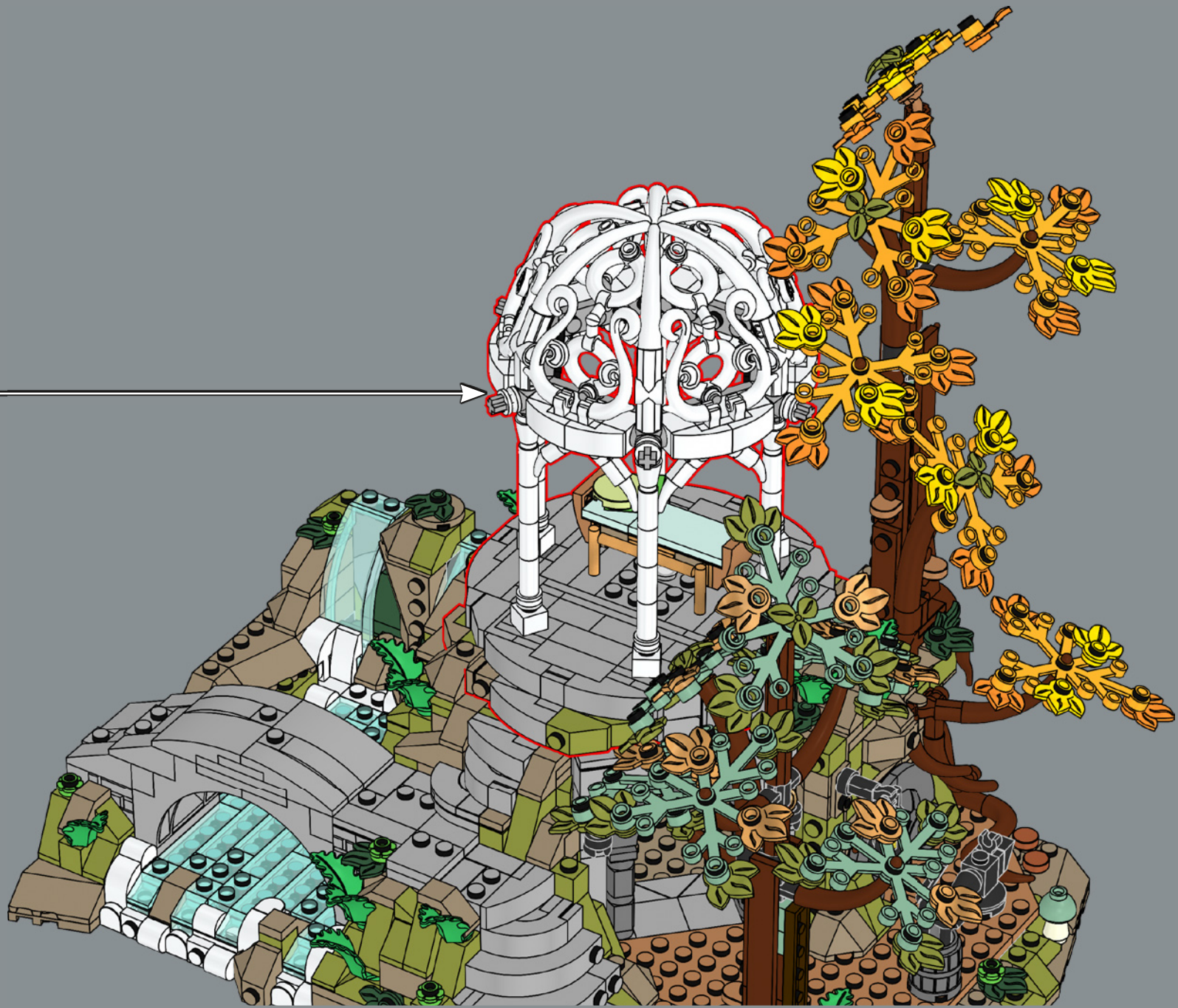

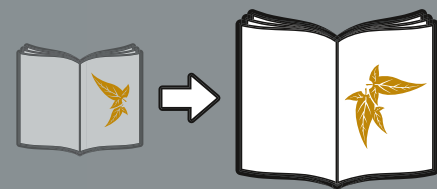



LEGO and the LEGO logo are trademarks of the LEGO Group. ©2023 The LEGO Group.

© 2023 New Line Productions, Inc. All rights reserved. The Lord of the Rings: The Fellowship of the Ring, The Lord of the Rings: The Two Towers, The Lord of the Rings: The Return of the King and the names of the characters, items, events and places therein are trademarks of The Saul Zaentz Company d/b/a Middle-earth Enterprises under license to New Line Productions, Inc. (s23)