

手册 2

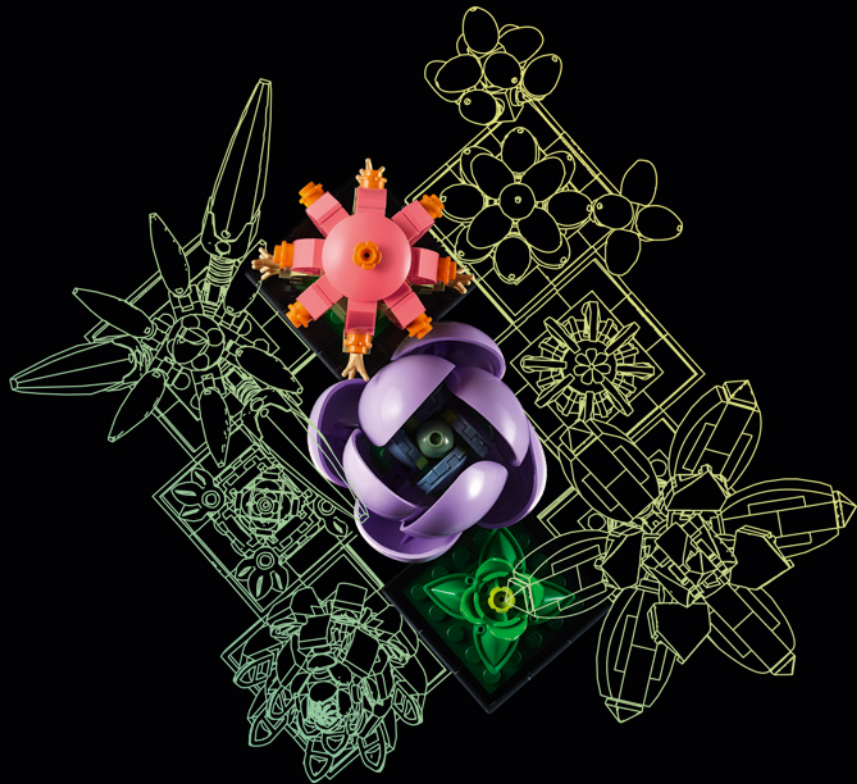

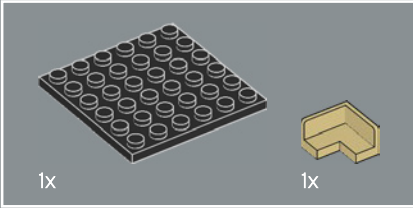

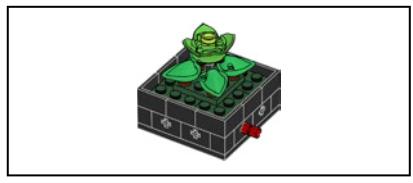

1

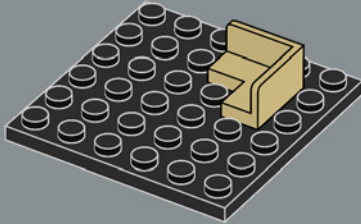

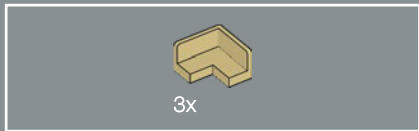

2

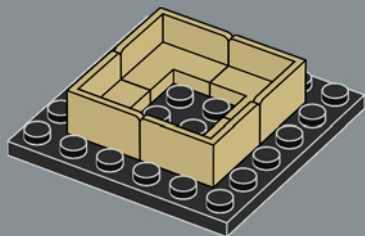

4

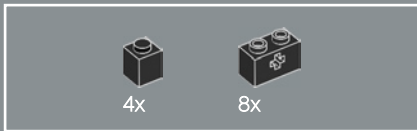

3

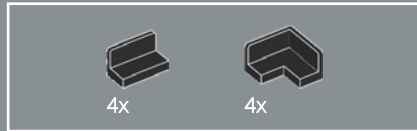
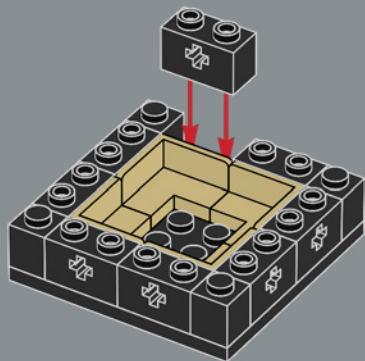

4

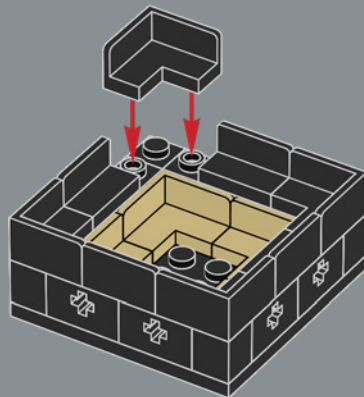

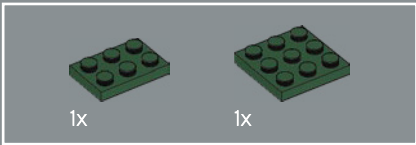

5

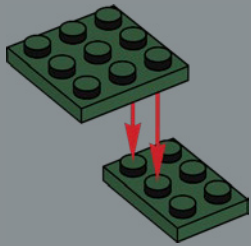

6

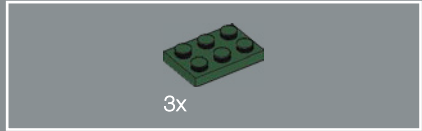

6

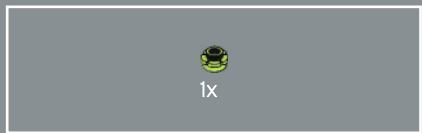
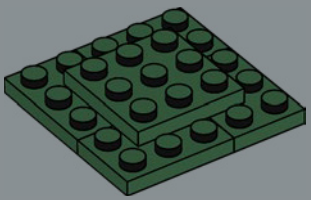

7

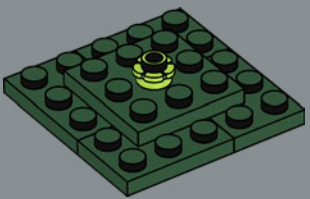

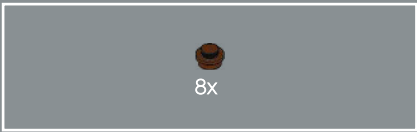

8

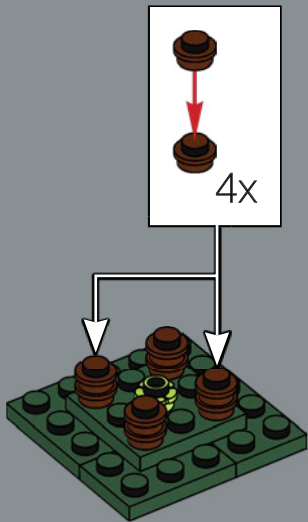

9

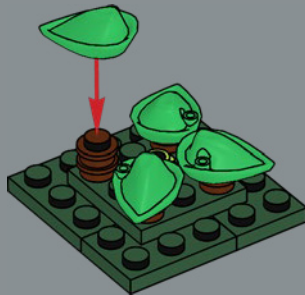



10

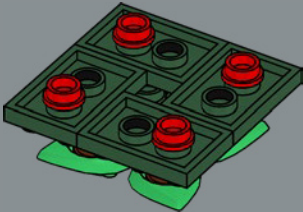

11

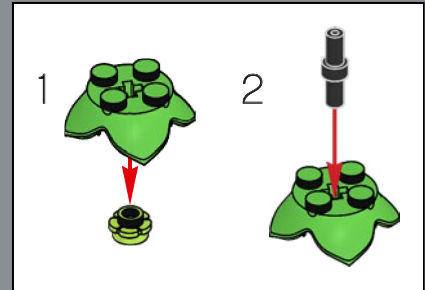

12

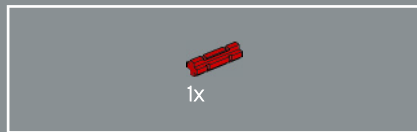
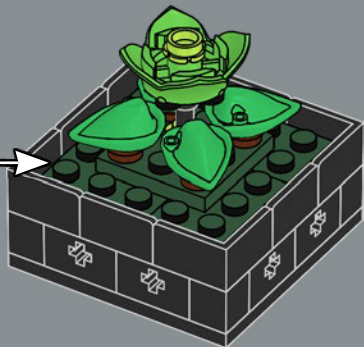

13

你可以种植大约 1 万种肉质植物。这款有趣的乐高®肉质植物是开启你收藏之旅的很好方式。

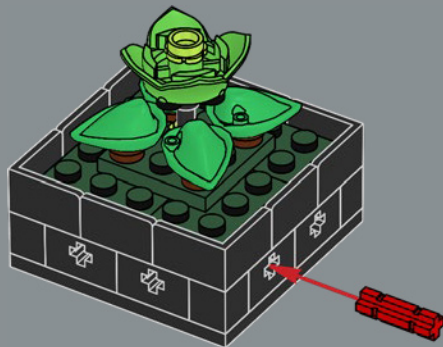

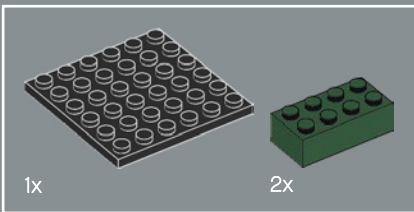
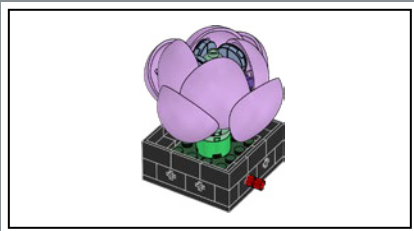

1

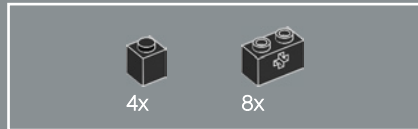
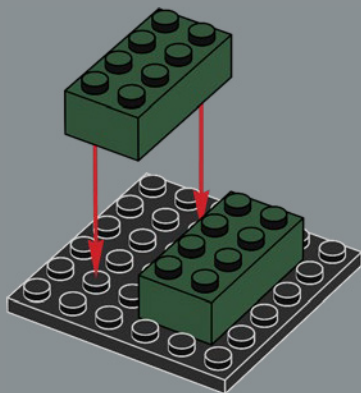

2

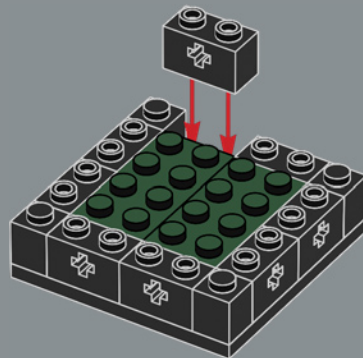

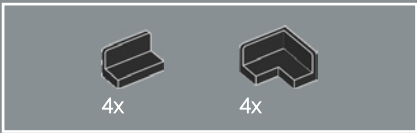

3

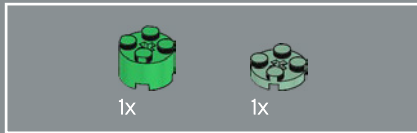
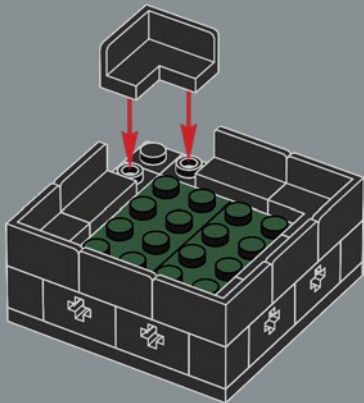

4

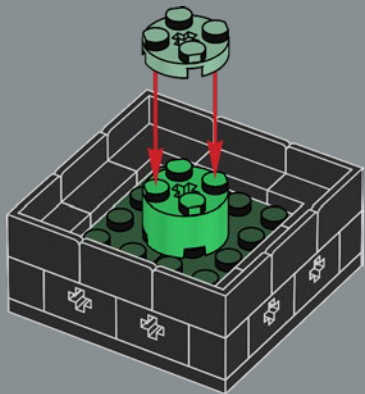

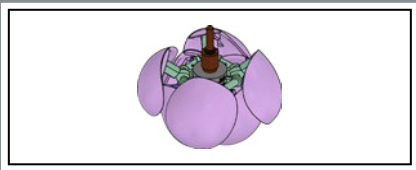

5

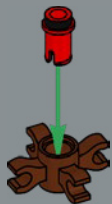

12

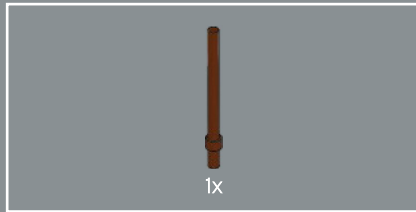

6

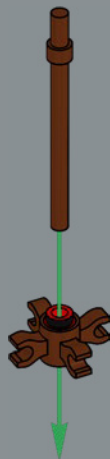



7

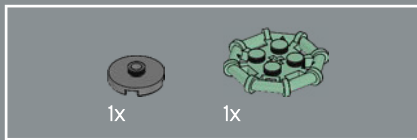

8

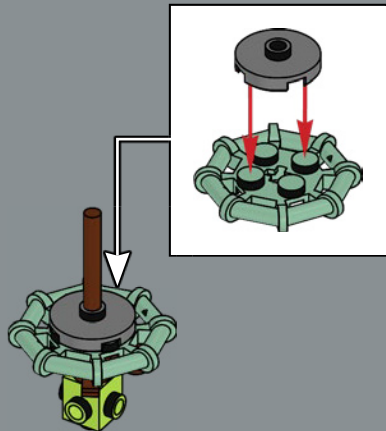



9

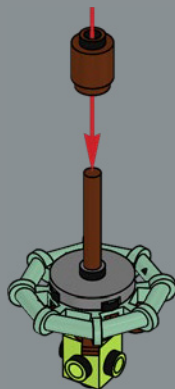

10

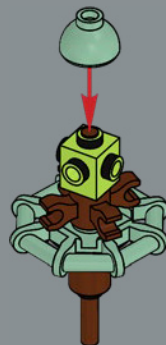

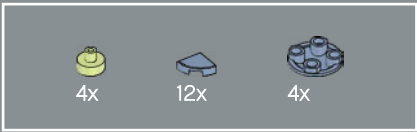

11

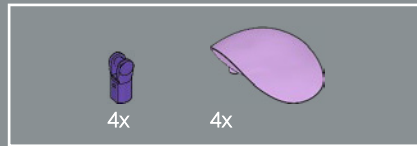
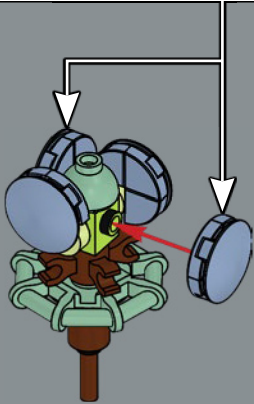
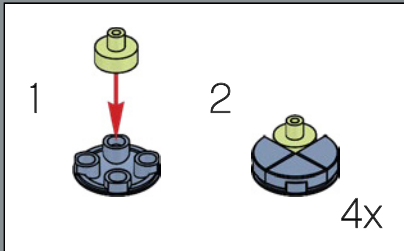

12

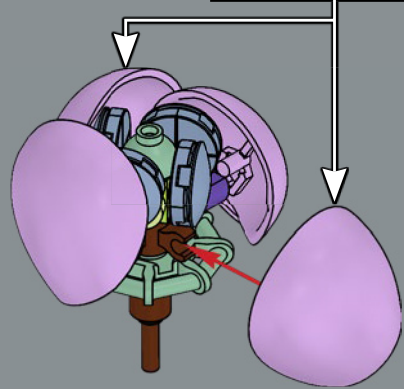
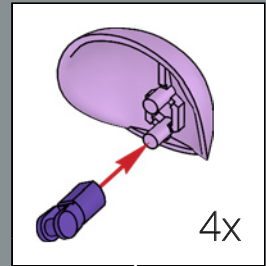

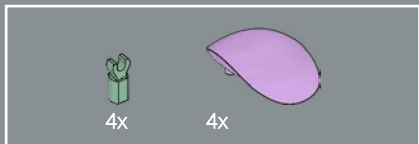

13

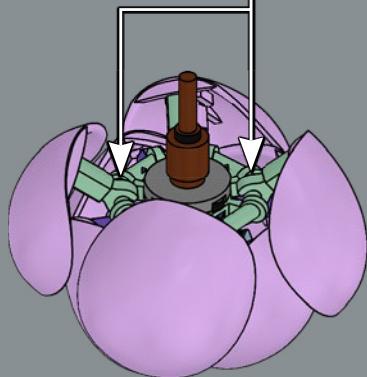
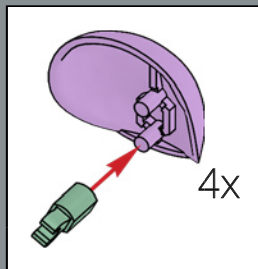

薰衣草特玉莲
拟石莲属薰衣草品种有一些有趣的名称，
如“晚霞”和“霜立方”。你会为你的肉质植
物起什么名字？

14

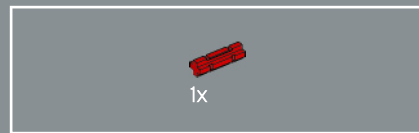
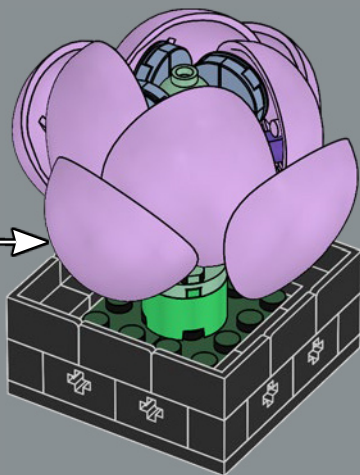

15

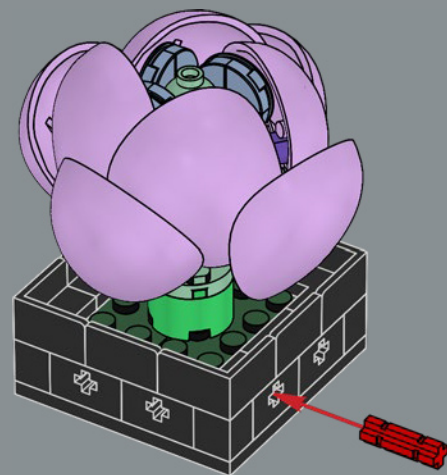

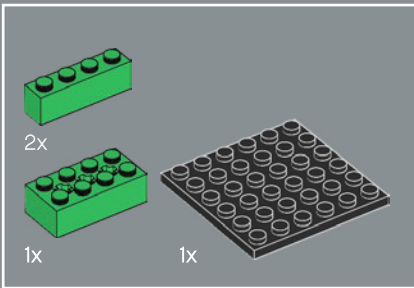
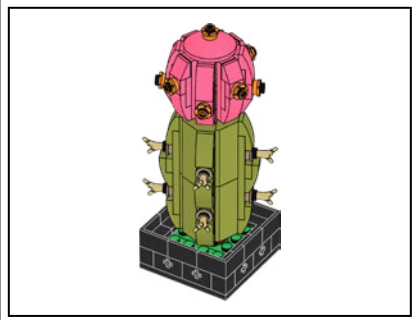

1

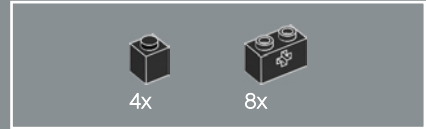
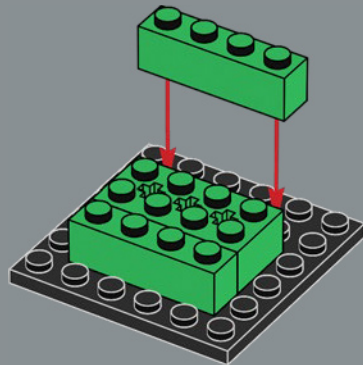

2

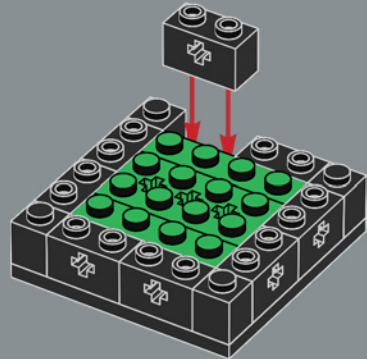

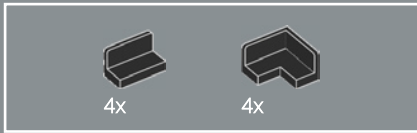

3

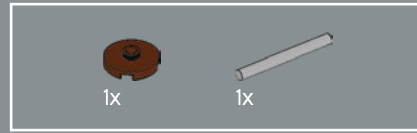
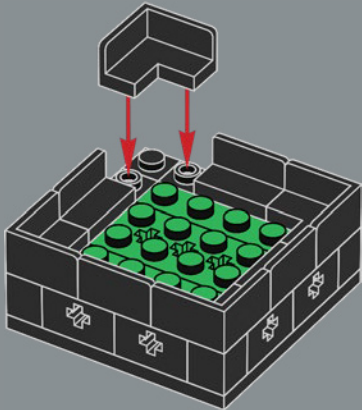

4

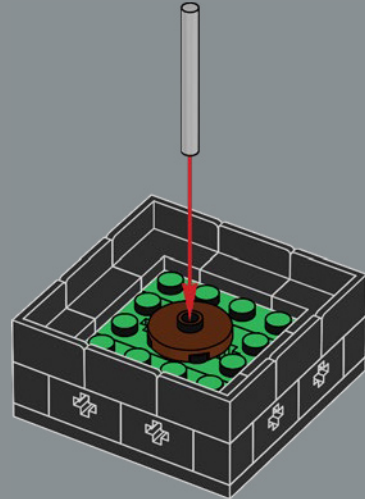

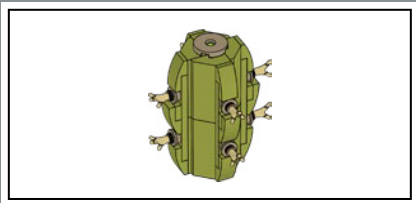

1x

1x

5

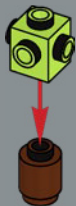

2x

6





7



8



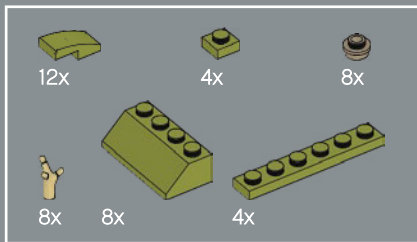
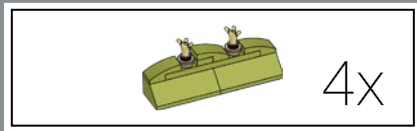

9

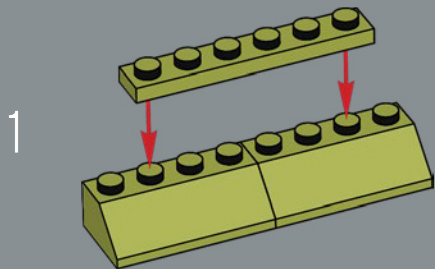

22

2

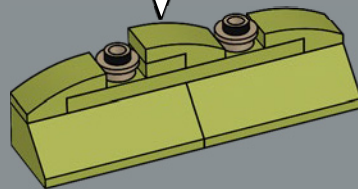

3

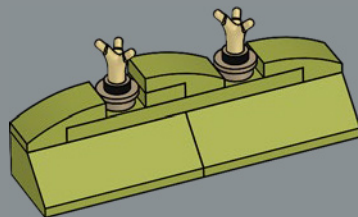

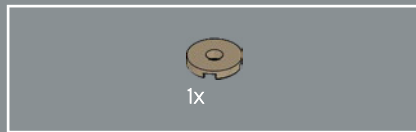
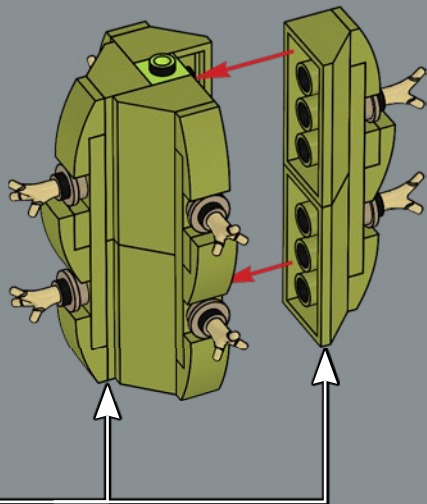

10

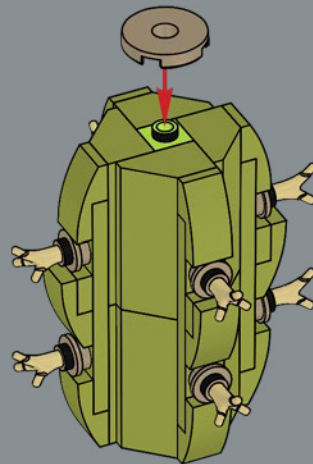

11

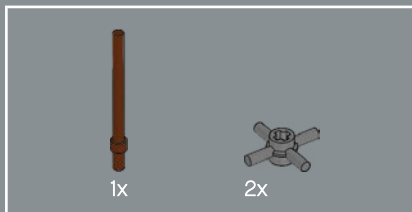
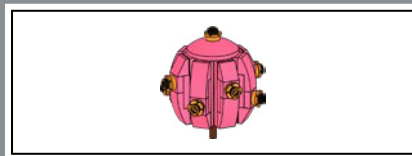
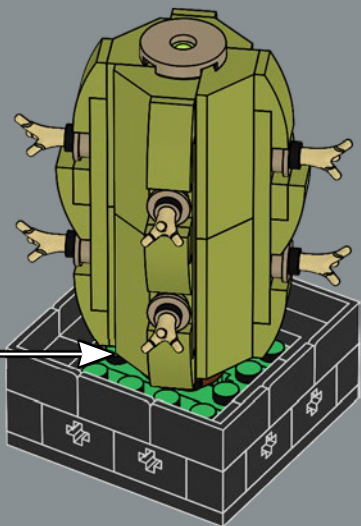

12

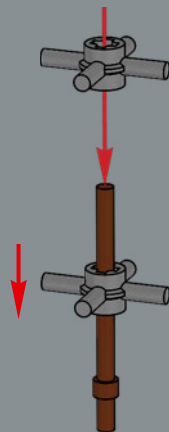

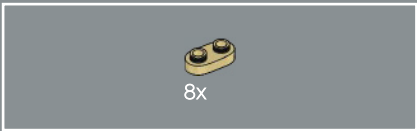

13

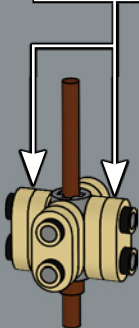
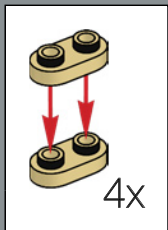

14

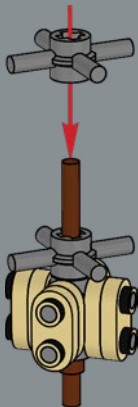



15

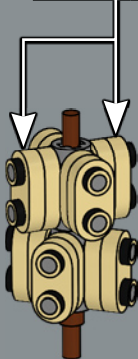
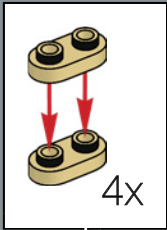

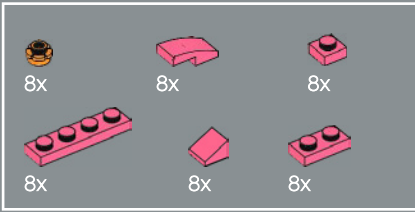

16

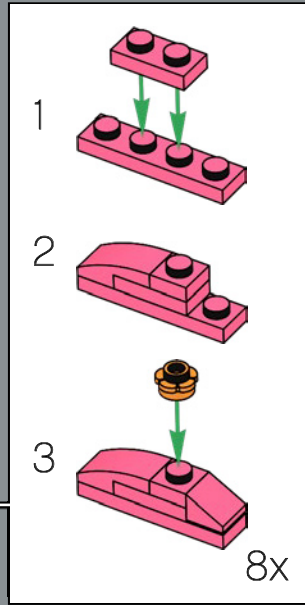
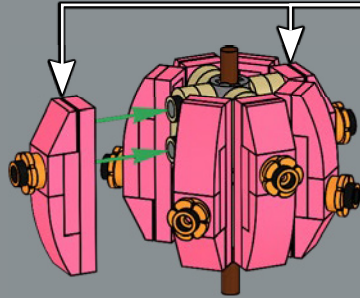



17

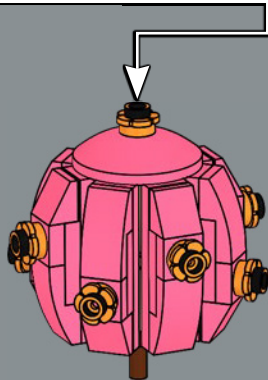
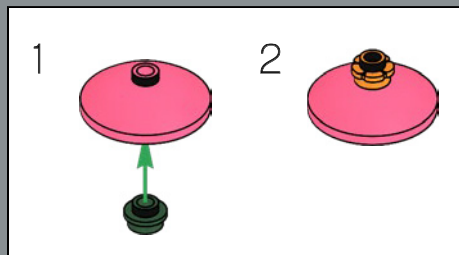

月亮仙人掌 (Moon Cactus)

月亮仙人掌之所以显示红色,是因为它缺乏叶绿素,必须嫁接到其他仙人掌上才能生长。

18

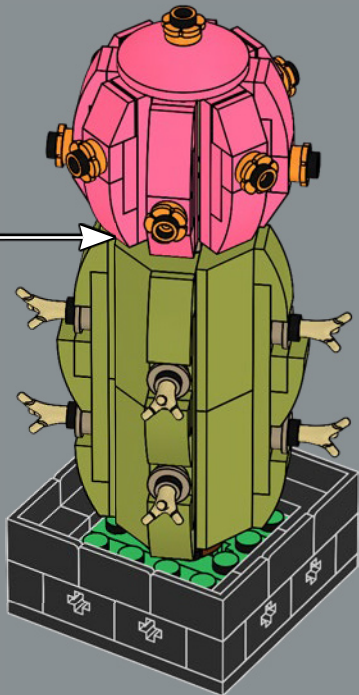

19

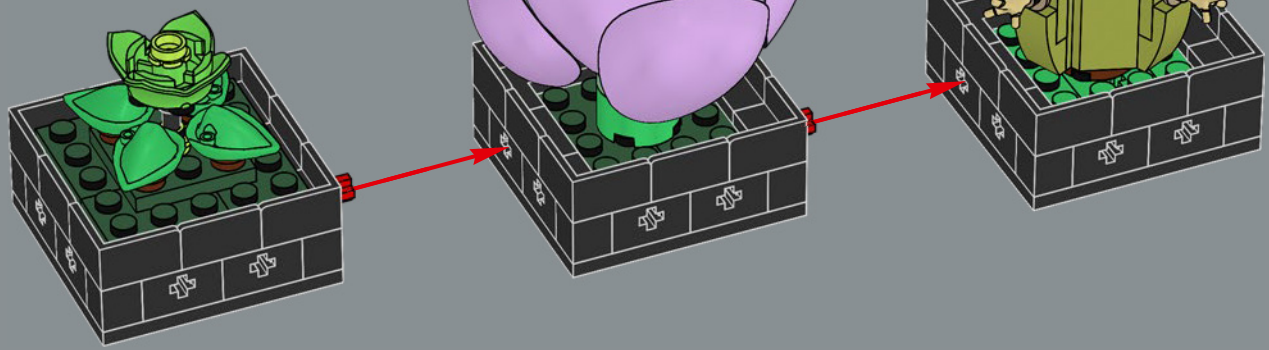



2x

20

