



Booklet available in English on  
Livret disponible en français sur  
Folleto disponible en español en

[LEGO.com/service/buildinginstructions](https://www.LEGO.com/service/buildinginstructions)



## THE ART OF THE BONSAI/L'ART DU BONSAÏ/EL ARTE DEL BONSAÍ

● The art of growing miniature trees in decorative pots originated in China over 2000 years ago. This LEGO® variety is much more modern, but the process and outcome is the same: you assemble, plant and prune your LEGO Bonsai, then watch as it grows into a beautiful creation you can be proud of for yourself and share with others. Enjoy!

● L'art de cultiver des arbres miniatures dans des pots décoratifs a vu le jour en Chine il y a plus de 2 000 ans. Cette variété LEGO® est beaucoup plus moderne, mais le processus et le résultat sont les mêmes : assemblez, plantez et taillez votre bonsaï LEGO, puis admirez sa transformation en une magnifique création que vous pourrez partager avec fierté. Profitez-en !

● El arte de cultivar árboles en miniatura en macetas decorativas surgió en China hace más de 2000 años. Esta variedad LEGO® es mucho más moderna, pero el proceso y el resultado son los mismos: ensambles, plantas y podas tu bonsái LEGO, y luego ves cómo crece hasta convertirse en una hermosa creación de la que puedes sentirte orgulloso y que puedes compartir con los demás. ¡Que lo disfrutes!





LEGO® Designer Nicolaas Vás  
Le concepteur LEGO® Nicolaas Vás  
Nicolaas Vás, diseñador de LEGO®

## THE LEGO® BONSAI MASTER/LE MAÎTRE DU BONSAI LEGO/EL MAESTRO DEL BONSAI LEGO

● Growing up in New Zealand, LEGO® Designer Nicolaas Vás always loved trees and plants but admits to being pretty bad at looking after them. Luckily, he's much better at creating beautiful horticulture from LEGO elements. His first LEGO Bonsai tree was created as part of his work with the LEGO NINJAGO® series, and since then he's become the Bonsai specialist within the LEGO design team.

● Ayant grandi en Nouvelle-Zélande, le concepteur LEGO® Nicolaas Vás a toujours apprécié les arbres et les plantes, mais admet ne pas être très doué pour s'en occuper. Heureusement, il n'a aucun mal à créer une magnifique horticulture à partir d'éléments LEGO. Il a créé son premier bonsaï LEGO dans le cadre de son travail sur la série LEGO NINJAGO®, et il est depuis devenu le spécialiste des bonsaïs au sein de l'équipe de conception LEGO.

● Durante su infancia en Nueva Zelanda, el diseñador de LEGO® Nicolaas Vás aprendió a amar los árboles y las plantas, aunque admite que no es muy bueno cuidándolos. Afortunadamente, es mucho mejor cuando se trata de crear hermosas obras de horticultura a partir de elementos LEGO. Creó su primer bonsaï LEGO mientras trabajaba en la serie LEGO NINJAGO® y hoy es el especialista en bonsaïs del equipo de diseño de LEGO.

## ONE TREE, TWO VARIETIES/UN ARBRE, DEUX VARIÉTÉS/ UN ÁRBOL, DOS VARIEDADES

● The biggest challenge for Nico was deciding which two leaf variations to include for you to build. The first variety is the more traditional Bonsai tree where the foliage ranges from bright to dark green, with the juvenile buds being darker in color. The second tree is inspired by a Japanese Cherry Tree and is much more colorful with striking light purple blossoms. Both options are full of character and capture the wonder and beauty of a real Bonsai.

● Le plus grand défi pour Nico a été de choisir les deux variantes de feuillage à inclure dans cet ensemble. La première variété est le bonsaï plus traditionnel dont le feuillage varie du vert vif au vert foncé, avec des bourgeons de couleur plus foncée. Le deuxième bonsaï est inspiré du cerisier japonais et est beaucoup plus coloré, avec des fleurs d'une couleur mauve clair éclatante. Les deux options ont beaucoup de caractère et rendent parfaitement la magie et la beauté d'un vrai bonsaï.

● Para Nico, lo más difícil fue decidir qué par de variedades de hojas incluir para que construyeras. La primera variedad corresponde a un bonsái tradicional cuyas ramas oscilan entre el verde intenso y el verde oscuro, con brotes juveniles de color más apagado. La segunda se inspira en un cerezo japonés y es mucho más colorida, pues incluye impresionantes flores púrpura claro. Ambas opciones tienen un fuerte carácter y capturan la maravilla y la belleza de un verdadero bonsái.

*LEGO® Bonsai trees are surprisingly robust and thrive in indoor environments. Be sure to dust occasionally and your Bonsai tree will continue to remain healthy and beautiful for many years to come!*

*Les bonsaïs LEGO® sont étonnamment robustes et s'épanouissent dans les environnements intérieurs. Assurez-vous de dépoussiérer votre bonsaï de temps en temps et il restera beau et en santé pour de longues années !*

*Los bonsáis LEGO® son sorprendentemente robustos y se integran perfectamente en ambientes interiores. ¡Solo asegúrate de limpiarle el polvo de vez en cuando y tu bonsái lucirá sano y hermoso por muchos años!*



## PLANTS FROM PLANTS/DES PLANTES FABRIQUÉES AVEC DES PLANTES/ PLANTAS CON PLANTAS

● The LEGO Group is working to build a more sustainable future for children. Currently more than 80 LEGO® elements including trees, leaves and bushes are made from a plant-based plastic, produced using sustainably sourced sugarcane, Plants from Plants! These elements represent the first steps of a bigger mission to make LEGO bricks from sustainable sources by 2030.

● Le Groupe LEGO s'emploie à bâtir un avenir plus durable pour les enfants. À l'heure actuelle, plus de 80 éléments LEGO®, dont des arbres, des feuilles et des buissons, sont fabriqués à partir de plastique végétal fait à base de canne à sucre de sources durables ; des plantes fabriquées avec des plantes ! Ces éléments constituent la première étape d'une mission bien plus considérable visant à fabriquer des briques LEGO issues de sources durables d'ici 2030.

● The LEGO Group está trabajando en la construcción de un futuro más sustentable para los niños. En la actualidad, más de 80 elementos LEGO® (como árboles, hojas y arbustos) se fabrican a partir de plástico de origen vegetal producido con caña de azúcar proveniente de fuentes sustentables, lo que da nombre a nuestra iniciativa: Plantas con Plantas. Estos elementos representan los primeros pasos de una misión de mayor envergadura cuyo objetivo es que los bricks LEGO se fabriquen a partir de fuentes sustentables antes de 2030.



● Plants from Plants elements in this set:

● Les éléments fabriqués avec des plantes dans cet ensemble :

● Elementos pertenecientes a la iniciativa Plantas con Plantas que contiene este set:

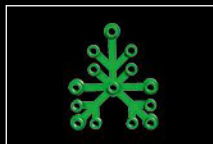

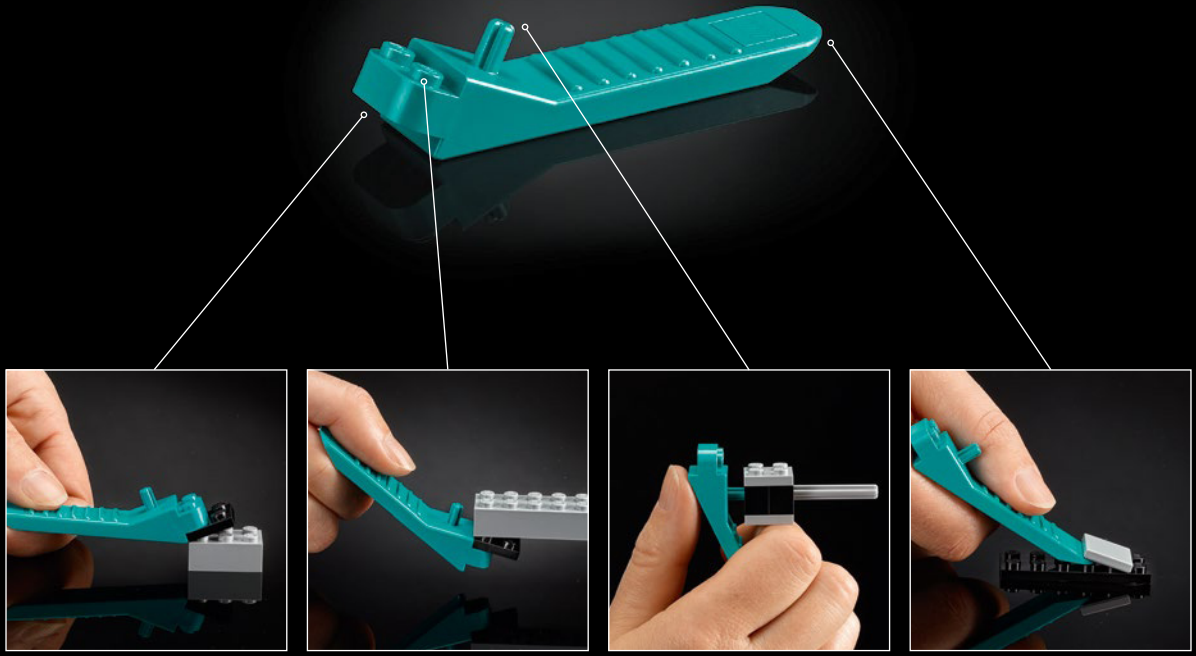

[LEGO.com/brickseparator](https://www.lego.com/brickseparator)

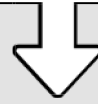



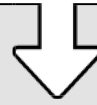
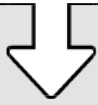

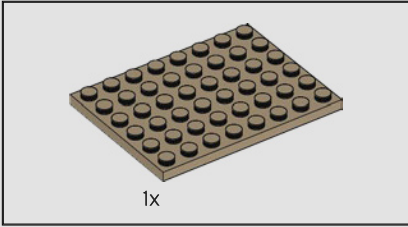
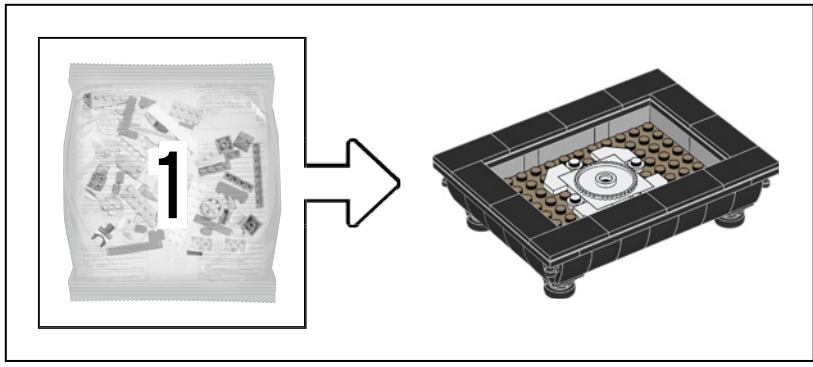

1

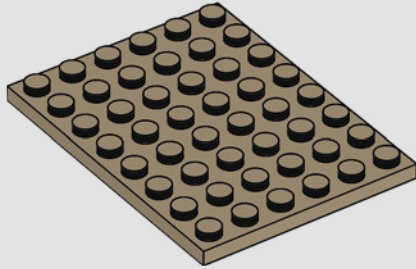

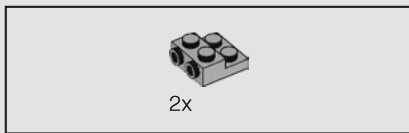

2

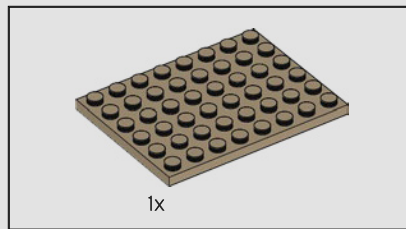
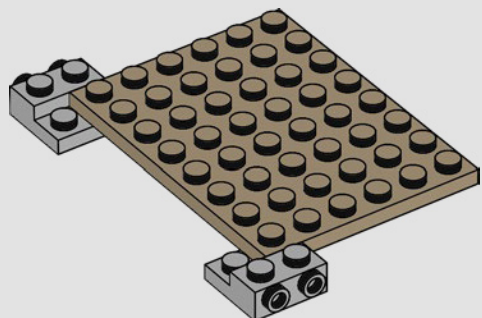

3

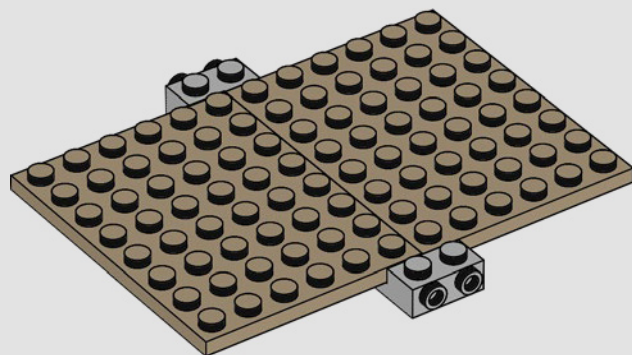

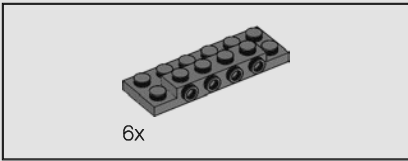

4

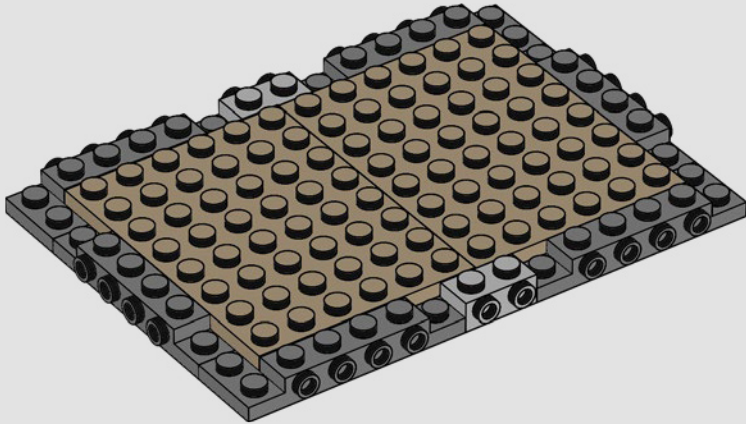

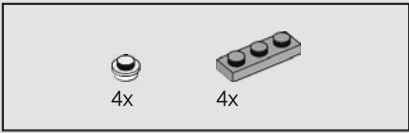

5

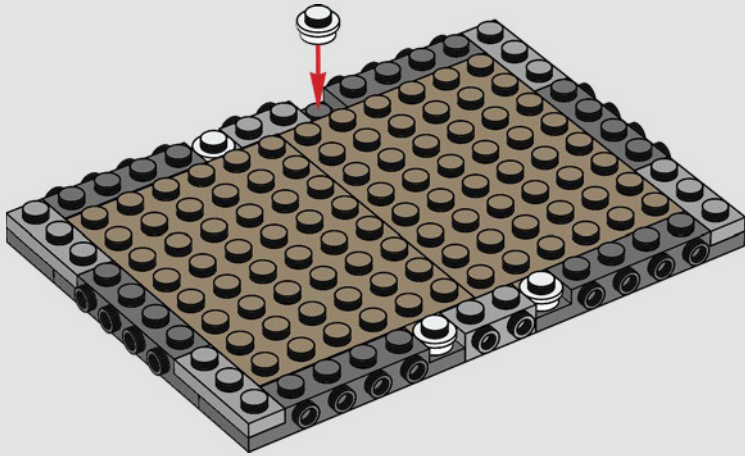

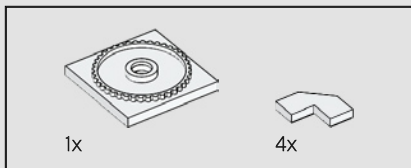

6

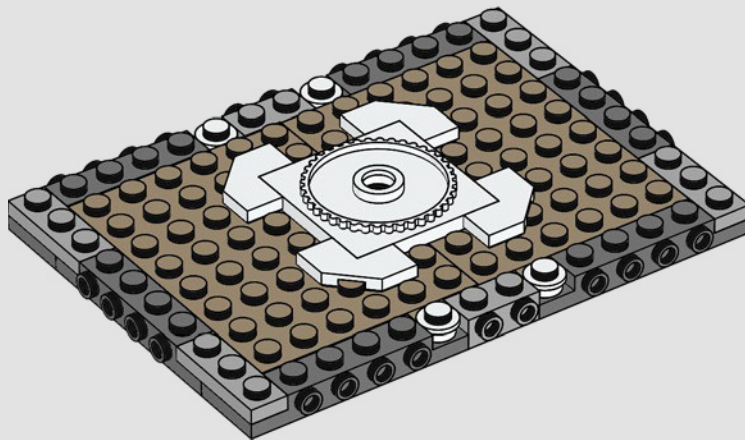



4x

7

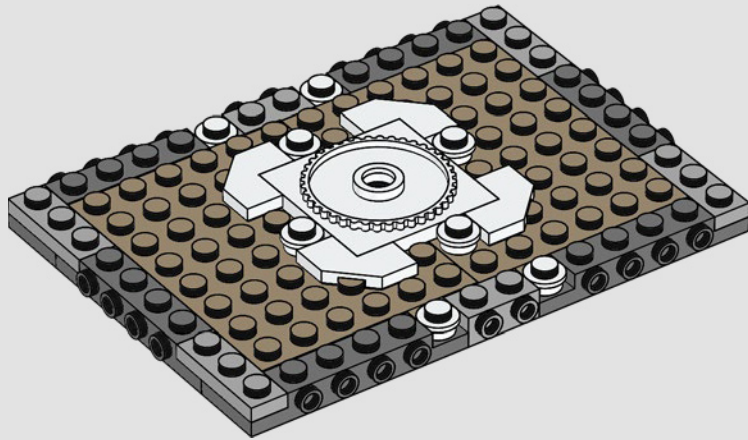

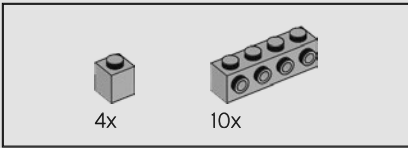

8

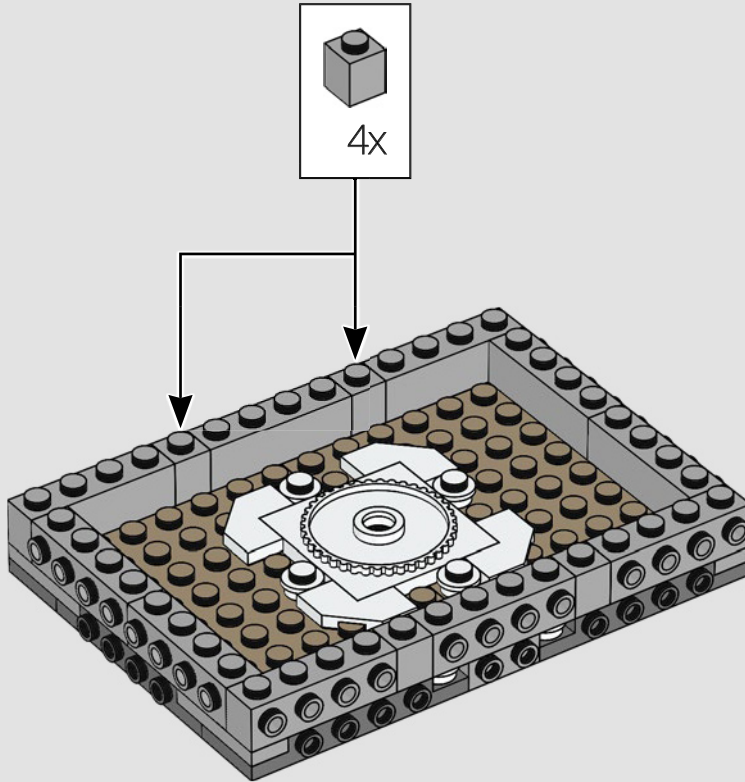



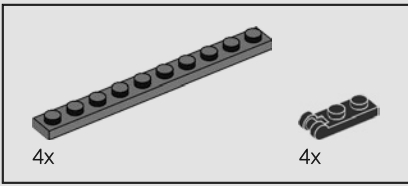

9

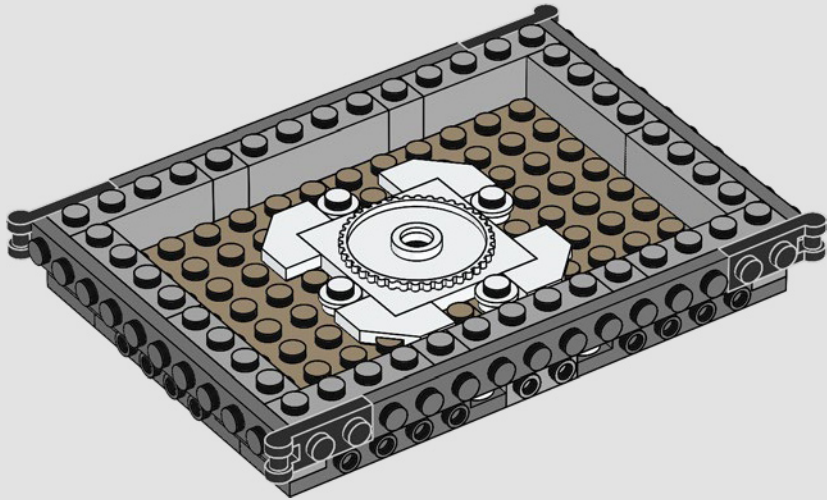



24x

10

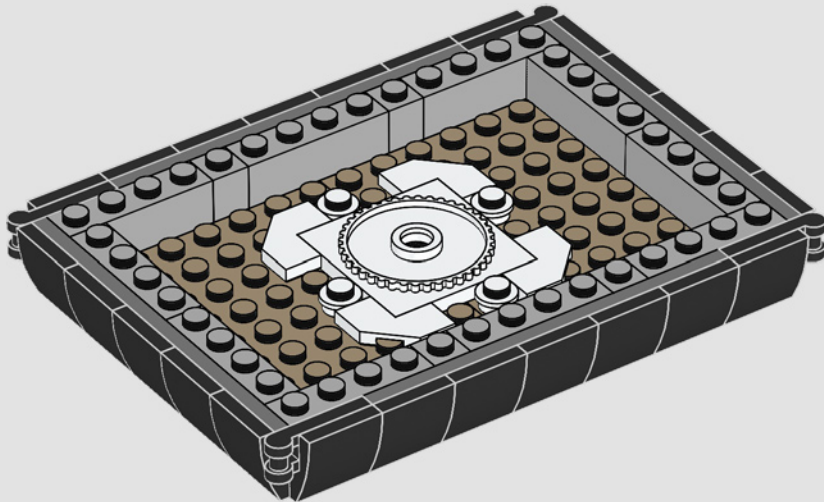

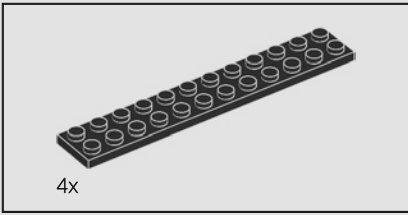

11

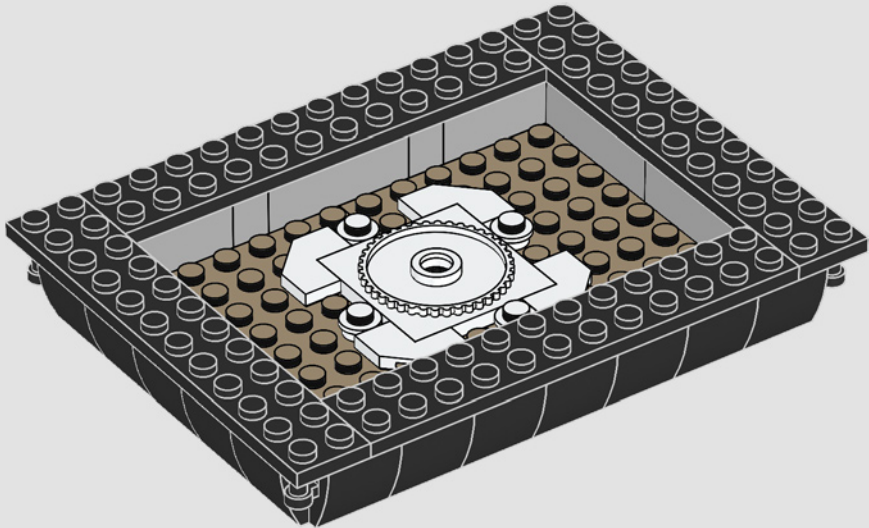

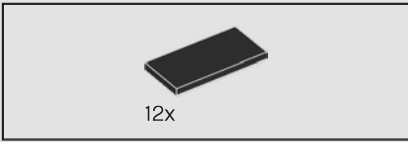

12

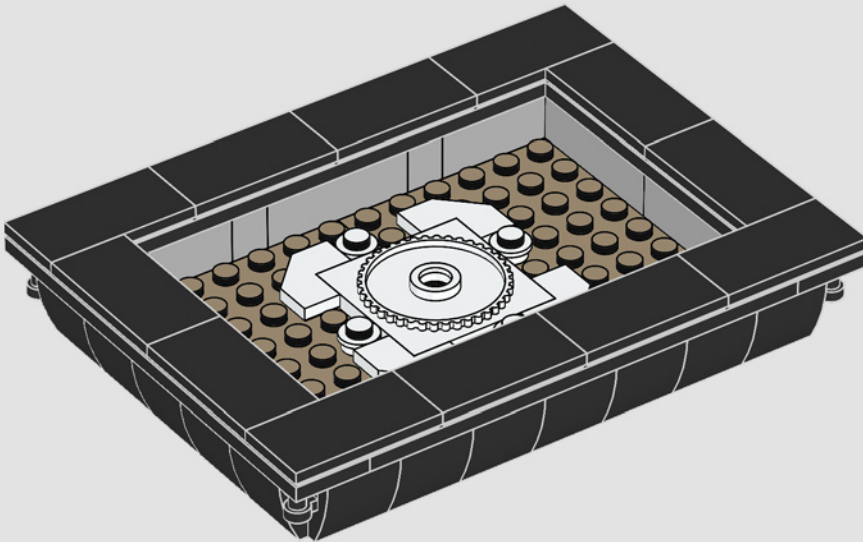

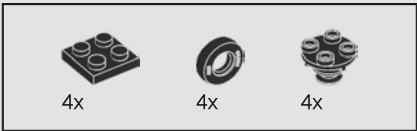

13

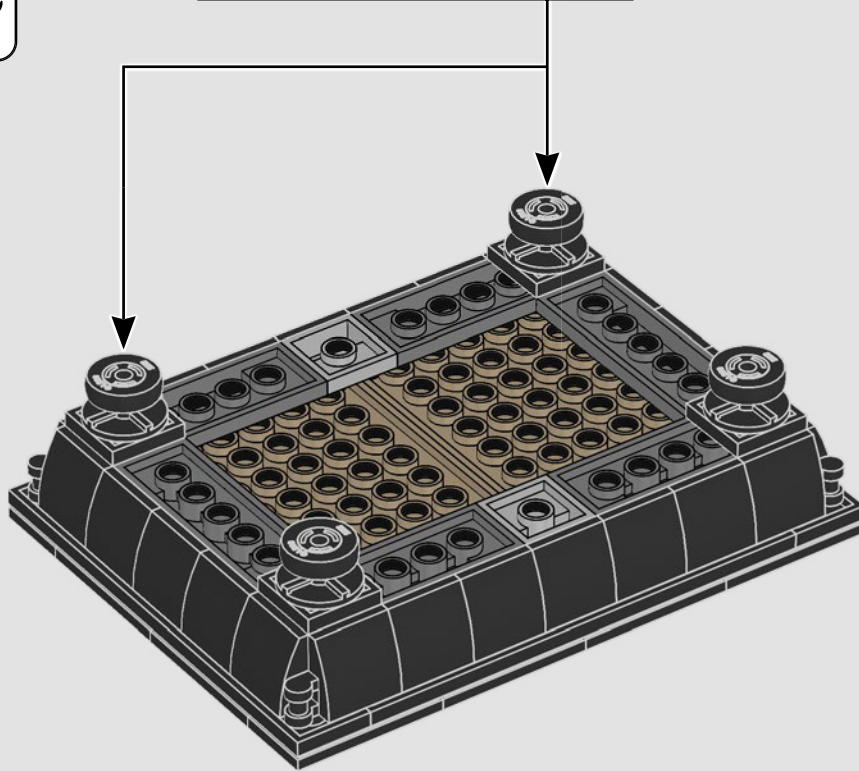
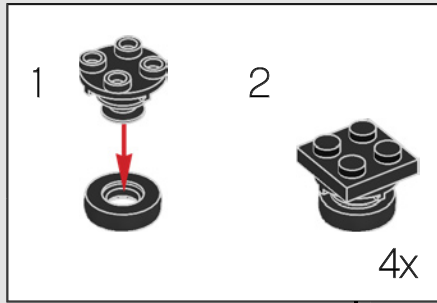

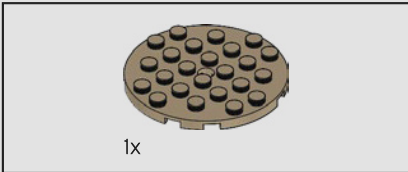
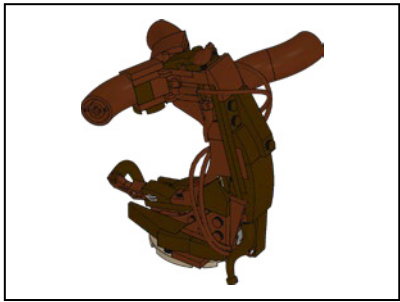
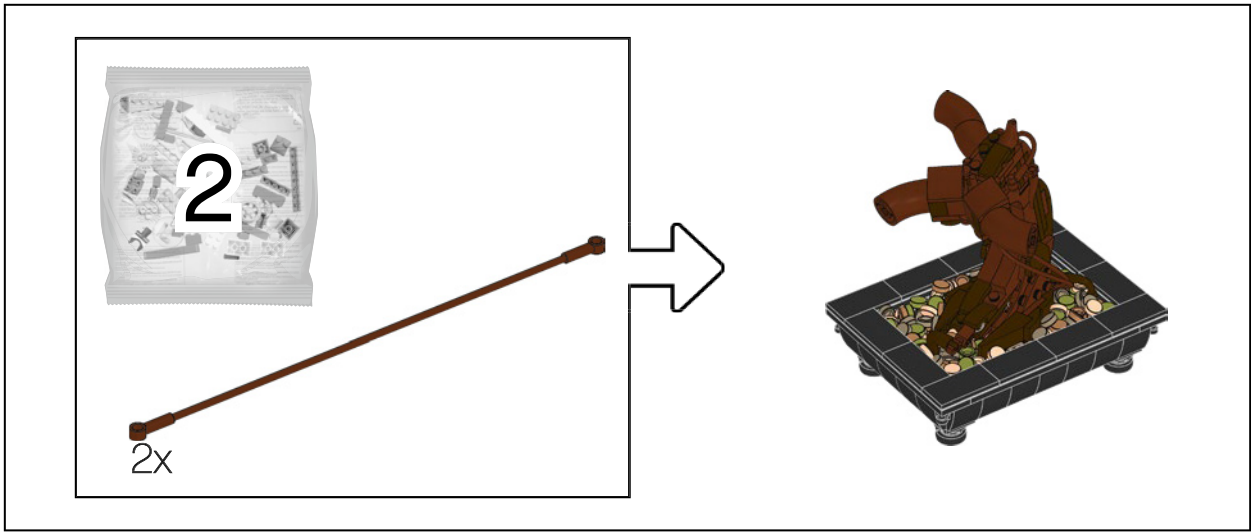

14

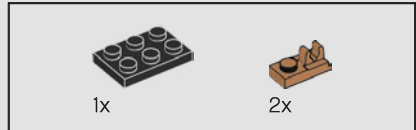
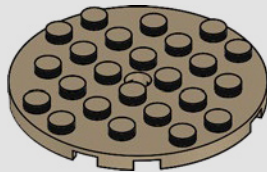

15

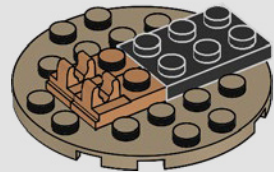



16

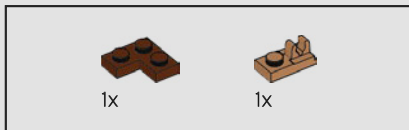
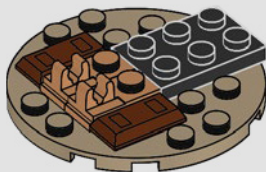

17

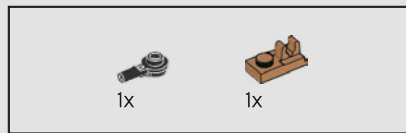
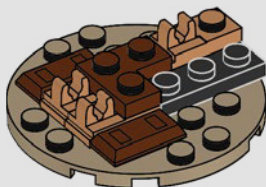

18

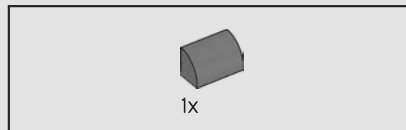
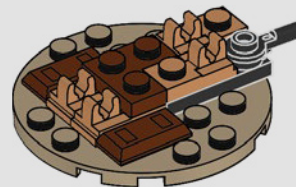

19

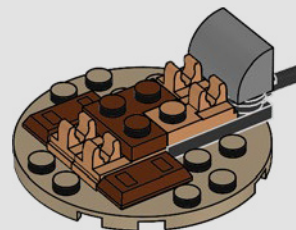

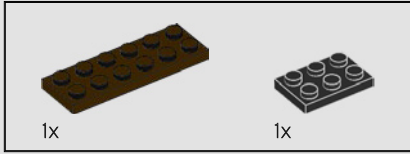
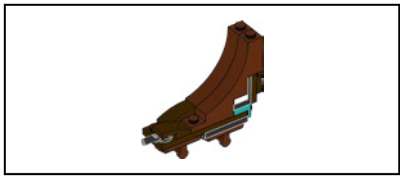

20

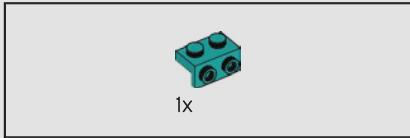
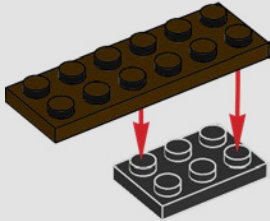

21

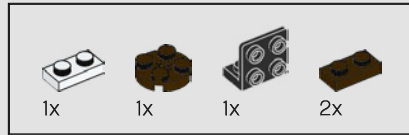
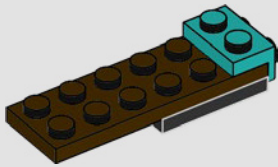

22

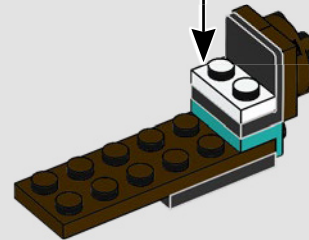
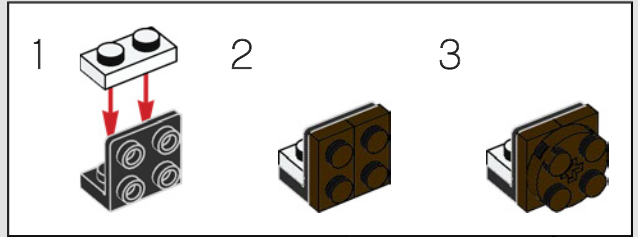



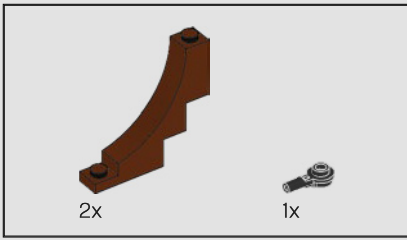

23

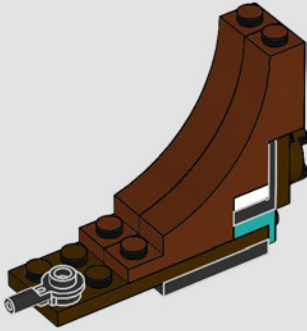

24

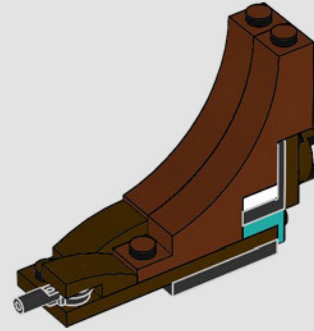



25

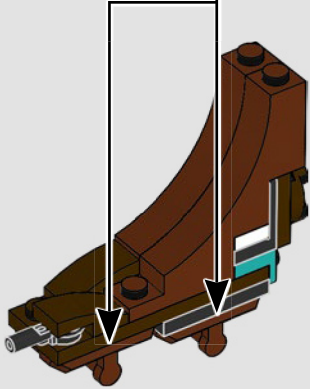
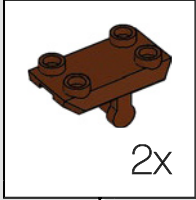

26

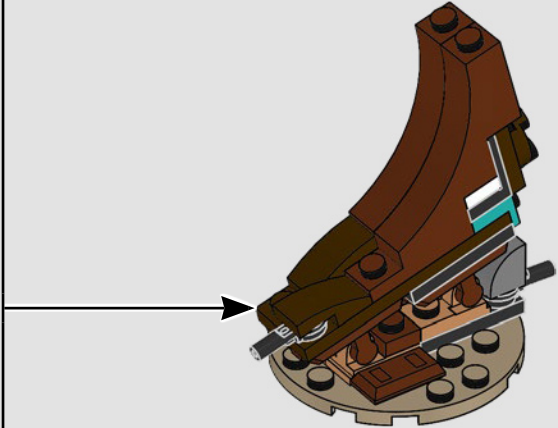

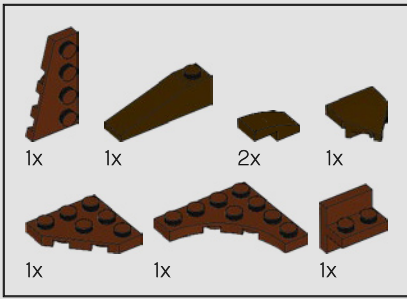

27

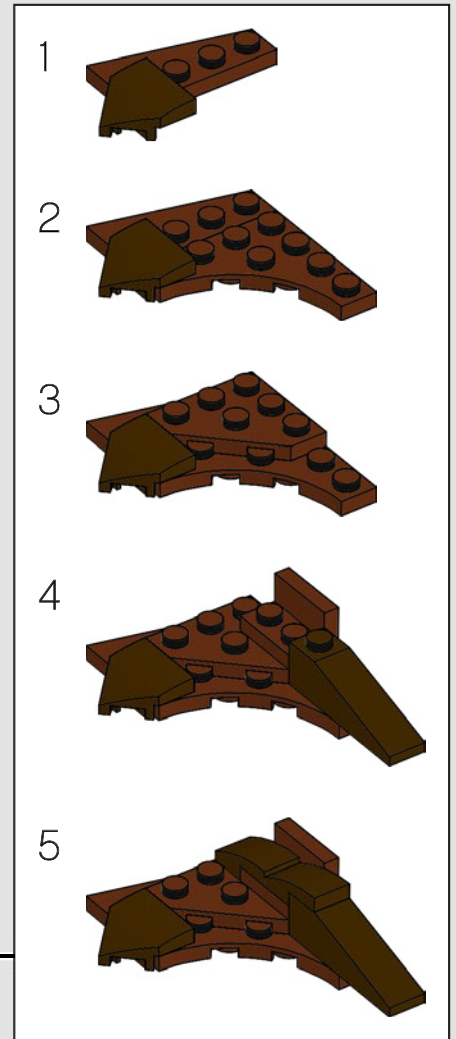
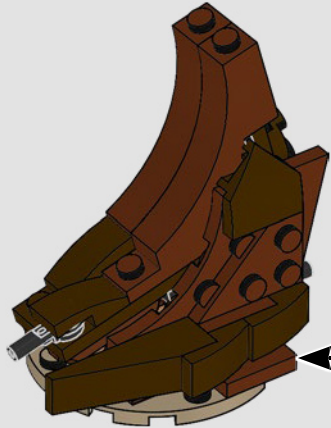

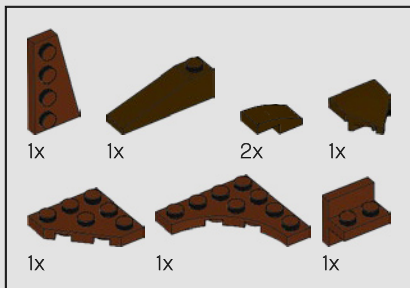

28

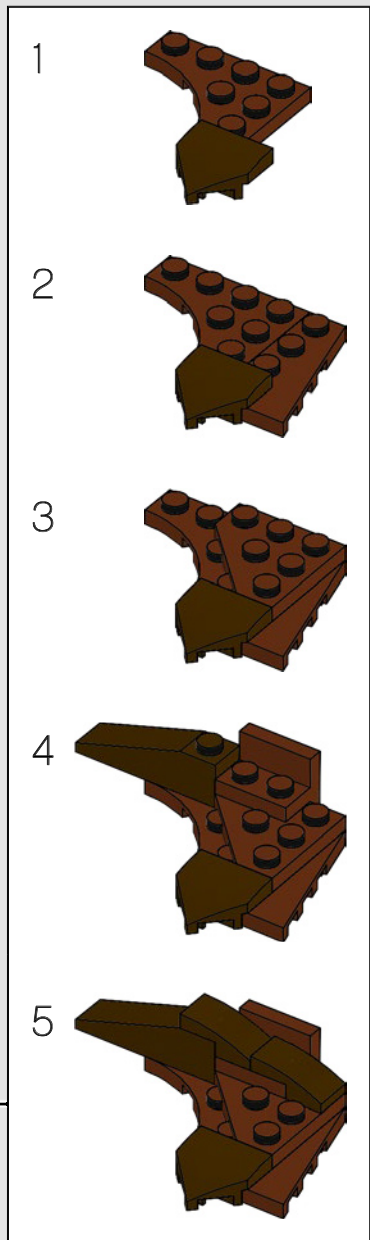
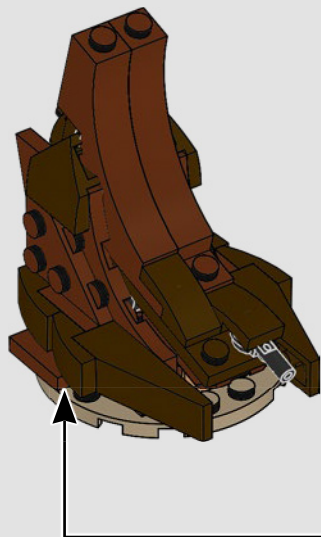

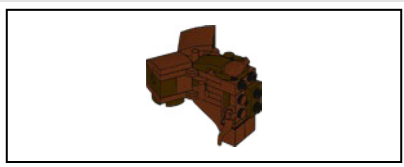

29



30

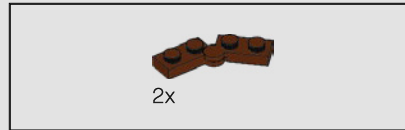
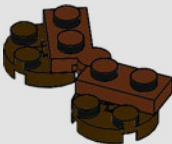

31

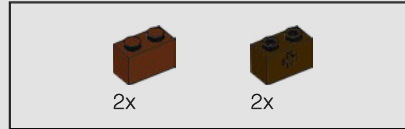
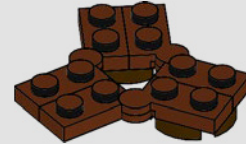

32

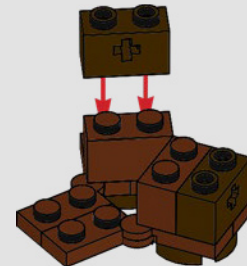

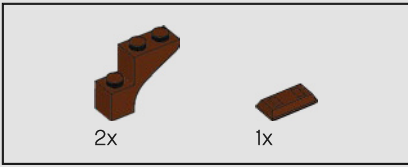

33

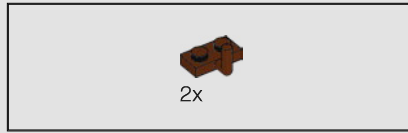
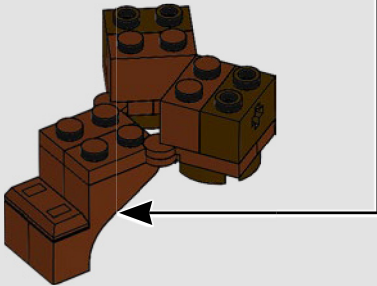
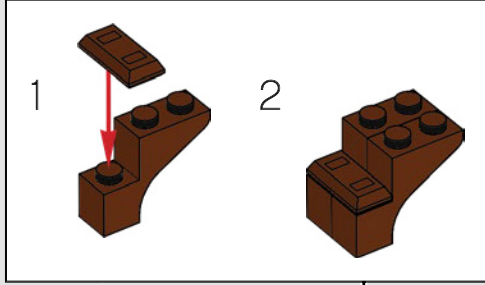

34

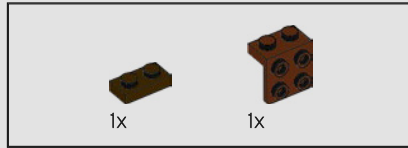
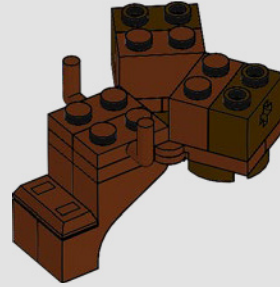

35

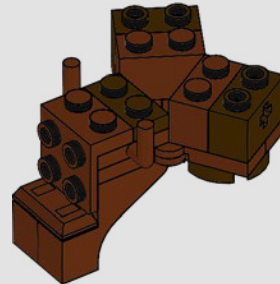

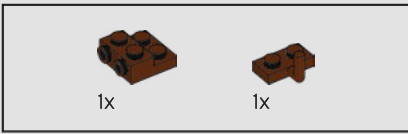

36

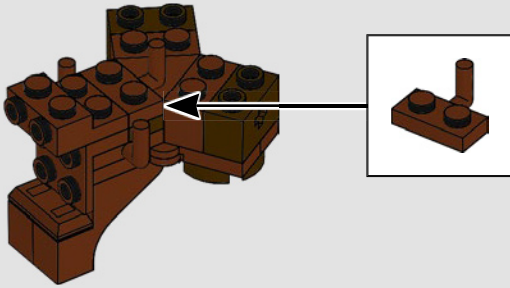

37

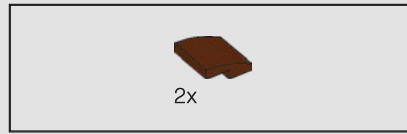
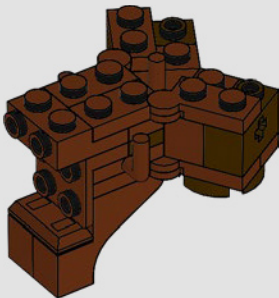

38

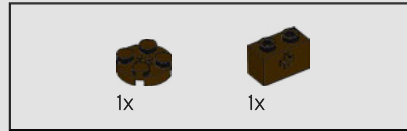
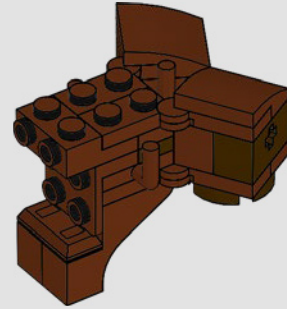

39

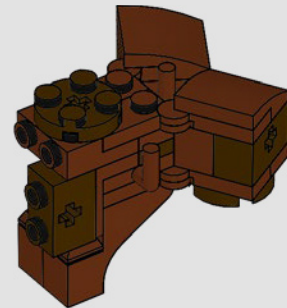



40

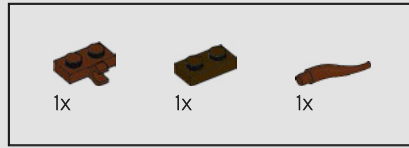
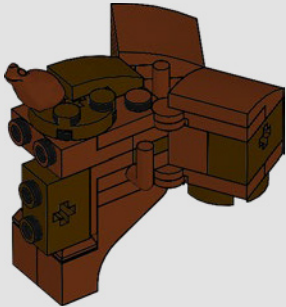

41

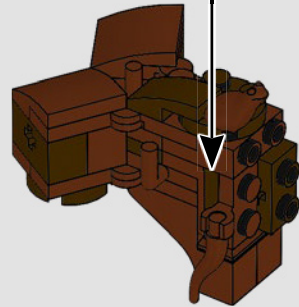
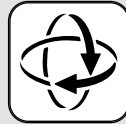
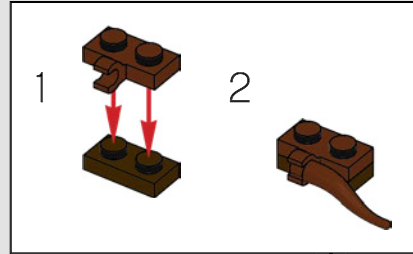



42

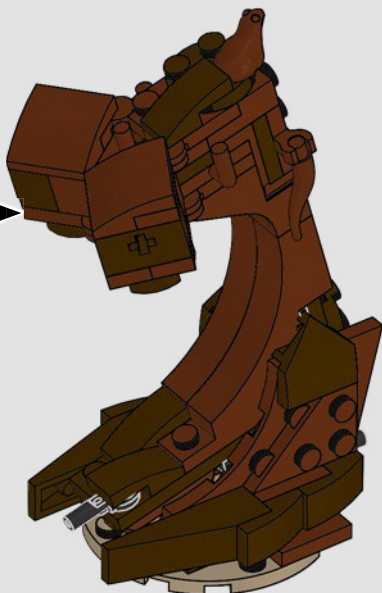

43

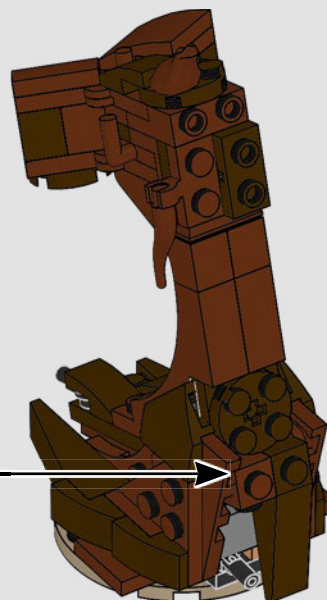
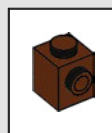
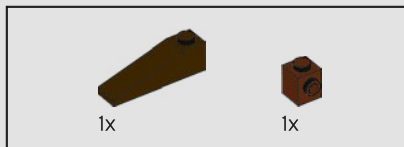

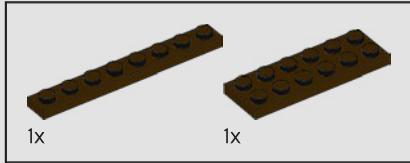
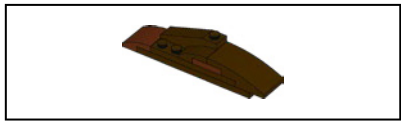

44

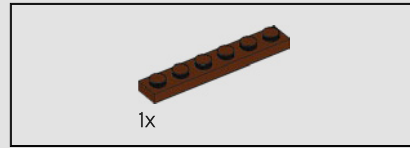
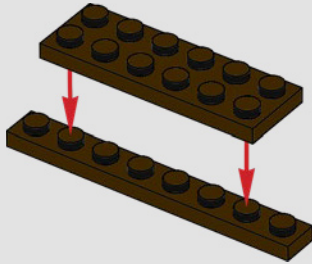

45

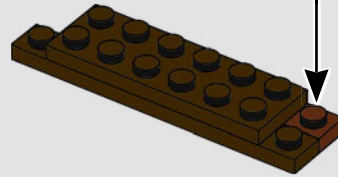
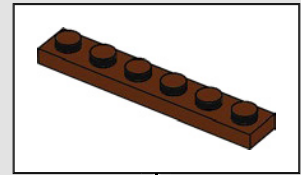

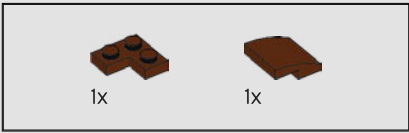

46

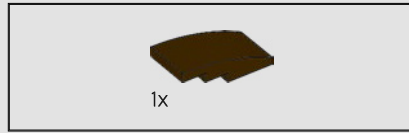
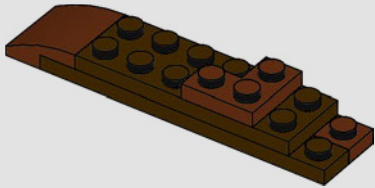

47

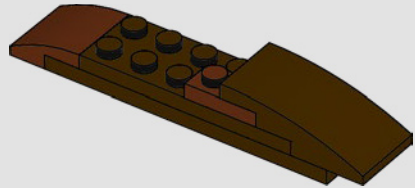

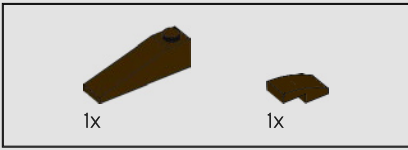

48

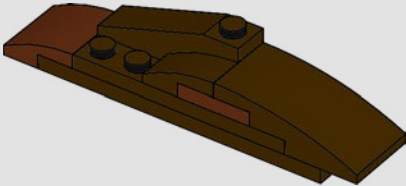

49

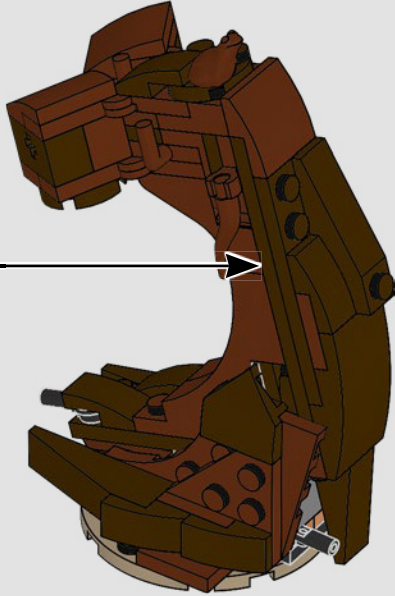

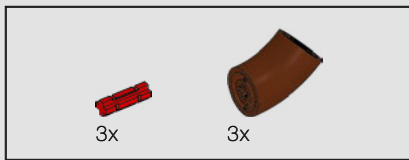

50

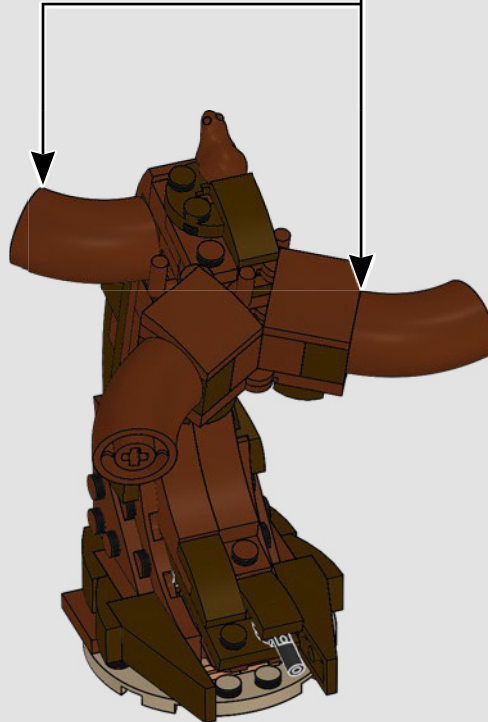
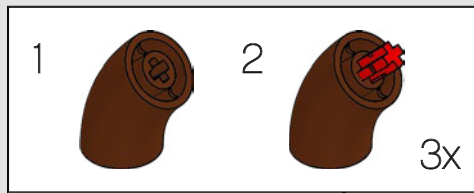

● This is one of the first times this particular element has been used in a LEGO® set in a reddish-brown color.

● C'est l'une des premières fois que cet élément est de couleur brun rougeâtre dans un ensemble LEGO®.

● Esta es una de las primeras veces que se usa este elemento específico en color café rojizo como parte de un set LEGO®.

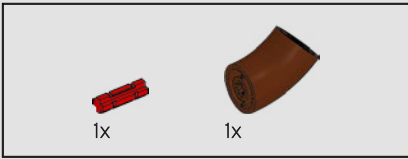

51

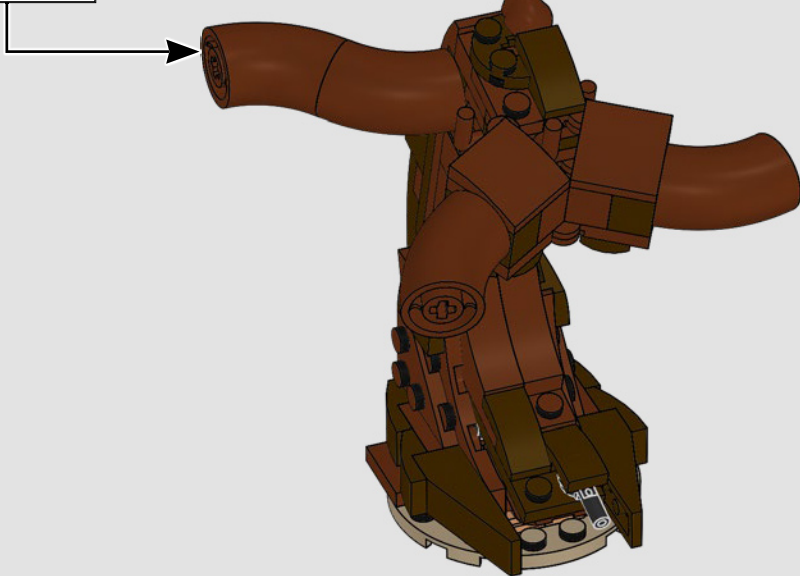
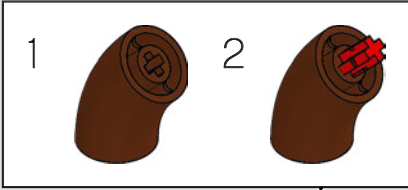

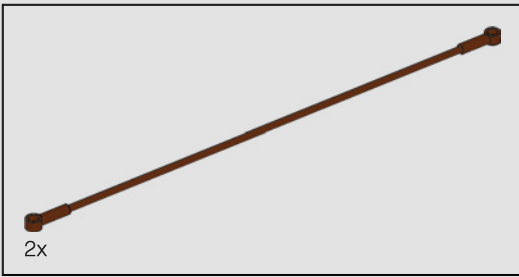

- It's the first time these LEGO® 'vine' elements have appeared in a reddish-brown color.
- C'est la première fois que ces éléments LEGO® de type « vigne » sont de couleur brun rougeâtre.
- Es la primera vez que aparecen estos elementos LEGO®, que representan lianas, en color café rojizo.

52

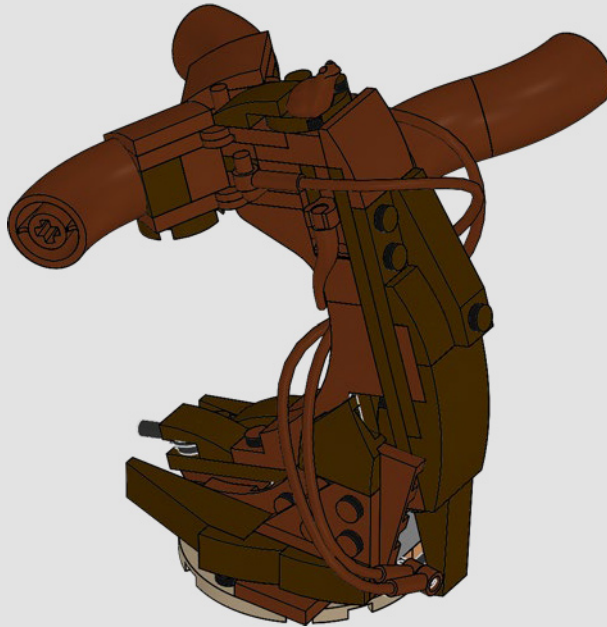

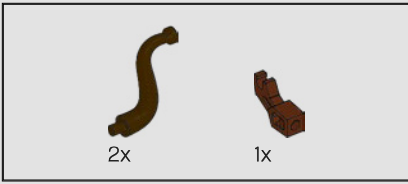

53

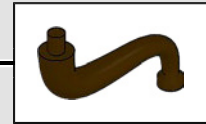
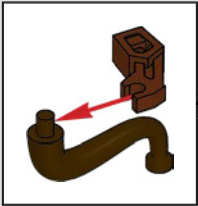
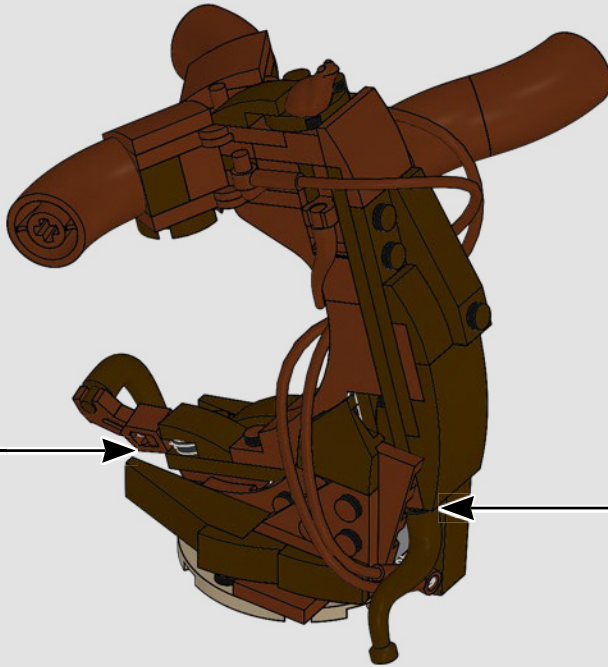



54

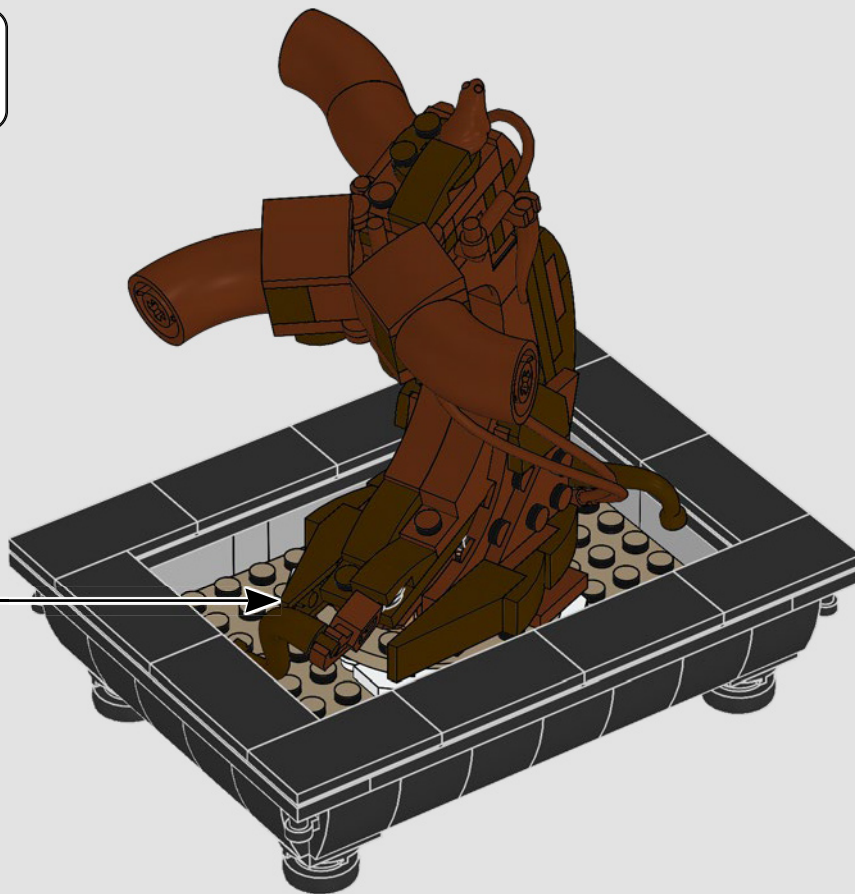

- These root pieces were originally used as elephant trunks, perfect for slurping water!
- Ces pièces de racines servaient à l'origine de trompes d'éléphants, parfaites pour aspirer l'eau !
- Originalmente, estas piezas, que representan raíces, se usaban como trompas de elefante: ¡perfectas para absorber el agua!

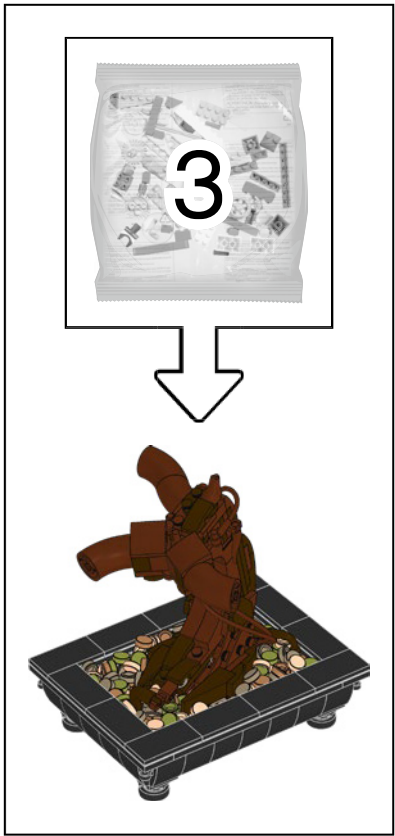

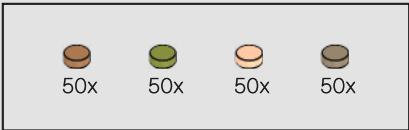

55





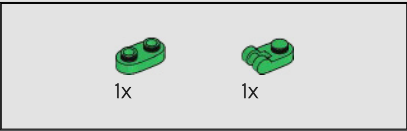
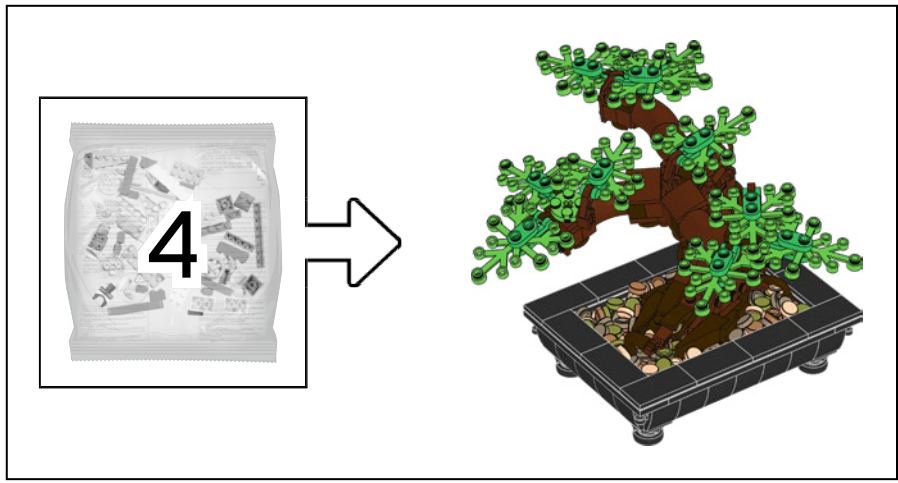

56

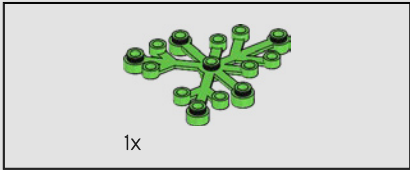
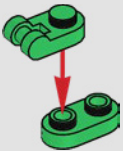

57



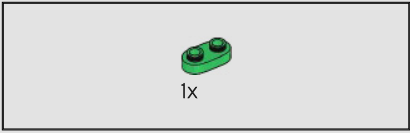

58

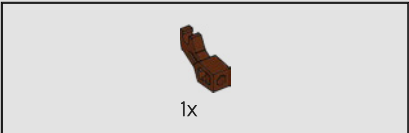
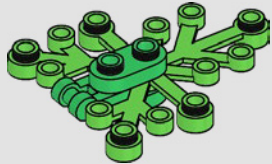

59

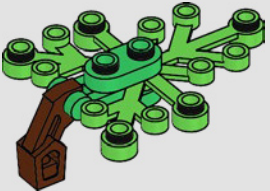

60



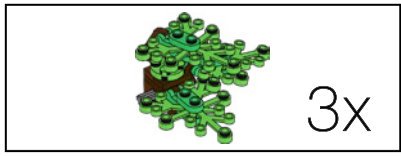

61

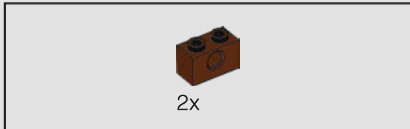

62

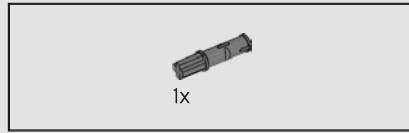
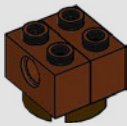

63

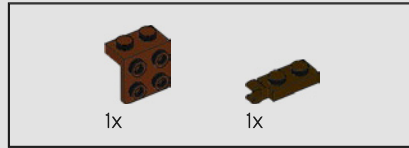
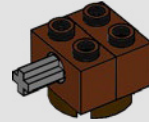

64

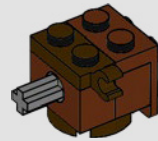



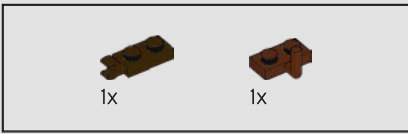

65

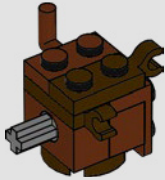

66

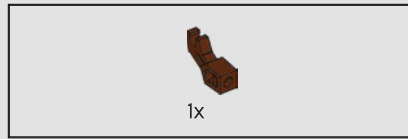
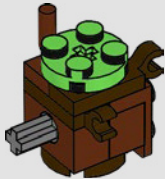

67

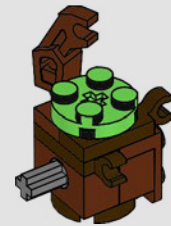

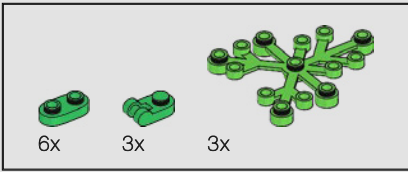

68

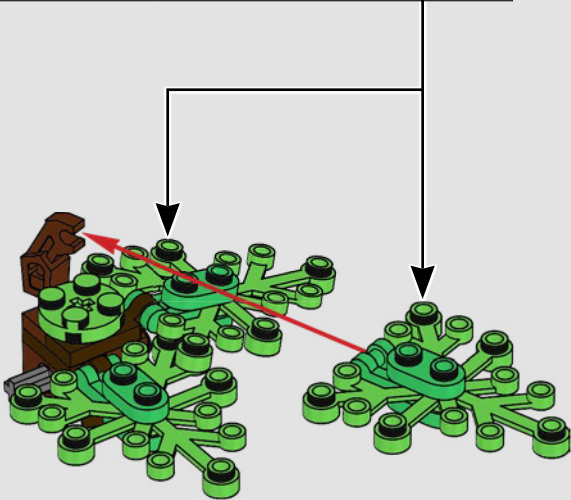
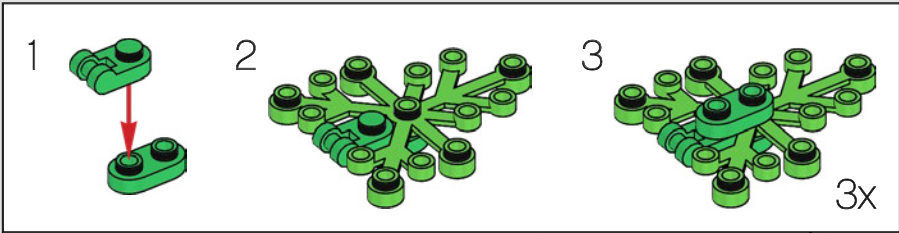

3x

69



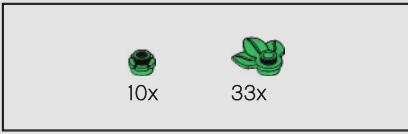

70

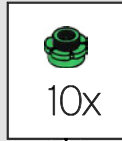
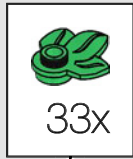

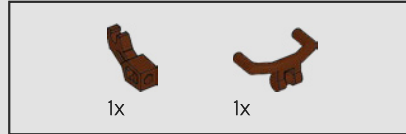
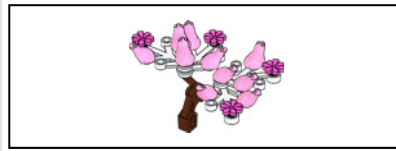
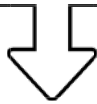

71

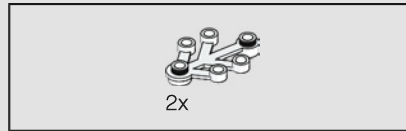
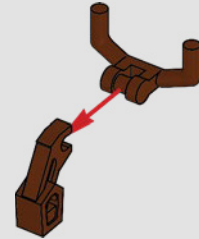

72

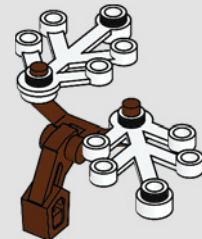

● These branch connectors were originally used as mini-doll bicycle handlebars.

● Ces connecteurs de branches étaient à l'origine des guidons de vélos pour minipoupées.

● Estas ramas conectoras se usaban originalmente como manubrios en bicicletas para minipersonajes.

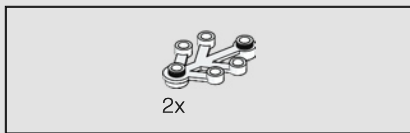

73

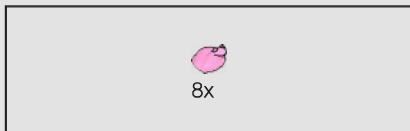

74

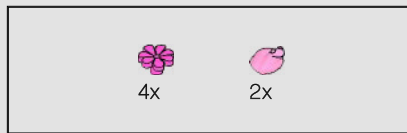
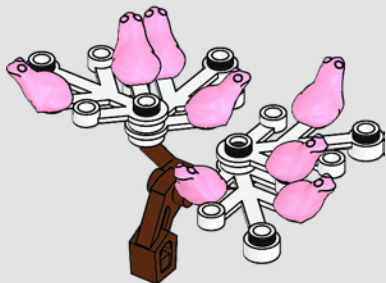

75

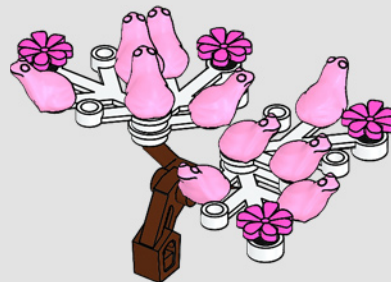

● The colorful blossoms on this tree are actually frog elements from earlier LEGO® sets.

● Les fleurs colorées de cet arbre sont en fait des éléments de grenouilles provenant d'ensembles LEGO® antérieurs.

● Las vistosas flores de este árbol son en realidad elementos con forma de rana procedentes de sets LEGO® anteriores.

76



● It's the first time these 'frogs' have been seen in this light purple color.

● C'est la première fois que ces « grenouilles » apparaissent dans cette couleur mauve clair.

● Es la primera vez que aparecen estas ranas en color púrpura claro.

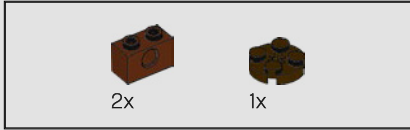
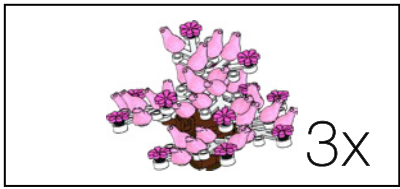

77

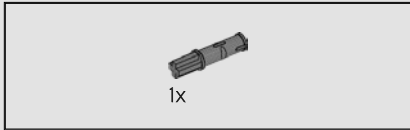
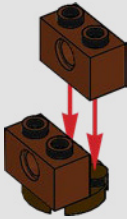

78

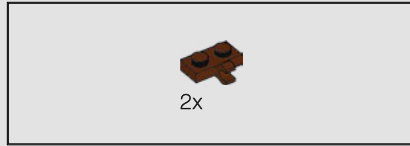
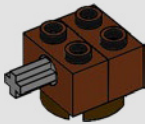

79

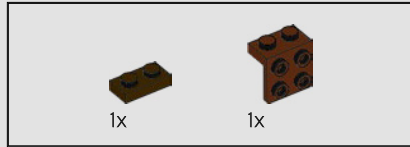
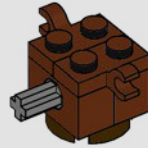

80

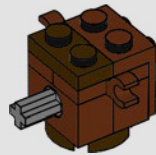



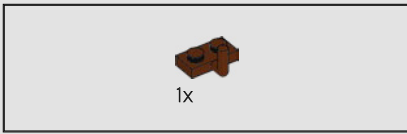

81

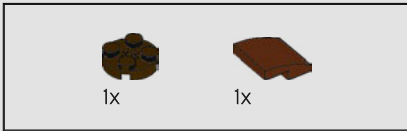
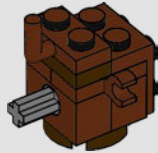

82

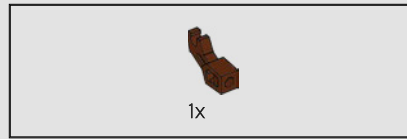
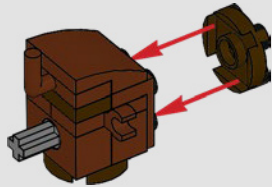

83

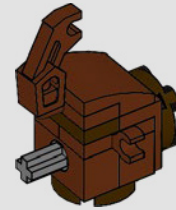

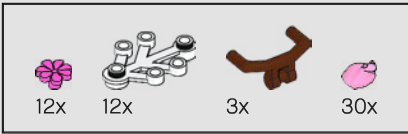

84

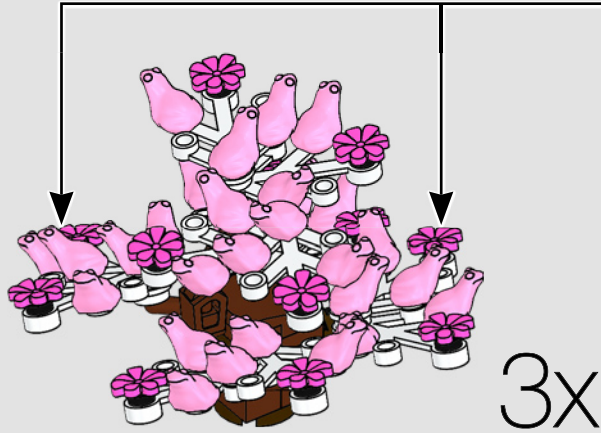
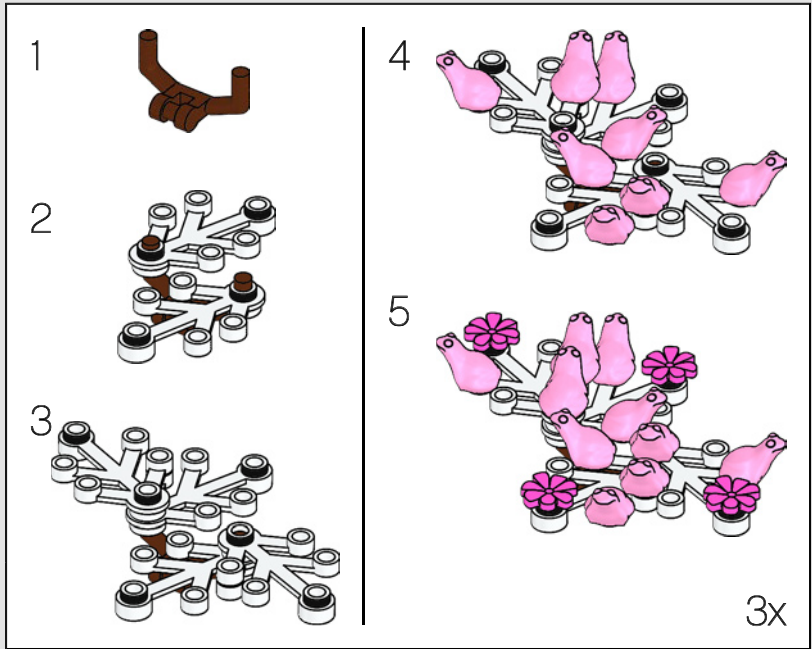

85

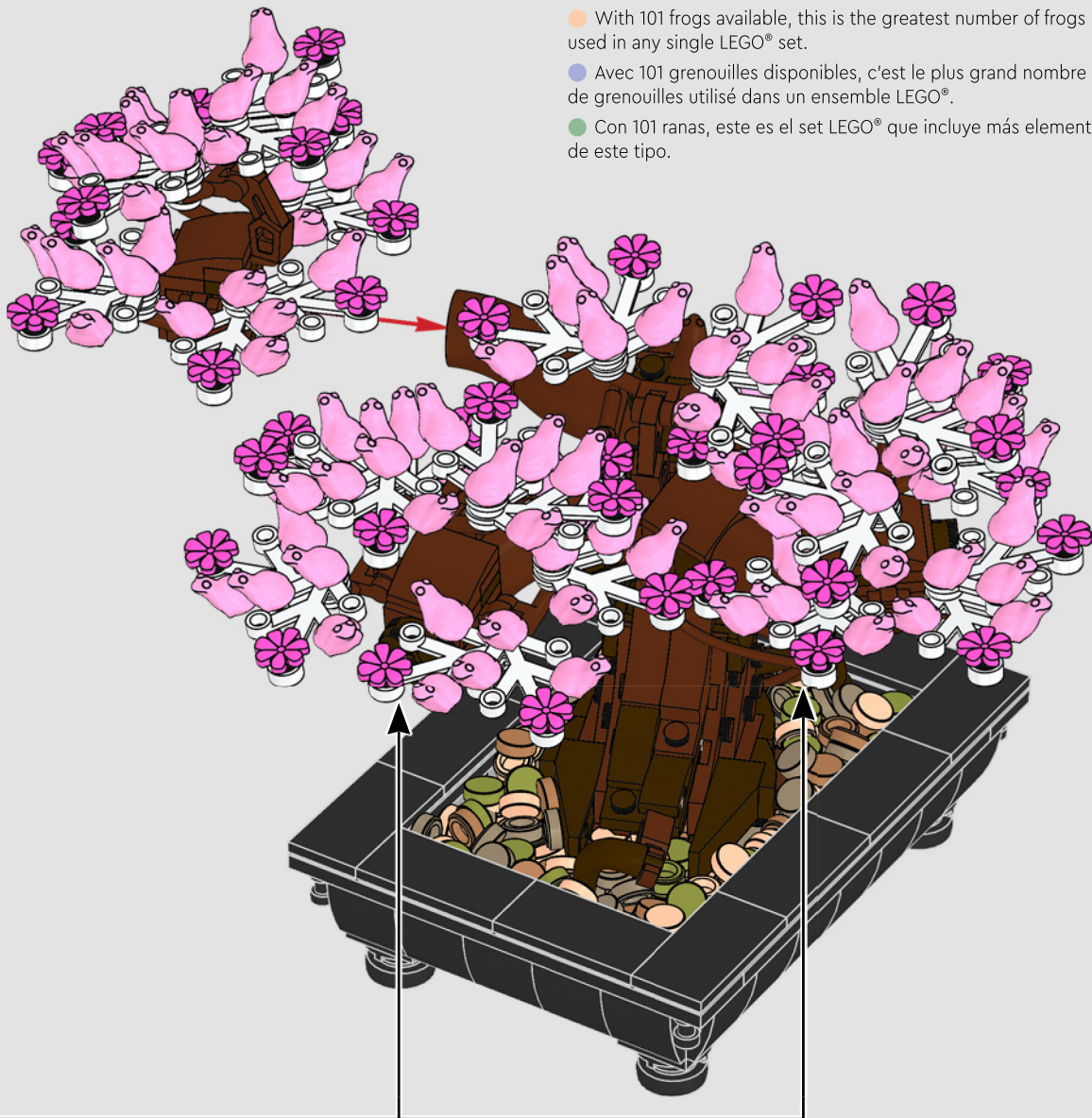

● With 101 frogs available, this is the greatest number of frogs used in any single LEGO® set.

● Avec 101 grenouilles disponibles, c'est le plus grand nombre de grenouilles utilisé dans un ensemble LEGO®.

● Con 101 ranas, este es el set LEGO® que incluye más elementos de este tipo.

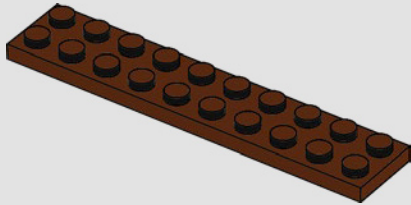
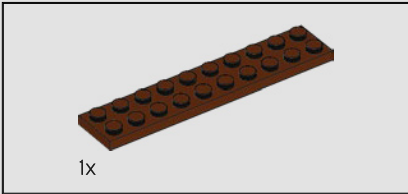
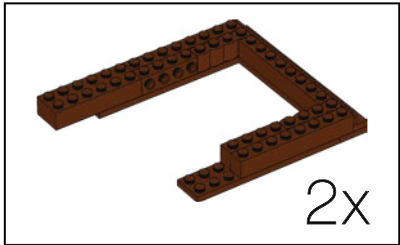
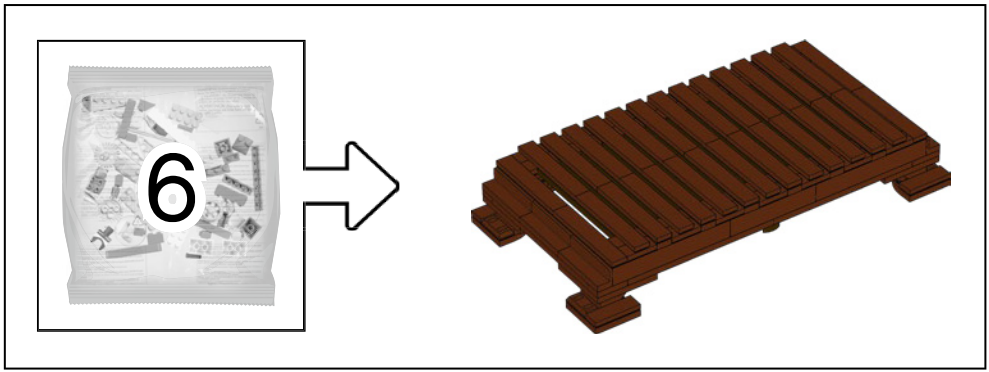

86

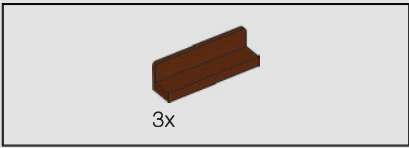

87

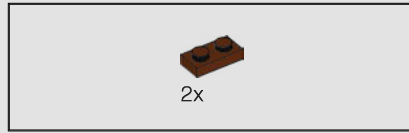
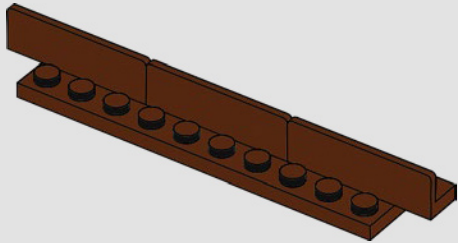

88

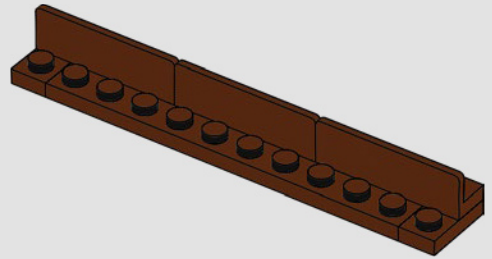

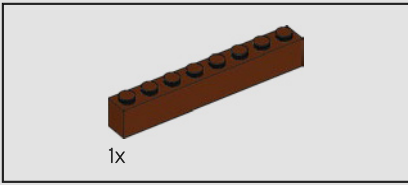

89

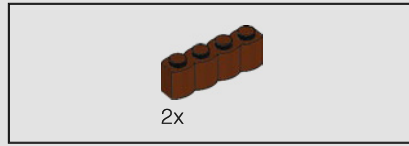
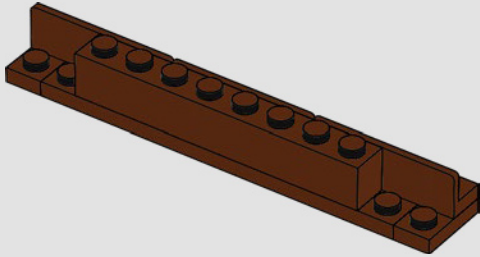

90

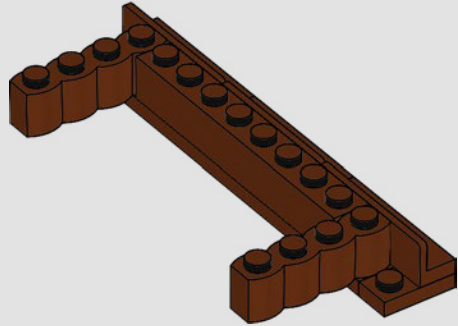

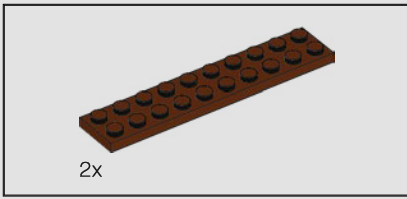

91

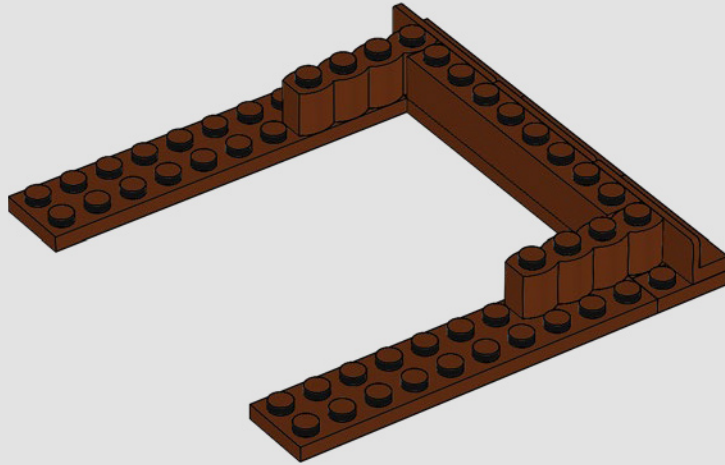

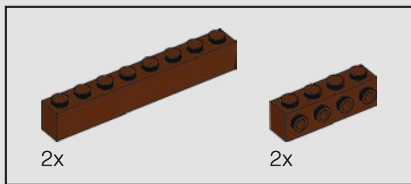

92

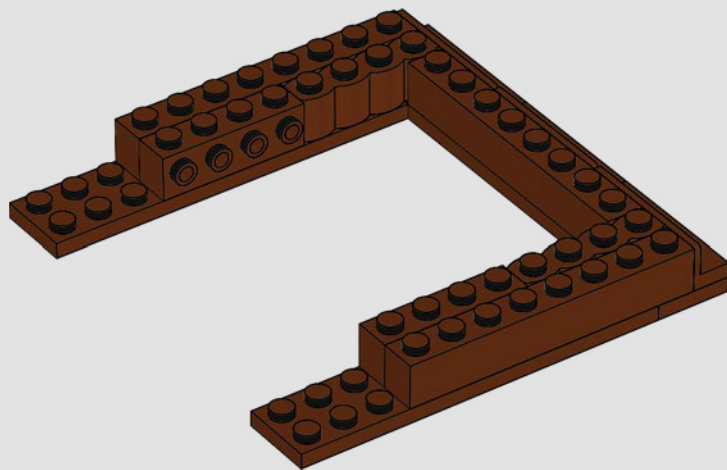



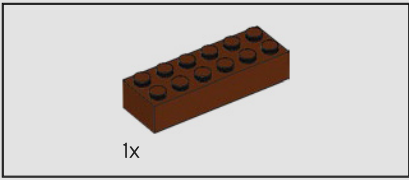

93

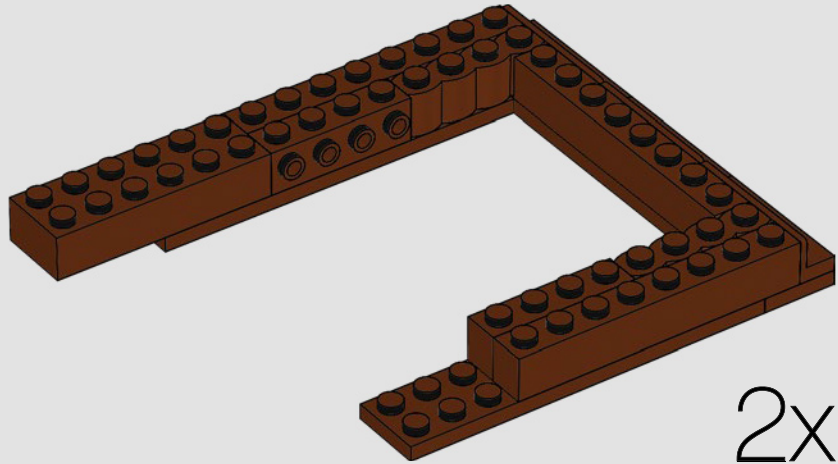

94

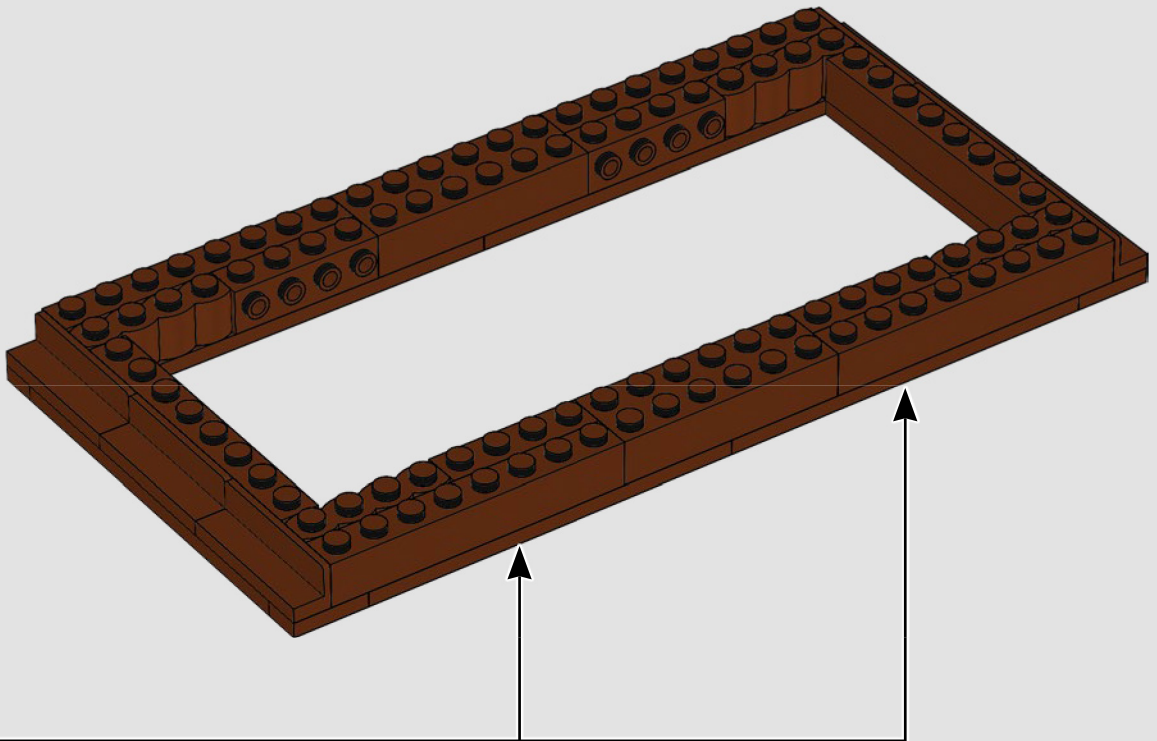

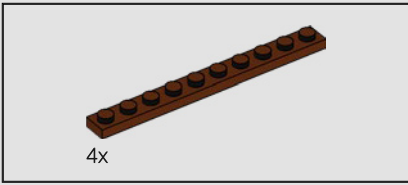

95

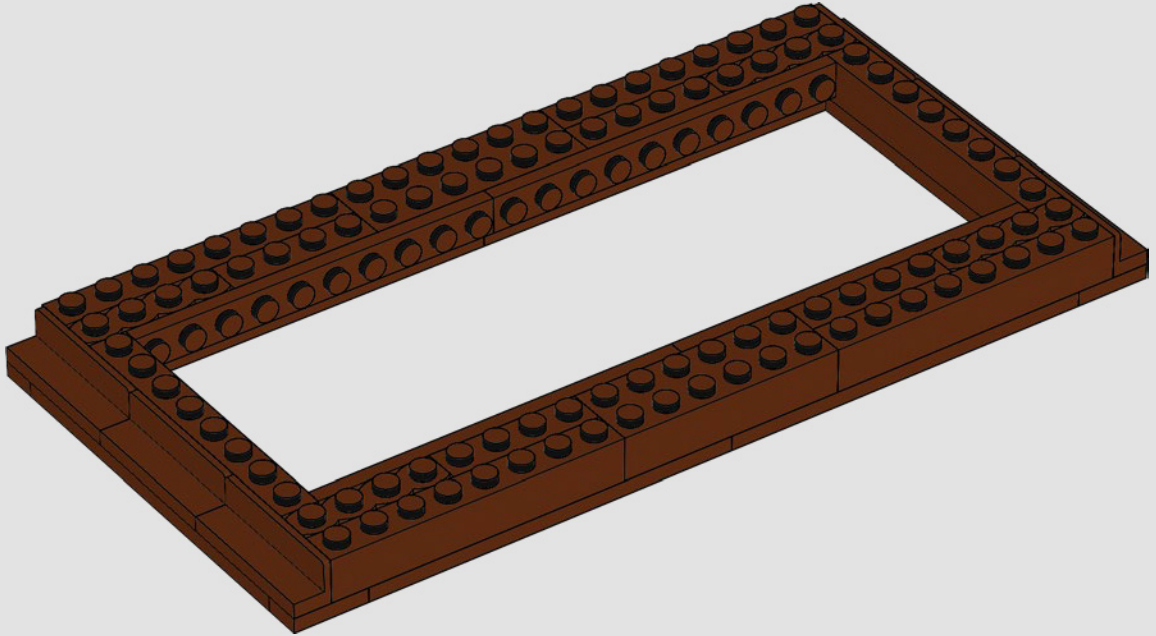

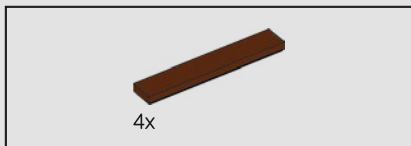

96

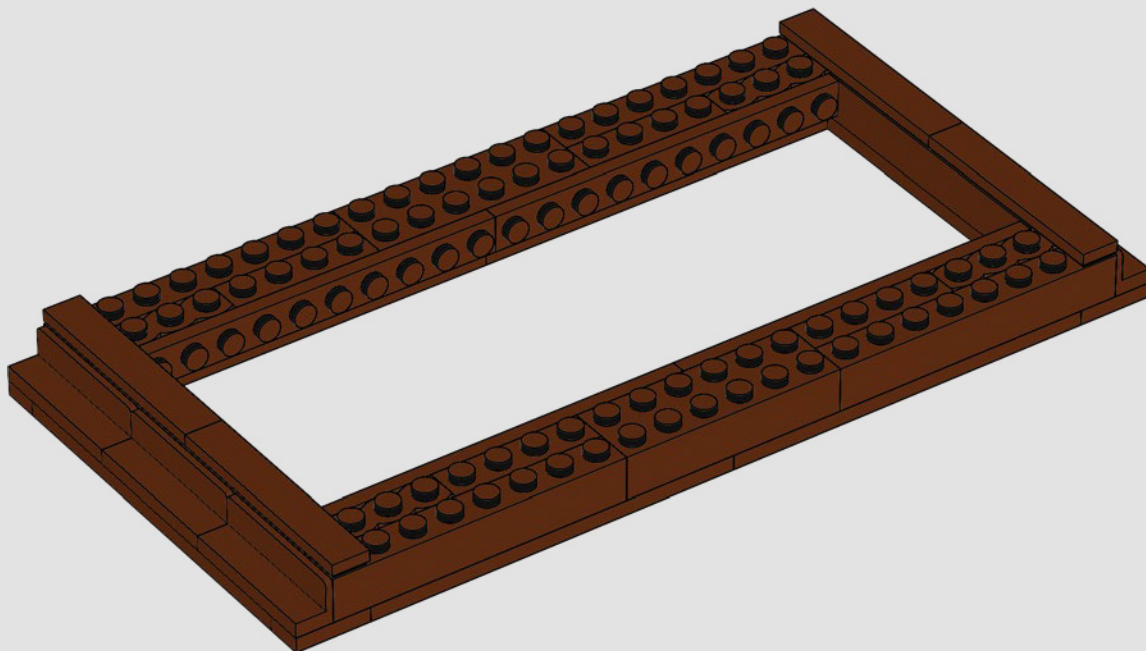

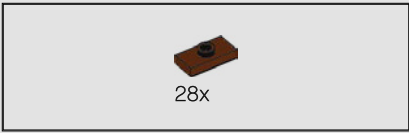

97

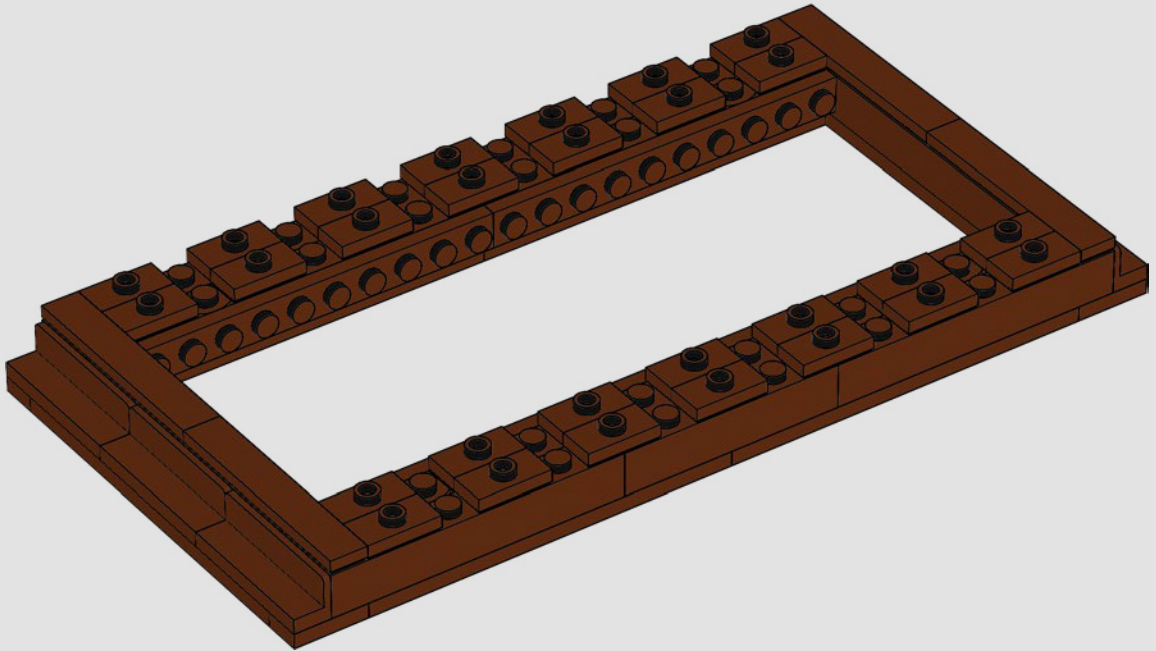



98

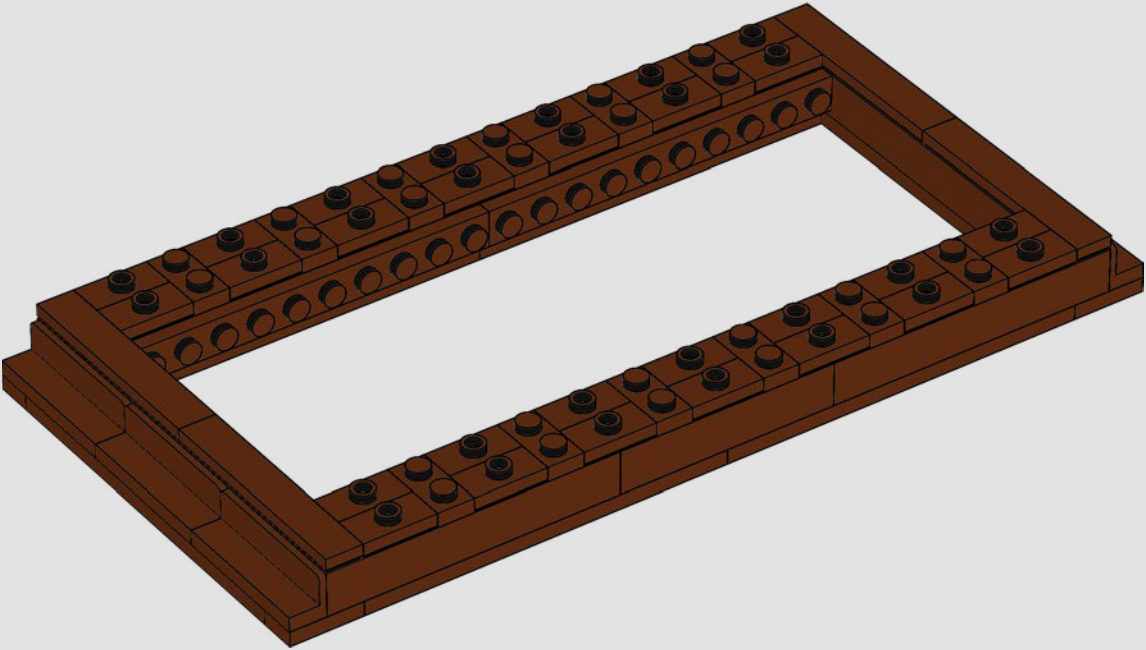



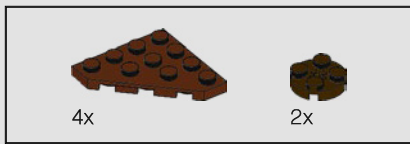

100

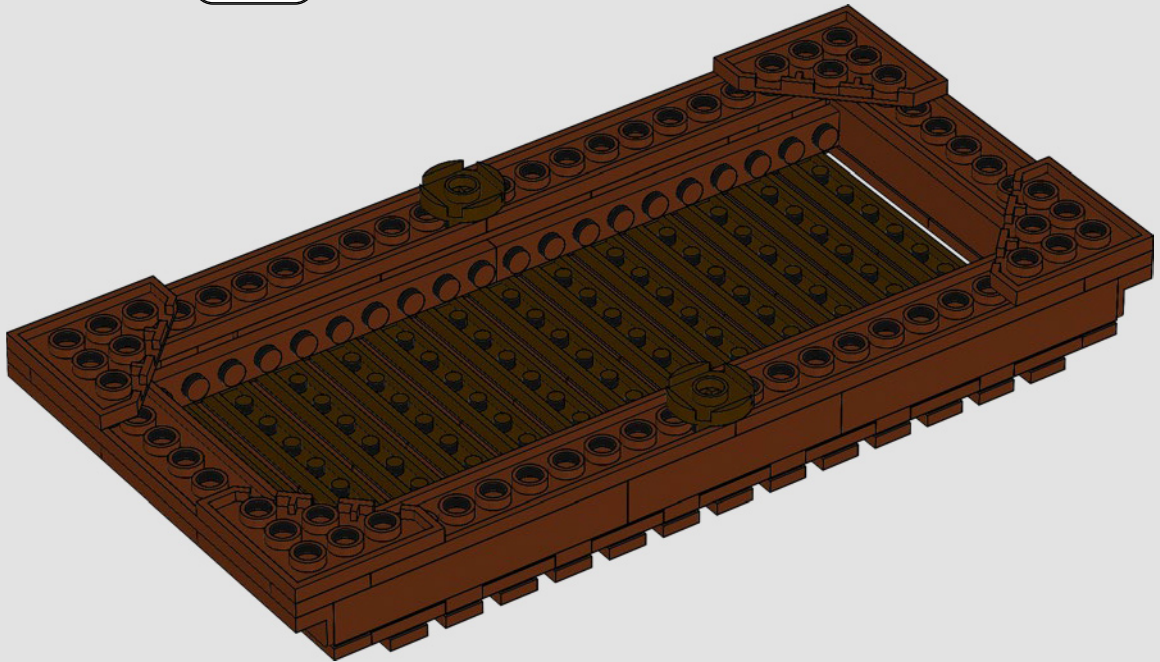



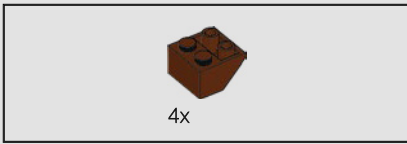

101

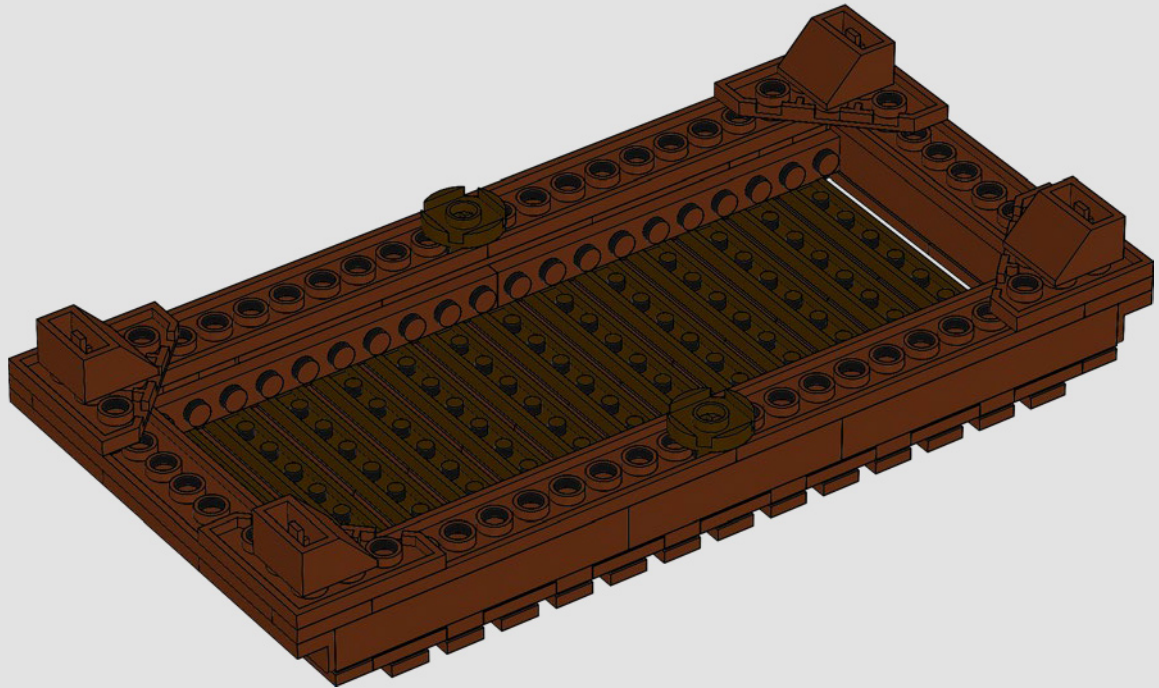

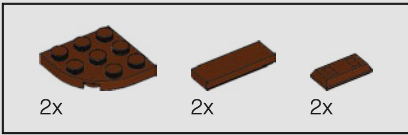

102

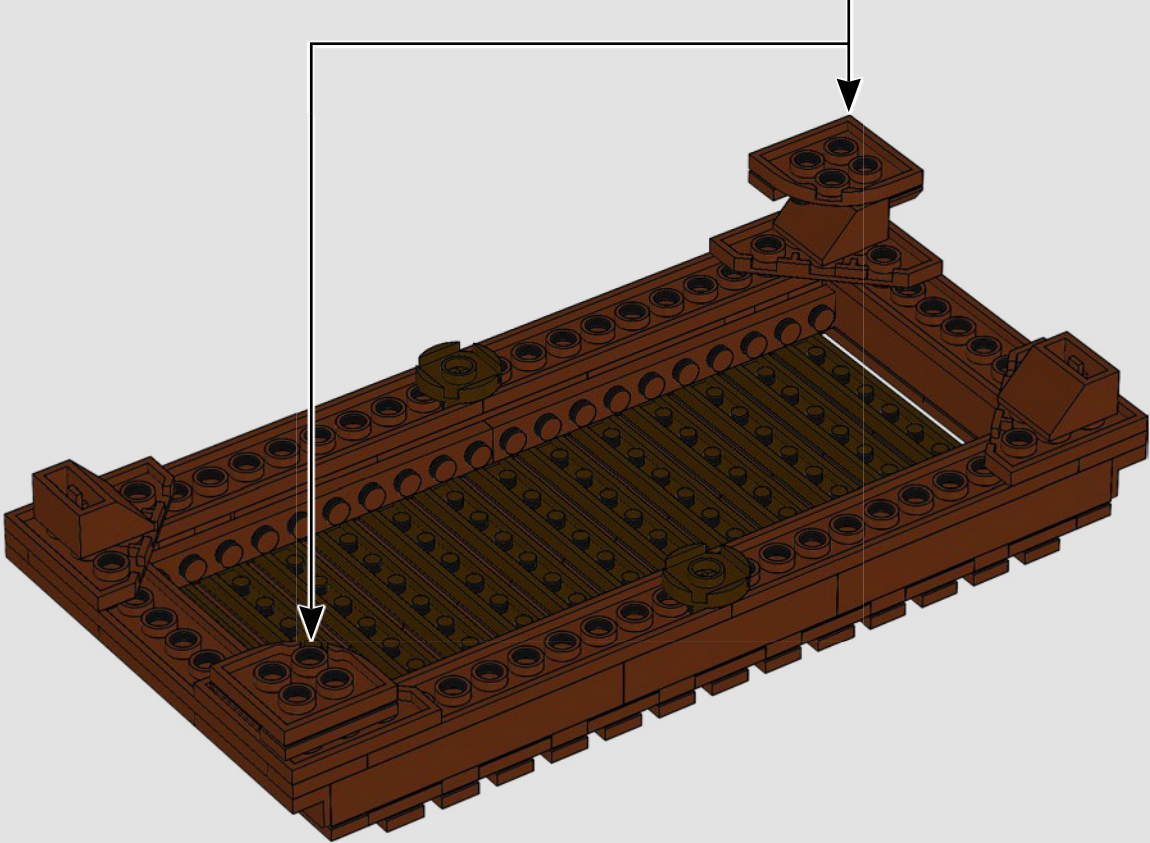
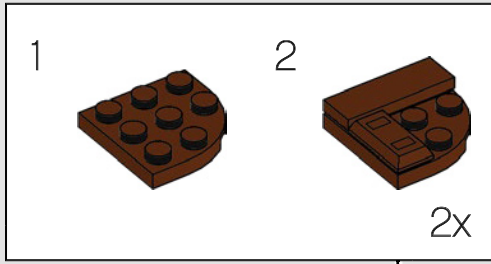

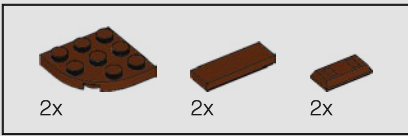

103

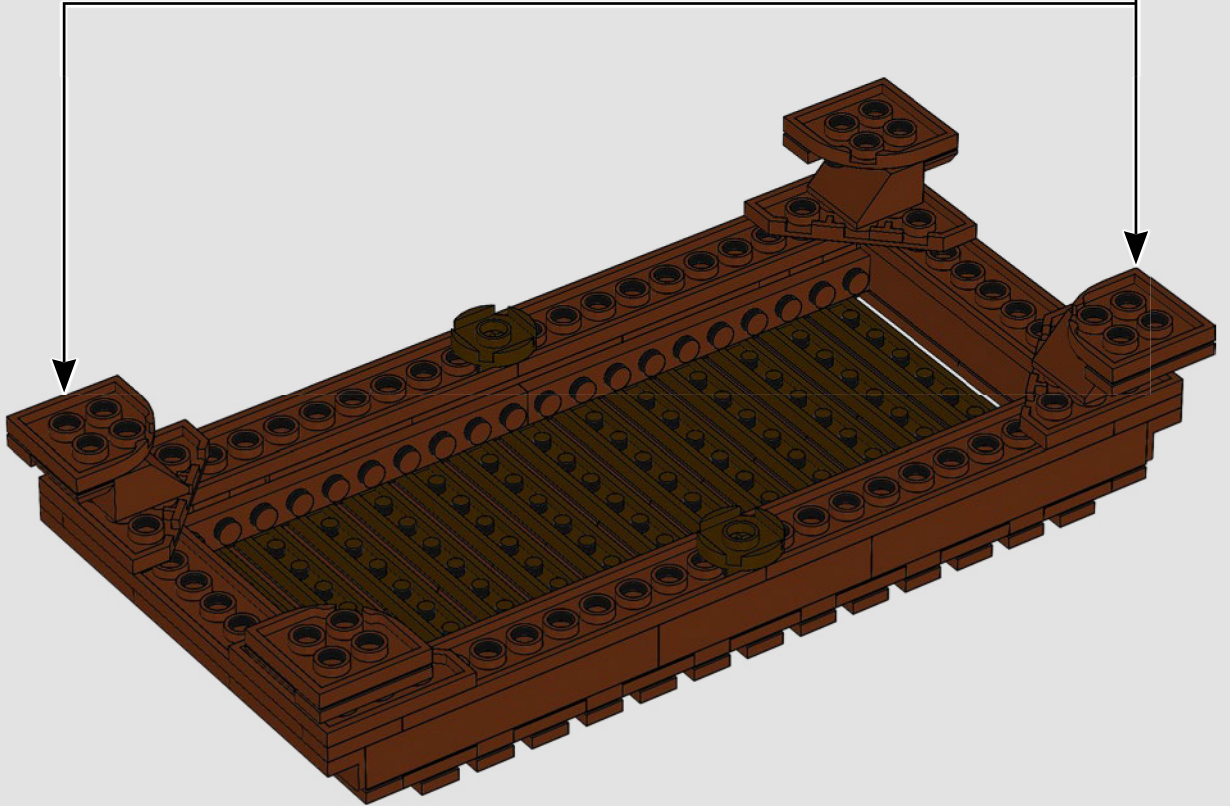
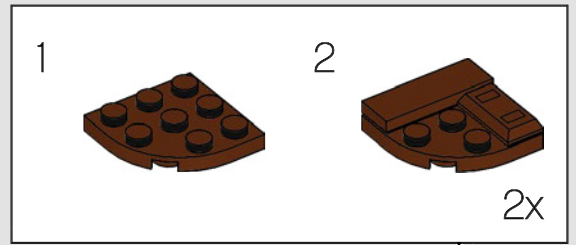

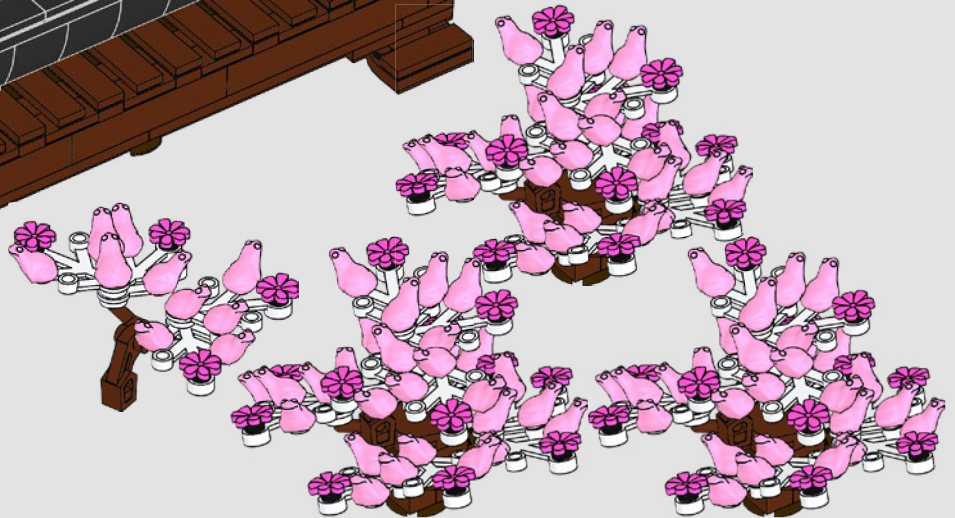
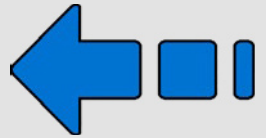



## KEEP ON GROWING/UNE CROISSANCE CONTINUE/ QUE SIGA CRECIENDO

● Unlike other art forms, a LEGO® Bonsai tree is never complete, but is instead an ongoing dynamic masterpiece. Once you have mastered the first two varieties of LEGO Bonsai, we hope you will want to branch out and create your own individual vision of the perfect tree. We have created this gallery to inspire you in your future building (they cannot be built from the bricks included in this set). While all the elements you see here are LEGO elements, not all of them are still available in our assortment, so hunt up your old LEGO sets and use whatever you find.

● Contrairement à d'autres formes d'art, un bonsaï LEGO® n'est jamais une œuvre terminée, mais plutôt un chef-d'œuvre dynamique en constante évolution. Une fois que vous aurez maîtrisé les deux premières variétés de bonsaïs LEGO, nous espérons que vous voudrez laisser libre cours à votre imagination et créer votre propre vision de l'arbre parfait. Voici quelques modèles pour inspirer vos constructions futures (ces exemples ne peuvent pas être construits à partir des briques incluses dans cet ensemble). Bien que tous les éléments dans ces images sont des éléments LEGO, certains ne sont plus disponibles dans notre assortiment, alors ressortez vos anciens ensembles LEGO et utilisez tout ce que vous trouverez.

● A diferencia de otras formas de arte, un bonsái LEGO® nunca está completo; en cambio, es una obra maestra dinámica y constante. Esperamos que, cuando domines las dos primeras variedades de bonsái LEGO, surja en ti el deseo de crear tu propia visión del árbol perfecto. Preparamos esta galería para que te sirva de inspiración cuando llegue el momento (los modelos no se pueden construir con los bricks que incluye este set). Aunque todas las piezas que puedes ver aquí son elementos LEGO de verdad, algunas ya no forman parte de nuestro surtido, así que aprovecha tus viejos sets LEGO y usa lo que encuentres.



Inspirational models only. Not part of the actual set. • Modèles d'inspiration seulement. Ils ne font pas partie de cet ensemble. • Modelos con fines de inspiración. No forman parte del set real.





Inspirational models only. Not part of the actual set. • Modèles d'inspiration seulement. Ils ne font pas partie de cet ensemble. • Modelos con fines de inspiración. No forman parte del set real.





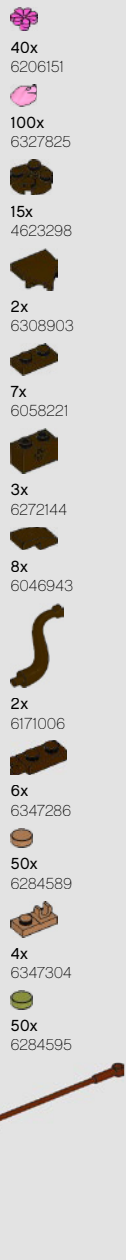
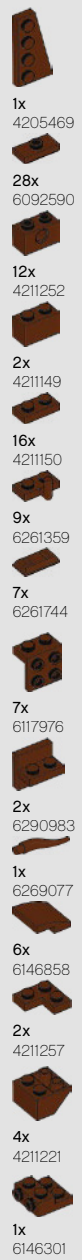
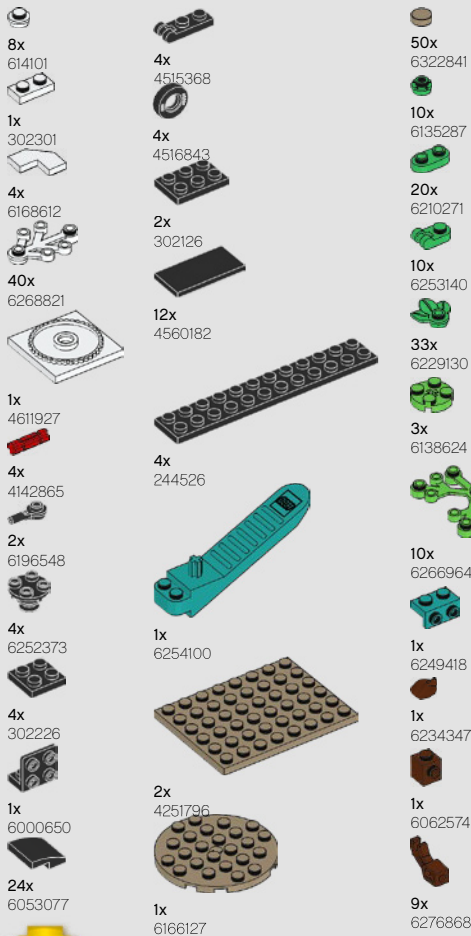

Inspirational models only. Not part of the actual set. • Modèles d'inspiration seulement. Ils ne font pas partie de cet ensemble. • Modelos con fines de inspiración. No forman parte del set real.

**Customer Service**  
**Kundenservice**  
**Service Consommateurs**  
**Servicio Al Consumidor**

**LEGO.com/service or dial**

00800 5346 5555 : 

1-800-422-5346 : 



# FEEDBACK AND WIN

## FEEDBACK AND WIN

Your feedback will help shape the future development of this product series.

Please visit:

## FEEDBACK UND GEWINNEN

Dein Feedback trägt zur Weiterentwicklung dieser Produktreihe bei.

Geh auf:

## COMMENTEZ ET GAGNEZ

Vos commentaires nous aideront à concevoir les futurs produits de cette gamme.

Rendez-vous sur :

## COMENTA Y GANA

Tu opinión nos ayudará a dar forma al desarrollo de esta serie de productos en el futuro.

Visita:

## 反馈有奖

您的反馈将有助于我们在今后改进本系列产品。

请访问：

[LEGO.com/productfeedback](https://www.lego.com/productfeedback)

By completing, you will automatically enter a drawing to win a LEGO® set.

Terms & Conditions apply.

Durch Ausfüllen nimmst du automatisch an der Verlosung eines LEGO® Preises teil.

Es gelten die Teilnahmebedingungen.

En envoyant vos commentaires, vous serez automatiquement inscrit(e) à un tirage au sort qui vous permettra de remporter un prix LEGO®.

Offre soumise à conditions.

Al contestar, participarás automáticamente en el sorteo y podrás ganar un set LEGO®.

Sujeto a Términos y Condiciones.

完成我们的反馈调查，即可自动进入抽奖环节，赢取乐高® 套装。

适用《条款和条件》。

