

MEGA
CONSTRUX™

nickelodeon
TEENAGE MUTANT NINJA
TURTLES



FFC54

4x
MA74397APG

1x
MA07223F

8x
MA1113APG

1x
AM78632APG

2x
AM16914KC

2x
AM18628APG

2x
AM18260APG

1x
MA09393MM

1x
MA09393F

2x
AM18630MM

2x
AM18272APG

2x
MA16649APG

1x
MA03773APG

1x
MA18329MM

1x
MA17502MM

1x
AM17509BOR

1x
AM17509APG

1x
AM76521F

2x
MA09493APG

1x
AM72601APG

2x
AM02219BOR

1x
AM78681AJK

1x
AM77193MM

1x
MA1480MM

1x
AS-FFC54-03

1x
AS-DMX16-02

1x
AS-FFC54-02

2x
AS-FFC54-01

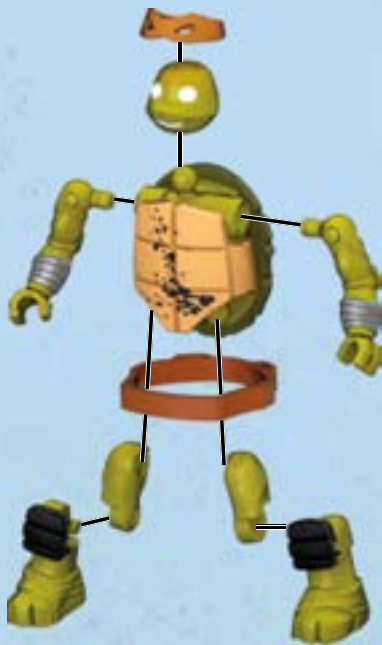
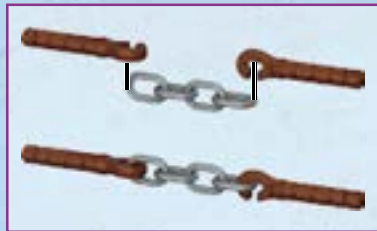

1x
FIG-FFC54-A



⚠ WARNING:
CHOKING HAZARD. - Small parts.
Not for children under 3 years.

⚠ ATTENTION:
DANGER D'ÉTOUFFEMENT. - Présence de petits éléments.
Ne convient pas aux enfants de moins de 3 ans.

⚠ 警告:
噎住危險。包含有小部件
不适合3岁以下的小孩玩。

⚠ 警告:
のどにつまる危険 小さな部品が含まれています
3歳以下の子供には与えないで下さい。

⚠ : تحذير
خطر الاختناق - قطع صغيرة.
غير صالحة للأطفال أقل من 3 سنوات.

ADVERTENCIA: Peligro de asfixia. Juguete no recomendado para menores de 3 años, porque contiene piezas pequeñas que podrían provocar asfixia en casode ser ingeridas o inhaladas por el/la niño/a.

ATENÇÃO: Não recomendável para crianças com menos de 36 meses. Contém peças pequenas capazes de criar risco de asfixia.

AVVERTENZA: Contiene pezzi di piccole dimensioni.

ACHTUNG: Kleine Teile.

OSTRZEZENIE: Małe części

WAARSCHUWING: Kleine onderdelen

ПРЕДУПРЕЖДЕНИЕ: Мелкие детали

ADVARSEL: Små dele.

VARNING: Smådelar

ADVARSEL: Små deler.

VAROITUS: Pieniä osia

ΠΡΟΣΟΧΗ: Περιλαμβάνονται μικρά κομμάτια.

UYARI: BOĞULMA TEHLİKESİ - Küçük Parçalar İçerir. 3 yaşından küçük çocuklar için uygun değildir.



Please read these instructions carefully before first use and keep them for future reference.

Il est recommandé de lire attentivement ce feuillet avant la première utilisation et de le conserver pour référence future.

Leer estas instrucciones cuidadosamente antes de la primera utilización y guardarlas para referencia futura.

Leia as instruções antes do primeiro uso e guarde-as para futura referência.

Leggere le istruzioni prima di cominciare ad usare il gioco e conservarle per referenze future.

Die Gebrauchsanleitung bitte durchlesen und aufbewahren.

Proszę uważnie przeczytać instrukcję obsługi przed pierwszym użyciem, a następnie zachować ją na przyszłość.

Wij raden u aan deze handleiding zorgvuldig te lezen en te bewaren voor eventuele raadpleging op een later tijdstip.

Внимательно прочитайте инструкцию перед первым использованием и сохраните ее для дальнейшего использования.

Vær venlig at læse disse instruktioner omhyggeligt inden ibrugtagning og opbevar dem til fremtidig brug.

Läs noggrant igenom dessa instruktioner innan du använder produkten för första gången och spara dem för ev. framtida frågor.

Les disse instruksjonene nøye før første gangs bruk, og ta vare på dem for fremtidige oppslag.

Lue nämä ohjeet huolellisesti ennen ensimmäistä käyttöä ja säilytä ne myöhempää tarvetta varten.

Διαβάστε προσεκτικά τις οδηγίες πριν από τη χρήση και κρατήστε τις για μελλοντική αναφορά.

Ilk kullannimden önce talimatları dikkatlice okumanızı ve bu bilgileri ileride tekrar bakabilmek için saklamamanızı öneririz.

第一次使用前，请仔细阅读本说明书并保留以备将来参考。

初めてご使用になる前に、この説明書をよくお読みください。また、本書は将来いつでも参照できるように保管してください。

يجب قراءة هذه التعليمات بعناية قبل الاستخدام والاحتفاظ بها للعودة إليها مستقبلاً.



© 2017 Viacom Overseas Holdings C.V. All Rights Reserved. Teenage Mutant Ninja Turtles and all related titles, logos and characters are trademarks of Viacom Overseas Holdings C.V.

® D714,887

PLAY.MEGACONSTRUX.COM

1



2x



1x



1x

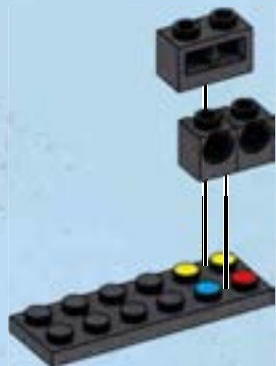

2



1x



1x



2x

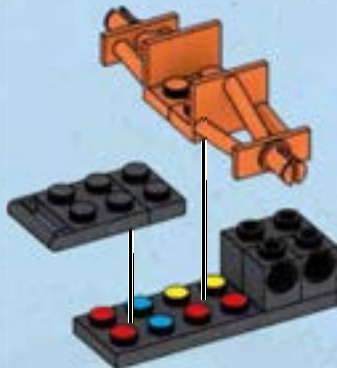

3



1x



1x

4



2x



1x

5

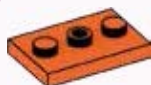

1x



1x

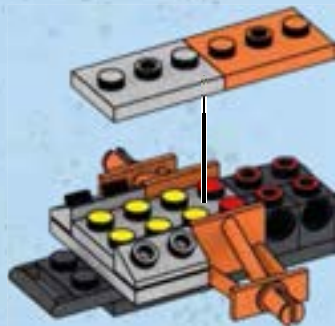
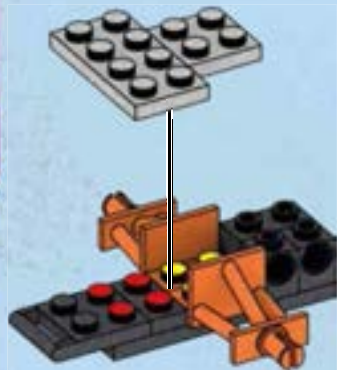

6



1x



1x

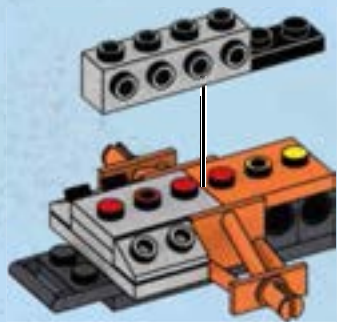

7



8x

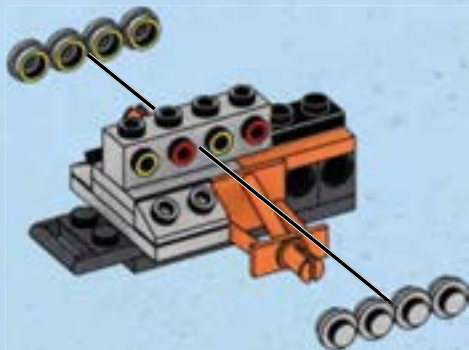

8



1x

2x

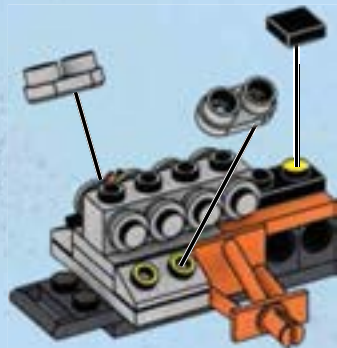

9



4x

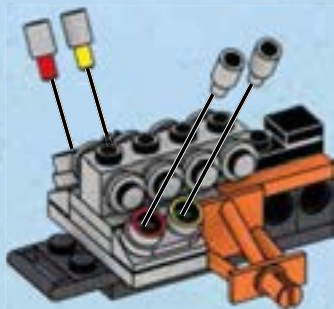

10



1x

2x

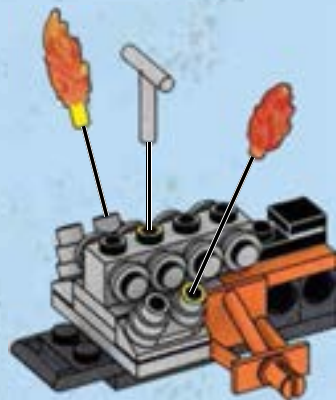

11

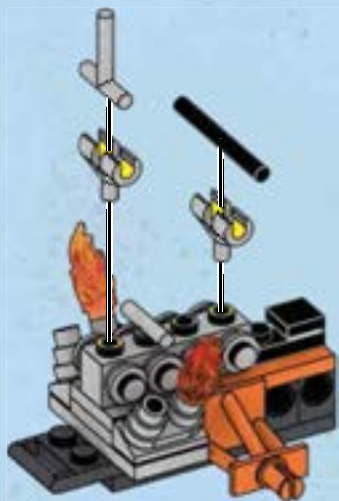

12

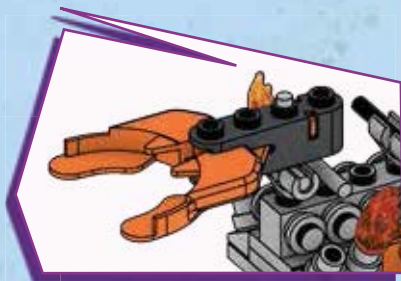
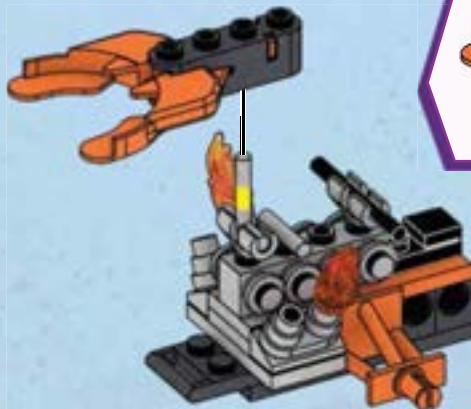
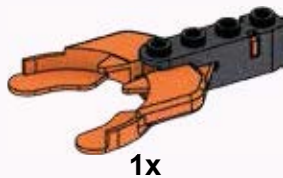

13



1x



1x

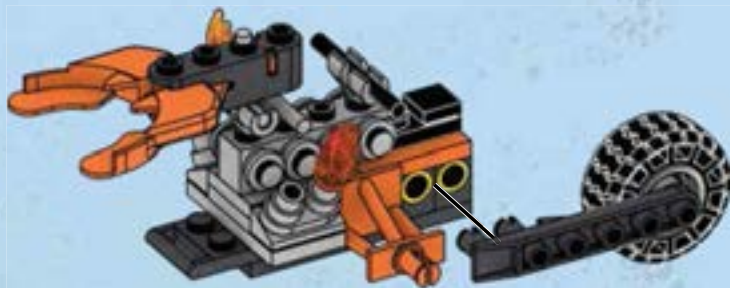



Warning: Do not aim at eyes or face. Only use projectiles supplied with this toy. Do not fire at point blank range.

Attention : Ne pas viser les yeux ou le visage. Ne pas utiliser d'autres projectiles que ceux fournis avec ce jouet. Ne pas tirer à bout portant.

Advertencia: No apuntar hacia los ojos o la cara. Utilizar exclusivamente los proyectiles suministrados con este juguete. No disparar a quemarropa.

Atenção: Não apontar em direção aos olhos ou ao rosto. Usar apenas os projéteis fornecidos com este brinquedo. Não disparar à queima-roupa.

Avvertenza: Non mirare agli occhi o al viso. Usare solo i proiettili forniti con il giocattolo. Non sparare a distanza ravvicinata.

Achtung: Nicht auf Augen oder Gesicht zielen. Nur die zu diesem Spielzeug gehörenden Projektiler verwenden.

Nicht auf Menschen oder Tiere oder aus nächster Nähe zielen.

Ostrzeżenie: Nie celuj w oczy i twarz. Nie strzelaj pociskami innymi niż dostarczone z zabawką. Nie strzelaj z bliska.

Waarschuwing: niet op ogen of gezicht richten. Gebruik uitsluitend de bijgeleverde projectielen.

Niet van te dichtbij afschieten.

Предупреждение: Не направляйте в глаза или лицо. Используйте только снаряды,

входящие в комплект. Не стреляйте со слишком близкого расстояния.

Advarsel: Sigt ikke mod øjne eller ansigt. Brug kun de projektiler, som følger med

legetøjet. Skyd ikke direkte på personer eller ting.

Varning: Sikta inte mot ögon eller ansikte. Använd endast projektiler som

medföljer leksaken. Fyra inte av på mycket nära håll.

Advarsel: Du må ikke sikte mot øyne eller ansikt. Bruk bare prosjektilene

som følger med leken. Ikke skyt på noe på kloss hold.

Varoitus: Älä tähtää silmiin äläkä kasvoihin. Käytä ainoastaan

tämän tuotteen mukana tulleita ammuksia.

Älä ammu lähietäisyydeltä.

Προσοχή: Μην στοχεύετε στα μάτια ή στο

πρόσωπο. Χρησιμοποιείτε μόνο τα βλήματα που

περιλαμβάνονται. Μην στοχεύετε όταν δεν

έχετε ορατότητα.

Uyarı: Göze veya yüze nişan almayın.

Fırlatmak için yalnızca bu oyuncakla

birlikte verilen objeleri kullanın.

İnsanlara ve hayvanlara nişan

almayın.

警告：请勿对着眼睛或脸部发

射。仅使用本玩具自带的抛射

物。请勿近距离射击。

警告：目や顔を狙わないでく

ださい。このおもちゃに同梱

されている発射物のみ使用する

ようにしてください。到達可

能な距離内で火を燃やさないで

ください。

تحذير: يجب عدم التصويب باتجاه العينين أو

الوجه. يجب استخدام المقذوفات المزودة مع هذه

اللعبة فقط. يجب عدم الإطلاق من مدى قريب.





* Each sold separately and subject to availability. / Tous vendus séparément. Certains produits peuvent ne pas être commercialisés. / Se venden por separado y están sujetos a disponibilidad. / Vendidos em separado e sujeitos à disponibilidade. / Ognuno in vendita separatamente secondo disponibilità. / Alle Artikel separat erhältlich. Einige Artikel werden nicht in allen Ländern vertrieben. / Sprzedawane oddzielnie w zależności od dostępności. / Per stuk verkrijgbaar en niet overal leverbaar. / Каждый продукт продается отдельно, в зависимости от наличия. / Sælges separat og så længe lager haves. / Alla delar säljs separat så långt lagret räcker. / Hver leke selges separat så langt lageret rekker. / Jokainen myydään erikseen, saatavuus voi vaihdella. / Το καθένα πωλείται ξεχωριστά και ανάλογα με τη διαθεσιμότητα. / Her biri ayrı ayrı ve stoklara bağlı olarak satılır. / 每件单独出售，并且视库存情况而定。それぞれ在庫状況に従って個別に販売されます。 / تبايع كل منها على حدة وتخضع لتوفرها.

TEENAGE MUTANT NINJA

TEENAGE MUTANT NINJA

TURTLES

COLLECT THEM ALL! | COLLECTIONNEZ-LES TOUS! | COLEZIONALOSI! | COLEZIONA COLEZIONAL TUTTI! | COOLER SPIELSPASS MIT ALLEN PRODUKTEN! | ZBIERZ WSZYSTKIE! VERZAMEL ZE ALLEMAAL! | СОБЕРИ ВСЕ! | СЪМАГНИ! | НЕПСИНИ БИРИКТИ | جمعهم كلها



COLLECT & CONNECT! | COLLECTIONNE-LES ET COMBINE-LES!
 ¡COLECCIONA Y CONECTA! | COLECCIONA E UNE!
 COLLEZIONA E COLLEGA! | ZUM SAMMELN UND VERBINDEN!
 ZBIERAJ I ŁĄCZ! | VERZAMEL & COMBINEER! | СОБИРАЙ И
 СОЕДИНЯЙ! | ΚΑΝΤΕ ΣΟΥΠΕΡ ΣΥΛΛΟΓΗ & ΕΝΩΣΤΕ!
 HEPSİNİ BİRİKİTİR VE BİRLEŞTİRİR! | اجمع و وصل!



Each sold separately and subject to availability. / Tous vendus séparément. Certains produits peuvent ne pas être commercialisés. / Se venden por separado y están sujetos a disponibilidad. / Vendidos em separado e sujeitos a disponibilidade. / Ognuno in vendita separatamente secondo disponibilità. / Alle Artikel separat erhältlich. Einige Artikel werden nicht in allen Ländern vertrieben. / Sprzedawane oddzielnie w zależności od dostępności. / Per stuk verkrijgbaar en niet overal leverbaar. / Каждый продукт продается отдельно, в зависимости от наличия. / Sælges separat og så længe lager haves. / Alla delar säljs separat så långt lagret räcker. / Hver leke selges separat så langt lageret rekker. / Jokainen myydyään erikseen, saatavuus voi vaihdella. / Το καθένα πωλείται ξεχωριστά και ανάλογα με τη διαθεσιμότητα. / Her biri ayrı ayrı ve stoklara bağlı olarak satılır. / 每件单独出售，并且视库存情况而定。それぞれ在庫状況に従って個別に販売されず。 / تباع كل منها على حدة وتخضع لتوفرها.

MEGA CONSTRUX™

Build Beyond™

Au-delà de la construction!

¡Construye sin límites!

Mais do que Construção!

Costruisci oltre ogni limite!

Es gibt keine Grenzen!

Więcej niż budowanie!

Meer dan alleen bouwen!

Больше, чем конструктор!

Χτίσε έναν ολόκληρο κόσμο!

Hayallerini İnşa Et!

لنبني .. وأكثر!

Printed in Canada D-FFC54-01
©2017, MEGA Brands Inc. &™ MEGA Brands Inc. CONSTRUX™ is owned by Mattel
and used under license. CONSTRUX™ appartient à Mattel et est utilisée sous licence.



play.megaconstrux.com

