

**MEGA
CONSTRUX™**

 American Girl®

**SANCTUAIRE
DE LA FORÊT
TROPICALE
2 EN 1 DE LEA**

FDY98

COMMENÇONS

C'EST LE MOMENT DE
CRÉER TON HISTOIRE



P.3

COMMENCE PETIT,
PUIS CONSTRUIS GRAND!



P.5

CHOISIS UNE SCÈNE À CONSTRUIRE



P.36

LE REFUGE POUR
ANIMAUX DE LEA



P.38

LE SAUVETAGE À LA TOUR
DE GUET DE LEA



P.76

LES ACTIVITÉS DE LEA



P.108

C'EST LE MOMENT DE CRÉER TON HISTOIRE

L'aventure commence lorsque tu ouvres la boîte. Trouve tout ce dont tu as besoin pour créer ton histoire, et prépare-toi à construire!



Retire tous les sacs de pièces de la boîte – tu es presque prête à commencer à construire.

Organisons d'abord le tout ! Sors toutes les pièces des sacs et dispose-les où tu peux toutes les voir. Fais attention de ne pas en perdre.

Tire la languette pour sortir ta mini-figurine American Girl de la fenêtre.

TA FIGURINE À ASSEMBLER



SAVAIS-TU QUE TU PEUX PERSONNALISER TES MINI-FIGURINES AMERICAN GIRL?

Collectionne-les toutes, puis combine les pièces de chacune pour les personnaliser. Avec les pièces et accessoires différents, change leur look et leur style. Tu peux même créer de nouveaux personnages qui vous ressemblent, à toi et à tes amies!

Produits vendus séparément, selon la disponibilité.





Voici Lea!

La Fillette de l'année Lea Clark est impatiente de vivre de grandes aventures! Quand sa famille se rend au Brésil, Lea fait du bénévolat à un refuge pour animaux, où elle s'occupe des animaux exotiques. Parfois, elle va dans la forêt tropicale pour sauver les animaux dans le besoin!

COMMENCE PETIT, PUIS CONSTRUIS GRAND!

Commence par construire les pièces que tu utiliseras pour Le Refuge pour animaux de Lea et Le Sauvetage à la tour de guet de Lea.

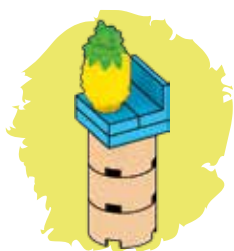

Construis cette table haute et ajoute un ananas.

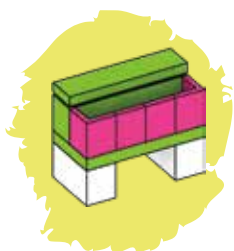
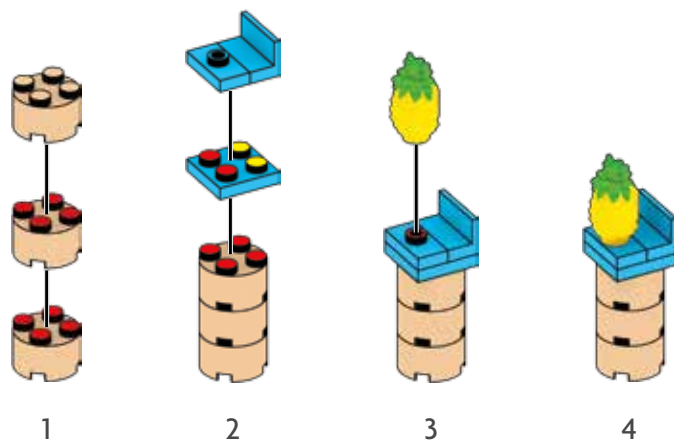
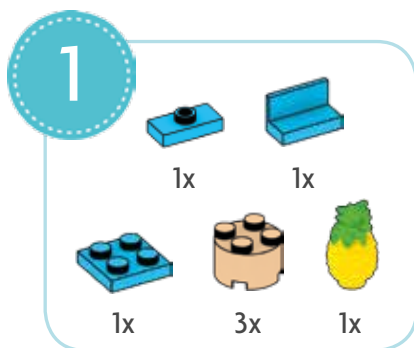

Il s'agit d'un porte-revues qui ira dans le hall du refuge. Lea peut lire sur tous les animaux!

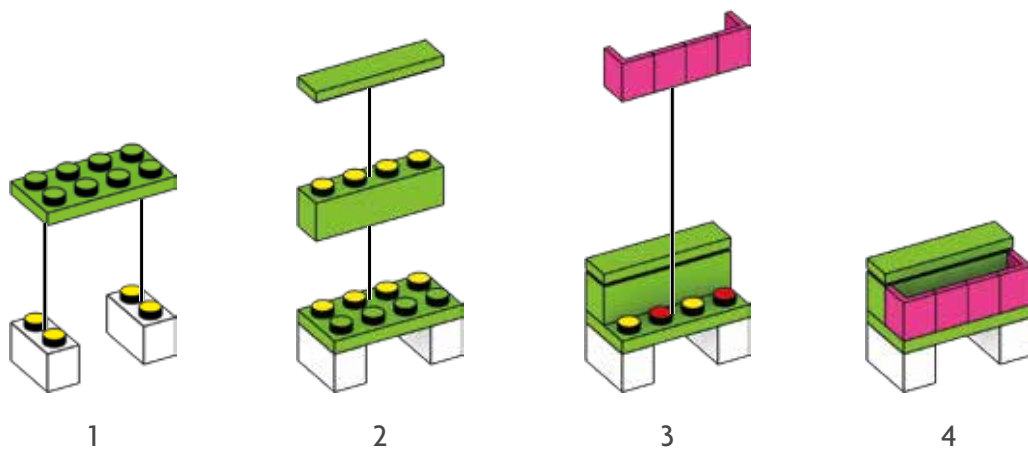
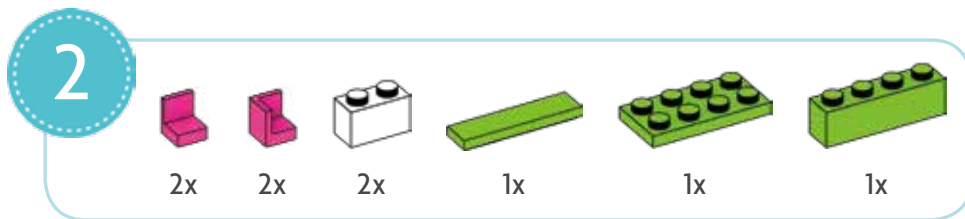

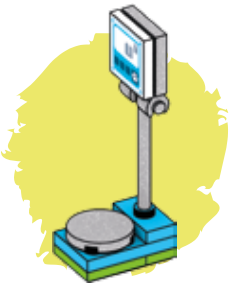

Construis une balance pour permettre à Lea de vérifier le poids des animaux.

3

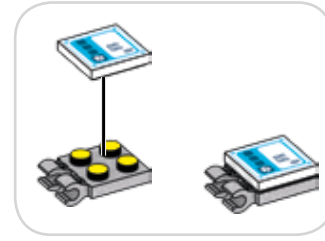
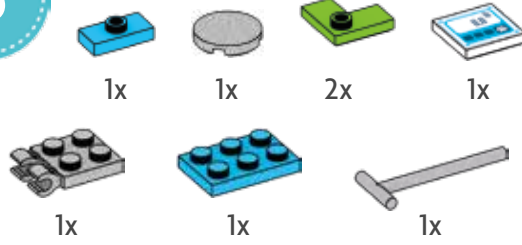

1



2

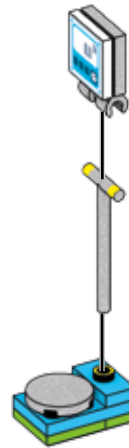

3



4



Lea adore la photographie! Construire son appareil-photo est très facile.

4

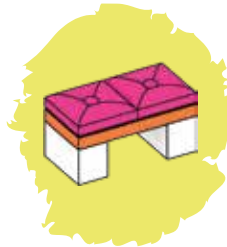

Construis un banc confortable.

5

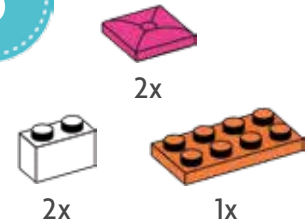

1



2

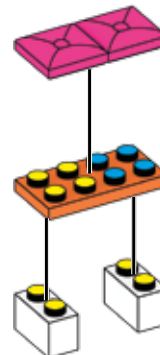

1



2



Il fait chaud!
 Construis un évier et
 un robinet pour que
 Lea garde les animaux
 propres et abreuvés.

6

2x

1x

7

2x

2x

8

1x

1x

2x

1x

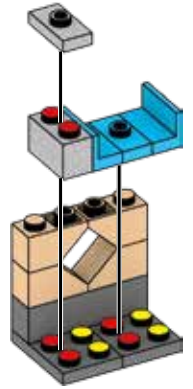
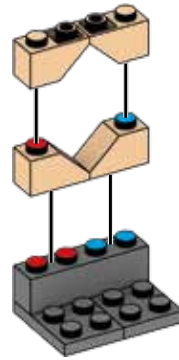

9

1x

1x

1x

10

1x

1x

11

1x

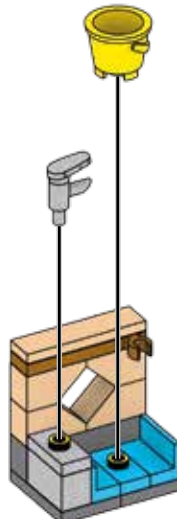
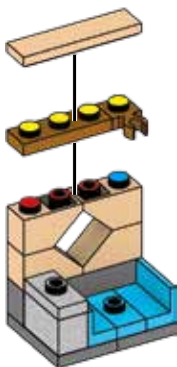

1

2



Construis un véhicule de sauvetage! Lea et le vétérinaire ont besoin d'explorer la forêt tropicale profonde.

12

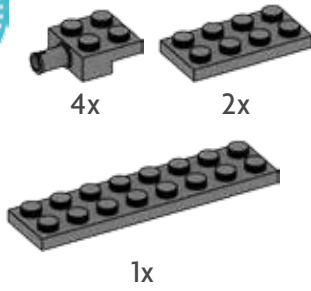

13

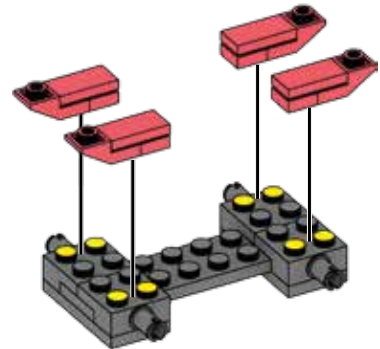
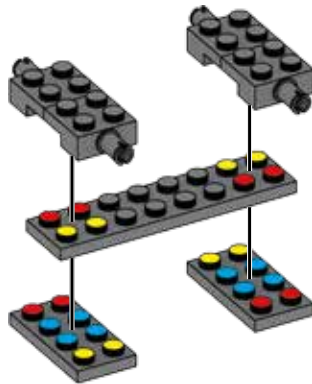
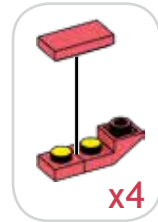

14

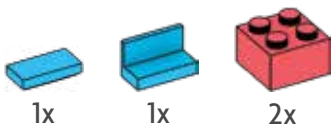

15

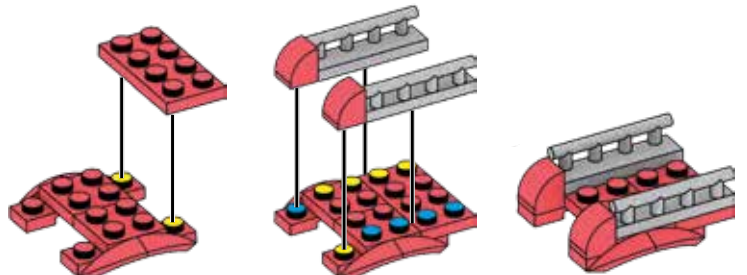
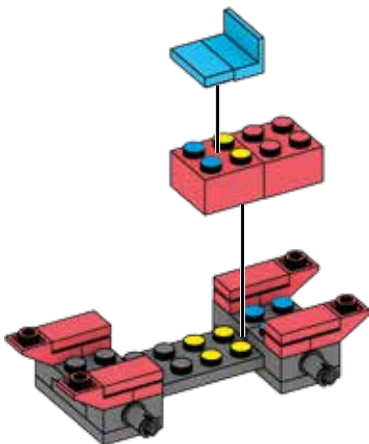
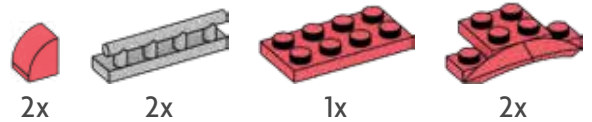

1

2

3



16

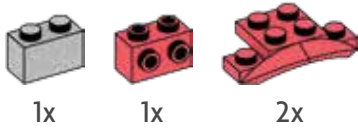

1x

1x

2x

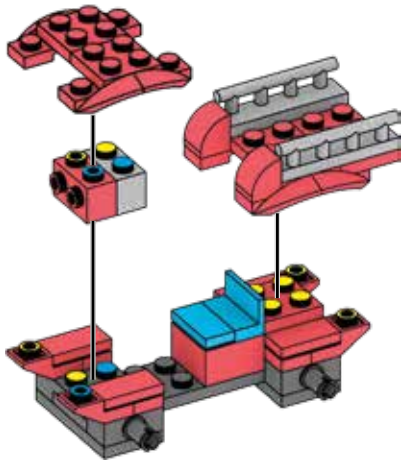

17



1x

1x

1x

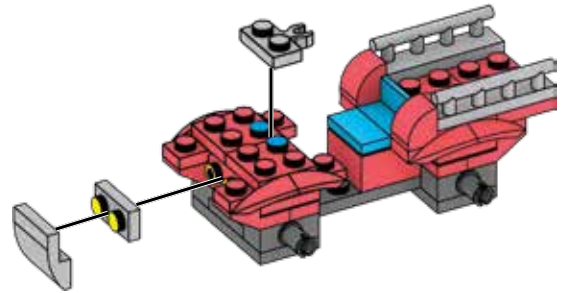

18



2x

2x

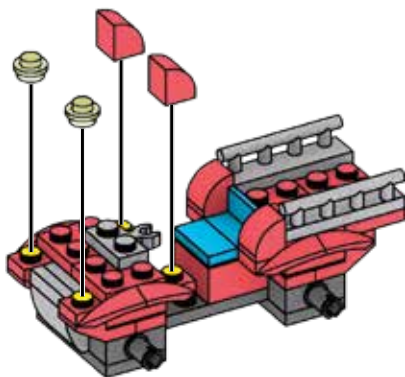

19

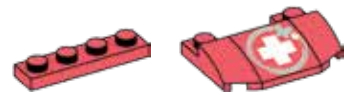

1x

1x

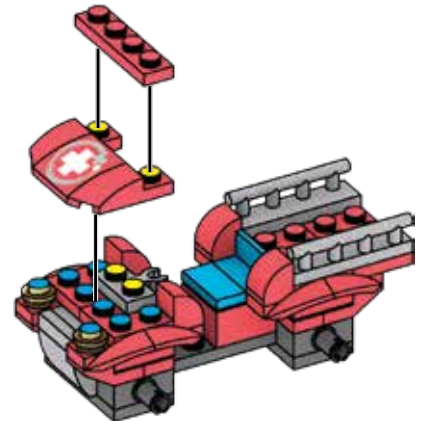



20

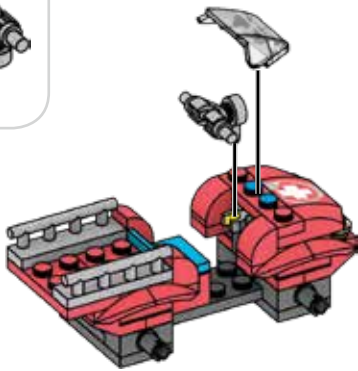
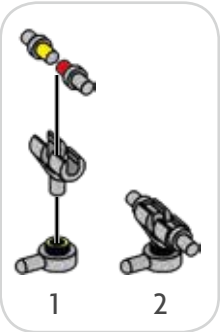
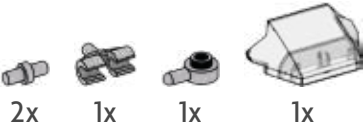

21

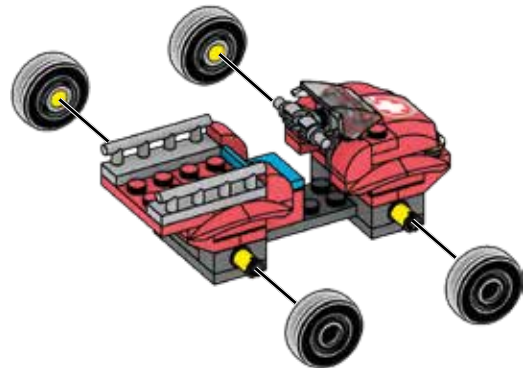

22

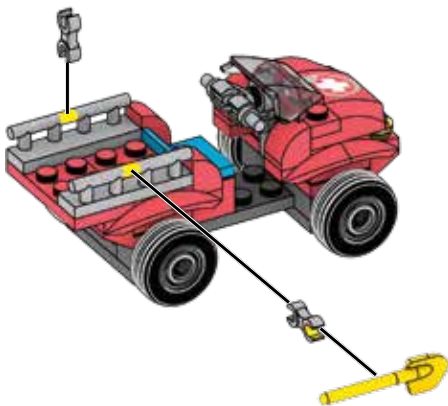
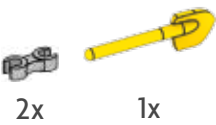

23

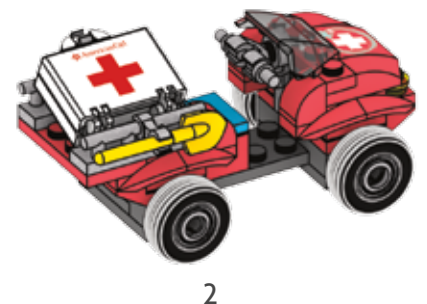
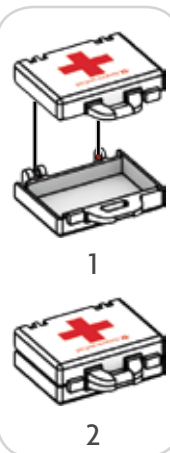
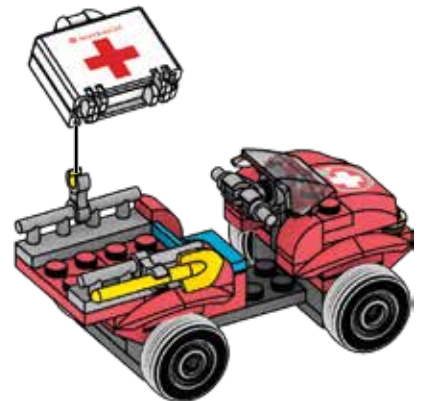
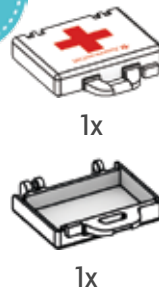



Avec un ordinateur portable et un poste de travail, Lea peut faire le suivi de la santé de ses patients animaux.

24

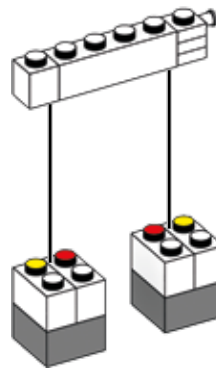
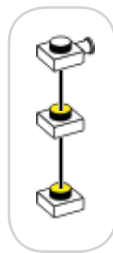
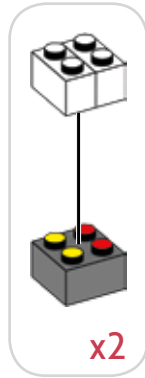
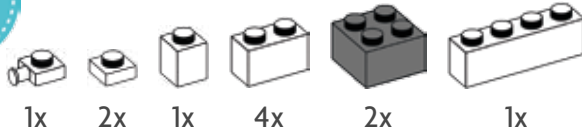

25

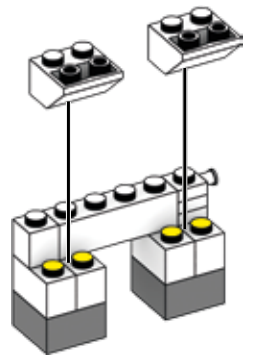

26



1x



1x



1x

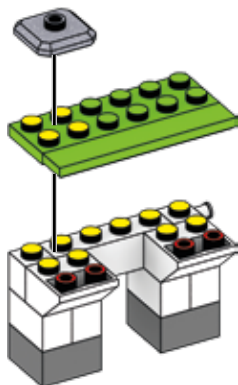

27



1x



1x

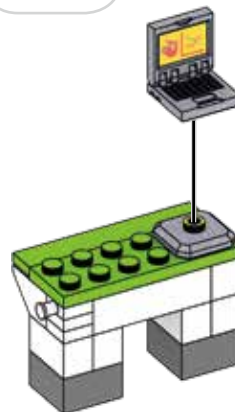

1



2



28



1x



1x



1x



1x



1x



4x



4x



1x

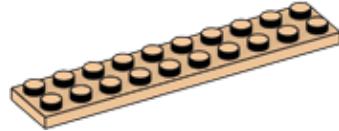

1x

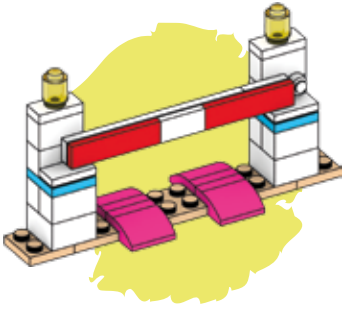

Construis la barrière.
Elle s'ouvre vraiment!



1

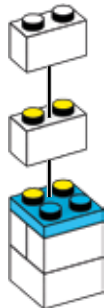

2

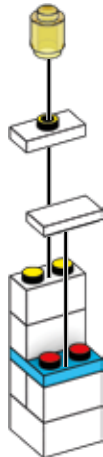

3

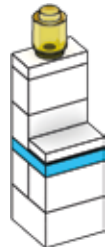

4

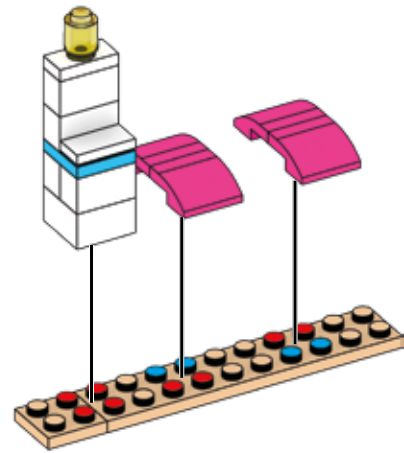

29



1x



1x



1x



1x



1x



2x

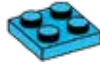

1x



1x



3x



1x



1

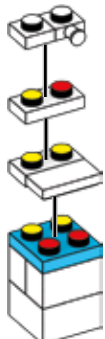

2



3



4

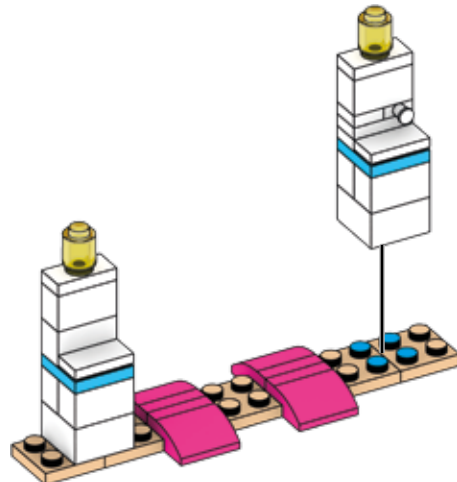



30

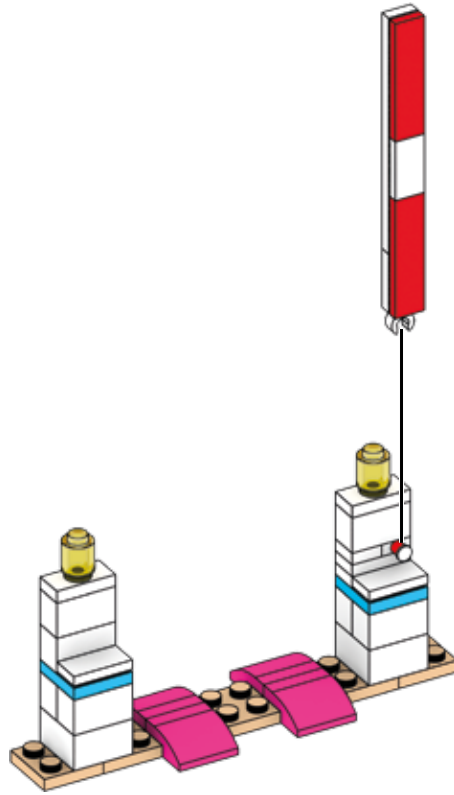
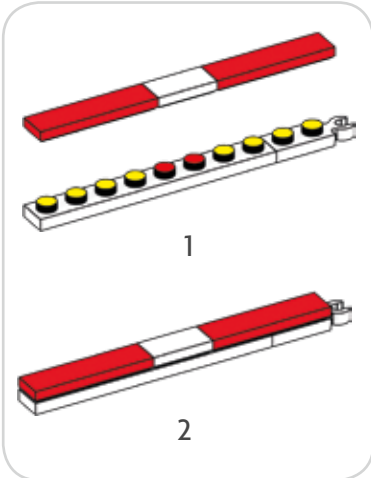
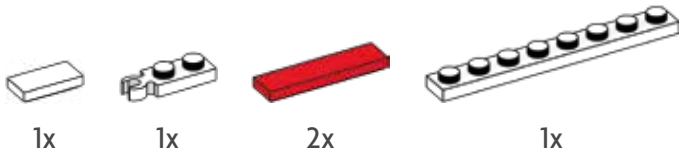

1

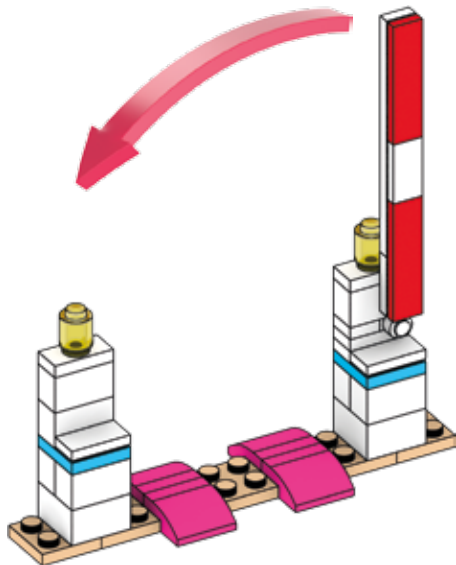

2

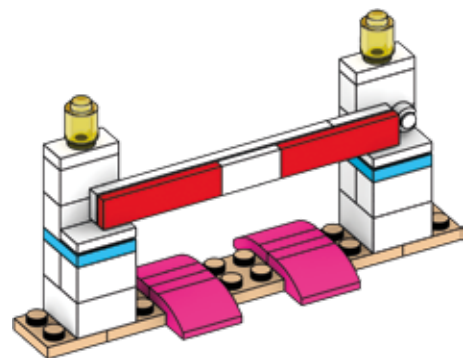

3

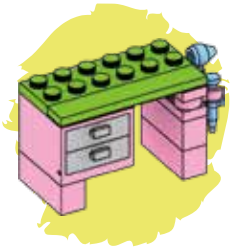

31

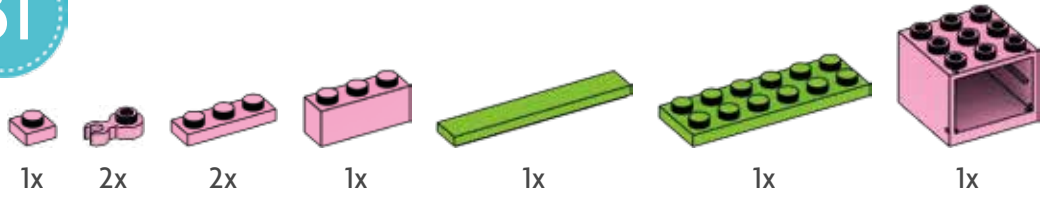

Construis une table d'examen pour le bureau du vétérinaire.

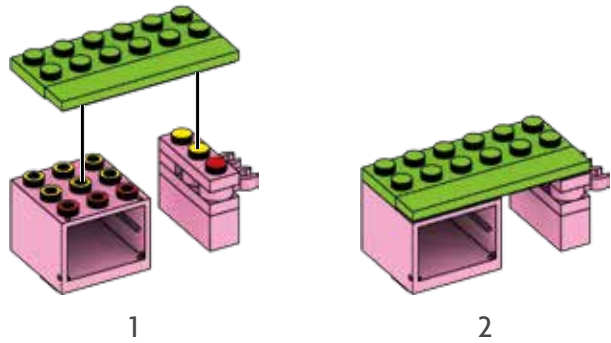
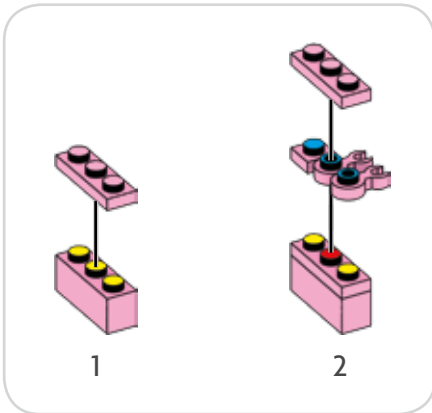

32

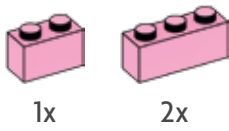

33

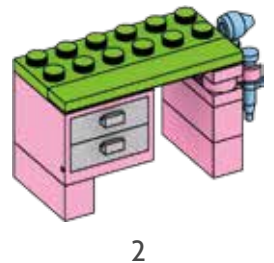
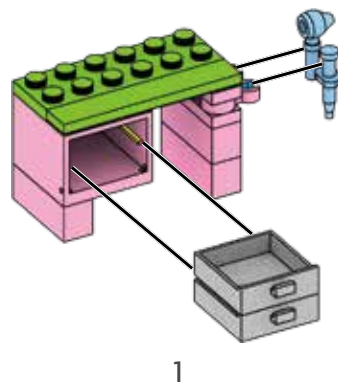
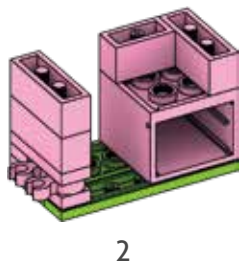
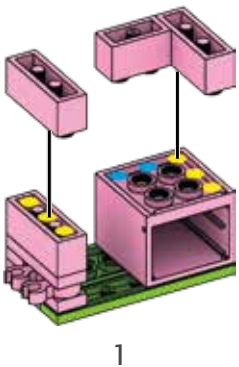
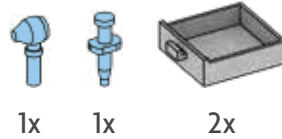

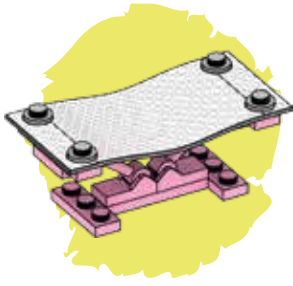

34

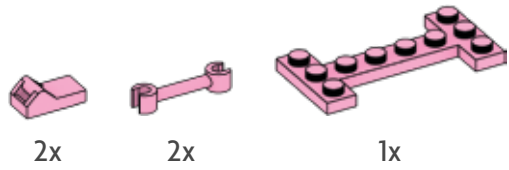

Lea et les animaux aiment se reposer dans ce hamac!

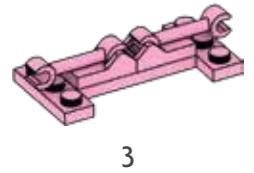
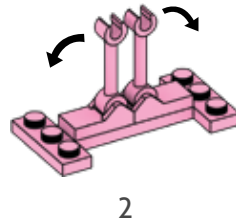
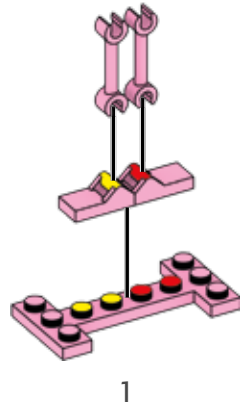

35

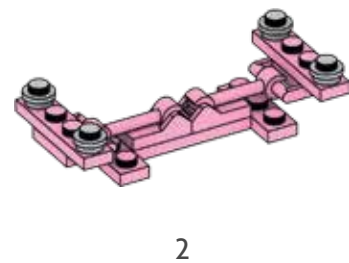
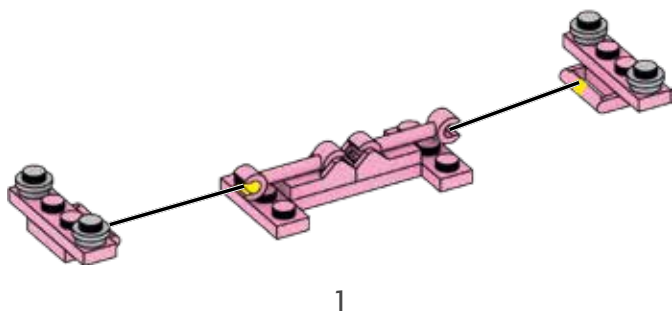
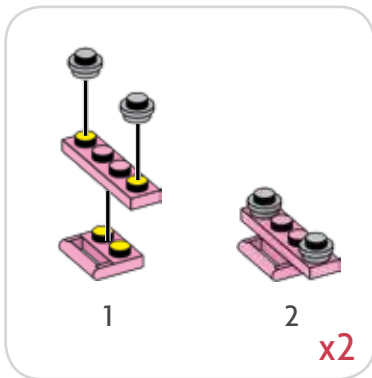
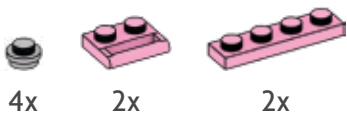



36



1x

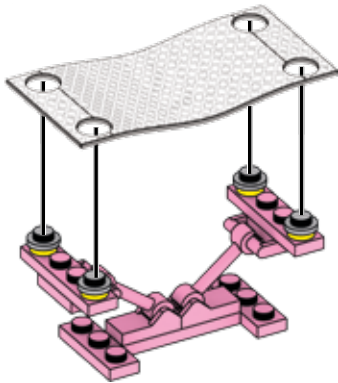

1

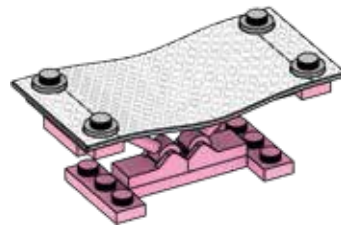

2



CONSEIL UTILE

Ajoute le maillage au hamac en alignant ses quatre trous avec les quatre chevilles sur le dessous du hamac. Étire un trou de maille sur la cheville pour l'adapter. Répète pour les 3 autres chevilles. C'est facile!





37

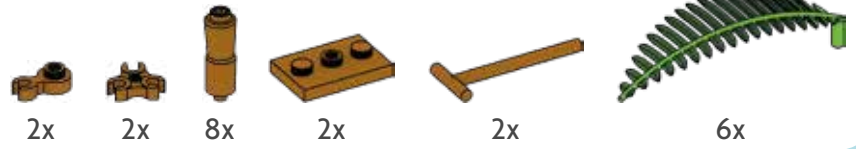

Construis les palmiers pour ta scène!



Ajoute quelques arbustes où les animaux peuvent se cacher.

38

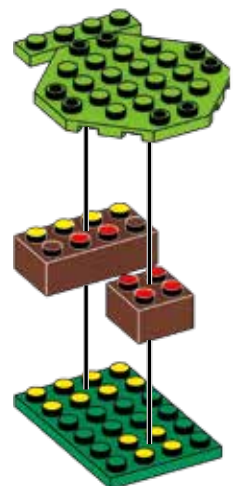
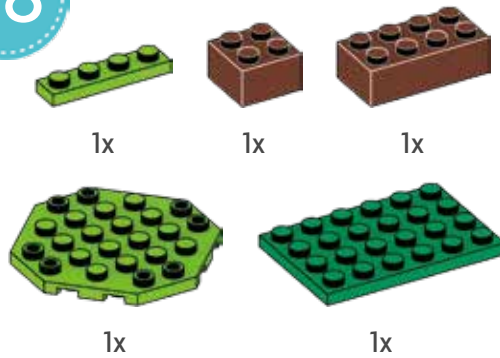



39

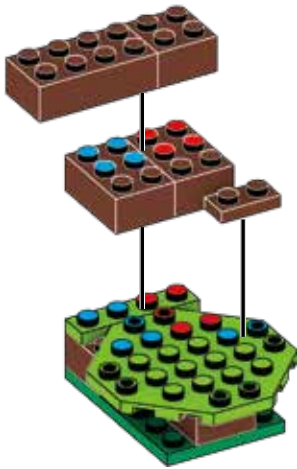
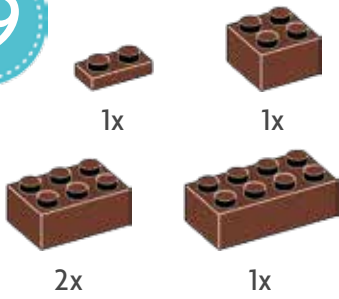

40

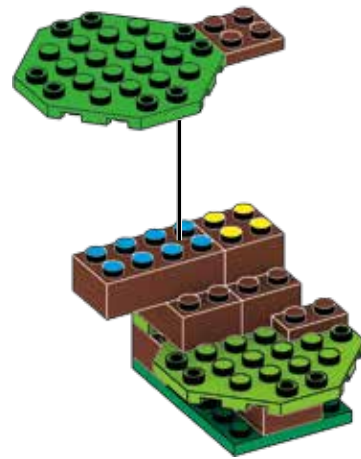
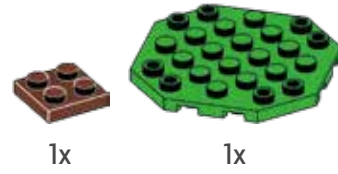

CONSEIL UTILE

C'est le moment de planter!
La construction de cet arbuste exige un empilage. Placer le bloc de feuille verte à mi-chemin sur le bloc brun pour le placer sur le bord. Appuie ensuite fermement vers le bas pour le verrouiller en place. C'est superbe!





41



1x



1x



1x

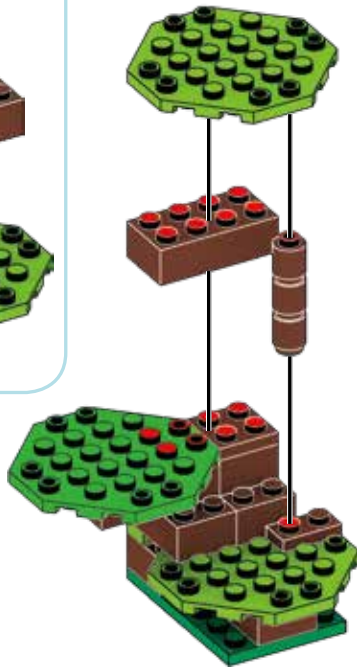

42



2x



1

2

43



1x



1x



1x



1x



1x



1



2



3

Construis un bain d'oiseau pour que les amis à plumes de Lea puissent se rafraîchir.

44

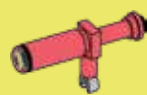

Construis le télescope.



1x



1x



1x



1x



1x



1x

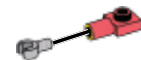

1



2

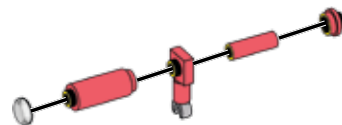

1

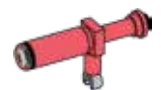

2



45



2x



4x



Construis l'entrée.
Bienvenue!

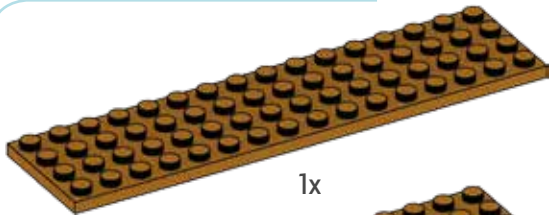

1x

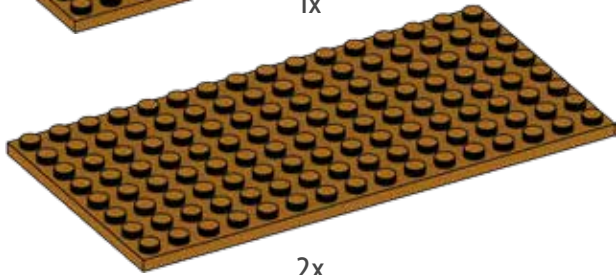

2x

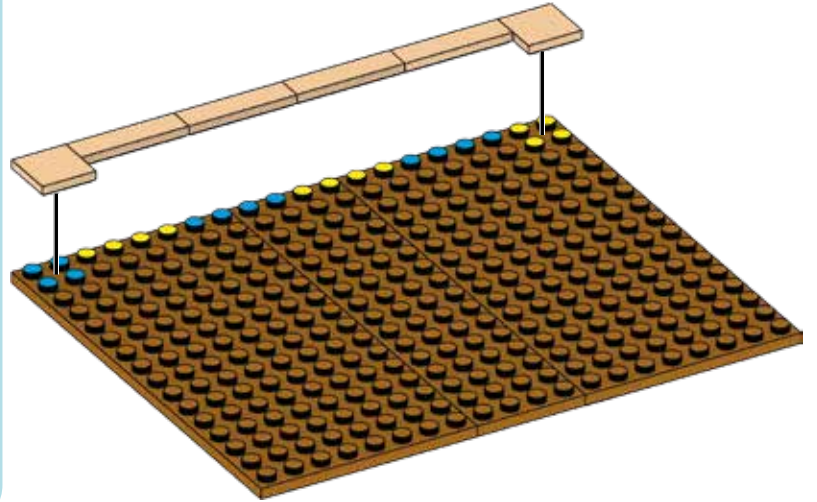

46



2x



1x

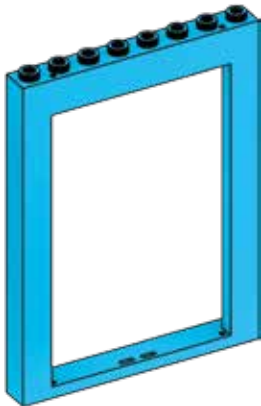

1x

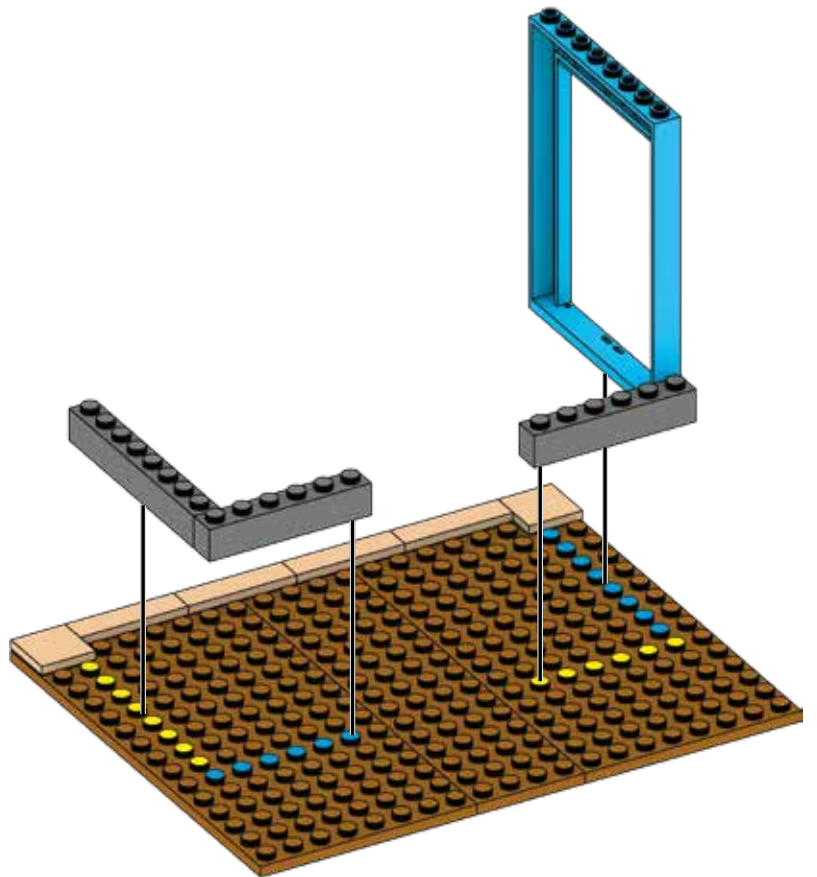



47



2x

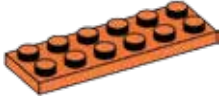

1x

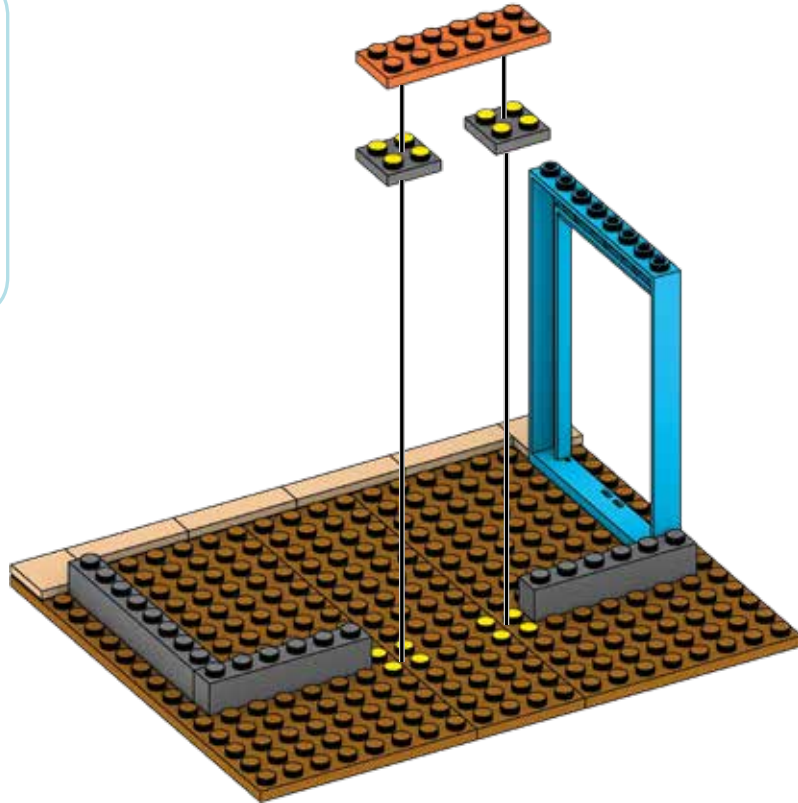

48



2x



2x

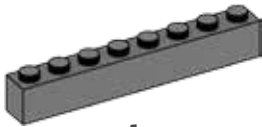

1x

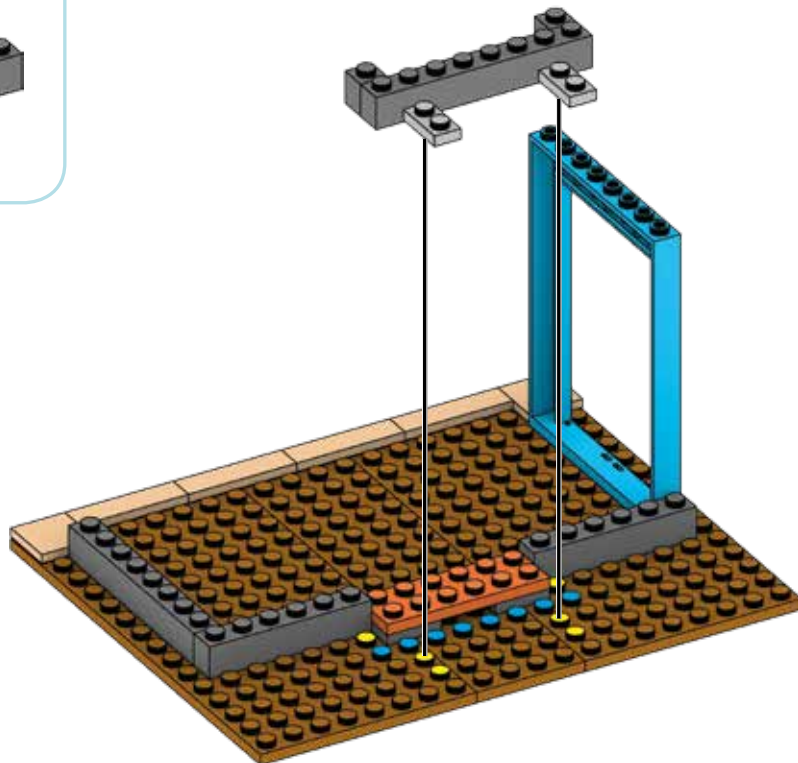



49



2x

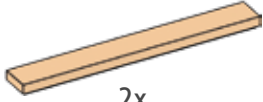

2x

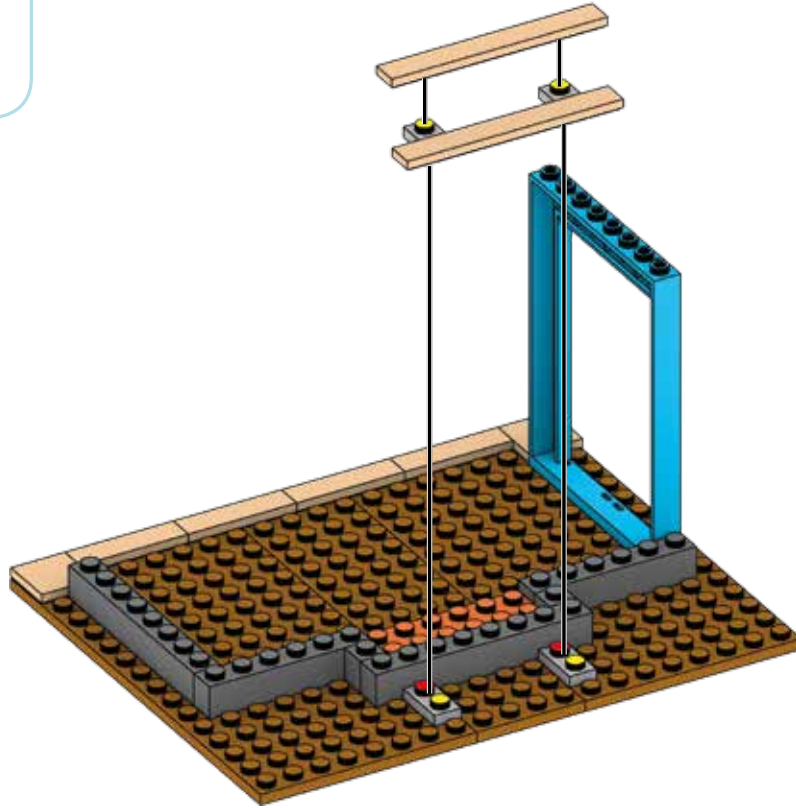

50



4x



2x

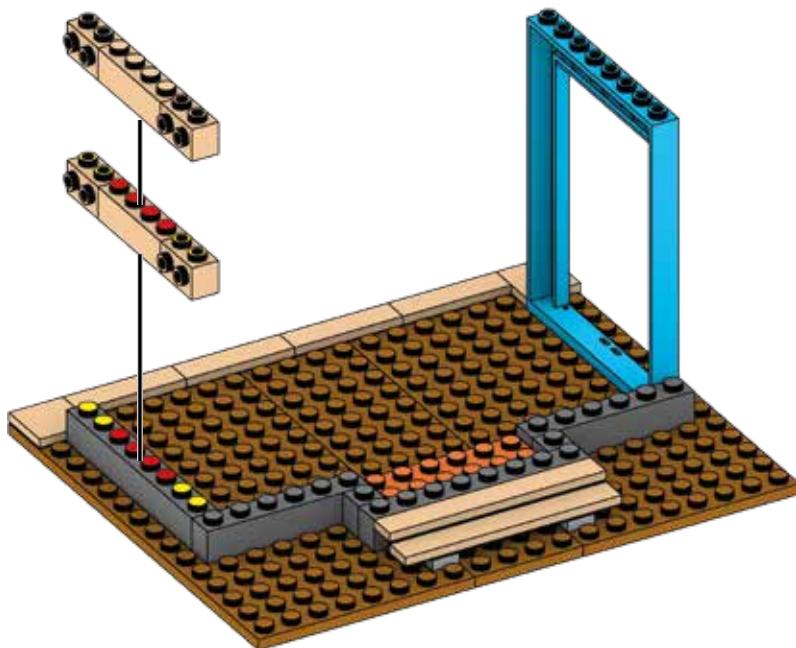



51

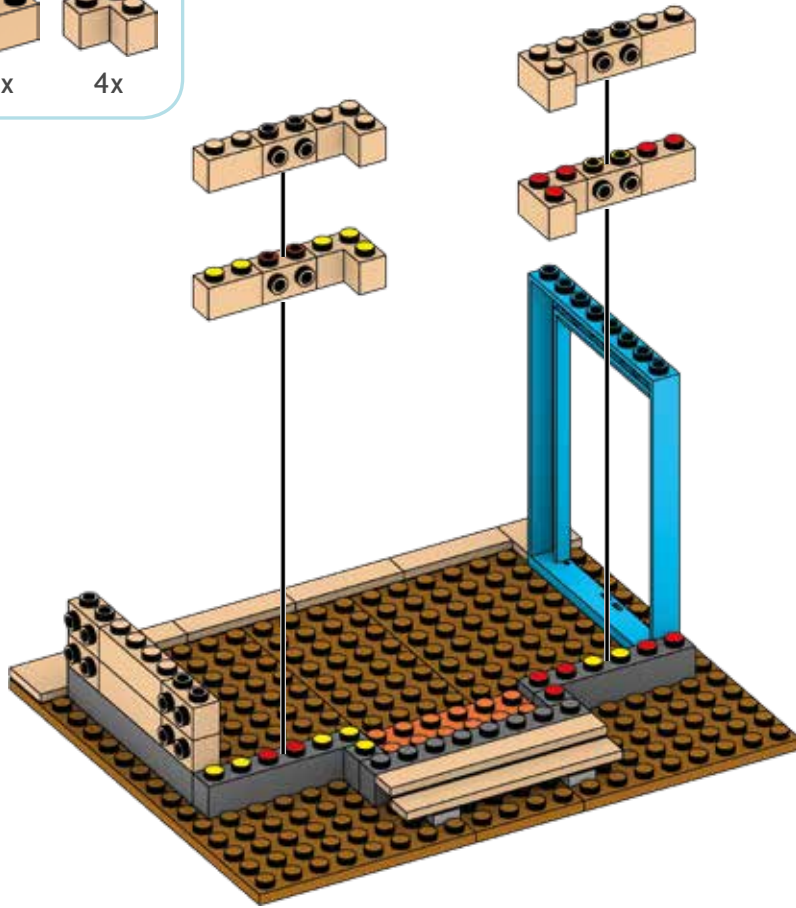

52

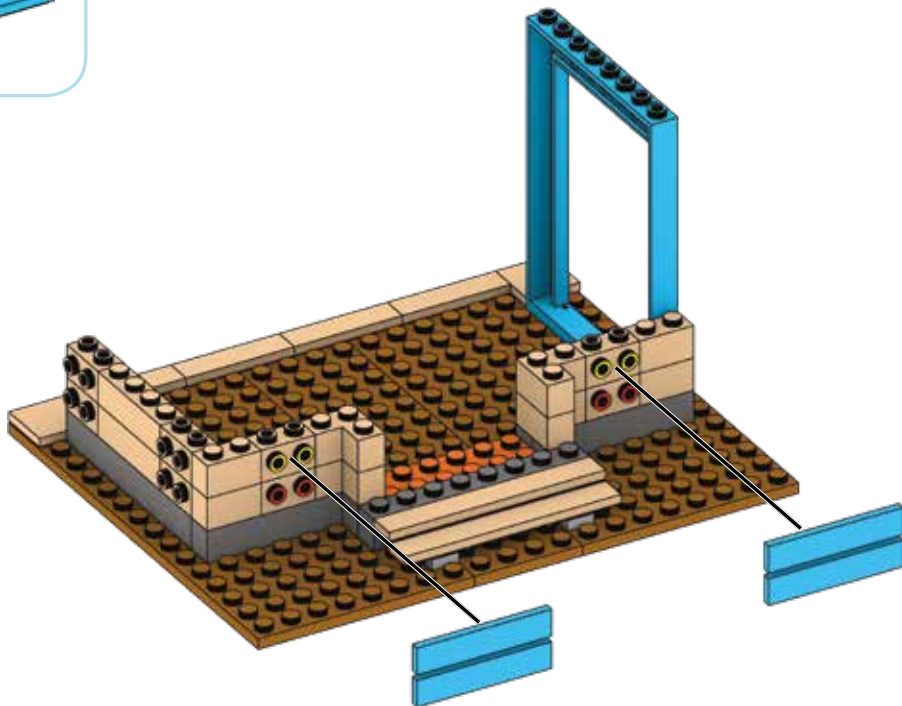
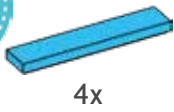



53



1x



2x

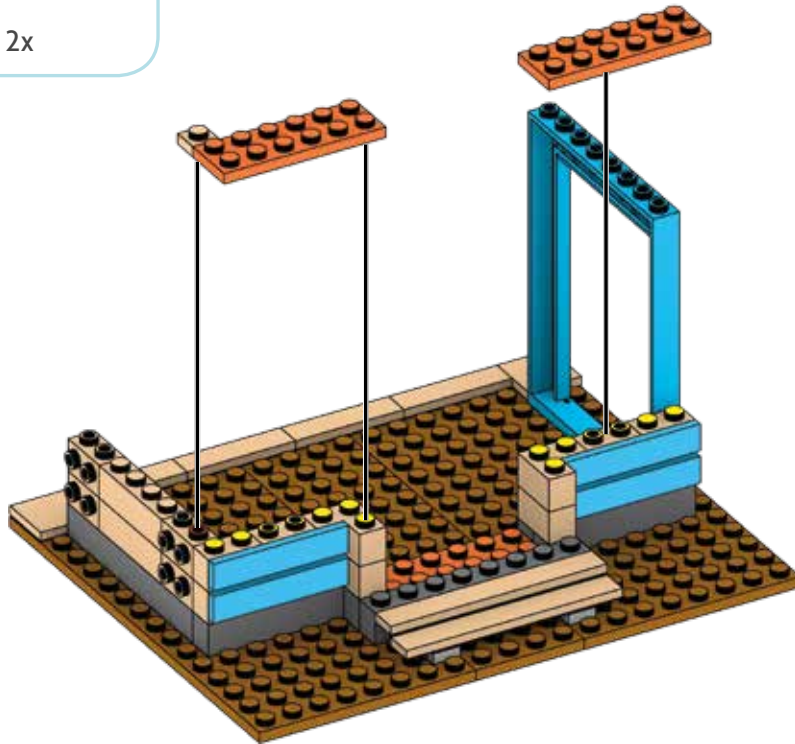

54



1x



1x

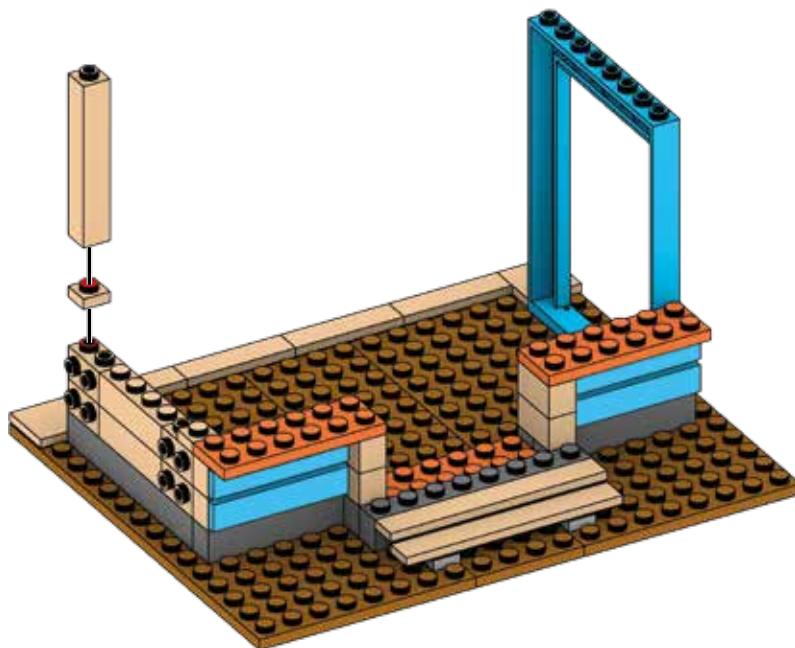



55



1x



1x

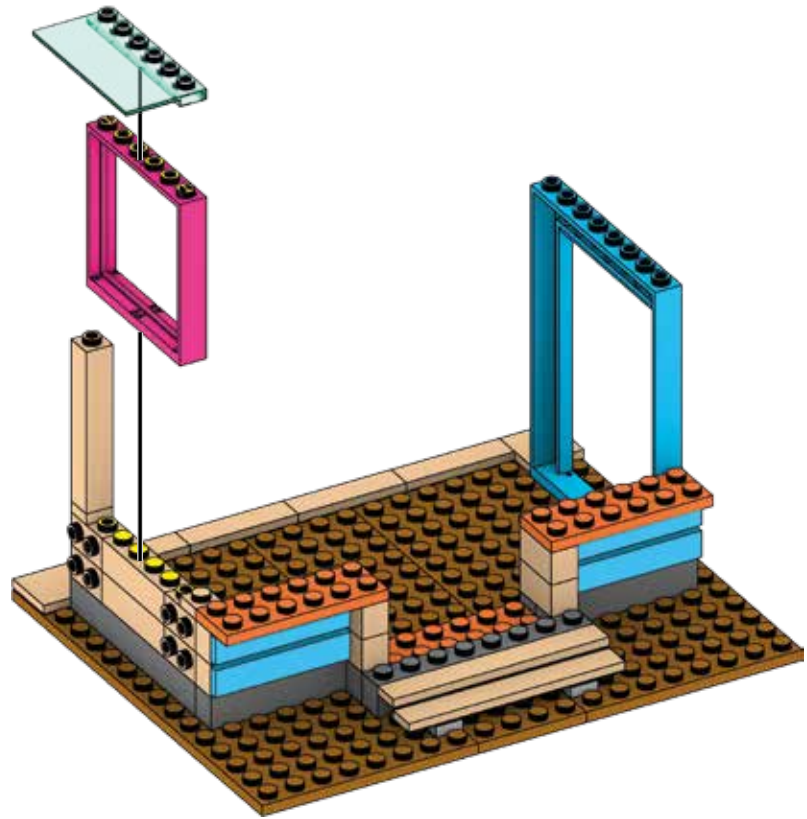

56



1x



1x



1x

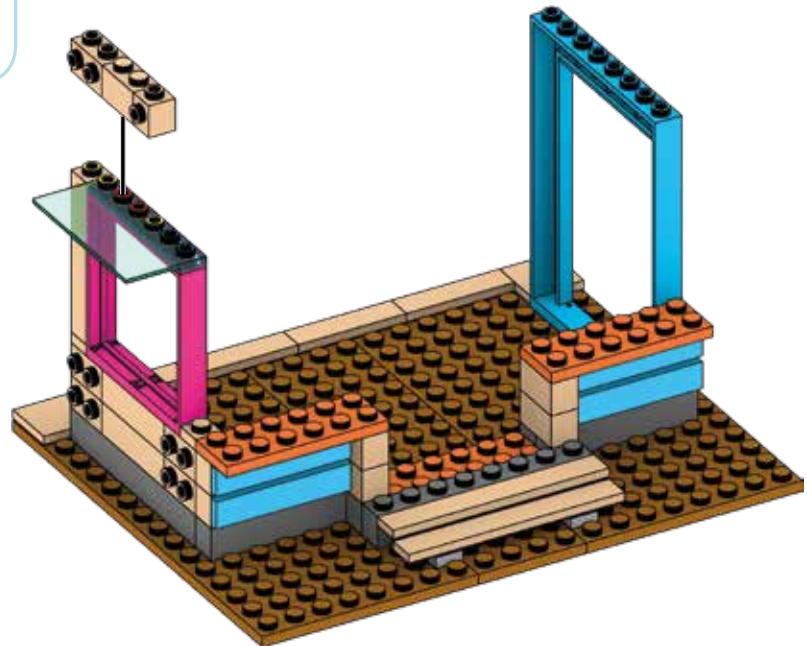



57

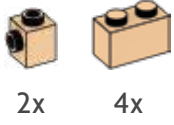

2x

4x

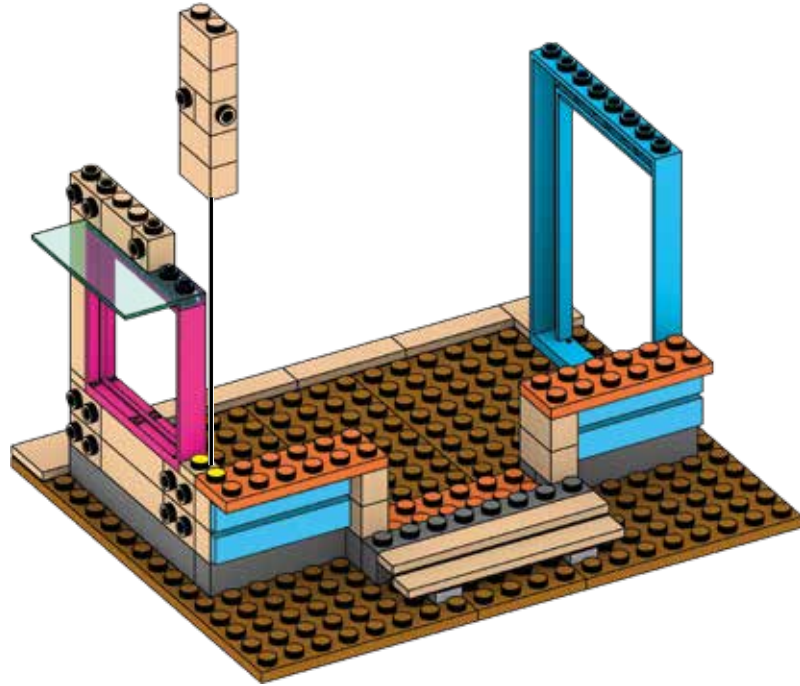
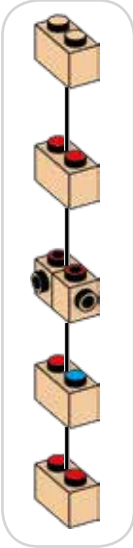

58

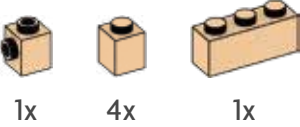

1x

4x

1x

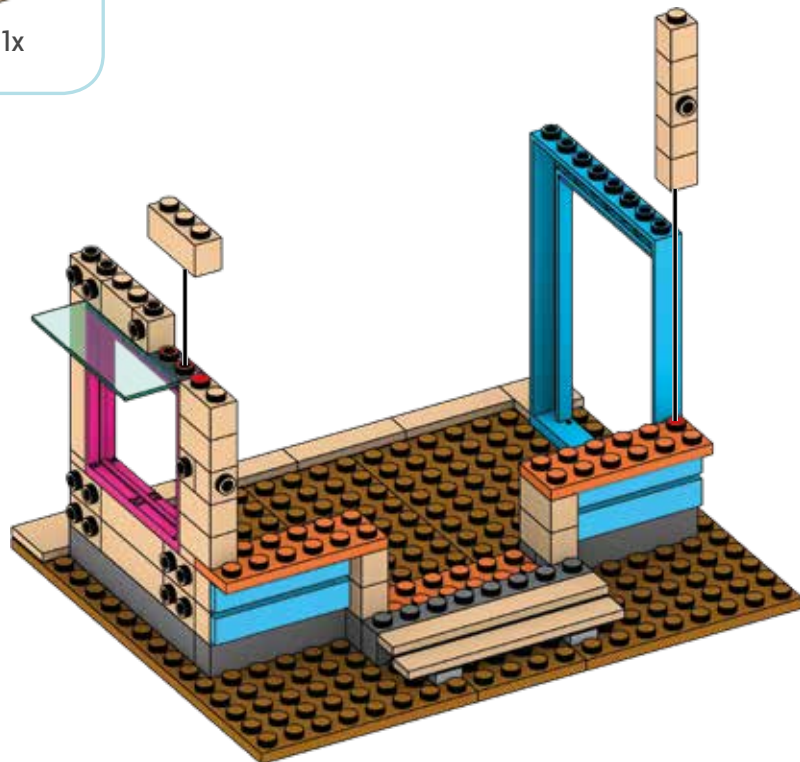
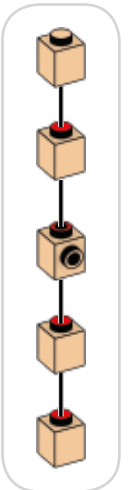



59



2x

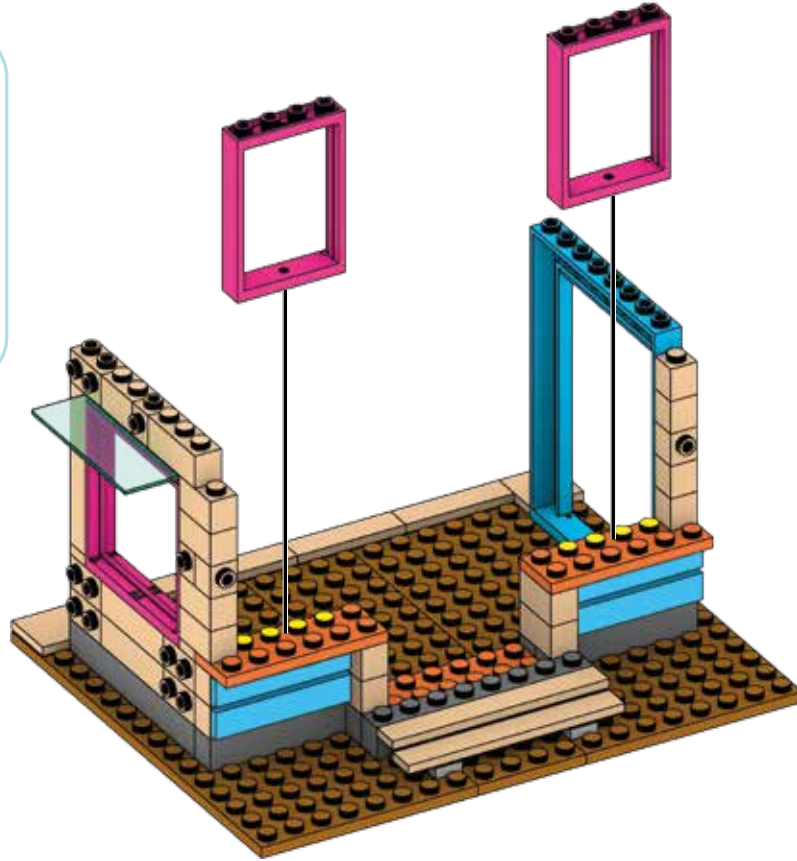

60



10x



x2

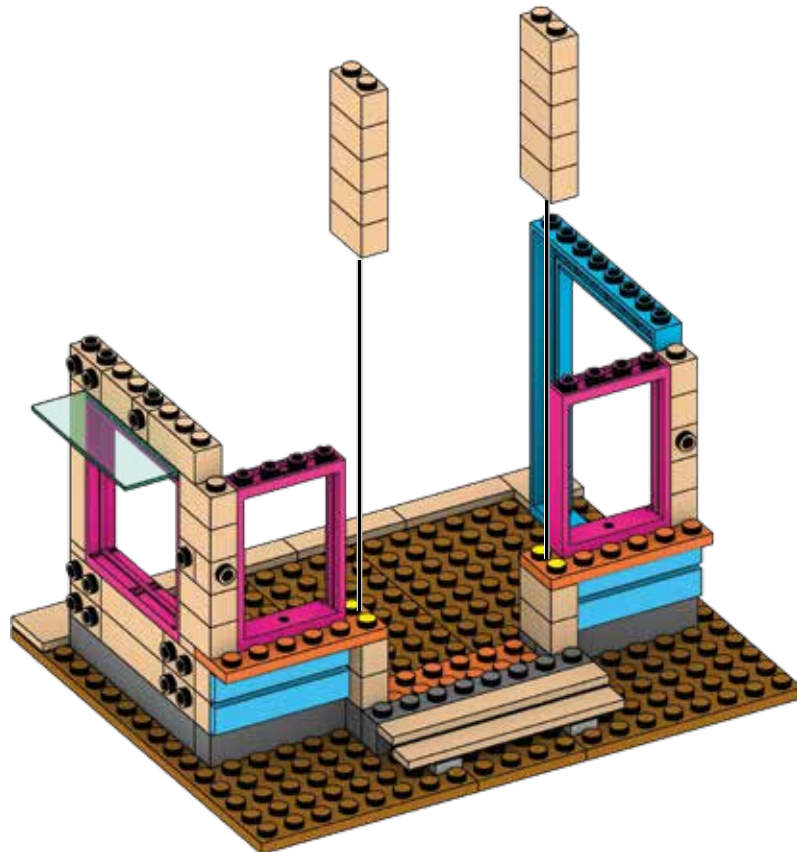



61



2x

2x

2x

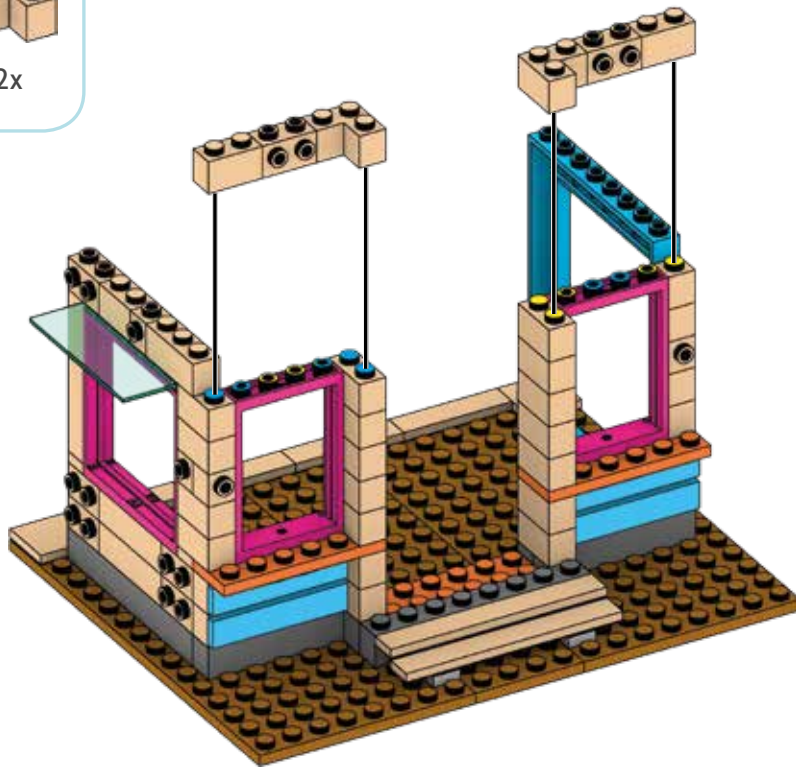

62



2x

2x

1x

2x

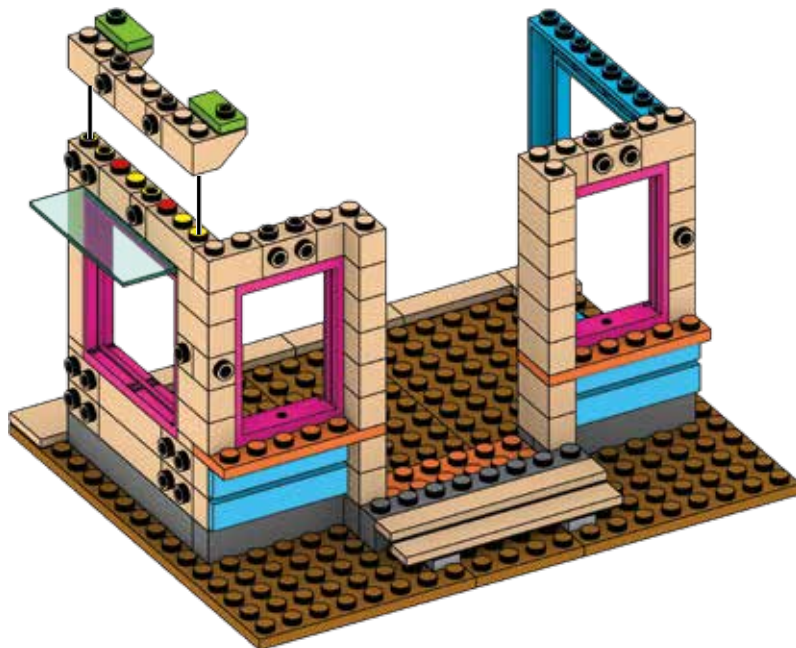
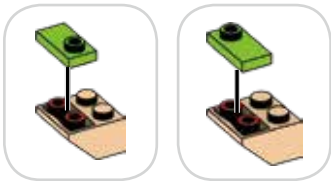



63

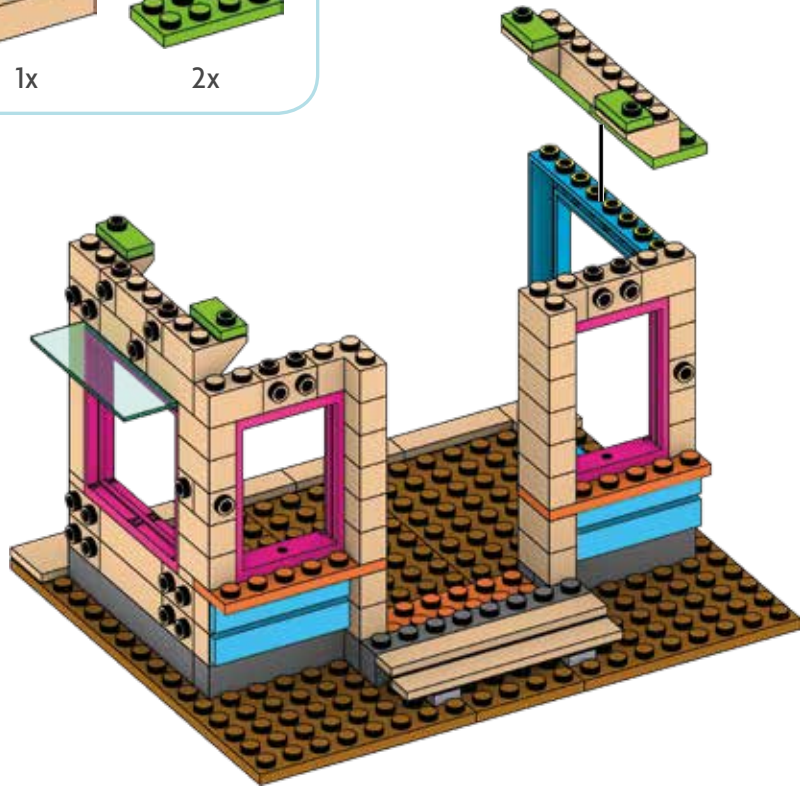
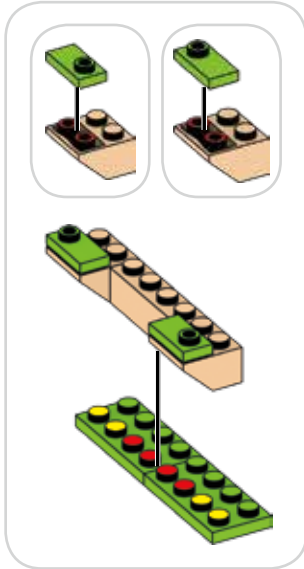
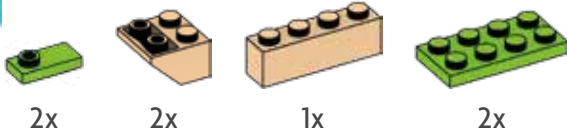

CONSEIL UTILE

Mettons un toit au-dessus de la tête de Lea! Place les blocs beiges utilisés pour construire le surplomb de la porte directement en ligne avec le cadre de porte, orientés vers l'intérieur. Veille à tenir solidement le cadre de porte pendant que tu les poses. Beau travail!

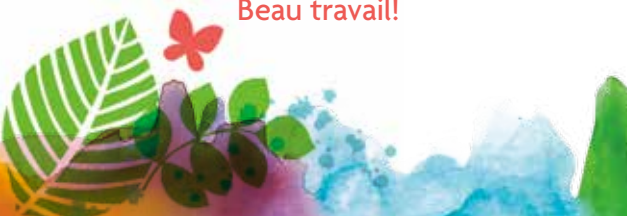



64



1x



1x



4x



2x

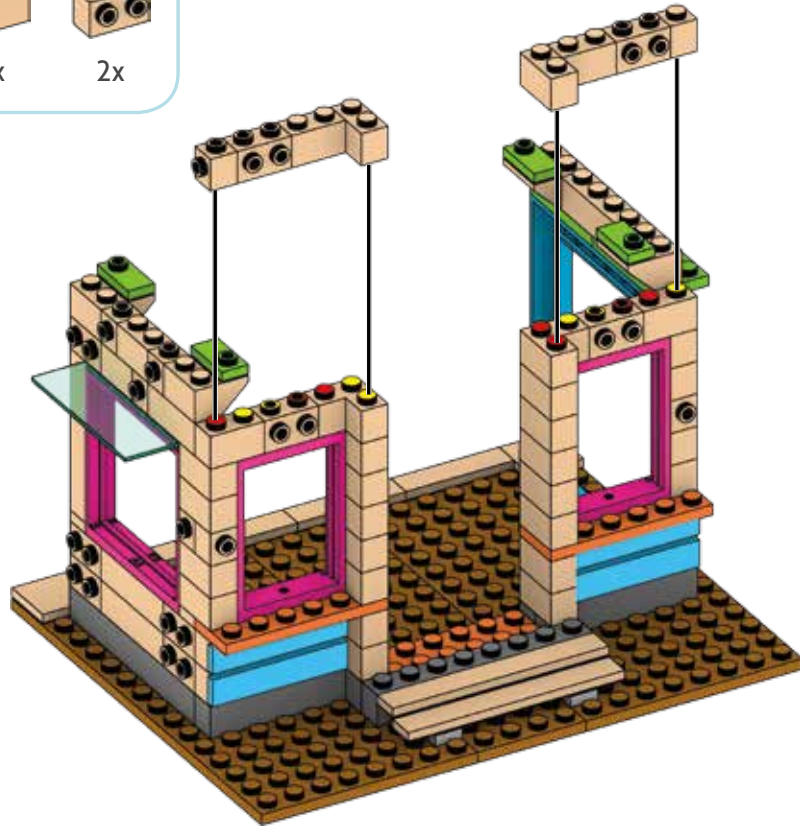

65



2x



2x

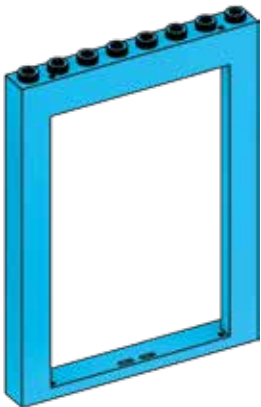

1x

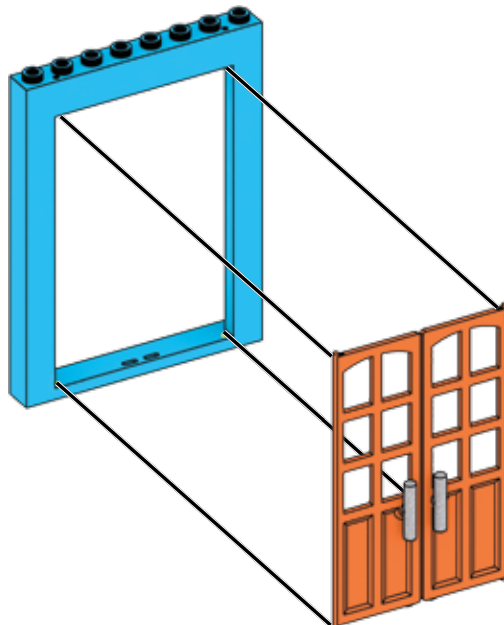
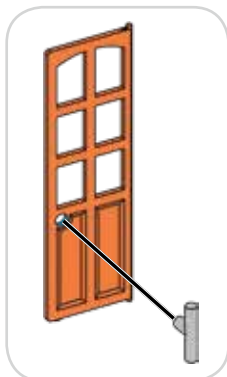
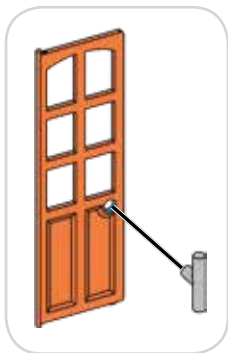



66

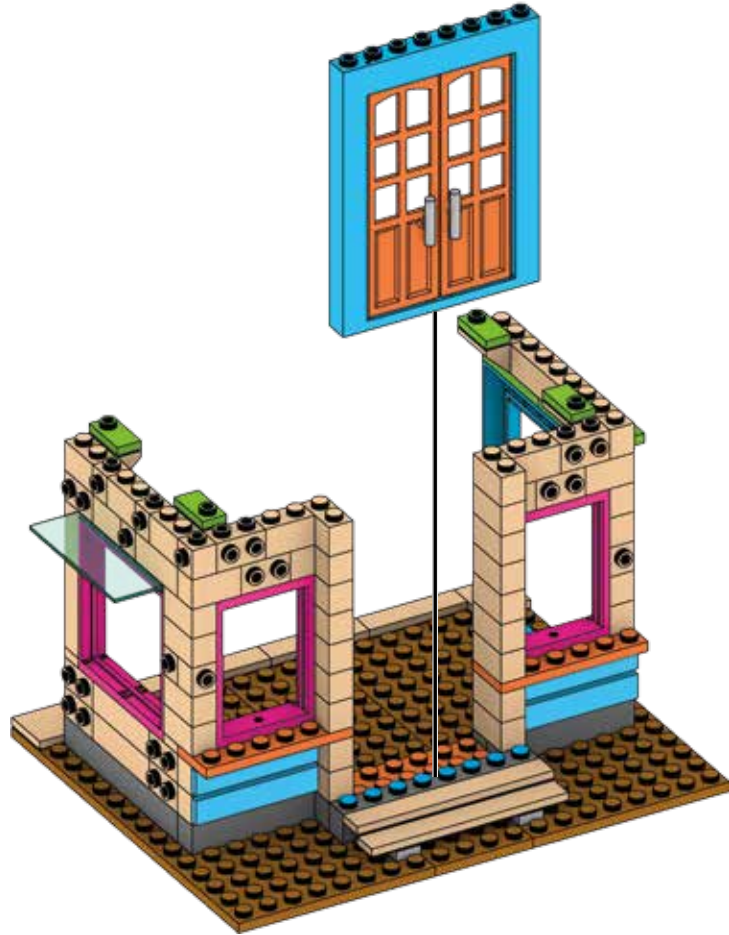

67



2x



4x



2x

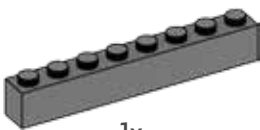

1x





68



4x



69



2x

1x





70



4x

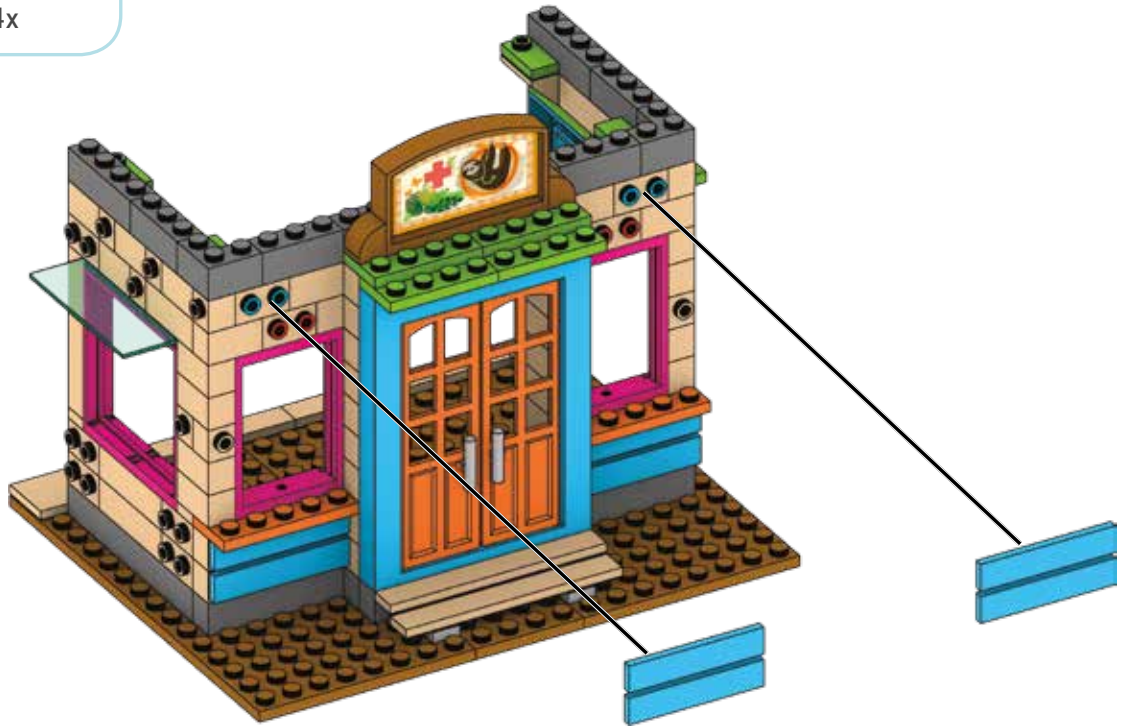

CONSEIL UTILE

Veille à tenir solidement le bâtiment lorsque tu poses les blocs bleus sur l'avant de la maison. On dirait que tu as construit un refuge solide!





71

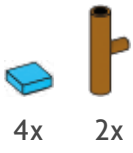

4x

2x

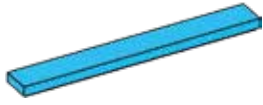

4x

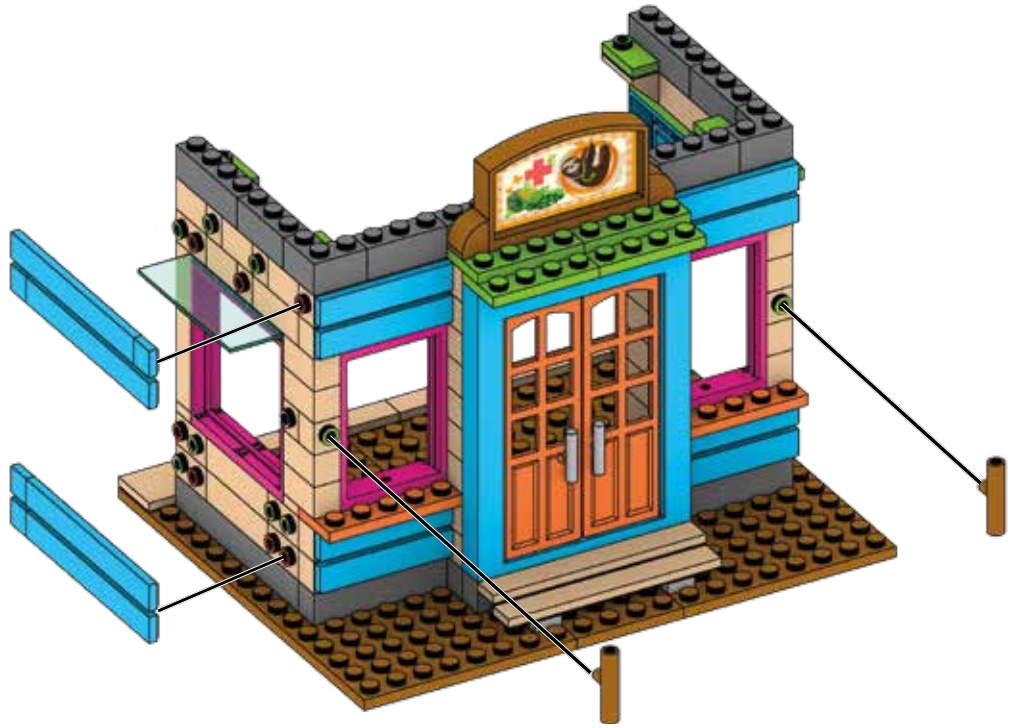

72

2

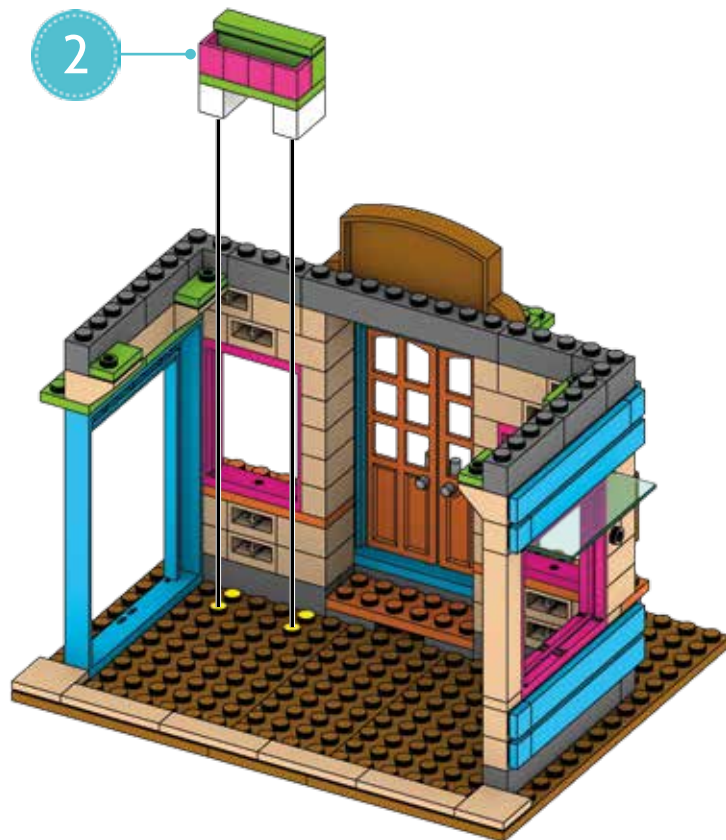



73



1x

1x

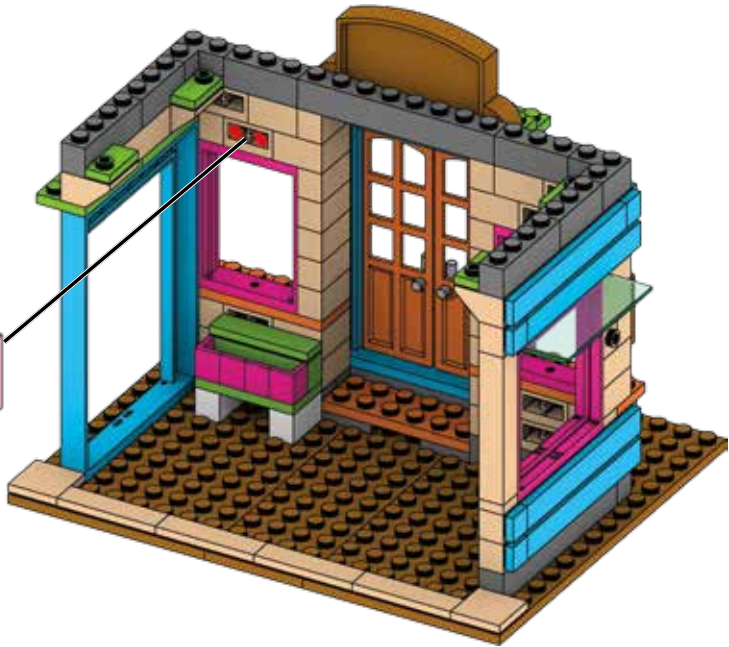
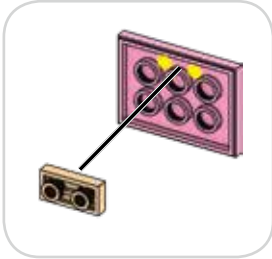

74



1x

1x

1x

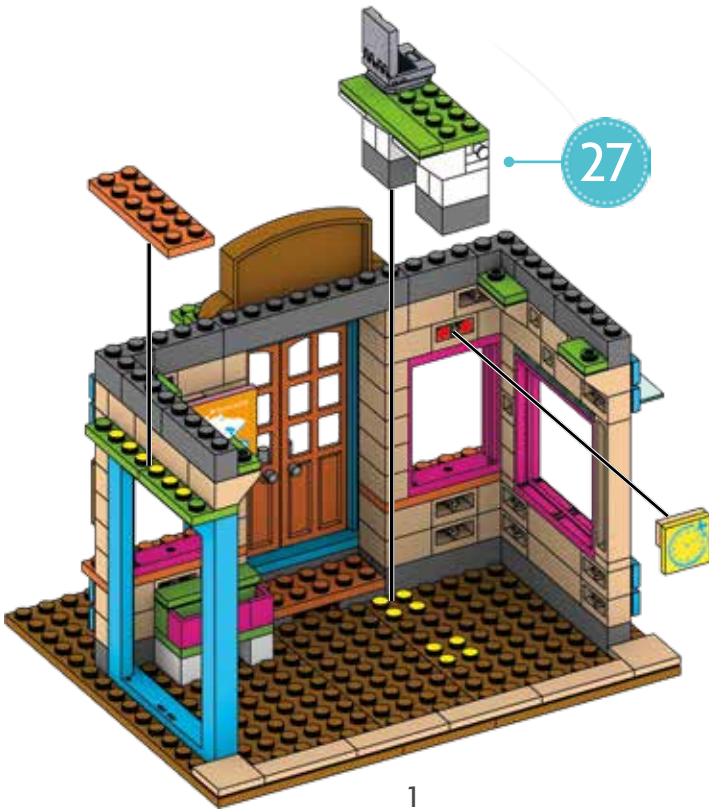

1

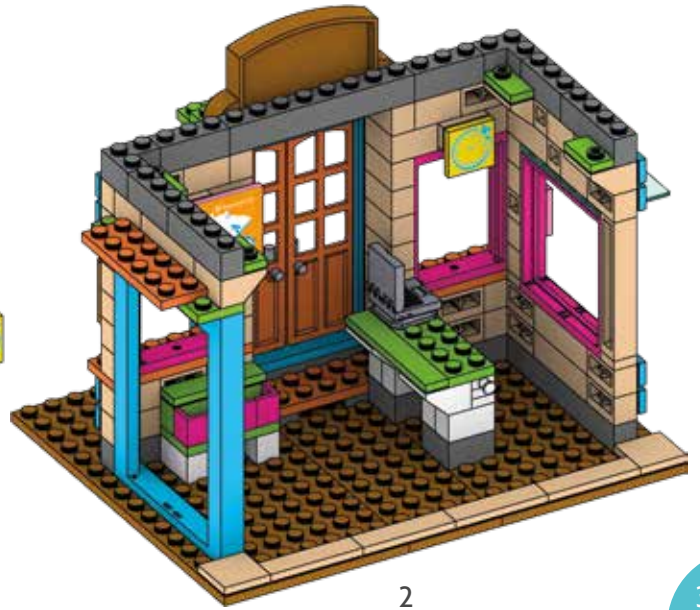

2

Le Refuge pour animaux de Lea

Le refuge a tout ce dont les animaux ont besoin pour retrouver la santé et leurs forces. Que fera Lea pour les aider aujourd'hui?

Passes à la page 38.



SCÈNE À CONSTRUIRE

Le Sauvetage à la tour de guet de Lea

Lea est prête pour l'action!
Que voit-elle depuis le haut
de la tour de guet?

Passes à la page 76.





Le Refuge pour animaux de Lea



La Fillette de l'année Lea Clark adore les animaux et les aventures. Quand elle et sa famille voyagent au Brésil, Lea obtient les deux! Dans la forêt tropicale, il y a des paresseux, des perroquets, des tortues, des singes et un type de chat appelé un *margay*.

Lea ne refuse jamais de vivre une nouvelle aventure.

Avec sa nouvelle amie Camila, Lea fait du bénévolat à un refuge pour animaux. Elles aident le vétérinaire à prendre soin des animaux blessés et à les ramener à la santé. Lea utilise l'ordinateur portable pour suivre les progrès de chaque animal.

La tâche favorite de Lea est de regarder les animaux faire de l'exercice. Le margay descend de l'arbre tête la première, mais le paresseux est lent à se déplacer.

«Tu sois avoir récupéré toutes tes forces avant que le vétérinaire te relâche dans la nature», dit Lea au paresseux en le regardant grimper l'arbre. Lea voit ensuite le paresseux suspendu tête en bas, serrant une branche d'arbre avec ses pieds. «Super», dit Lea.
«Ça semble assez bon pour moi!»



Lea explore ce qui est dans son cœur.

Lea est une photographe, et les animaux sont ses sujets favoris. Elle utilise ses photos dans le blogue qu'elle écrit pour ses amis à la maison. «Je réalise mes meilleures photos quand je regarde les choses sous un angle nouveau», écrit-elle. «Il n'est pas facile de se placer au niveau des yeux d'une tortue de mer. Mais ça vaut le coup!»

Découvre encore plus sur Lea dans ses livres d'American Girl.





CONSTRUIS LE REFUGE POUR ANIMAUX DE LEA



Termine le refuge.

75



1x



2x

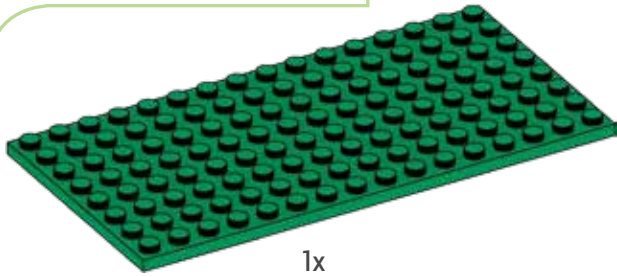

1x

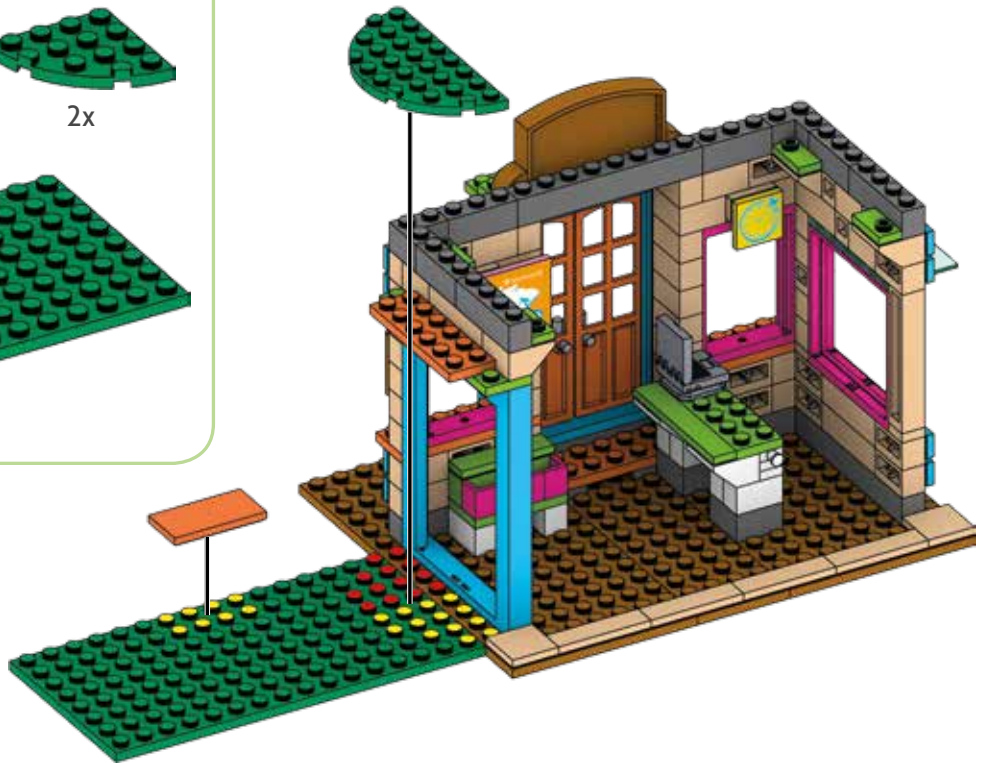

76



4x



2x

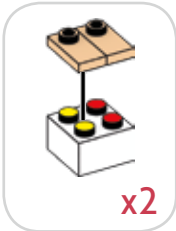

x2

36

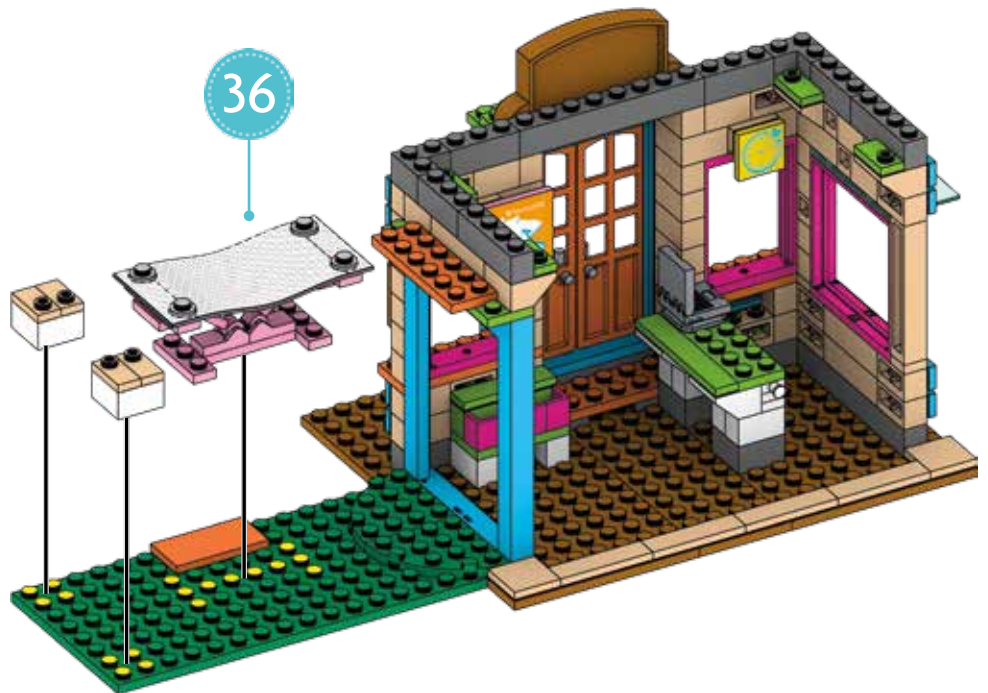



77



2x



2x



2x



x2

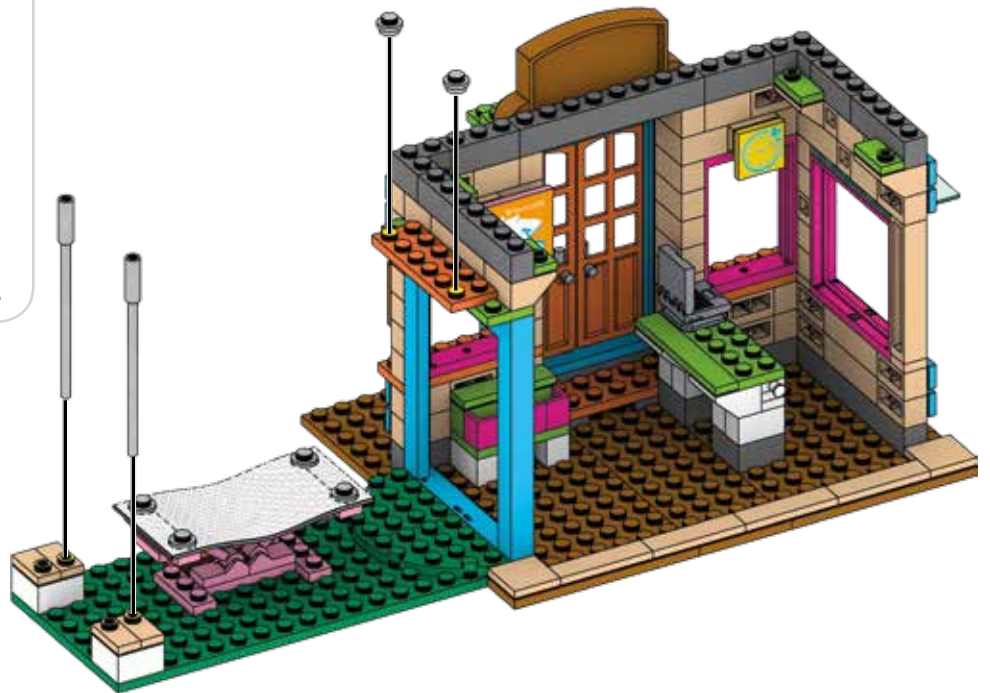

78



2x



1x



1x



1x



1x

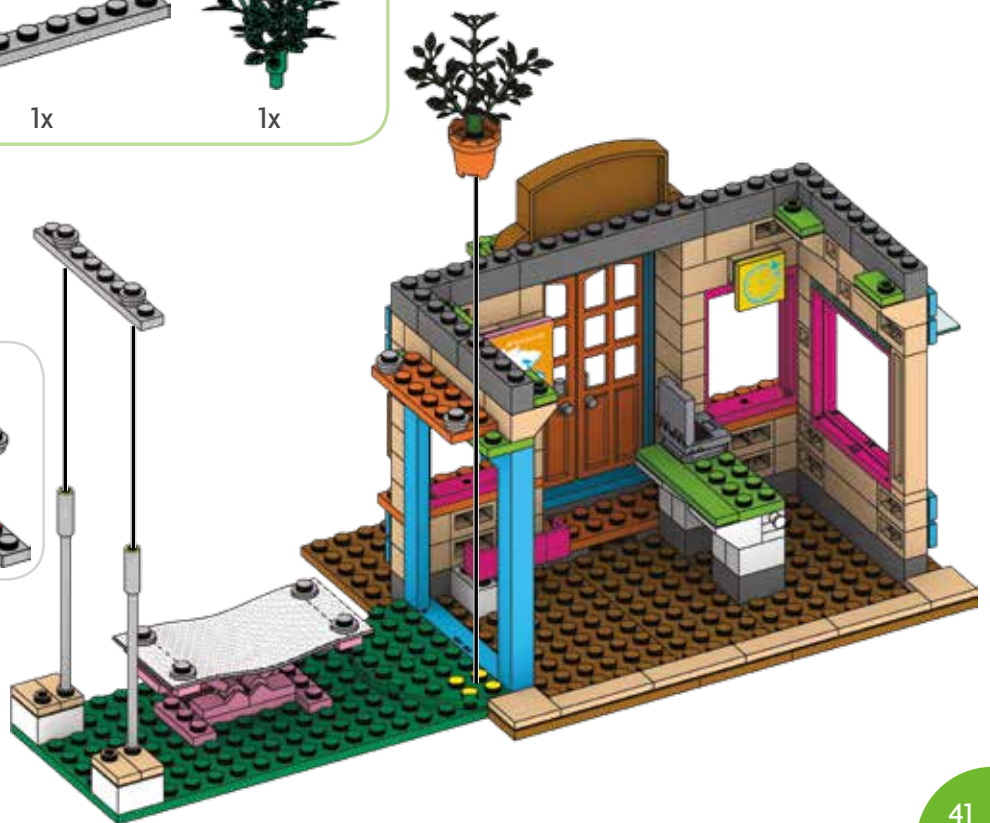
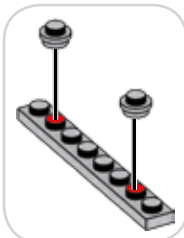



79



2x



2x

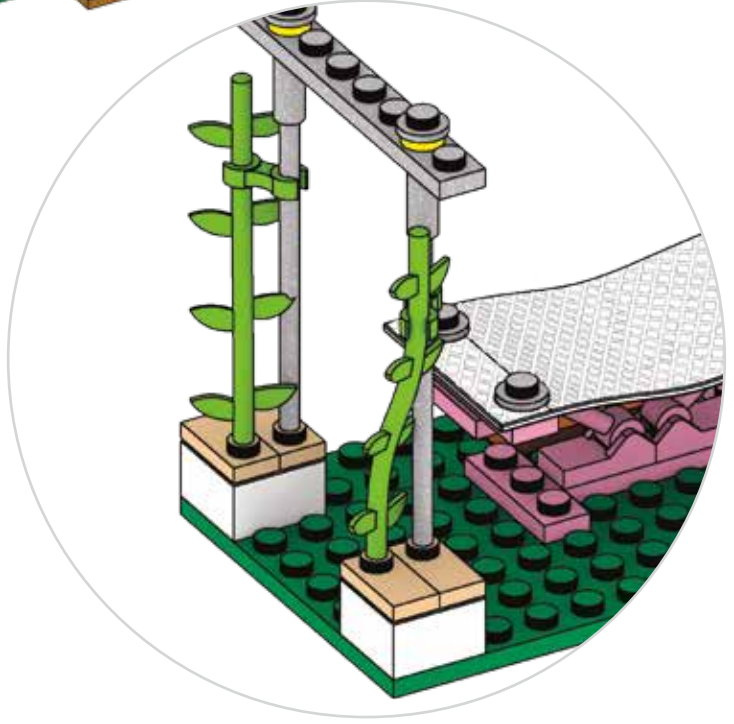
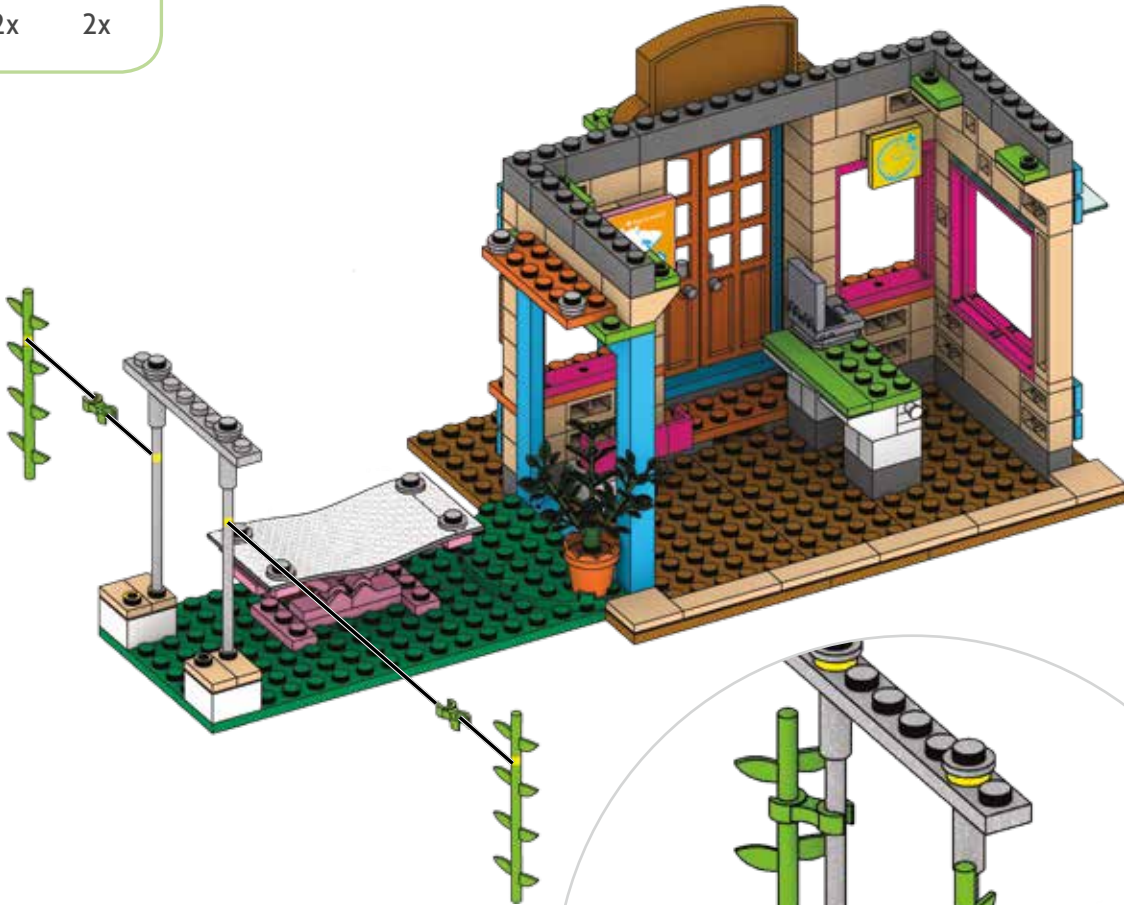



80



1x

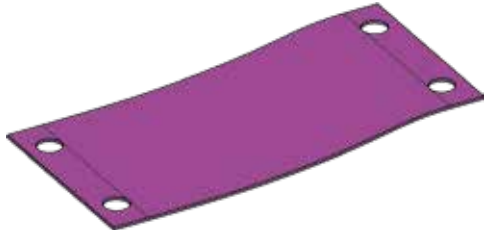

1x

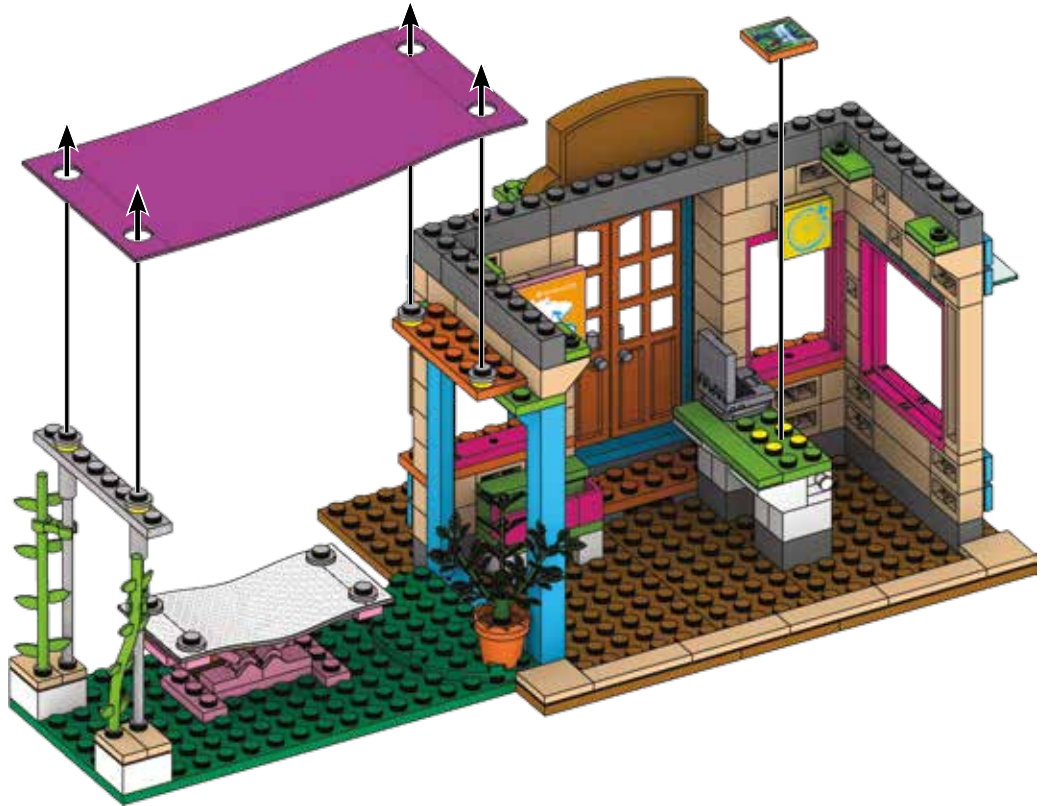

CONSEIL UTILE

Lorsque tu fixes la bâche de tente, étire le tissu serré pour l'installer sur les 4 facettes.
Ça semble confortable!





81



1x



1x



1x

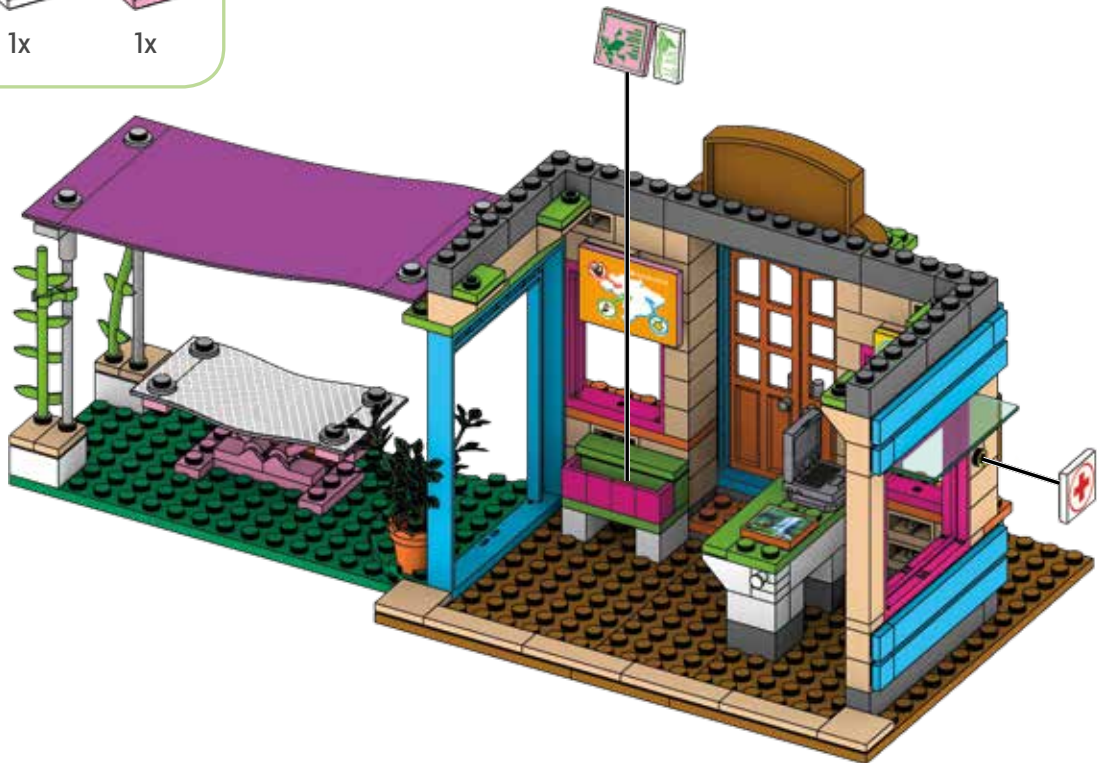

82



1x

5



4

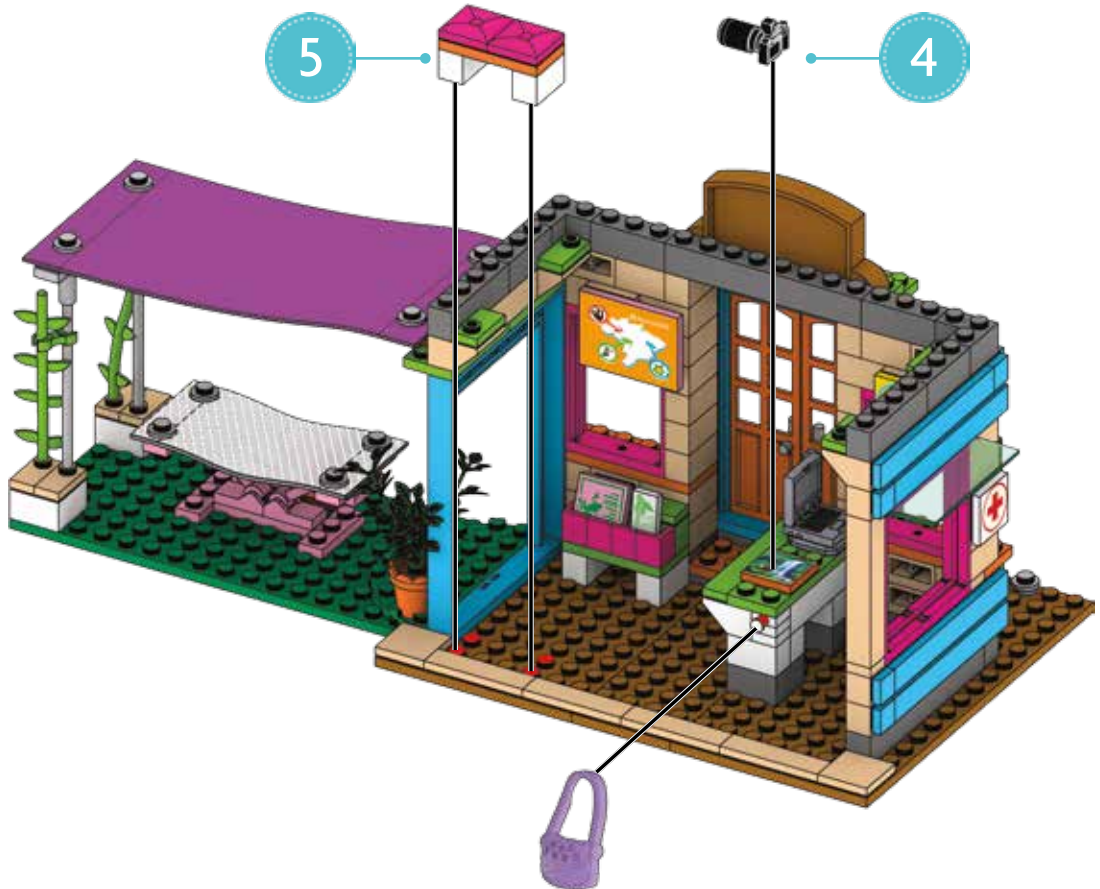



83

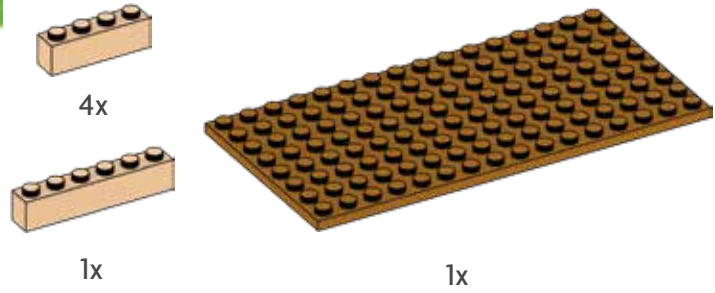

Construis le deuxième étage. Les grandes fenêtres permettent à Lea et aux animaux de voir dans la forêt tropicale!

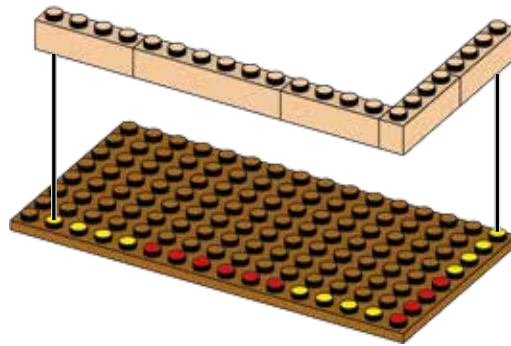

84

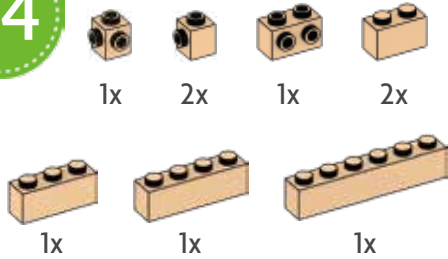

85

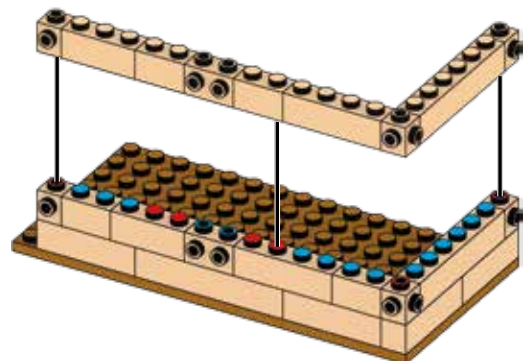
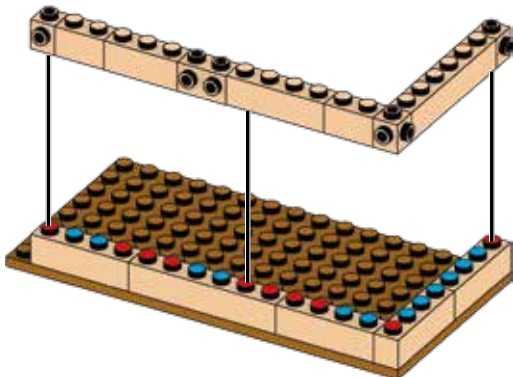
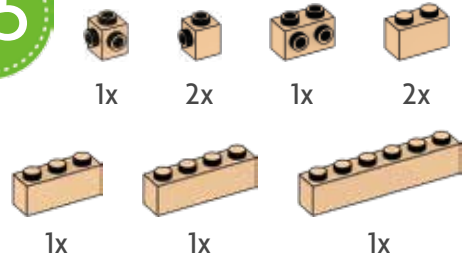



86



4x

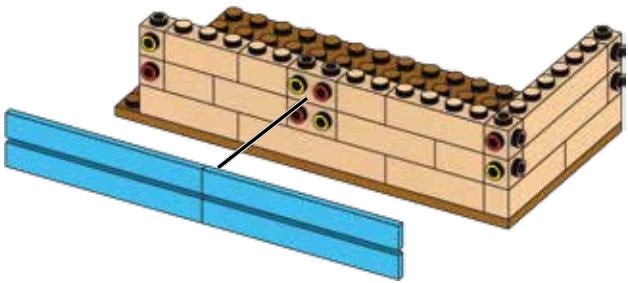

87



5x



2x



1x



2x

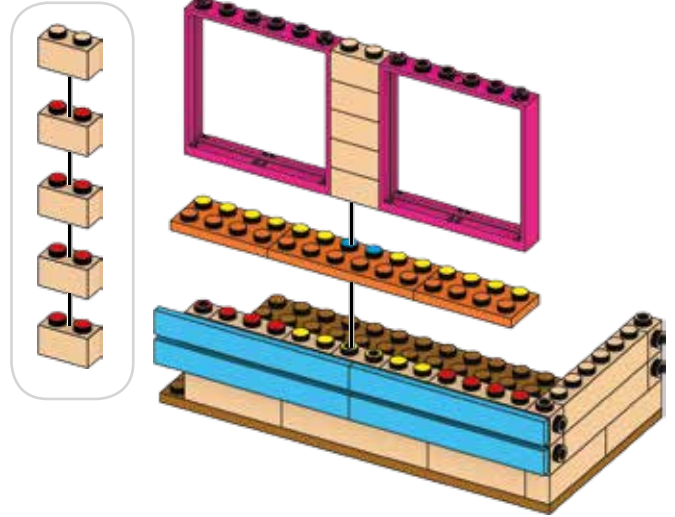

88



3x



1x



2x

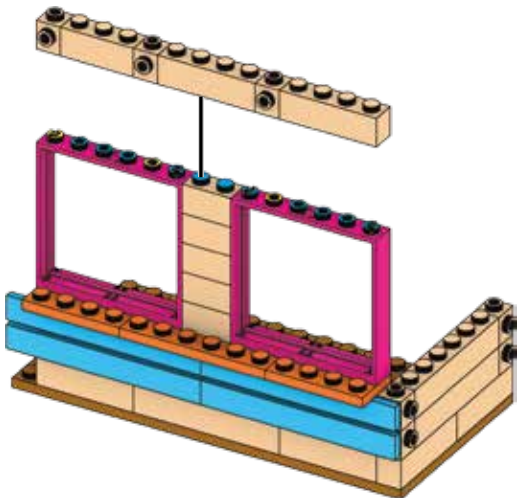

89



4x



2x



2x



2x

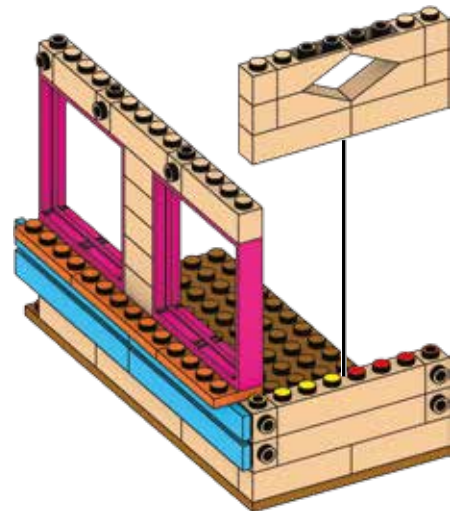
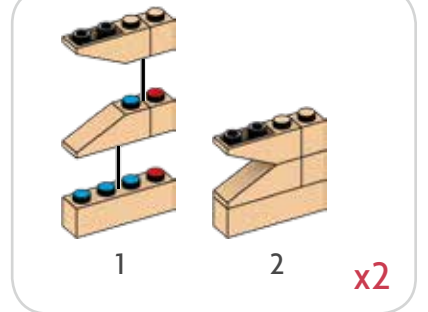



90

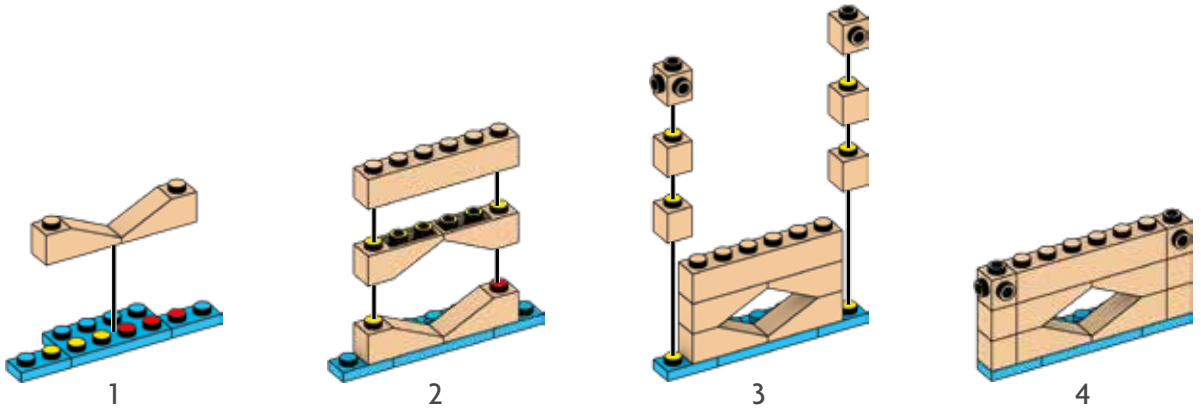
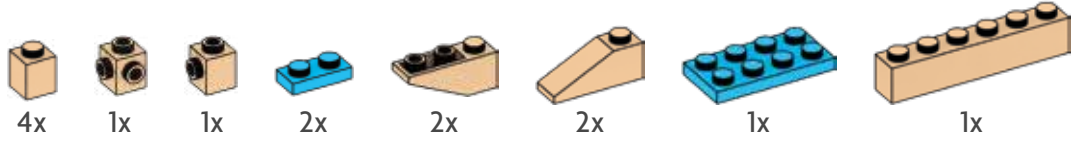

91

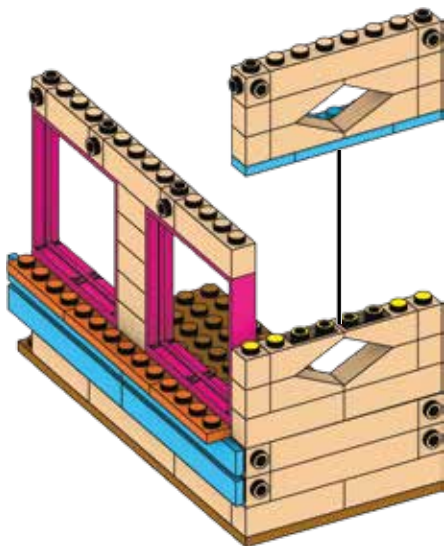

92

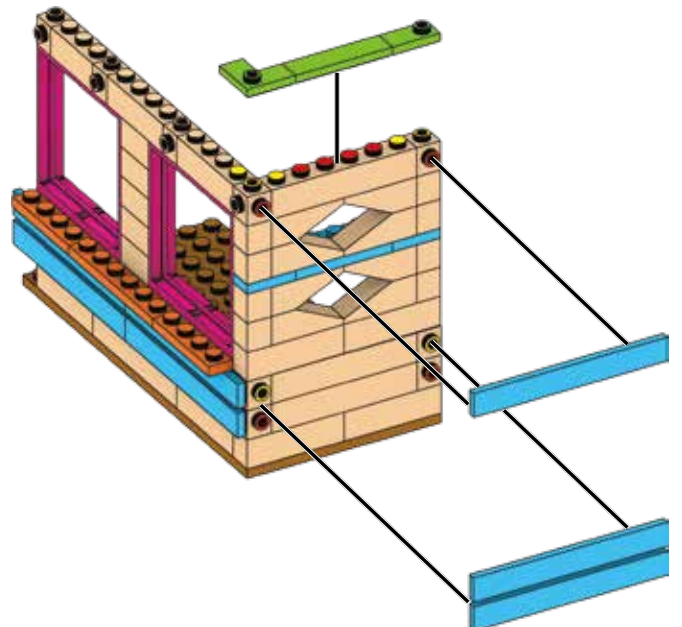
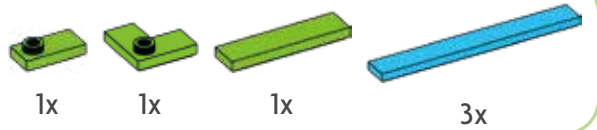



93

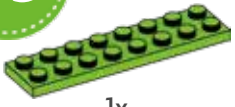

1x



1x

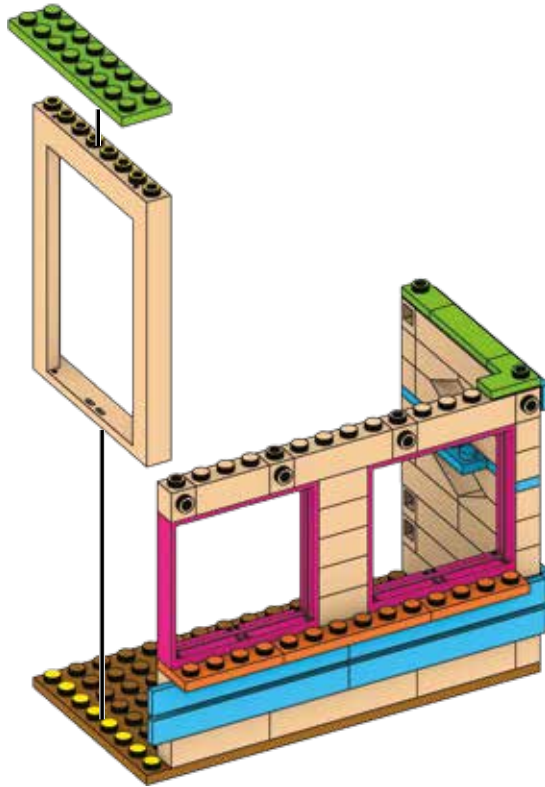

94



1x

1x

1x



1x

2x

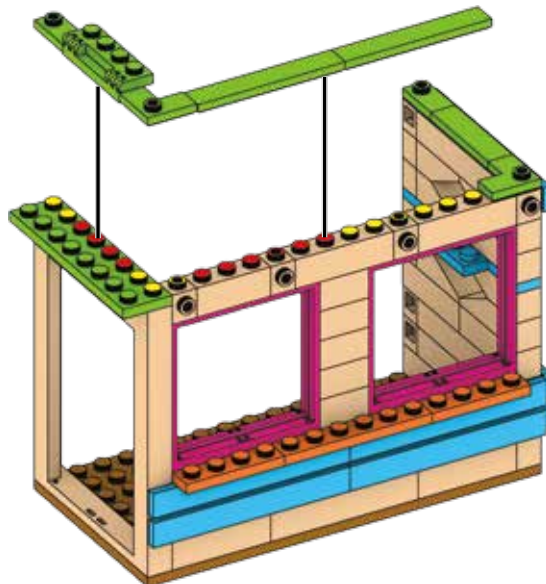



95



2x

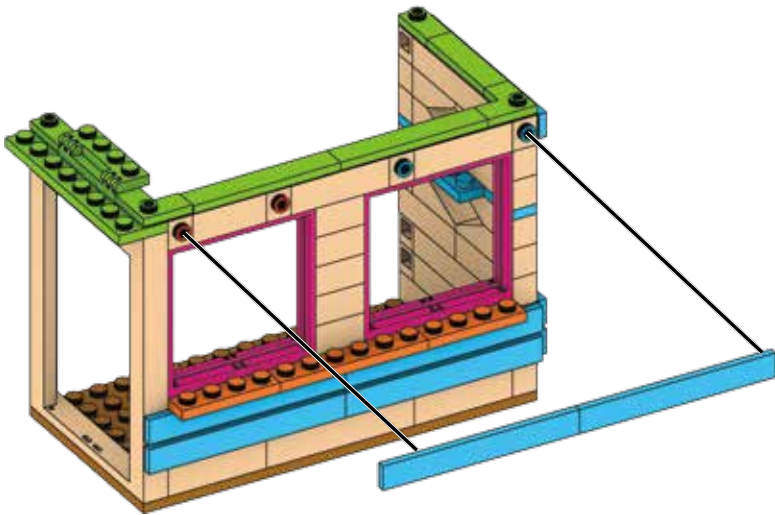

1

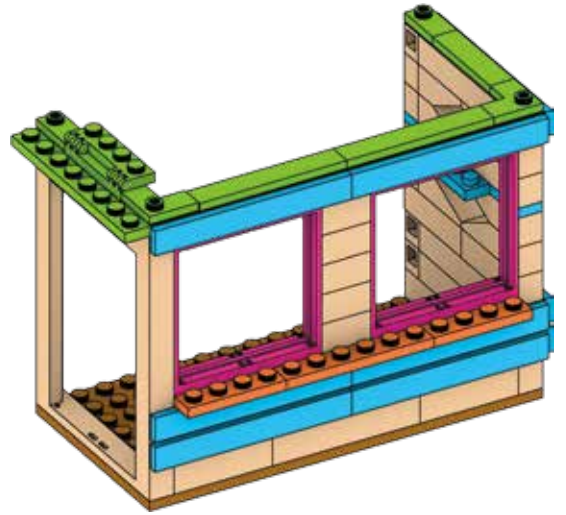

2

96

3

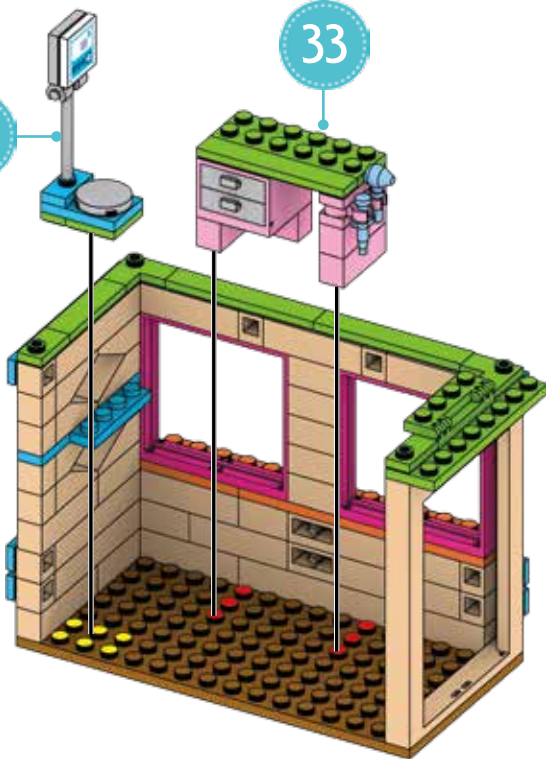

33

97



1x

1x

1x

1x

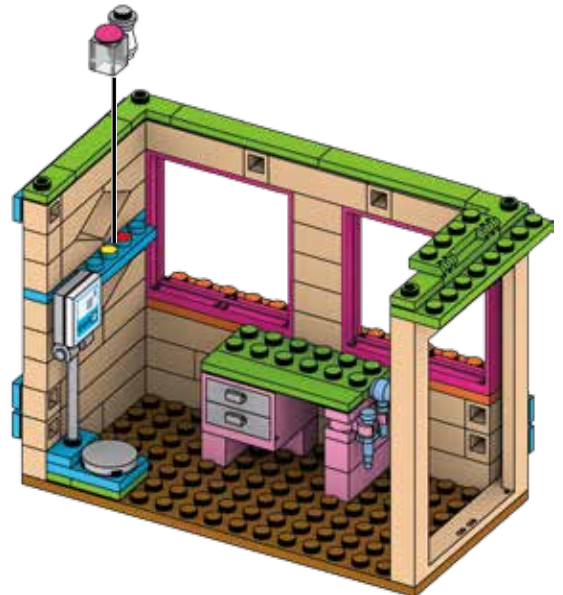
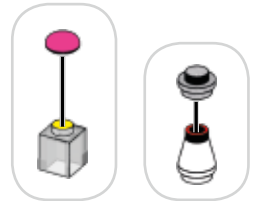



98

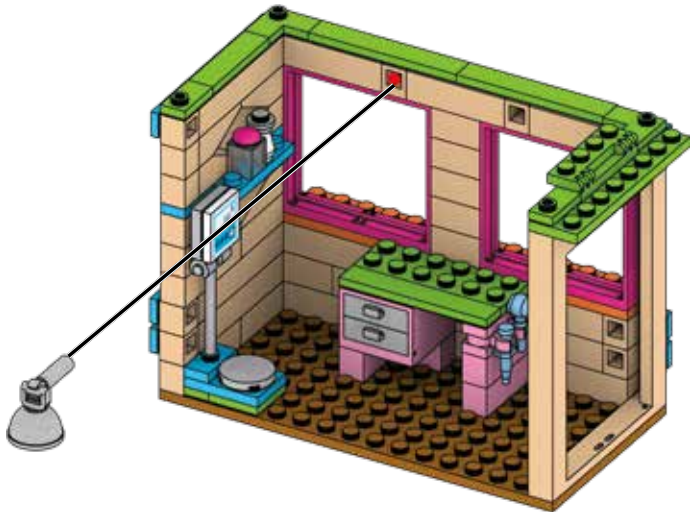
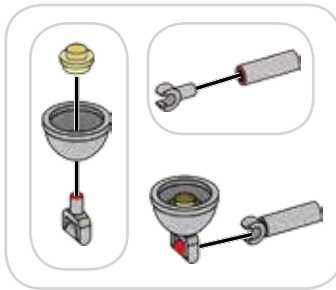

1

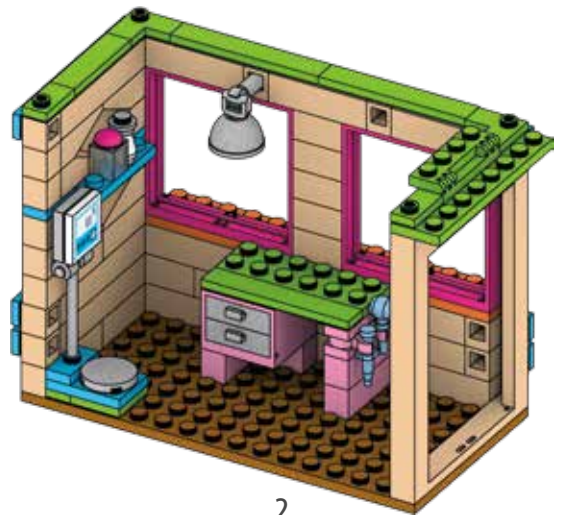

2

99

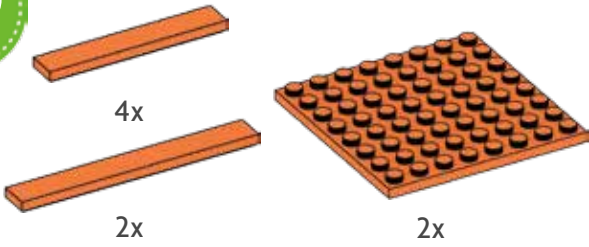

100

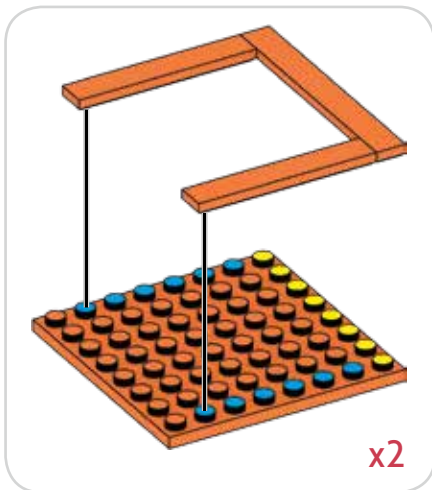

x2

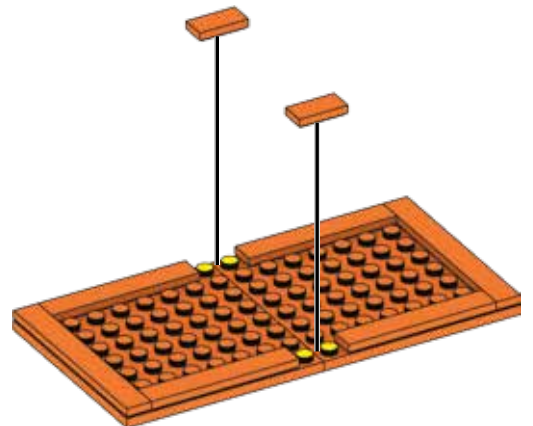



101



1x

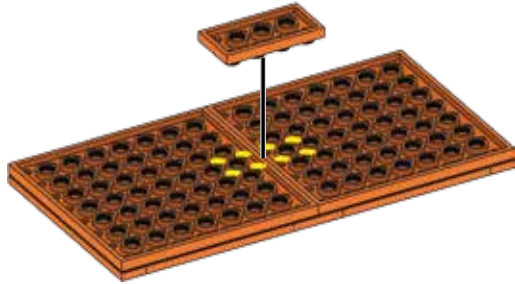

1

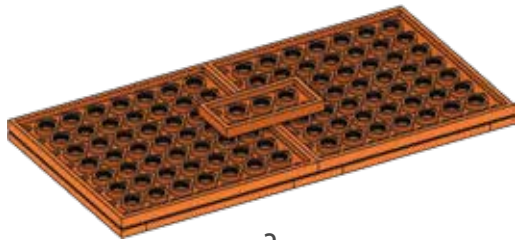

2

102



4x

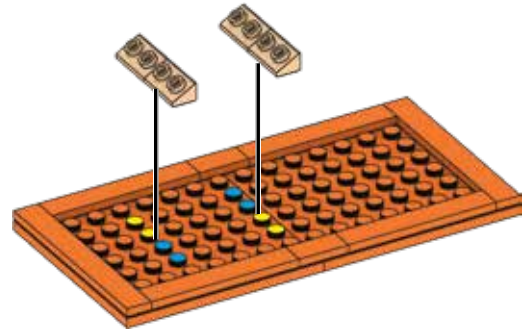

103



6x



2x



x2

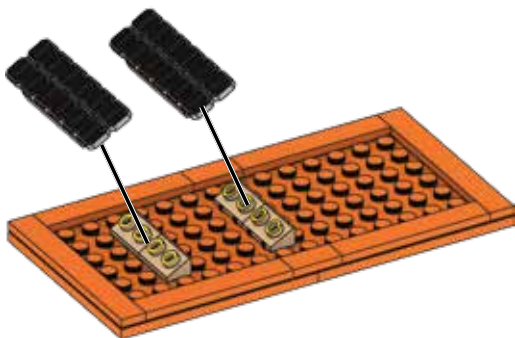

1

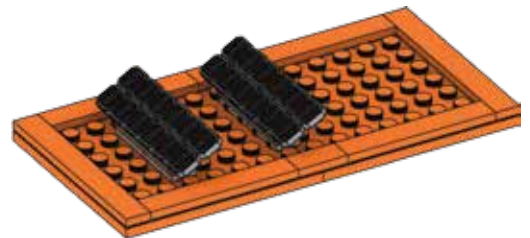

2



104

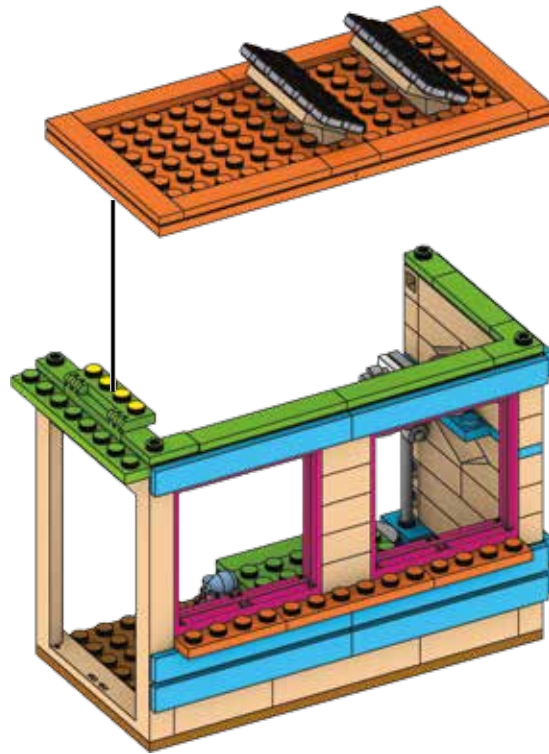

CONSEIL UTILE

Pour fixer le toit, relie-le à la pièce charnière à quatre points. Utilise tes deux mains pour le guider en place.

Tu peux maintenant lever le toit avec facilité!





105



2x

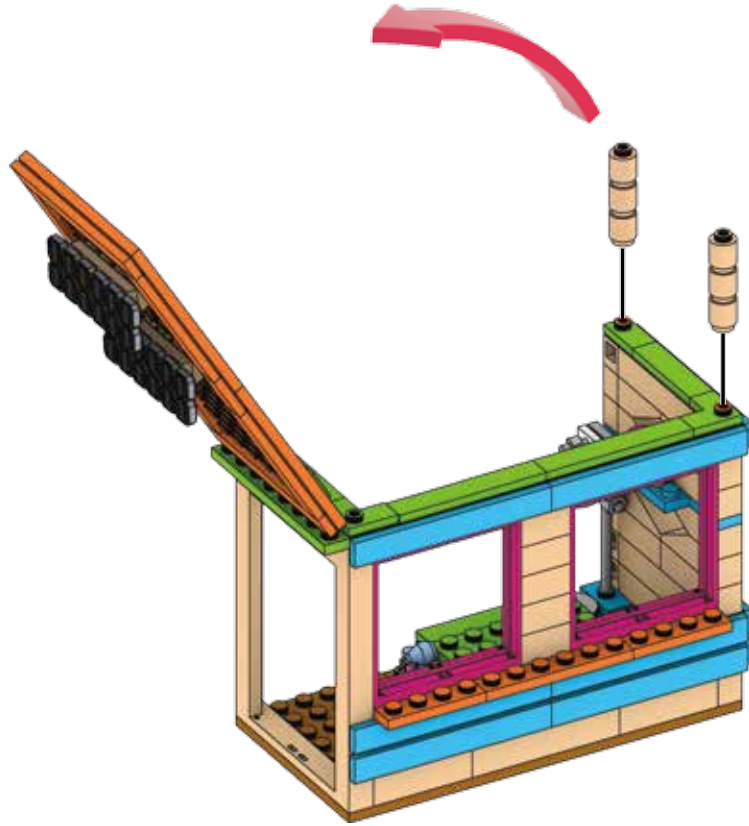

106

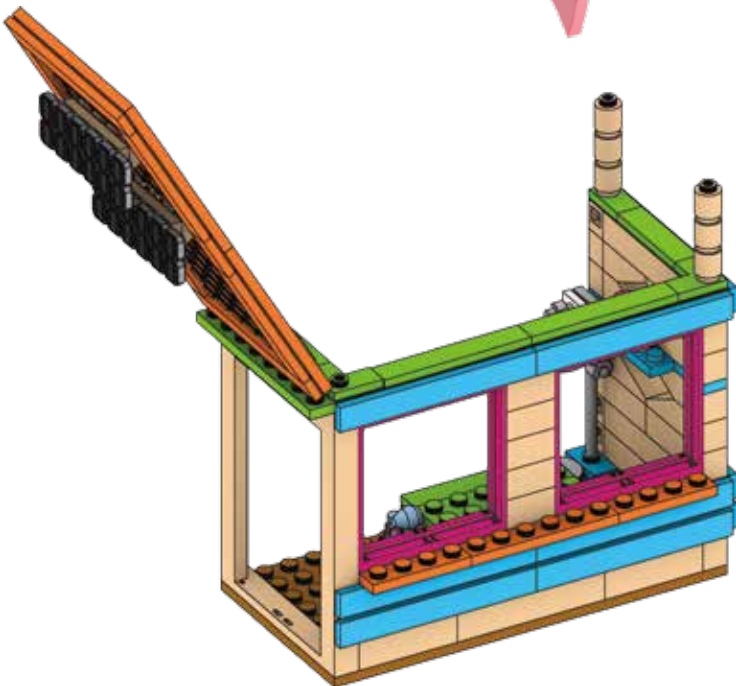

1

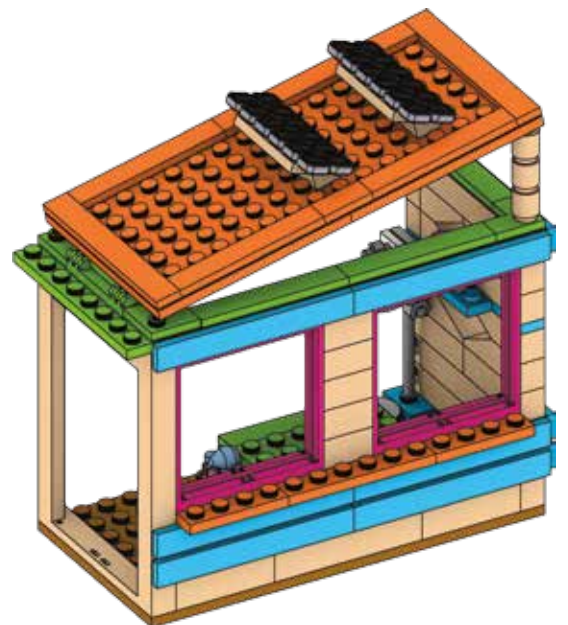

2



Parfois, les animaux font de l'exercice à l'extérieur!
 Construis l'espace extérieur
 et la tour d'escalade.

107

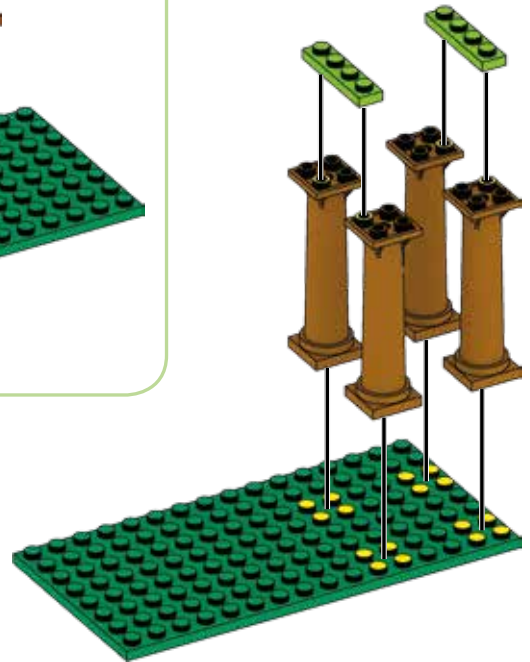
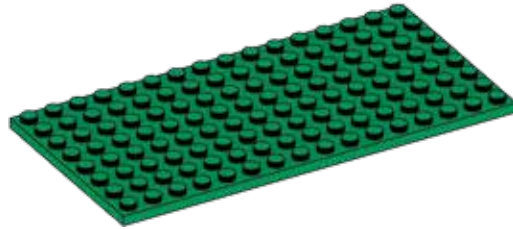
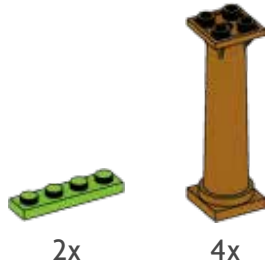

108

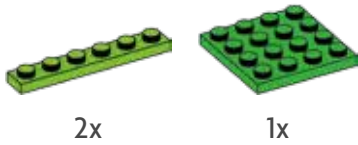

109

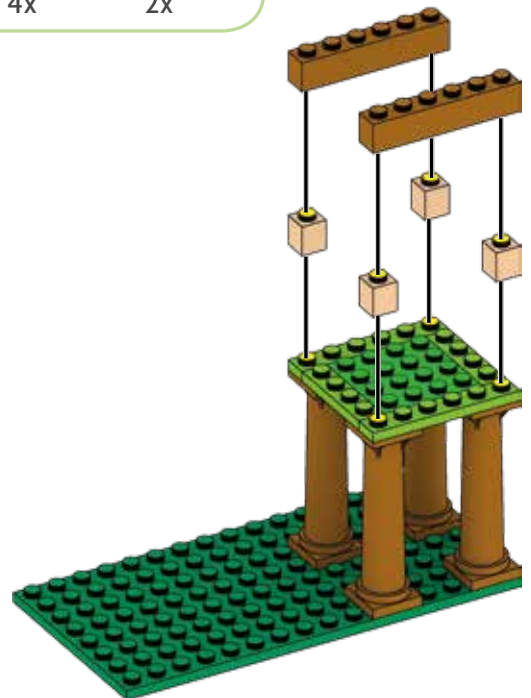
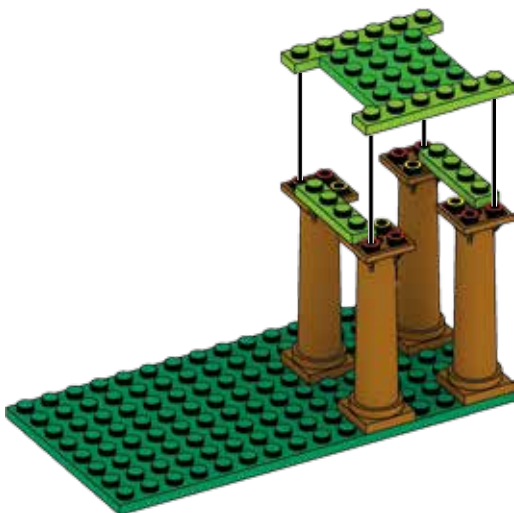
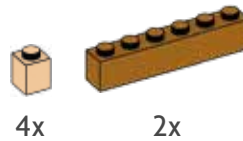



110



2x

1x

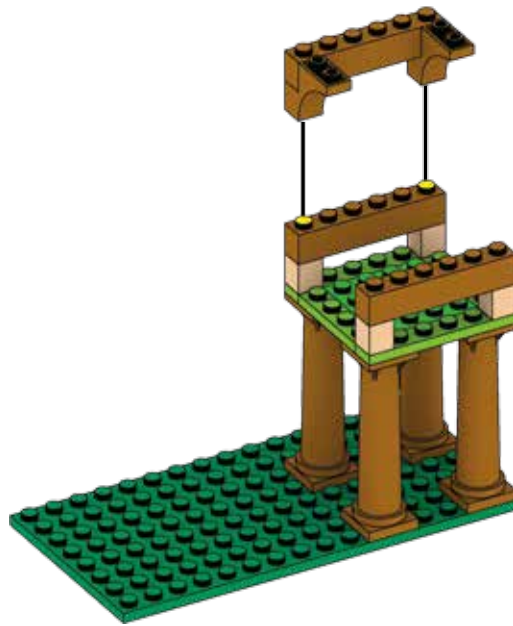
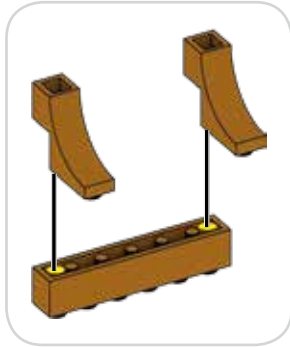

111



2x

1x

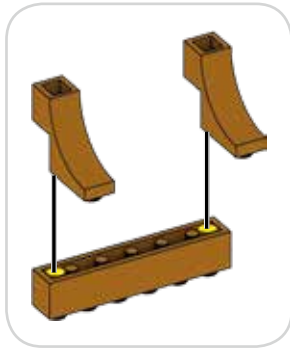



112



4x



4x



CONSEIL UTILE

Utilise tes deux mains pour soutenir la tour d'escalade pendant que tu fixes la bordure. Beau travail!





113

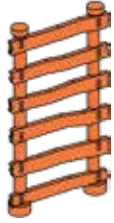

1x

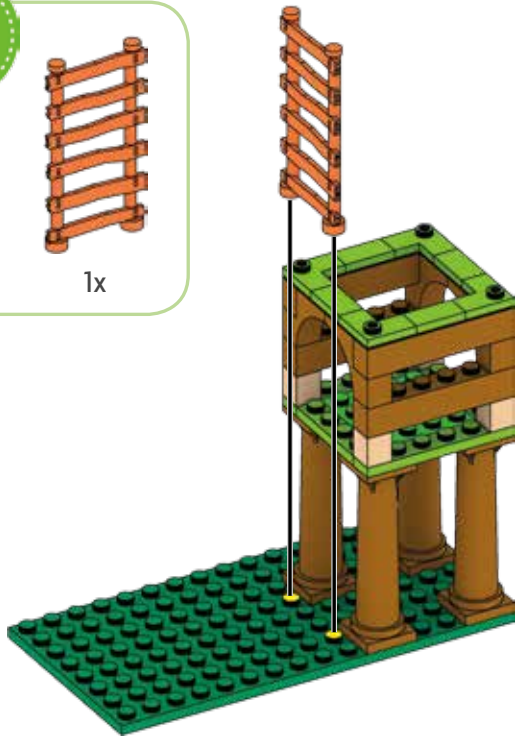

1



2

114



4x

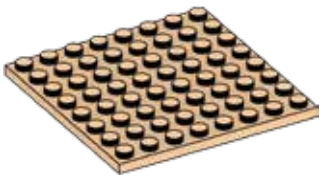

1x

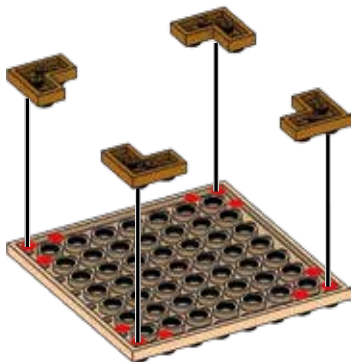

1



2

115



2x



2x



4x



4x

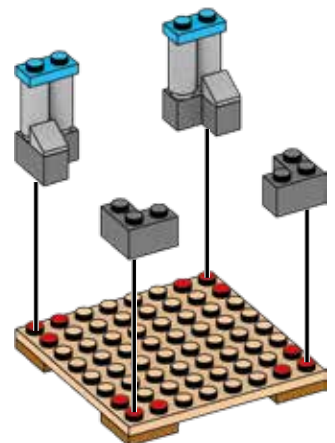



116

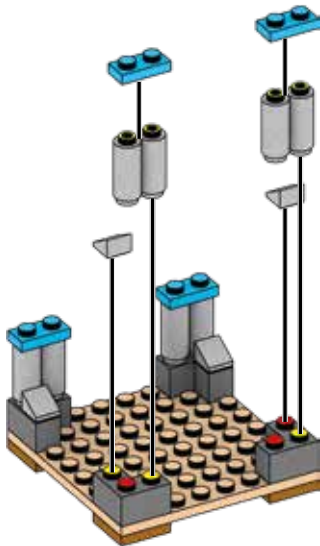

117

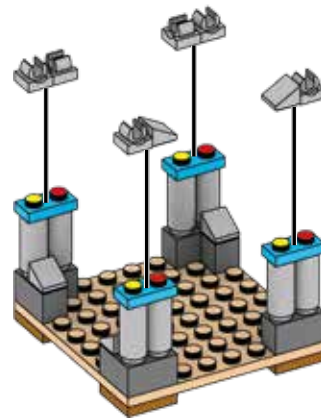

118

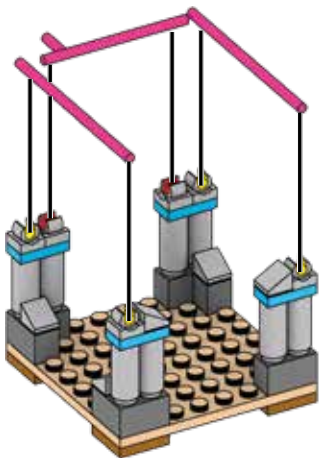

119





120

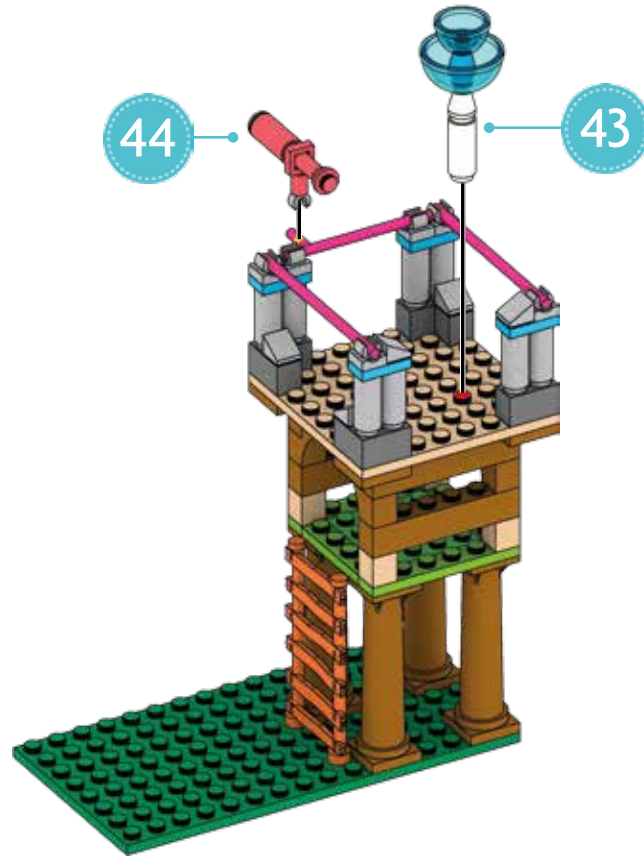

121

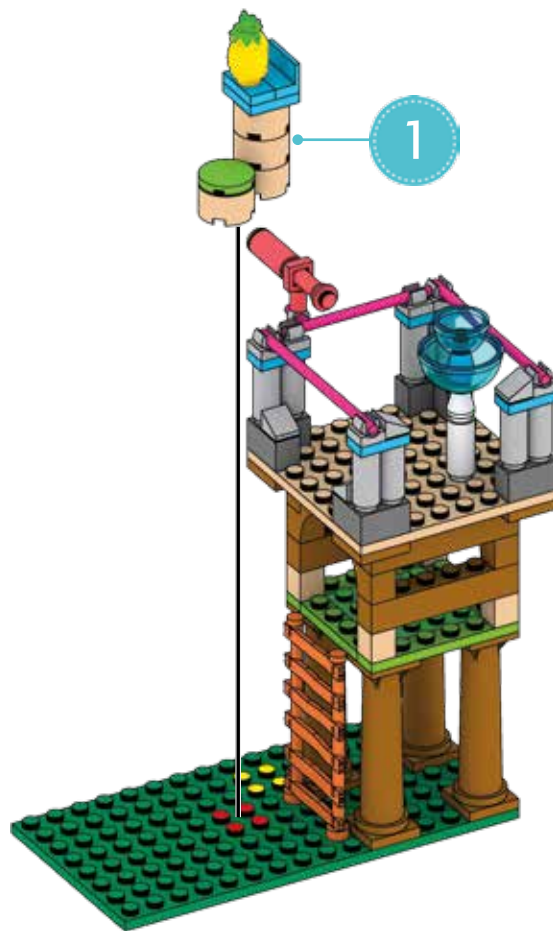
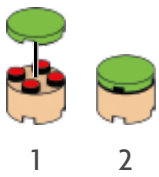



122



1x



1x

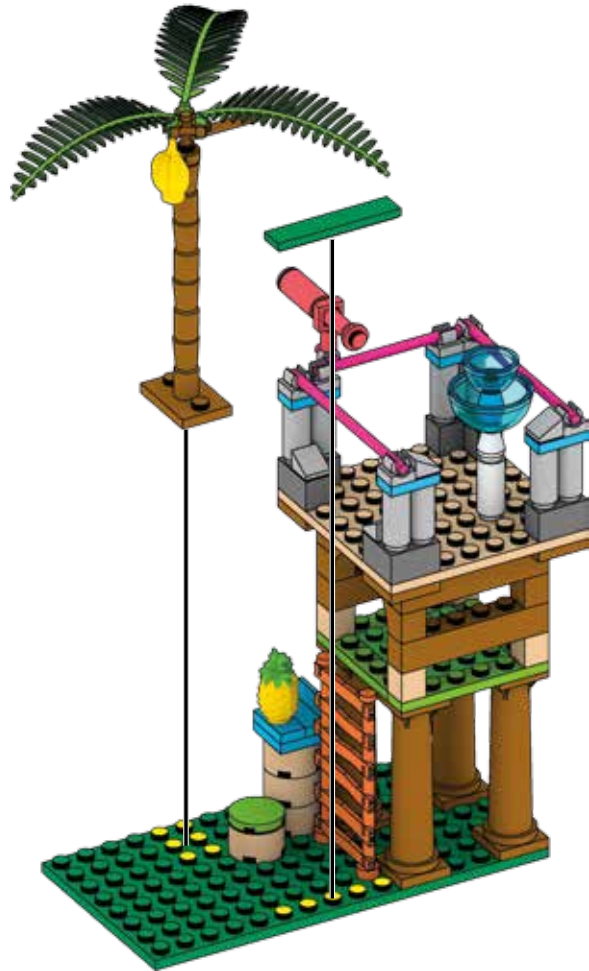

123



1x

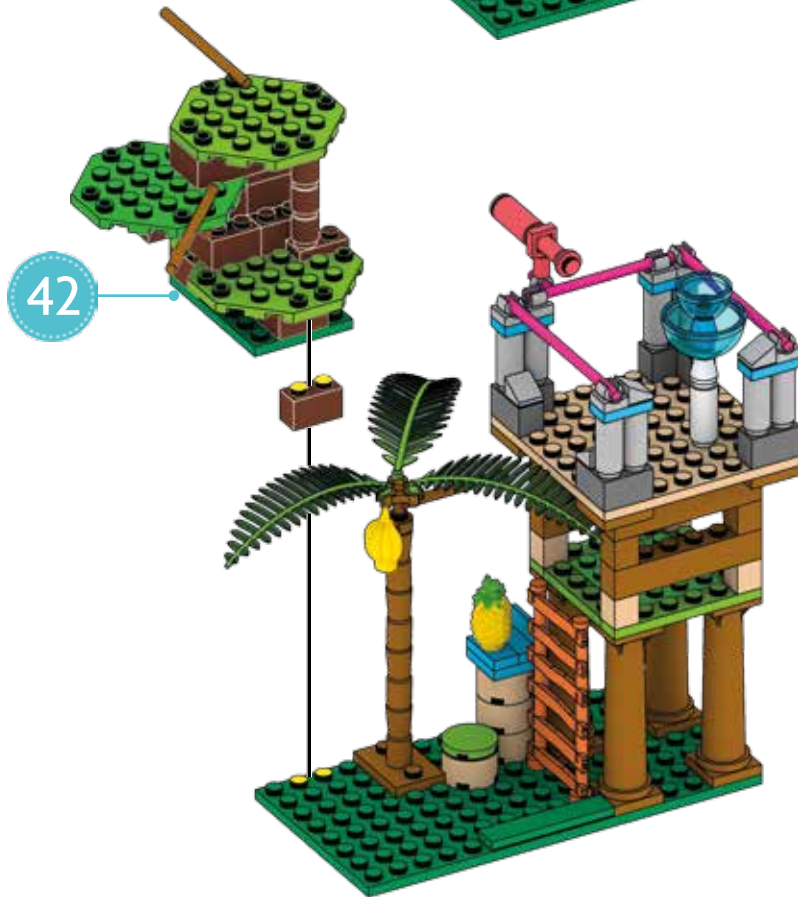



124



3x



3x



1



2

x3



125



1x





126



2x



1x

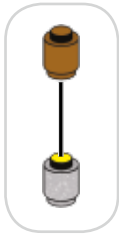

127



2x



3x

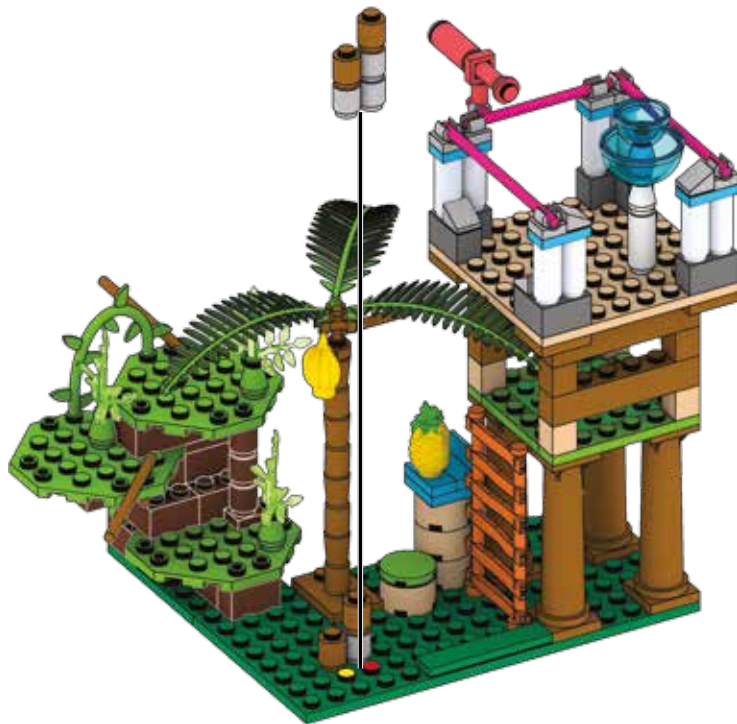
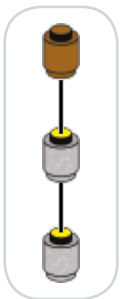
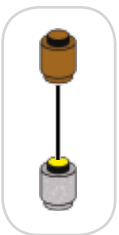



CONSEIL UTILE

On voit que les choses avancent! Tu auras besoin des deux mains pour fixer le deuxième étage. Essaie de fixer la pièce un côté à la fois. Une fois le premier côté relié, garde la main en place pour le tenir solidement pendant que tu enclenches le deuxième côté. Parfait!



Voilà! C'est le moment de l'ajouter au refuge et de le combiner avec la zone extérieure. Tout va bien!

128

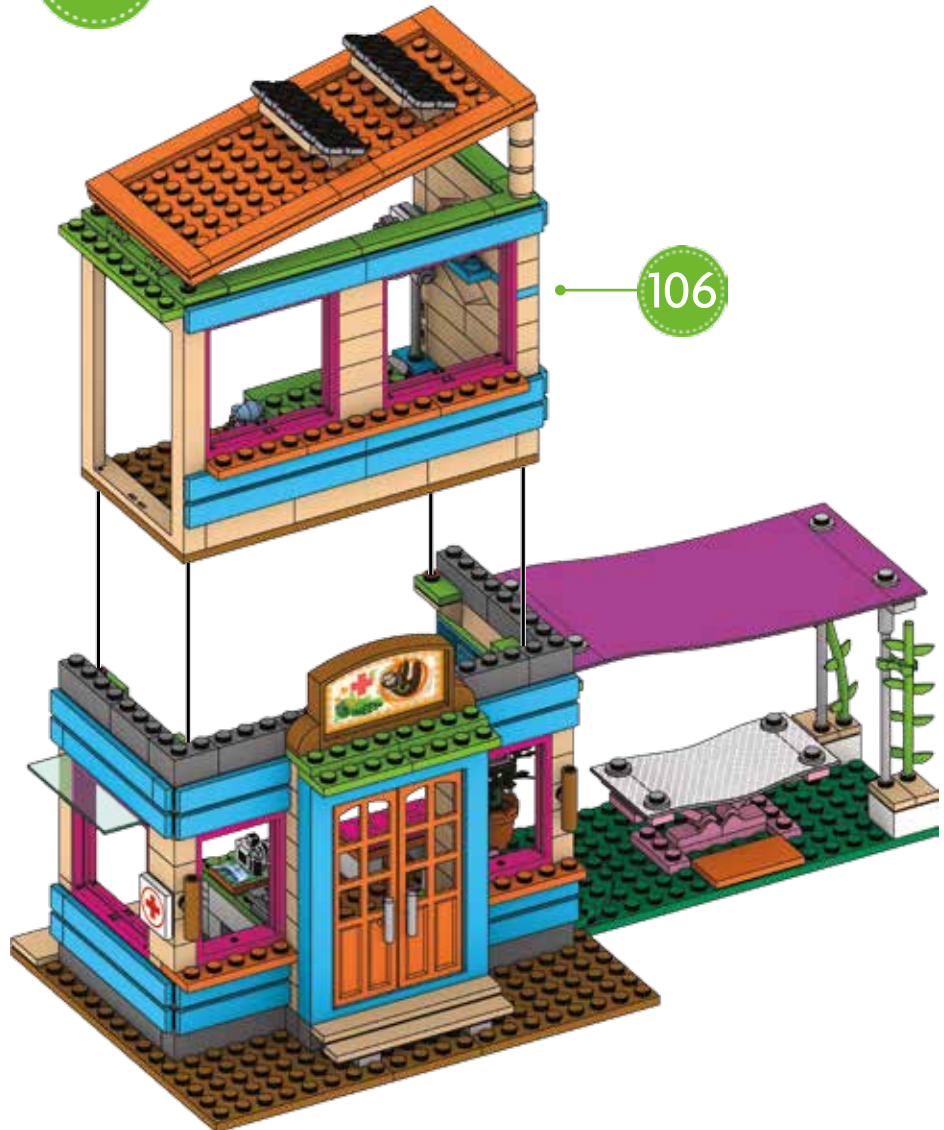



129



1x



2x



2x



2x



2x

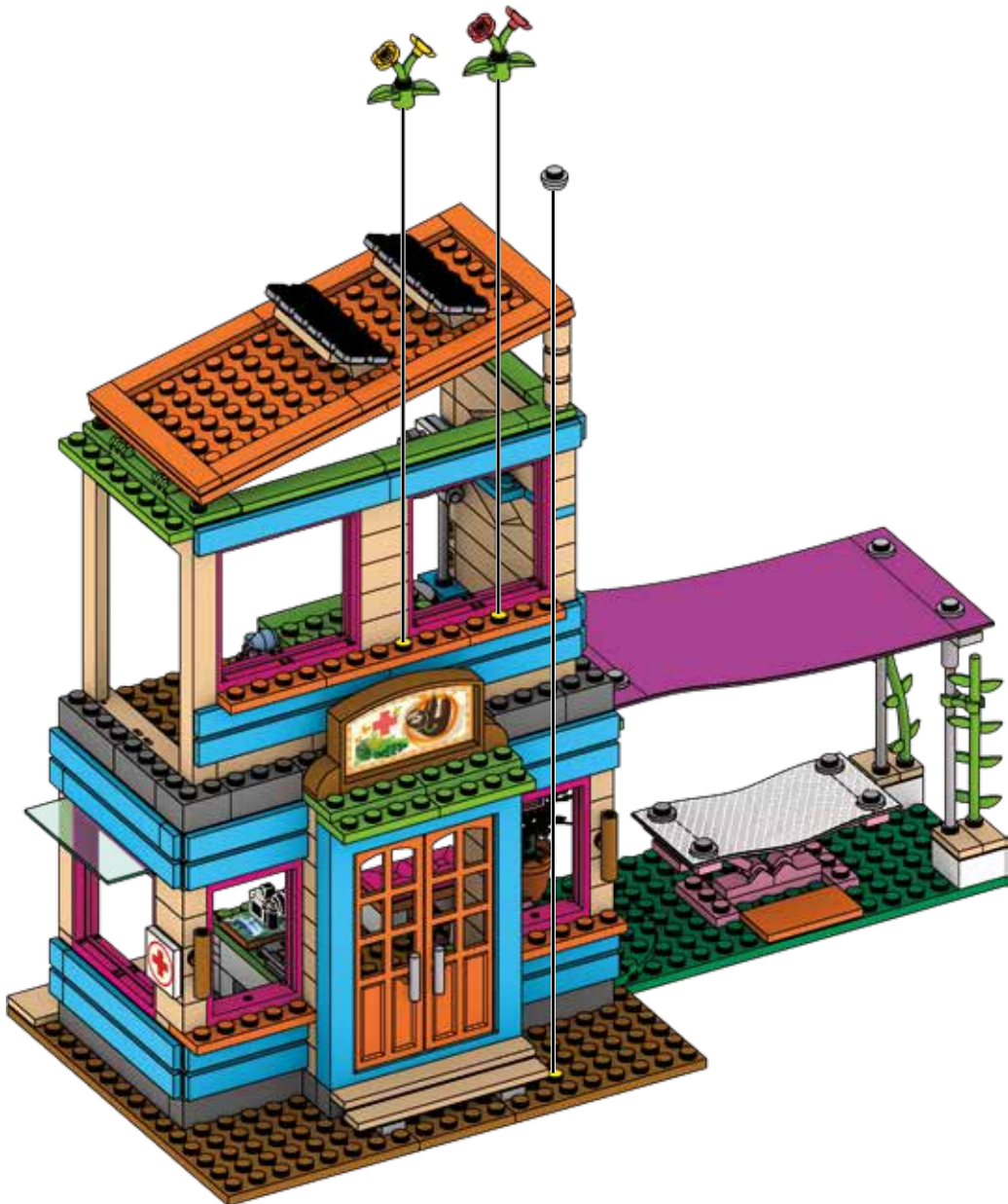
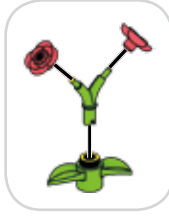



130

- 2x
- 2x
- 2x
- 2x
- 2x





131



2x



1x



1x



2x



1x

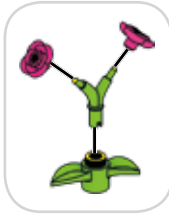



132



1x





133

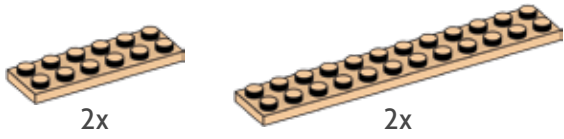

2x

2x

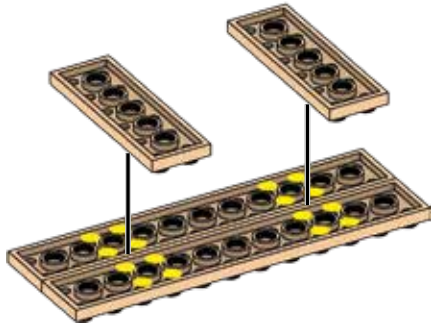

1



2

134

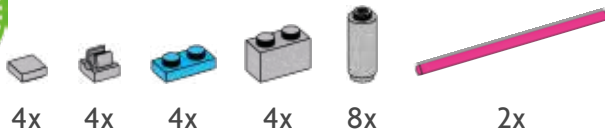

4x

4x

4x

4x

8x

2x

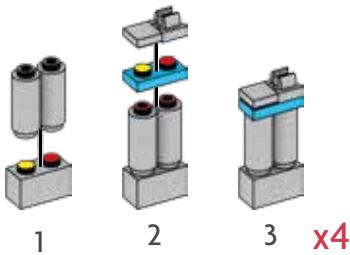

1

2

3

x4

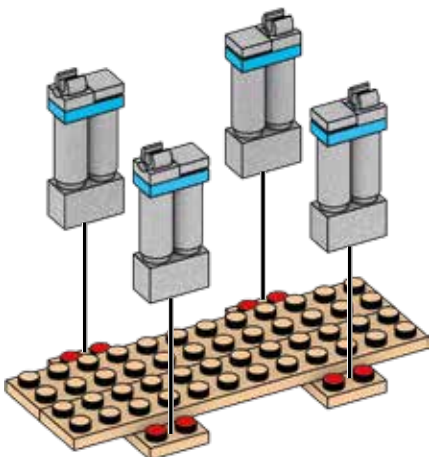

1

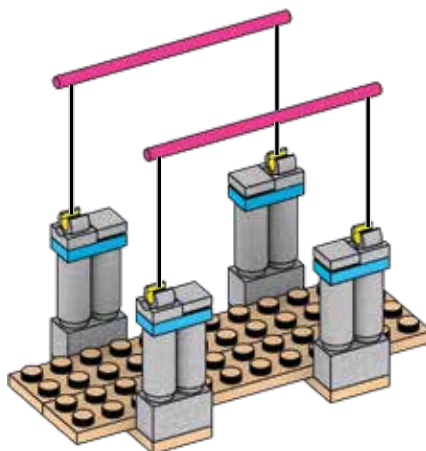

2

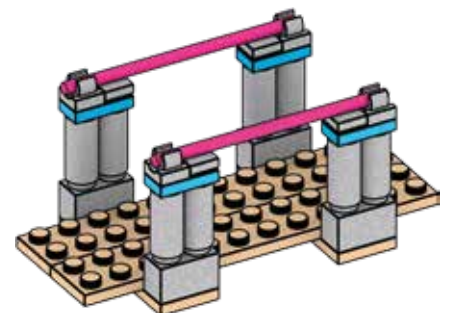

3



135

30

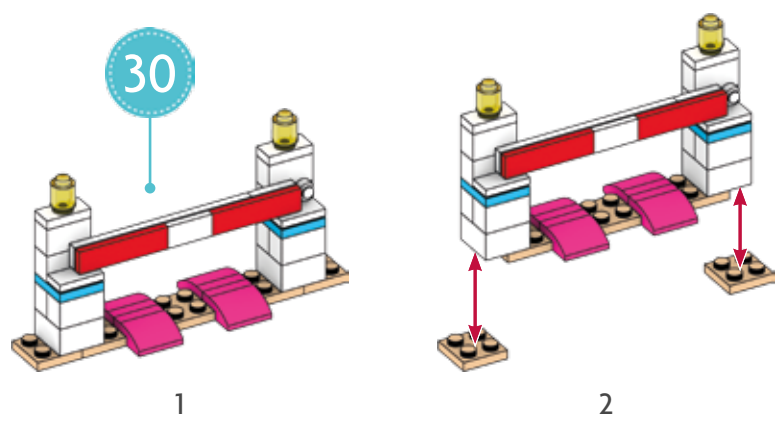

Remove temporary pieces
 Retirez les pièces temporaires
 Retirar las piezas provisionales.
 Remover as peças temporárias
 Rimuovere i pezzi provvisori
 Die vorübergehend benötigten Teile entfernen
 Usunąć elementy tymczasowe
 Verwijder tijdelijke delen
 Fjern midlertidige stykker.
 Удалите временные детали
 Ta bort temporära delar
 Fjern midlertidige deler
 Poista väliaikaiset osat
 Αφαιρέστε τα προσωρινά κομμάτια
 Geçici parçaları çıkarın
 移除临时件
 暂定ピースを外してください
 انزع القطع المؤقتة





136



1x

134





137

- 4x
- 4x
- 2x
- 2x

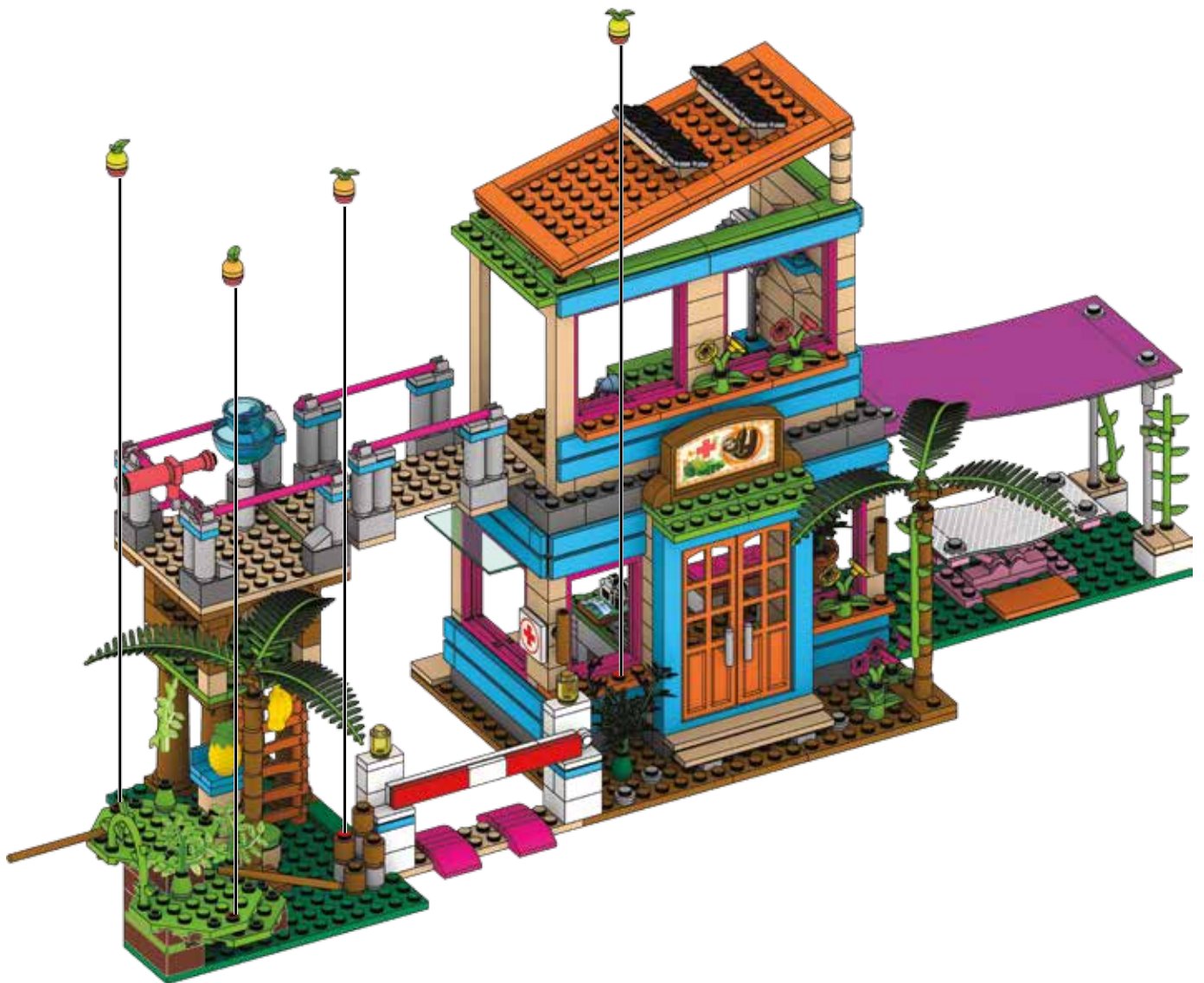
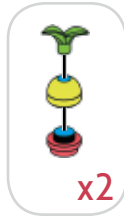
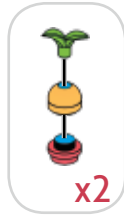



138



1x



1x



1x





139



1x



1x



1x



1x



1x





140



1x

1x

1x

1x

BEAU TRAVAIL!

Tu as construit le Refuge pour animaux de Lea!



CRÉE TON HISTOIRE

Tu peux créer encore plus d'histoires American Girl en ligne.
Construis tes propres histoires et découvre ce que d'autres filles ont créé.
Parce qu'ensemble, on peut aller beaucoup plus loin!





Le Sauvetage à la tour de guet de Lea



La Fillette de l'année Lea Clark est courageuse et prête pour l'action. Quand elle se rend au Brésil avec sa famille, elle fait du bénévolat dans un refuge pour animaux, où les vétérinaires prennent soin des animaux malades et blessés.

Son esprit aventurier lui ouvre toujours la voie. Aujourd'hui, Lea et son amie Camila sont à la tour de guet. Lea regarde attentivement dans le télescope et aperçoit un bébé margay à la base d'un arbre. Pourquoi est-il seul?, se demande-t-elle. Je vais en informer le vétérinaire. Quand le vétérinaire invite les filles à le suivre pour aller sur place, Lea se rend rapidement au véhicule de sauvetage.

«Je vais chercher la trousse de premiers soins», dit Lea. «Super! Je n'aurais jamais cru que les vacances pourraient s'avérer si excitantes!»



Lea adore tous les animaux – à plumes, drôles, glissants et visqueux.

Le bébé margay est blessé, et il doit être examiné. Pendant que Lea se précipite vers sa tente mobile du vétérinaire, elle voit 2 singes la regarder depuis un arbre. Elle aperçoit un toucan et des tortues de mer à côté de l'océan. Et, attends – est-ce un paresseux suspendu à la branche? Le refuge prend soin de tant d'animaux différents au Brésil, pense-t-elle. Je me demande ce que je peux faire d'autre pour aider? Découvre encore plus sur Lea dans ses livres d'American Girl.





CONSTRUIS LE SAUVETAGE À LA TOUR DE GUET DE LEA



Construis la tente
mobile du vétérinaire.
C'est comme une mini
clinique vétérinaire dans
la forêt tropicale
profonde.

75

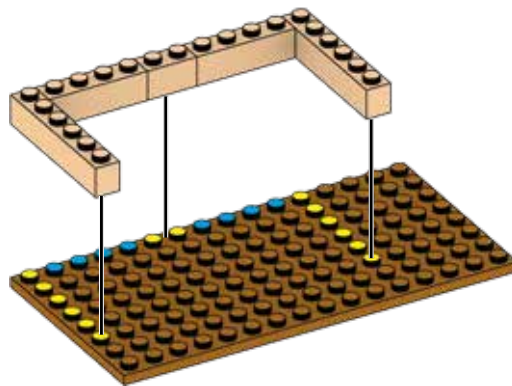
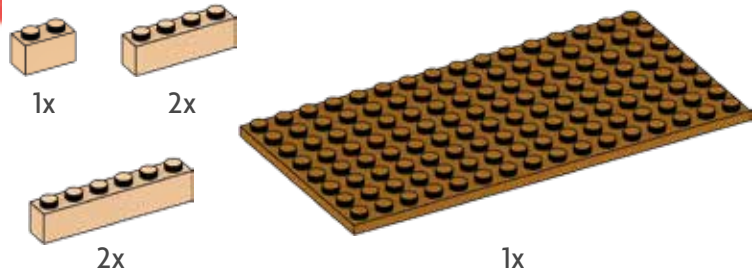

76

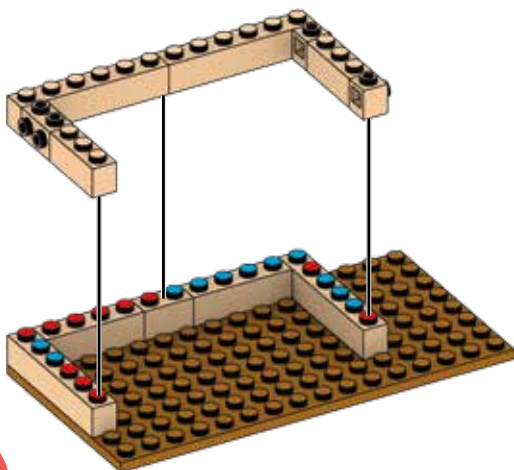
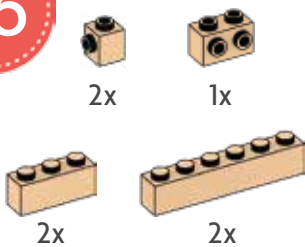

77

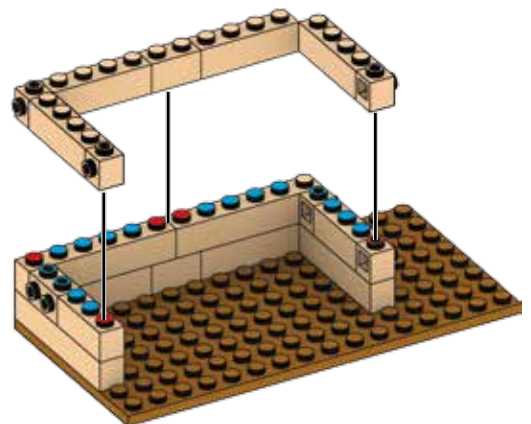
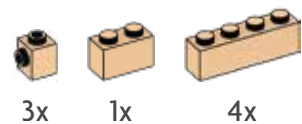



78

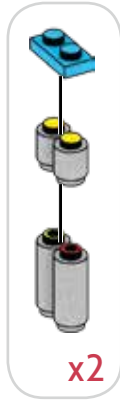
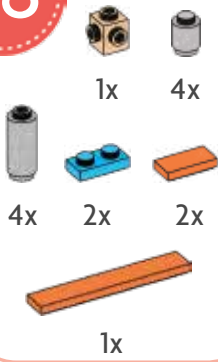

x2

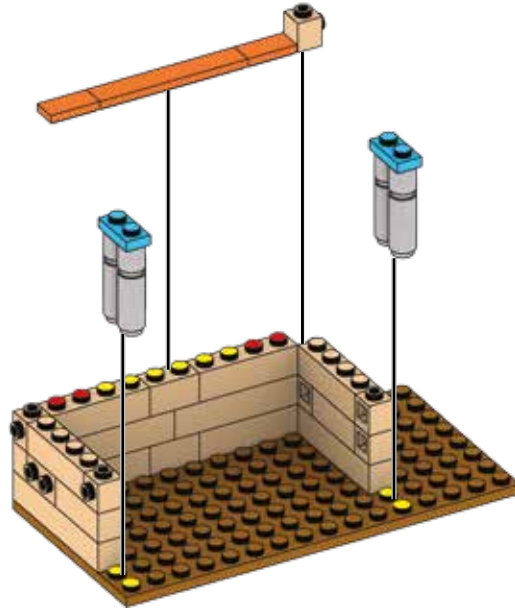

79

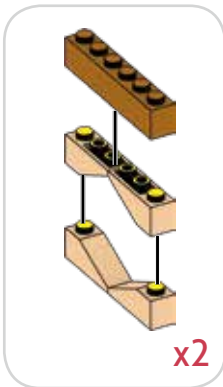
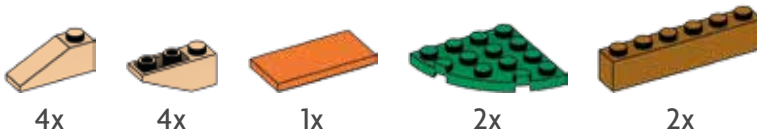

x2

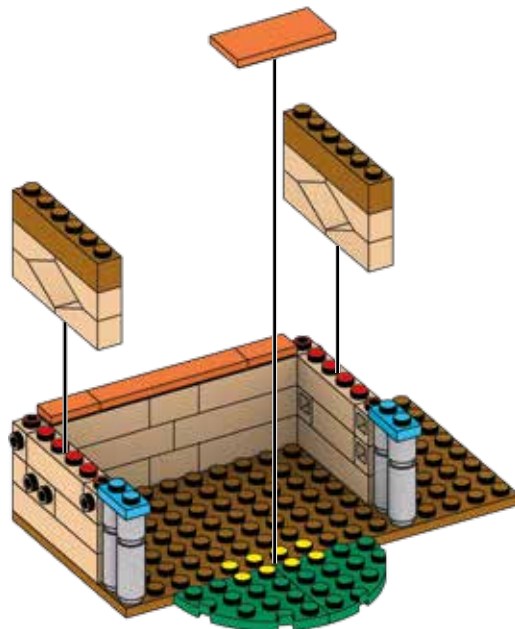



80

4x



2x

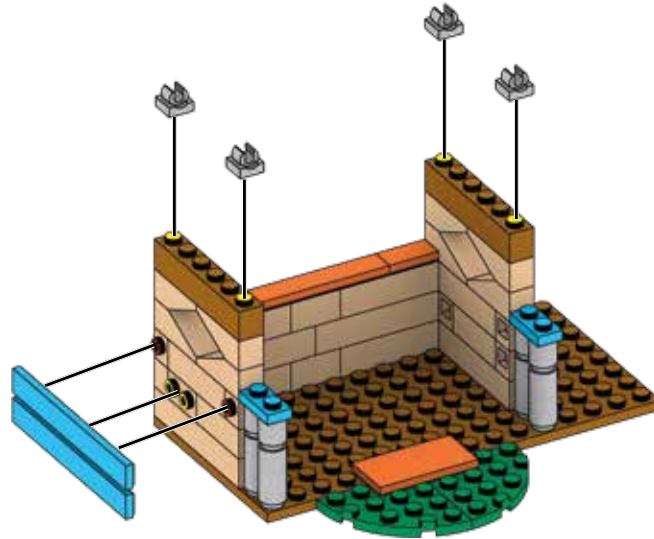

CONSEIL UTILE

Veille à tenir solidement le mur lorsque tu poses les blocs de parement bleus. Beau travail!

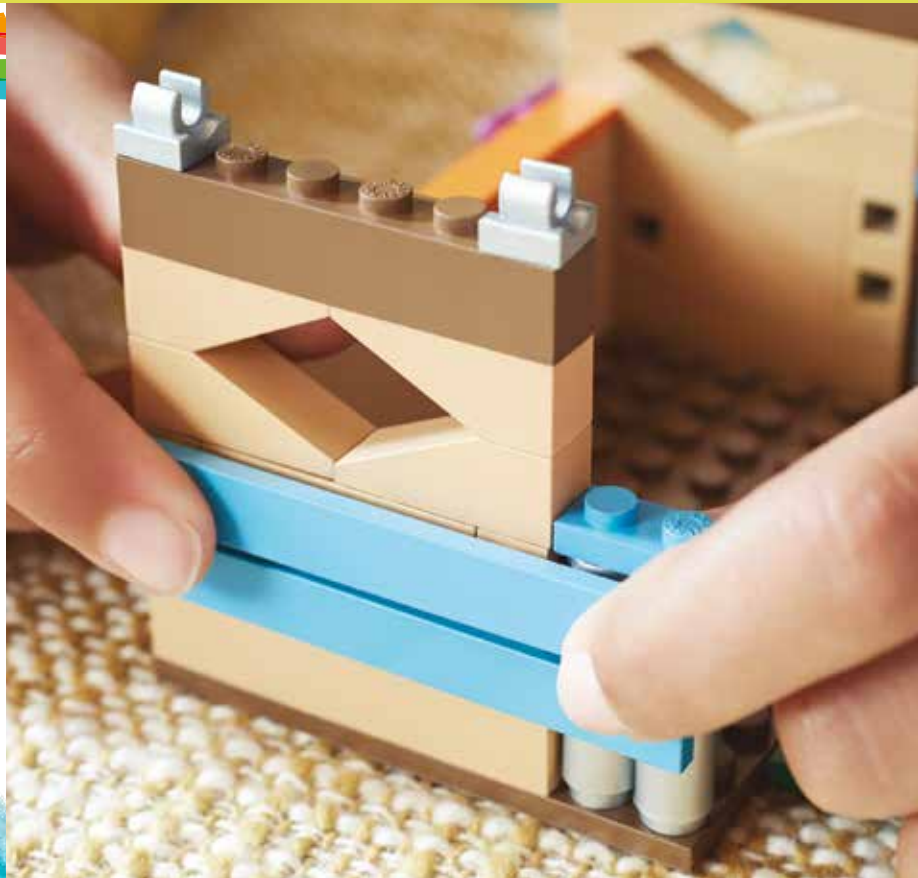



81

- 1x
- 1x
- 1x
- 1x

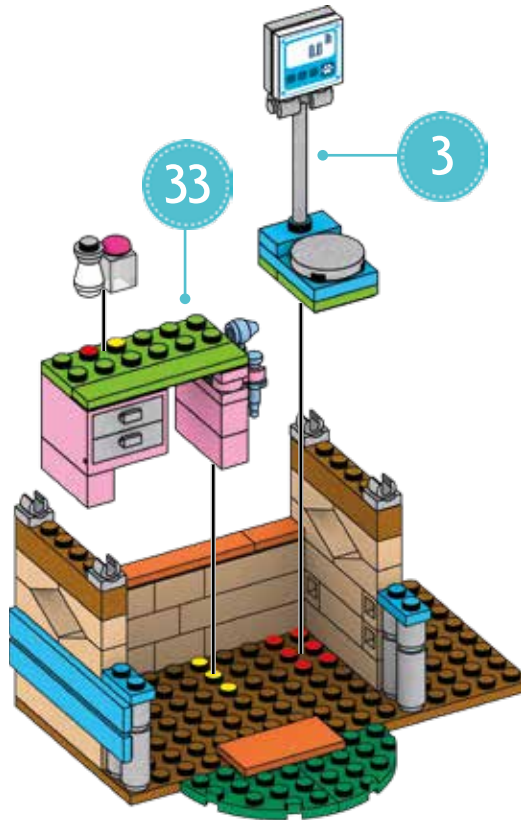
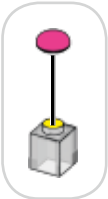

1



2

82

- 4x
- 4x
- 4x
- 4x
- 2x

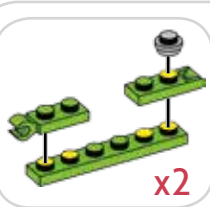

x2

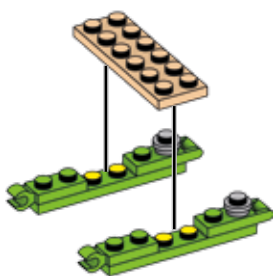

1

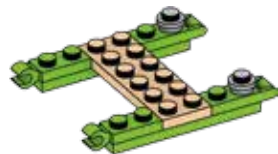

2

x2

83

- 1x
- 1x
- 2x
- 2x

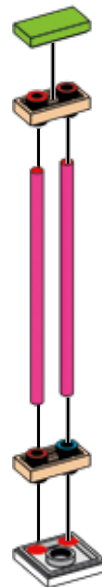

1



2



84

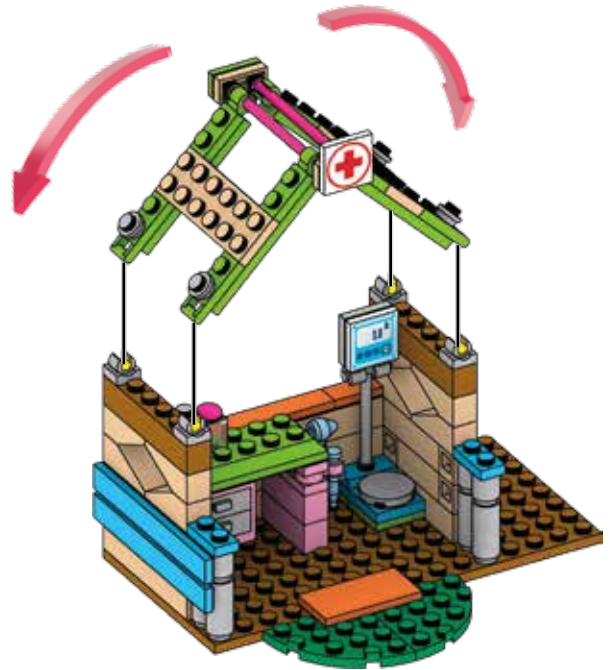
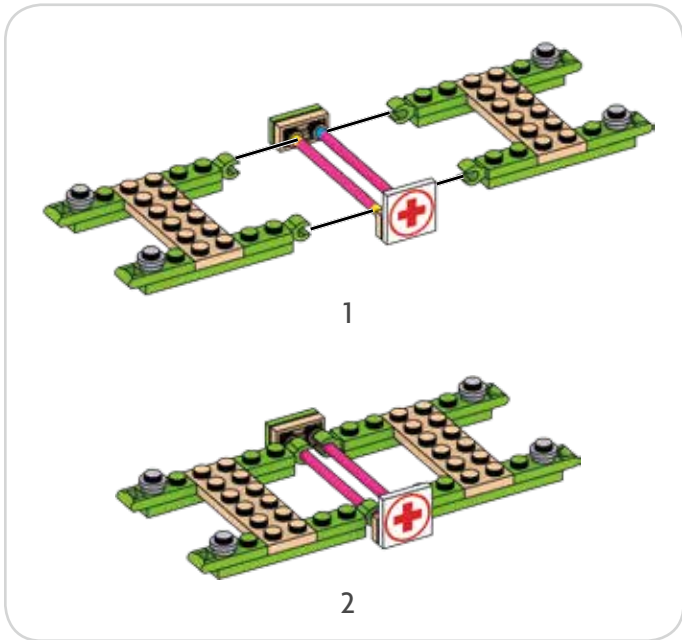

CONSEIL UTILE

Assure-toi d'utiliser tes deux mains pour poser ces blocs et construire le toit. Tu es une pro!





85

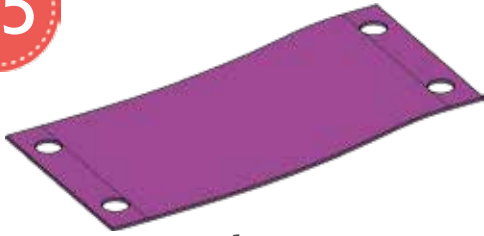

1x

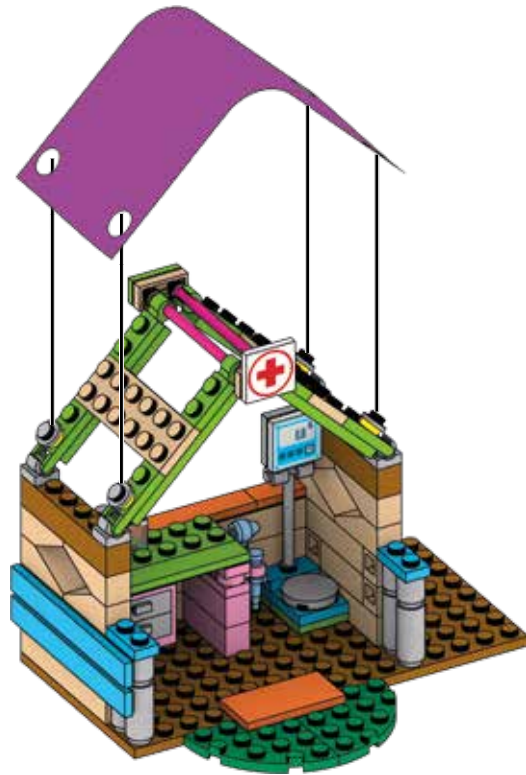

CONSEIL UTILE

Lorsque tu fixes le toit, étire le tissu serré pour l'installer sur les quatre facettes. Ça sera un excellent endroit pour prendre soin des animaux!





86



2x

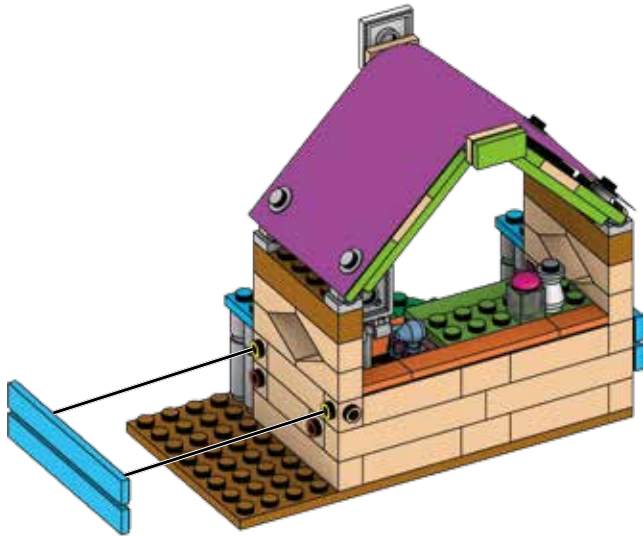

87



1x

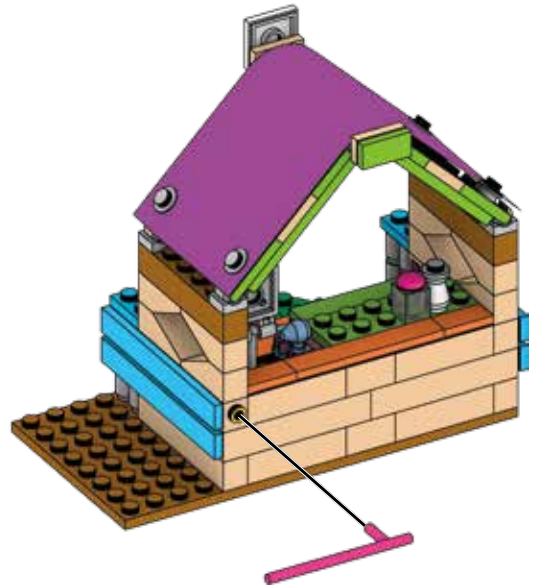

88



1x

1x

1x

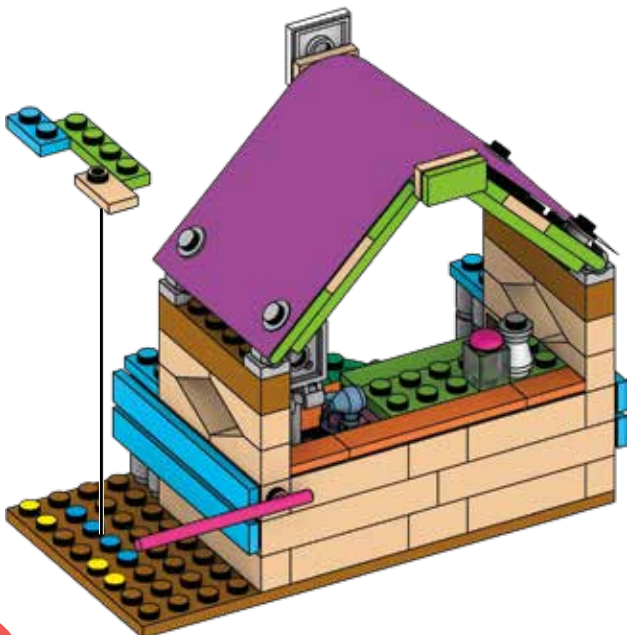

1

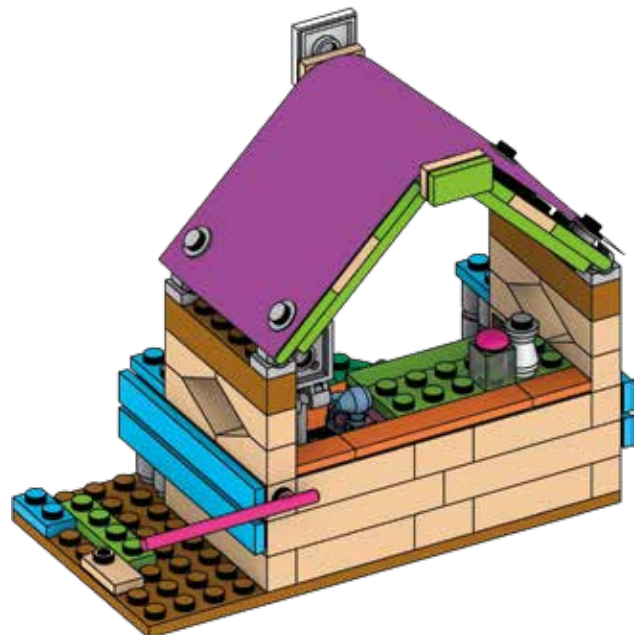

2



Lea adore la luxuriante forêt tropicale! Construis l'étang et le pont. Relie ensuite la tente du vétérinaire à la zone boisée.

89

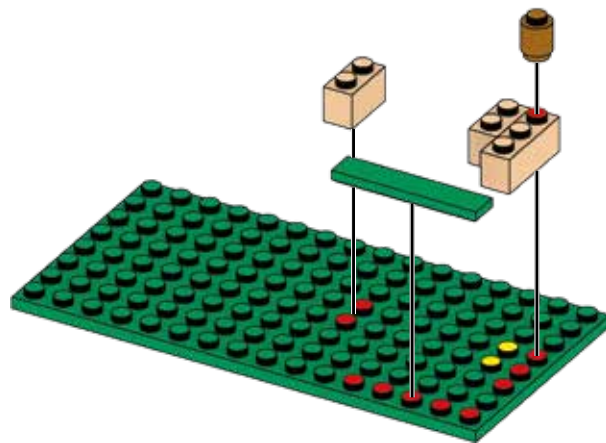
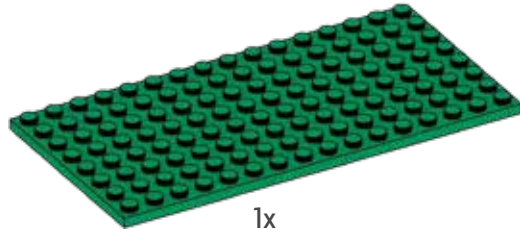
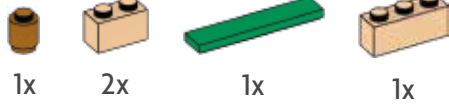

90



4x

91



1x 2x 2x

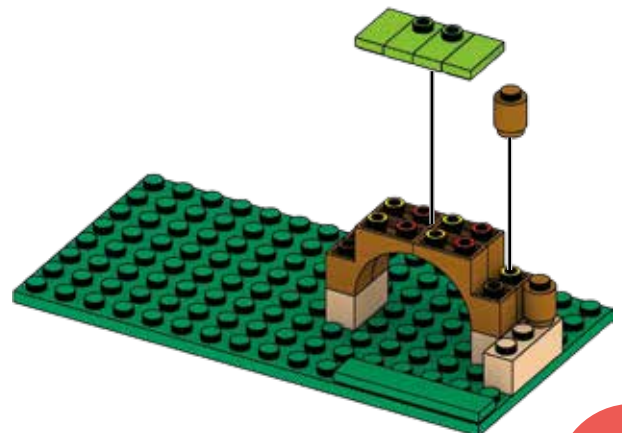
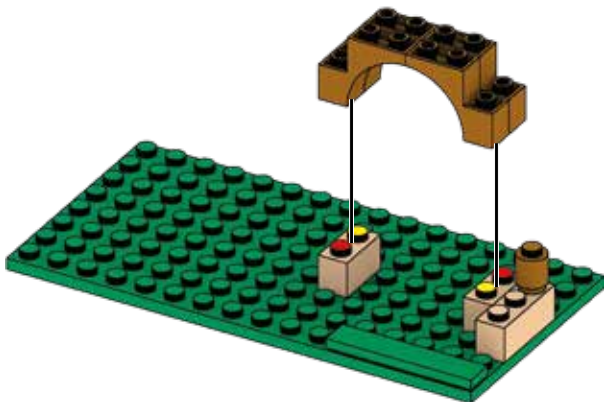



92

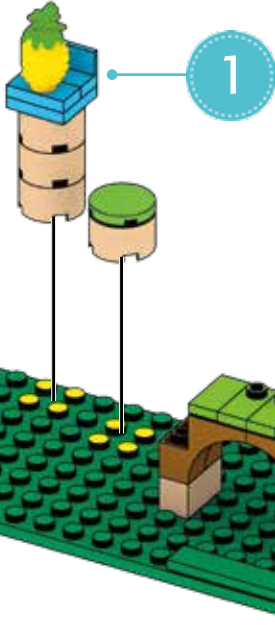
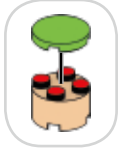

93

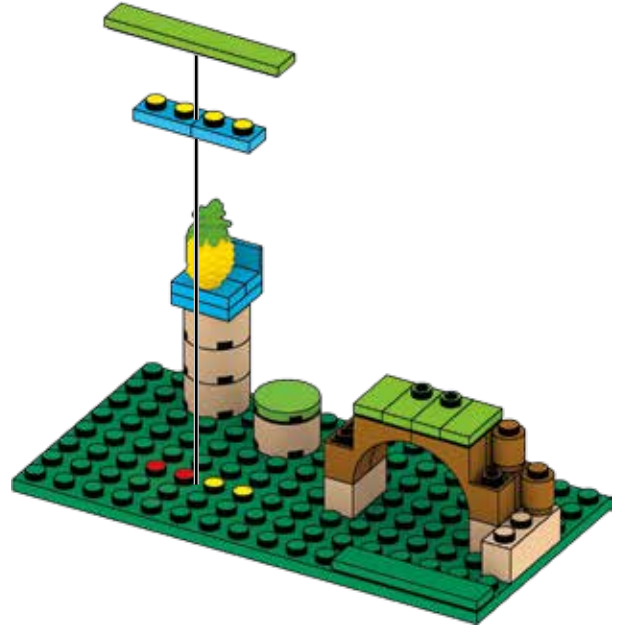
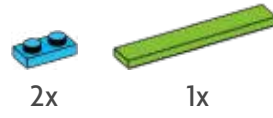

94

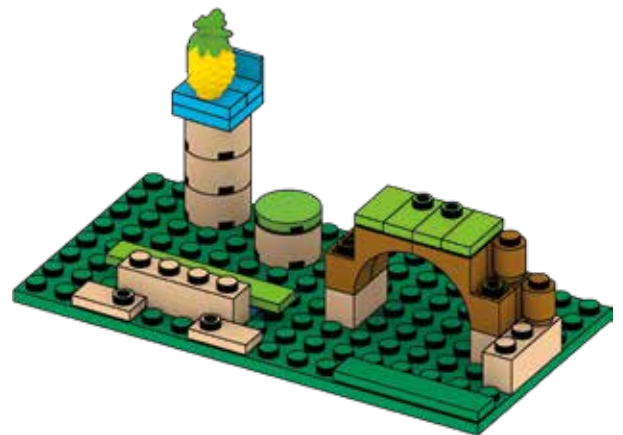
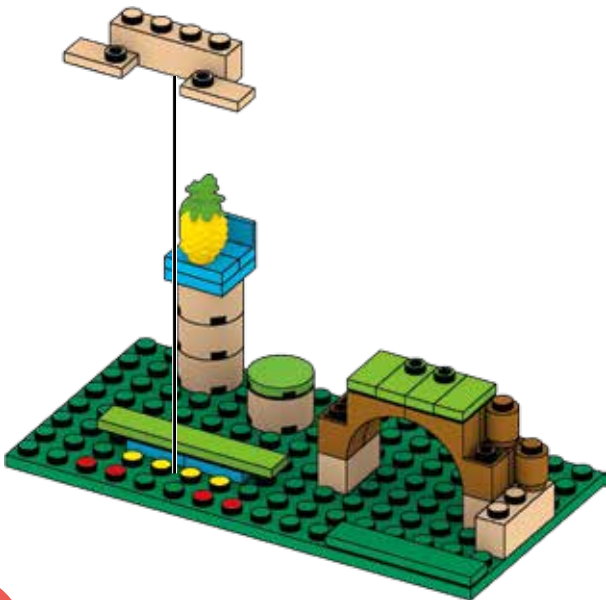
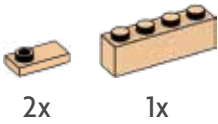

1

2



95

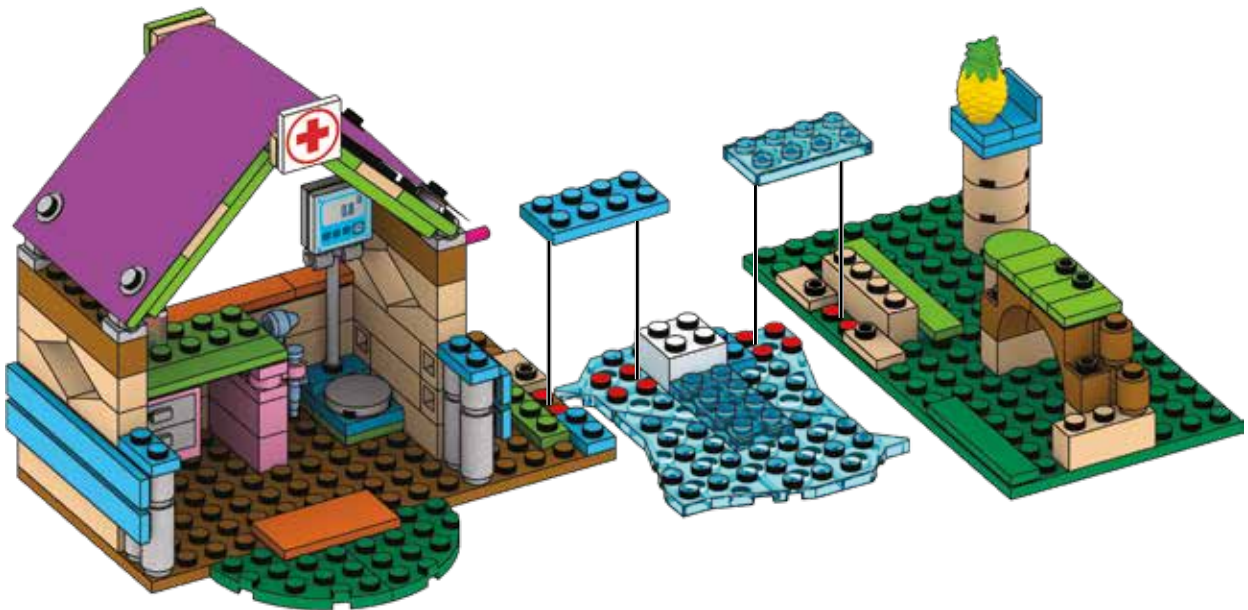
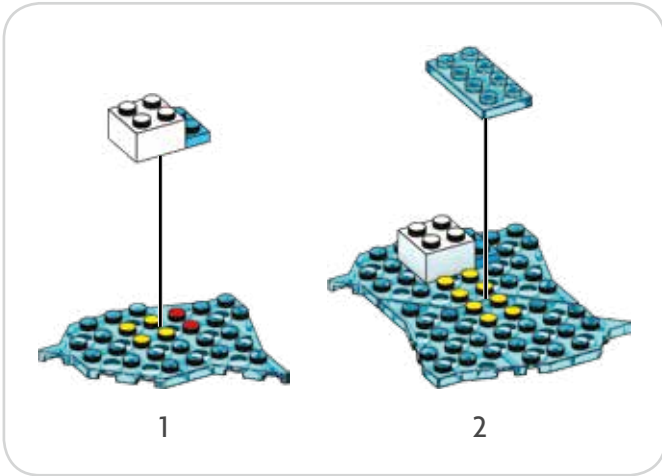
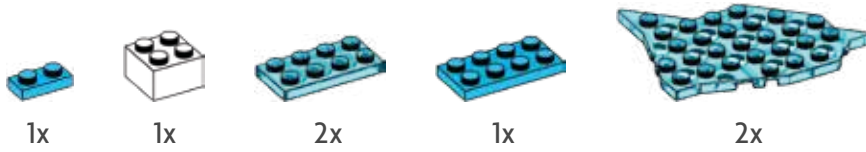



96

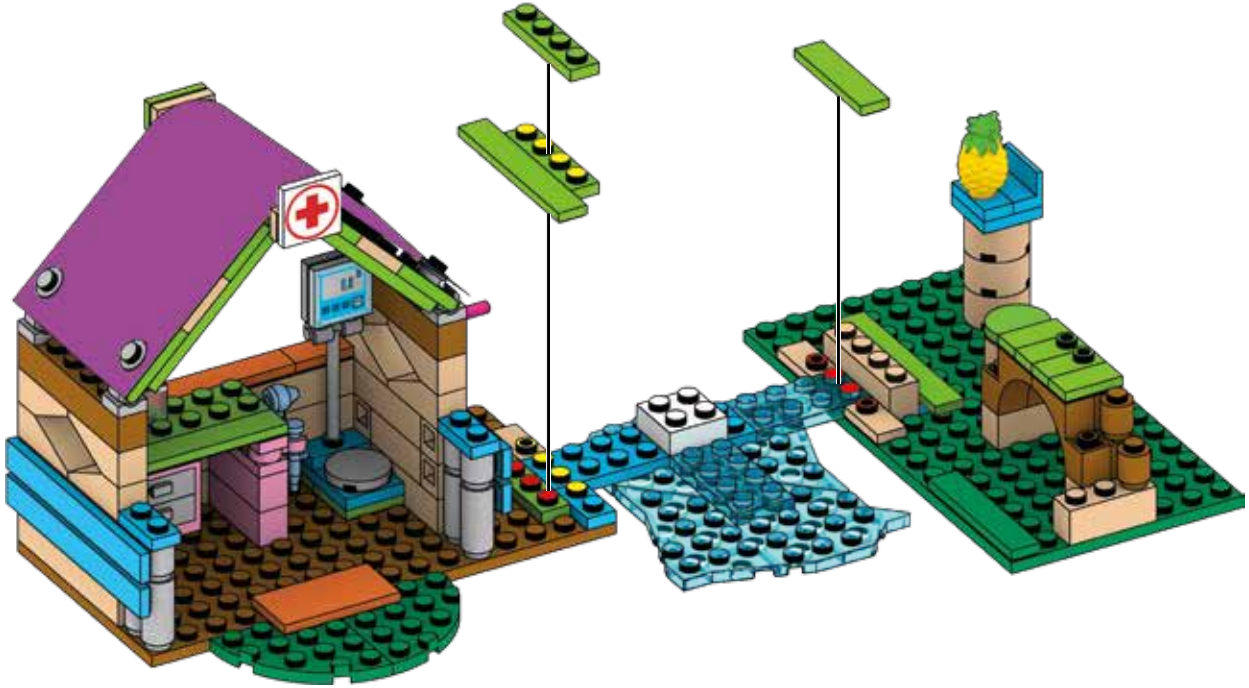
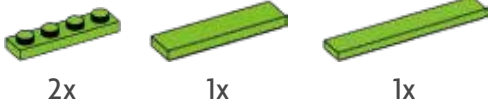

97

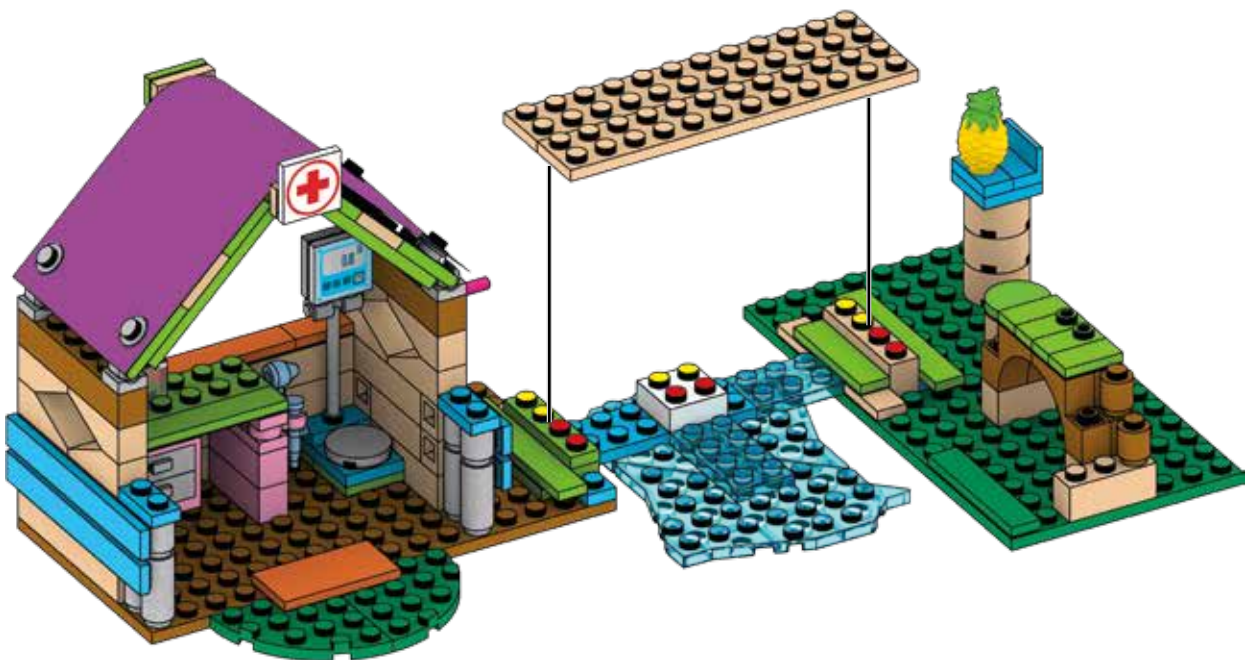
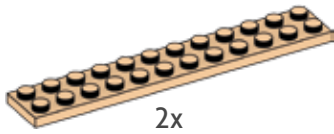



98

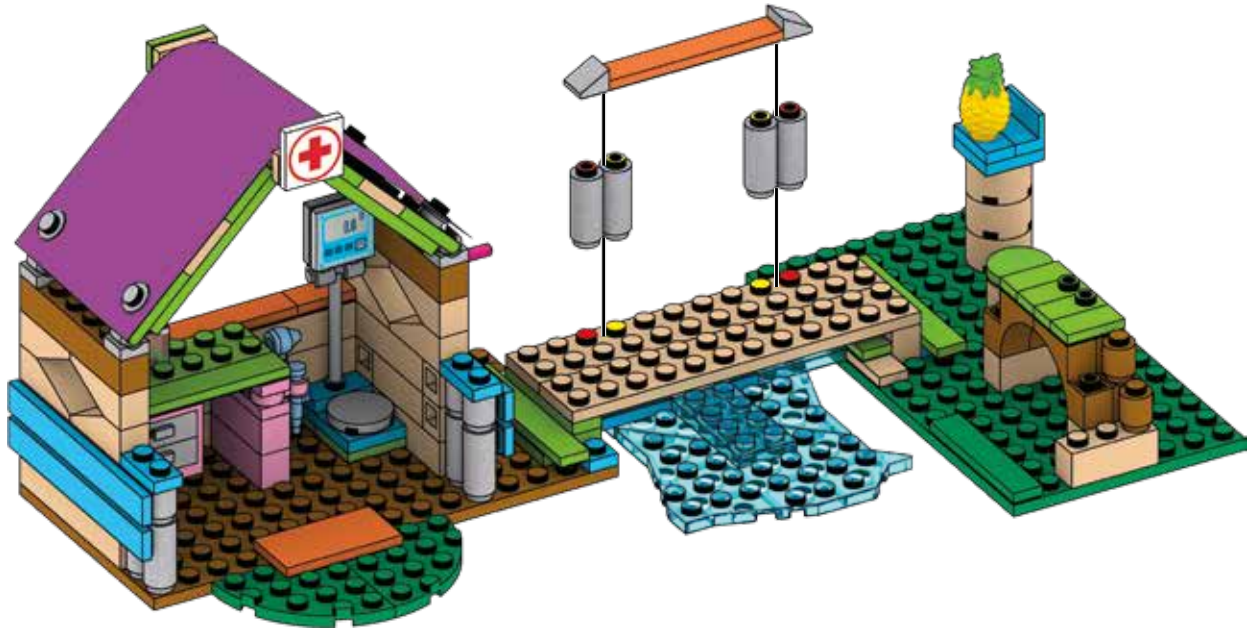
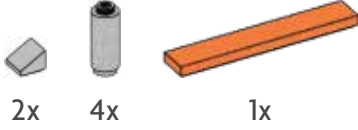

99

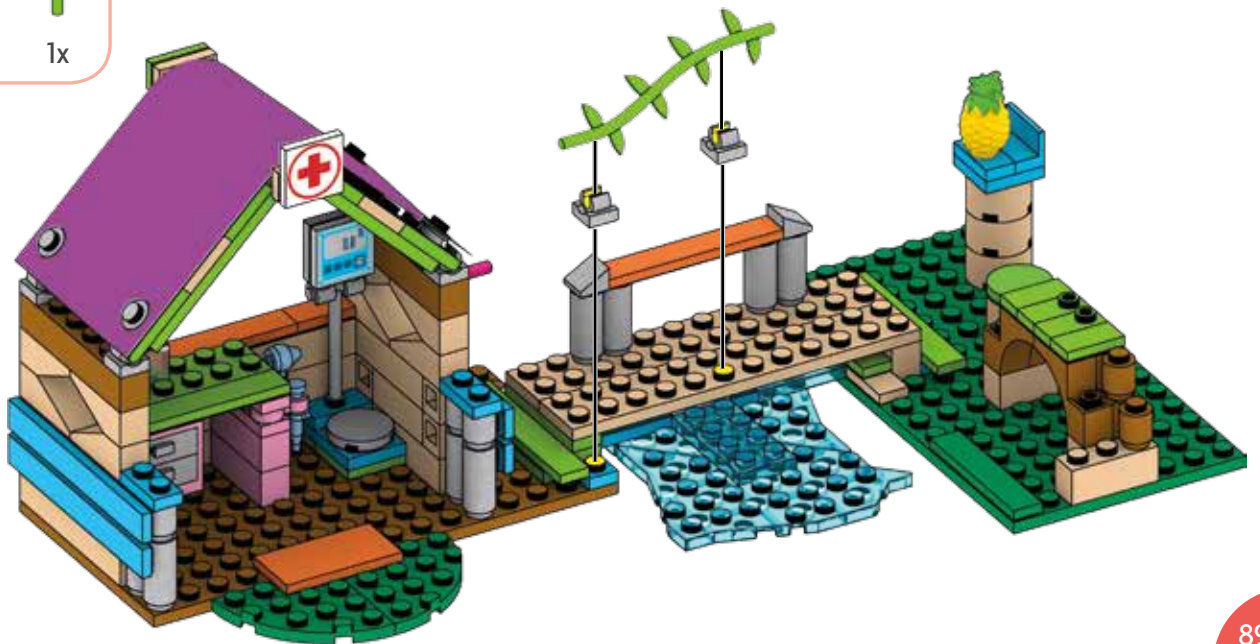
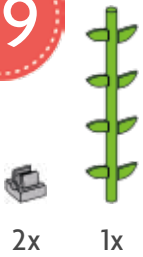



100



1x



1x

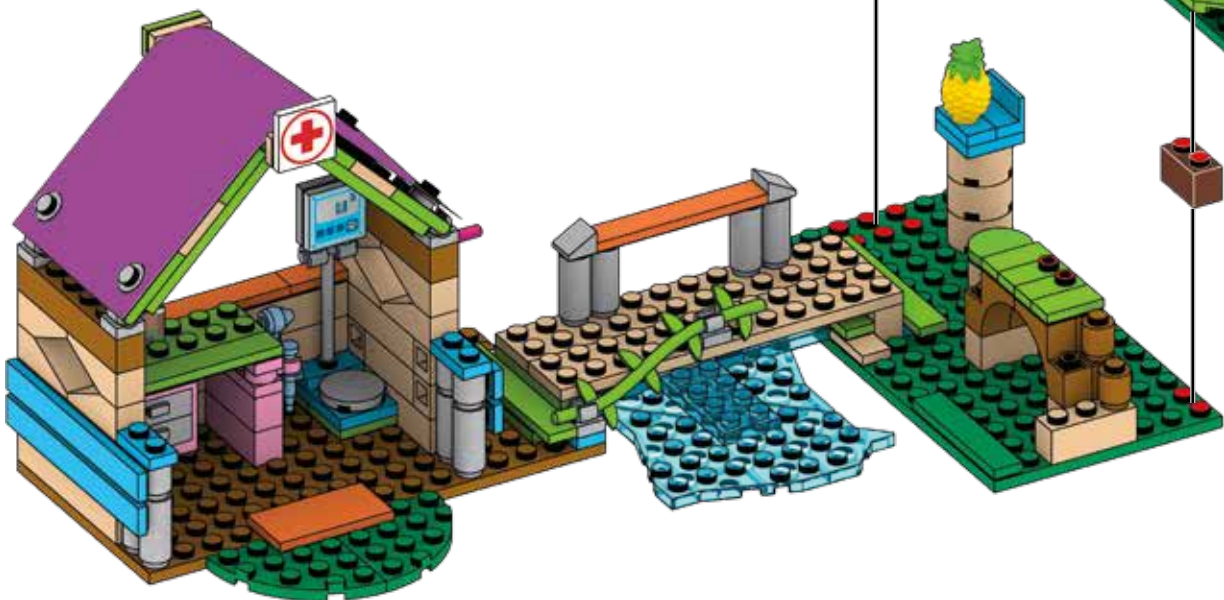



101



2x



3x



3x



x3

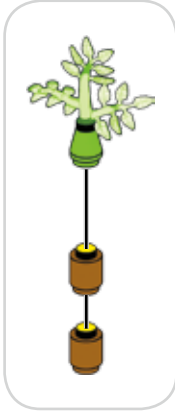



102



103

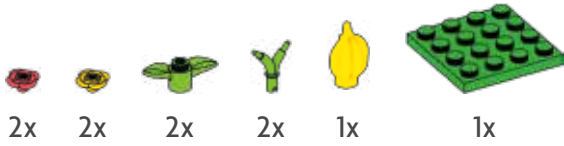



104

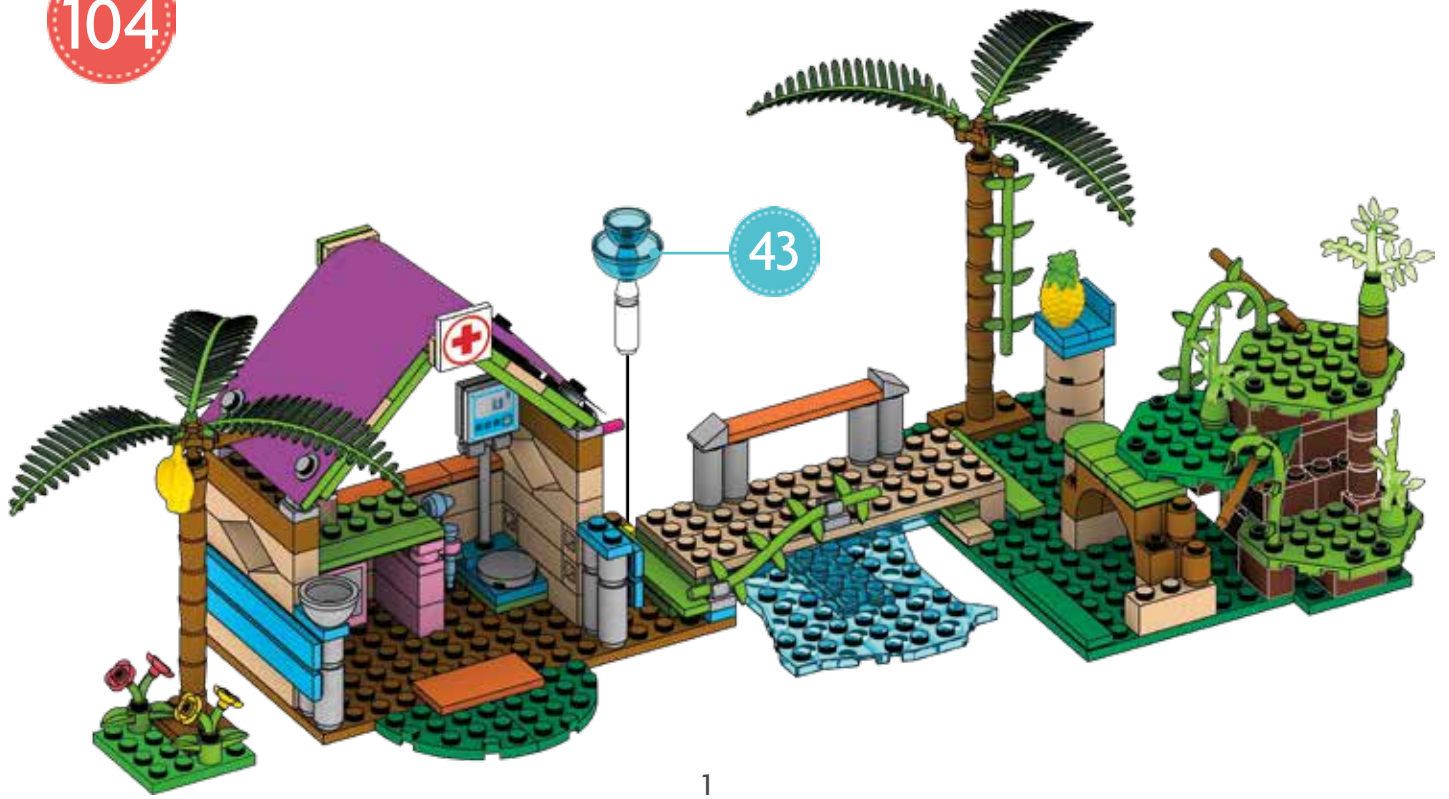



105



4x

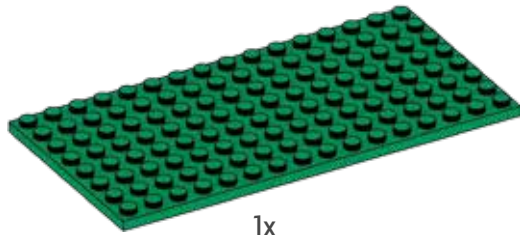

1x

Construis la tour de guet.
Lea peut tout voir de là-haut!

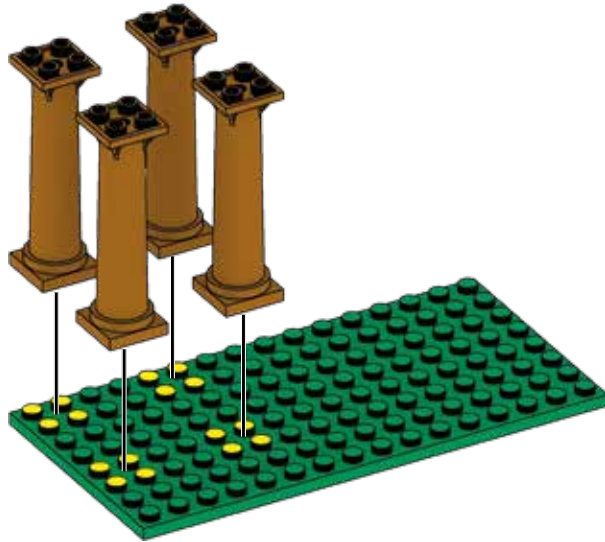

106



4x



2x



2x

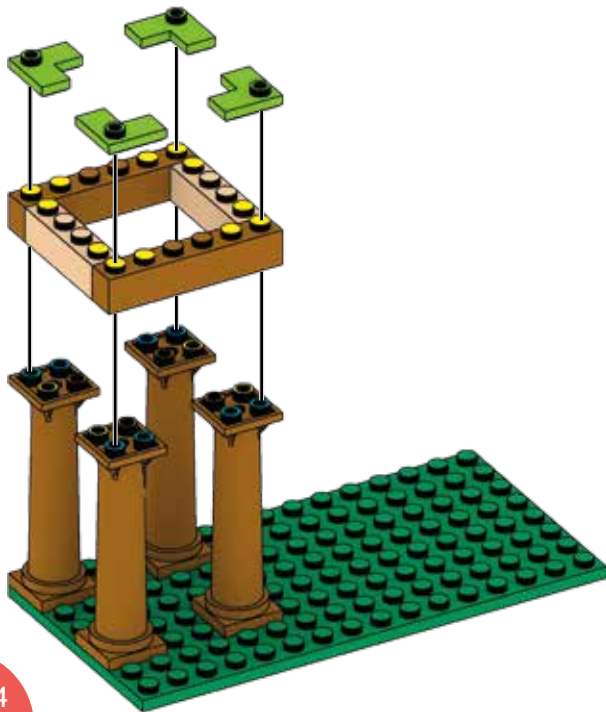

107



4x



4x



4x



8x



x4

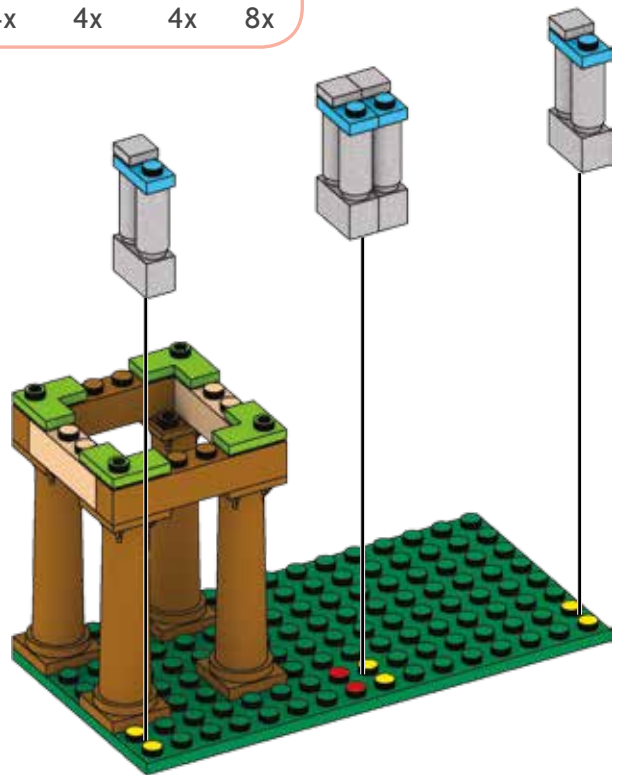



108



4x



2x

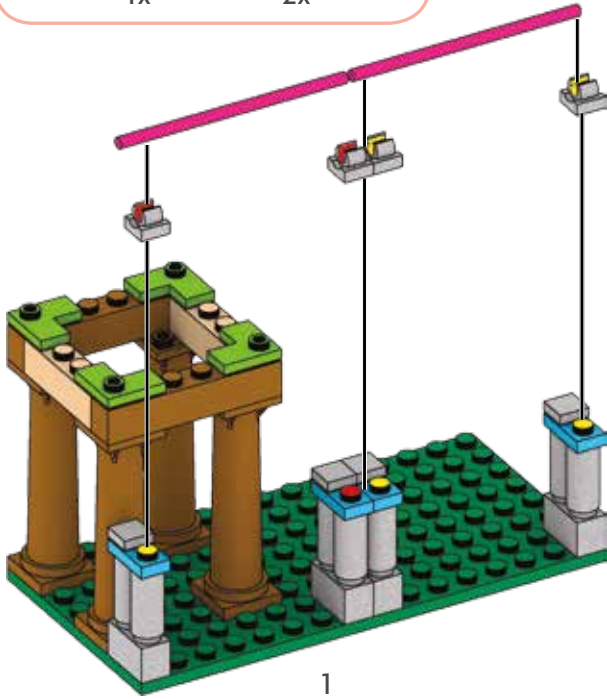

1

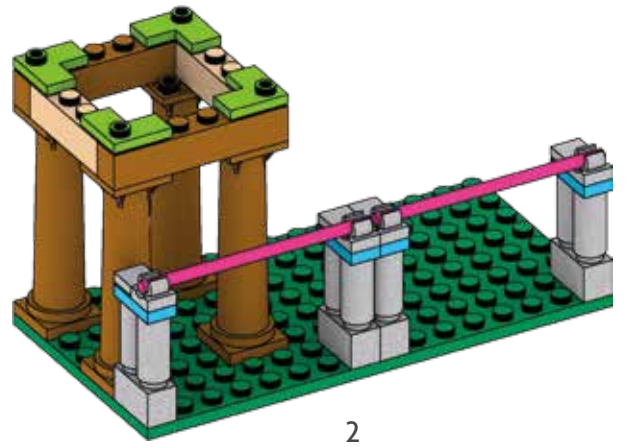

2

109



4x

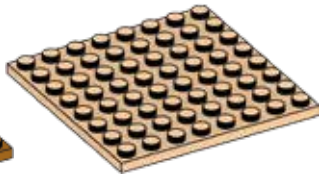

1x

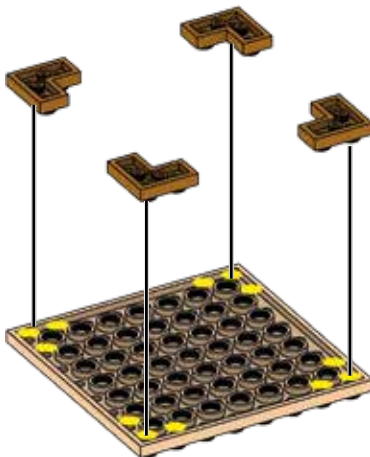

1



2



110

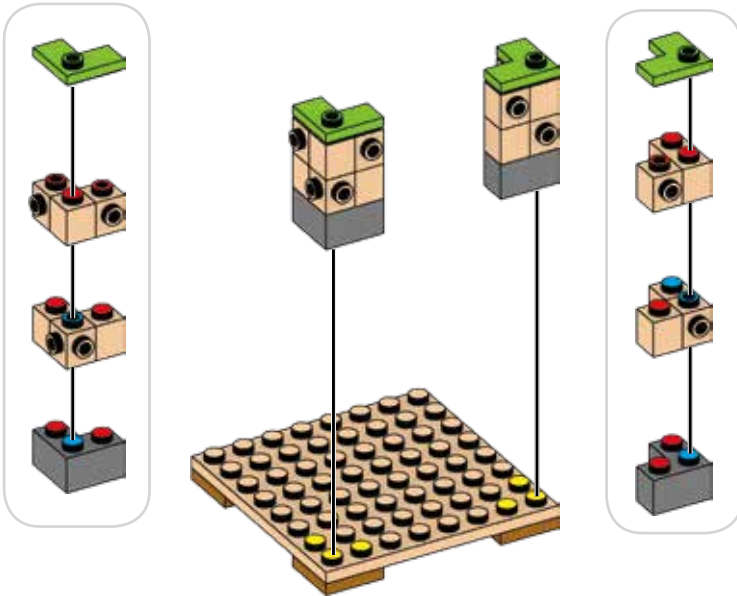

1

2

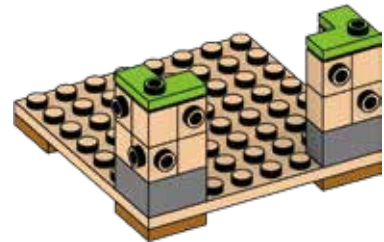

111

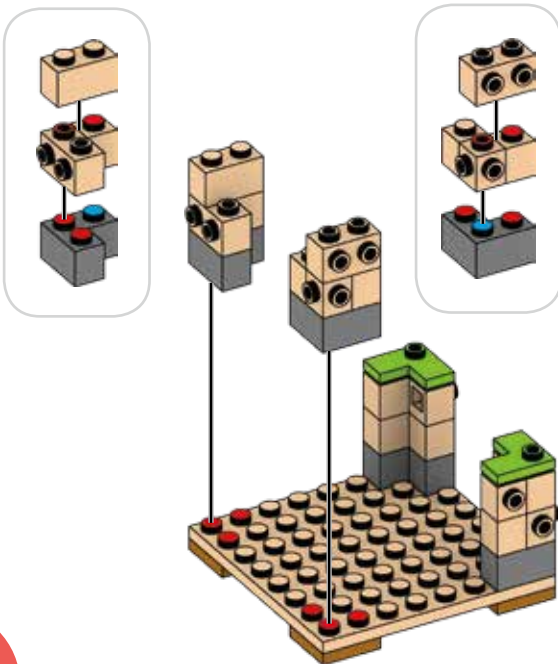
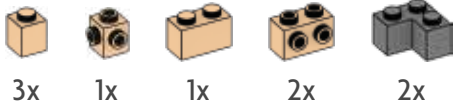

112

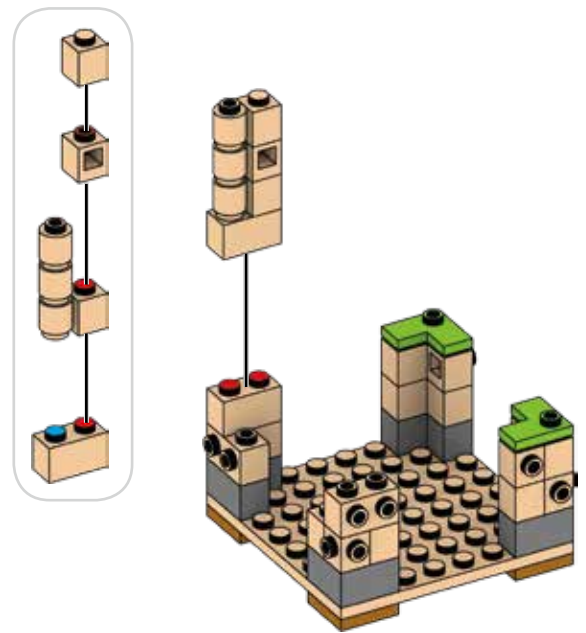
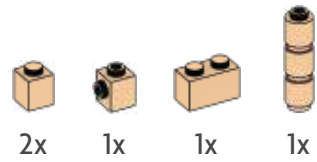



113



1x



1x

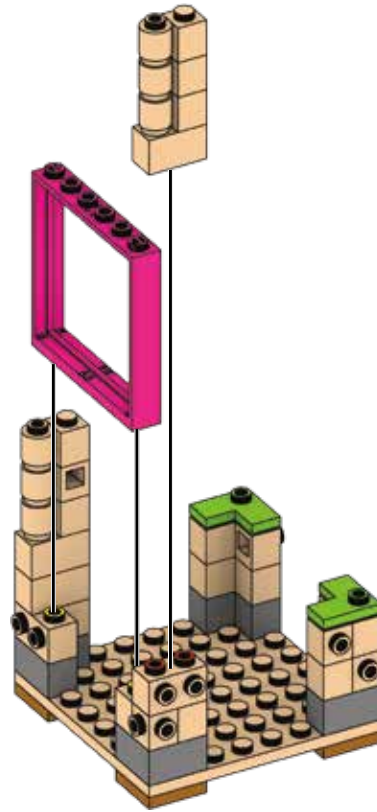
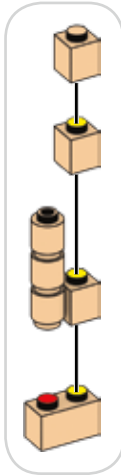

114

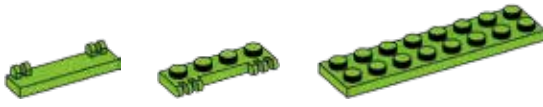

1x

1x

1x

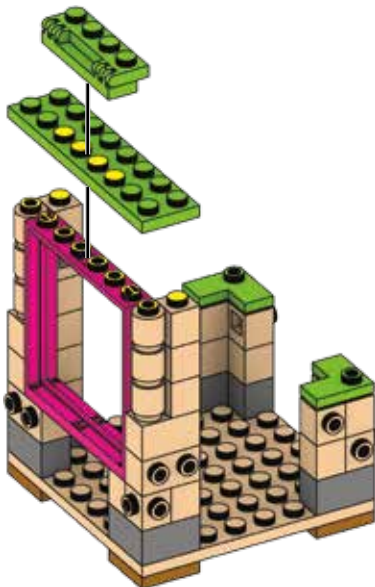
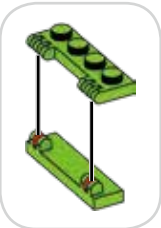

1

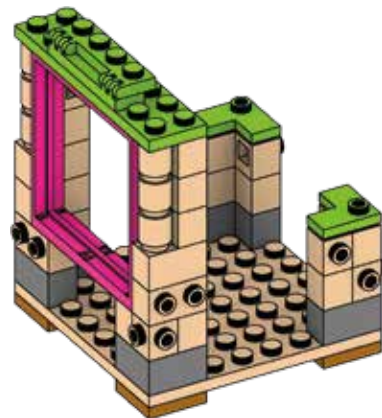

2



115

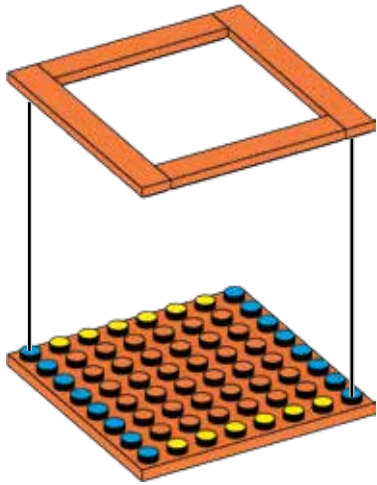
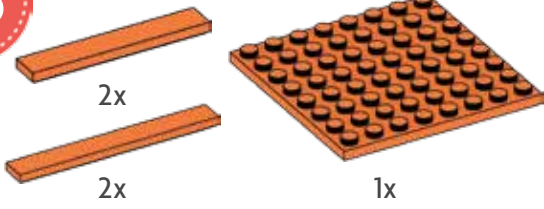

116

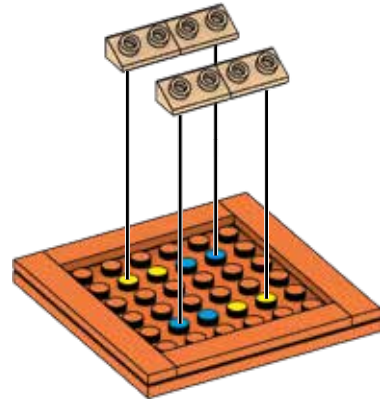

117

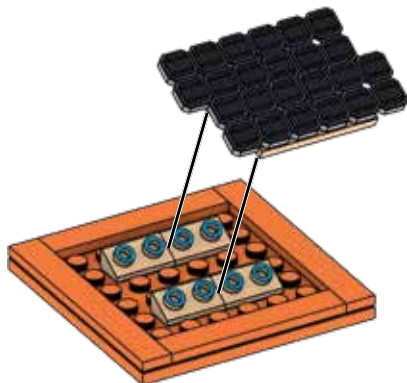
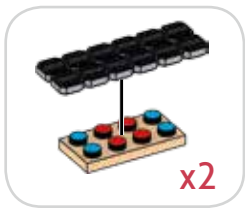

1



2



118

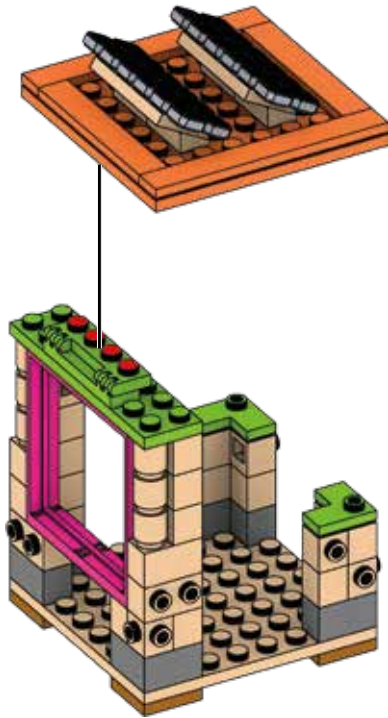

1

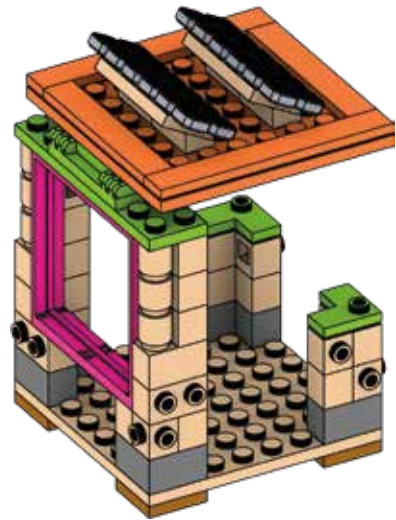

2



CONSEIL UTILE

Pour fixer le toit, relie-le à la pièce charnière à 4 points. Utilise tes deux mains pour le guider en place. Tu peux maintenant lever le toit avec facilité! Ces poteaux maintiennent le toit de panneaux solaires. Assure-toi de tenir les poteaux serrés lorsque tu fixes le bloc supérieur à ceux-ci.

C'est superbe!





119



2x



2x



1x

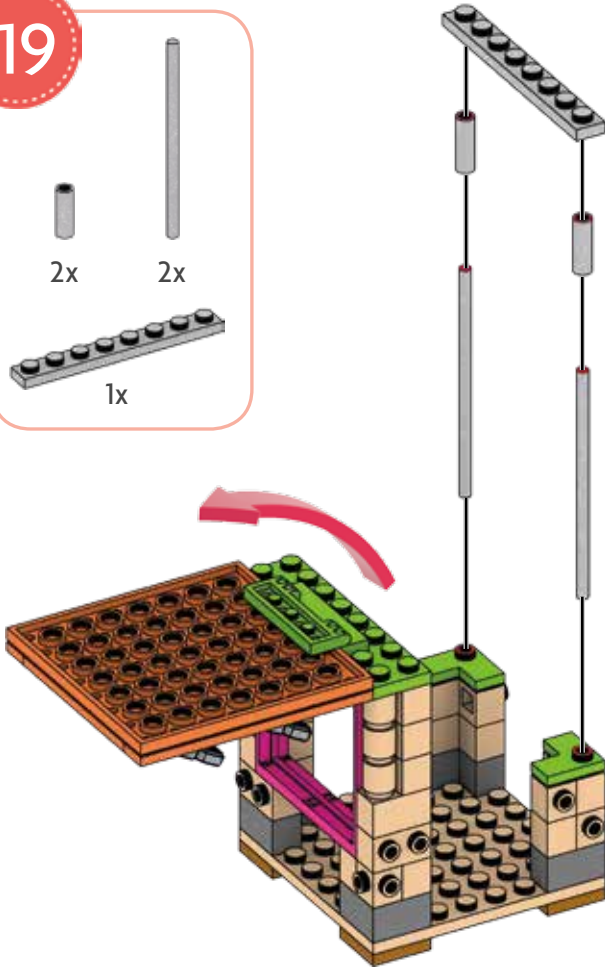

1

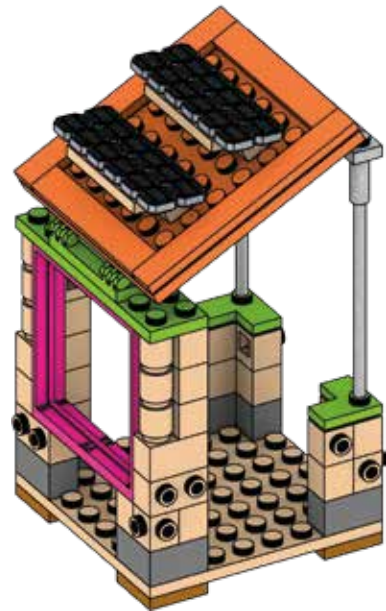

2



CONSEIL UTILE

Ces poteaux maintiennent le toit de panneaux solaires. Assure-toi de tenir les poteaux serrés lorsque tu fixes le bloc supérieur à ceux-ci. C'est superbe!





120



4x

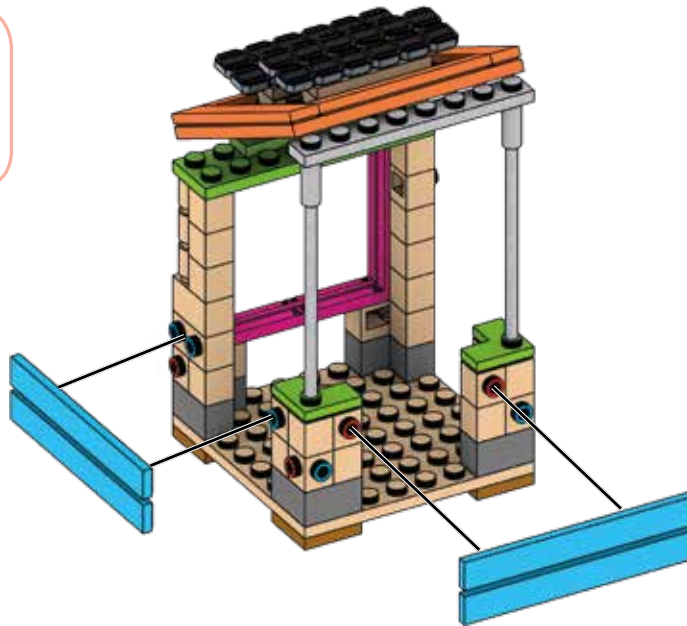

121

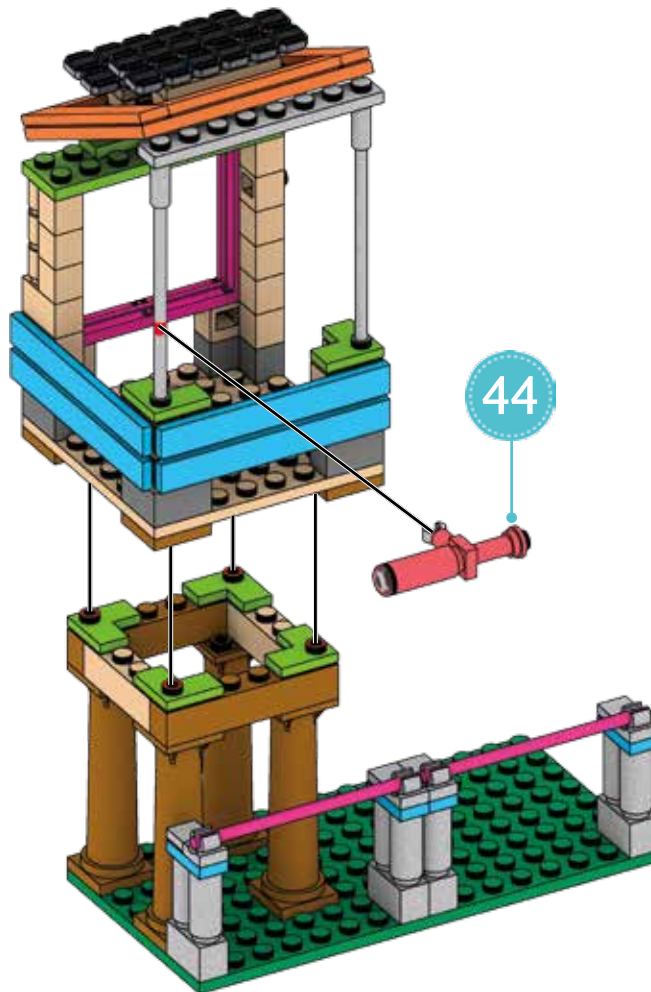



122



1x

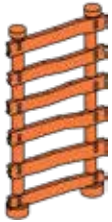

1x



1x

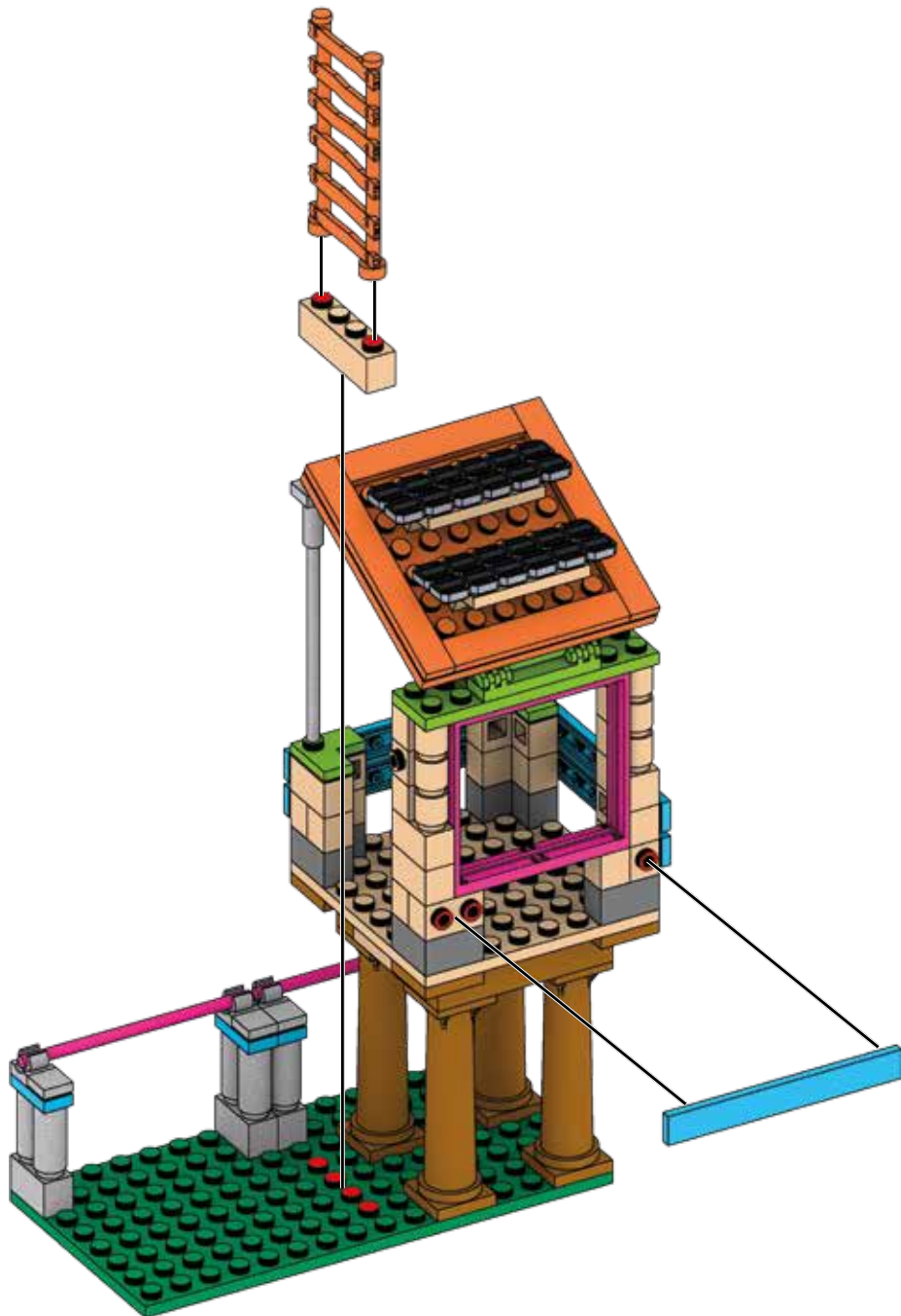



123

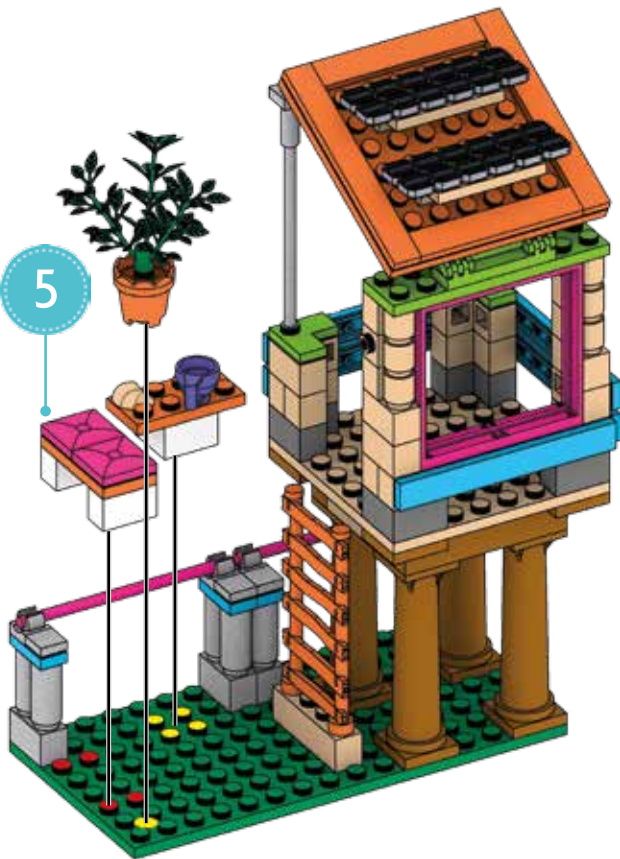
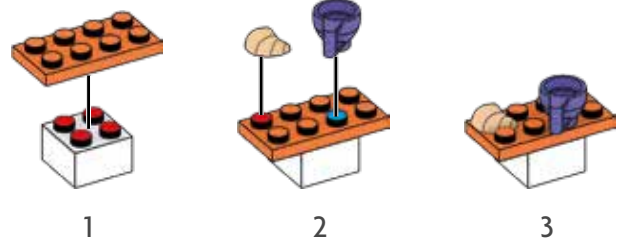
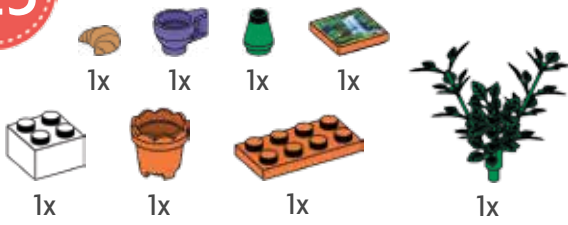

1

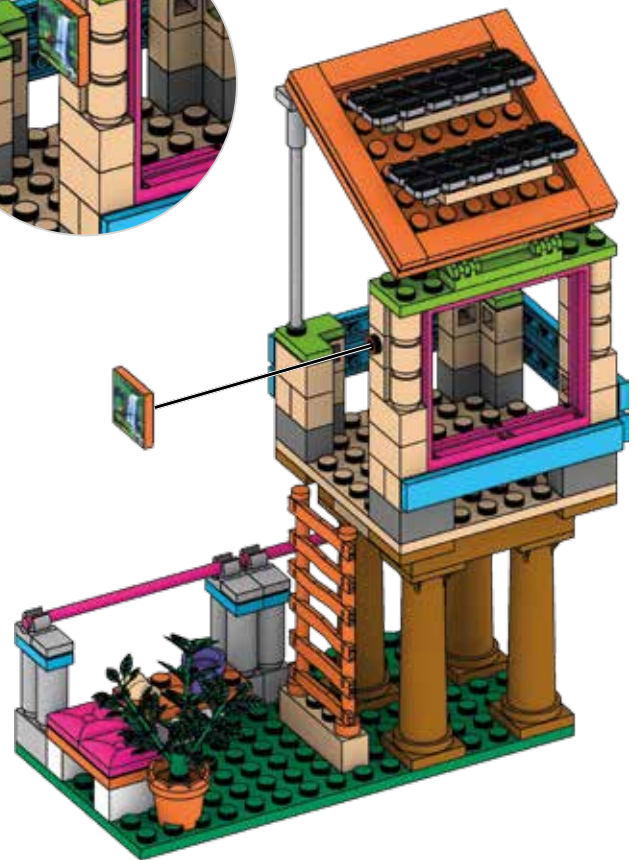
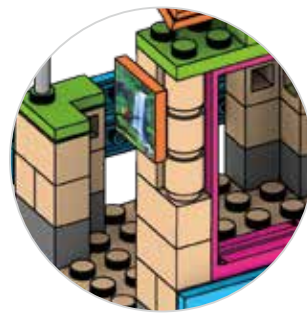

2



CONSEIL UTILE

Utilise tes deux mains pour fixer le deuxième étage à la tour. Essaie de fixer l'ensemble un côté à la fois. Une fois le premier côté relié, garde la main en place pour le tenir solidement pendant que tu enclenches le deuxième côté. Ta réussite est gigantesque!

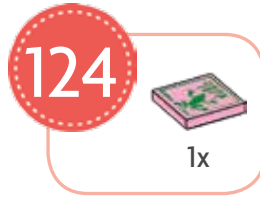



125

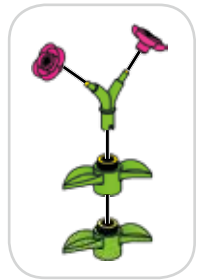
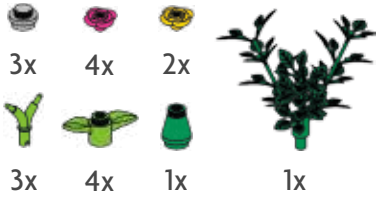



126



2x



2x



2x



1x



1x



1x



1x



1x



1x

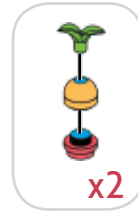



127



1x



1x



1x



1x

BEAU TRAVAIL!

Tu as construit le Sauvetage
à la tour de guet de Lea!



CRÉE TON HISTOIRE

Tu peux créer encore plus d'histoires American Girl en ligne.
Construis tes propres histoires et découvre ce que d'autres filles ont créé.
Parce qu'ensemble, on peut aller beaucoup plus loin!





Dessine un oiseau fantaisiste

Exerce-toi ici!



1. Dessiner un V courbé avec un ovale sur celui-ci. Ajoute une ligne pour la narine. Dessine un œil rond.

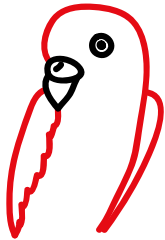

2. Dessine une longue courbe pour la tête et le corps. Ajoute des ailes.



3. Dessine les pieds et un perchoir. Dessine une queue. Termine le bec. Ajoute des rayures aux ailes.



Questionnaire sur les animaux

Quel animal correspond à ton style?
Réponds à ce mini questionnaire pour le découvrir.

1. Lorsque tu fais du gardiennage, tu divertis l'enfant en :

- a. coloriant des images avec lui.
- b. jouant à un jeu.
- c. créant une histoire.

2. Sur le boîtier de ton ordinateur portable, il y a :

- a. des autocollants scintillants.
- b. des gribouillis aléatoires.
- c. des images d'animaux adorables.

3. Quelles chaussures porterais-tu?

- a. Espadrilles arc-en-ciel
- b. Ballerines à motifs
- c. Mocassins chauds et doux

4. Lorsque tu lis un nouveau livre, tu aimes :

- a. regarder les illustrations.
- b. savoir que tes amis ne l'ont pas encore lu.
- c. lire dans un fauteuil confortable pendant un après-midi tranquille.

Ton style est :

Réponse « a » pour la majorité des questions :
coloré comme un paon.

Réponse « b » pour la majorité des questions :
audacieux comme un zèbre.

Réponse « c » pour la majorité des questions :
confortable comme un paresseux adorable.



Coloriez l'image



★ American Girl®

© 2016 AMERICAN GIRL. Tous droits réservés.
American Girl ainsi que les marques et designs y afférents appartiennent à American Girl.



- 2x AM75332W
- 1x AM75332ACJ
- 2x AM78802FM
- 2x AM78802ANY
- 3x MI113ZD
- 5x MA113RQ
- 12x MA113APG
- 2x AM72954RQ
- 4x AM72954BYE
- 4x AM72954ACJ
- 2x MA17003APG
- 2x AM17062APG
- 1x AM76060APG
- 4x MA07223APG
- 4x MA07223GD
- 2x MA03328AMR
- 2x MA03328APG
- 1x MA03328ASX
- 3x MA03328E
- 4x MA03328RQ
- 4x AM78803HT
- 10x MA19999APG
- 1x AM78800VL

- 1x MA1312APG
- 2x MA12251ASX
- 2x MA12251MY
- 1x AM18591MY
- 2x MA19328E
- 1x AM76058RQ
- 2x AM18592JS
- 2x AM18592APG
- 2x AM18287APG
- 6x MA17127APG
- 2x AM08412BMG
- 1x AM08412GD
- 2x AM08412E
- 3x AM08412JS
- 4x MA0910APG
- 4x MA0910MY
- 2x M0910ZD
- 1x MA0910F
- 2x AM15485ACJ
- 2x AM76959ACJ
- 4x MA07659RQ
- 2x MA07659MY

- 1x MI086W
- 18x MA1086AMR
- 1x MA1086E
- 2x MA1086BDG
- 17x MA07629AMR
- 3x AM18286AMR
- 2x AM19900MY
- 6x AM78726JS
- 5x AM78722JS
- 1x AM76329I
- 1x AM76329ACS
- 1x AM76330I
- 1x AM76330ACS
- 1x AM78799I
- 1x AM78799ACS
- 1x AM73975ACJ
- 1x AM72931APG
- 1x AM18260APG

- 3x MA17506APG
- 1x MA17506RQ
- 2x MA18256MY
- 16x AM09129APG
- 1x AM09129RQ
- 1x AM09129E
- 8x AM78953MY
- 2x AM19901AMR
- 1x AM19901DH
- 1x AM72922F
- 1x AM19611AMP
- 1x AM19752BYE
- 1x AS-DXW90-01
- 2x AS-CNF54-01

- 1x MA022501GD
- 4x MA022501RQ
- 4x MA022501JS
- 2x MA022501BOR
- 3x MA022501E
- 1x AS-FDY98-04
- 4x MA73758AMR
- 6x MA73758JS
- 2x MA07590E
- 1x MA07590APG
- 3x MA07590GD
- 1x MA09393DH
- 3x MA09393APG
- 10x MA09393GD
- 2x MA09393E
- 2x MA18901ASX
- 4x MA72002RQ
- 2x MA72000ASX
- 1x AM19660APG

- 4x MA16954JS
- 4x MA16975JS
- 1x AM72917E
- 4x MA16680AMR
- 4x AM18272AMR
- 4x MA07228GD
- 2x MA1417AMR
- 2x MA1322AMR
- 1x MA09013DH
- 6x MA09013APG
- 15x MA09013E
- 1x MA09013ASX
- 35x MA09013AMR
- 1x MA17502RQ
- 16x MA17502AMR
- 1x AM02215APG
- 1x AM02215HT

- 1x AM73974BYE
- 1x AM17672BOR
- 1x AM73025APG
- 1x AM73025AAV
- 1x AM73026AAV
- 8x AM74428JS
- 4x MA15484MY
- 6x MA17153AMR
- 6x MA17153BDG
- 1x AS-FDY98-05
- 1x AS-FDY98-03
- 1x AS-FDY98-06
- 2x MA0948AMR
- 1x AS-FDY98-07
- 1x AS-FDY98-08

6x AM17836AWB
 1x AM73009AWB
 2x AM72956ACJ
 1x AS-FDY98-09
 1x AM15013AWB
 2x MA03773BDG
 2x MA03773AMR
 3x MA03773GD
 1x MA03773DH
 4x AM74106ACJ
 1x AM74106APG
 1x MA18328APG
 4x MA18671BDG
 4x MA1320AMR
 2x MA1154E
 4x MA1154AMR
 2x MA09023BDG
 2x MA09023DH
 4x MA09023E

2x MA09023RQ
 2x AM72264ASX
 2x MA1314ASX
 1x MA1314MY
 4x MA1323AMR
 4x MA1418AMR
 3x MA16384ASX
 4x MA16384AMR
 4x MA16384BDG
 4x AM78916MY
 1x MA03772GD
 2x AM17509MY
 2x MA03772BDG
 2x MA03873DH
 1x AM74798W
 2x AM72944APG
 1x AS-FDY98-10
 1x AM78171E

2x MA01847APG
 2x MA09838JS
 2x MA09838AMC
 5x MA09838AMR
 2x MA09593ASX
 1x MA09593RQ
 4x MA09593JS
 1x AM01390JS
 1x AM01389JS
 1x MA1087JS
 1x MA1087E
 13x MA1087AMR
 3x MA1087BDG
 4x MA09493BOR
 1x MA09493RQ
 1x MA09493GD
 2x MA09493BDG
 2x MA09493AMR
 2x MA09493AMR

7x MA09493JS
 2x M09493ATB
 2x AS-DPK83-06
 1x AM77463BOR
 1x AS-FDY98-02
 3x MA09033DH
 1x AM17426BYE
 2x AM72089MY
 1x AM72089APG
 1x AM18524ACJ
 2x AM18524MY
 8x AM17793GD
 1x AM17793BMG
 4x MA16331JS
 4x MA16331BOR
 4x MA09292JS
 4x MA1313AMR
 2x MA1313BDG

4x MA1313MY
 1x AM72333AQX
 2x MA1480JS
 5x MA1480BOR
 2x MA1480AMR
 2x MA09922AMR
 13x MA09922GD
 2x MA09922BOR
 1x MA18298E
 1x MA18298APG
 3x MA10233BDG
 1x MA08483BDG
 1x MA08483JS
 1x MA09923AMR



1x AS-FDY98-11



4x AM16907RQ



1x AM72928ASX



2x MA74680BMG

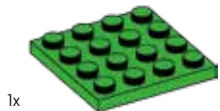

1x MA17054HT



6x AM78806HT

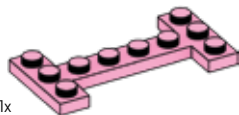

1x AM17063ASX



2x AM18778JS

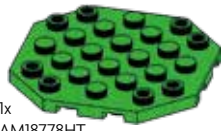

1x AM18778HT



1x MA17055BMG



2x AM73222ATB



3x AM76226WH



2x AM77653ARD

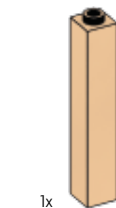

1x AM16289AMR



4x AM78727JS

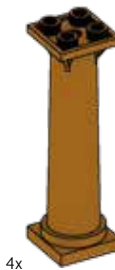

4x AM03318MY



2x AM76416ACJ



3x AM19003ACJ



2x AM77498BOR



1x AM01895BOR



4x AM18259ACJ



2x AM18259APG

ATTENTION : DANGER D'ÉTOUFFEMENT. - Présence de petits éléments. Ne convient pas aux enfants de moins de 3 ans.



Il est recommandé de lire attentivement ce feuillet avant la première utilisation et de le conserver pour référence future.

© 2016 AMERICAN GIRL. Tous droits réservés. Patent pending. American Girl ainsi que les marques et designs y afférents appartiennent à American Girl. Brevet en instance. (P) D714, 887



1x AS-FDY98-01

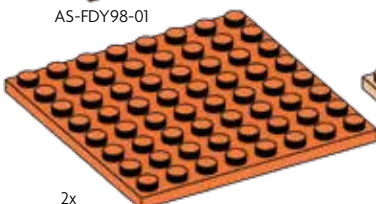

2x MA18556BOR

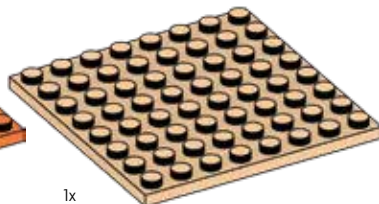

1x MA18556AMR

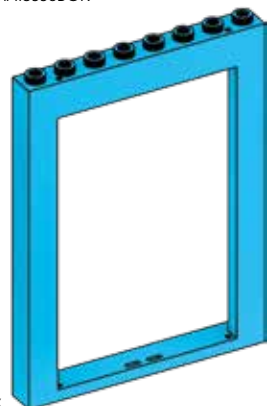

2x AM72863GD

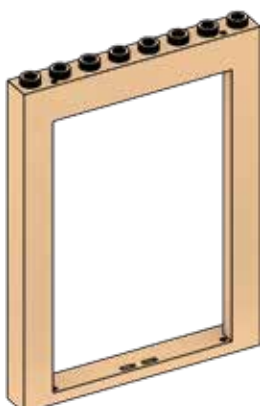

1x AM72863AMR

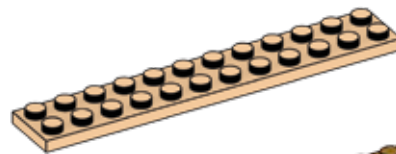

2x MA1172AMR

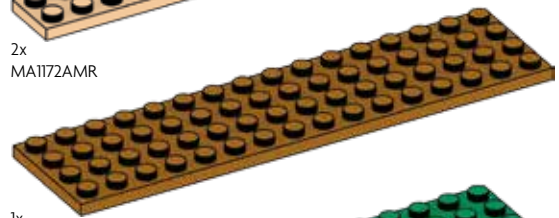

1x MA18566MY

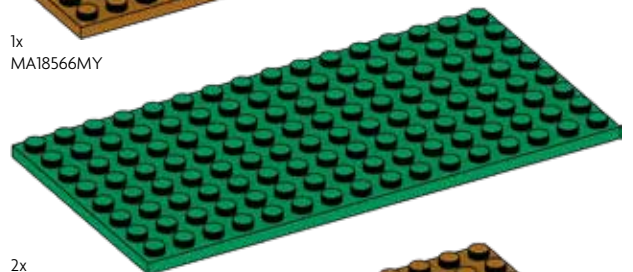

2x MA18567BMG

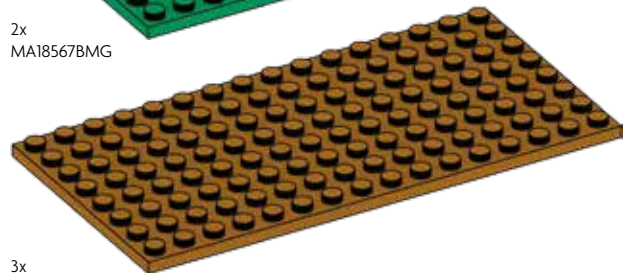

3x MA18567MY

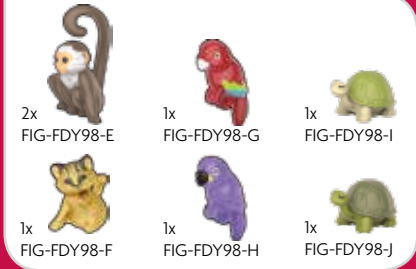
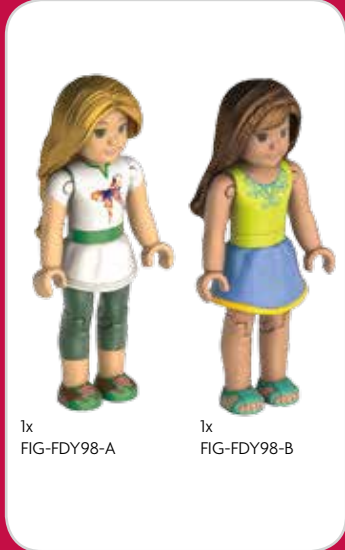
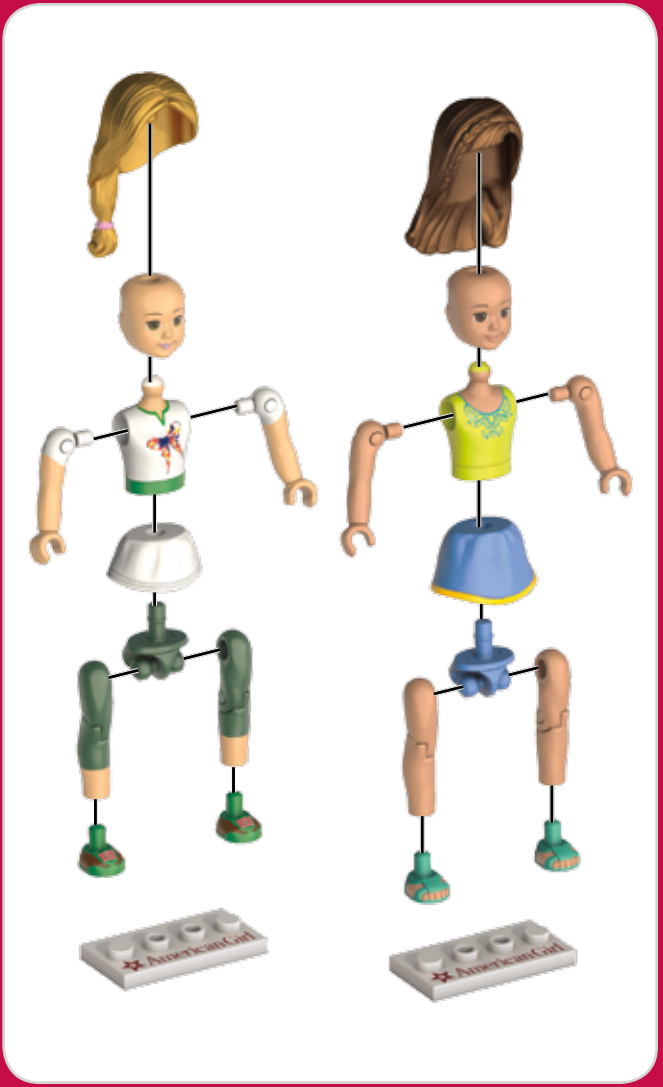
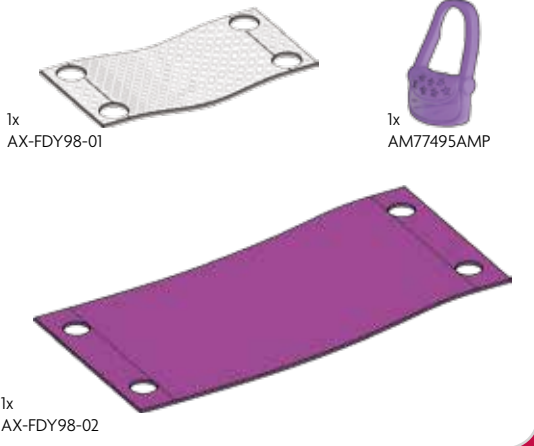

Collectionne-les toutes!



Produits vendus séparément, selon la disponibilité.

MEGA CONSTRUX™

Build Beyond™

Au-delà de la
construction!

¡Construye sin límites!

Mais do que Construção!

Costruisci oltre ogni limite!

Es gibt keine Grenzen!

Więcej niż budowanie!

Meer dan alleen bouwen!

Больше, чем конструктор!

Χτίσε έναν ολόκληρο κόσμο!

Hayallerini İnşa Et!

لنبني .. وأكثر!



©2016, MEGA Brands Inc. &™ MEGA Brands Inc.
CONSTRUX™ appartient à Mattel et est utilisée sous licence.
Imprimé au Canada D-FDY98-01



play.megaconstrux.com

