

# HOTWHEELS™

# 3 IN 1

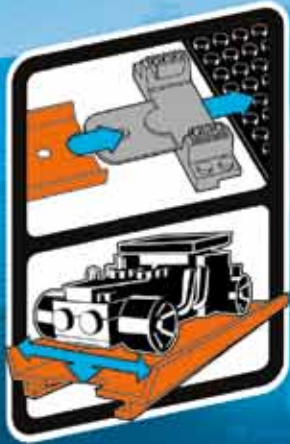

HOTWHEELS.MEGABLOKS.COM



Grease Pit Garage™ | Garage de ravitaillement | Garaje de reparación | Garagem de grease pit | Garage Fossadi Riparazione | VerschmierteGarage | Garaż Grease Pit Garage Met Smeerput | гараж сосмотровой ямой

# MEGA BLOKS®





1x  
MA17003FM

4x  
AM19392ACX

4x  
AM18560AMC

1x  
M1113WH

1x  
M1113X

2x  
AM08417X

2x  
AM18592MM

2x  
AM09104AMC

2x  
AM72001ACX

2x  
AM72233FM

2x  
MA0910ACX

1x  
AM18630MM

2x  
MA07629FM

4x  
AM11971F

4x  
AM01890KC

1x  
MA09198ACX

1x  
MA022501AMC

2x  
AM76469ACX

1x  
AM18260ACX

1x  
AM17070AMC

4x  
MA09393AMC

1x  
MA09393MM

1x  
MA09393F

3x  
MA09393FM

4x  
AM18221FM

3x  
MA72000ACX

2x  
AM74288FM

2x  
AM18705MM

2x  
AM18705FM

1x  
MA18549AMC

1x  
AM09946FM

2x  
AM76467ACX

2x  
AM76467F

2x  
AM18014F

2x  
AM18014FM

4x  
MA09013MM

1x  
MA09013AMC

2x  
MA17502MM

1x  
MA17502FM

1x  
AM76456AMC

4x  
AM18525MM

2x  
MA0948F

1x  
MA09267F

1x  
MA03773FM

1x  
MA03773F

1x  
AM74106ACX

1x  
AM15064ACX

1x  
MA10273FM

4x  
MA10273MM

1x  
MA09023FM

1x  
MA09023MM

1x  
AM72264ACX

1x  
AM74103MM

2x  
AM74103ACX

2x  
AM74058ACX

4x  
AM19012FM

2x  
MA09838AMC

1x  
MA09838MM

1x  
MA09593MM

1x  
MA09493FM

1x  
MA1141E

4x  
MA1323FM

1x  
MA04497MM

1x  
AM17000FM

1x  
AM17001FM

1x  
AS-CNF43-01

2x  
AM18276MM

1x  
AM18299ACX

1x  
MA09033MM

1x  
MA09033FM

1x  
AM16912FM

1x  
AS-CNF43-02



1x  
AM18259FM



2x  
AM16289FM

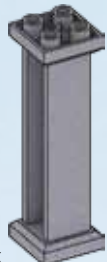

2x  
AM09238ACX

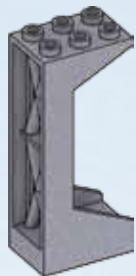

1x  
MA06618ACX



2x  
MA18275FM



2x  
AM18610FM



2x  
MA09292MM



2x  
MA09292FM



2x  
MA1480ACX



5x  
MA1480MM



2x  
MA04983MM



2x  
AM17383ACX

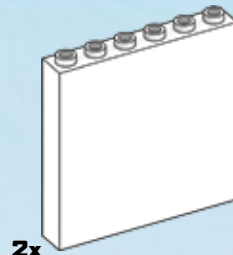

2x  
AM01321E

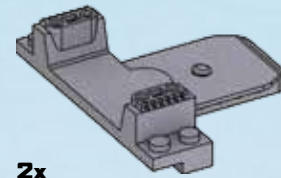

2x  
AM76496ACX

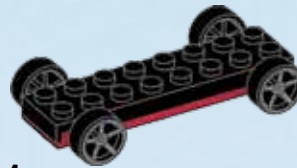

1x  
AS-CNF43-03



1x  
MA09923MM

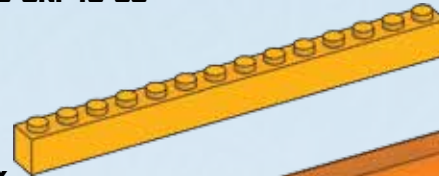

1x  
AM19036FM



1x  
AX-HWTRK22-H

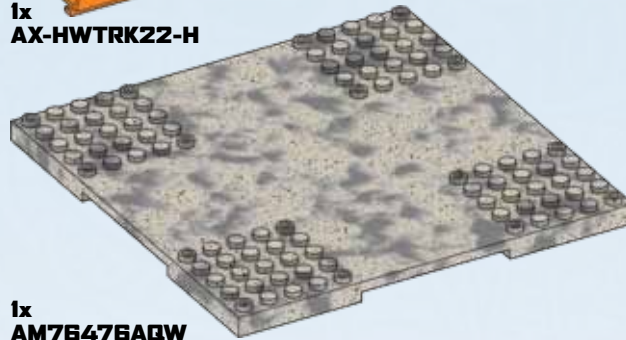

1x  
AM76476AQW

Please read these instructions carefully before first use and keep them for future reference.  
 Il est recommandé de lire attentivement ce feuillet avant la première utilisation et de le conserver pour référence future.  
 Leer estas instrucciones cuidadosamente antes de la primera utilización y guardarlas para referencia futura.  
 Leia as instruções antes do primeiro uso e guarde-as para futura referência.  
 Leggere le istruzioni prima di cominciare ad usare il gioco e conservarle per referenze future.  
 Die Gebrauchsanleitung bitte durchlesen und aufbewahren.  
 Proszę uważnie przeczytać instrukcję obsługi przed pierwszym użyciem, a następnie zachować ją na przyszłość.  
 Wij raden u aan deze handleiding zorgvuldig te lezen en te bewaren voor eventuele raadpleging op een later tijdstip.  
 Внимательно прочитайте инструкцию перед первым использованием и сохраните ее для дальнейшего использования.  
 Vær venlig at læse disse instruktioner omhyggeligt inden ibrugtagning og opbevar dem til fremtidigt brug.  
 Läs noggrant igenom dessa instruktioner innan du använder produkten för första gången och spara dem för ev. framtida frågor.  
 Les disse instruksjonene nøye før første gangs bruk, og ta vare på dem for fremtidige oppslag.  
 Lue nämä ohjeet huolellisesti ennen ensimmäistä käyttöä ja säilytä ne myöhempää tarvetta varten.  
 Διαβάστε αυτές τις οδηγίες προσεκτικά πριν χρησιμοποιήσετε το προϊόν για πρώτη φορά και φυλάξτε τις για μελλοντική αναφορά.  
 يرجى قراءة هذه التعليمات بدقة قبل البدء بالاستعمال والاحتفاظ بها كمرجع للمستقبل.  
 请在初次使用前仔细阅读这些指示，并保留它们以便未来参考。  
 初めてご使用になる前に、この説明書をよくお読みください。また、本書は将来いつでも参照できるように保管してください。

⚠ WARNING:  
CHOKING HAZARD. - Small parts.  
Not for children under 3 years.

⚠ ATTENTION:  
DANGER D'ÉTOUFFEMENT. - Présence de petits éléments.  
Ne convient pas aux enfants de moins de 3 ans.

⚠ تحذير:  
خطر الاختناق - قطع صغيرة.  
غير صالحة للأطفال أقل من 3 سنوات.

⚠ 警告:  
噎住危険。包含有小部件  
不适合3岁以下的小孩玩。

⚠ 警告:  
のどにつまる危険 小さな部品が含まれています  
3歳以下の子供には与えないで下さい。

ADVERTENCIA: Peligro de asfixia. Juguete no recomendado para menores de 3 años, porque contiene piezas pequeñas que podrían provocar asfixia en caso de ser ingeridas o inhaladas por el/la niño/a.

ATENÇÃO: Não recomendável para crianças com menos de 36 meses. Contém peças pequenas capazes de criar risco de asfixia.

ATTENZIONE: Contiene pezzi di piccole dimensioni.

ACHTUNG: Kleine Teile.

OSTRZEŻENIE: Małe części

WAARSCHUWING: Kleine onderdelen

ПРЕДУПРЕЖДЕНИЕ: Мелкие детали

ADVARSEL: Små dele.

VARNING: Smådelar

ADVARSEL: Små deler.

VAROITUS: Pieniä osia

ΠΡΟΣΟΧΗ: Περιλαμβάνονται μικρά κομμάτια.



1x  
AS-CNF43-04

1x  
FIG-CNF43-A





**1**

1x

2x 1x 2x

1x



**2**

1x 1x 1x

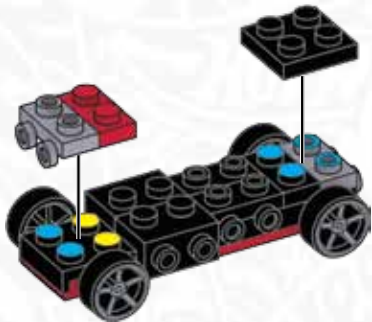

**3**

1x 2x 1x

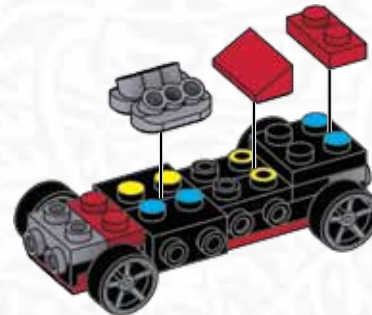

**4**

2x 1x

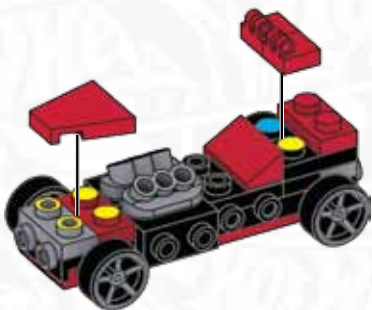

**5**

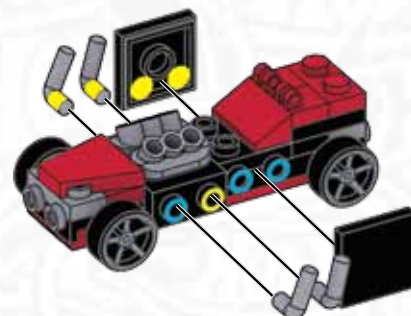

4x 2x







**6**

1x  1x 

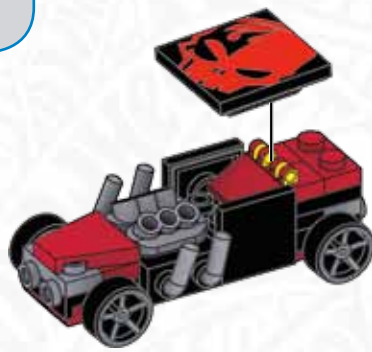



1





2



**1**

4x  1x  1x 

2x  2x  1x 

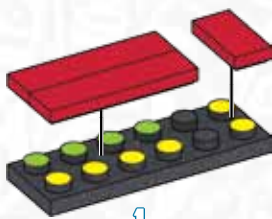

1

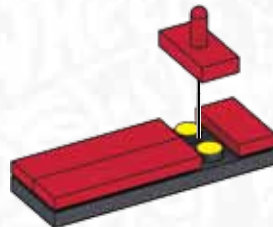

2

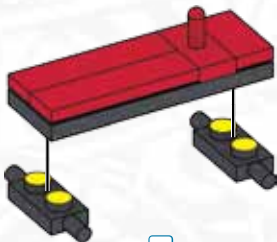

3

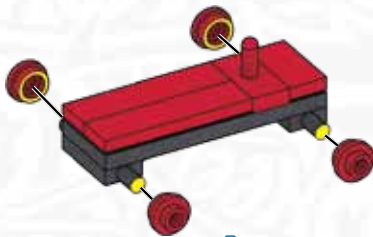

4

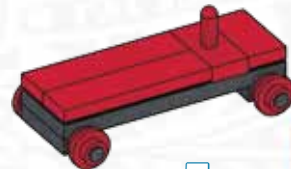

5

5





**1**

1x  
1x  
2x

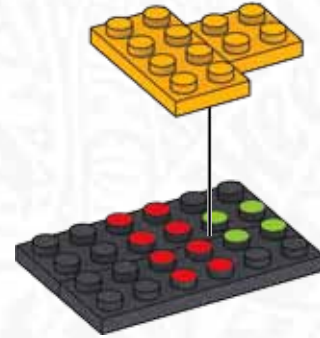

**2**

4x

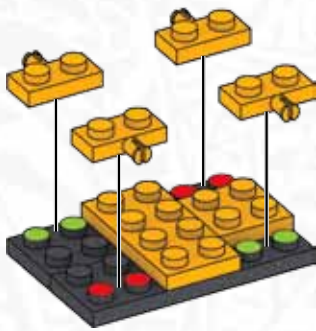

**3**

1x 1x

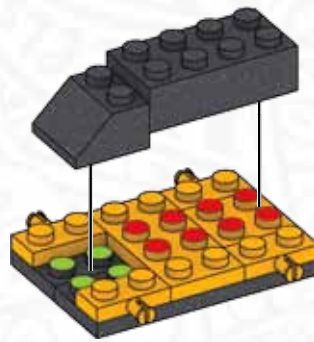

**4**

4x

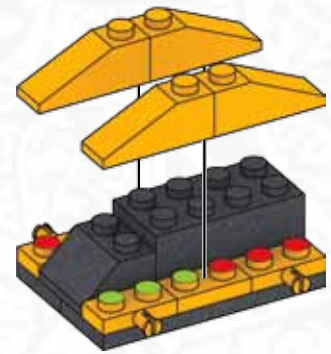

**5**

1x 1x  
1x 1x

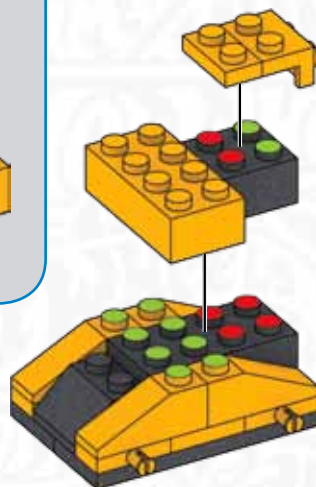

**6**

1x

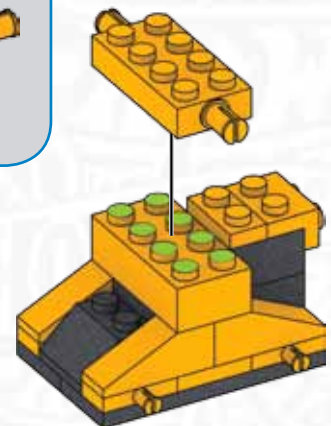





**7**

2x

1x

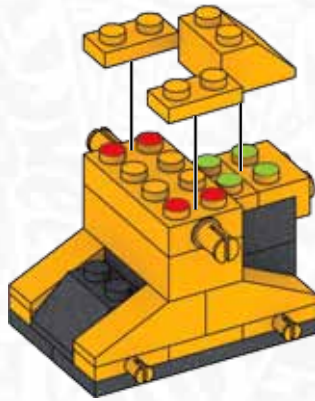

**8**

1x 1x

1x 1x

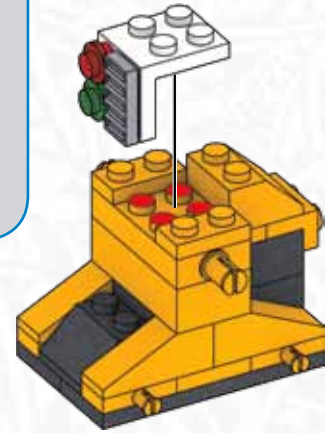
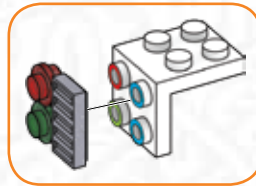

**9**

2x

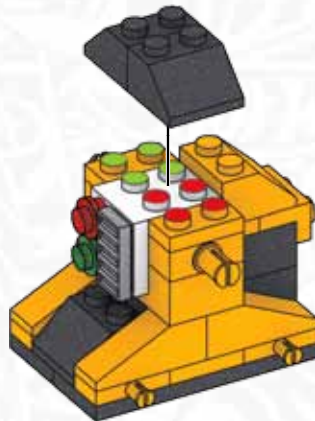

**10**

1x 1x

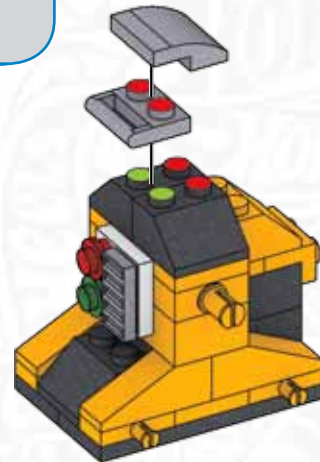

**11**

1x 1x 1x

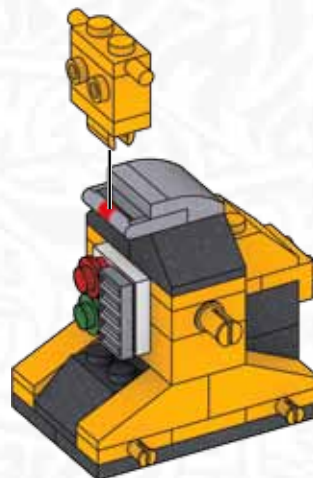
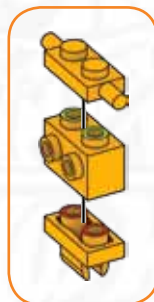



**12**

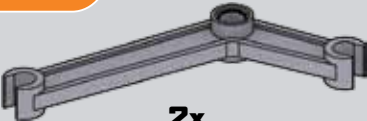

**2x**

**13**



**1x**



**2x**

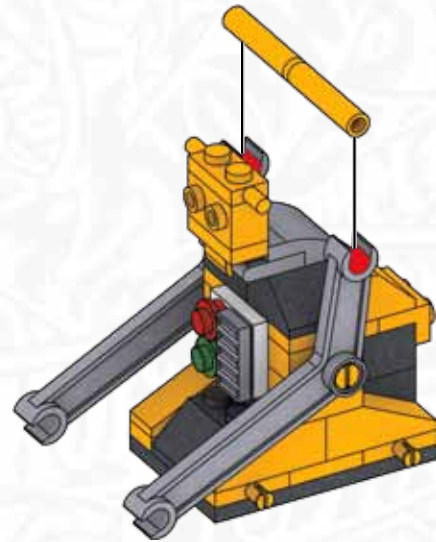
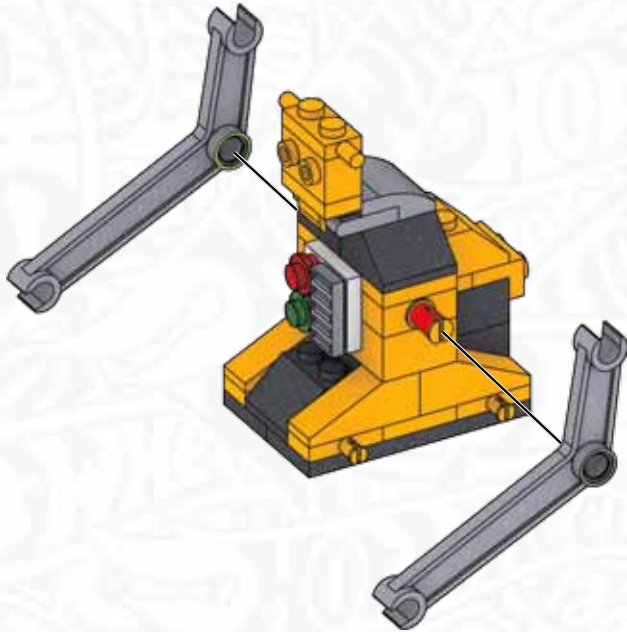

**14**



**2x**



**1x**



**2x**

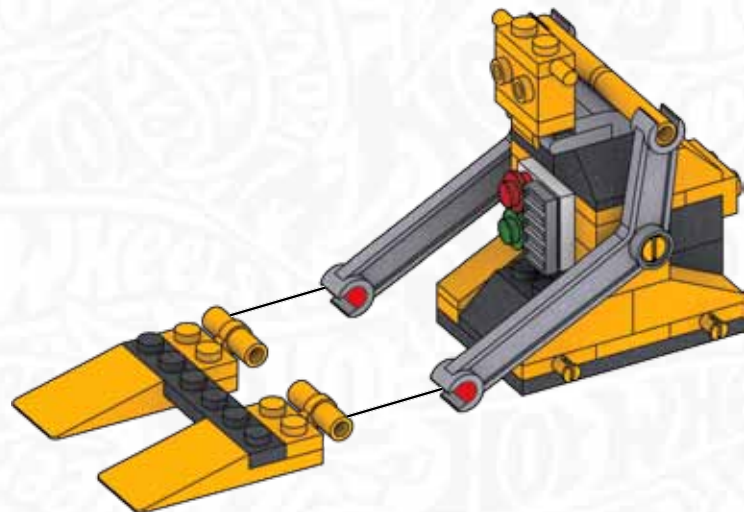
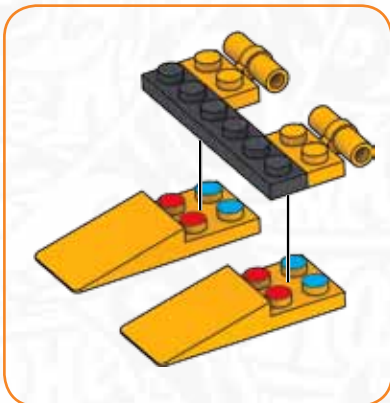





**15**



2x



2x

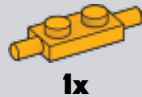

1x



1x

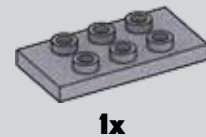

1x

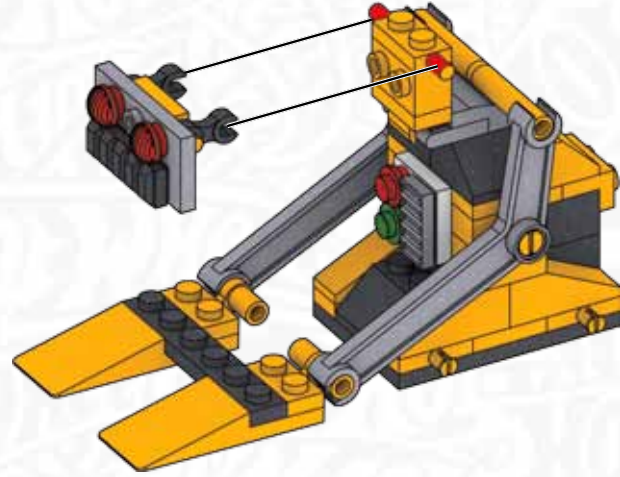
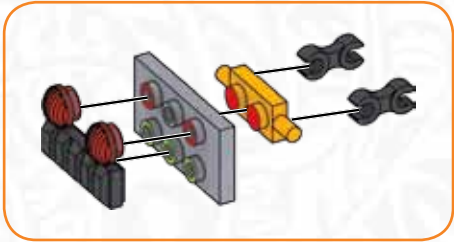

**16**



2x



4x

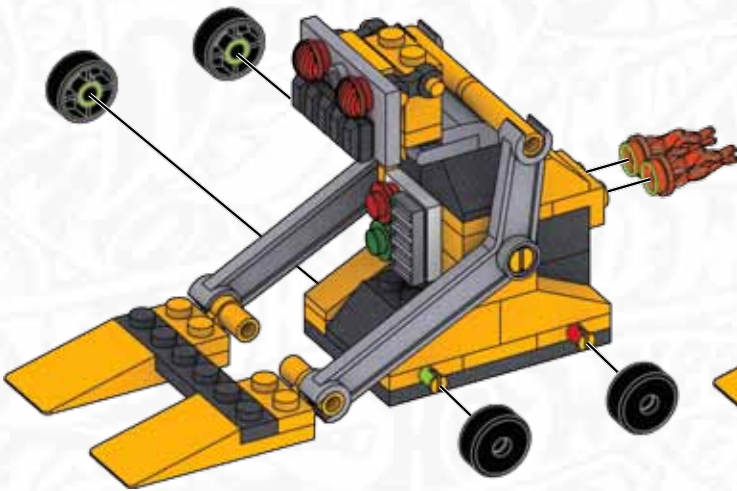

1

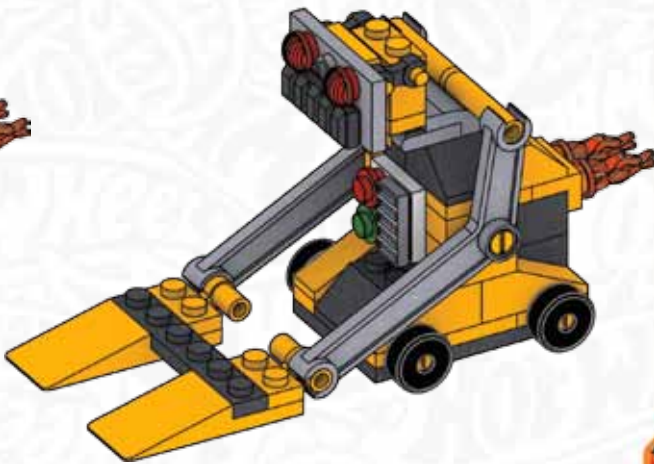

2



**1**

- 1x
- 1x
- 2x
- 2x
- 1x

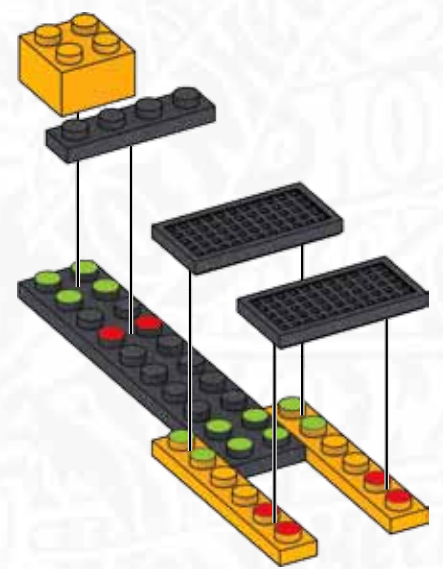

**2**

- 4x
- 4x
- 2x

**3**

- 1x

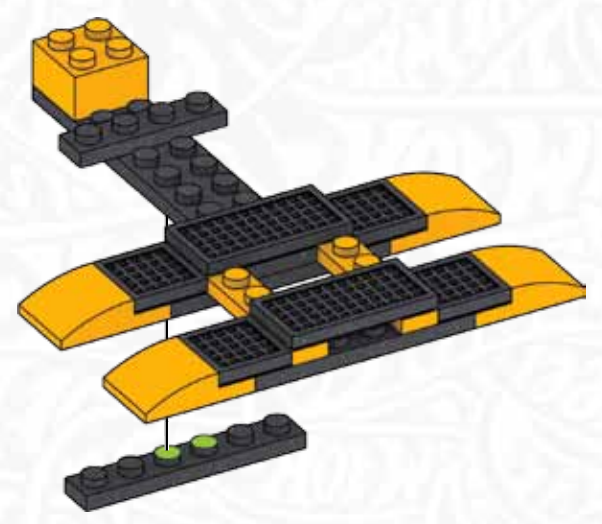
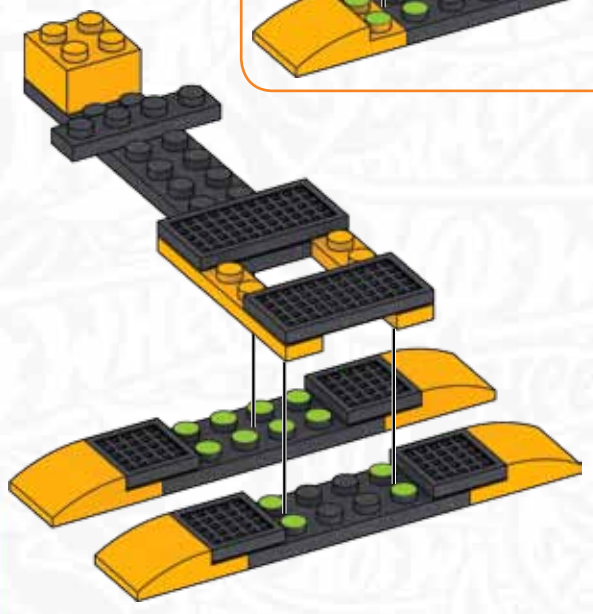
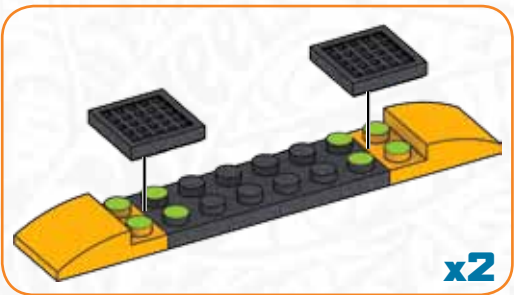



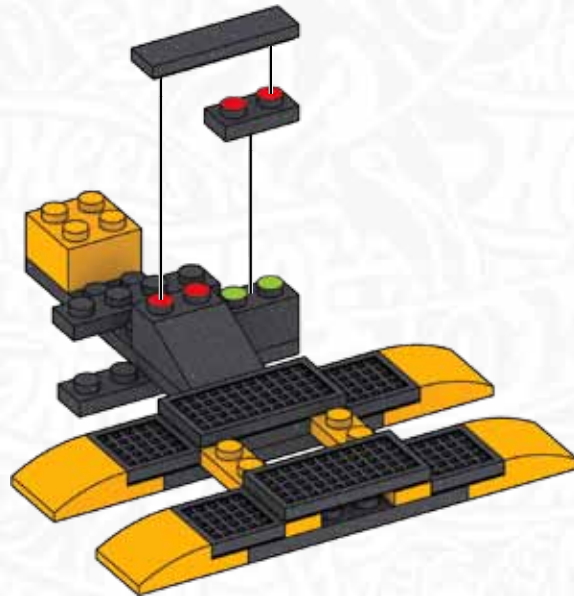
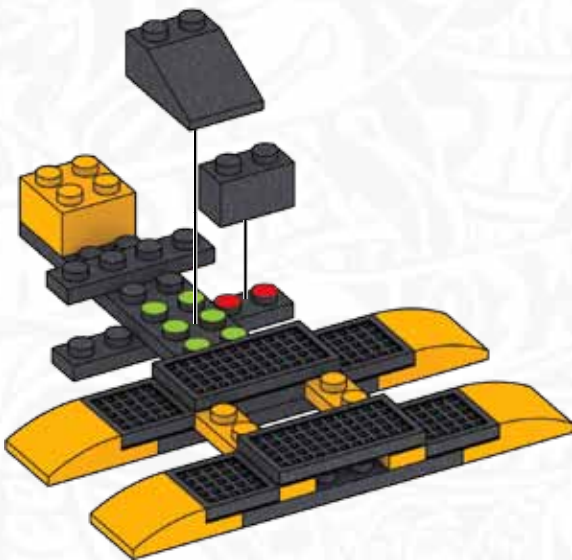
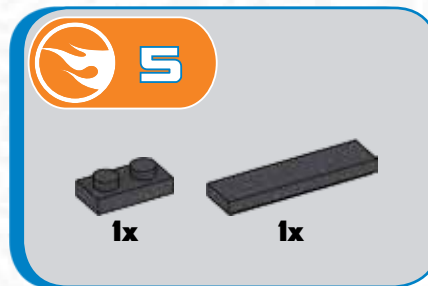
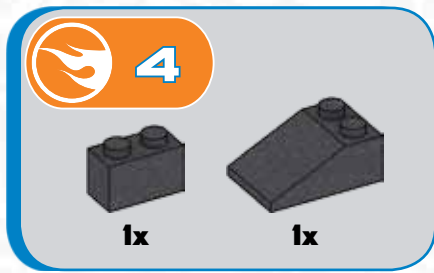

1

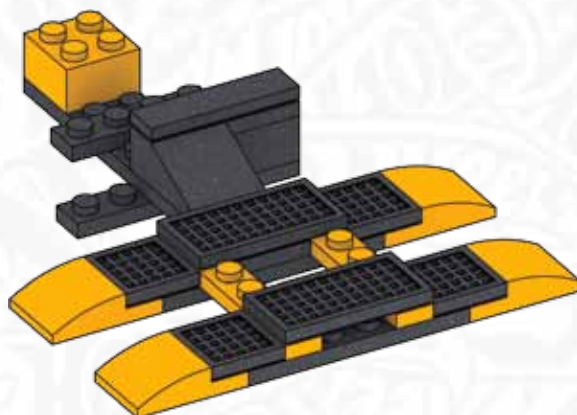

2





**6**



**2x**

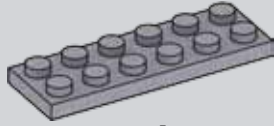

**1x**

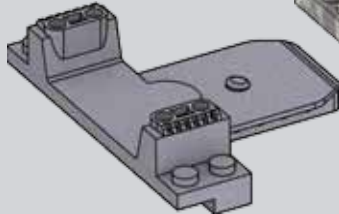

**1x**

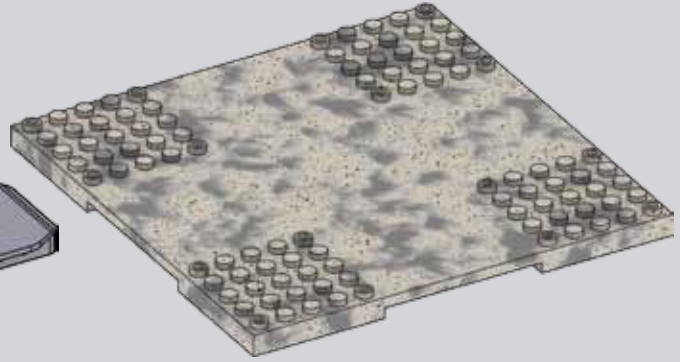

**1x**

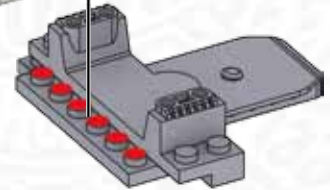
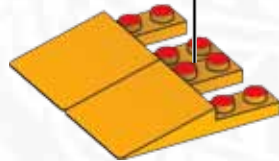
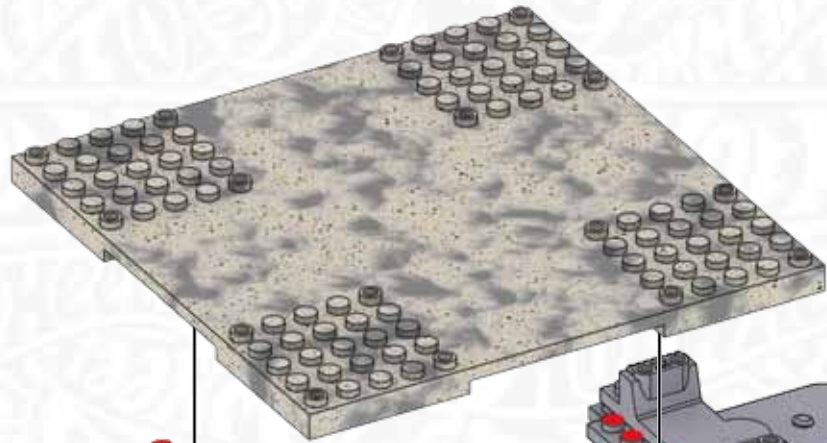
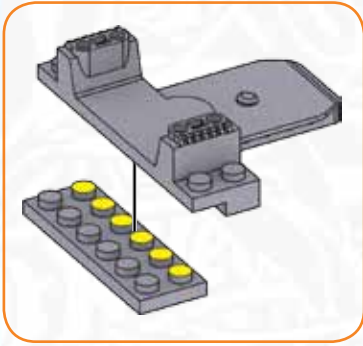

**7**



**2x**

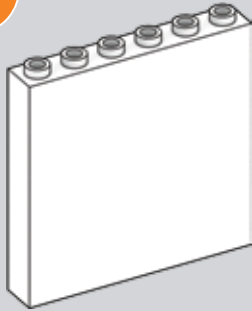

**2x**

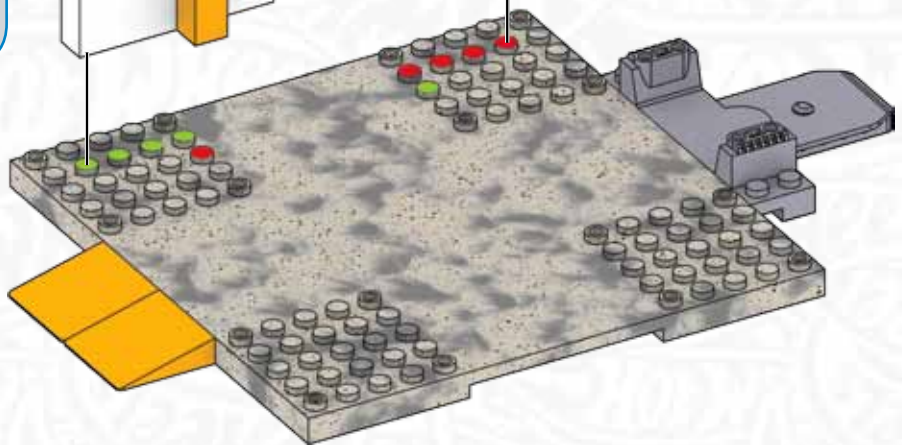
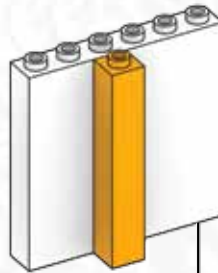
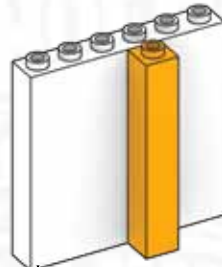



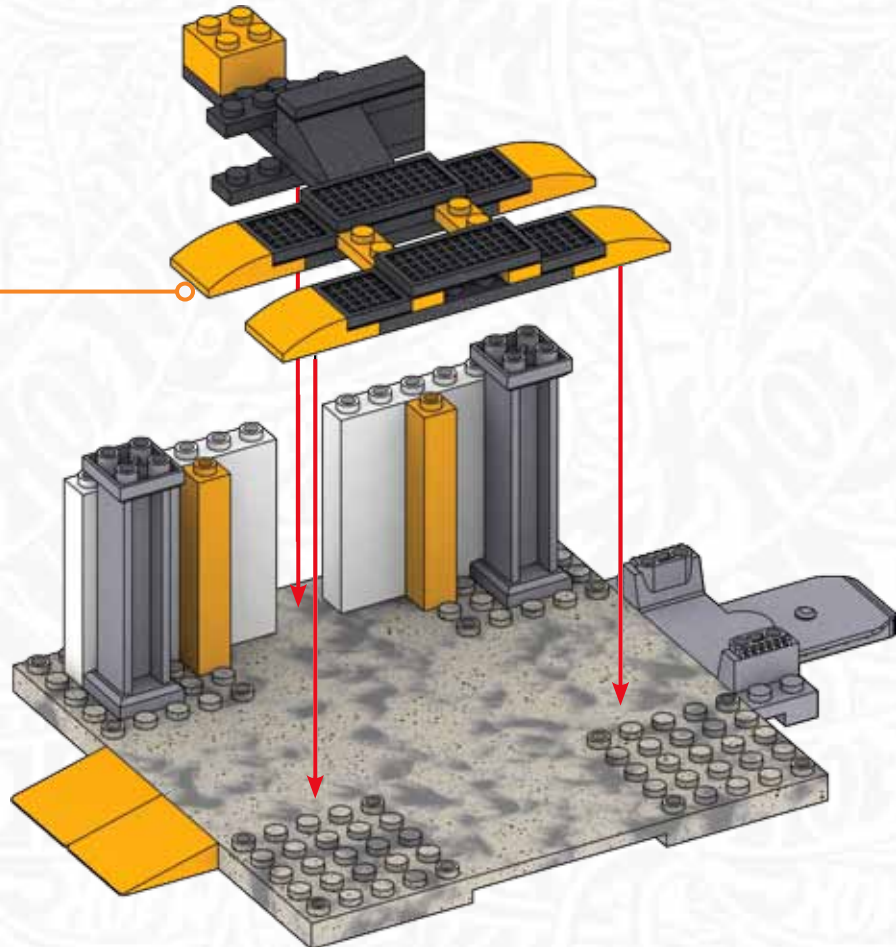
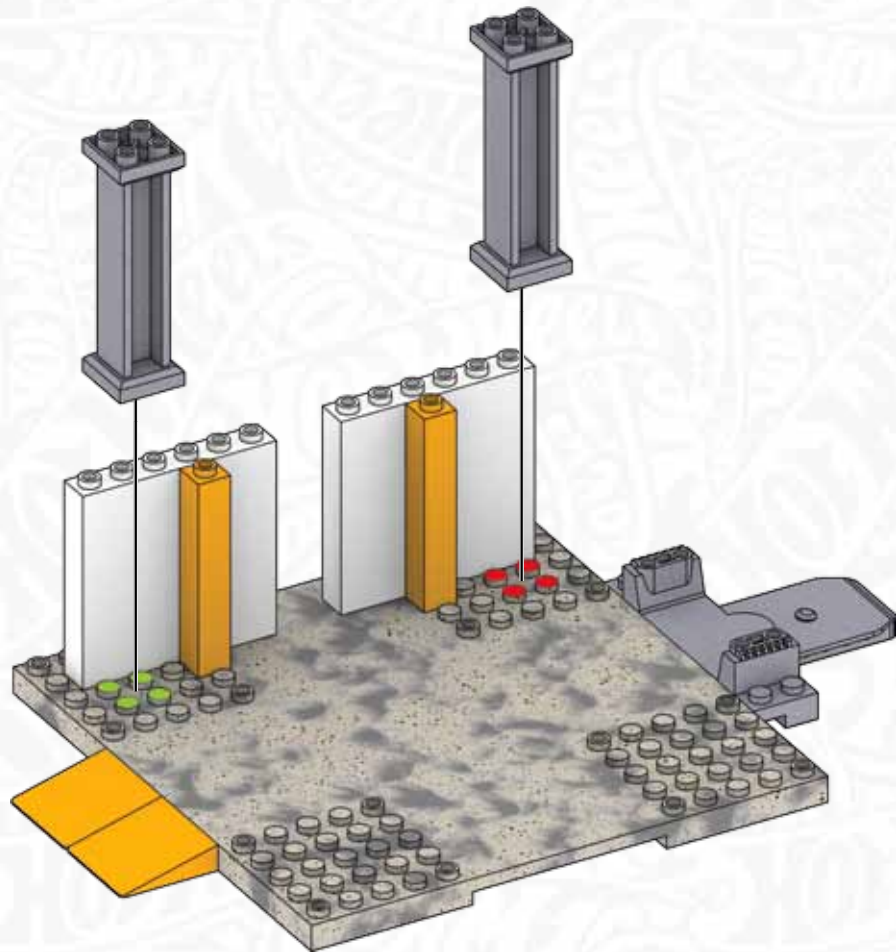
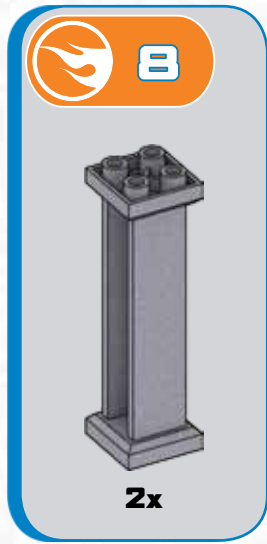



**10**

2x

2x

1x

x2

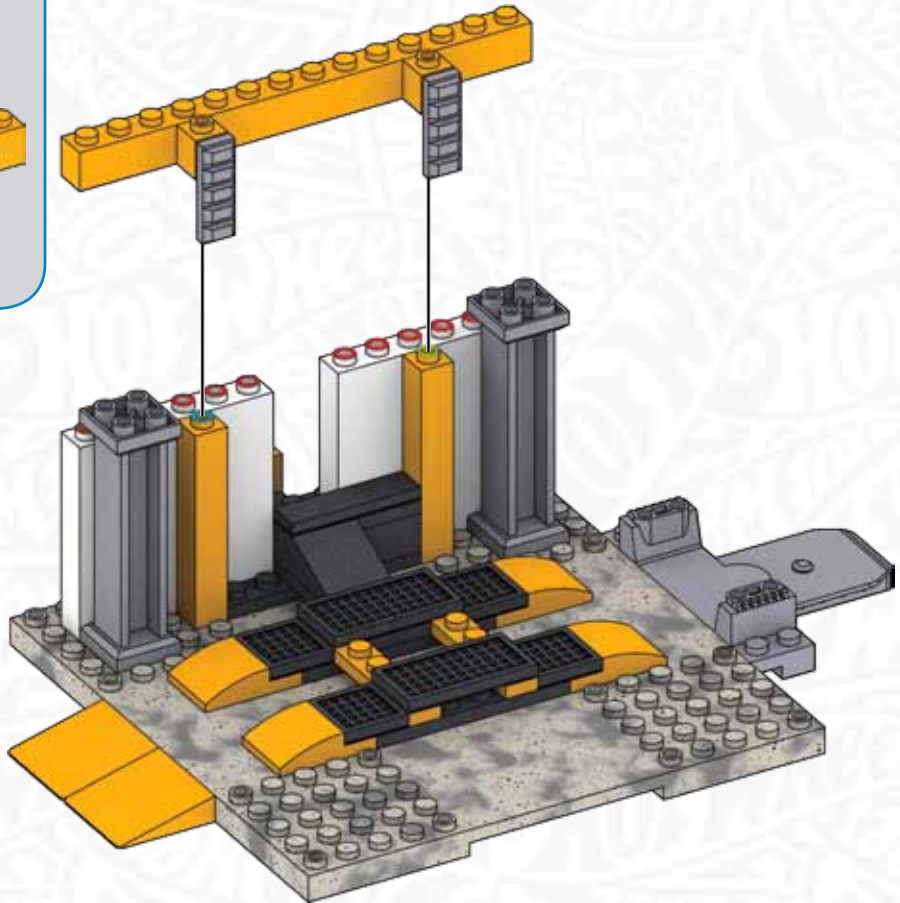

**11**

3x

2x

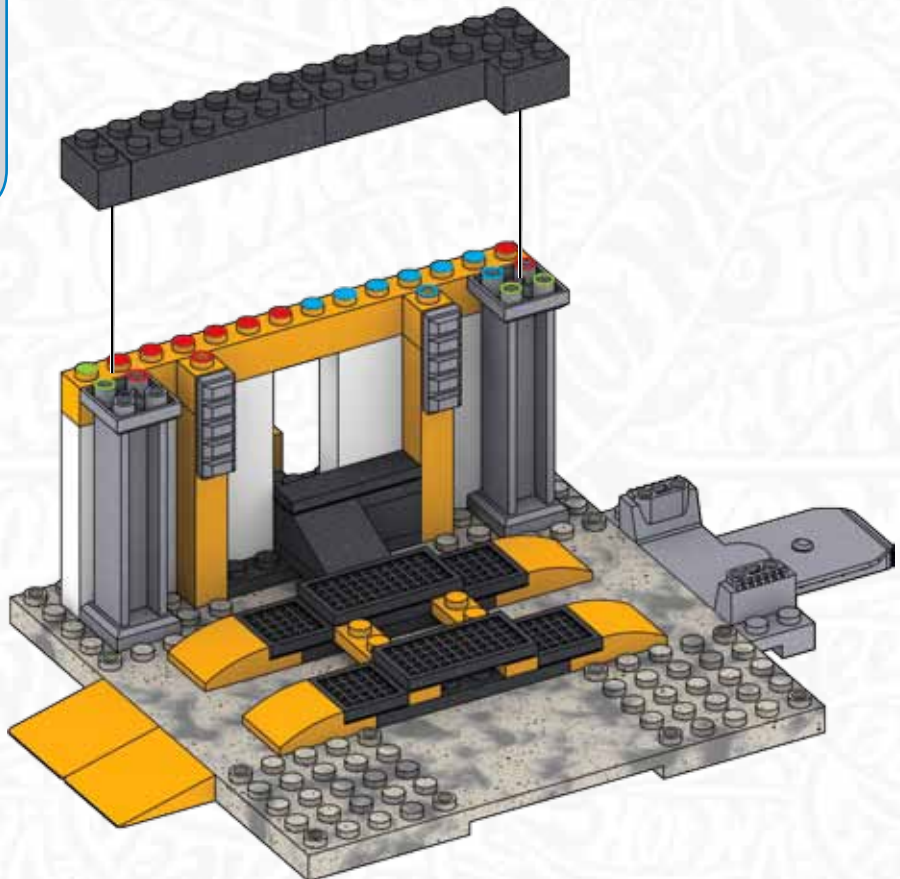





**12**

**1x**



**13**

**1x**   **1x**  
**2x**   **1x**   **1x**

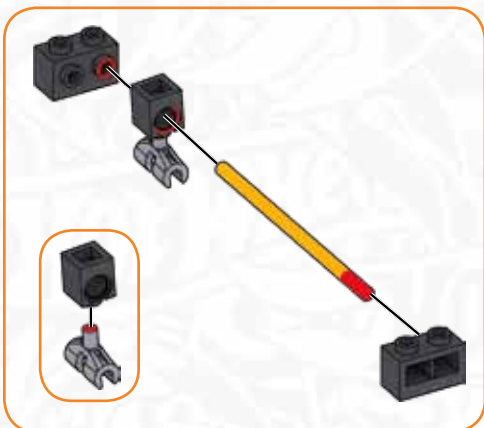



**14**



2x



2x



2x



1x



2x



1x

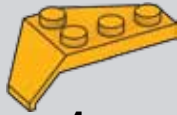

1x



1x

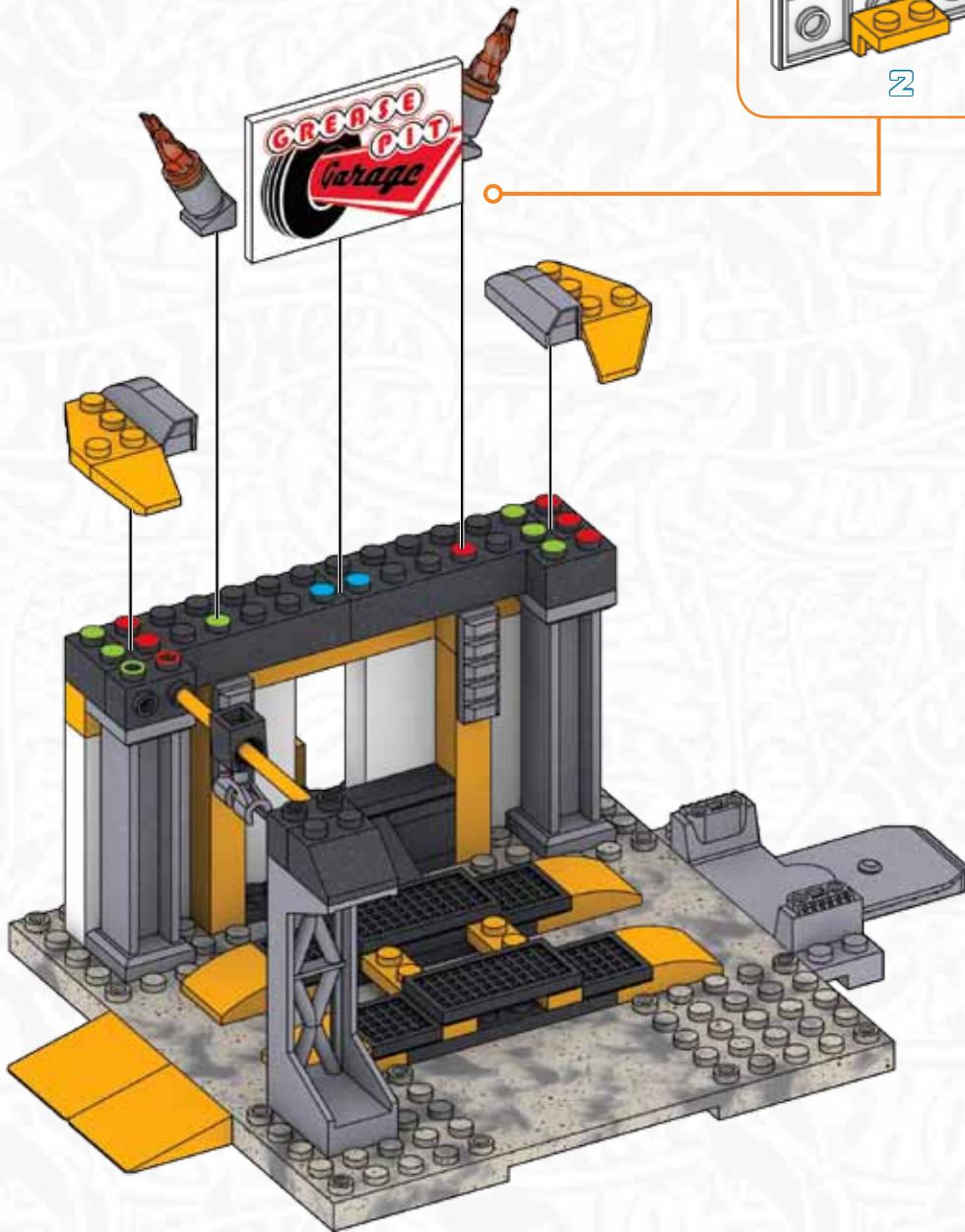
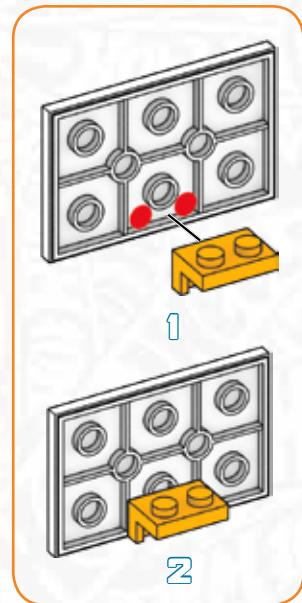





 15



2x



2x

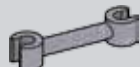

1x



1x



1x

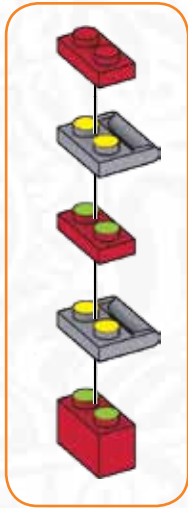



 16

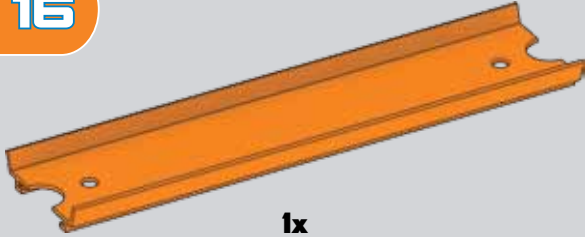

1x

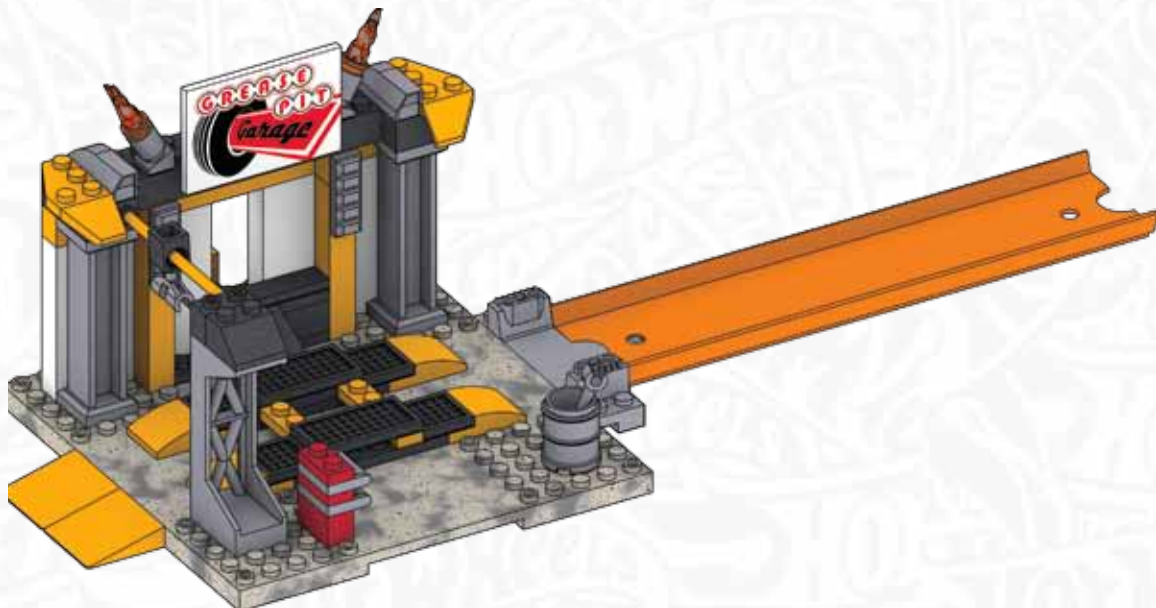
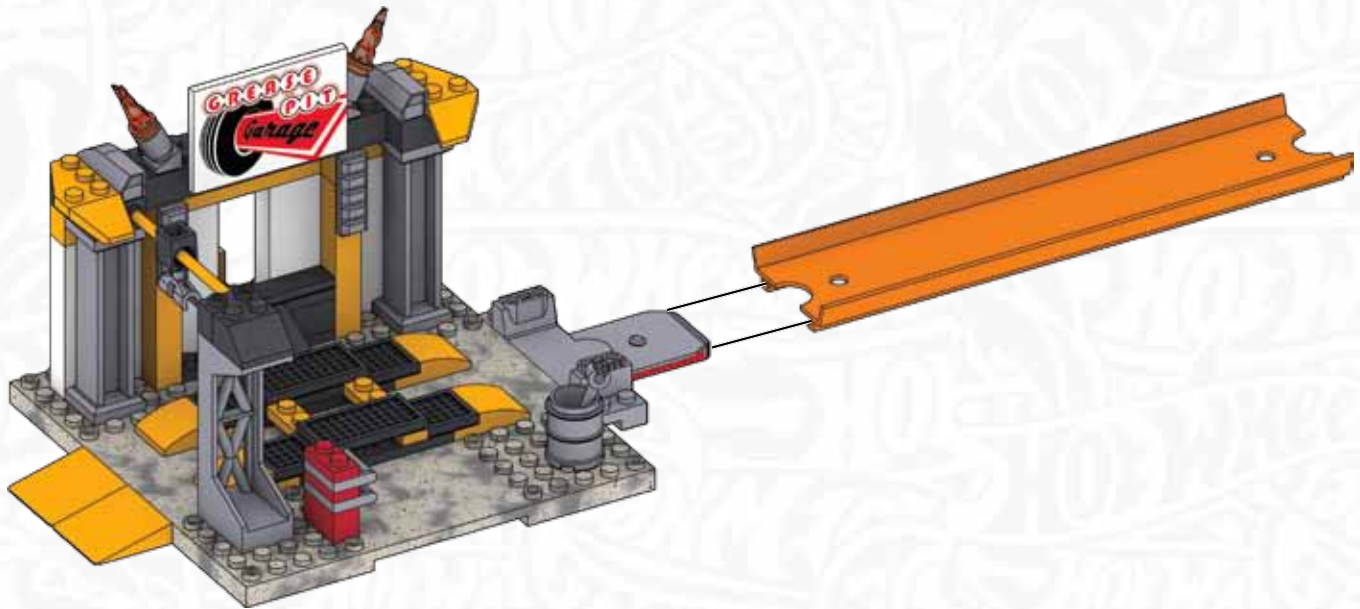







1

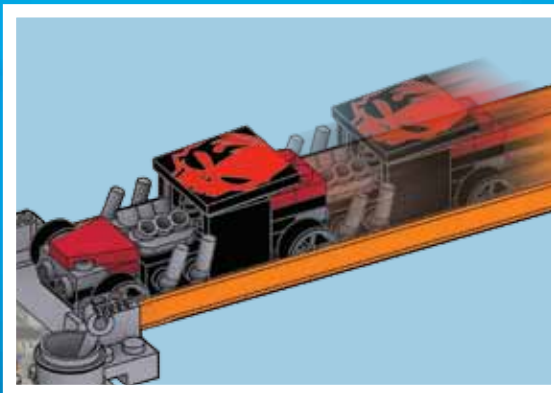

2

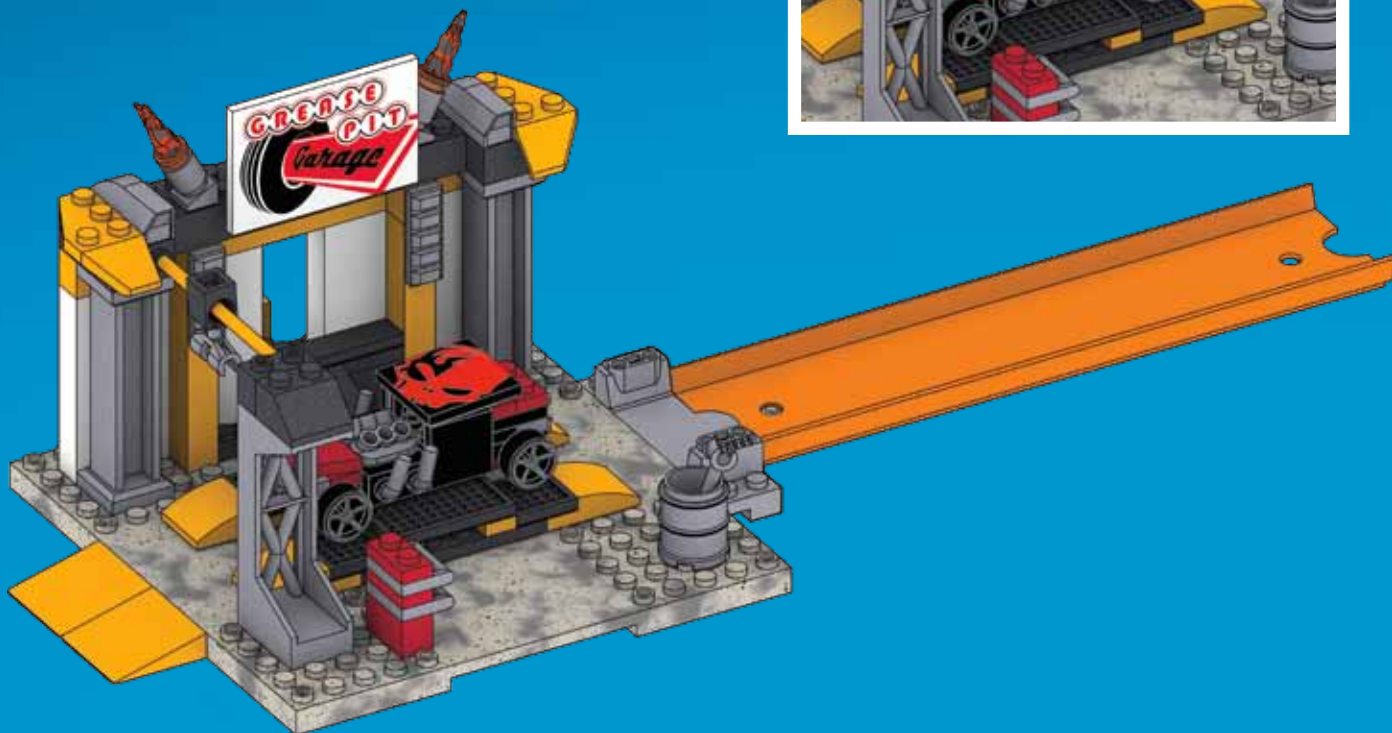





3

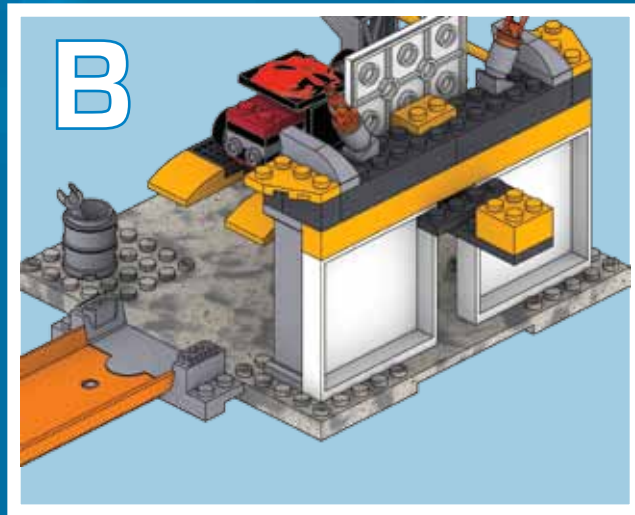
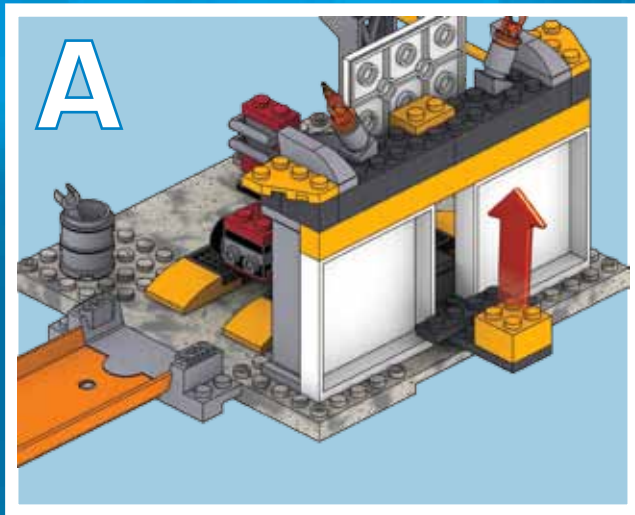



4

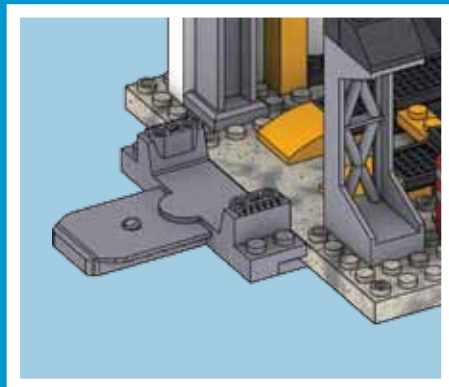
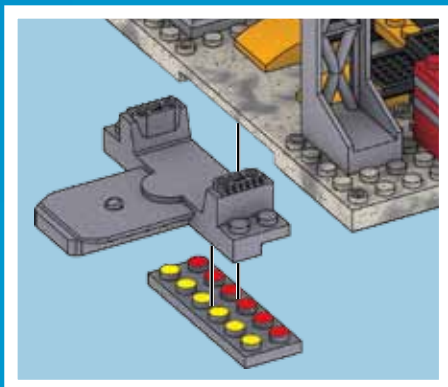
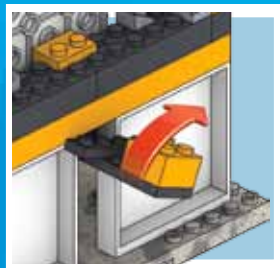

or/ou/o/oder  
of/lub/Или





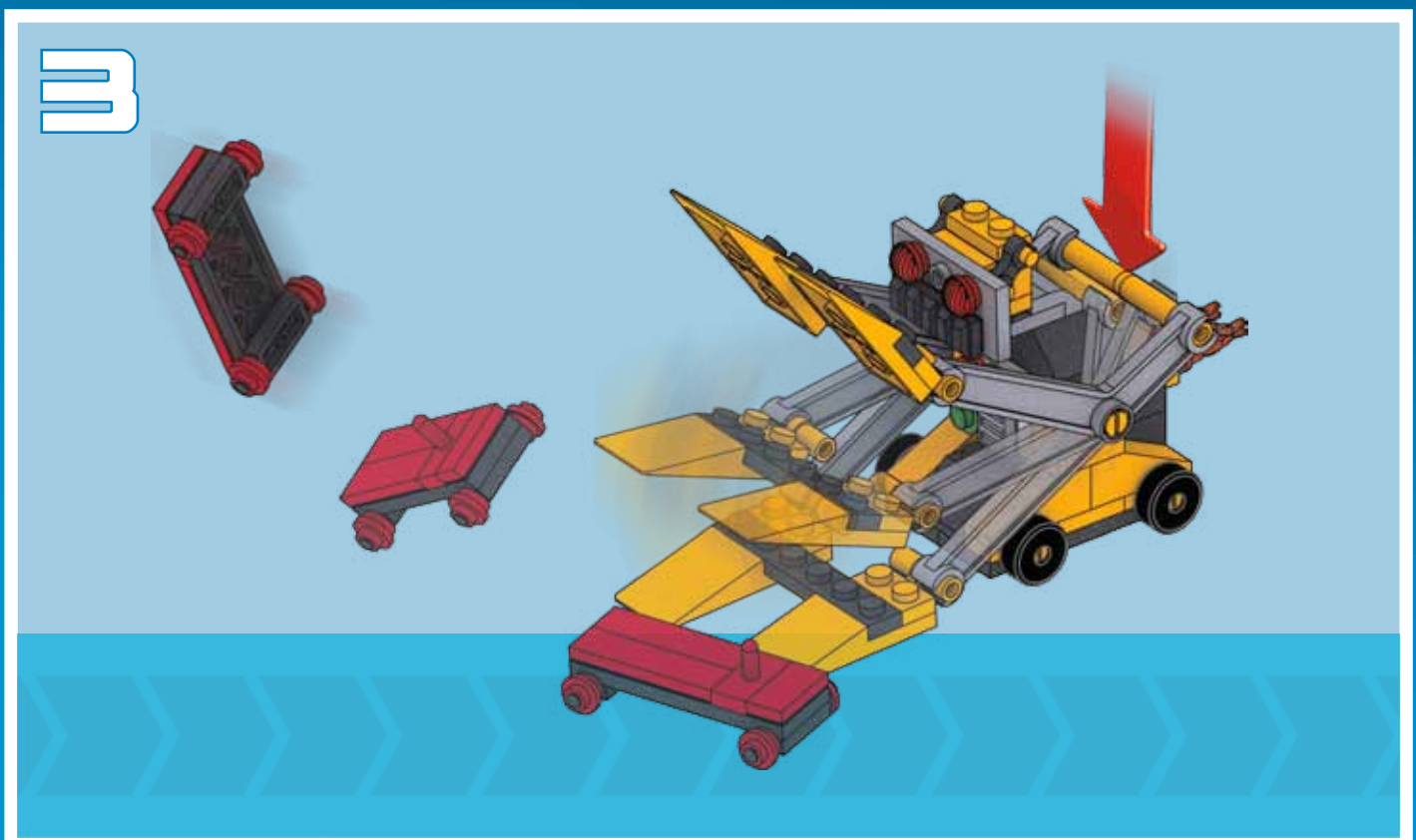
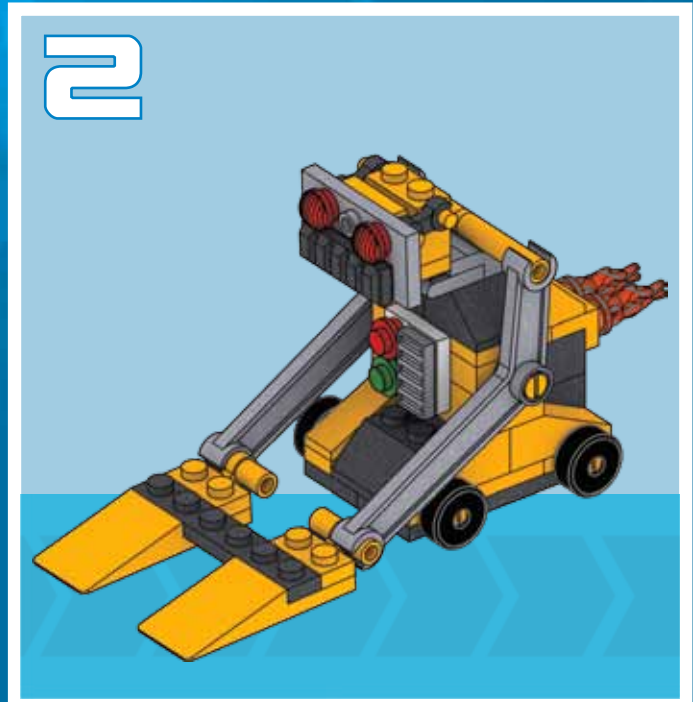
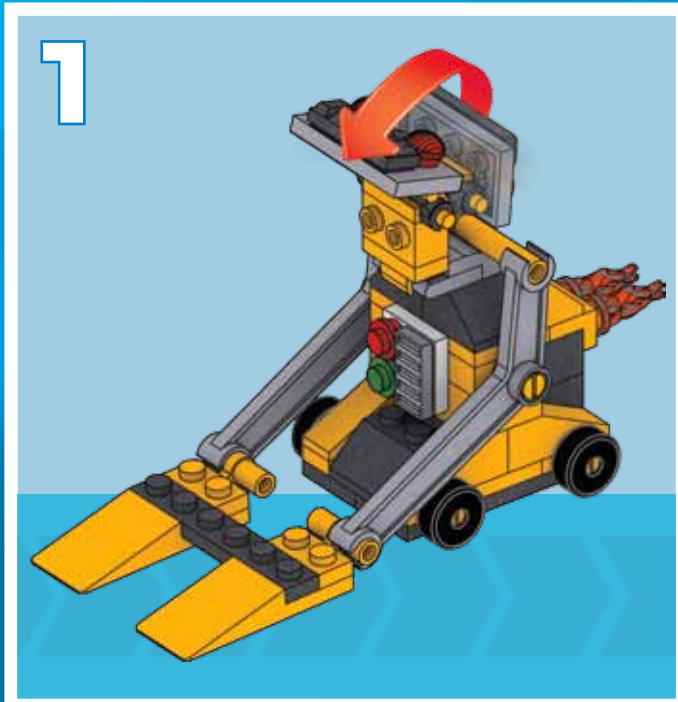

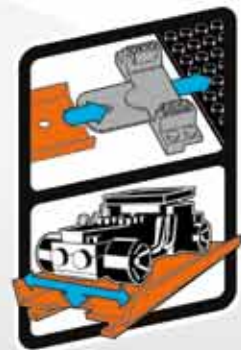

Grease Pit Garage™  
 Garage de ravitaillement  
 Garaje de reparación  
 Garagem de grease pit  
 Garage Fossadi Riparazione  
 VerschmierteGarage  
 Garaž Grease Pit  
 Garage Met Smeerput  
 гараж ссмотровой ямой



Includes 1 track piece / Comprend 1 piste  
 Incluye 1 pieza de pista / Inclui 1 peça da pista  
 Contiene 1 pezzo di pista / Enthält 1 Streckenstück  
 Zawiera 1 element toru / Bevat 1 racebaanonderdeel  
 В набор входит 1 деталь от гоночной трассы

**HOTWHEELS.MEGABLOKS.COM**

©2015, MEGA Brands Inc. ® & ™ MEGA Brands Inc.  
 Printed in Canada D-CNF43-01

Collect them all!  
 Collectionne-les tous!  
 ¡Coleccionalos!  
 Viel Spaß mit allen Produkten!  
 Collezionati tutti!  
 Colecional!  
 Verzamel ze allemaal!  
 Zbierz je wszystkie!  
 Собери все!



CNF34



CNF36



CNH40



CNH41



CNF35



CNF37



CNF39



CNF40



CNF41



CNF44

Each sold separately and subject to availability. / Tous vendus séparément, selon la disponibilité. / Se venden por separado y están sujetos a disponibilidad. / Alle Artikel separat erhältlich.  
 Einige Artikel werden nicht in allen Ländern vertrieben. / Ognuno in vendita separatamente secondo disponibilità / Cada um é vendido separadamente, sujeito à disponibilidade. / Per stuk verkrijgbaar en niet overal leverbaar. / Sprzedawane oddzielnie w zależności od dostępności. / Каждый продукт продается отдельно, в зависимости от наличия.