











Pickle Tank Attack • Attaque du tank à cornichons • Ataque del tanque de pepinillo • Ataque do Tanque de Pepinos em Conserva • Attacco del carrarmato sottaceto • Angriff mit grünem Tank • Atak czolgu Pickle • Aanval met augurktank • Активная танковая атака





- 1x  AM01113SN
- 2x  MA1113BYE
- 2x  MA1113AMC
- 1x  MA17003AMC
- 2x  MA03328BMG
- 1x  AM08412AMC
- 1x  AM75956BMG
- 2x  MA022501BMG
- 5x  MA09393BMG
- 1x  MA18549BMG

- 2x  AM18740BMG
- 6x  AM04322BMG
- 1x  MA72000BMG
- 1x  AM02215B
- 1x  MA03484BMG
- 1x  AM09893SN
- 1x  AM17010SN
- 1x  AM17010AMC
- 2x  MA15484BMG

- 2x  AM72917BMG
- 8x  MA11101BMG
- 1x  AS9465508
- 1x  MA03485BMG
- 1x  MA09267BMG
- 1x  MA09268MG
- 2x  MA03773BMG
- 1x  MA1146AMC
- 1x  MA18223BMG

- 1x  AS9465507
- 8x  AM17392F
- 1x  AS9465505
- 1x  MA09593BMG
- 1x  MA03323BMG
- 1x  AM03324BMG
- 3x  MA09493BMG

- 3x  AM74718BTN
- 1x  AM75954BMG
- 2x  MA1480BMG
- 1x  AM08483AUG
- 2x  AM74643F





1x
AS946506



1x
AM17601AMC



1x
FIG946552



1x
FIG946551

©2015 Paramount Pictures and Viacom International Inc. All Rights Reserved. Nickelodeon, SpongeBob SquarePants and all related titles, logos and characters are trademarks of Viacom International Inc. SpongeBob SquarePants created by Stephen Hillenburg.

WWW.MEGABLOKS.COM

Please read these instructions carefully before first use and keep them for future reference.
Il est recommandé de lire attentivement ce feuillet avant la première utilisation et de le conserver pour référence future.

Leer estas instrucciones cuidadosamente antes de la primera utilización y guardarlas para referencia futura.
Leia as instruções antes do primeiro uso e guarde-as para futura referência.

Leggere le istruzioni prima di cominciare ad usare il gioco e conservarle per riferimento future.
Die Gebrauchsanleitung bitte durchlesen und aufbewahren.

Proszę uważnie przeczytać instrukcję obsługi przed pierwszym użyciem, a następnie zachować ją na przyszłość.

Wij raden u aan deze handleiding zorgvuldig te lezen en te bewaren voor eventuele raadpleging op een later tijdstip.

Внимательно прочитайте инструкции перед первым использованием и сохраните ее для дальнейшего использования.

Vær venlig at læse disse instruktioner omhyggeligt inden ibrugtagning og opbevar dem til fremtidigt brug.

Läs noggrant igenom dessa instruktioner innan du använder produkten för första gången och spara dem för ev. framtida frågor.

Läs disse instruksjonene nøye før første gangs bruk, og ta vare på dem for fremtidige oppslag.

Lue nämä ohjeet huolellisesti ennen ensimmäistä käyttöä ja säilytä ne myöhempää tarvetta varten.

Διαβάστε αυτές τις οδηγίες προσεκτικά πριν χρησιμοποιήσετε το προϊόν για πρώτη φορά και φυλάξτε τις για μελλοντική αναφορά.

يرجى قراءة هذه التعليمات بدقة قبل البدء بالاستعمال والاحتفاظ بها كمرجع للمستقبل

请在初次使用前仔细阅读这些指示，并保留它们以便未来参考。

初めてご使用になる前に、この説明書をよくお読みください。また、本書は将来いつでも参照できるように保管してください。

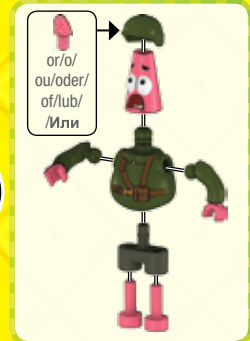

⚠ WARNING:
CHOKING HAZARD. - Small parts.
Not for children under 3 years.

⚠ ATTENTION:
DANGER D'ÉTOUFFEMENT - Présence de petits éléments.
Ne convient pas aux enfants de moins de 3 ans.

⚠ تحذير:
خطر الاختناق - قطع صغيرة.
غير صالحة للأطفال أقل من 3 سنوات.

⚠ 警告:
窒息危險。包含有小部件
不适合3岁以下的小孩玩。

⚠ 警告:
のどにつまる危険 小さな部品が含まれています
3歳以下の子供には与えないで下さい。

ADVERTENCIA: Peligro de asfixia. Juguete no recomendado para menores de 3 años, porque contiene piezas pequeñas que podrían provocar asfixia en caso de ser ingeridas o inhaladas por el/la niño/a.

ATENÇÃO: Não recomendável para crianças com menos de 36 meses. Contém peças pequenas capazes de criar risco de asfixia.

ATTENZIONE: Contiene pezzi di piccole dimensioni.

ACHTUNG: Kleine Teile.

OSTRZEŻENIE: Małe części

WAARSCHUWING: Kleine onderdelen

ПРЕДУПРЕЖДЕНИЕ: Мелкие детали

ADVARSSEL: Små dele.

WARNING: Smådelar

ADVARSSEL: Små deler.

VAROITUS: Pieniä osia

ΠΡΟΣΟΧΗ: Περιλαμβάνονται μικρά κομμάτια.



0-3

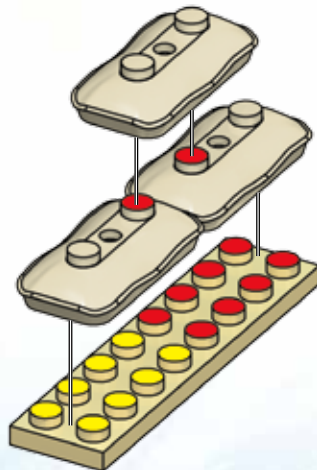
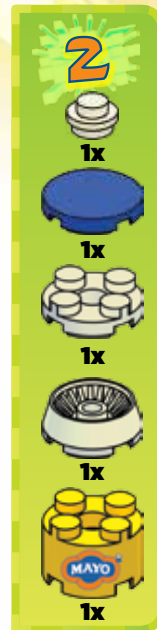
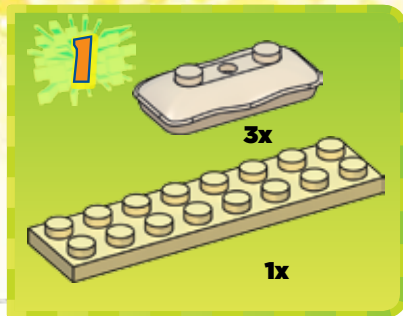
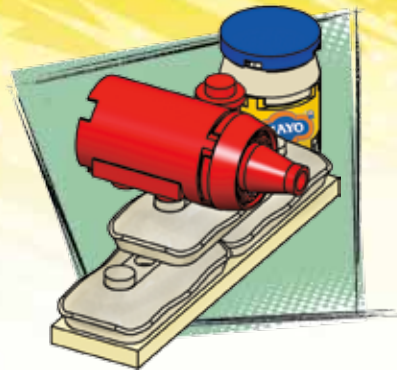



3



2x



2x

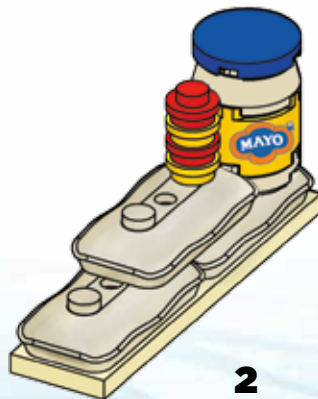
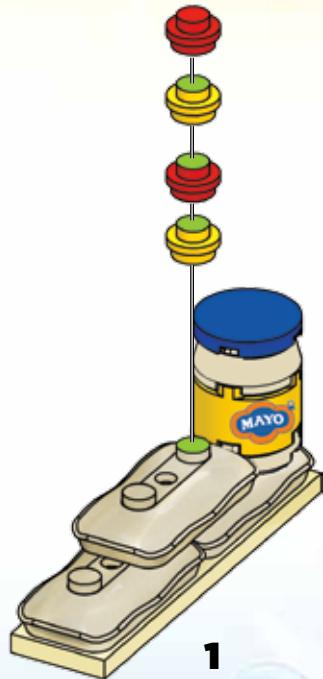

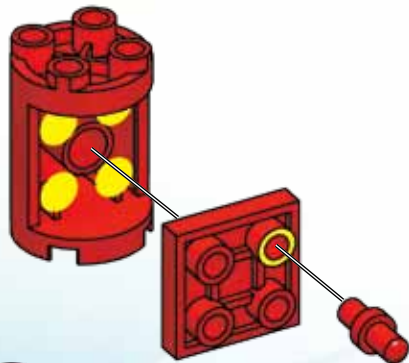
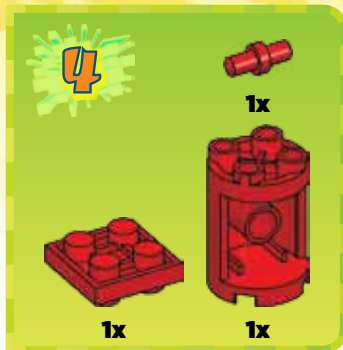



6

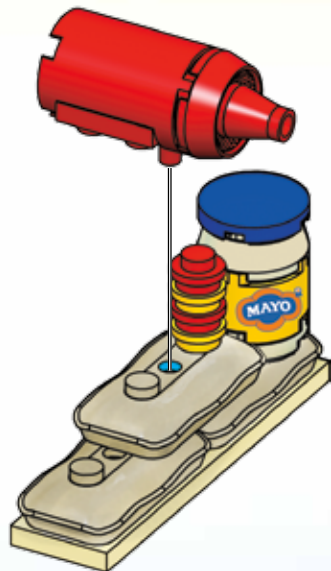

1

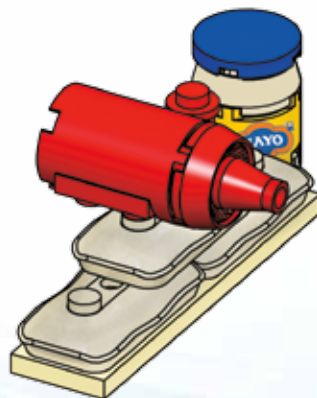

2

7

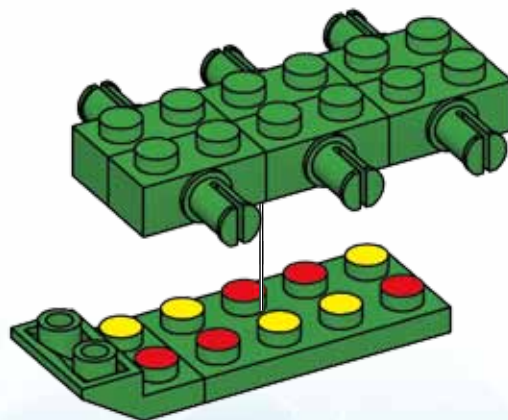
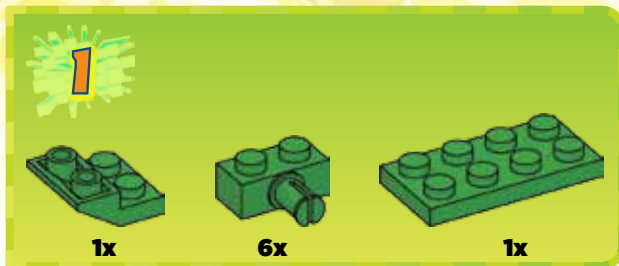

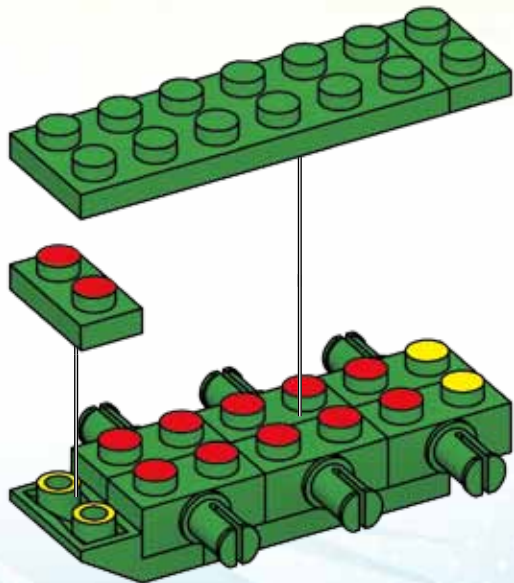
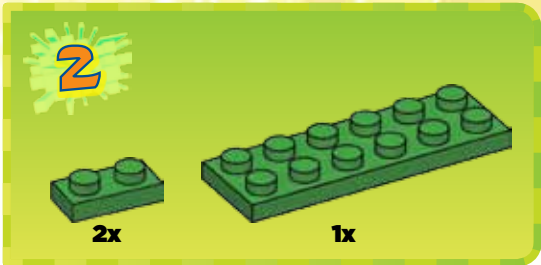

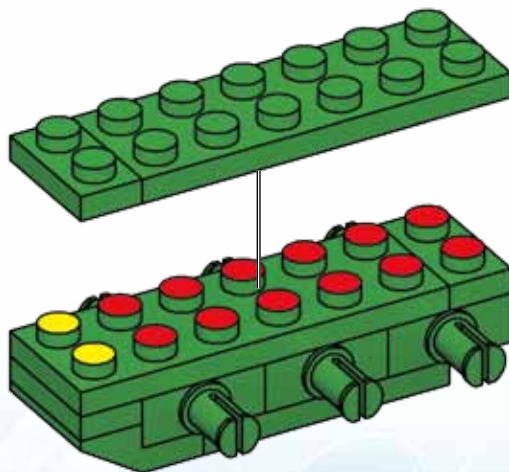
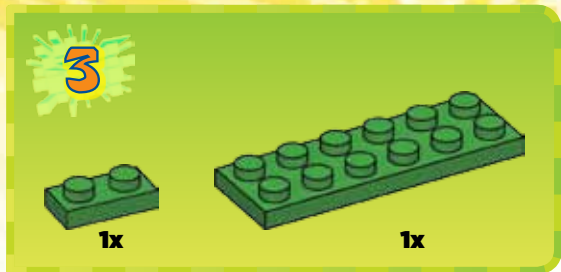



4

1x **2x** **2x**

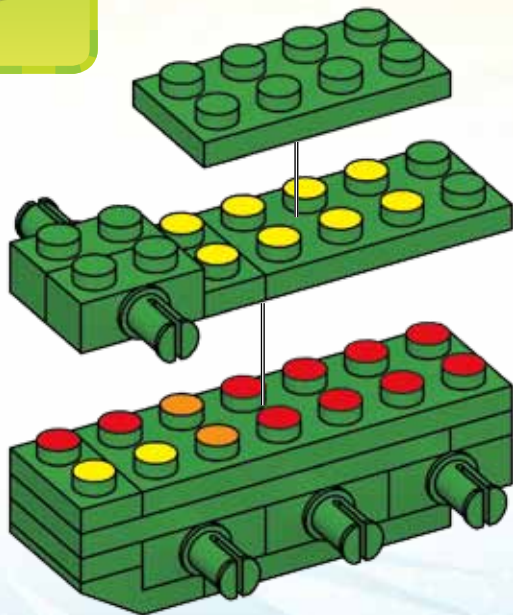

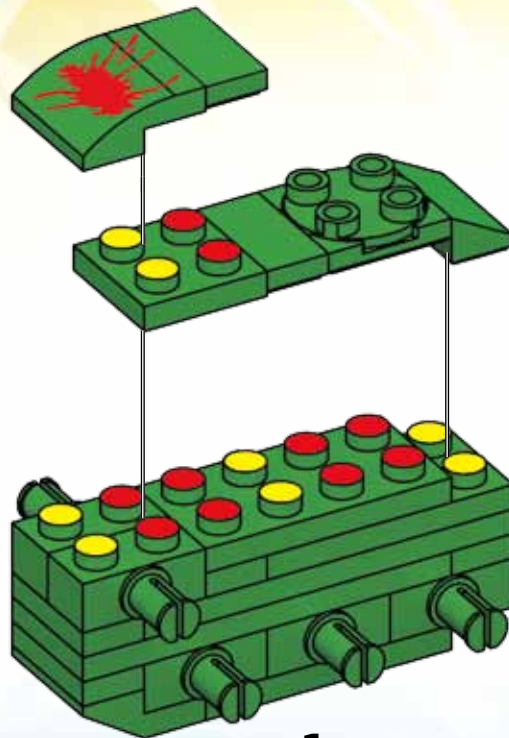
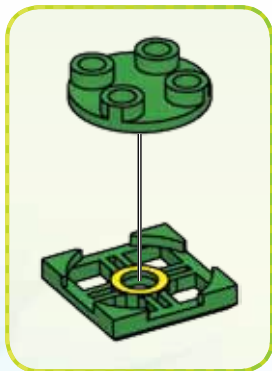
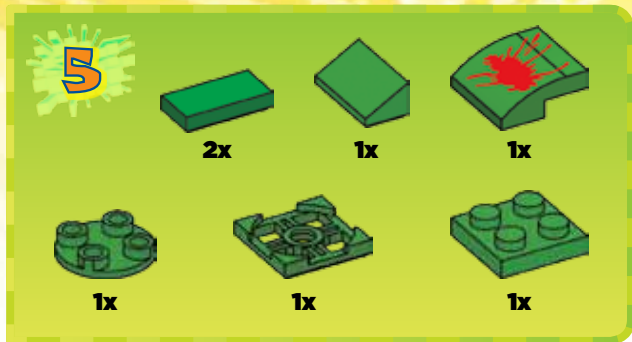

1



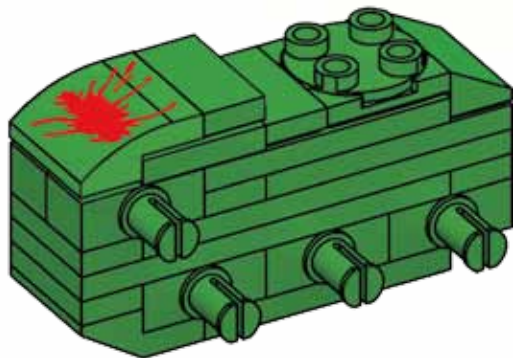

2



13

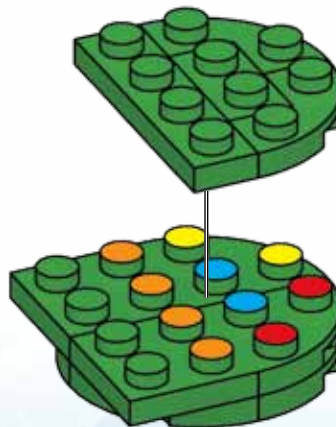
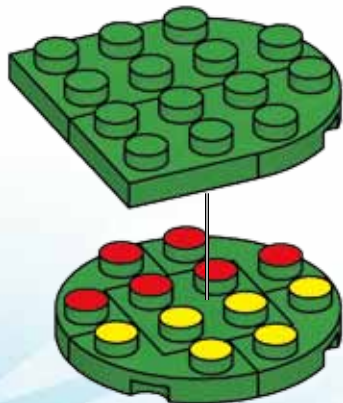
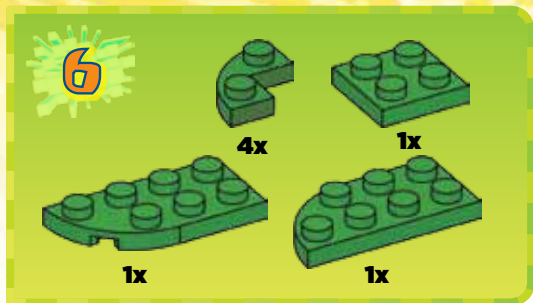



8



2x



1x

9



2x

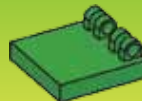

1x

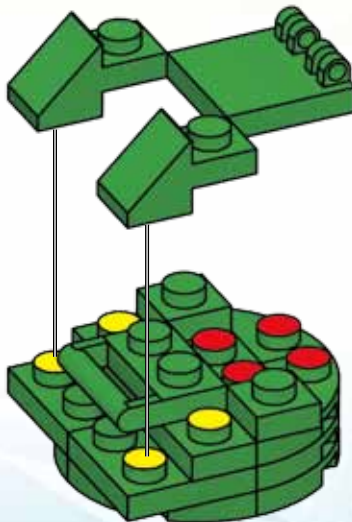
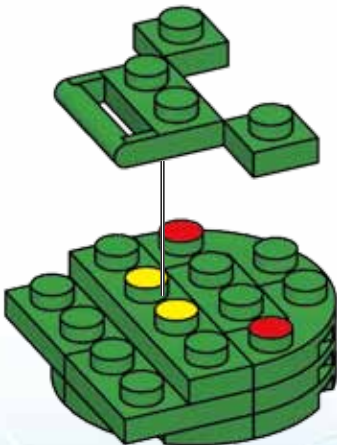

15

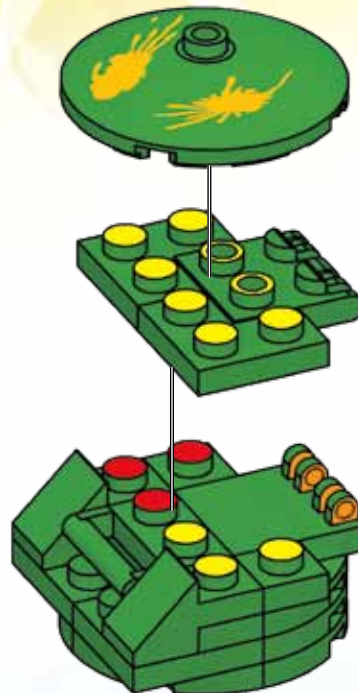

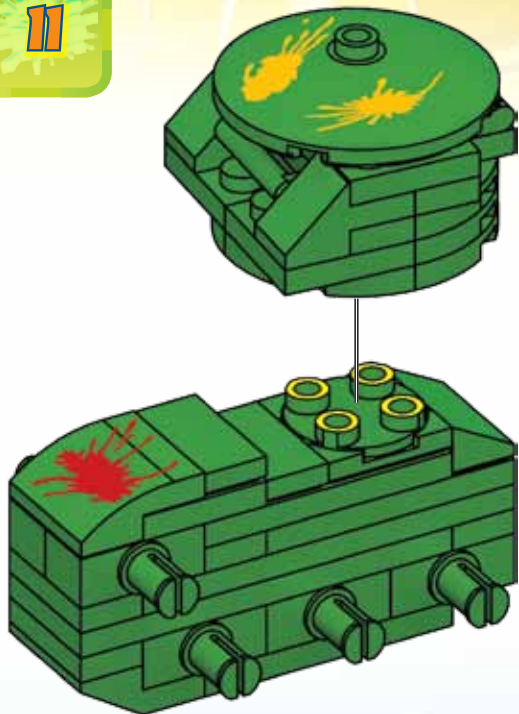

1

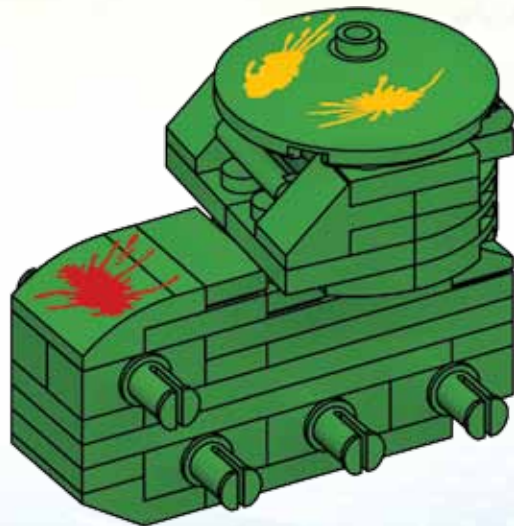

2





12



1x



2x



1x

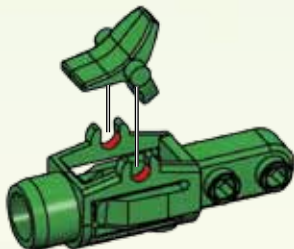

1

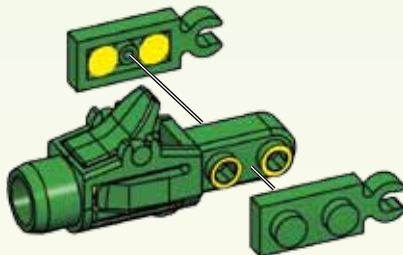

2



13

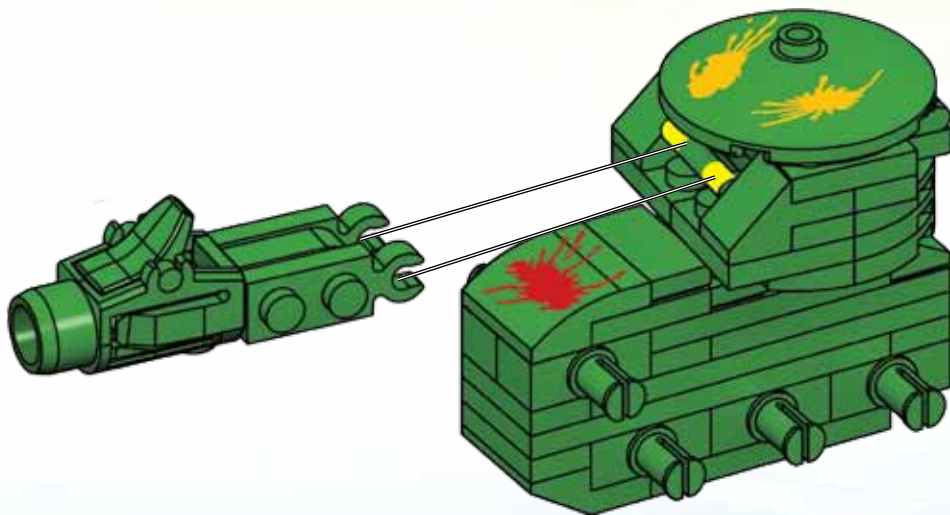

19



14



8x

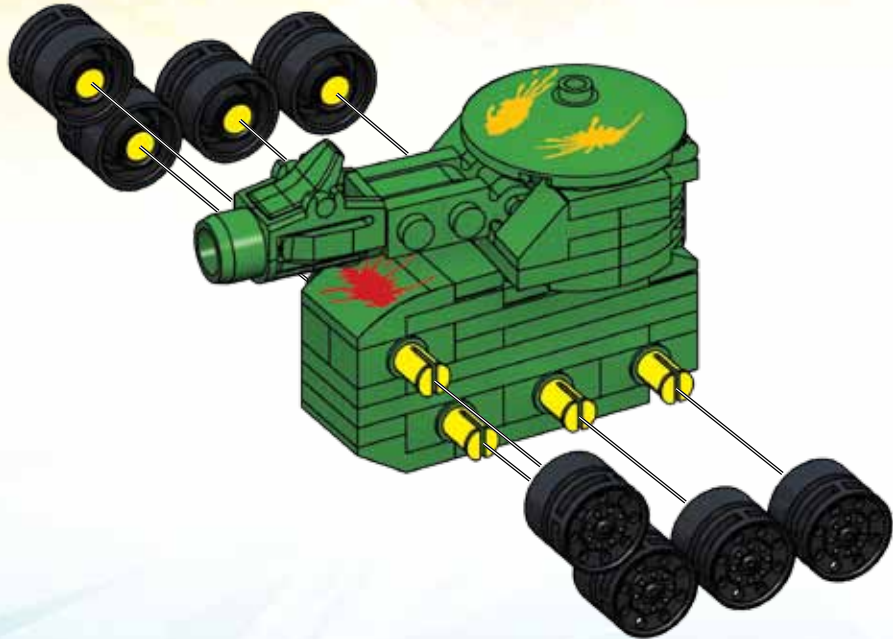

20







16



1x

Warning: Do not aim at eyes or face. Only use projectiles supplied with this toy. Do not fire at point blank range.

Attention : Ne pas viser les yeux ou le visage. Ne pas utiliser d'autres projectiles que ceux fournis avec ce jouet. Ne pas tirer à bout portant.

Advertencia: No apuntar hacia los ojos o la cara. Utilizar exclusivamente los proyectiles suministrados con este juguete. No disparar a quemarropa.

Atenção! Não apontar para os olhos e para a face. Não utilizar projéteis diferentes dos providos. Não disparar excessivamente perto do alvo.

Attenzione: Non puntare agli occhi o al viso. Usa solo i proiettili forniti con il giocattolo. Non sparare a distanza ravvicinata.

Achtung: Nicht auf Augen oder Gesicht zielen. Nur die zu diesem Spielzeug gehörenden Projektile verwenden. Nicht auf Menschen oder Tiere oder aus nächster Nähe zielen.

Ostrzeżenie: Nie celuj w oczy ani w twarz. Używaj wyłącznie rzutek BOOMco.™. Nie strzelaj z bliska.

Waarschuwing: niet op ogen of gezicht richten. Gebruik uitsluitend de bijgeleverde projectielen. Niet van te dichtbij afschieten.

Предупреждение: Не направляйте в глаза или лицо. Используйте только детали, входящие в комплект. Не стреляйте со слишком близкого расстояния.

Advarsel: Sigt ikke mod øjne eller ansigt. Brug kun de projektiler, som følger med legetøjet. Skyd ikke direkte på personer eller ting.

Varning! Sikta inte mot ögon eller ansikte. Använd endast projektiler som medföljer leksaken. Fyra inte av på mycket nära håll.

Advarsel: Du må ikke sikte mot øyne eller ansikt. Bruk bare prosjektilene som følger med leken. Ikke skyt på noe på kloss hold.

Varoitus: Älä tähtää silmiin äläkä kasvoihin. Käytä ainoastaan tämän tuotteen mukana tulleita ammuksia. Älä ammu lähietäisyydeltä.

Προσοχή: Μη στοχεύετε στα μάτια ή στο πρόσωπο. Χρησιμοποιείτε μόνο τα βλήματα που περιλαμβάνονται. Μη στοχεύετε προς ανθρώπους ή ζώα.

تحذير: يجب عدم التصويب باتجاه العينين أو الوجه. يجب استخدام المقذوفات المزودة مع هذه اللعبة فقط. يجب عدم الإطلاق من مدى قريب.

警告: 请勿对着眼睛或脸部发射。仅使用本玩具自带的抛射物。请勿近距离射击。

警告: 目や顔を狙わないでください。このおもちゃに同梱されている発射物のみ使用するようにしてください。到達可能な距離内で火を燃やさないでください。



1

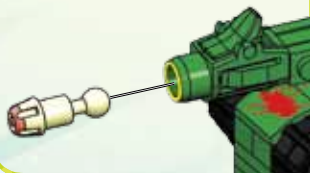

2



3



22





SPONGEBOB.MEGABLOKS.COM

©2015, MEGA Brands Inc. ® & ™ MEGA Brands Inc.
 Printed in Canada D946551

