

**MEGA
BLOKS**

PROBUILDER®

9734

M1A1 Abrams tank



Ages / Años / Âges

Pieces / Piezas / Pièces

7+

850



10x
M1086DR

36x
M09013DR

2x
M09013F

12x
M1087DR

45x
M10233DR

180x
M09033DR

18x
M09023DR

4x
M09023W

1x
M1320F

14x
M1322DR

1x
M1322F

15x
M10273DR

2x
M10273F

10x
M1323DR

1x
M1323F

6x
M1417DR

2x
M1418DR

18x
M1154DR

16x
M1139DR

3x
M11132D

18x
M1113F

59x
M09393DR

40x
M09593DR

94x
M09493DR

28x
M1480DR

5x
M1172DR

1x
M09493F

5x
M1146F

2x
AM01495F

2x
AM02215F

1x
M1404F

14x
M1312F

10x
M1225F

2x
M11101F

67x
M0948DR

16x
M1346DR

2x
M1389DR

2x
AM02236DR

15x
AM02228DR

2x
AM02238DR

9x
AM02232DR

1x
AM02234DR

1x
AM02233DR

21x
AM02237DR

2x
M1324DR

1x
AM01485F

14x
AM02227JG

2x
AM02235F

1x
AM01486F

2x
M1147F

2x
X097343

1x
AS0973415

2x
M1115F

1x
AX097341

1x
AS0973413

4x
AM01530DR

2x
AS0973412

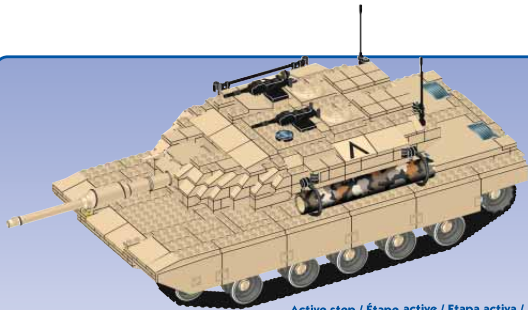

Active step / Étape active / Etapa activa / Azione attiva
Aktivt skede / Actieve stap / アクティブなステップ / 積極ステップ

Previous step / Étape précédente / Etapa precedente
Azione precedente / Föregående skedet / Yorige stap
前のステップ / 上一步驟

Color chart.

Charte de couleurs.

Cuadro cromático.

Quadro cromatico.

Färgtabell.

Kleurenkaart.

カラーチャート

色彩表

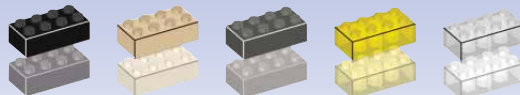

Adult assistance is required. / L'aide d'un adulte est requise. / Necesita ayuda de un adulto. / È necessario l'aiuto di un adulto. /
Hjälp av en vuxen är nödvändig. / Hulp van een volwassene is gewenst. / 大人の方が手伝ってあげる必要があります。 / 需要成年人協助



WARNING:
Choking hazard— Small parts.
Not for children under 3 years.

AVERTISSEMENT:
Risque de suffocation. Ne convient pas à un enfant
de moins de 3 ans - contient de petits éléments.

ADVERTENCIA:
Peligro de asfixia. No recomendado para niños
menores de 3 años-contiene piezas pequeñas.

AVVERTENZA:
Rischio di soffocamento. Non adatta ad un bambino
di età minore ai 36 mesi. Contiene parti piccole - non
ingerire.

WARNING:
Risk for kvävning. Ikke egnet til barn under
3 år - inneholder smådeler.

WAARSCHUWING:
Stikgevaar. Niet geschikt voor kinderen onder
3 jaar - i.v.m. kleine onderdelen.

注意:
飲み込むと 危険です。
小さいパーツがあるので、
3才以下の幼児には
与えないでください。
⚠️ 不適合三岁以下儿童。

1

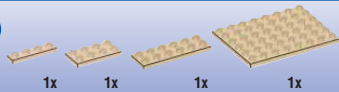

2

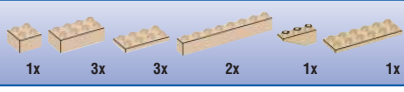

3

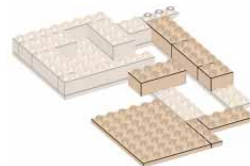
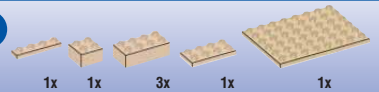

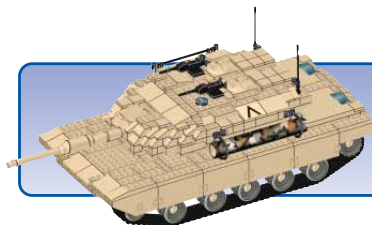

Active step / Étape active / Etapa activa / Azione attiva
 Aktivt skede / Actieve stap / アクティブなステップ / 積極步驟
 Previous step / Étape précédente / Etapa precedente
 Azione precedente / Föregående skedet / Vorige stap
 前のステップ / 上一步驟

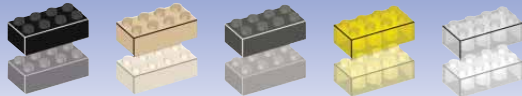

4

1x 4x 2x 1x

5

5x 2x 2x 2x 4x

6

2x 10x 1x 2x 4x

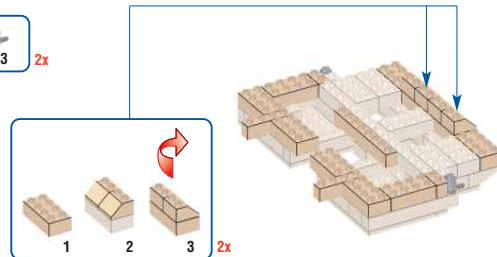
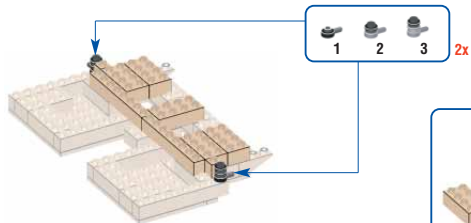

7

3x 1x 8x 4x 2x

8

2x 2x 2x 8x 4x

9

17x 2x 2x 5x

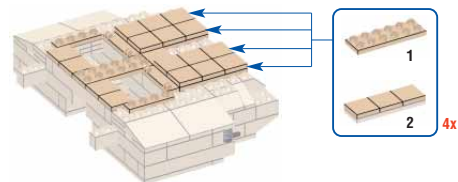
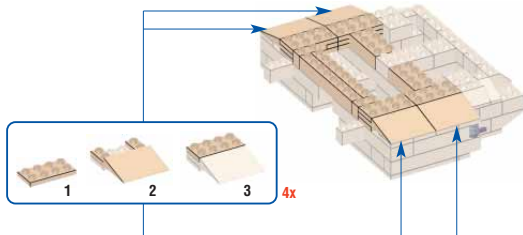

10



4x

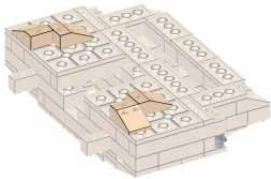

11

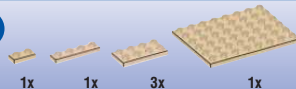

12



13



14



15



16

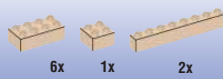

17

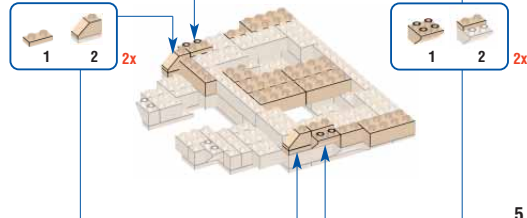

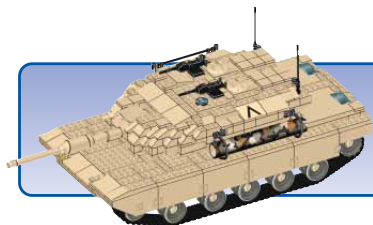

Active step / Étape active / Etapa activa / Azione attiva
 Aktivt skede / Active step / アクティブなステップ / 積極步驟
 Previous step / Étape précédente / Etapa precedente
 Azione precedente / Føregående skedet / Vorige stap
 前のステップ / 上一步驟

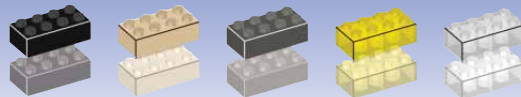

18



19



20

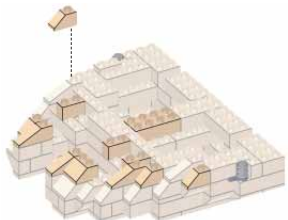

21

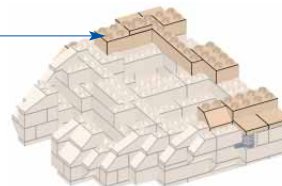
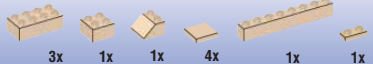

22

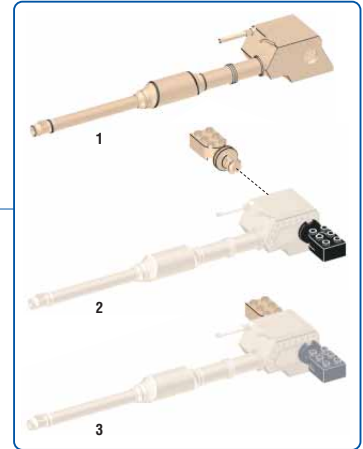
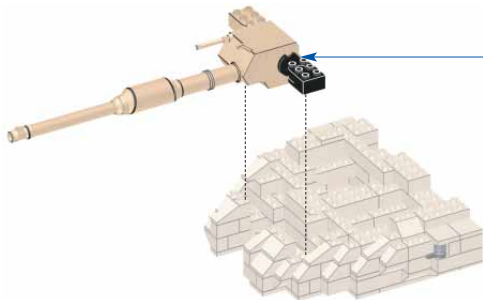
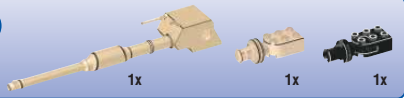

23



24

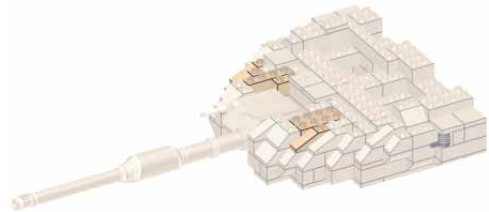
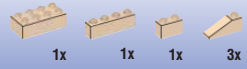

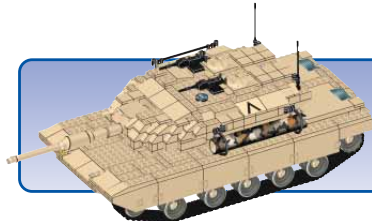

Active step / Étape active / Etapa activa / Azione attiva
 Aktivt skede / Active stap / アクティブなステップ / 積極步驟

Previous step / Étape précédente / Etapa precedente
 Azione precedente / Føregående skedet / Vorige stap
 前のステップ / 上一步驟

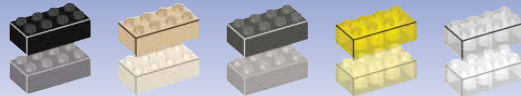

25



26

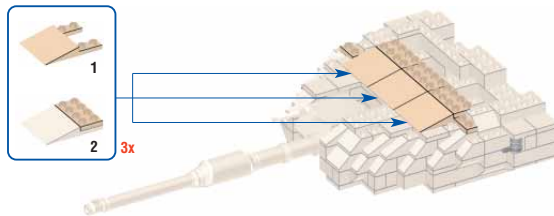
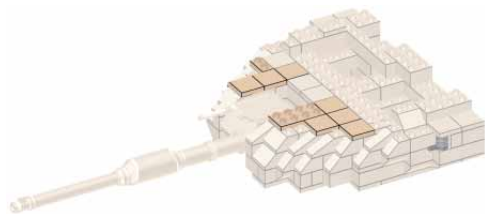
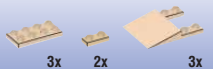

27

10

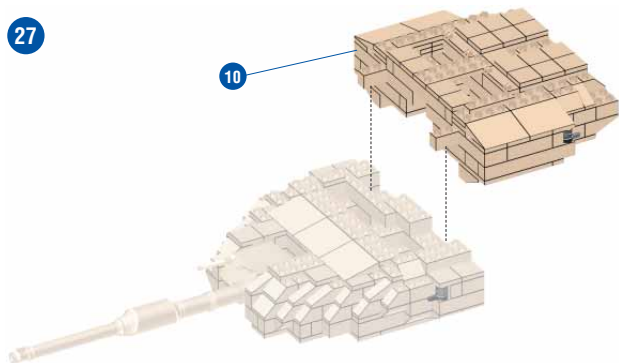

28

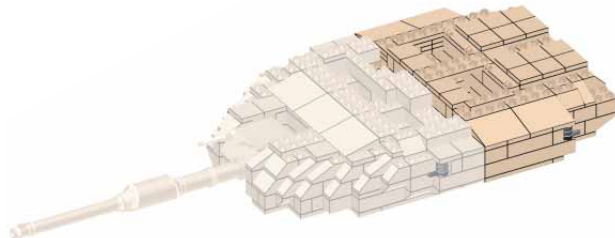

29

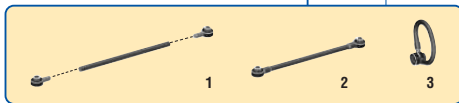
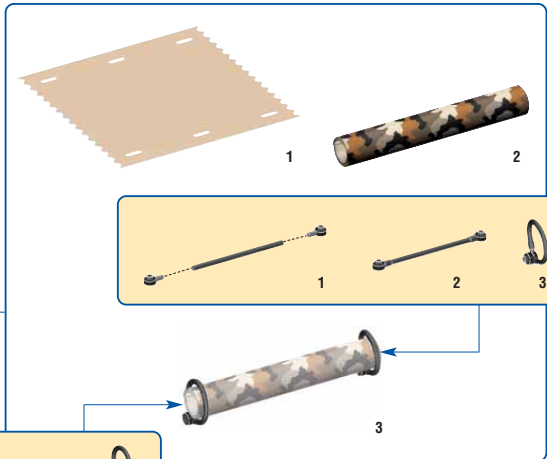

30

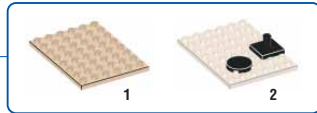
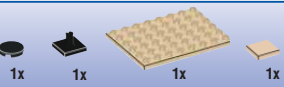

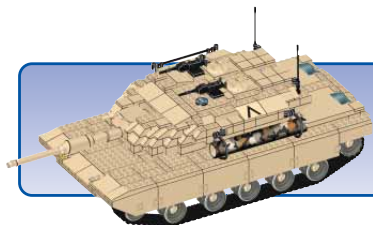

Active step / Étape active / Etapa activa / Azione attiva
 Aktivt skede / Active stap / アクティブなステップ / 積極步驟
 Previous step / Étape précédente / Etapa precedente
 Azione precedente / Föregående skedet / Vorige stap
 前のステップ / 上一步驟

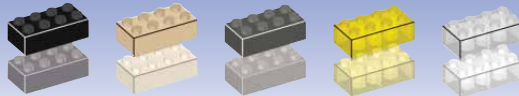

31



1x

32



5x

5x

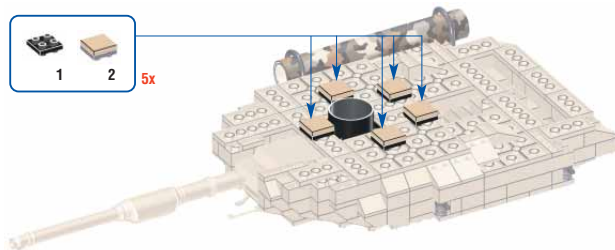
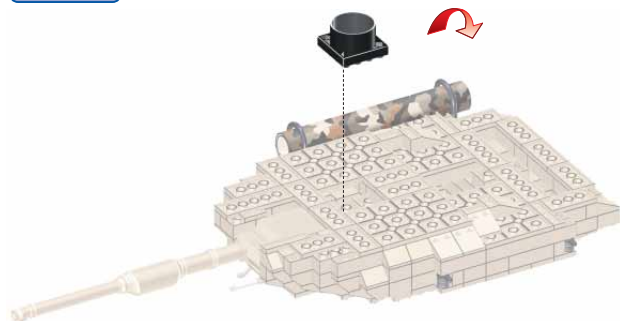

33



1x

1x

1x

2x

1x

1x

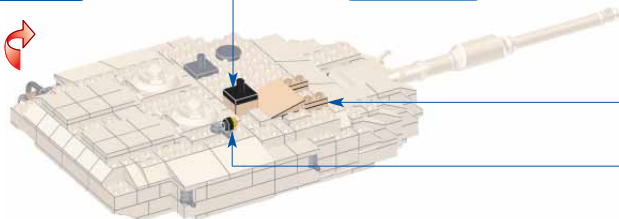

1

2



1

2



1

2

34

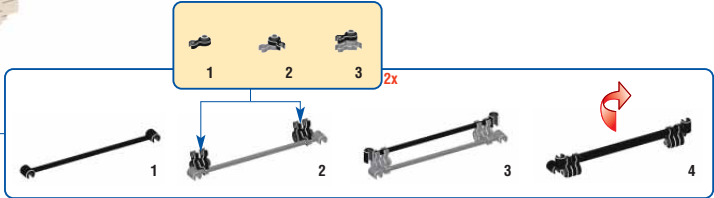
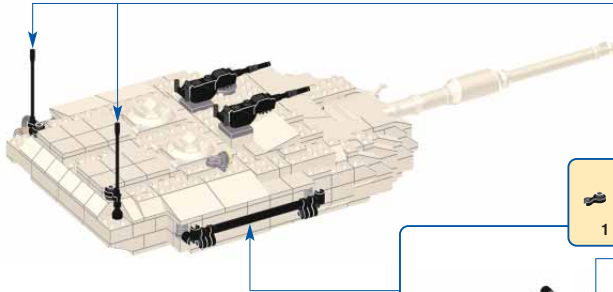
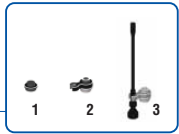

35

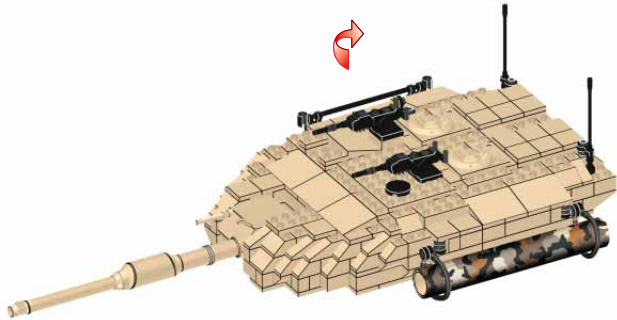

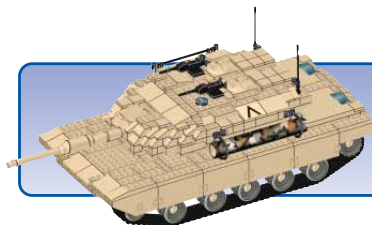

Active step / Étape active / Etapa activa / Azione attiva
 Aktivt skede / Active step / アクティブなステップ / 積極步驟
 Previous step / Étape précédente / Etapa precedente
 Azione precedente / Föregående skedet / Vorige stap
 前のステップ / 上一步驟

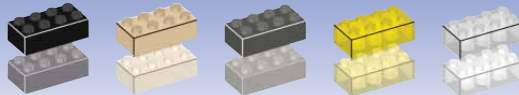

36



37

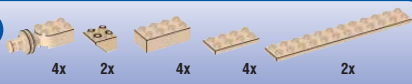

38

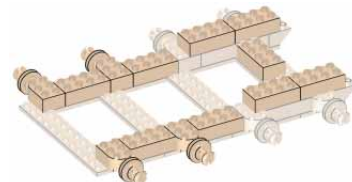
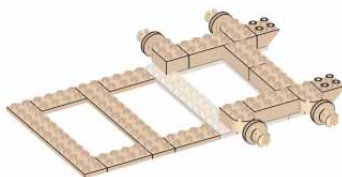

39

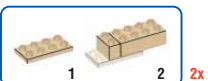
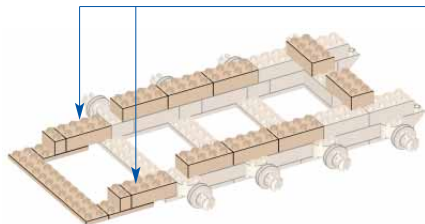
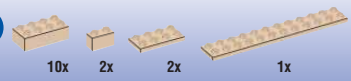

40

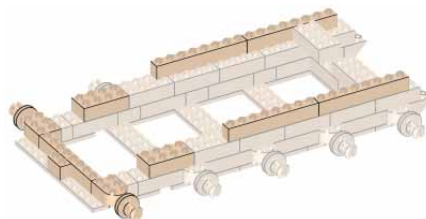
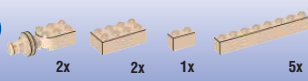

41



6x



2x



5x



2x



2x

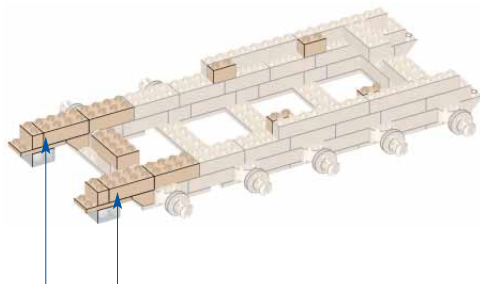

1



2



3



4



2x

42



2x



2x



4x



2x



2x



1

2



1

2

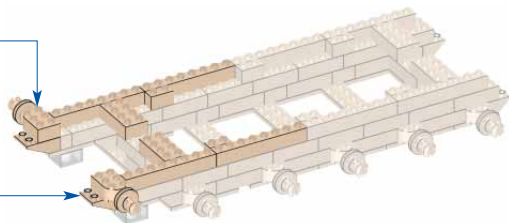

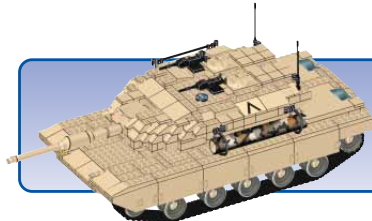

Active step / Étape active / Etapa activa / Azione attiva
 Aktivt skede / Active stap / アクティブなステップ / 積極步驟
 Previous step / Étape précédente / Etapa precedente
 Azione precedente / Föregående skedet / Vorige stap
 前のステップ / 上一步驟

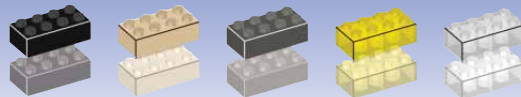

43

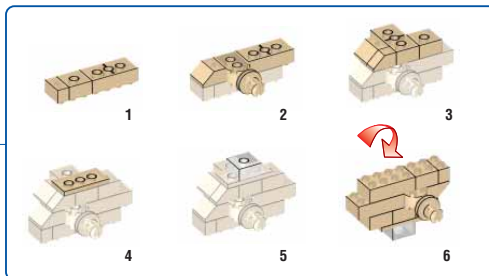
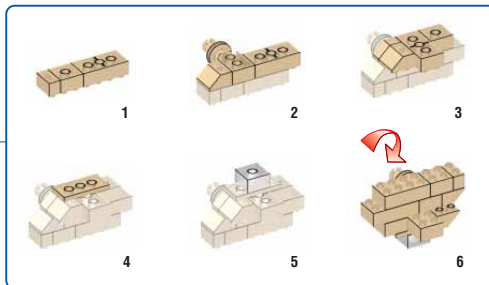
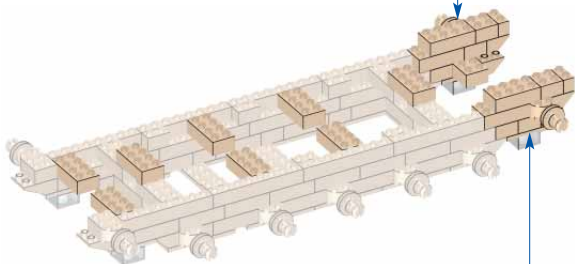
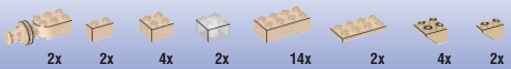

44



16x

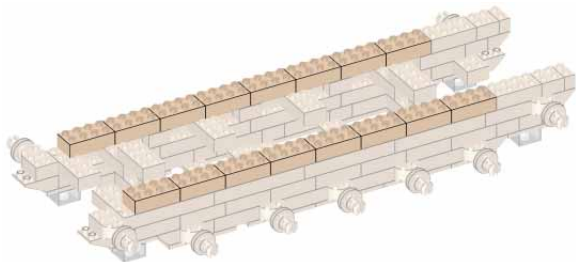

45



3x

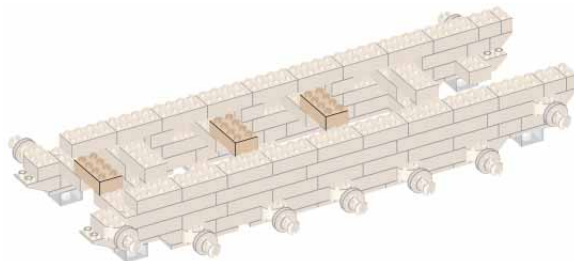

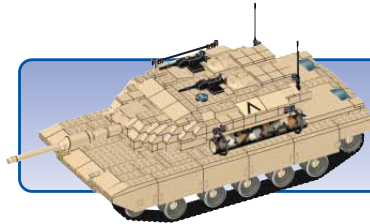

Active step / Étape active / Etapa activa / Azione attiva
 Aktivt skede / Active step / アクティブなステップ / 積極步驟
 Previous step / Étape précédente / Etapa precedente
 Azione precedente / Föregående skedet / Vorige stap
 前のステップ / 上一步驟

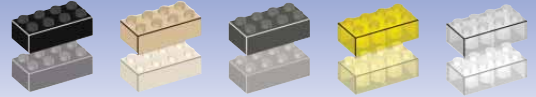

46

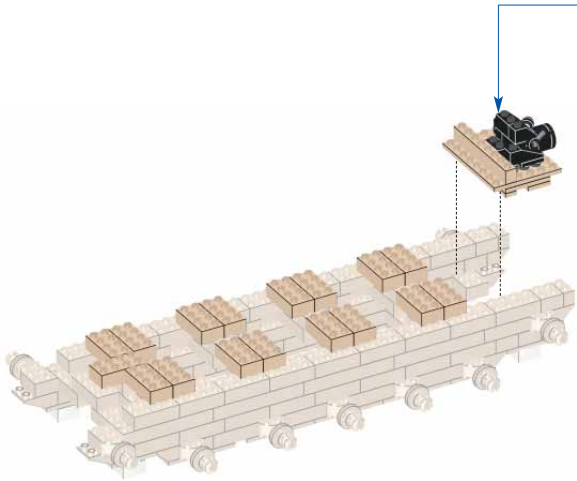
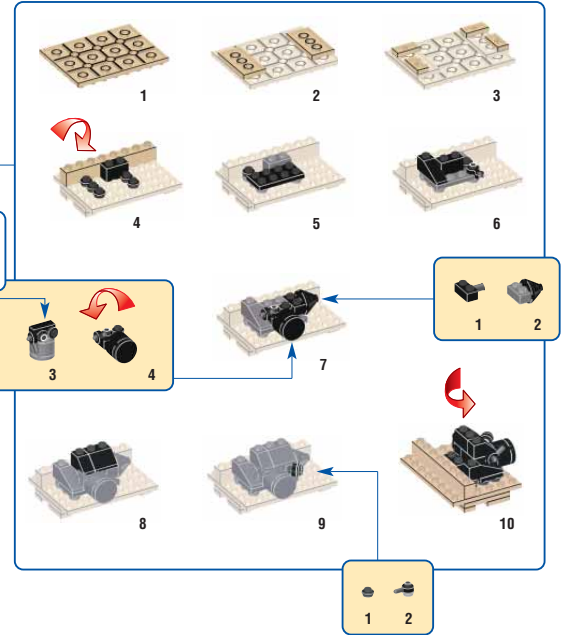
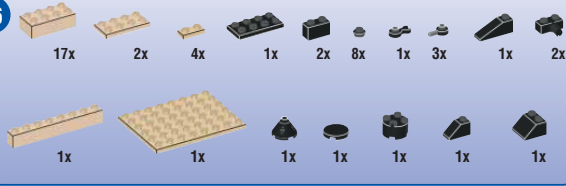

47



1x

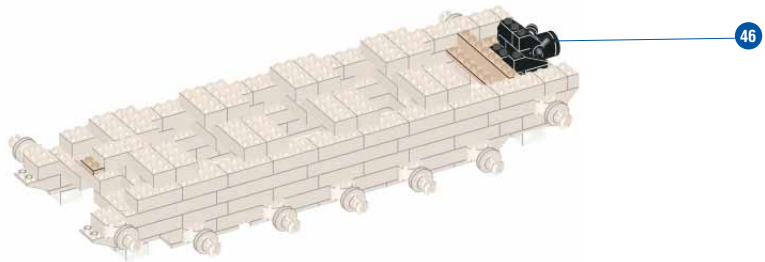

48



7x



2x



4x



6x



1x



5x



2x



2x



4x

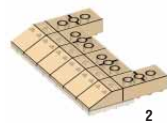
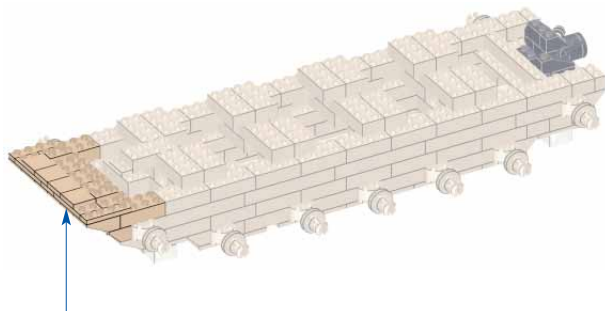

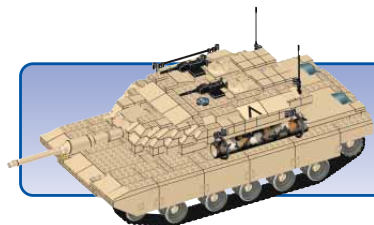

Active step / Étape active / Etapa activa / Azione attiva
 Aktivt skede / Active step / アクティブなステップ / 積極步驟
 Previous step / Étape précédente / Etapa precedente
 Azione precedente / Föregående skedet / Vorige stap
 前のステップ / 上一步驟

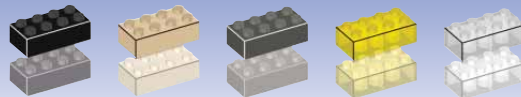

49



50

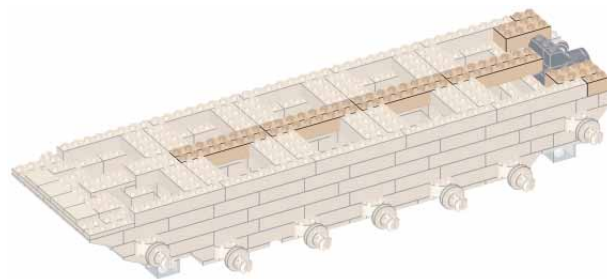
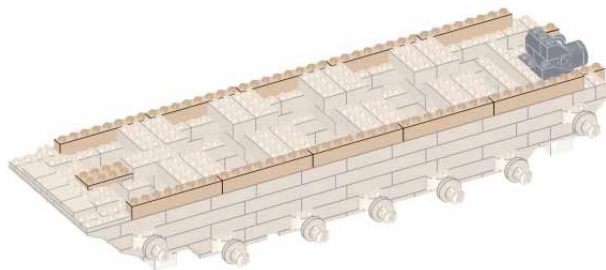
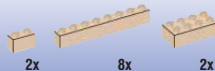

51

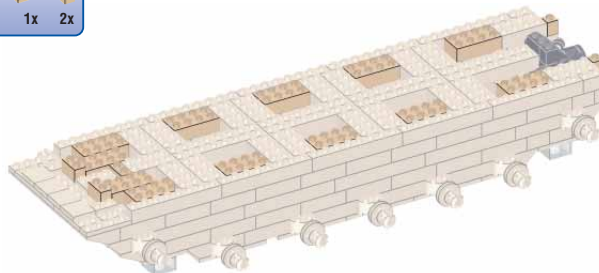

52

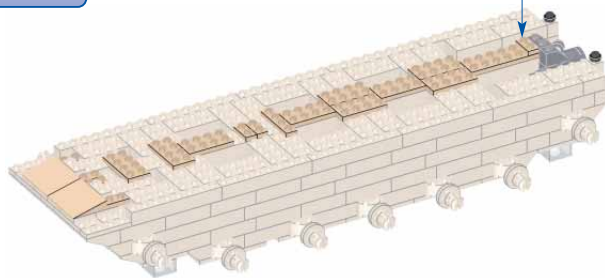

53

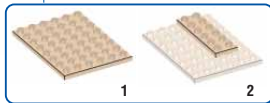
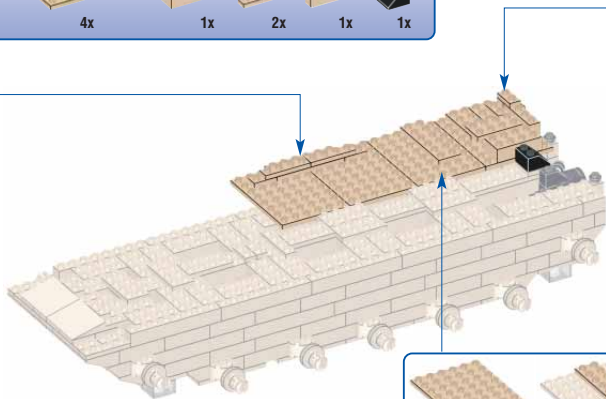
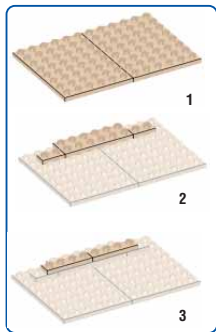
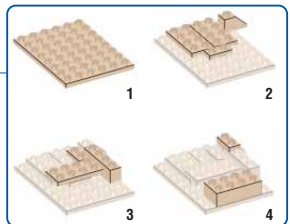
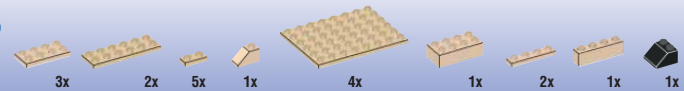

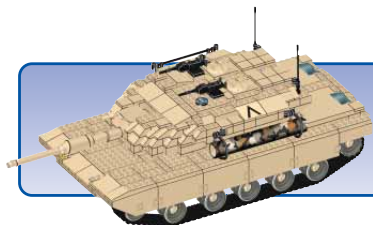

Active step / Étape active / Etapa activa / Azione attiva
 Aktivt skede / Active stap / アクティブなステップ / 積極步驟
 Previous step / Étape précédente / Etapa precedente
 Azione precedente / Föregående skedet / Vorige stap
 前のステップ / 上一步驟

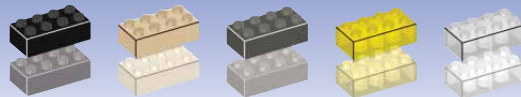

54

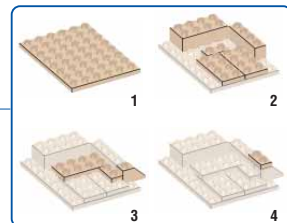
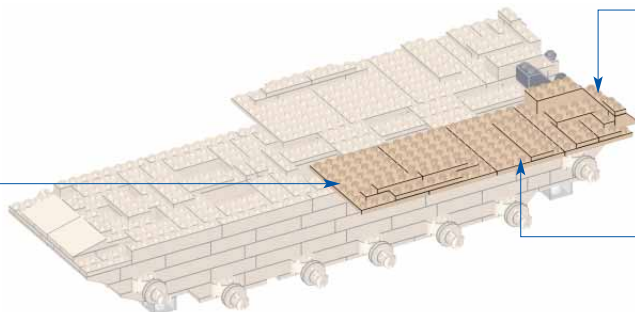
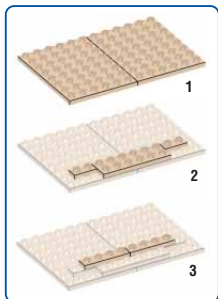
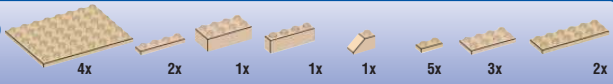

55

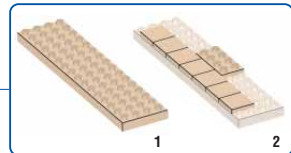
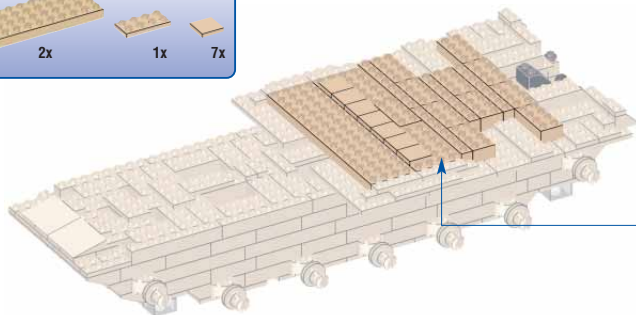
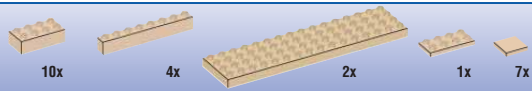

56

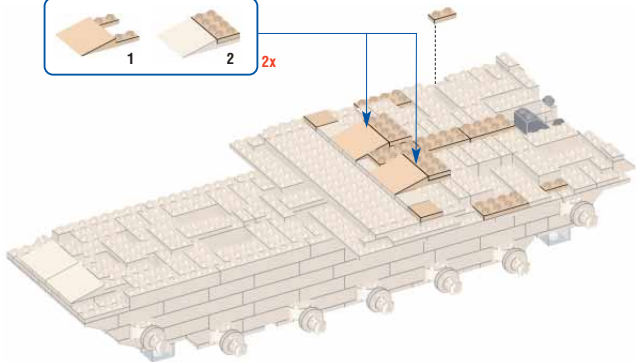

57

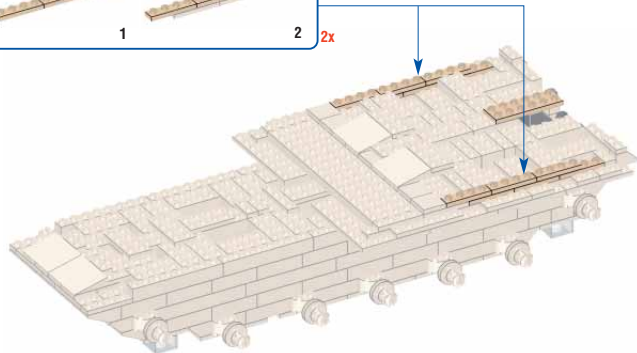

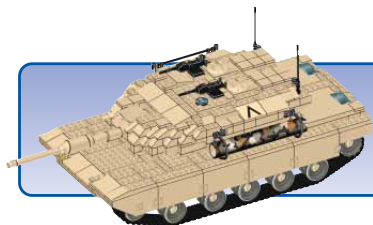

Active step / Étape active / Etapa activa / Azione attiva
 Aktivt skede / Active stap / アクティブなステップ / 積極步驟
 Previous step / Étape précédente / Etapa precedente
 Azione precedente / Föregående skedet / Vorige stap
 前のステップ / 上一步驟

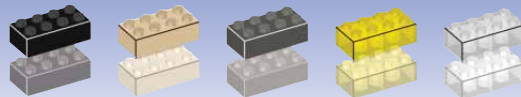

58

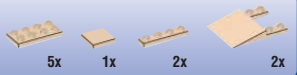

5x 1x 2x 2x

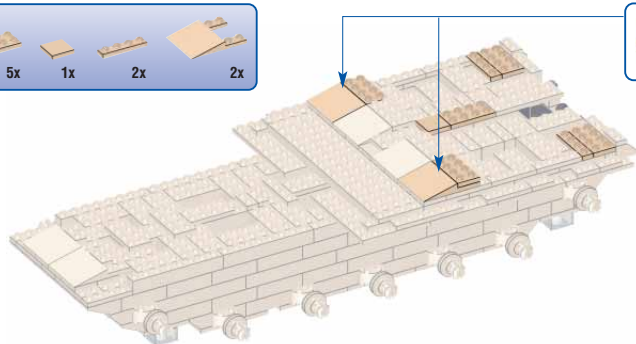

59

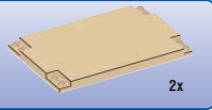

2x

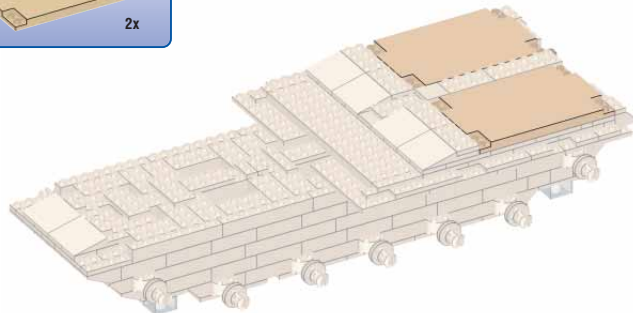

60

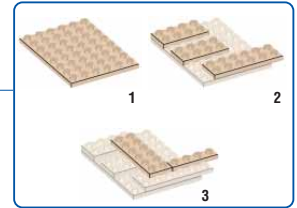
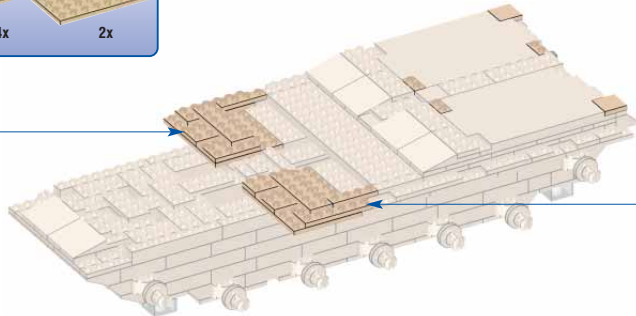
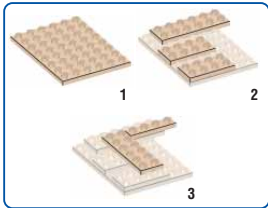
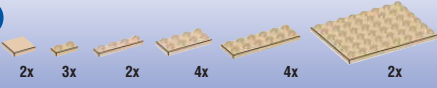

61

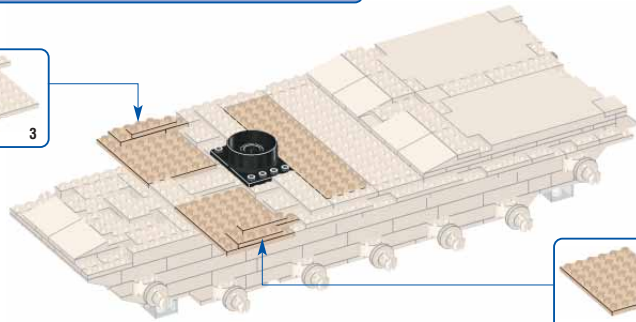
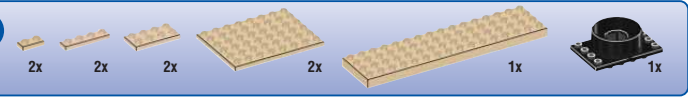

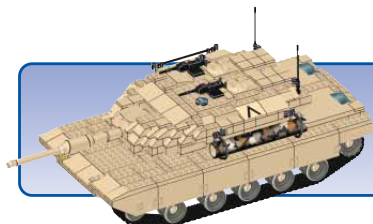

Active step / Étape active / Etapa activa / Azione attiva
 Aktivt skede / Active step / アクティブなステップ / 積極步驟

Previous step / Étape précédente / Etapa precedente
 Azione precedente / Föregående skedet / Vorige stap
 前のステップ / 上一步驟

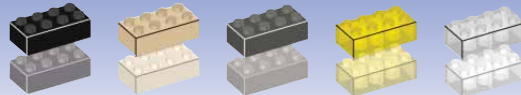

62

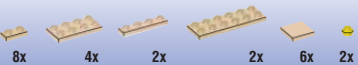

1

2

3

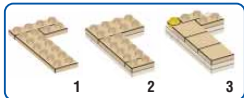

1

2

3

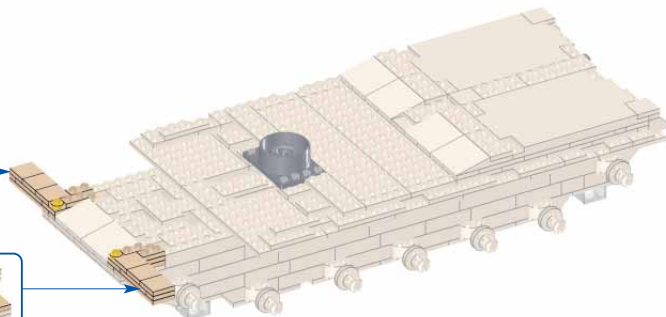

63

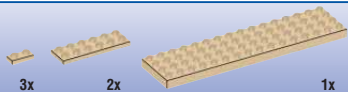

3x

2x

1x

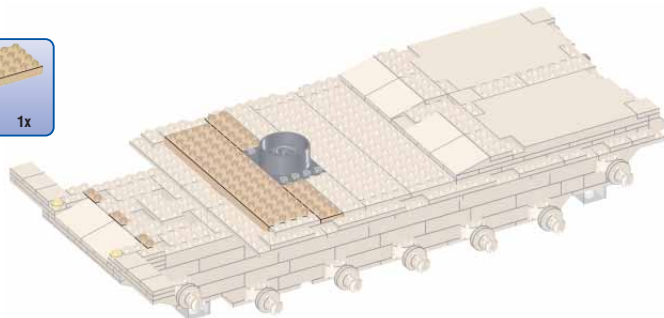

64

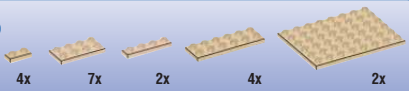

1



2



3



1



2



3

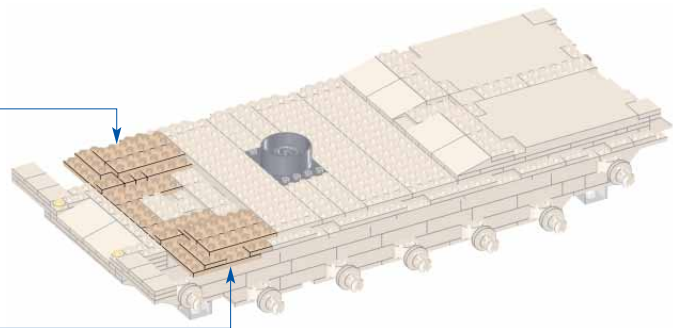

65

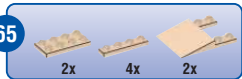

1



2

2x

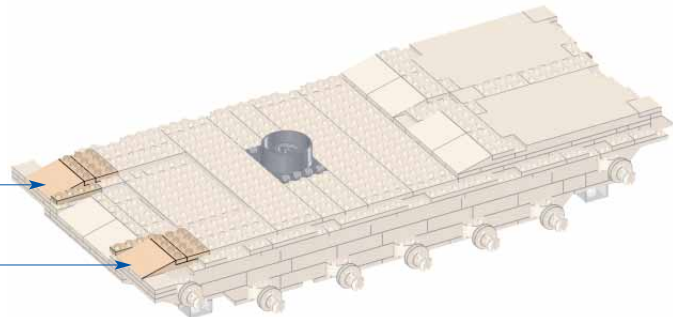

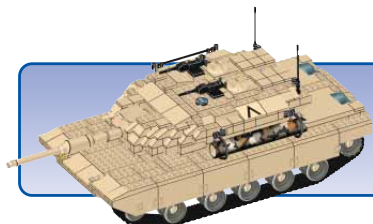

Active step / Étape active / Etapa activa / Azione attiva
Aktivt skede / Actieve stap / アクティブなステップ / 積極步驟
Previous step / Étape précédente / Etapa precedente
Azione precedente / Föregående skedet / Vorige stap
前のステップ / 上一步驟

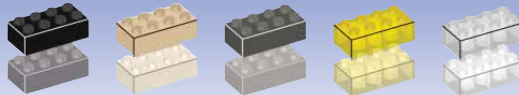

66

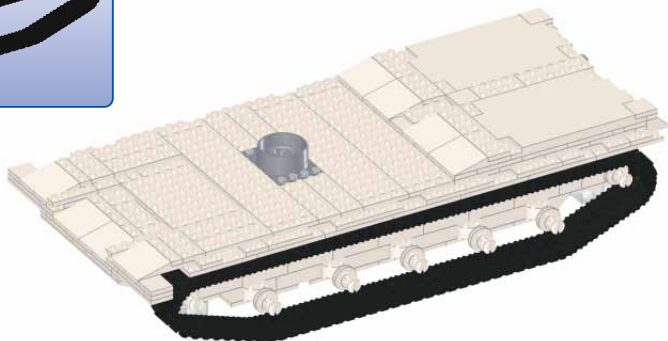
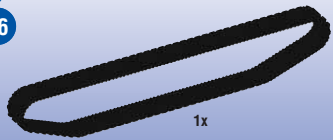

67



5x

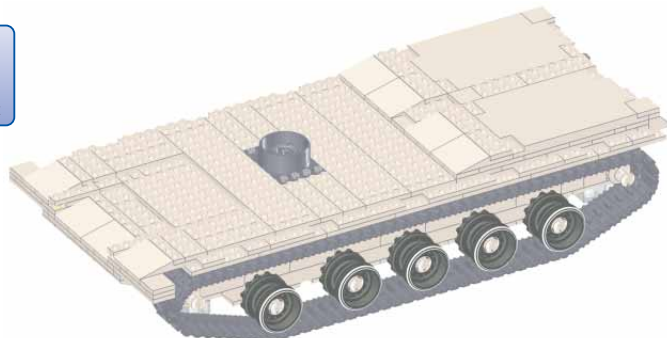

68



2x

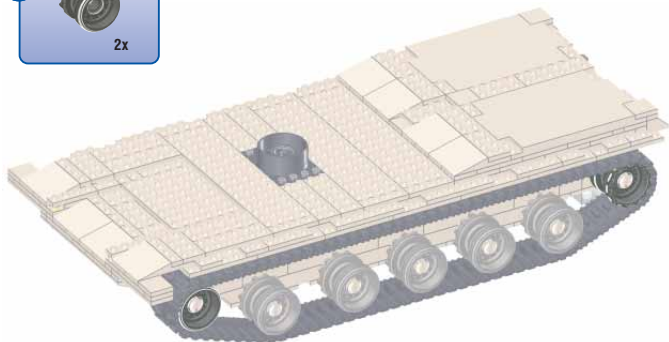

69

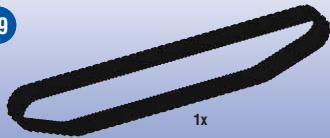

1x

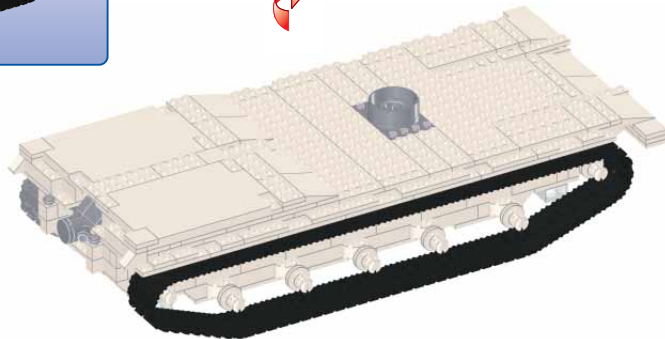

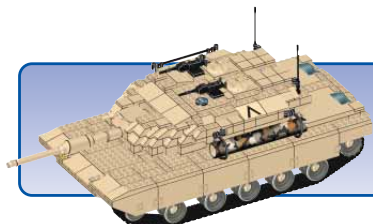

Active step / Étape active / Etapa activa / Azione attiva
 Aktivt skede / Active step / アクティブなステップ / 積極步驟
 Previous step / Étape précédente / Etapa precedente
 Azione precedente / Föregående skedet / Vorige stap
 前のステップ / 上一步驟

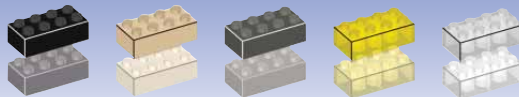

70



5x

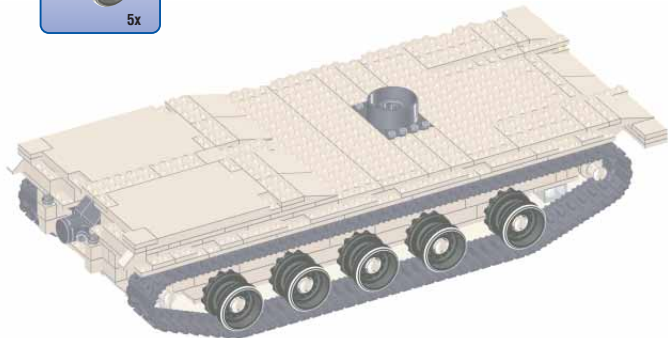

71



2x

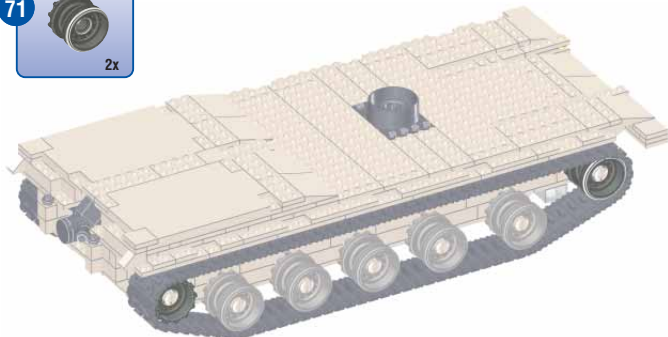

72

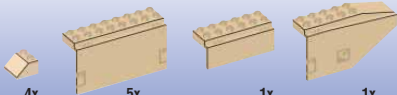

4x

5x

1x

1x



1



2

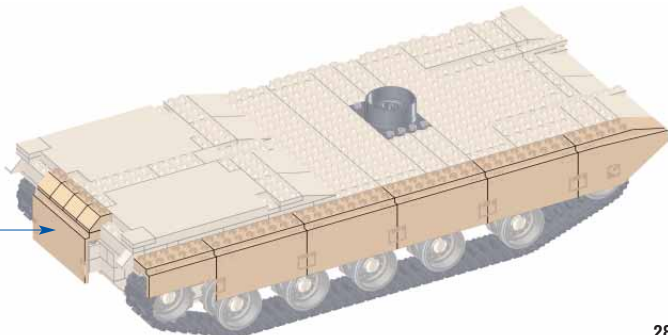

73

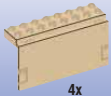

4x



1x



1x

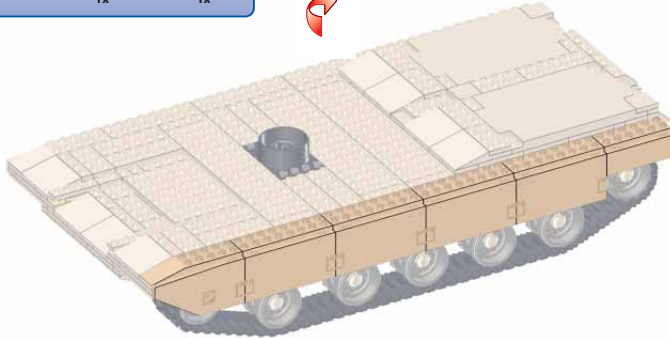

74

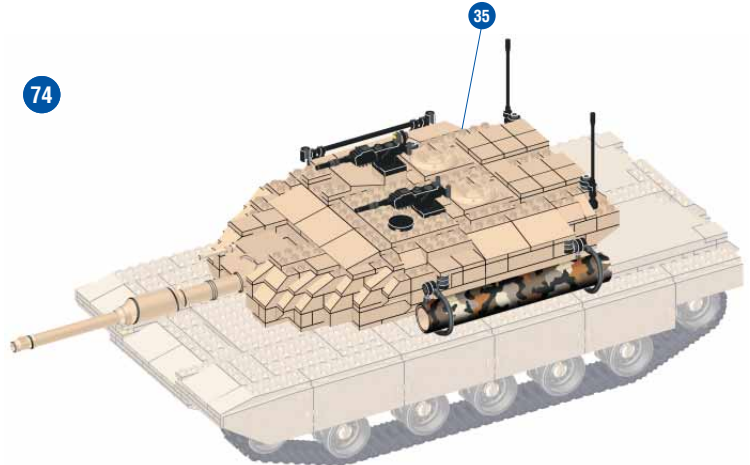

35

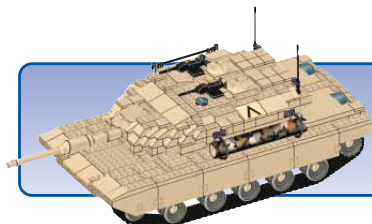

Active step / Étape active / Etapa activa / Azione attiva
 Aktivt skede / Actieve stap / アクティブなステップ / 積極步驟

Previous step / Étape précédente / Etapa precedente
 Azione precedente / Föregående skedet / Vorige stap
 前のステップ / 上一步驟

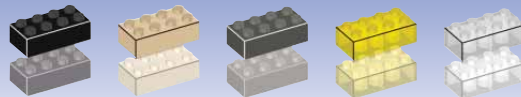

75

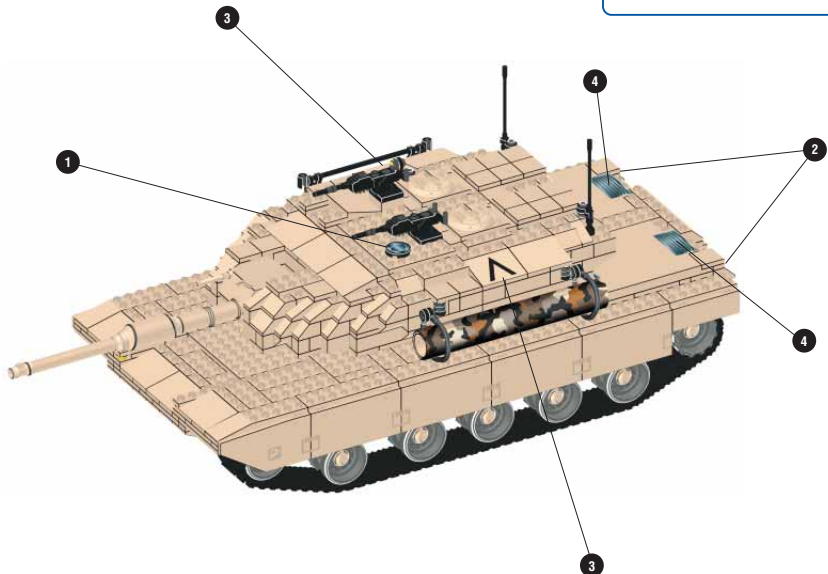

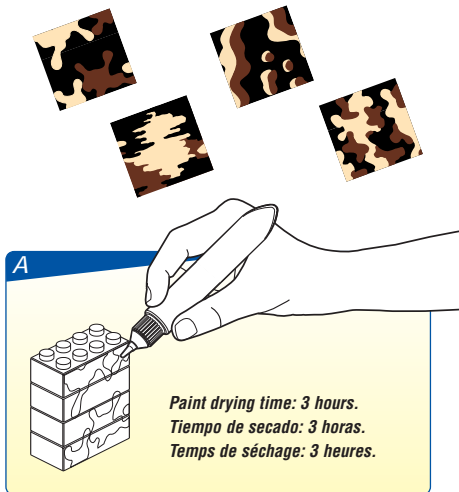

A

*Paint drying time: 3 hours.
Tiempo de secado: 3 horas.
Temps de séchage: 3 heures.*

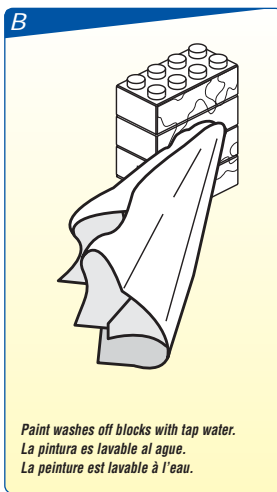

B

*Paint washes off blocks with tap water.
La pintura es lavable al agua.
La peinture est lavable à l'eau.*

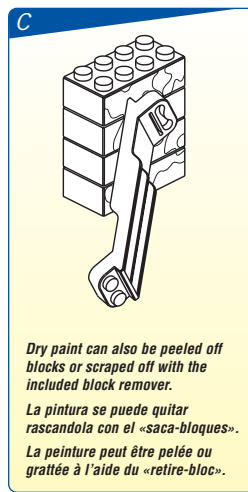

C

Dry paint can also be peeled off blocks or scraped off with the included block remover.

*La pintura se puede quitar rascandola con el «saca-bloques».
La peinture peut être pelée ou grattée à l'aide du «retire-bloc».*

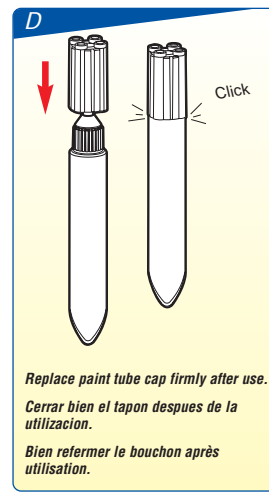

D

Replace paint tube cap firmly after use.

Cerrar bien el tapon despues de la utilización.

Bien refermer le bouchon après utilisation.

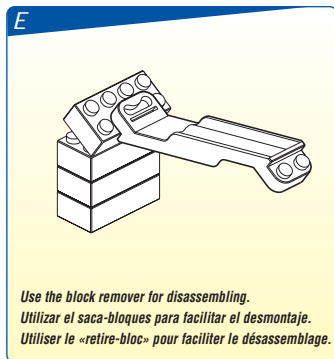

E

*Use the block remover for disassembling.
Utilizar el saca-bloques para facilitar el desmontaje.
Utiliser le «retire-bloc» pour faciliter le désassemblage.*



F

CAUTION ATENCION ATTENTION

*Paint may stain fabric and clothing.
La pintura puede manchar los tejidos y la ropa.
La peinture peut tacher les tissus et les vêtements.*



Collect them all Coleccionalos todos Collectionne-les tous



Movable turret and cannon
Cañón y torreta móviles
Tourelle et canon mobiles

Movable treads
Escaleras móviles
Chenilles mobiles



Opening hatches
Apertura de las escotillas
Écoutilles ouvrantes



2 Mega Bloks®Camo-Stiks™ included/incluidos/inclus

The M1A1 Abrams tank was named for the late General Creighton W. Abrams, former Army Chief of Staff and commander of the 37th Armored Battalion. The first M-1 tanks were delivered to the U.S. Army on February 28, 1980.

M1A1 SPECIFICATIONS

Crew:	4 - driver, commander, gunner/loader
Weight:	49.54 tons (109,623 kilograms)
Length:	32 feet 3 inches (9.8 meters)
Turret height:	7 feet 10 inches (2.4 meters)
Width:	12 feet (3.7 meters)
Ground clearance:	19 inches (48.26 cm)
Propulsion:	Gas turbine engine, 1500 horsepower
Top speed:	42 m.p.h. (68 km/h)
Main armament:	120 mm smooth bore cannon, M256
Crew weapons:	2 x 7.62 mm machine guns

El tanque Abrams M1A1 fue bautizado con el nombre del fallecido General Creighton W. Abrams, antiguo jefe del Estado Mayor del Ejército y comandante del Batallón Blindado n.º 37. El primero de los tanques M-1 fue entregado al ejército norteamericano el 28 de febrero de 1980.

CARACTERÍSTICAS DEL TANQUE M1A1

Tripulación:	4 personas: Conductor, comandante, artillero y cargador.
Peso:	70.652 kilogramos
Longitud:	9,8 metros
Altura de la torreta:	2,4 metros
Anchura:	3,7 metros
Distancia mínima al suelo:	48,26 cm
Propulsión:	motor con turbina de gas de 1500 CV
Velocidad punta:	68 km/h
Armamento principal:	cañón liso de 120 mm, modelo M256
Armas de la tripulación:	2 metraladoras de 7,62 mm

Le char d'assaut Abrams M1A1 a été nommé en mémoire du défunt général Creighton W. Abrams, ancien chef d'état-major et commandant du 37^e bataillon blindé. Les premiers chars d'assaut M-1 ont été livrés aux forces terrestres des États-Unis le 28 février 1980.

CARACTERÍSTICAS DU M1A1 :

Équipage :	4, incluant un chauffeur, un chef d'équipage, un carabinier et un chargeur.
Poids :	69,54 tonnes (70 652 kilogrammes)
Longueur :	32 pieds et 3 pouces (9,8 mètres)
Hauteur de la tourelle :	7 pieds et 10 pouces (2,4 mètres)
Largeur :	12 pieds (3,7 mètres)
Garde au sol :	19 pouces (48,26 cm)
Propulsion :	turbine à gaz, 1500 chevaux-vapeur
Vitesse maximale :	42 mi/h (68 km/h)
Armement principal :	canon à âme lisse de 120 mm, M256
Armes de l'équipage :	2 mitrailleuses de 7,62 mm