



97069

Versus: Snowbound Highbase • Versus: Base alta Snowbound • Versus: Base surélevée du Blizzard  
Gegen: Eingeschnittes Kampfgebiet • Tegen: Snowbound-gevechtsterrein  
Contro: Battlescape Snowbound • Contra: Battlescape Snowbound



### Versus: Snowbound Highbase

Choose your side and recreate arctic showdowns as Red and Blue Team race to control Snowbound High Base! The Red Team Spartan EVA's boots crunch into freshly packed snow as he makes a break for it with Blue Team's flag. The Blue Team Spartan EOD grips the handlebars on his arctic Mongoose and pulls back on the throttle, jumping from High Base and taking aim with his Spiker to stop Red Team and get Blue Team's flag back!

### Versus: Base alta Snowbound

¡Elige tu lado y recrea los enfrentamientos árticos mientras el equipo azul y rojo compiten por controlar la base de altura Snowbound! Las botas del EVA Spartan crujen en la fresca nieve a medida que se toma un descanso con la bandera del equipo azul. El Spartan EOD del equipo azul coge el manubrio en su Mangosta ártica y jala el acelerador saltando de la base de altura y apuntando con su Spiker para detener al EVA rojo y recuperar la bandera del equipo azul.

### Versus : Base surélevée de Blizzard

Choisissez votre allégeance et recréez les grands combats arctiques au cours desquels les équipes rouge et bleue s'affrontent pour contrôler la base surélevée de Snowbound! Les bottes du Spartan EVA rouge creusent dans la neige alors qu'ils s'élancent vers le drapeau de l'équipe bleue. Le Spartan EOD bleu saisit les commandes de son Mongoose arctique et file à pleine vitesse de la base surélevée, armé de son Spiker pour arrêter le Spartan EVA rouge et récupérer le drapeau de l'équipe bleue!

### Gegen: Eingeschneite Highbase

Wähle Deine Seite und stelle arktische Showdowns nach, während das Rote und Blaue Team sich ein Rennen über die Kontrolle der Snowbound Hohen Basis liefern! Die Stiefel des Roten EVA Spartan knirschen im frischen Schnee, während er für die Flagge des Blauen Teams abgesetzt wird. Der Blaue EOD Spartan greift die Griffe seiner arktischen Mongoose und zieht den Gashebel zurück, springt von der Hohen Basis und richtet seinen Spiker aus, um den Roten EVA zu stoppen und die Flagge des Blauen Teams zurückzuholen!

### Tegen: Snowbound-basis Hoog

Bepaal aan welke kant je staat en speel confrontaties na in het poolgebied, waar het rode en blauwe team strijden om de leiding over de Snowbound-basis! De laarzen van de EVA-Spartan knerpen in het verse pak sneeuw als hij probeert te ontsnappen met de vlag van het blauwe team. De blauwe EOD-Spartan grijpt het stuur van zijn arctische Mongoose vast, geeft gas, springt weg van het basiskamp en legt zijn Spiker aan om de rode EVA tegen te houden en de vlag van het blauwe team te heroveren!

### Contro: Highbase Snowbound

Scegli da che parte stare e ricrea gli scontri artici tra la Squadra Rossa e Blu per il controllo della High Base Snowbound! Gli stivali dello Spartan EVA Rosso affondano nella neve fresca mentre tenta la fuga con la bandiera della Squadra Blu. Lo Spartan EOD Blu impugna i manubri del suo Mongoose artico e accelera a tutta velocità, saltando dalla High Base e prendendo la mira con il suo Spiker per fermare l'EVA Rosso e riprendersi la bandiera della Squadra Blu!

### Contra: Base Elevada Snowbound

Escolha seu lado e recrie cenários do ártico enquanto as Equipes Vermelha e Azul correm pelo controle da Alta Base Snowbound! As botas EVA Spartan Vermelhas esmagam a neve recém amontoada enquanto tentam tomar a bandeira da Equipe Azul. O EOD Spartan Azul agarra o leme deste Mongoose ártico e pisa no acelerador, pulando da Alta Base e mirando com seu Spiker para impedir a EVA Vermelha e conseguir de volta a bandeira da Equipe Azul!

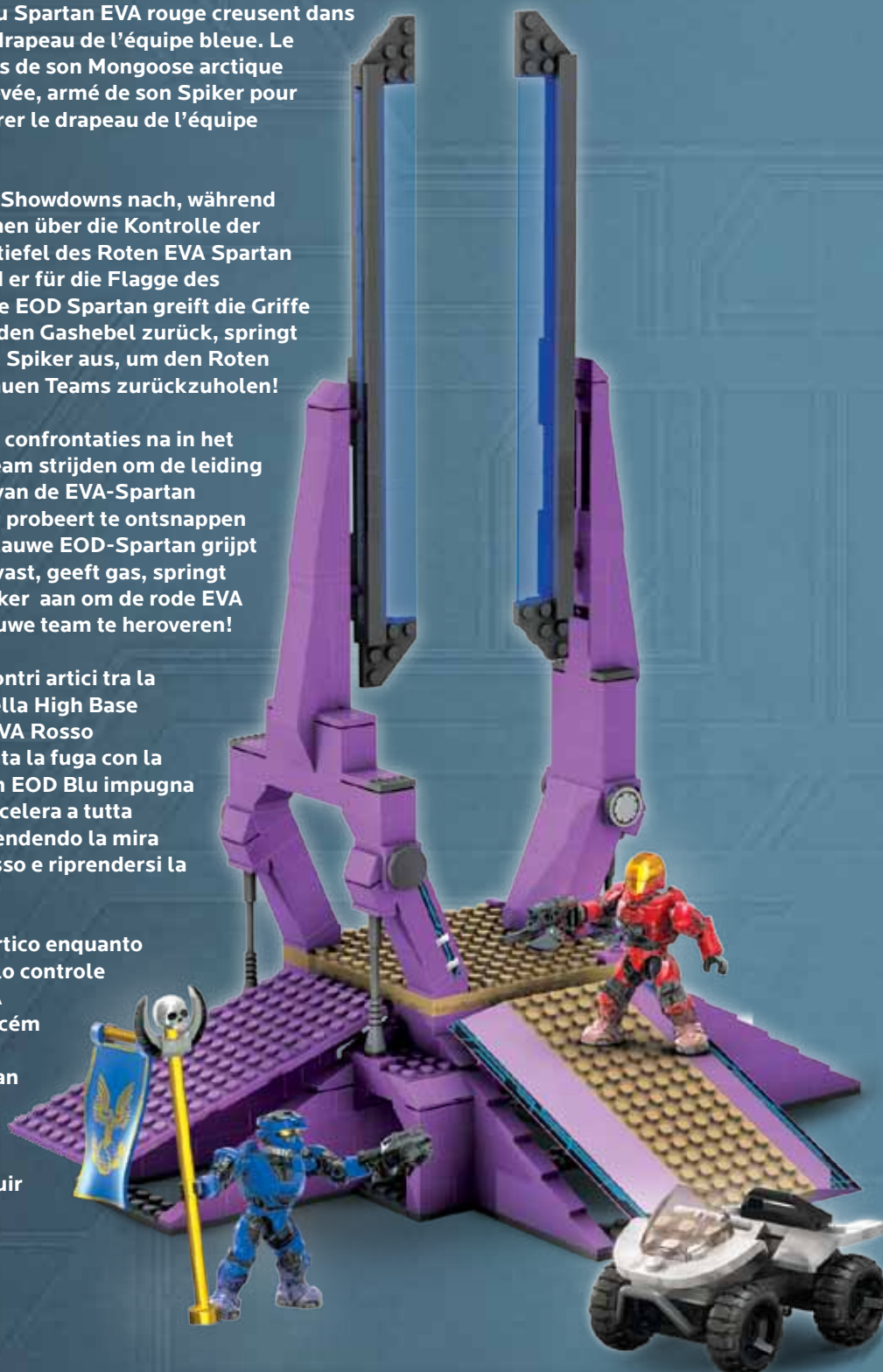



**MEGA  
BLOKS**

# HALO

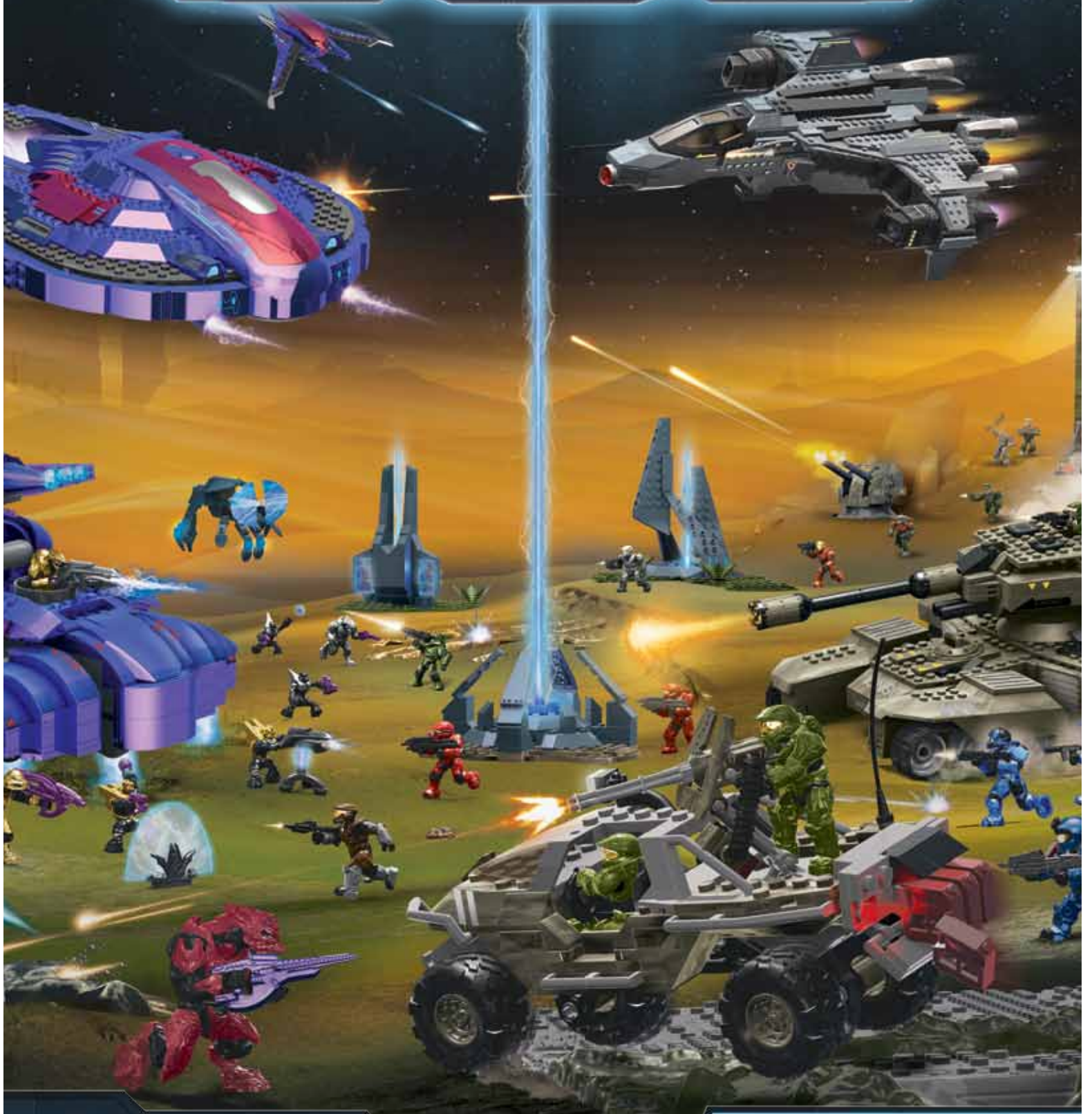

**Register for the Halo Bloks Brigade!**  
**Apuntate a la brigada Halo Bloks!**  
**Enrolez-vous dans la Brigade Halo Bloks!**  
Registriere dich fur die Halo-Bloks Brigade! • Schrijf je in voor de Halo Bloks Brigade!  
Effetua la registrazione per la Brigata dei Blok Halo! • Regista-te para a Brigada Halo Bloks!

[halo.megabloks.com](http://halo.megabloks.com)

**1X**  
AM07223AKQ

**1X**  
MA03328AKQ

**4X**  
MA03328MM

**4X**  
MAI140MM

**1X**  
MAI5258AKQ

**2X**  
MAI5258SX

**18X**  
MAI0865X

**1X**  
AMI8630AKQ

**2X**  
AMI66825X

**2X**  
MA02250IMM

**8X**  
MA09198MM

**3X**  
MA075905X

**2X**  
MA093935X

**4X**  
MA09393MM

**2X**  
MA09393AKQ

**1X**  
MA09393F

**5X**  
MA044305X

**1X**  
MA04430F

**3X**  
MA04429AKQ

**16X**  
MA04429SX

**2X**  
MAI322AKQ

**3X**  
MAI14175X

**1X**  
AMI7065F

**1X**  
AMI7064F

**4X**  
AM027995X

**27X**  
MA090135X

**2X**  
AMI75025X

**3X**  
AMI82725X

**7X**  
MA030195X

**4X**  
MAI5484MM

**4X**  
AM02215MM

**5X**  
MA09485X

**7X**  
MA037735X

**1X**  
MA03773MM

**6X**  
MAI83295X

**6X**  
MAI83285X

**6X**  
MAI02735X

**12X**  
MA090235X

**5X**  
MAI1545X

**4X**  
MAI1415X

**2X**  
AMI54885X

**2X**  
MAI3145X

**1X**  
MAI314AKQ

**2X**  
MAI314F

**31X**  
MAI3235X

**1X**  
MA03772AKQ

**2X**  
MA037725X

**8X**  
MA038735X

**6X**  
MA09593MM

**1X**  
MA095935X

**2X**  
AM09593KK

**41X**  
MAI0875X

**5X**  
MA094935X

**8X**  
AM09493KK

**8X**  
MA090335X

**4X**  
AMI8279MM

**1X**  
AMI8663AKQ

**1X**  
AMI8662AKQ

**1X**  
AMI7116AKQ

**1X**  
AMI7116F

**1X**  
MA07475AKQ

**1X**  
MA07475MM

**4X**  
MA092925X

**12X**  
MA09292MM

**4X**  
AM09292KK

**8X**  
AMI6331MM

**1X**  
MAI3135X

**1X**  
AS9696505

**1X**  
AS9696702

**8X**  
MAI3465X

**1X**  
AMI7063AKQ

**1X**  
AMI8664AKQ

**8X**  
AM72333HJ

**6X**  
MAI4805X

**1X**  
MAI480MM

**1X**  
AM049845X

**2X**  
MA08483MM

**4X**  
MA09923MM

**2X**  
MAI172MM

**4X**  
MAI1725X

**1X**  
AMI90365X

**2X**  
AMI7668KK

**1X**  
AMI85675X



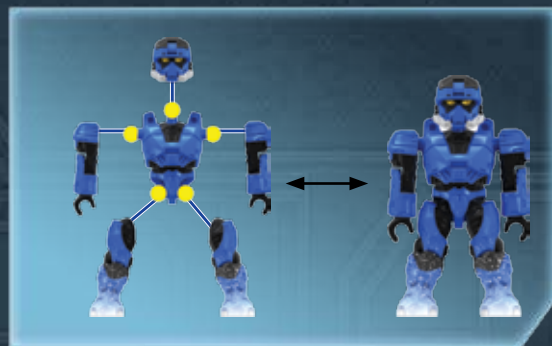
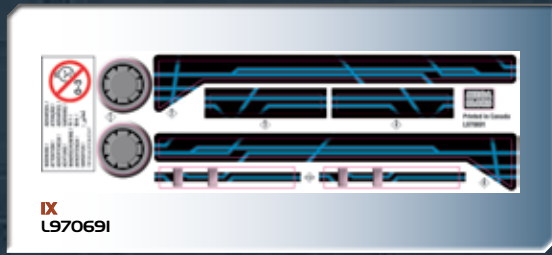
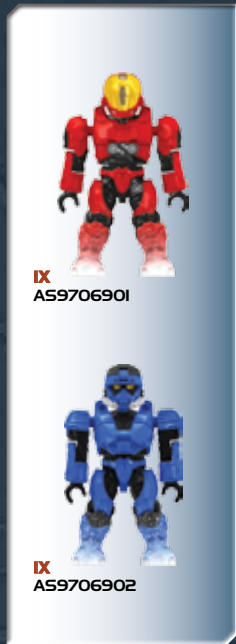
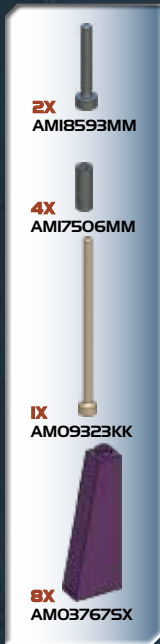

**EN** Please read these instructions carefully before first use and keep them for future reference.  
**ES** Leer estas instrucciones cuidadosamente antes de la primera utilización y guardarlas para referencia futura.  
**FR** Il est recommandé de lire attentivement ce feuillet avant la première utilisation et de le conserver pour référence future.  
**DE** Die Gebrauchsanleitung bitte durchlesen und aufbewahren.  
**NL** Wij raden u aan deze handleiding zorgvuldig te lezen en te bewaren voor eventuele raadpleging op een later tijdstip.  
**DA** Vær venlig at læse disse instruktioner omhyggeligt inden ibrugtagen og opbevar dem til fremtidigt brug.  
**EL** Διαβάστε αυτές τις οδηγίες προσεκτικά πριν χρησιμοποιήσετε το προϊόν για πρώτη φορά και φυλάξτε τις για μελλοντική αναφορά.  
**FI** Lue nämä ohjeet huolellisesti ennen ensimmäistä käyttöä ja säilytä ne myöhempää tarvetta varten.  
**IT** Leggere le istruzioni prima di cominciare ad usare il gioco e conservarle per referenze future.  
**NO** Les disse instruksjonene nøye før første gangs bruk, og ta vare på dem for fremtidige oppslag.  
**PT** Leia as instruções antes do primeiro uso e guarde-as para futura referência.  
**SV** Läs noggrant igenom dessa instruktioner innan du använder produkten för första gången och spara dem för ev. framtida frågor.  
**JA** 初めてご使用になる前に、この説明書をよくお読みください。また、本書は将来いつでも参照できるように保管してください。  
**ZH** 请在初次使用前仔细阅读这些指示，并保留它们以便未来参考。  
**AR** يرجى قراءة هذه التعليمات بدقة قبل البدء بالاستعمال والاحتفاظ بها كمرجع للمستقبل



**EN** ⚠ **WARNING :**  
**CHOKING HAZARD.** - Small parts.  
 Not for children under 3 years.

**ES** ⚠ **ADVERTENCIA :**  
**RIESGO DE ASFIXIA.** - Contiene piezas pequeñas.  
 No recomendado para niños menores de 3 años.

**FR** ⚠ **ATTENTION :**  
**DANGER D'ÉTOUFFEMENT.** - Présence de petits éléments.  
 Ne convient pas aux enfants de moins de 3 ans.

**DE** ⚠ **WARNUNG :**  
**ERSTICKUNGSGEFAHR.** - Enthält kleine Teile.  
 Nicht für Kinder unter 3 Jahren geeignet.

**NL** ⚠ **WAARSCHUWING :**  
**VERSTIKKINGSGEVAAR.** - Bevat kleine onderdelen.  
 Niet geschikt voor kinderen onder de 3 jaar.

**DA** ⚠ **ADVARSEL :**  
**FARE FOR KVÆLNING.** - Indeholder smådele.  
 Ikke til børn under 3 år.

**EL** ⚠ **ΠΡΟΕΙΔΟΠΟΙΗΣΗ :**  
**ΚΙΝΔΥΝΟΣ ΠΝΙΓΜΟΥ.** - Περιέχει μικρά αντικείμενα.  
 Όχι για παιδιά κάτω των 3 ετών.

**FI** ⚠ **VAROITUS :**  
**TUKEHTUMISVAARA.** - Sisältää pieniä osia.  
 Ei alle 3-vuotiaille lapsille.

**IT** ⚠ **ATTENZIONE :**  
**PERICOLO DI SOFFOCAMENTO.** - Contiene piccole parti.  
 Non indicato per bambini sotto i 3 anni.

**NO** ⚠ **ADVARSEL :**  
**KVELNINGSFARE.** - Inneholder små deler.  
 Kun for barn over 3 år.

**PT** ⚠ **ATENÇÃO :**  
**PERIGO DE ASFIXIA.** - Contém peças pequenas.  
 Não é concebido para crianças de menos de 3 anos.

**SV** ⚠ **VARNING :**  
**KVÄVNINGSRISK.** - Innehåller små delar.  
 Inte för barn under 3 år.

**JA** ⚠ **警告 :**  
 のどにつまる危険。小さな部品が含まれています。  
 3歳以下の子供には与えないで下さい。

**ZH** ⚠ **警告 :**  
 噎住危險。包含有小部件。  
 不适合3岁以下的小孩玩。

**AR** ⚠ **تحذير :**  
 خطر الاختناق - قطع صغيرة.  
 غير صالحة للأطفال أقل من 3 سنوات.

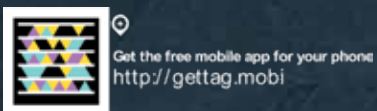

© 2012 MICROSOFT CORPORATION. ALL RIGHTS RESERVED.  
 MICROSOFT, 343 INDUSTRIES, THE 343 INDUSTRIES LOGO, HALO,  
 THE HALO LOGO, XBOX, XBOX 360, AND THE XBOX LOGOS, ARE  
 TRADEMARKS OF THE MICROSOFT GROUP OF COMPANIES.





1

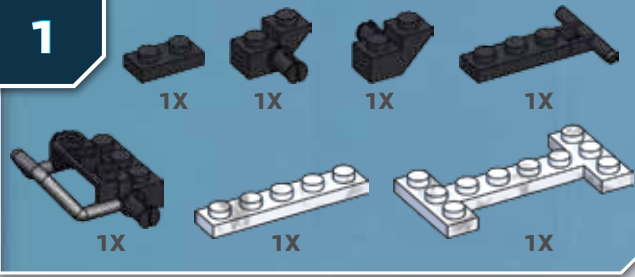

2

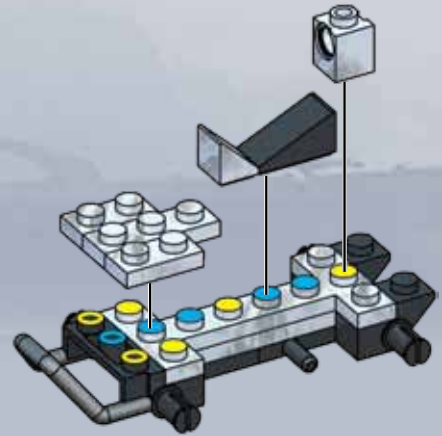
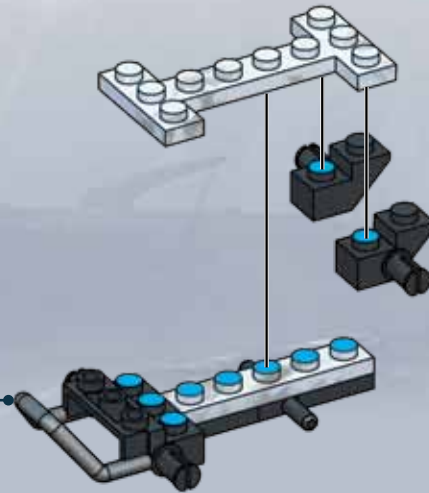
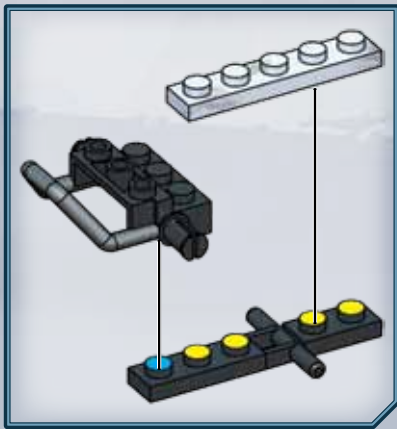

3

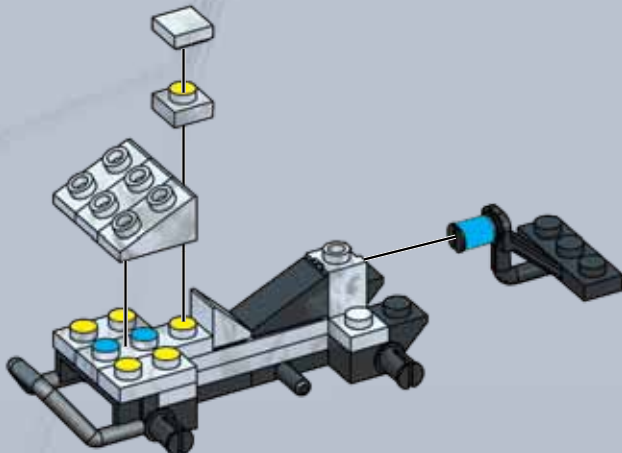

4

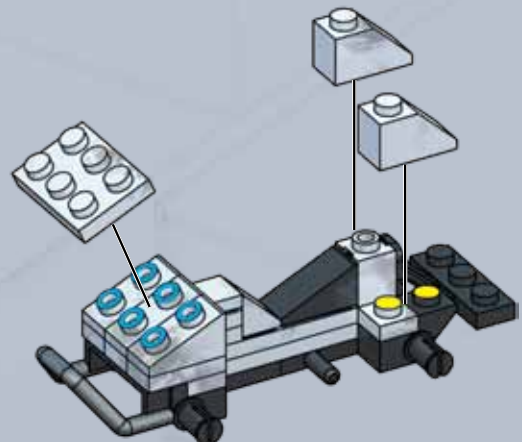

6



5

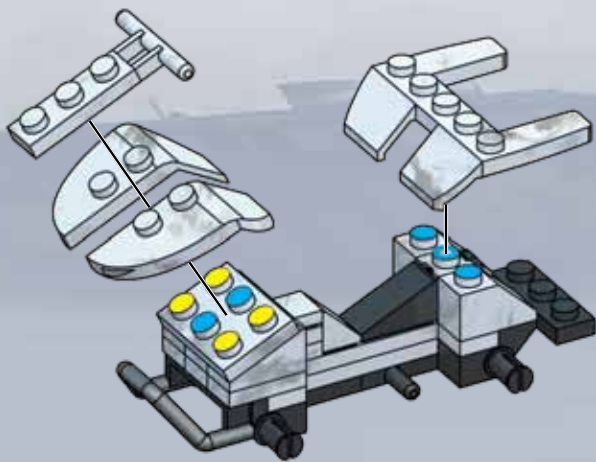
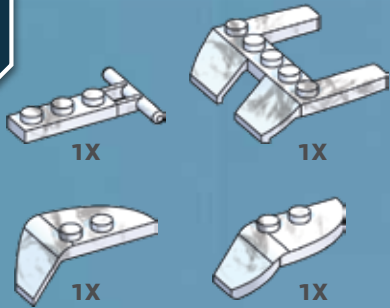

6

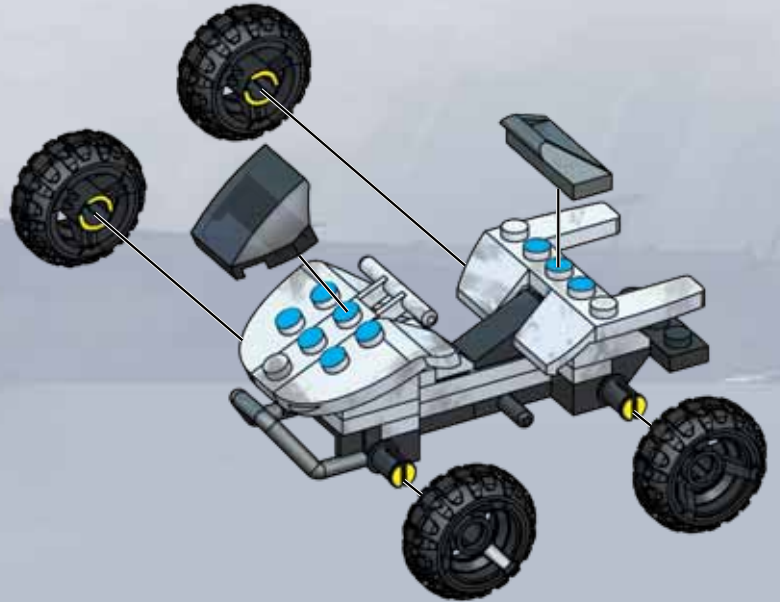

7

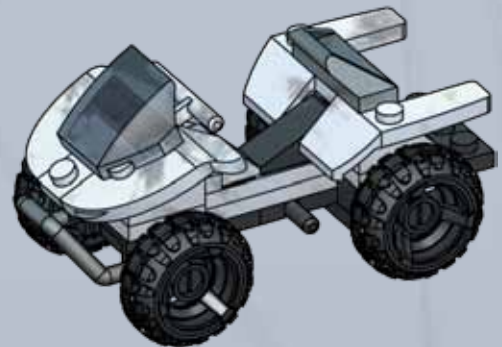
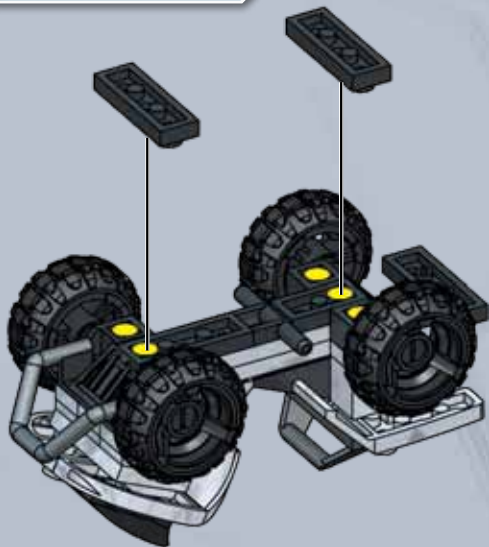

7



**1**

- 1X (grey 1x1 brick)
- 1X (purple 1x2 brick)
- 2X (purple 1x3 brick)
- 1X (grey 1x7 Technic beam)
- 1X (grey 1x8 Technic beam)
- 1X (grey 1x10 Technic beam)

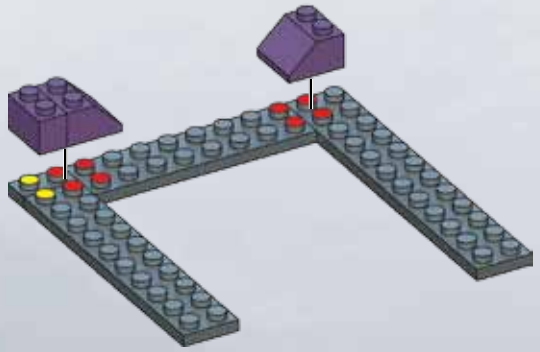

**2**

- 2X (purple 1x2 brick)
- 1X (purple 1x3 brick)
- 2X (purple 1x3 wedge)
- 5X (purple 1x5 Technic beam)
- 1X (grey 1x1 brick)
- 1X (grey 1x3 Technic beam)
- 3X (grey 1x3 Technic beam)
- 1X (grey 1x7 Technic beam)

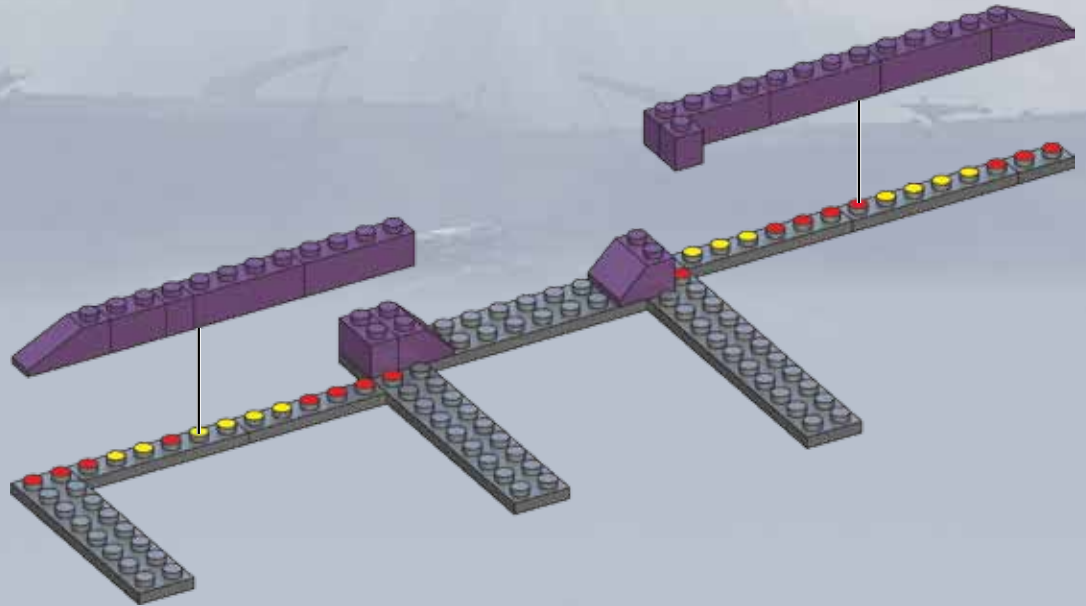

**3**

- 1X (purple 1x2 brick)
- 1X (grey 1x1 brick)
- 2X (grey 1x3 Technic beam)
- 3X (grey 1x3 Technic beam)
- 1X (purple 1x2 brick)
- 2X (purple 1x3 wedge)
- 5X (purple 1x5 Technic beam)
- 1X (grey 1x7 Technic beam)

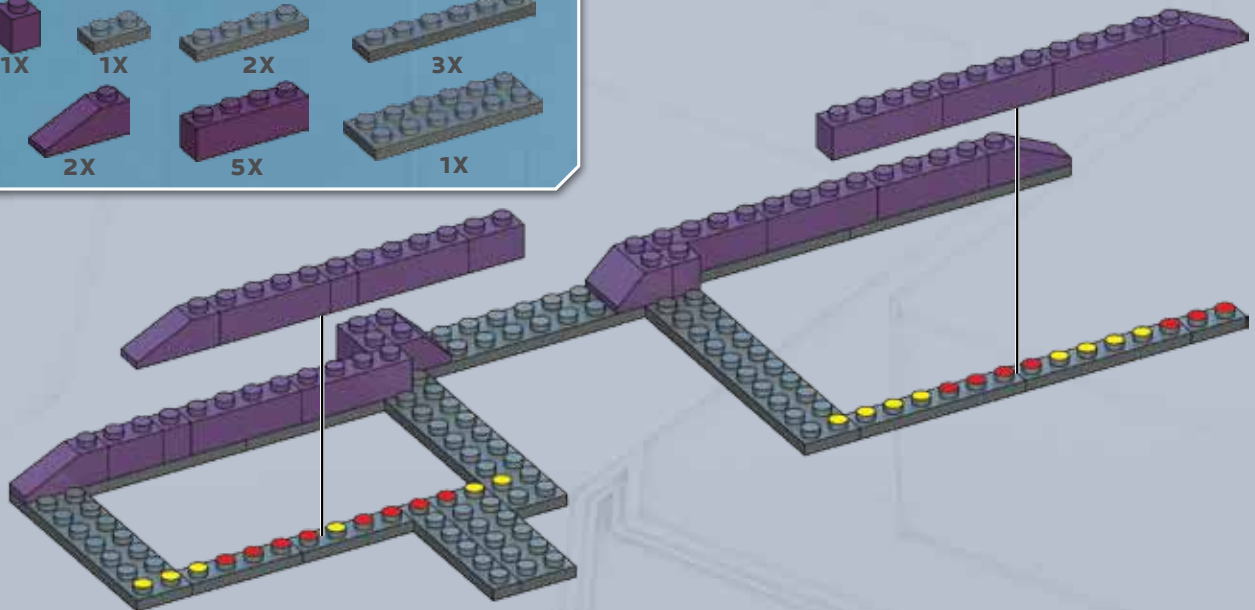



4

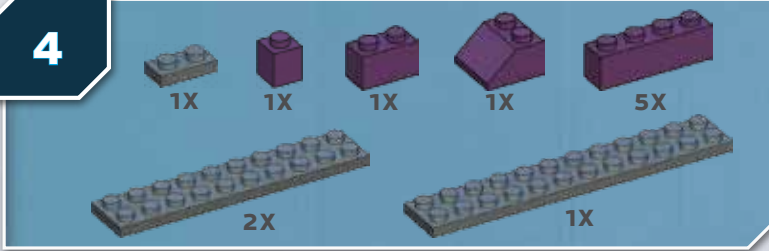

5

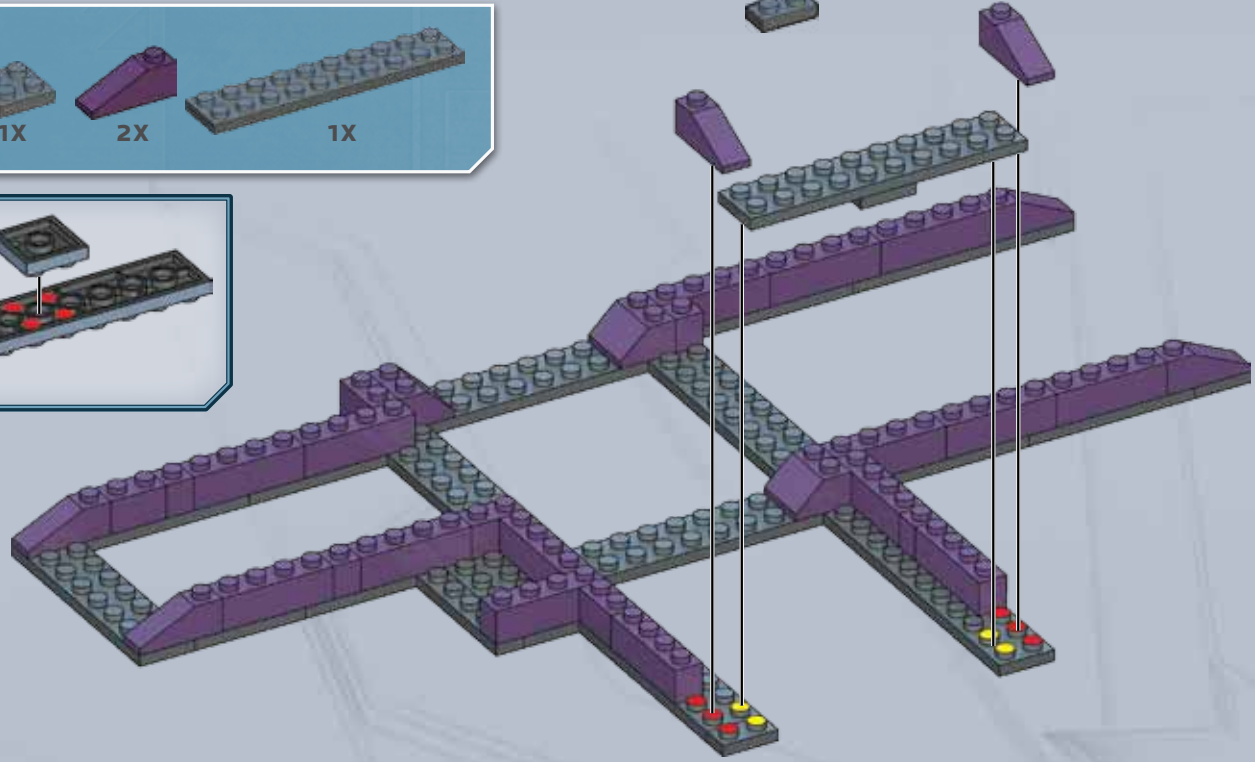
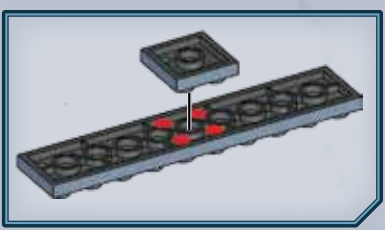

6



2X

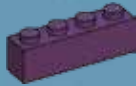

4X



2X



2X

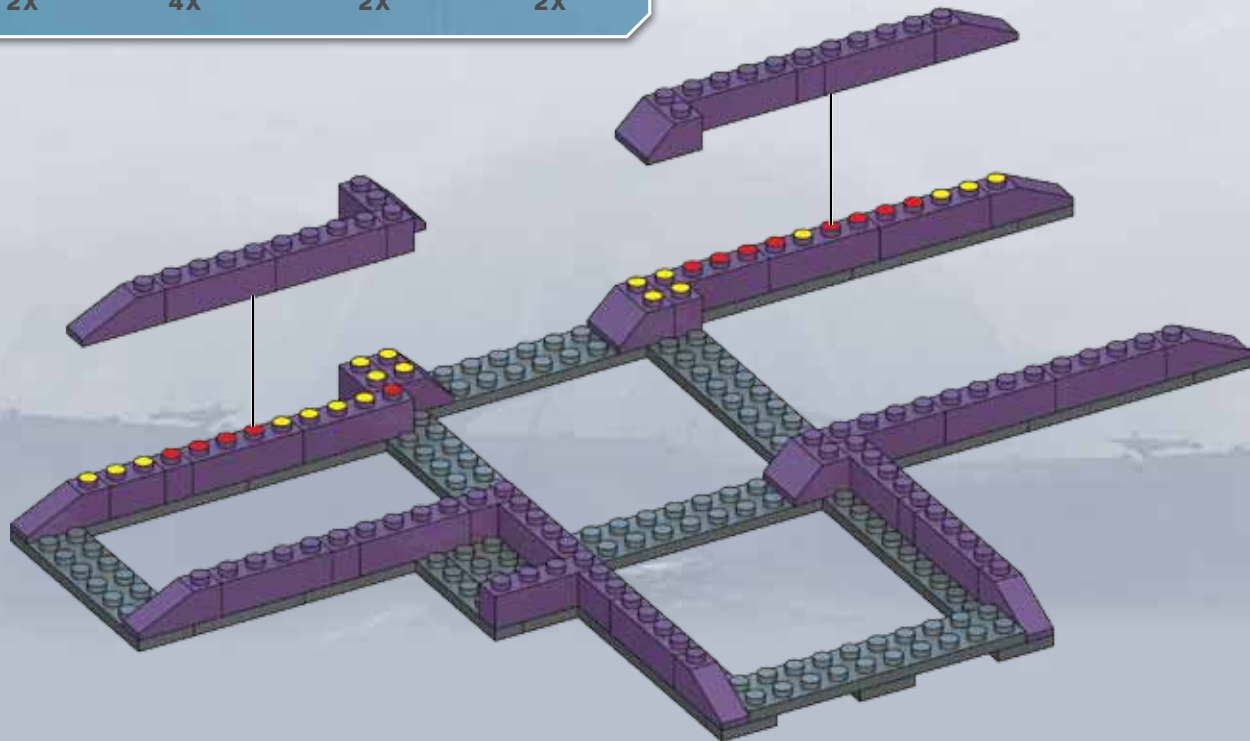

7



2X



4X



2X



1X

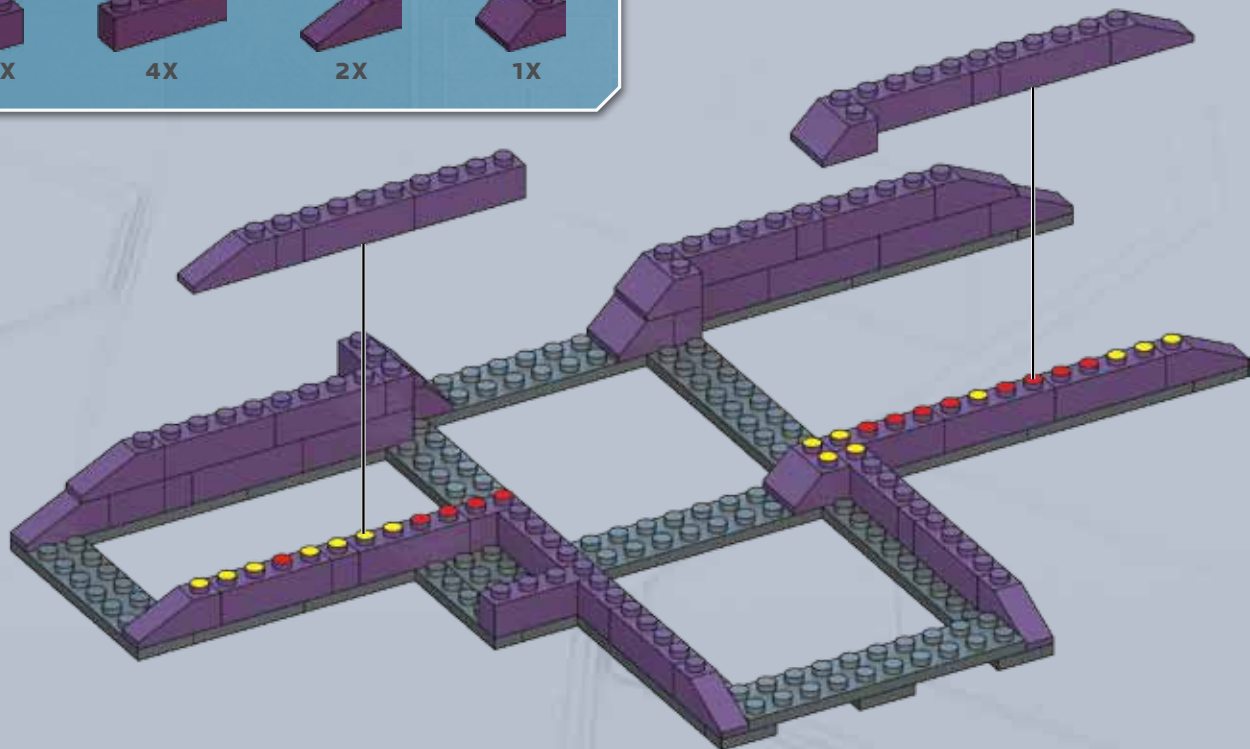



8



1X



3X



2X

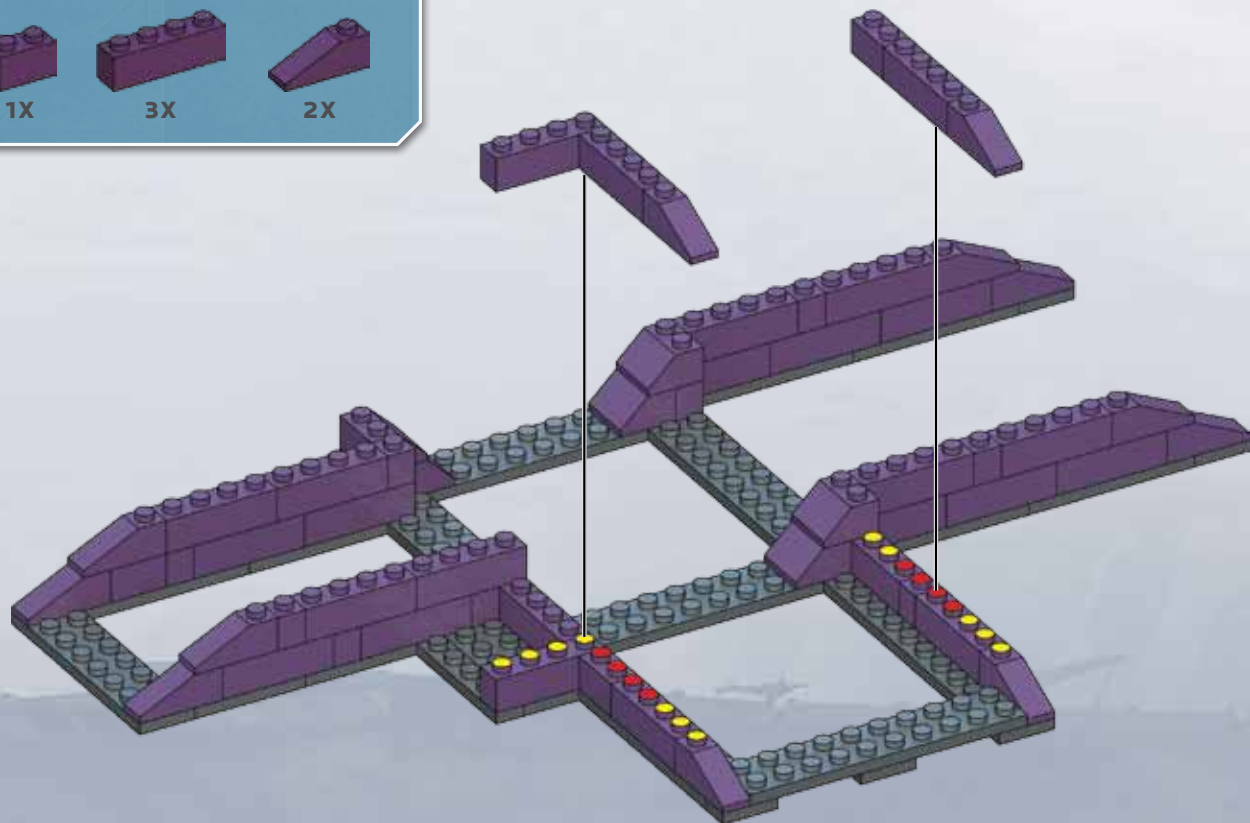

9



1X



2X



3X



6X



4X

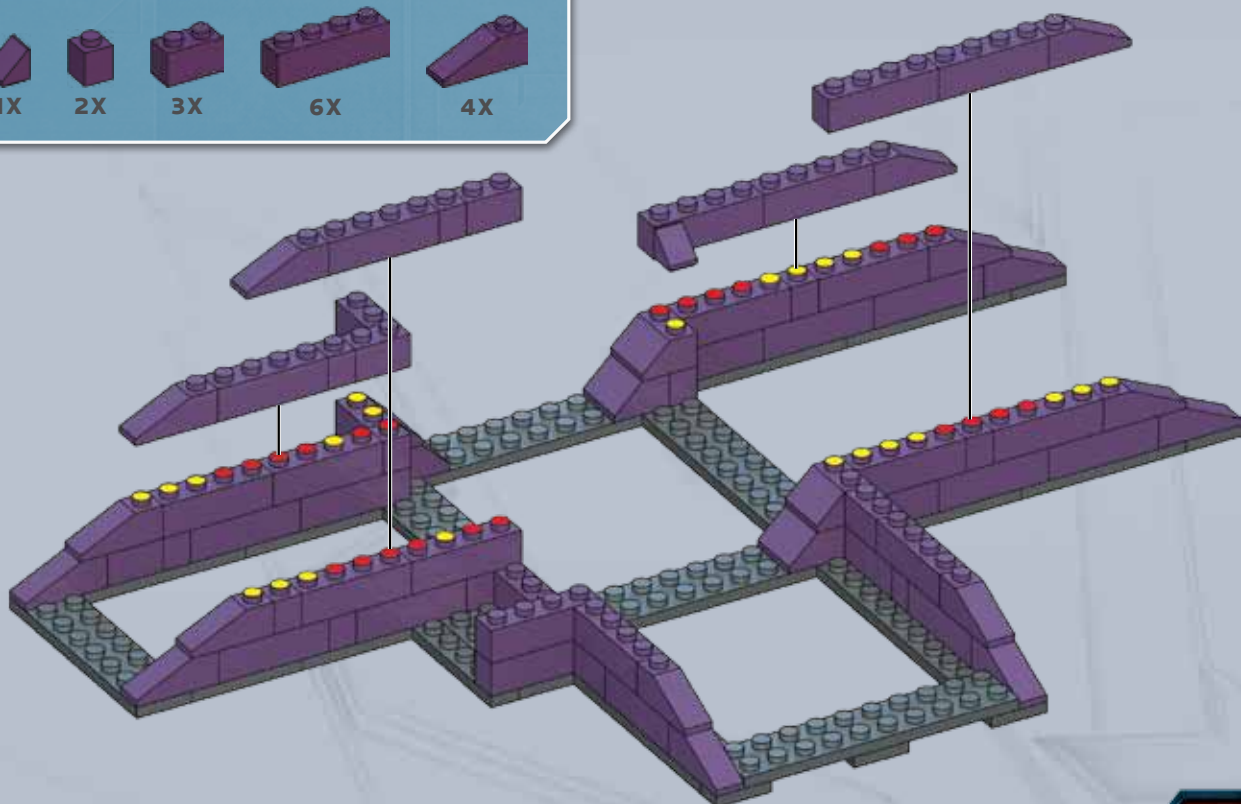





12

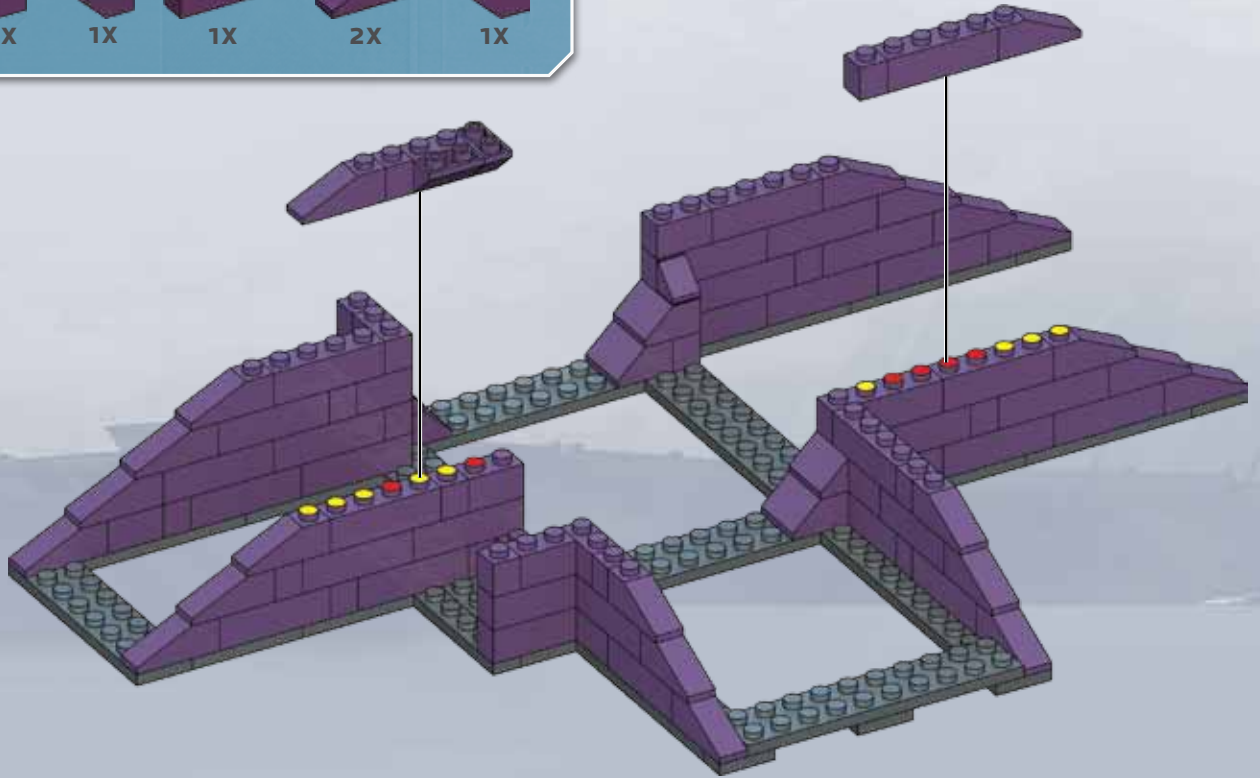

13

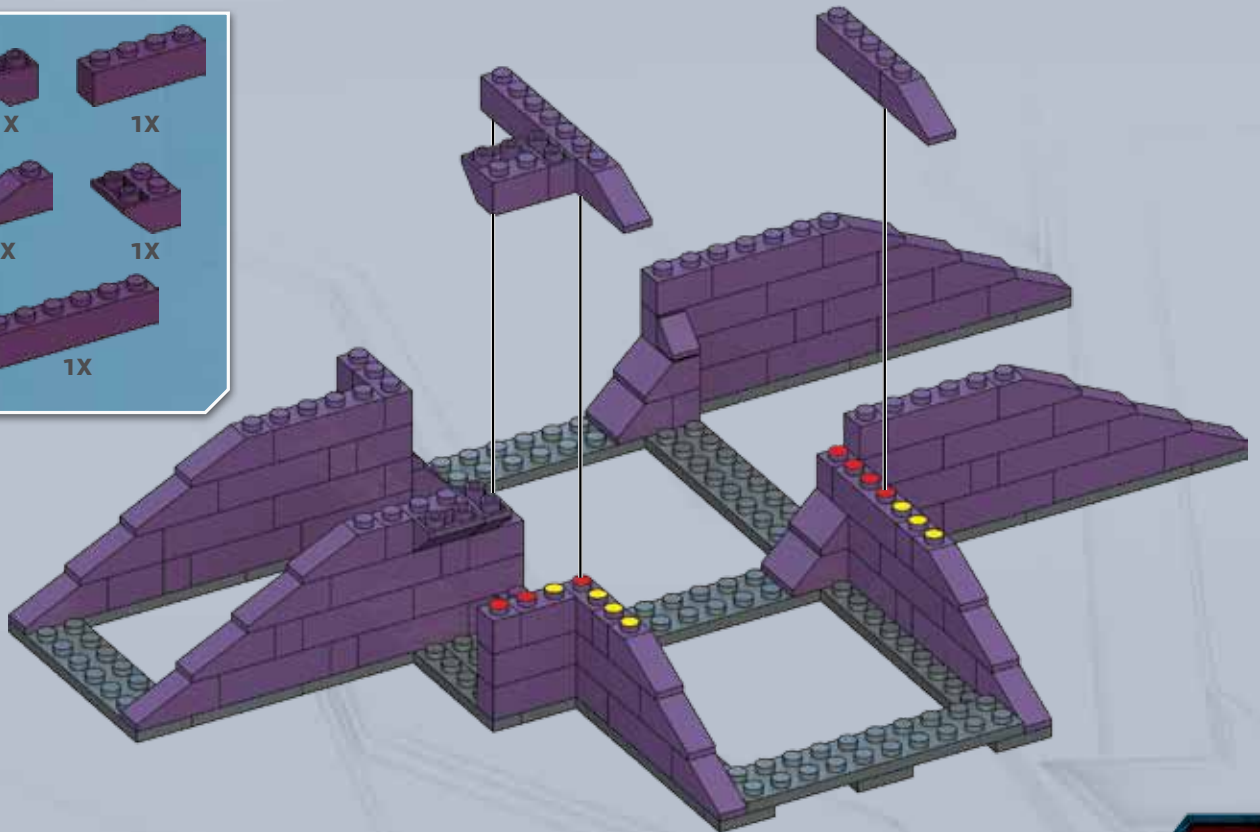
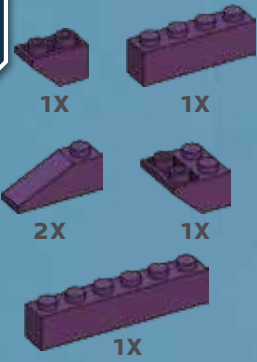





16

- 1X [1x 1x2 purple brick with 2 holes]
- 3X [3x 1x2 purple brick with 2 holes]
- 2X [2x 1x2 purple brick with 2 holes]
- 1X [1x 1x2 purple brick with 2 holes]



17

- 3X [3x 1x2 purple brick with 2 holes]
- 1X [1x 1x10 purple brick with 10 holes]

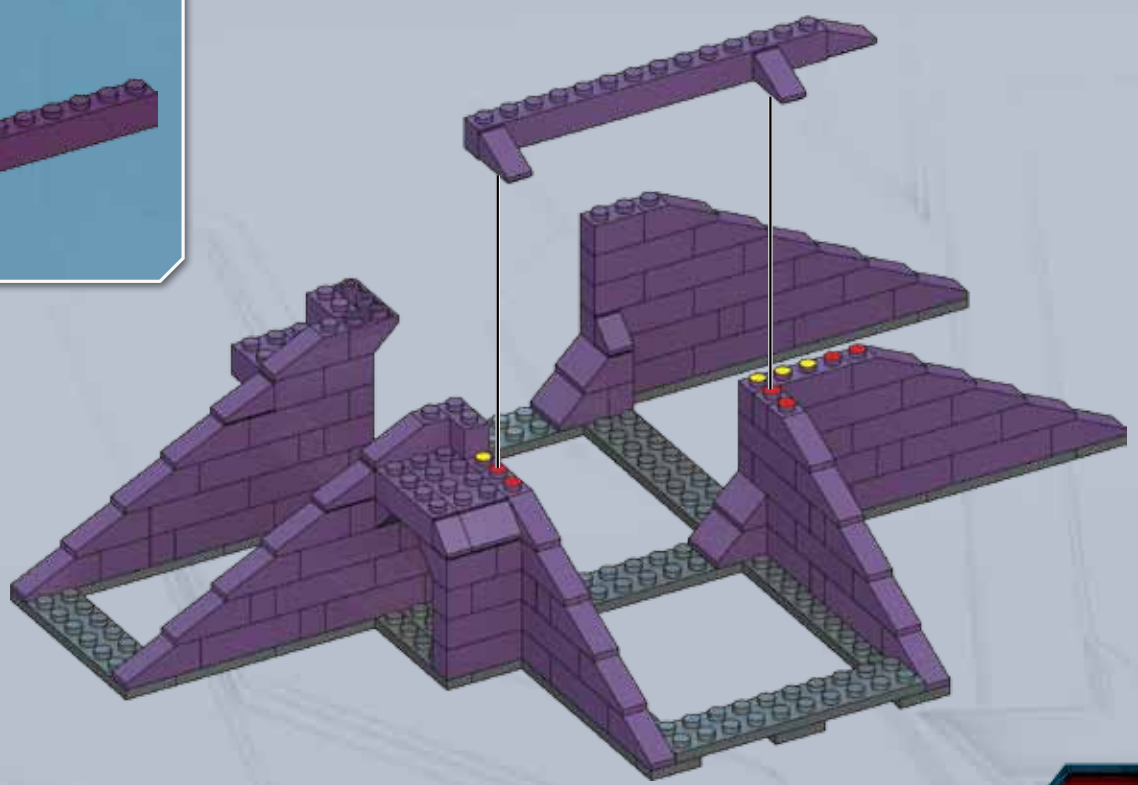

15

18

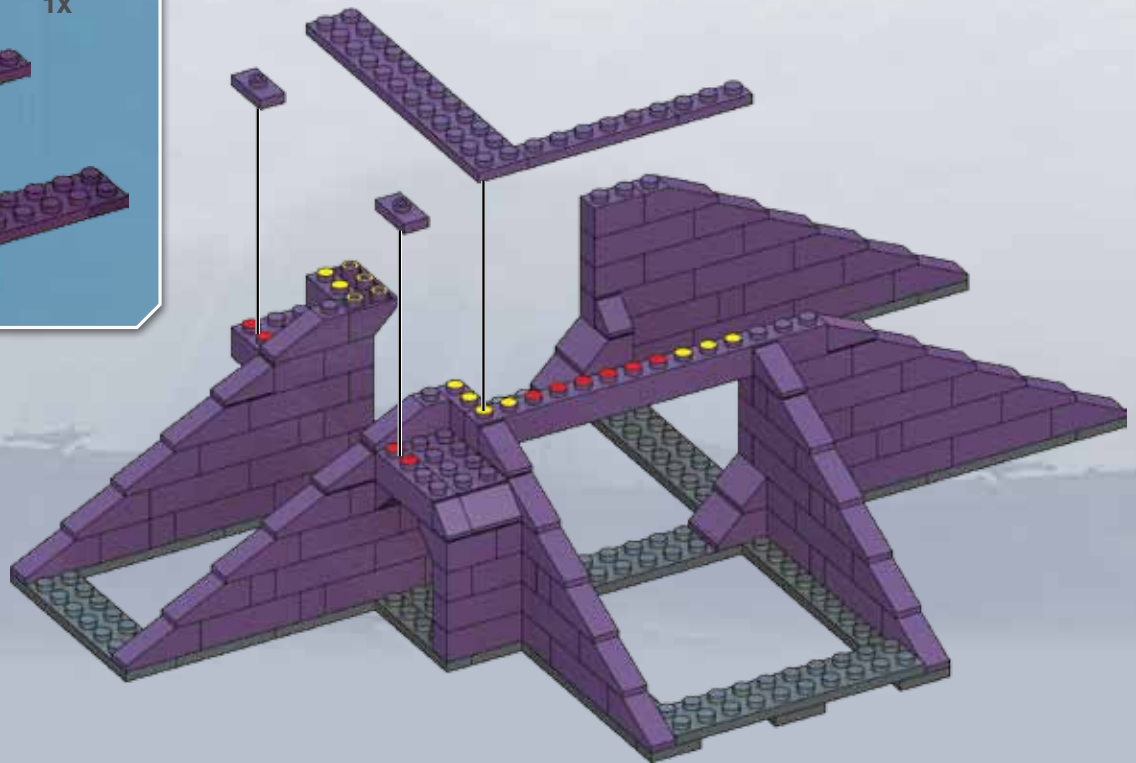
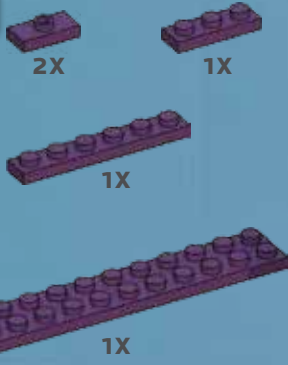

19

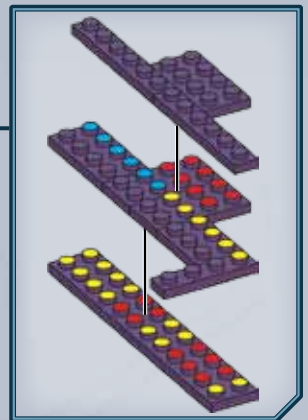
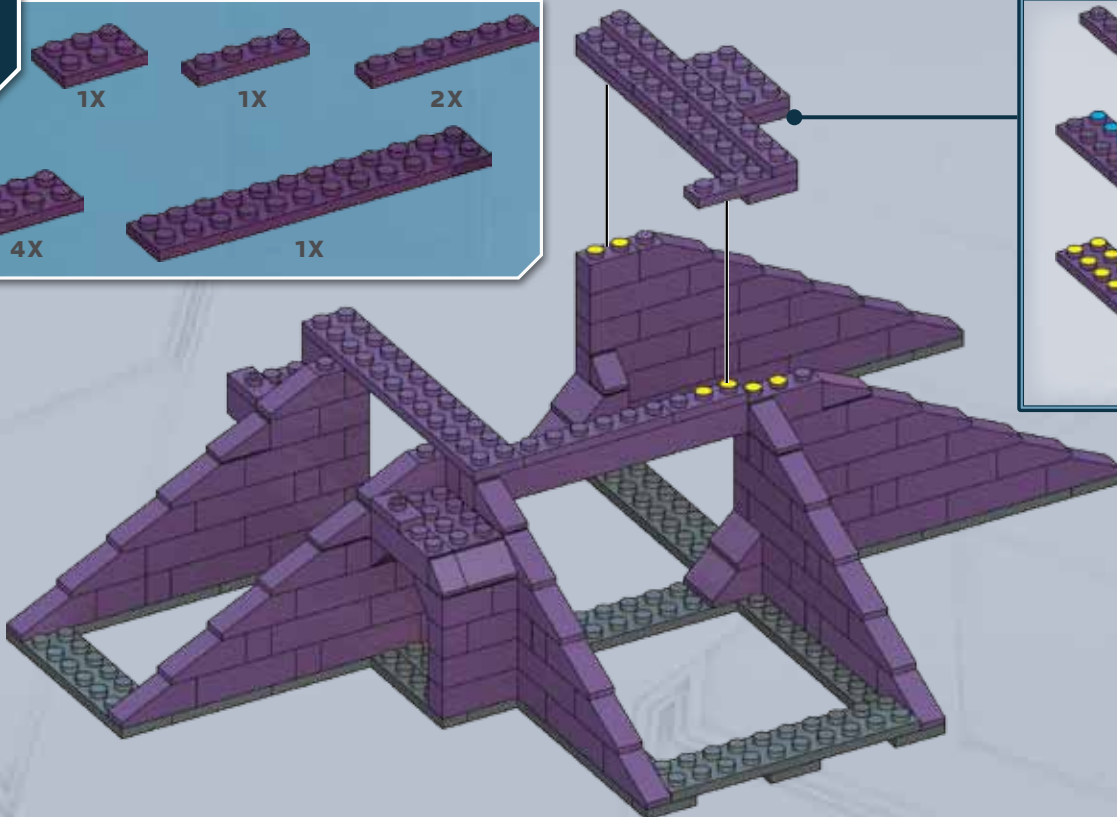
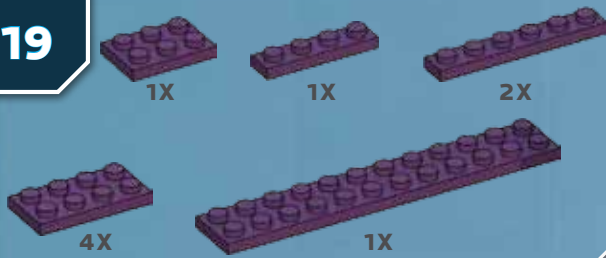



20



1X



3X

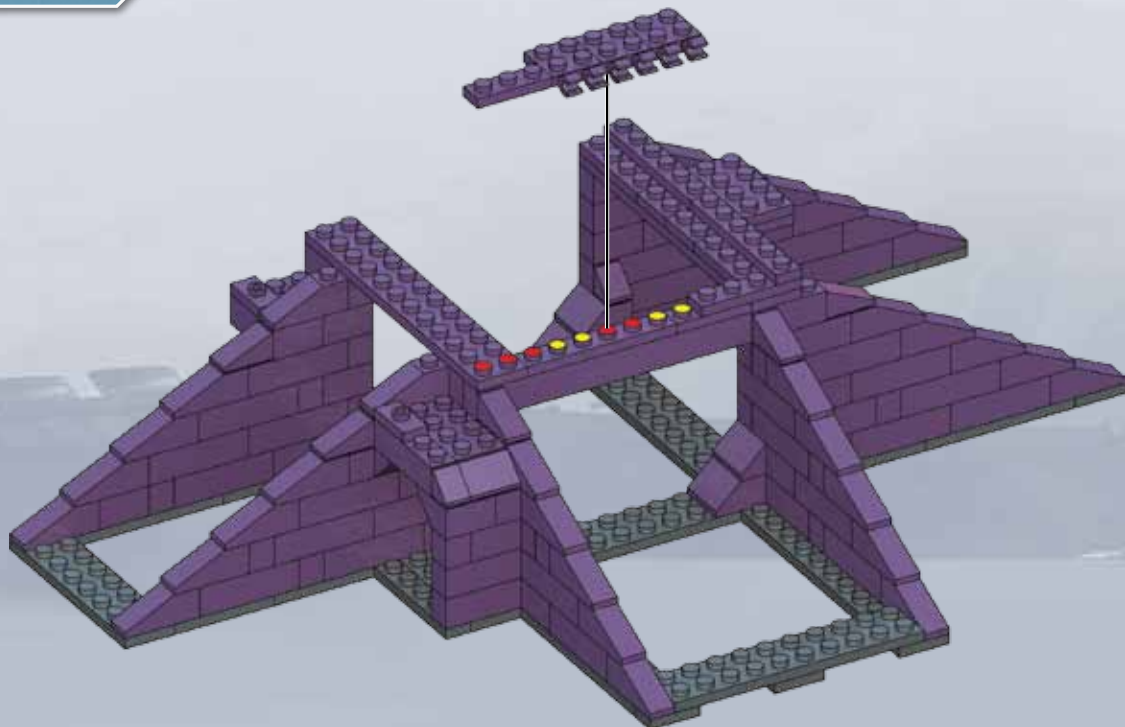

21



4X



1X



1X



1X



1X



3X

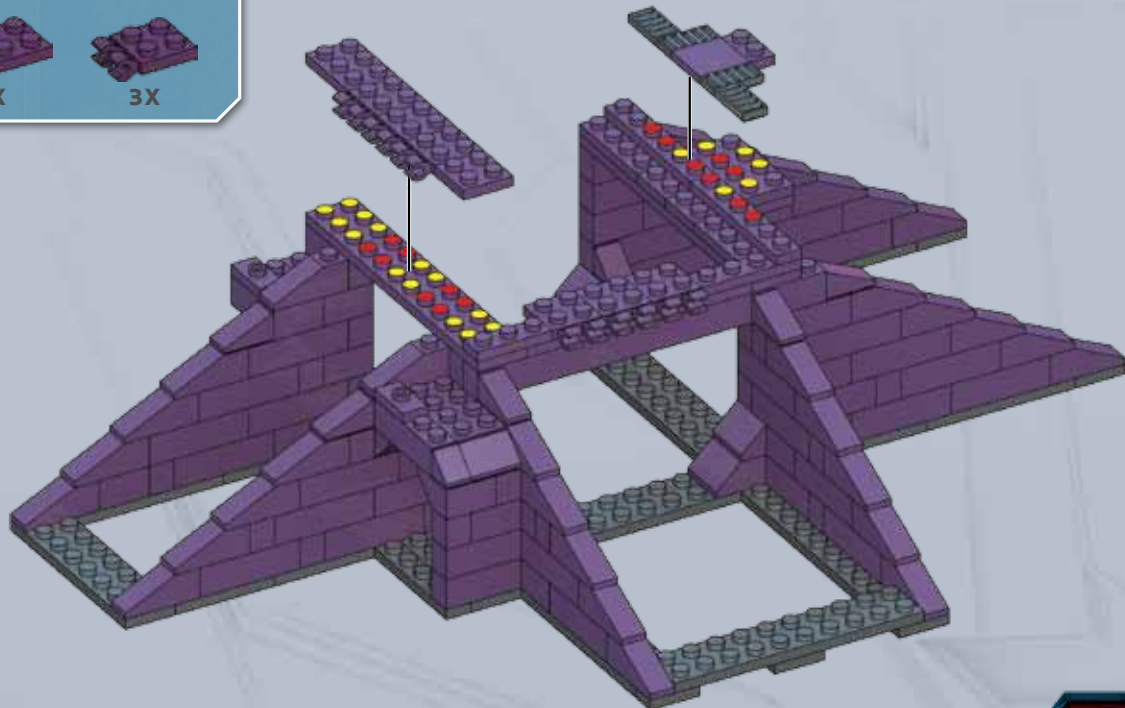

22

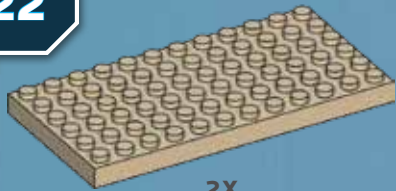

2X

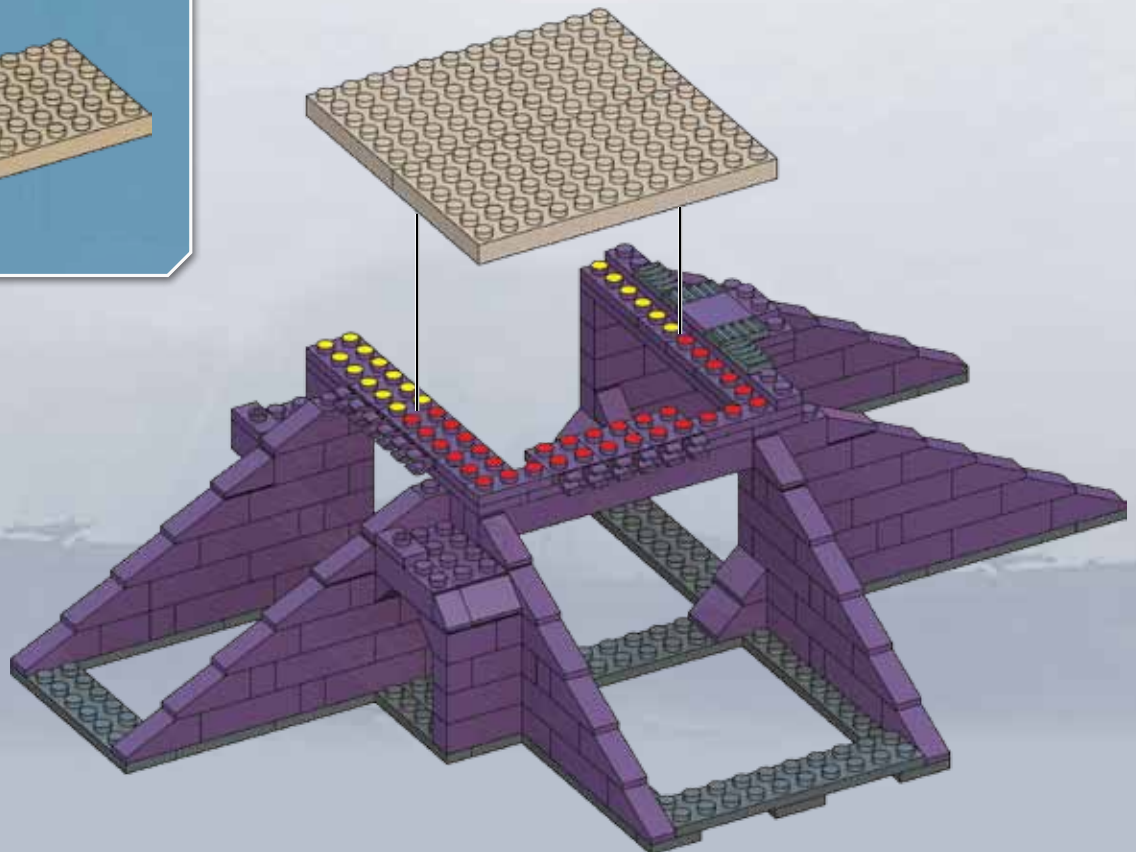

23



8X

2X

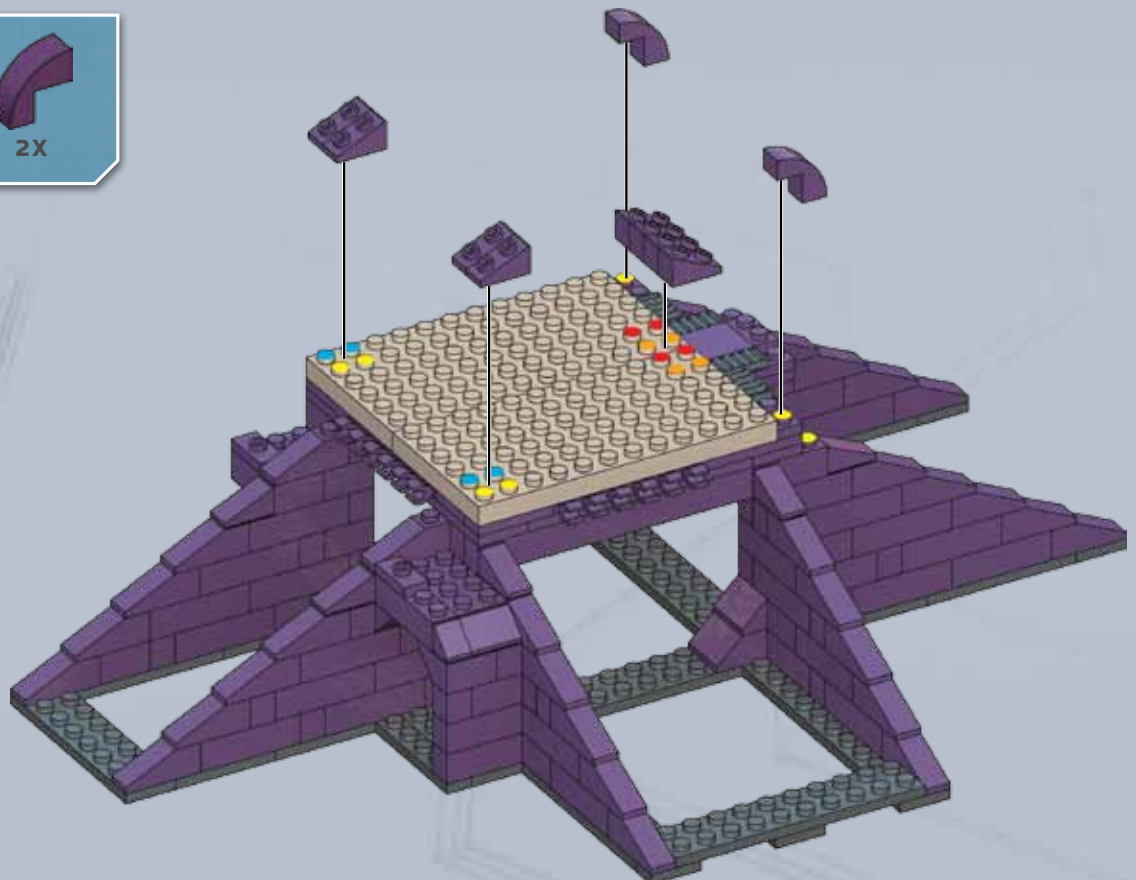



24



4X



2X



2X

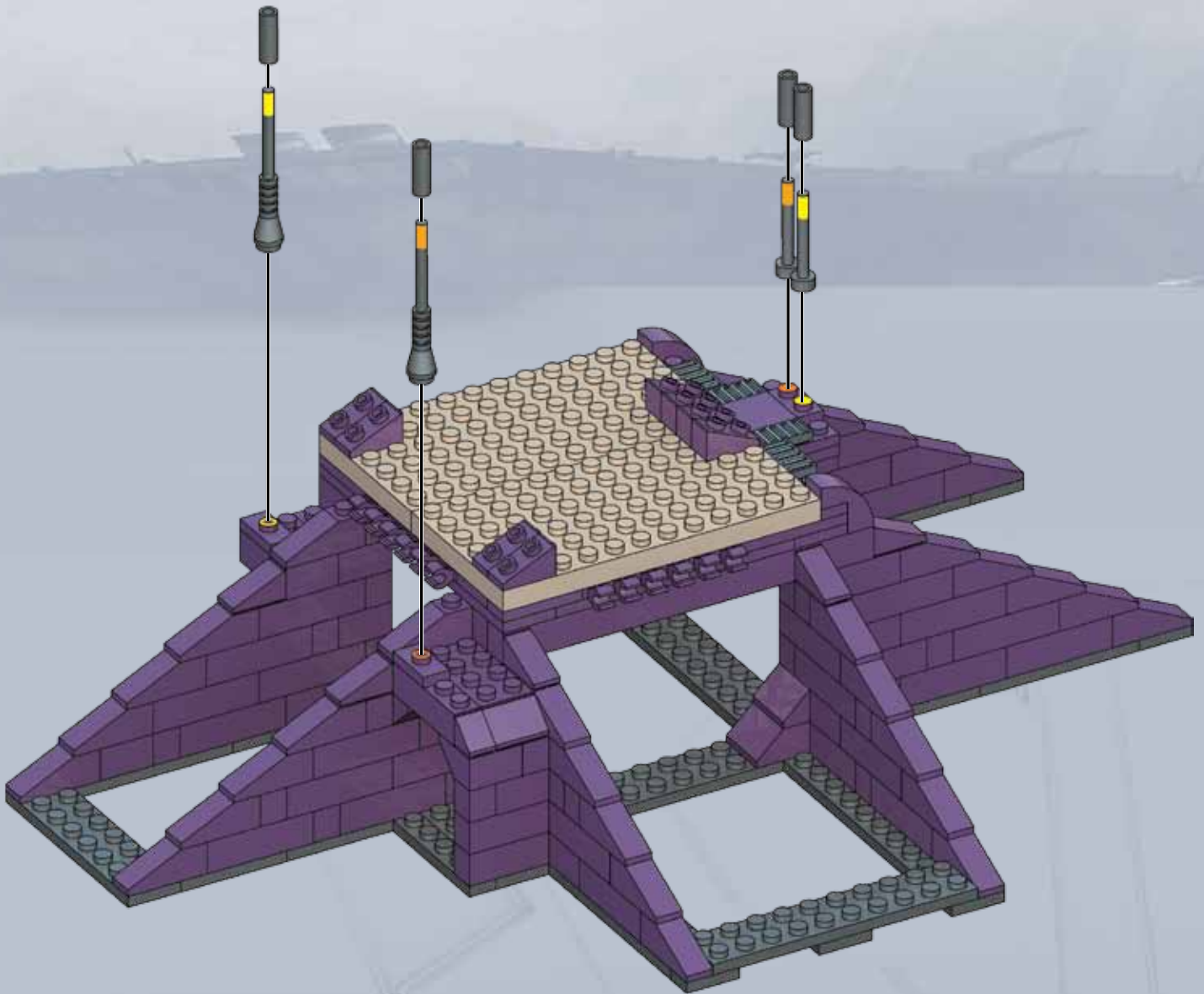

25



2X



2X



4X



2X

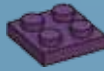

2X



8X



2X



2X

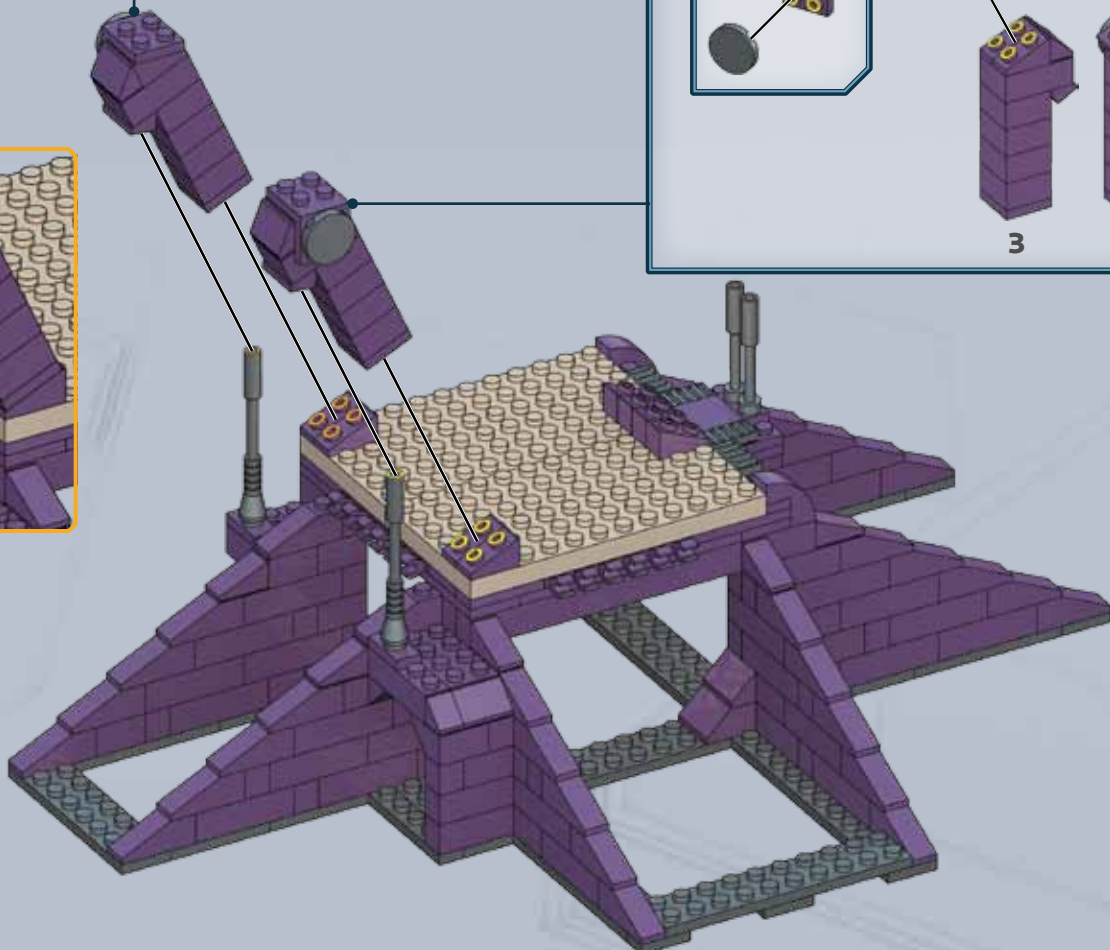
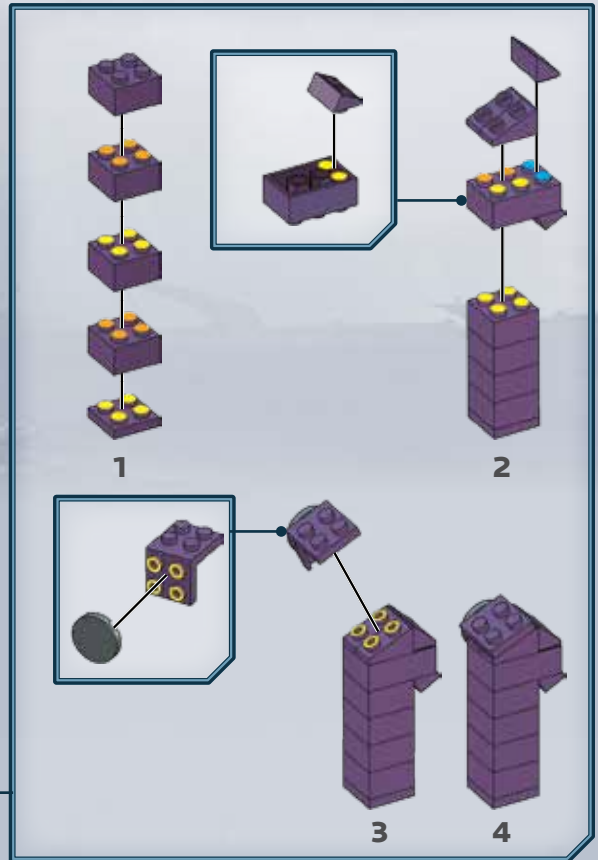
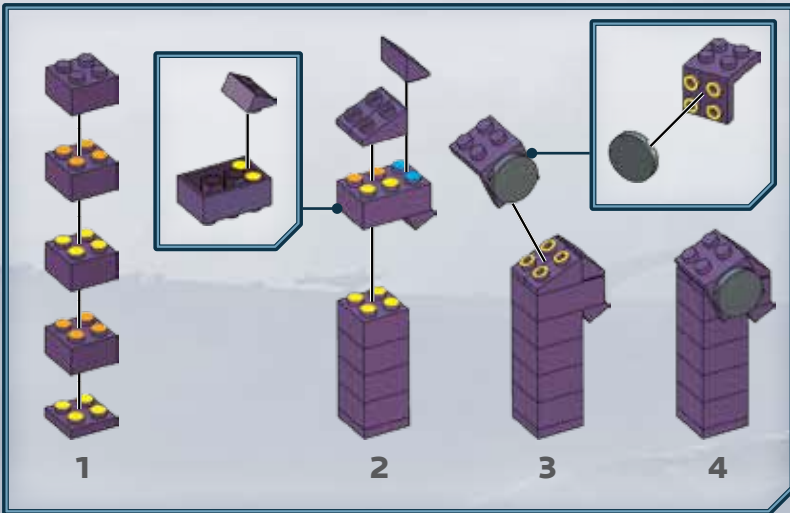



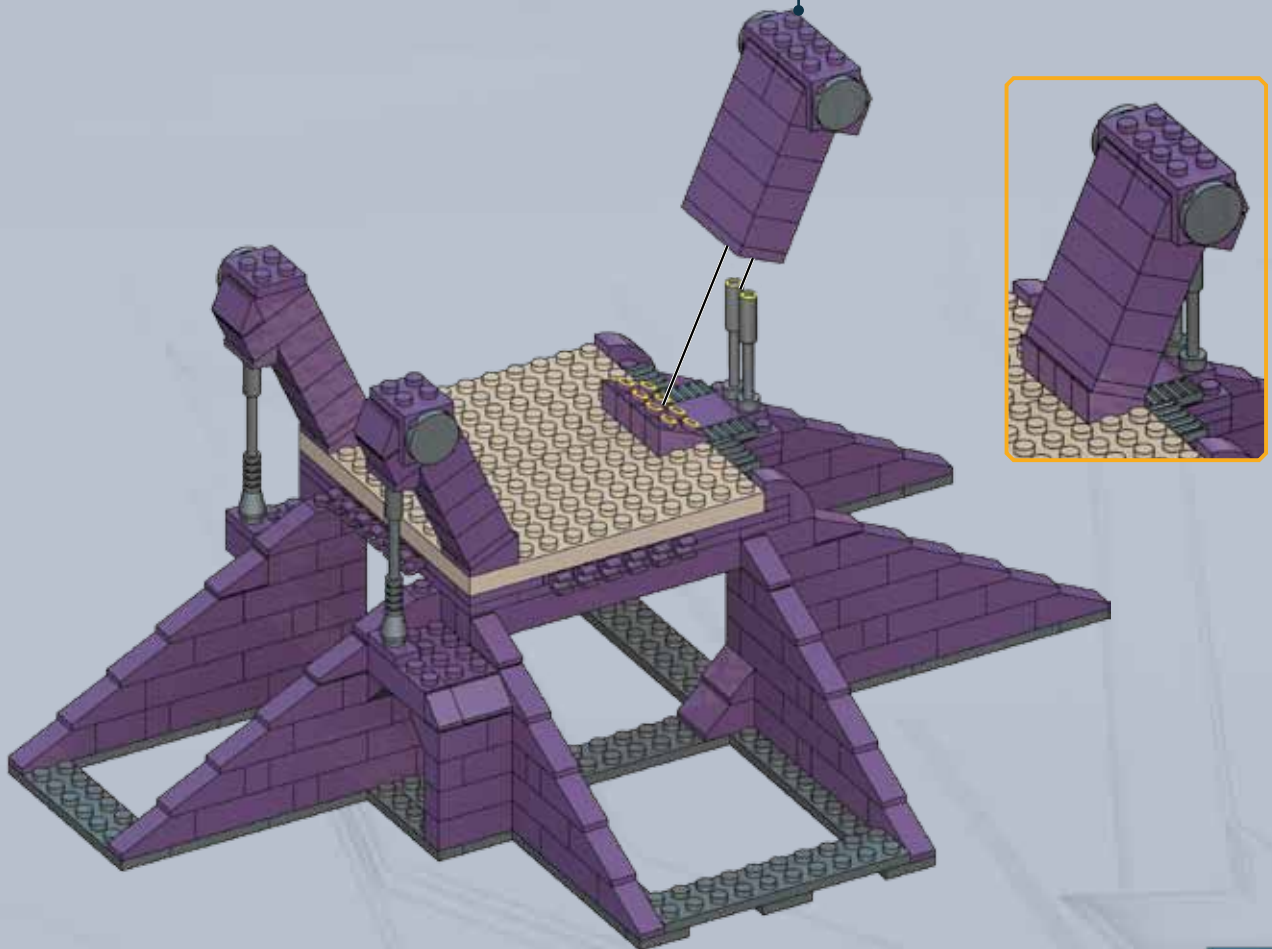
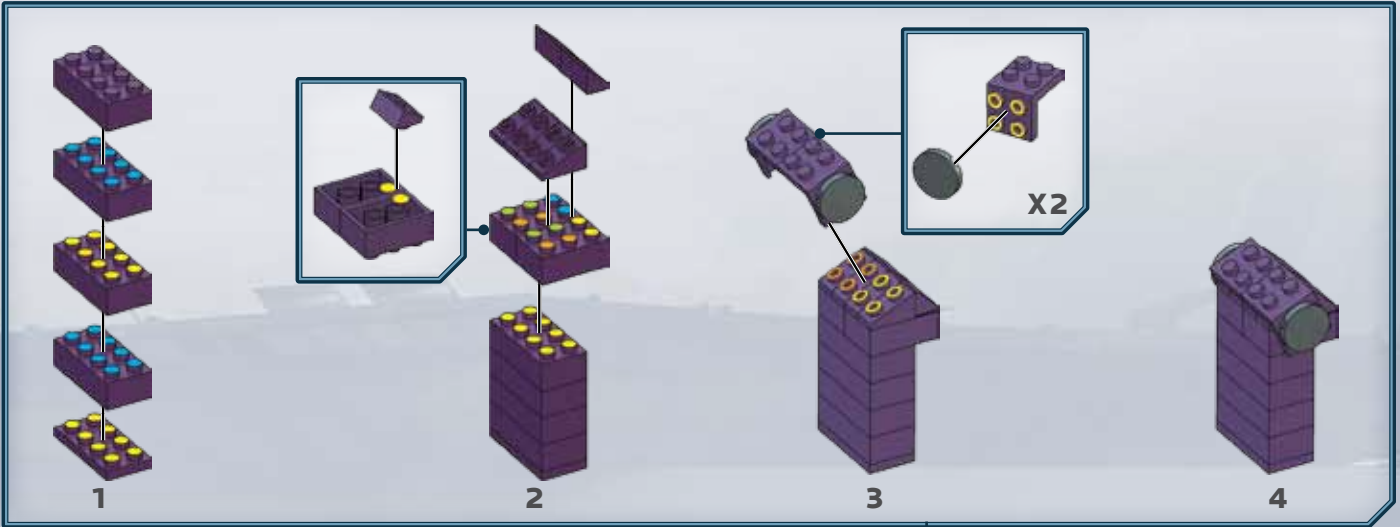

## 27

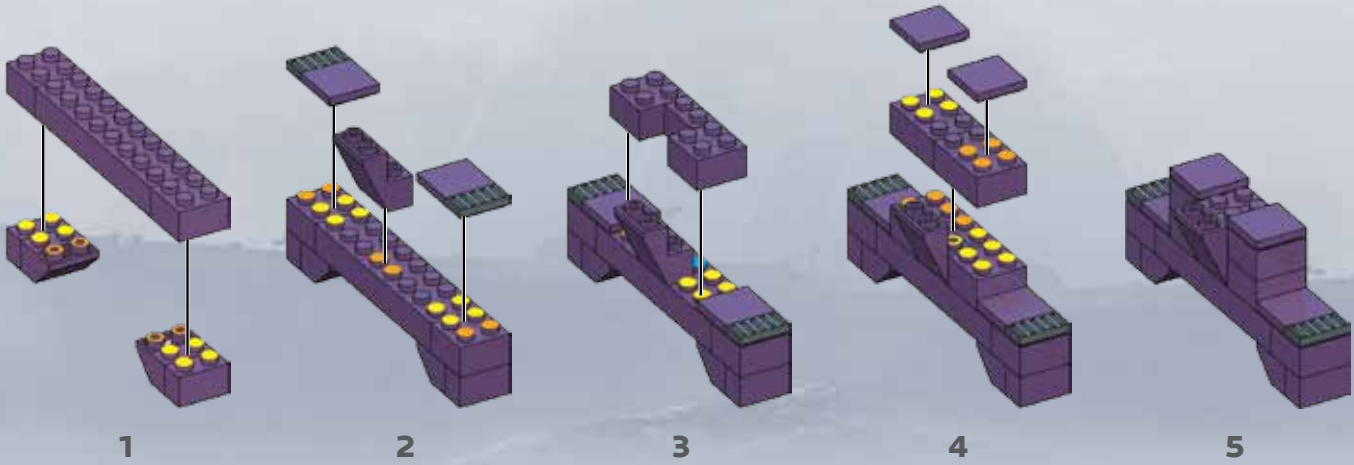

## 28

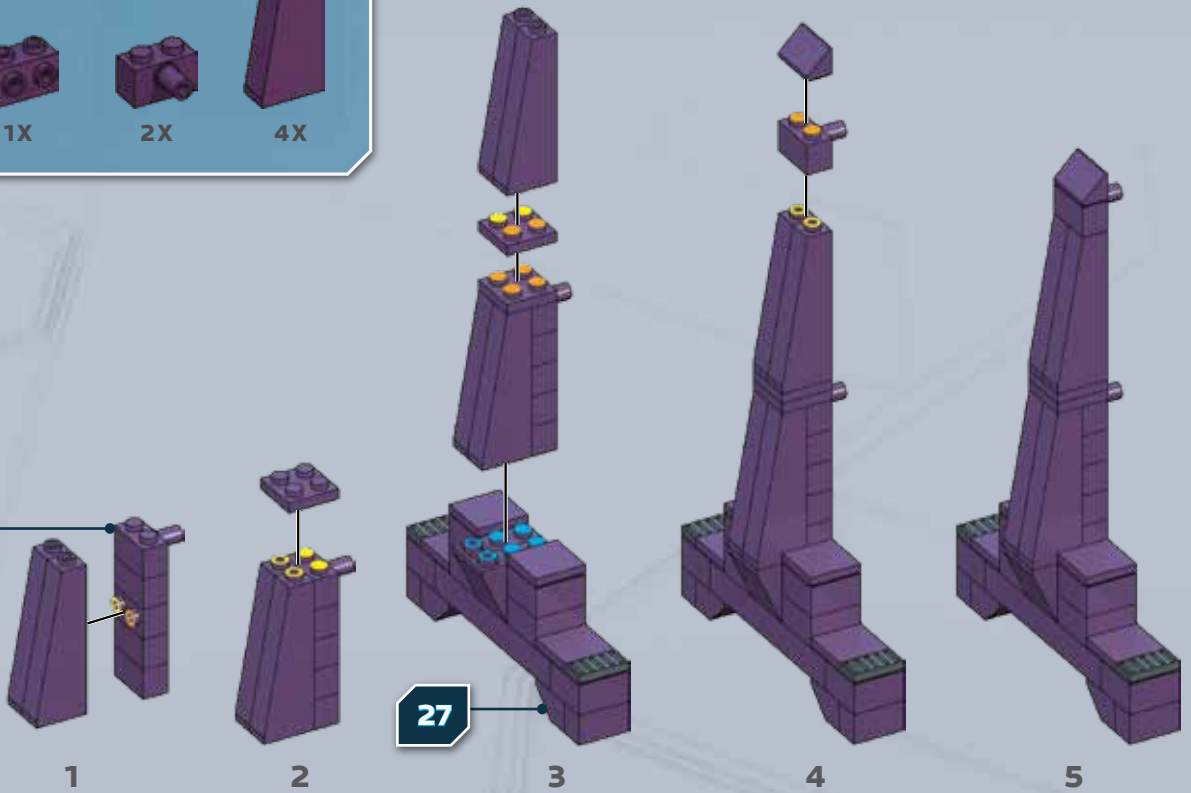
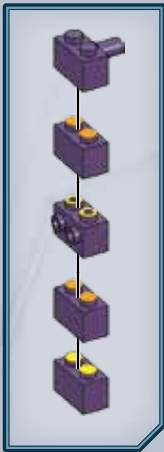



29

2X

2X

1X

2X

2X

2X

4X

3X

4X

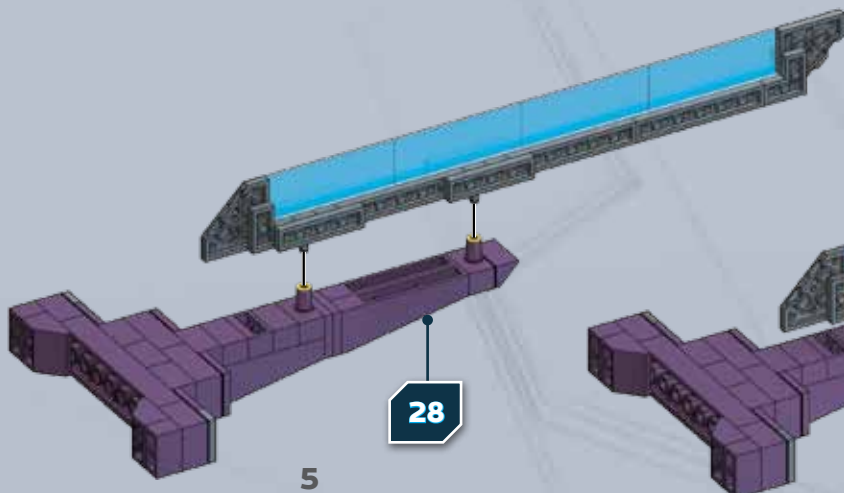
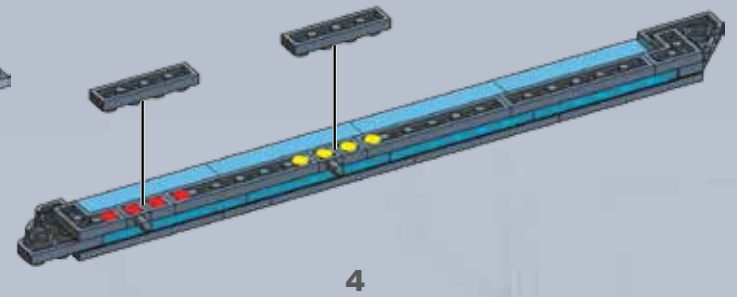
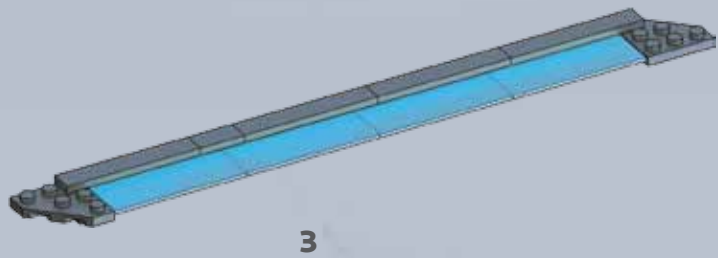
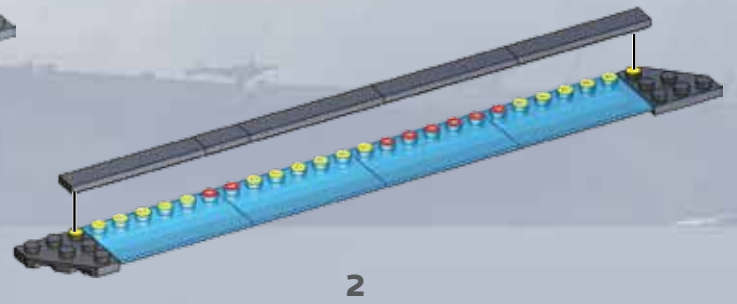
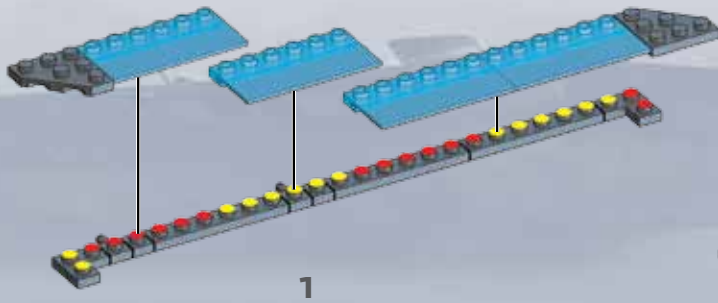

28

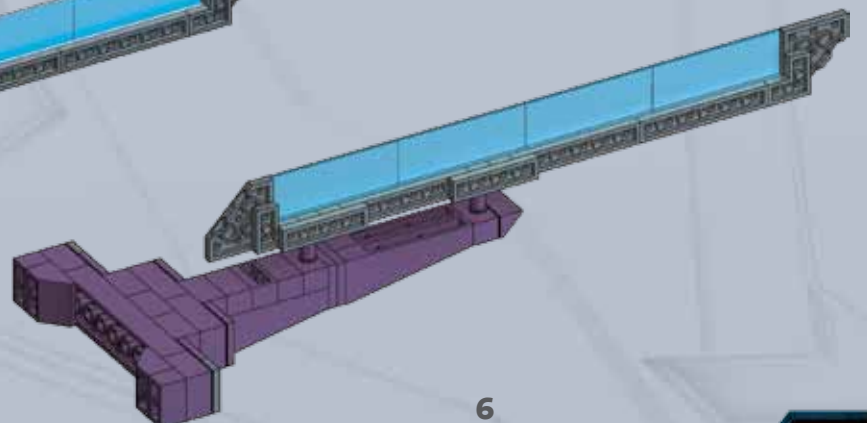

23

30

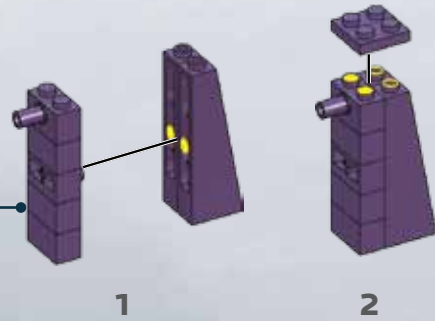
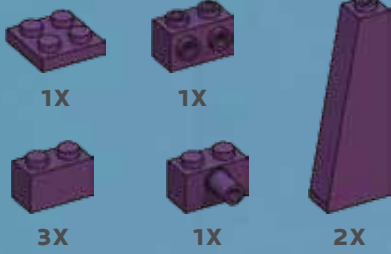

31

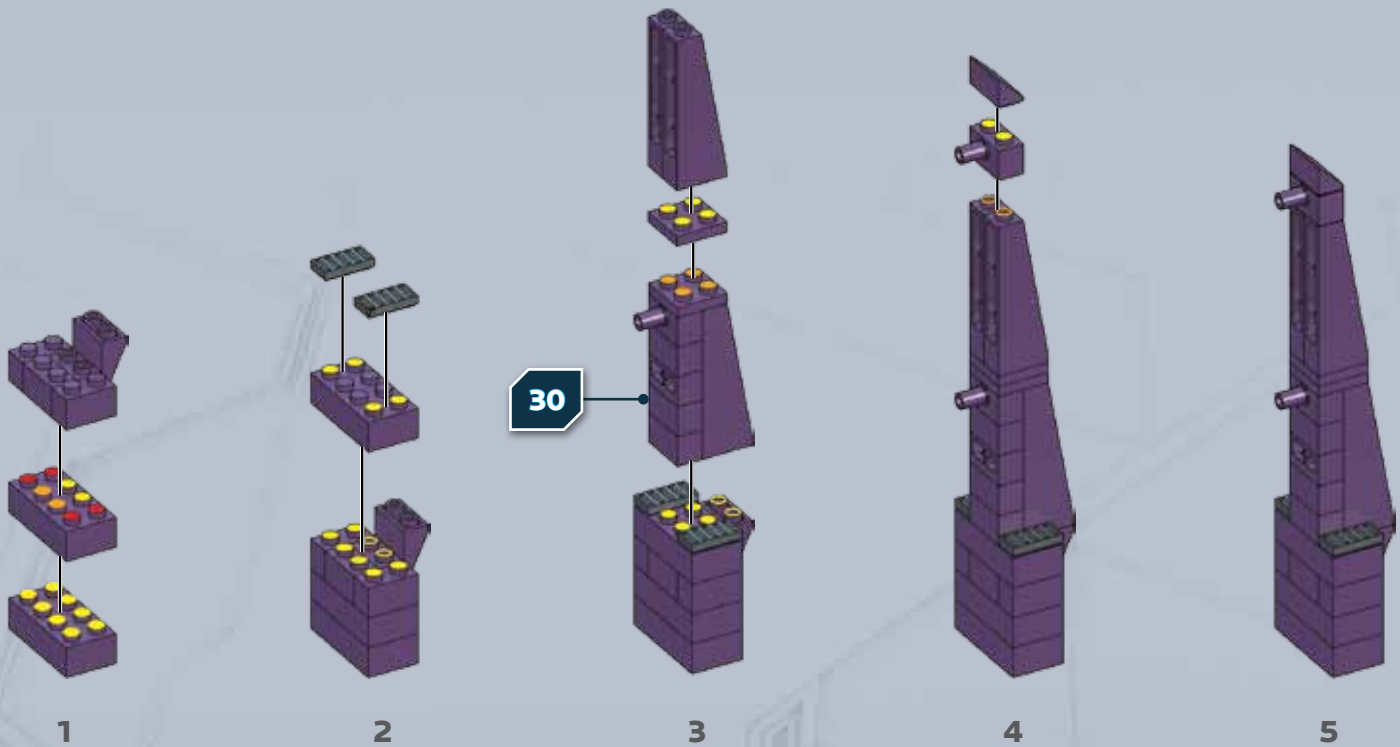
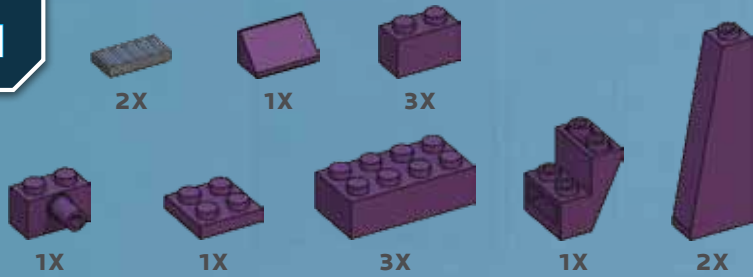





33

29

32

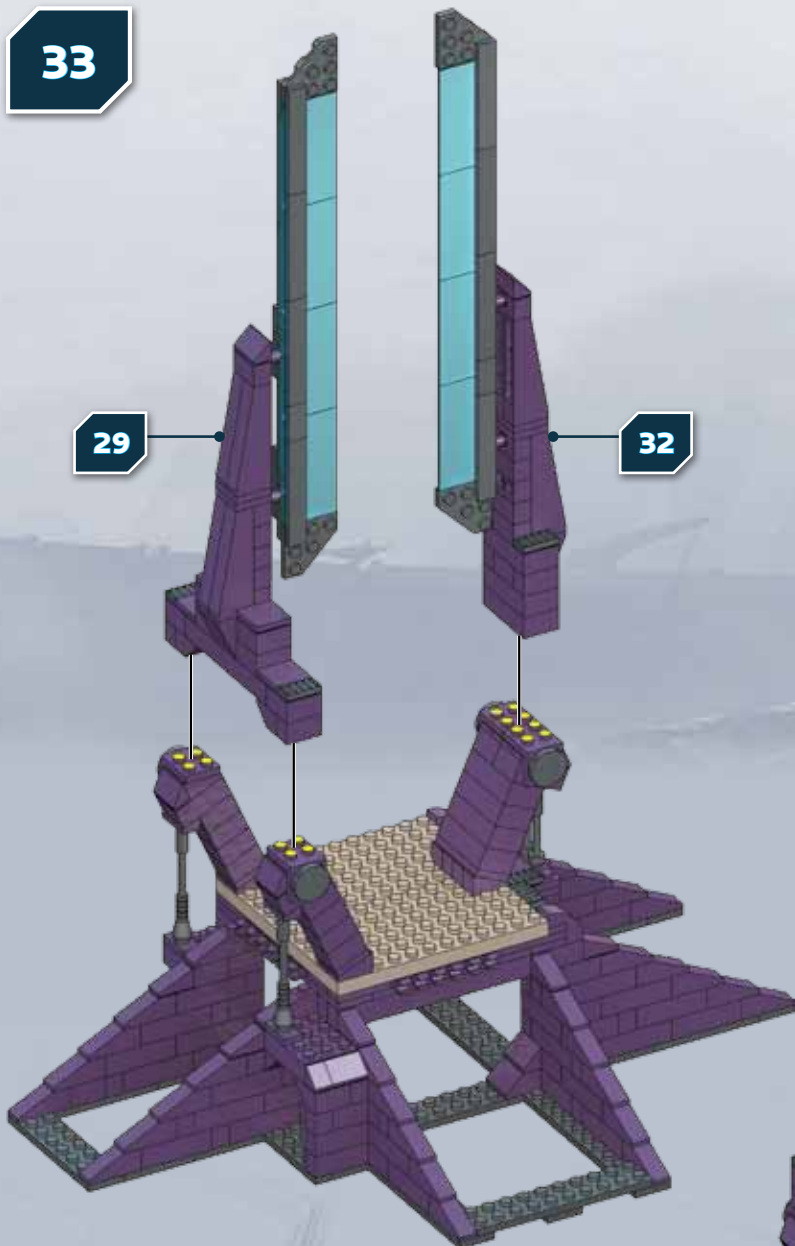

1

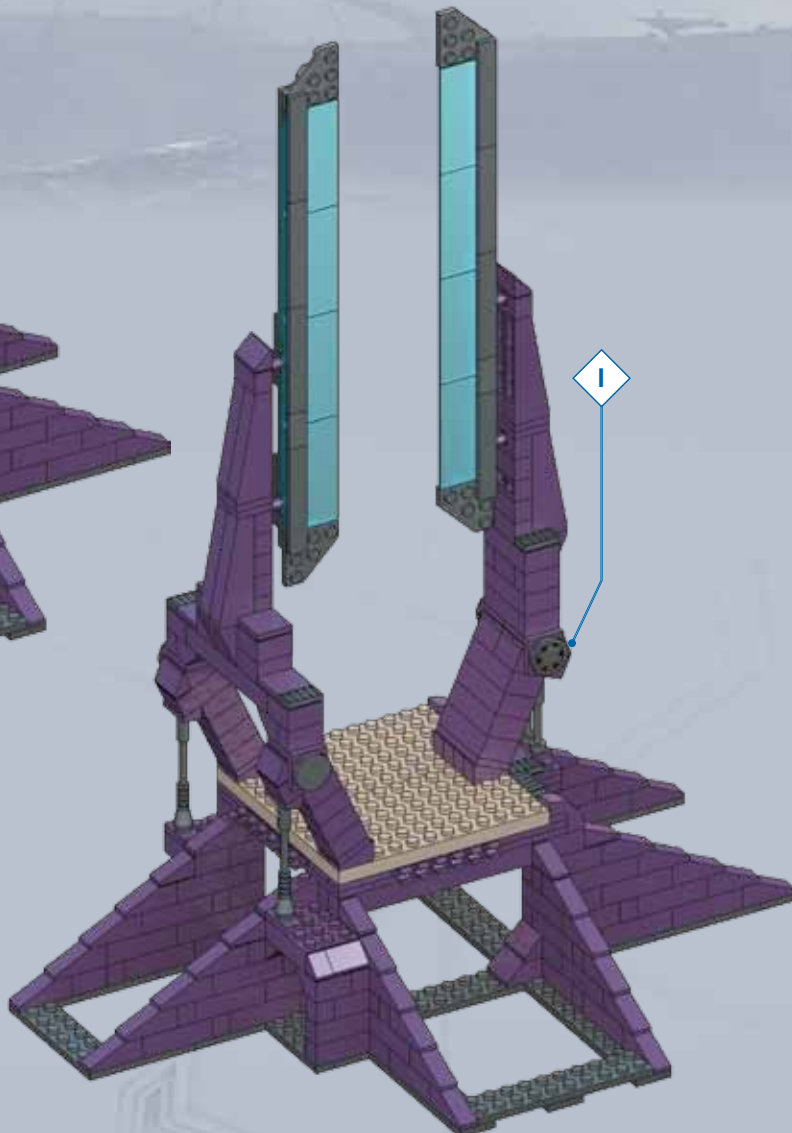

2



34

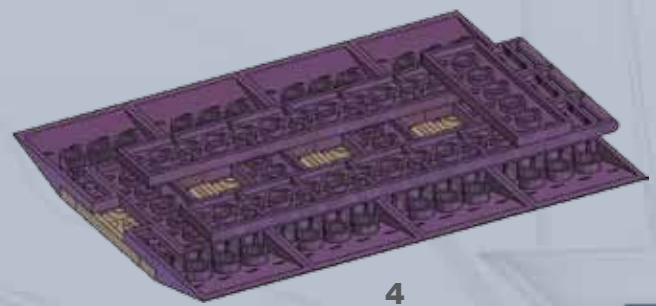
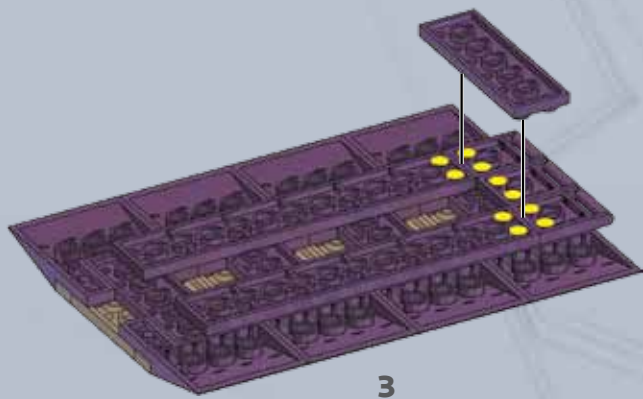
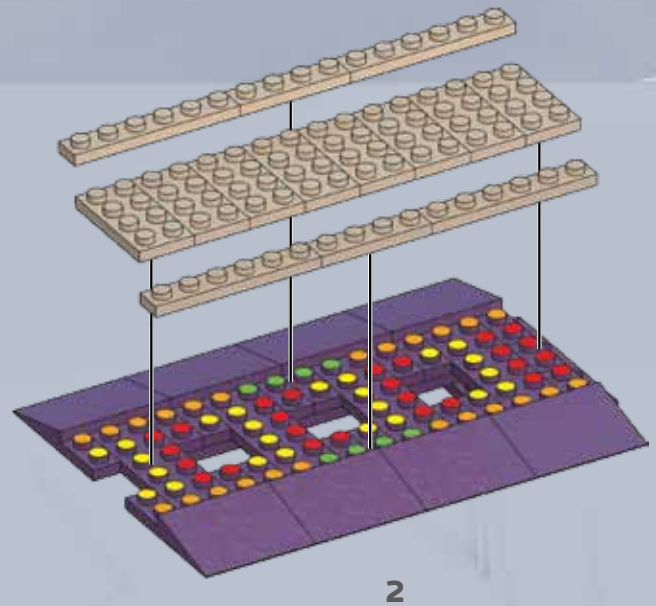
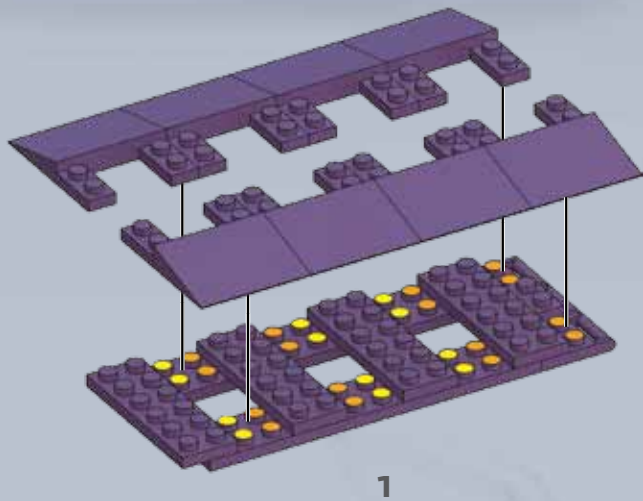
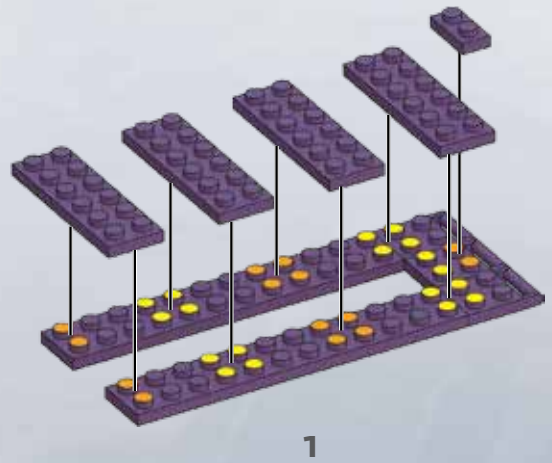
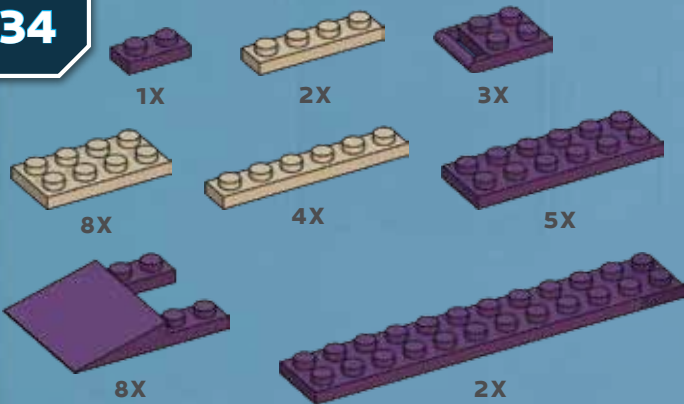

35



33

34

36

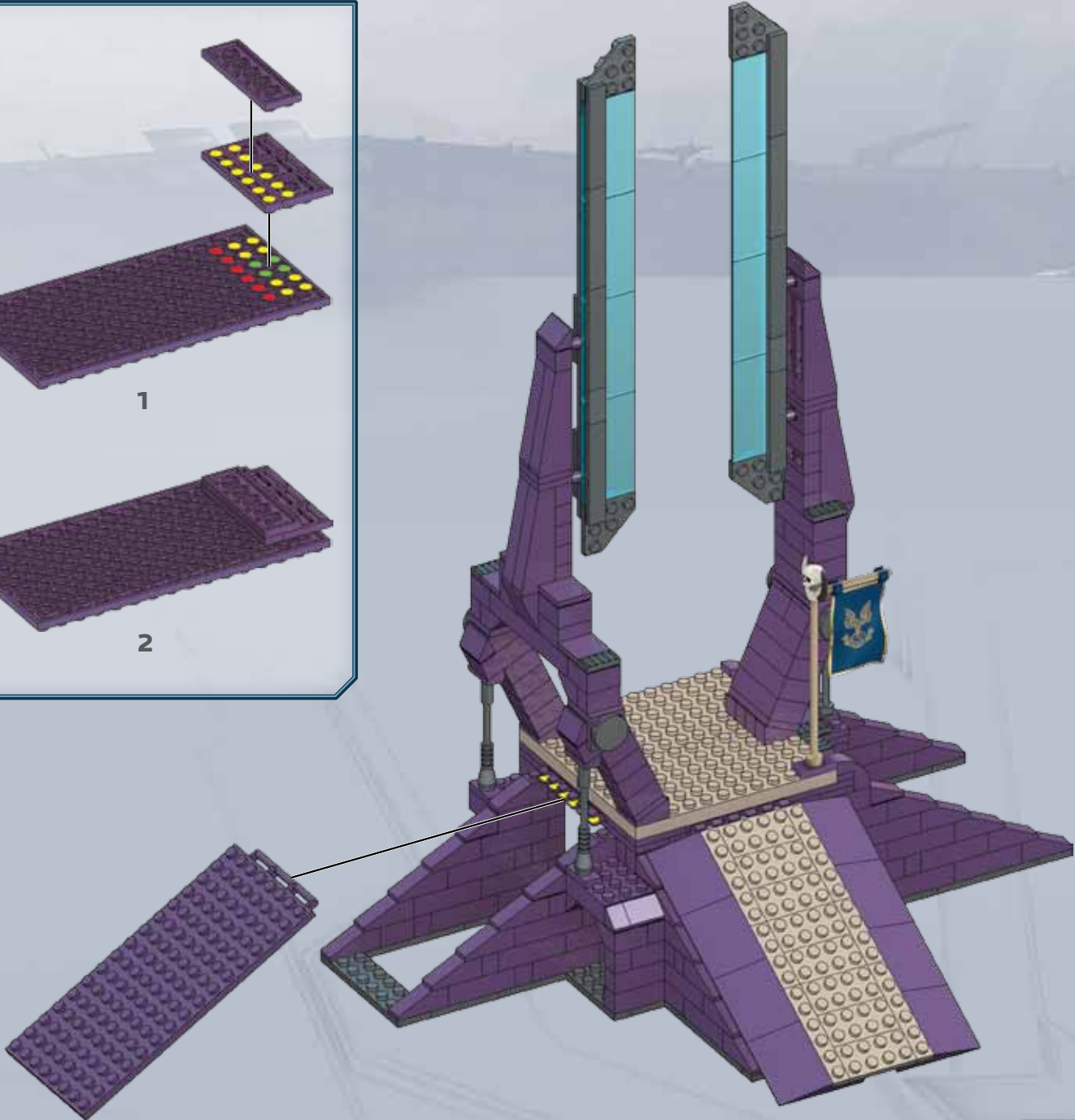
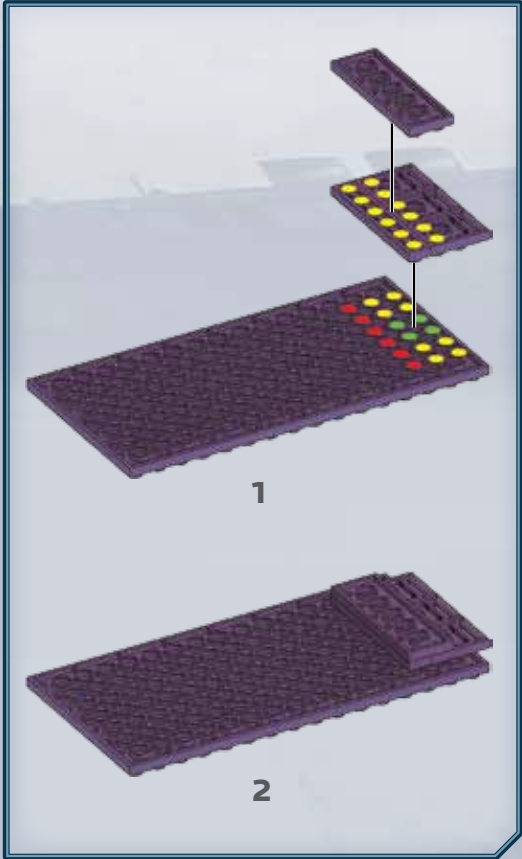
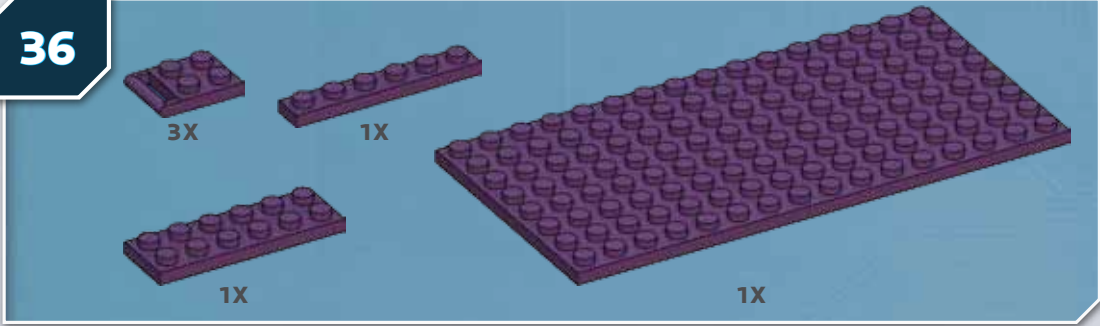

29



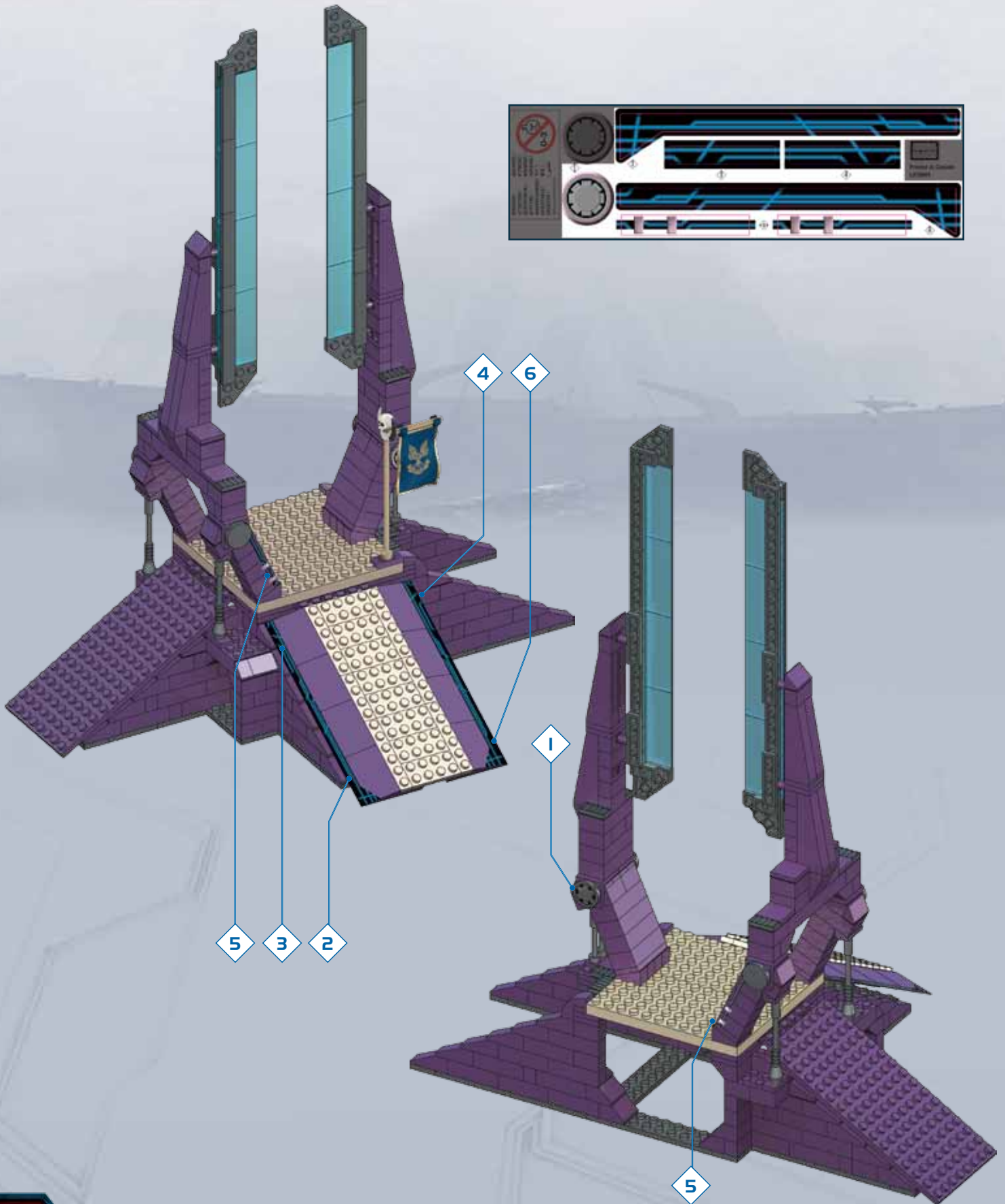
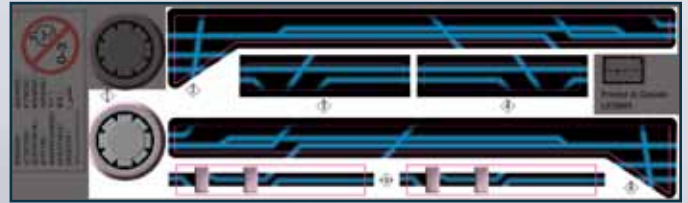

Go to [halo.megabloks.com/downloads](http://halo.megabloks.com/downloads)  
for rebuild instructions!

¡Visita [halo.megabloks.com/downloads](http://halo.megabloks.com/downloads)  
para obtener instrucciones de reconstrucción!

Allez au [halo.megabloks.com/downloads](http://halo.megabloks.com/downloads)  
pour obtenir des instructions de réassemblage!

Für Wiederaufbauanleitungen gehe zu  
[halo.megabloks.com/downloads](http://halo.megabloks.com/downloads)!

Ga voor bouw instructies naar  
[halo.megabloks.com/downloads](http://halo.megabloks.com/downloads)

Vai su [halo.megabloks.com/downloads](http://halo.megabloks.com/downloads)  
per le istruzioni di ricostruzione!

Visite [halo.megabloks.com/downloads](http://halo.megabloks.com/downloads)  
para instruções de reconstrução!



**REBUILD!**  
**¡RECONSTRUYE!**  
**RECONSTRUIS!**  
BAUE! / BOWEN! /  
COSTRUISCI! /  
CONSTRÓ!

**97068**  
**BATTLESCAPE NOT INCLUDED**  
NO INCLUYE EL CAMPO DE BATALLA  
CHAMP DE BATAILLE NON COMPRIS  
BALLESCAPE NICHT ENTHALTEN  
GEVECHTSTERREIN NIET INBEGREPEN  
BATTLESCAPE NON INCLUSO  
CAMPO DE BATALHA NÃO INCLUÍDO

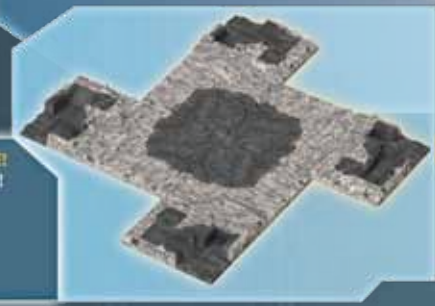
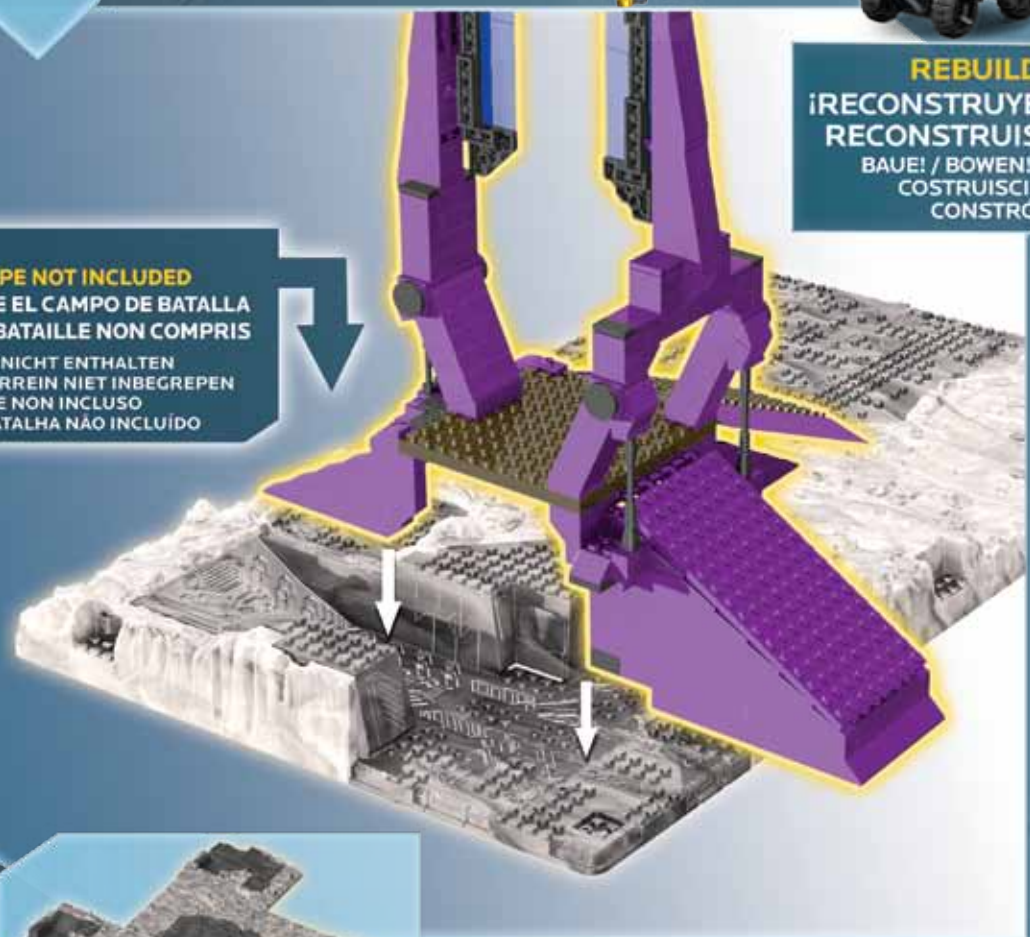

**CONNECT AND EXPAND YOUR BATTLE!**  
**¡CONECTATE Y EXPANDE TU BATALLA!**  
RELIEZ ET AGRANDISSEZ VOTRE  
ÉQUIPE DE COMBAT!  
VERBINDE UND ERWEITERE DEINEN KAMPF!  
KOPPEL AAN ELKAAR EN BREID JE GEVECHT UIT!  
COLLEGA ED ESTENDI LA TUA BATTAGLIA!  
CONECTE E EXPANDA SUA BATALHA!

Additional purchases required to collect all elements shown. / Para coleccionar todos los elementos mostrados se precisa realizar unas compras adicionales. / Des achats additionnels sont nécessaires afin d'obtenir tous les articles de la collection illustrés. / Des achats additionnels sont nécessaires afin d'obtenir tous les articles de la collection illustrés. / Um alle dargestellten Elemente zu sammeln sind zusätzliche Käufe erforderlich. / Verdere aankopen zijn nodig om alle afgebeelde artikelen te verzamelen. / Acquisti supplementari necessari per collezionare tutti gli elementi illustrati. / Compras adicionais são necessárias para coleccionar todos os elementos exibidos.



## VERSUS: SNOWBOUND HIGHBASE

Choose your side and recreate arctic showdowns as Red and Blue Team race to control Snowbound High Base! The Red Team Spartan EVA's boots crunch into freshly packed snow as he makes a break for it with Blue Team's flag. The Blue Team Spartan EOD grips the handlebars on his arctic Mongoose and pulls back on the throttle, jumping from High Base and taking aim with his Spiker to stop Red Team and get Blue Team's flag back!

### Versus: Base alta Snowbound

Elige tu lado y recrea los enfrentamientos árticos mientras el equipo azul y rojo compiten por controlar la base de altura Snowbound! Las botas del EVA Spartan crujen en la fresca nieve a medida que se toma un descanso con la bandera del equipo azul. El Spartan EOD del equipo azul coge el manubrio en su Mongoose ártica y jala el acelerador saltando de la base de altura y apuntando con su Spiker para detener al EVA rojo y recuperar la bandera del equipo azul.

### Versus : Base surélevée de Blizzard

Choisissez votre allégeance et recréez les grands combats arctiques au cours desquels les équipes rouge et bleue s'affrontent pour contrôler la base surélevée de Snowbound! Les bottes du Spartan EVA rouge creusent dans la neige alors qu'ils s'élancent vers le drapeau de l'équipe bleue. Le Spartan EOD bleu saisit les commandes de son Mongoose arctique et file à pleine vitesse de la base surélevée, armé de son Spiker pour arrêter le Spartan EVA rouge et récupérer le drapeau de l'équipe bleue!

### Gegen: Eingeschneite Highbase

Wähle Deine Seite und stelle arktische Showdowns nach, während das Rote und Blaue Team sich ein Rennen über die Kontrolle der Snowbound Hohen Basis liefern! Die Stiefel des Roten EVA Spartan knirschen im frischen Schnee, während er für die Flagge des Blauen Teams abgesetzt wird. Der Blaue EOD Spartan greift die Griffe seiner arktischen Mongoose und zieht den Gashebel zurück, springt von der Hohen Basis und richtet seinen Spiker aus, um den Roten EVA zu stoppen und die Flagge des Blauen Teams zurückzuholen!

### Tegen: Snowbound-basis Hoog

Bepaal aan welke kant je staat en speel confrontaties na in het poolgebied, waar het rode en blauwe team strijden om de leiding over de Snowbound-basis! De laarzen van de EVA-Spartan knerpen in het verse pak sneeuw als hij probeert te ontsnappen met de vlag van het blauwe team. De blauwe EOD-Spartan grijpt het stuur van zijn arctische Mongoose vast, geeft gas, springt weg van het basiskamp en legt zijn Spiker aan om de rode EVA tegen te houden en de vlag van het blauwe team te heroveren!

### Contro: Highbase Snowbound

Scegli da che parte stare e ricrea gli scontri arctici tra la Squadra Rossa e Blu per il controllo della High Base Snowbound! Gli stivali dello Spartan EVA Rosso affondano nella neve fresca mentre tenta la fuga con la bandiera della Squadra Blu. Lo Spartan EOD Blu impugna i manubri del suo Mongoose artico e accelera a tutta velocità, saltando dalla High Base e prendendo la mira con il suo Spiker per fermare l'EVA Rosso e riprendersi la bandiera della Squadra Blu!

### Contra: Base Elevada Snowbound

Escolha seu lado e recree cenários do ártico enquanto as Equipes Vermelha e Azul correm pelo controle da Alta Base Snowbound! As botas EVA Spartan Vermelhas esmagam a neve recém amontoada enquanto tentam tomar a bandeira da Equipe Azul. O EOD Spartan Azul agarra o leme deste Mongoose ártico e pisa no acelerador, pulando da Alta Base e mirando com seu Spiker para impedir a EVA Vermelha e conseguir de volta a bandeira da Equipe Azul!

CONNECT AND EXPAND YOUR BATTLE!  
¡CONECTATE Y EXPANDE TU BATALLA!  
RELIEZ ET AGRANDISSEZ VOTRE ÉQUIPE DE COMBAT!

VERBINEE UINE BRANȘETĂ DE JUCĂRIȘI A CĂPĂRI  
KOPPEL AAN ELKAAR EN BRED TO GEVECHT DIT!  
COLLEGA ED ESTENDI LA TUA BATTAGLIA!  
CONECTE E EXPANDA SUA BATALHA!

SET INCLUDES BOTH PLAYERS!  
NO INCLUDES EL CANTO DE BOTAS LA  
CANTO DE BOTAS LA CANTO DE BOTAS LA  
CANTO DE BOTAS LA CANTO DE BOTAS LA  
CANTO DE BOTAS LA CANTO DE BOTAS LA  
CANTO DE BOTAS LA CANTO DE BOTAS LA

16.5" - 42 CM

INCLUDES 2 PLAYERS  
INCLUDES 2 PLAYERS  
INCLUDES 2 PLAYERS  
INCLUDES 2 PLAYERS  
INCLUDES 2 PLAYERS  
INCLUDES 2 PLAYERS

UNSC INTEL

Collect them all! ¡Coleccionalos todos! Collectionne-les tous!  
Het sie dir alle! Verzamel ze allemaal! Collezionali tutti! Colecciona todos eles!



UNSC SPARTAN EVA

EVA Spartan CENU  
EVA Spartan CSNU  
RVN EVA Spartan  
RVN EVA-Spartan  
EVA Spartan CSNU  
EVA Spartan CENU



UNSC SPARTAN EOD

EOD Spartan CENU  
EOD Spartan CSNU  
RVN EOD Spartan  
RVN EOD-Spartan  
EOD Spartan CSNU  
EOD Spartan CENU



97041

97065

97068



©2012, MEGA Brands Inc.  
&™ MEGA Brands Inc.

Printed in Canada D970691A