

**MEGA  
BLOKS**

# HALO



**97015**

**Covenant Seraph • Seraph de Covenant  
Seraph du Covenant • Seraph Covenant**



### Covenant Seraph

The Covenant Seraph is the multi-role fighter of the Covenant. Armed with a pair of Heavy Plasma Cannons and protected by an Energy Shield, this superior indigo craft is incredibly versatile.

### Seraph de Covenant

El Seraph de Covenant es el luchador de varios roles de Covenant. Armado con un par de cañones de plasma pesados y protegidos por un escudo de energía, esta nave índigo superior es increíblemente versátil.

### Covenant Seraph

Le Covenant Seraph est le chasseur de choix du Covenant. Armé d'une paire de puissants canons au plasma et protégé par un bouclier d'énergie, cet aéronef bleu indigo de calibre supérieur est incroyablement habile et agile.

### Covenant Seraph

Der Covenant Seraph ist der universelle Kämpfer des Covenant. Ausgerüstet mit ein Paar schwere Plasmakanonen und geschützt durch ein Energieschild, ist diese überlegene indigofarbene Kampfmaschine unglaublich vielseitig.

### Covenant Seraph

De Covenant Seraph is een multifunctionele jager van de Covenant. Deze ongelofelijk veelzijdige blauwe jager is uitgerust met een tweetal Heavy Plasma Cannons en wordt beschermd door een Energy Shield.

### Seraph Covenant

Il Seraph Covenant è il caccia multi-funzione di Covenant. Armato con una coppia di cannoni pesanti al plasma e protetto da uno scudo ad energia, questo velivolo indaco superiore è incredibilmente versatile.

### Seraph Covenant

O Seraph Covenant é o lutador multi-funções do Covenant. Equipado co dois Canhões Pesados de Plasma e protegido por um Escudo de Energia, esta nave superior azul é incrivelmente versátil.

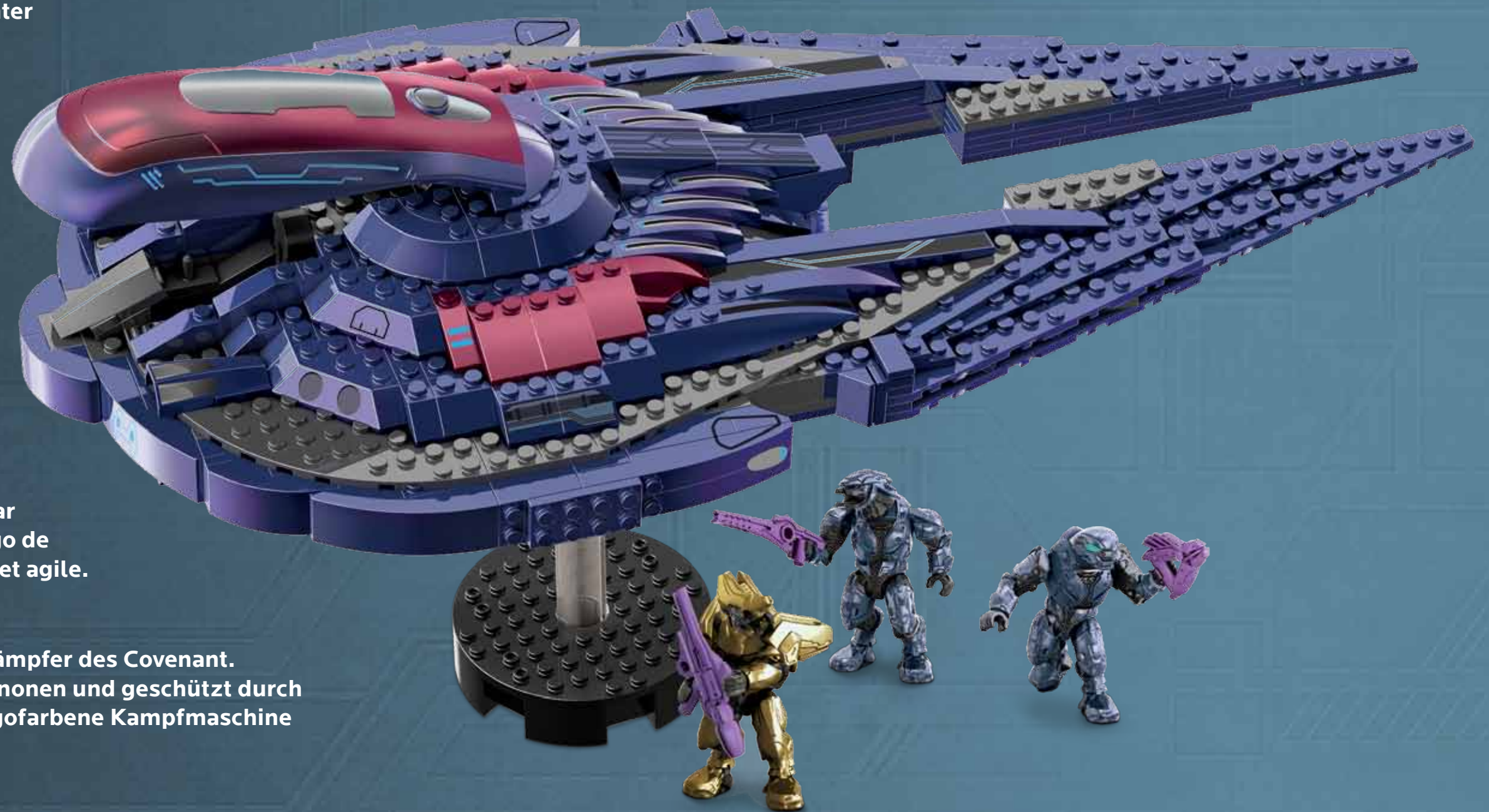



**MEGA  
BLOKS**

# HALO



Register for the Halo Bloks Brigade!  
Apuntate a la brigada Halo Bloks!  
Enrolez-vous dans la Brigade Halo Bloks!  
Registriere dich fur die Halo-Bloks Brigade! • Schrijf je in voor de Halo Bloks Brigade!  
Effetua la registrazione per la Brigata dei Blok Halo! • Regista-te para a Brigada Halo Bloks!

[halo.megabloks.com](http://halo.megabloks.com)



6x MA03328ARM  
 2x MA03328MM  
 21x MA09393ARM  
 6x MA09393MM  
 2x MA02250IARM  
 8x MA02250IMM  
 2x MA09198MM  
 1x MA07590MM  
 2x AMI7070MM  
 2x AMI6680ARM  
 6x MAI086ARM  
 1x AMI7130ARM  
 1x AMI7130AJT  
 1x AMI7129ARM  
 1x AMI7129AJT  
 2x MA03019ARM  
 2x MA04429MM  
 1x AMI7834F

10x MA09013MM  
 12x MA09013ARM  
 2x MAI133F  
 2x AMI7502ARM  
 4x AMI7502MM  
 6x MAI322ARM  
 1x AMO2799MM  
 6x MAI5484ARM  
 4x MAI5484MM  
 2x MA0948ARM  
 4x MA0948MM  
 7x MA03773ARM  
 2x MO3773AJT  
 16x MAI146ARM

1x MAI8329MM  
 4x AMI7153ARM  
 4x AMO2212ARM  
 2x MAI154ARM  
 10x MAI0273ARM  
 6x MA09023ARM  
 4x MA09023MM  
 2x MA09023BYE  
 2x AMI720IARM  
 2x AMO9106MM  
 6x MAI314ARM  
 4x AMI7073ARM

2x AMI7073MM  
 4x AMI7074ARM  
 2x AMI7074MM  
 2x MA03772MM  
 5x MA03772ARM  
 20x MAI141MM  
 6x MAI323ARM  
 4x MAI323MM  
 2x MI323AJT  
 2x MAI418ARM  
 2x AMO7230AJT  
 9x MA03873ARM  
 4x MA03873MM

6x MO4497AJT  
 1x MA04497F  
 14x MAI139ARM  
 2x AMI8732ARM  
 1x MA09593MM  
 7x MA09593ARM  
 8x AMI9323ARM  
 10x MA09493ARM  
 3x MA09493MM  
 4x AS9701506  
 1x AMO8416MM  
 10x AMI7021MM

16x MAI087ARM  
 4x AMI7503ARM  
 22x MA09033ARM  
 15x MA09033MM  
 8x MA09033BYE  
 2x AMI9324ARM  
 2x AMI9324MM  
 2x AMI8270ARM  
 2x MA07475MM  
 2x MA07475ARM  
 6x AMI6959ARM

1x AMI8288MM  
 1x AS9701508  
 1x AMO8409ARM  
 7x MA09292ARM  
 30x MAI480ARM  
 1x MAI480MM  
 8x MAI313ARM  
 4x AMI6638ARM  
 4x AMI8777ARM  
 2x AMI8656ARM  
 4x AMI8731ARM

1x AMI7055F  
 3x AMI7055ARM  
 2x AMO4983MM  
 6x MA08483MM  
 4x MA08483ARM  
 5x MAI0233ARM  
 6x AM72060ARM  
 1x AMO9184ARM  
 1x AMO9185ARM  
 2x AMI7077ARM  
 1x AMI7077MM

2x AMI7076ARM  
 1x AMI7076MM  
 1x AMI6648ARM  
 1x AMI6648MM  
 1x AMI6647ARM  
 1x AMI6647MM  
 2x AMO9924ARM  
 2x AMO9924MM  
 3x AMO4985ARM  
 3x MA09923ARM





1x L97015IA



1x AMI7189W

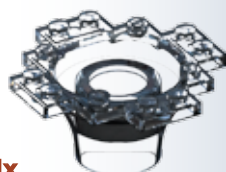

1x AMI7190W



4x AMI5510ARM



1x AMI7188F



2x AM72059MM



3x AMI8674ARM

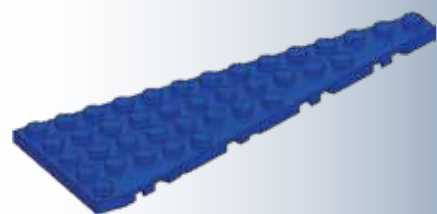

3x AMI8675ARM

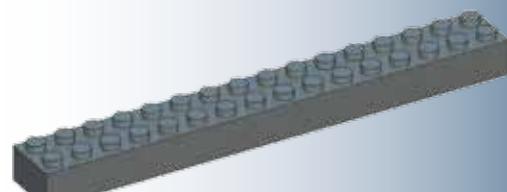

5x AMI8611MM

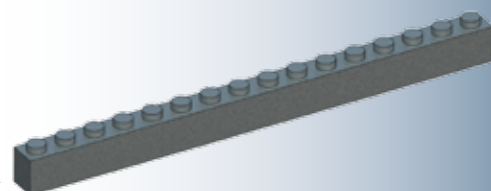

2x AMI8677MM



2x AMI8567MM

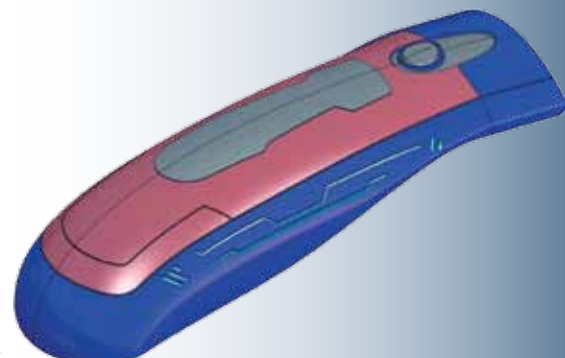

1x AS9701507



1x AMI8150SX



1x AMI9773SX



1x AMI9981SX



1x AS9691203



1x AS9701501



1x AS9701503



1x AS9701505



1x AS9701504

EN Please read these instructions carefully before first use and keep them for future reference.  
 ES Leer estas instrucciones cuidadosamente antes de la primera utilización y guardarlas para referencia futura.  
 FR Il est recommandé de lire attentivement ce feuillet avant la première utilisation et de le conserver pour référence future.  
 DE Die Gebrauchsanleitung bitte durchlesen und aufbewahren.  
 NL Wij raden u aan deze handleiding zorgvuldig te lezen en te bewaren voor eventuele raadpleging op een later tijdstip.  
 DA Vær venlig at læse disse instruktioner omhyggeligt inden ibrugtagning og opbevar dem til fremtidigt brug.  
 EL Διαβάστε αυτές τις οδηγίες προσεκτικά πριν χρησιμοποιήσετε το προϊόν για πρώτη φορά και φυλάξτε τις για μελλοντική αναφορά.  
 FI Lue nämä ohjeet huolellisesti ennen ensimmäistä käyttöä ja säilytä ne myöhempää tarvetta varten.  
 IT Leggere le istruzioni prima di cominciare ad usare il gioco e conservarle per referenze future.  
 NO Les disse instruksjonene nøye før første gangs bruk, og ta vare på dem for fremtidige oppslag.  
 PT Leia as instruções antes do primeiro uso e guarde-as para futura referência.  
 SV Läs noggrant igenom dessa instruktioner innan du använder produkten för första gången och spara dem för ev. framtida frågor.  
 JA 初めてご使用になる前に、この説明書をよくお読みください。また、本書は将来いつでも参照できるように保管してください。  
 ZH 请在初次使用前仔细阅读这些指示，并保留它们以便未来参考。  
 AR يرجى قراءة هذه التعليمات بدقة قبل البدء بالاستعمال والاحتفاظ بها كمرجع للمستقبل

EN ⚠ WARNING : CHOKING HAZARD. - Small parts. Toy contains a small ball. Not for children under 3 years.  
 ES ⚠ ADVERTENCIA : RIESGO DE ASFIXIA. - Contiene piezas pequeñas. El juguete contiene una bola pequeña. No recomendado para niños menores de 3 años.  
 FR ⚠ ATTENTION : DANGER D'ÉTOUFFEMENT. - Présence de petits éléments. Le jouet contient une petite balle. Ne convient pas aux enfants de moins de 3 ans.  
 DE ⚠ ACHTUNG : ERSTICKUNGSGEFAHR. - Enthält kleine Teile. Ein kleiner Ball ist im Spielzeug inbegriffen. Nicht für Kinder unter 3 Jahren geeignet.  
 NL ⚠ WAARSCHUWING : VERSTIKKINGSGEVAAR. - Bevat kleine onderdelen. Speelgoed bevat een klein balletje. Niet geschikt voor kinderen onder de 3 jaar.  
 DA ⚠ ADVARSEL : FARE FOR KVÆLNING. - Indeholder smådele. Legetøjet indeholder en lille bold. Ikke til børn under 3 år.  
 EL ⚠ ΠΡΟΕΙΔΟΠΟΙΗΣΗ : ΚΙΝΔΥΝΟΣ ΠΝΙΓΜΟΥ. - Περιέχει μικρά αντικείμενα. Το παιχνίδι περιέχει ένα μικρό μπάκι. Όχι για παιδιά κάτω των 3 ετών.  
 FI ⚠ VAROITUS : TUKEHTUMISVAARA. - Sisältää pieniä osia. Leluun sisältyy pieni pallo. Ei alle 3-vuotiaille lapsille.  
 IT ⚠ AVVERTENZA : PERICOLO DI SOFFOCAMENTO. - Contiene piccole parti. Il giocattolo comprende una pallina. Non indicato per bambini sotto i 3 anni.  
 NO ⚠ ADVARSEL : KVELNINGSFARE. - Inneholder små deler. Leketøyet inneholder en liten ball. Kun for barn over 3 år.  
 PT ⚠ ATENÇÃO : PERIGO DE ASFIXIA. - Contém peças pequenas. O brinquedo contém uma pequena bola. Não é concebido para crianças de menos de 3 anos.  
 SV ⚠ VARNING : KVÄVNINGSRISK. - Innehåller små delar. Leksaken innehåller en liten boll. Inte för barn under 3 år.  
 JA ⚠ 警告 : のどにつまる危険 小さな部品が含まれています 小さな玉が含まれています。 3歳以下の子供には与えないで下さい。  
 ZH ⚠ 警告 : 噎住危险。 包含有小部件 此玩具含有一个球。 不适合3岁以下的小孩玩。  
 AR ⚠ تحذير : خطر الاختناق - قطع صغيرة. تحتوي اللعبة على كرة صغيرة. غير صالحة للأطفال أقل من 3 سنوات.



# ARMORY ARMERIA ARMURERIE

KAMPFAUSRÜSTUNG / WAPENUITRUSTING ARSENALE / ARMARIA

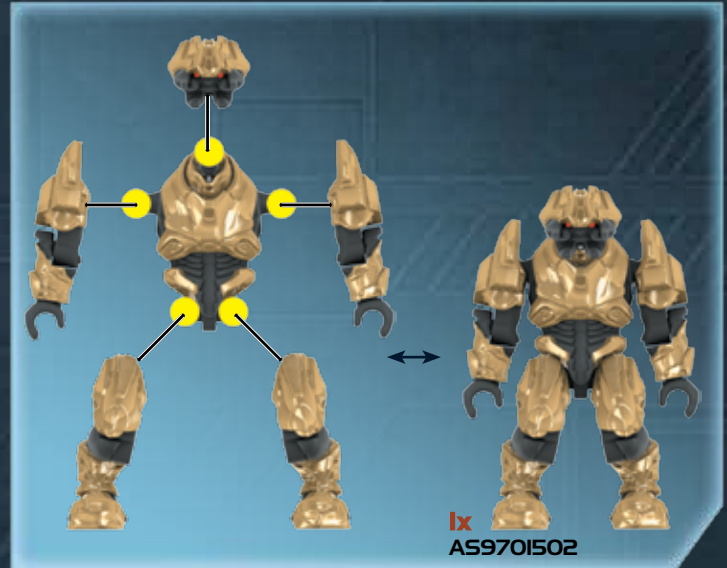

BUILD & CREA Y CONSTRUIR  
CUSTOMIZE PERSONALIZA ET PERSONNALISE  
BAUEN UND INDIVIDUELL GESTALTEN / BOUWEN EN AANPASSEN  
COSTRUISCI E PERSONALIZZA / CONSTRÓI E PERSONALIZA

Get the free mobile app for your phone  
<http://gettag.mobi>



© 2012 MICROSOFT CORPORATION. ALL RIGHTS RESERVED. MICROSOFT, 343 INDUSTRIES, THE 343 INDUSTRIES LOGO, HALO, THE HALO LOGO, XBOX, XBOX 360, AND THE XBOX LOGOS, ARE TRADEMARKS OF THE MICROSOFT GROUP OF COMPANIES.





**1**

- 2X [Grey 1x2 Technic Brick]
- 2X [Blue 1x2 Technic Brick]
- 2X [Grey 1x2 Technic Brick]
- 2X [Grey 1x12 Technic Plate]

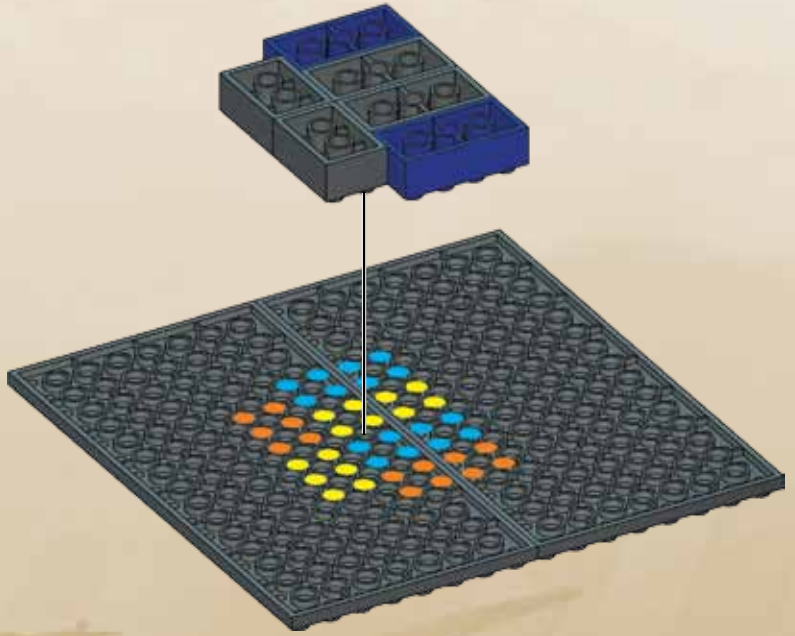

**2**

- 2X [Blue 1x2 Technic Brick]
- 3X [Grey 1x2 Technic Brick]
- 1X [Grey 1x2 Technic Brick]
- 1X [Grey 1x2 Technic Brick]

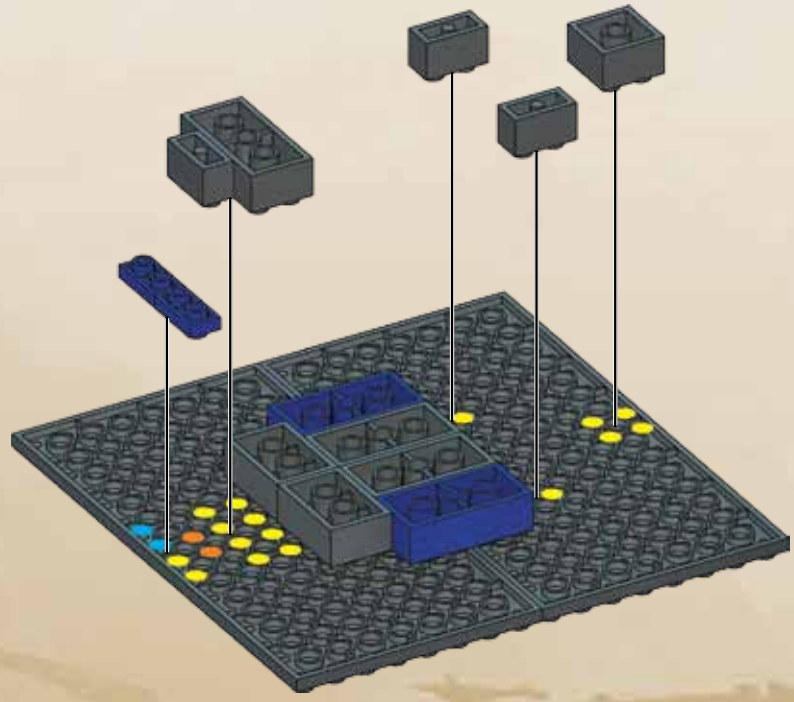

**3**

- 4X [Blue 1x2 Technic Brick]

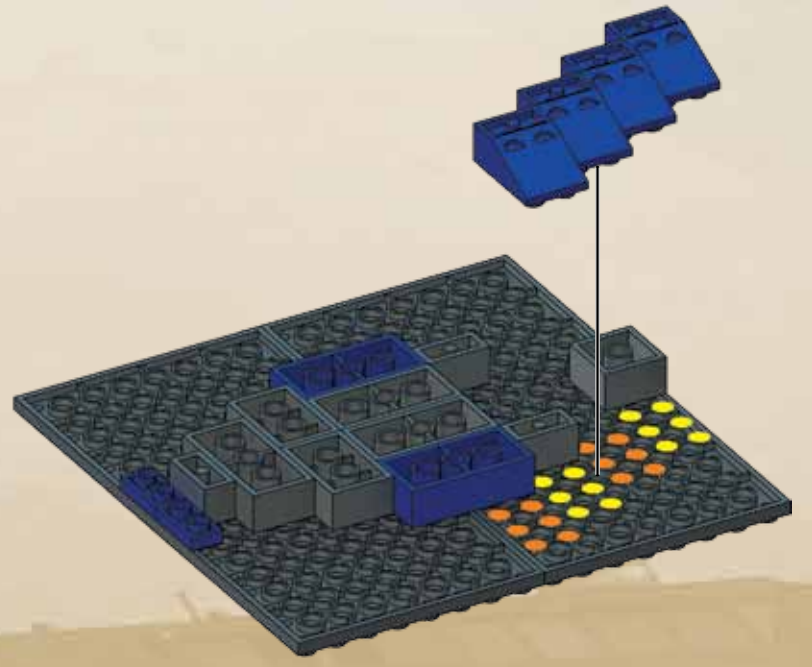

**4**

- 1X [Blue 1x2 Technic Brick]
- 3X [Blue 1x2 Technic Brick]

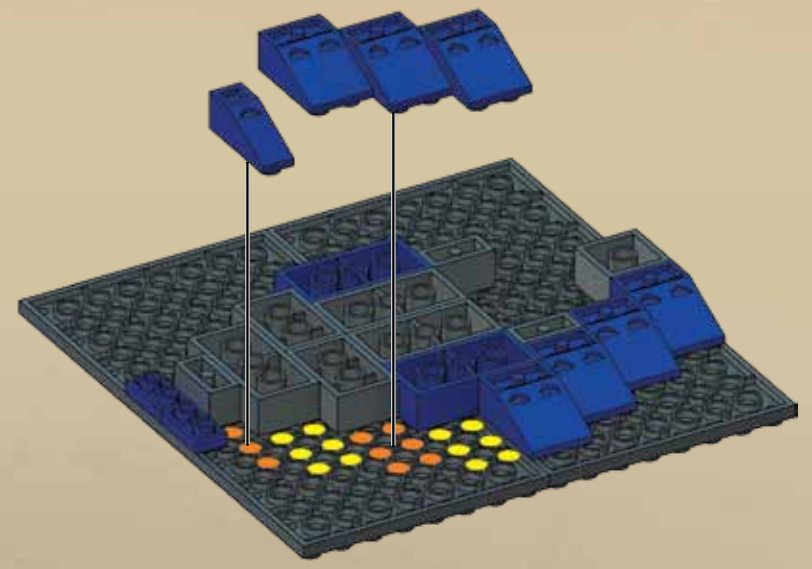

**5**

- 4X [Blue 1x2 Technic Brick]

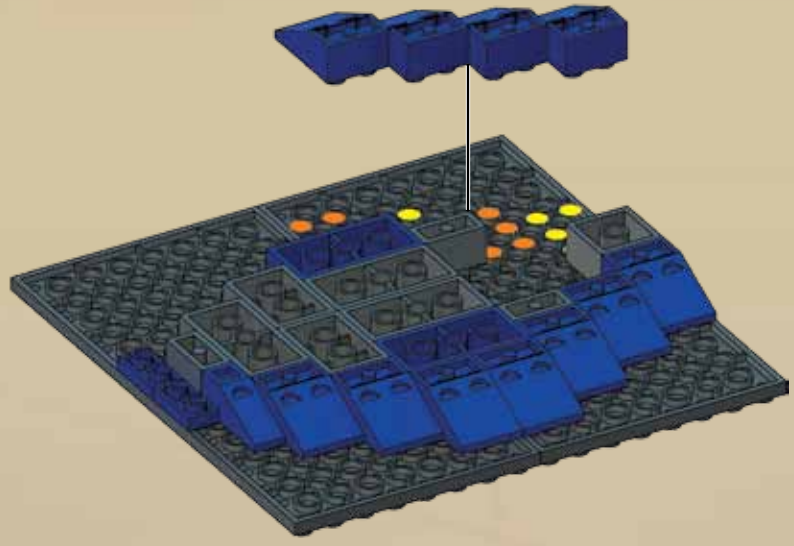

**6**

- 1X [Blue 1x2 Technic Brick]
- 3X [Blue 1x2 Technic Brick]





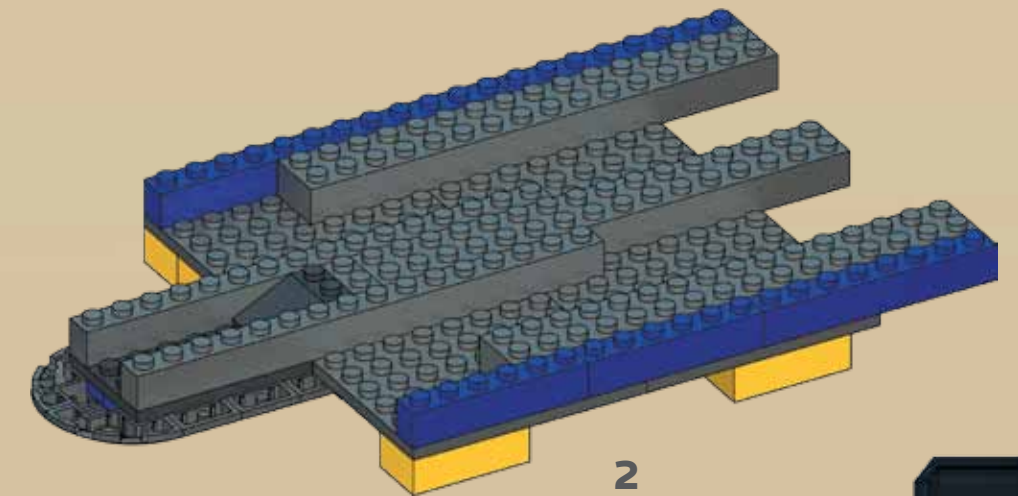
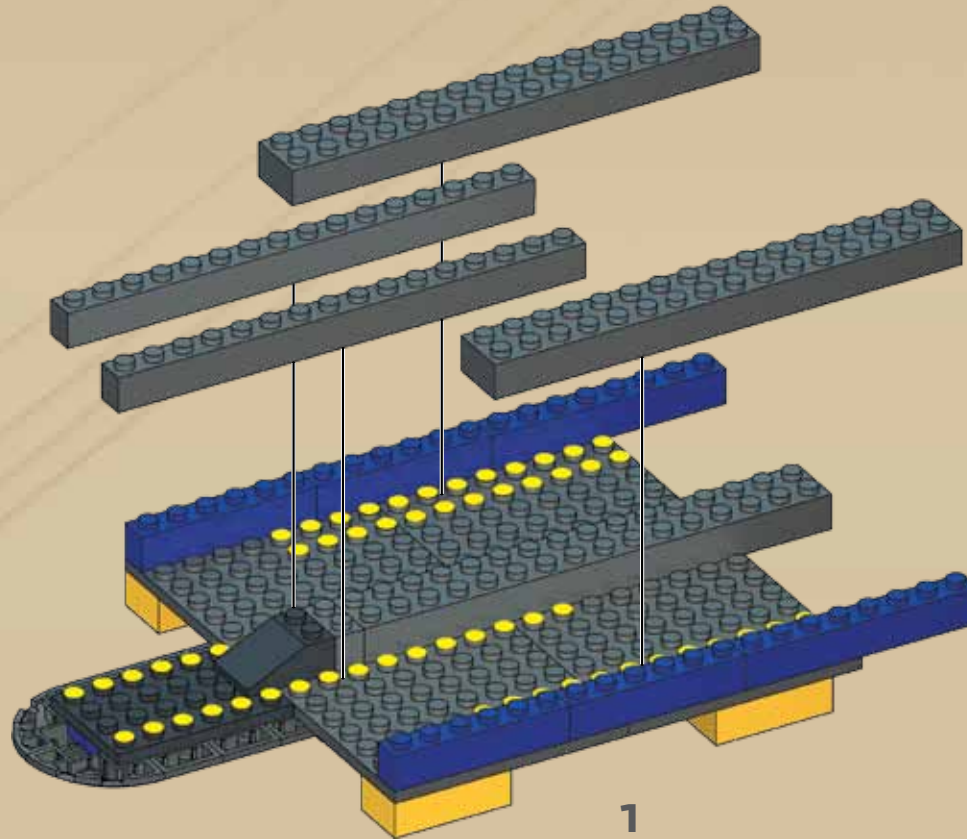
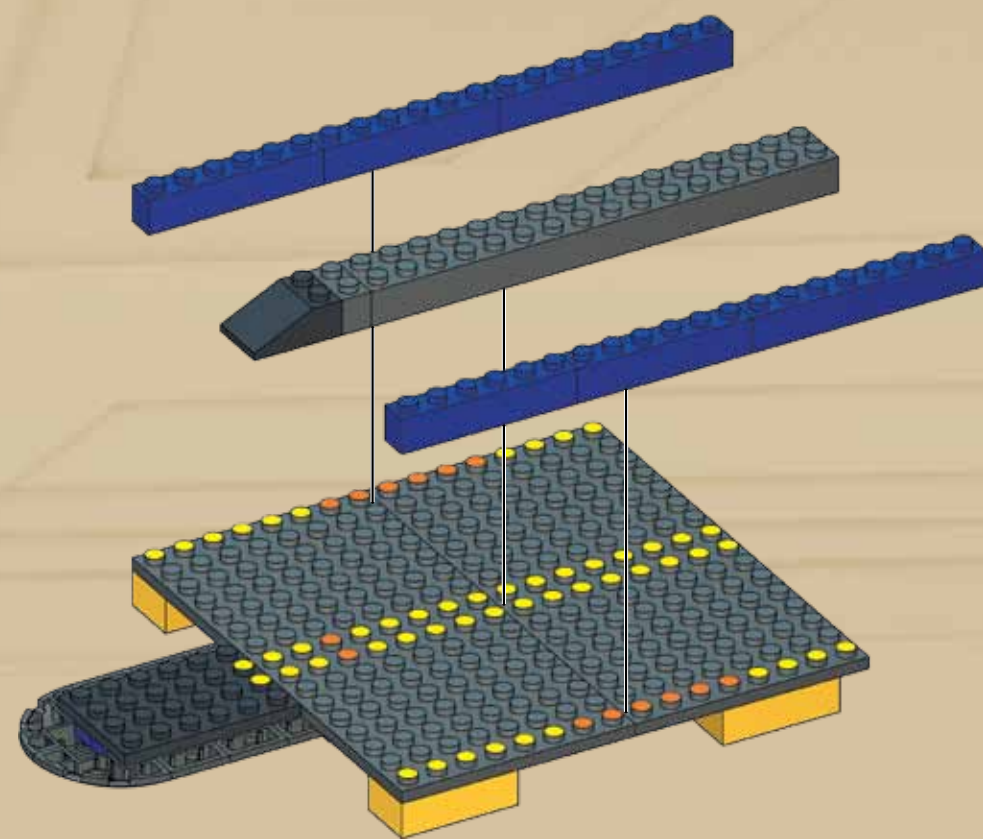
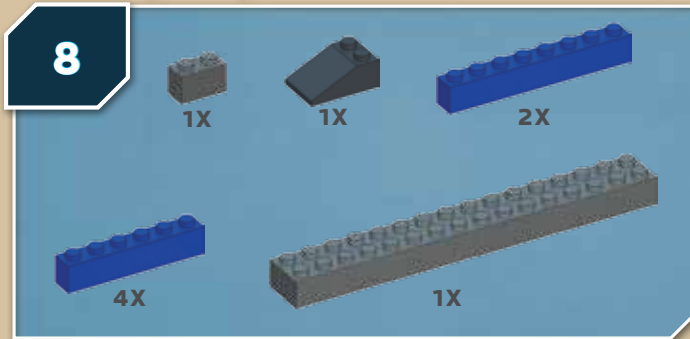
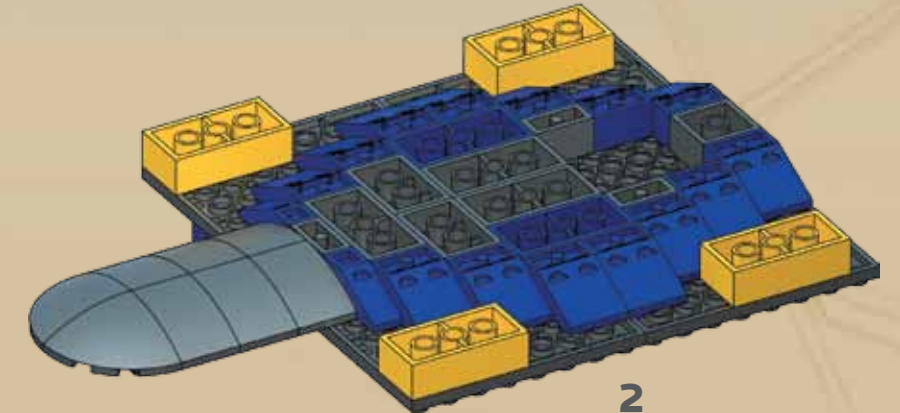
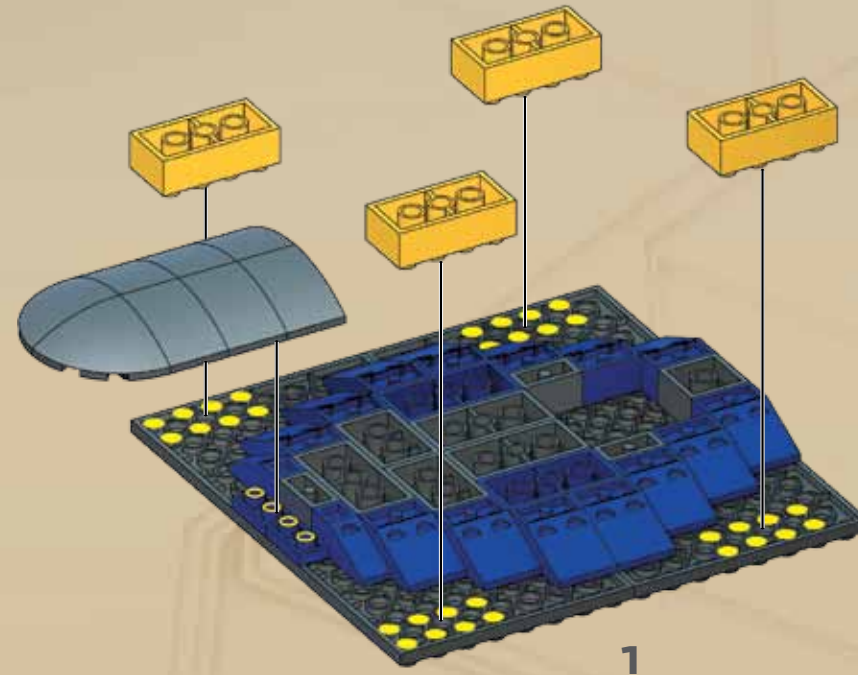
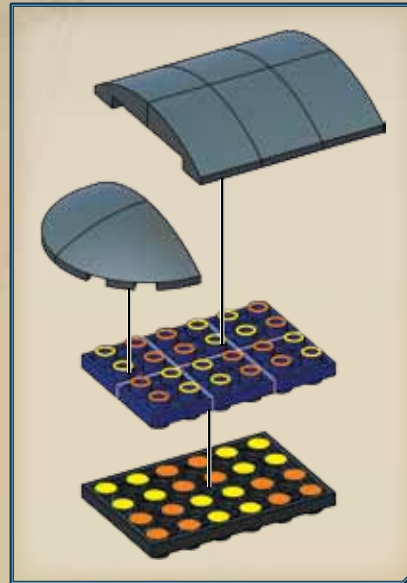



**10**

4X 2X

4X 2X

Place temporary pieces.  
 Colocar las piezas provisionales.  
 Installer les pièces temporaires.  
 Provisorische Teile einsetzen.  
 Installeer de tijdelijke onderdelen.  
 Piazzare i pezzi temporanei.  
 Colocar peças temporárias.

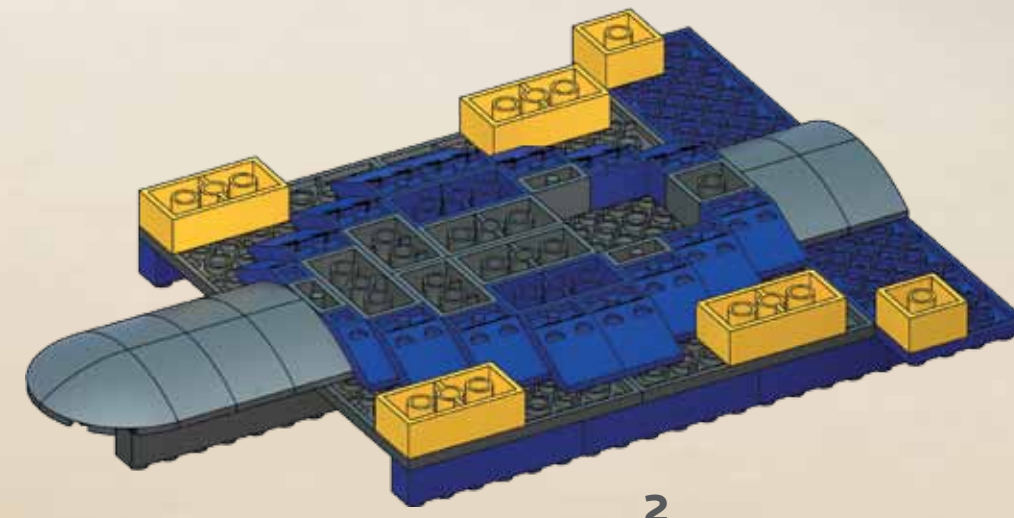
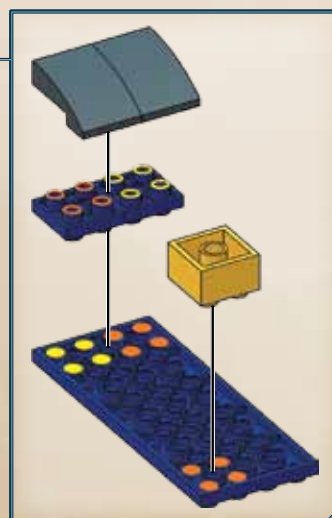
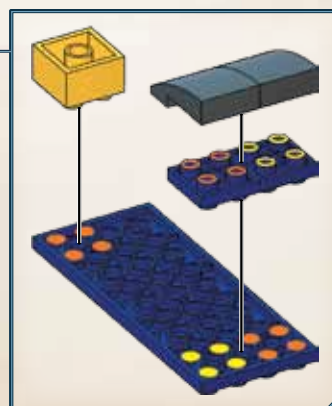
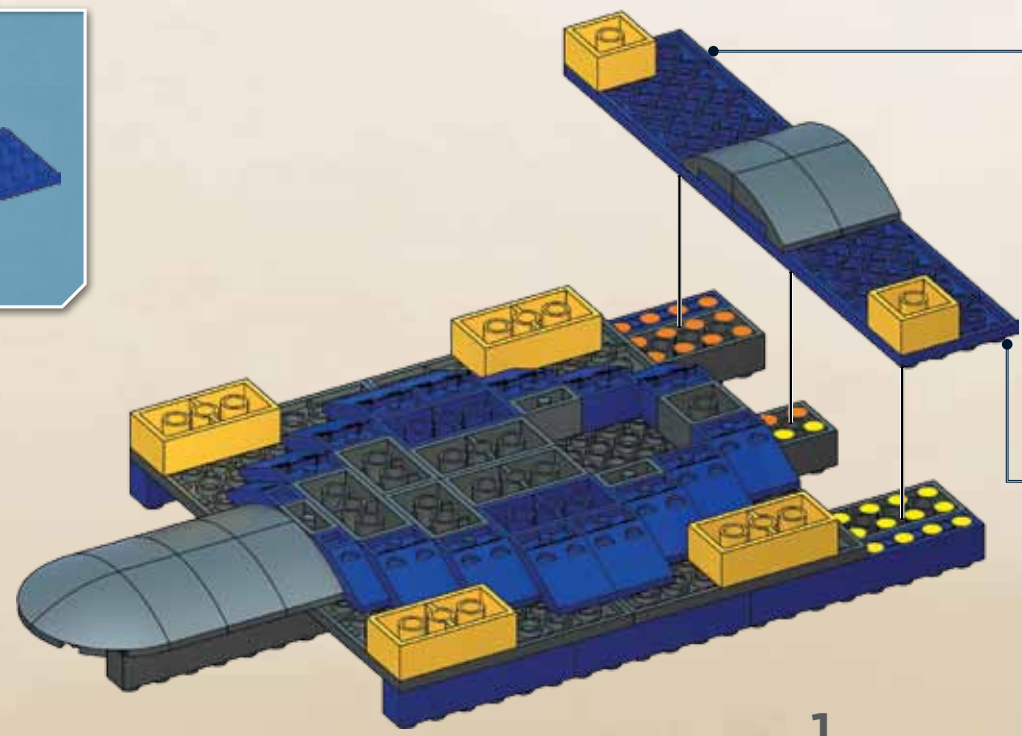

**11**

4X 4X 1X 2X

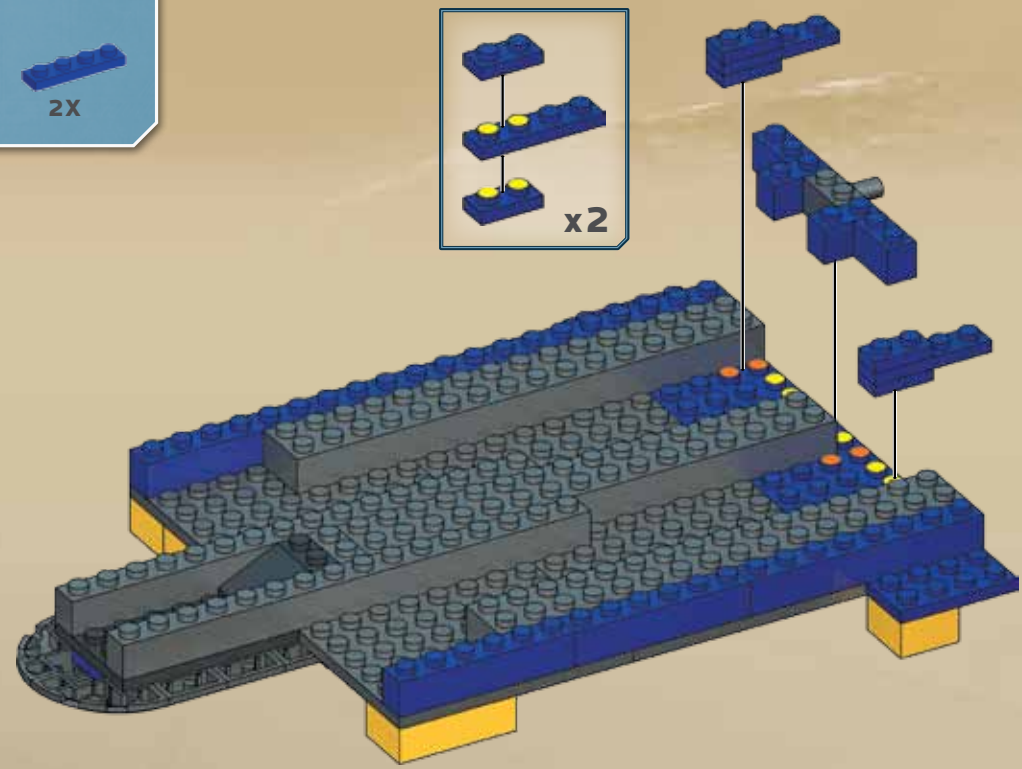
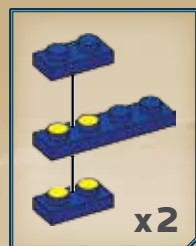

**12**

8X 2X 2X

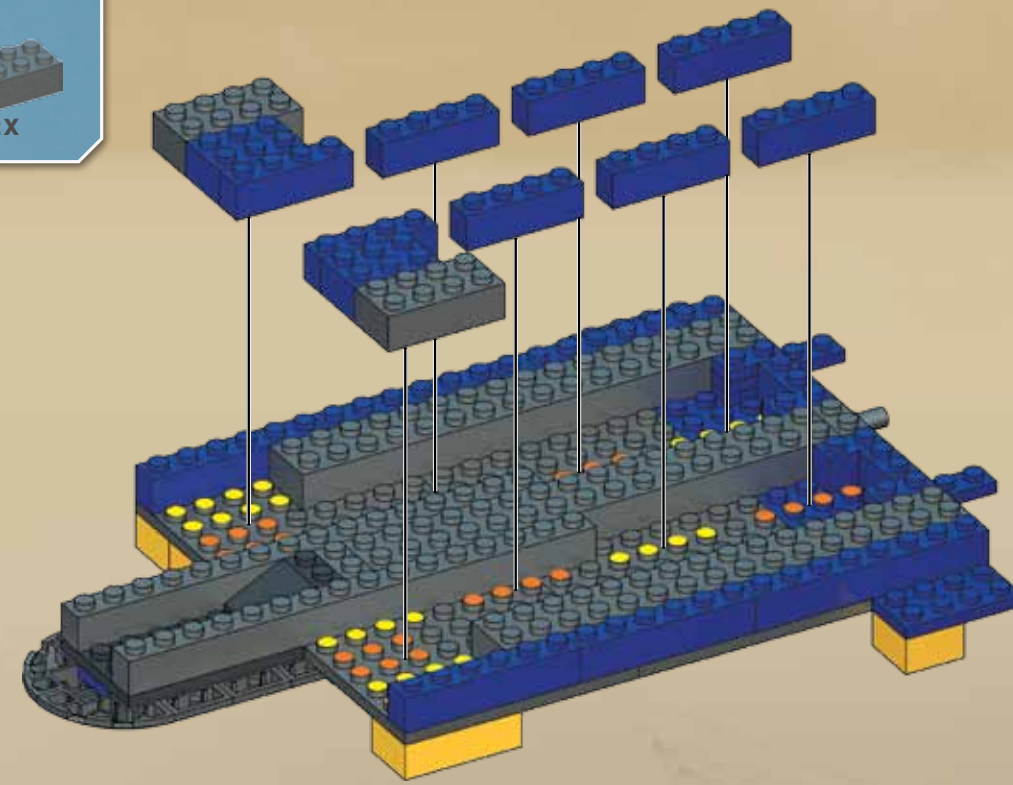



**13**

1X 4X

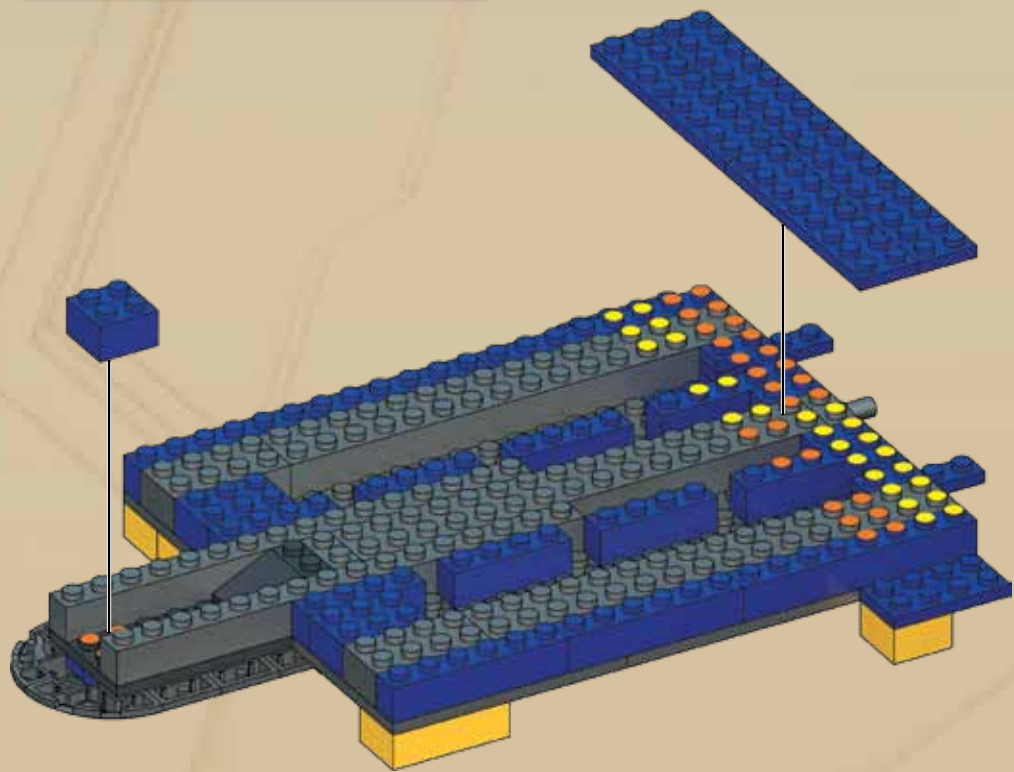

**14**

14X

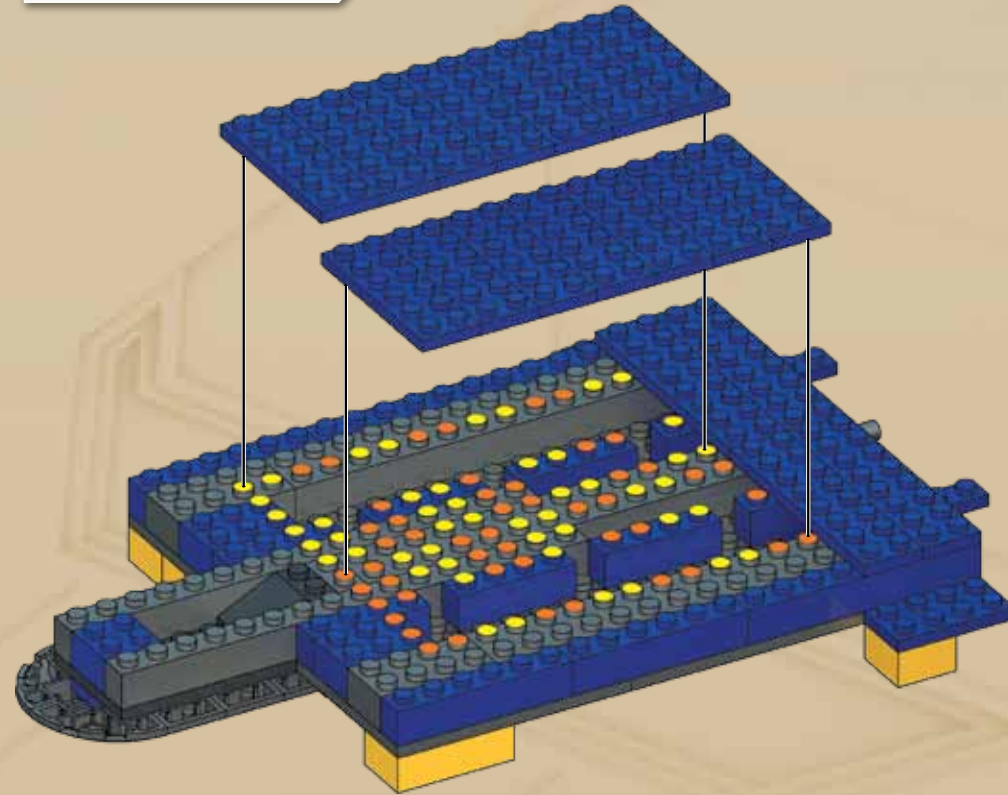

**15**

2X 14X

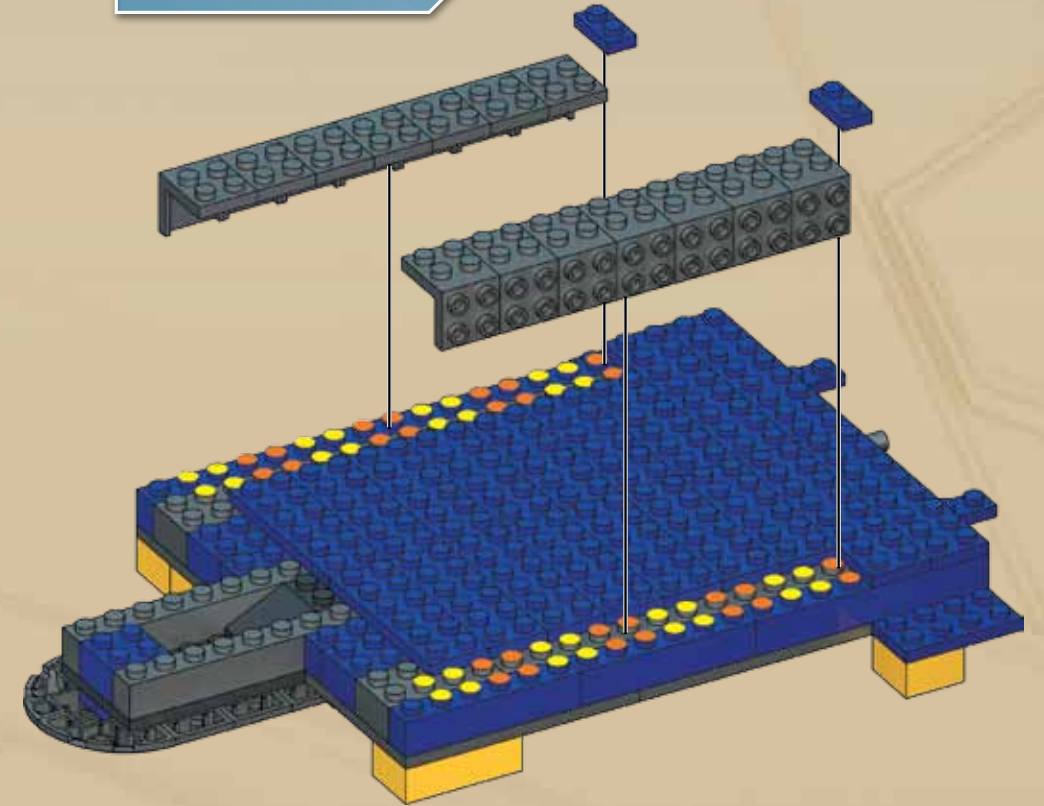

**16**

2X 6X

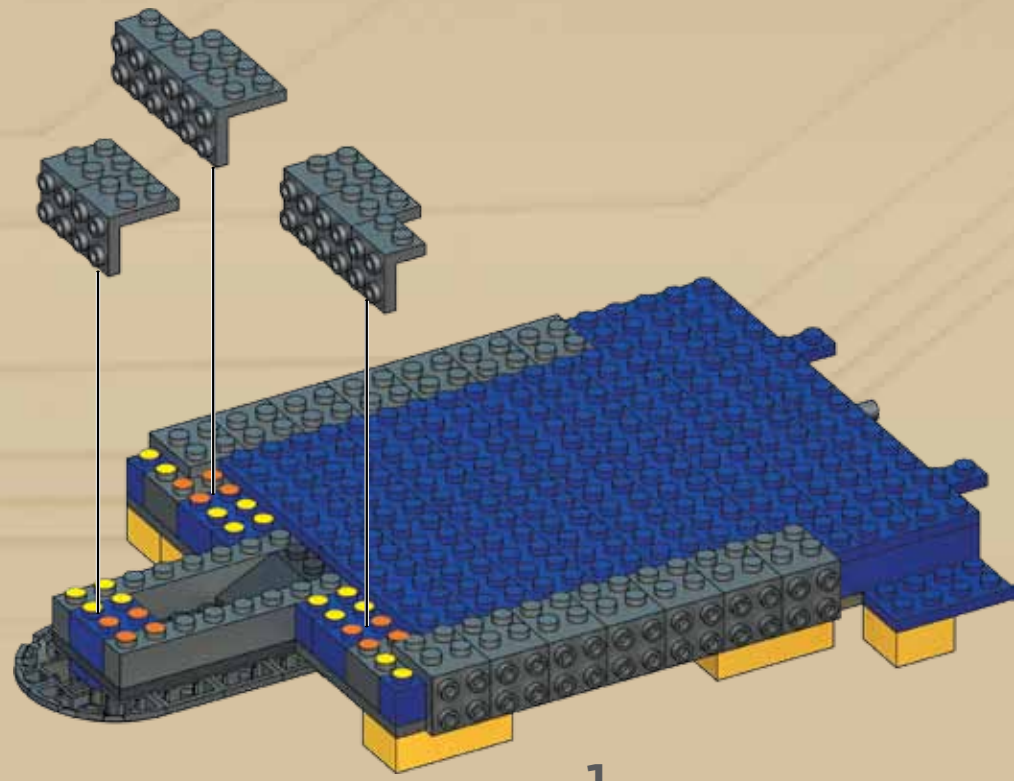

1

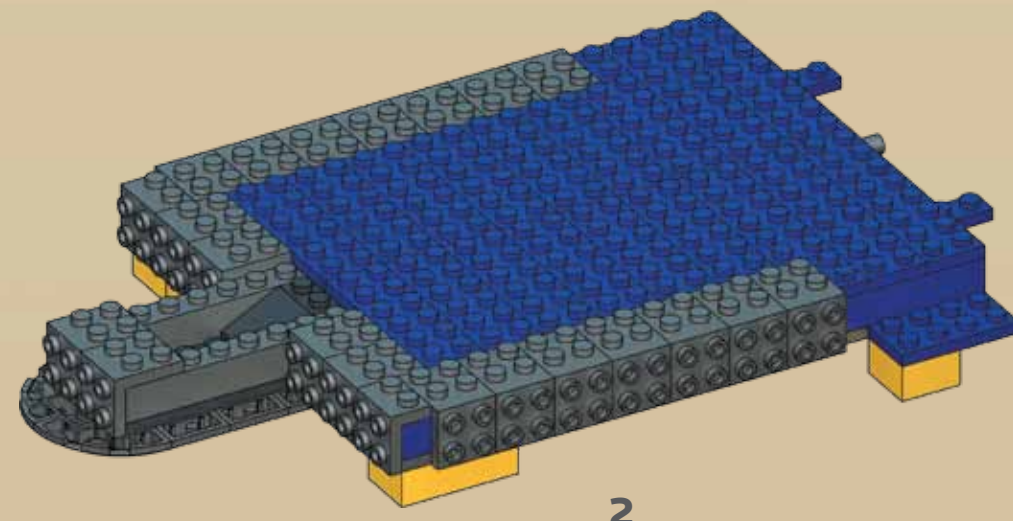

2



17

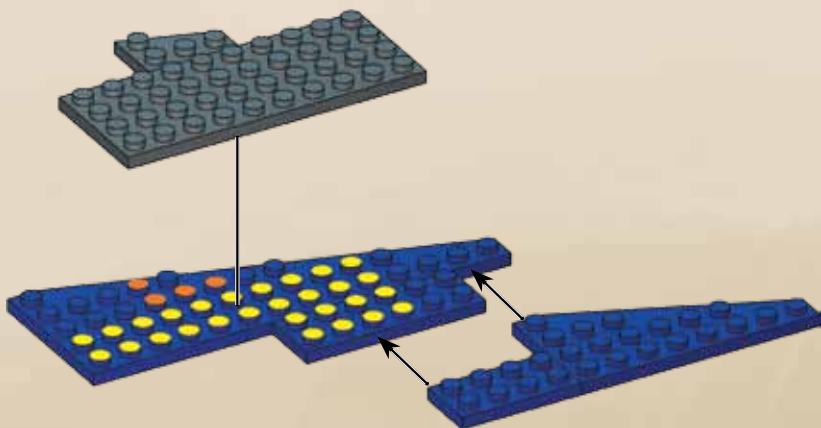
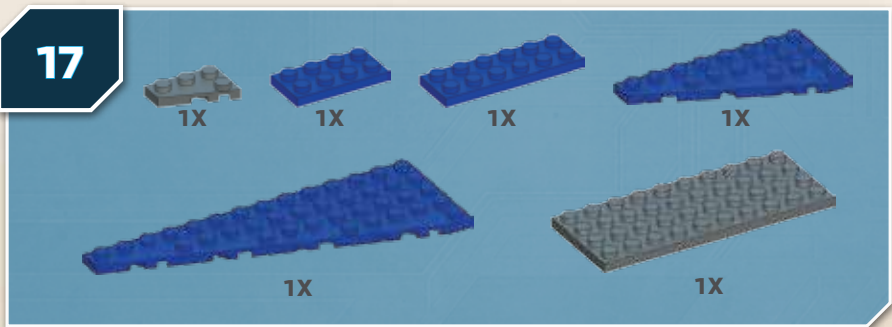

18

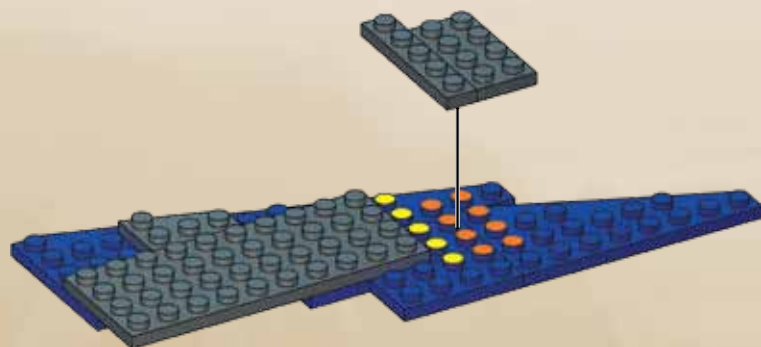

19

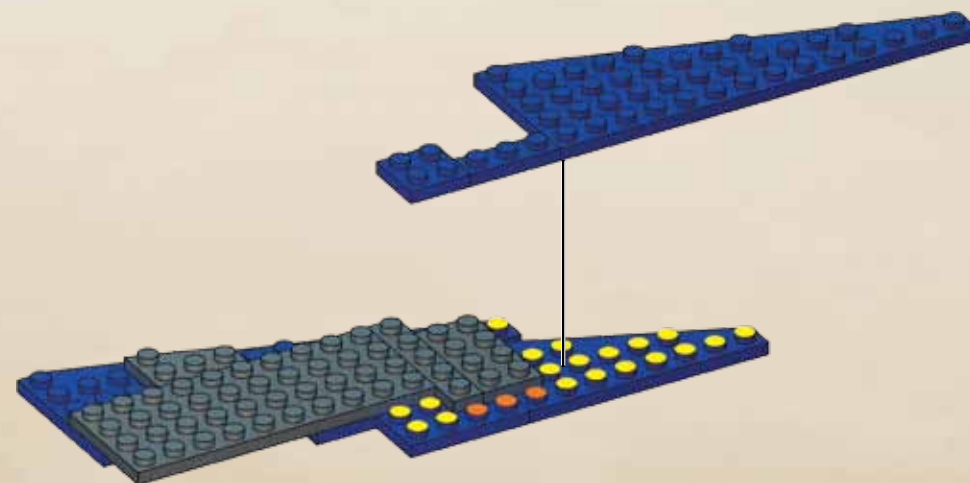

20

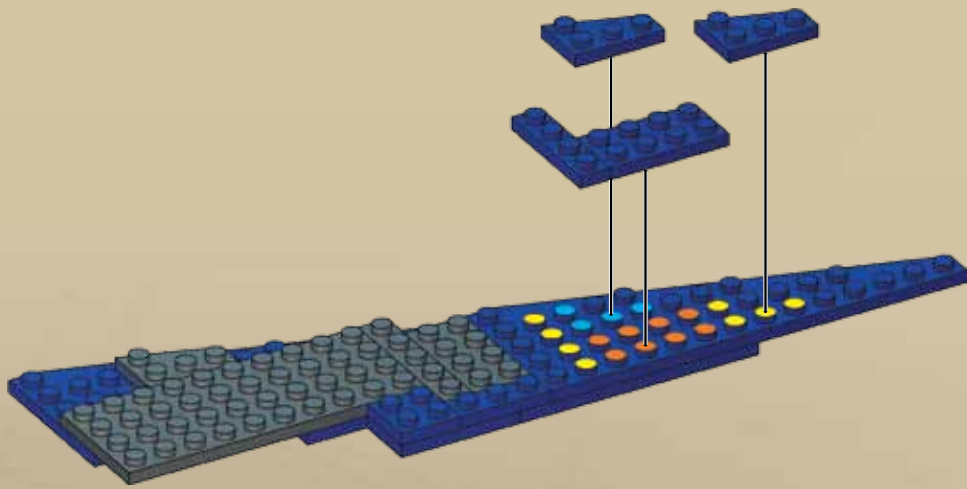

21

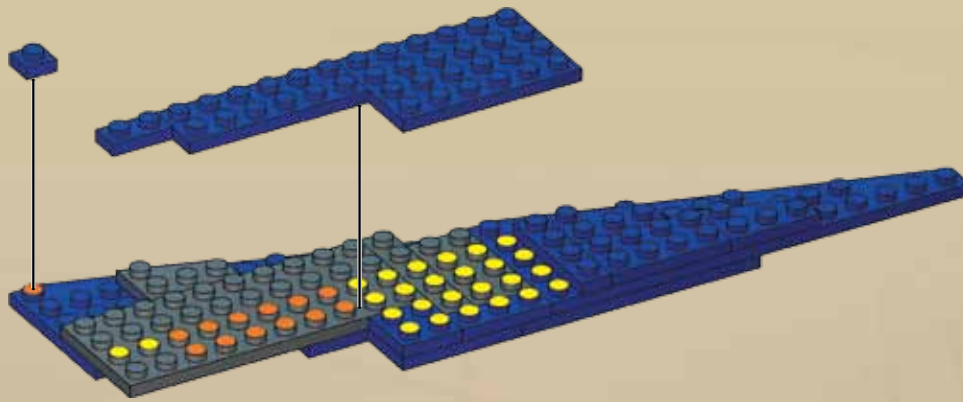
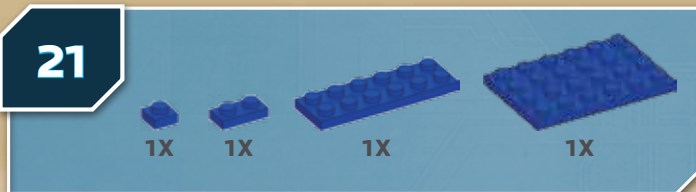

22

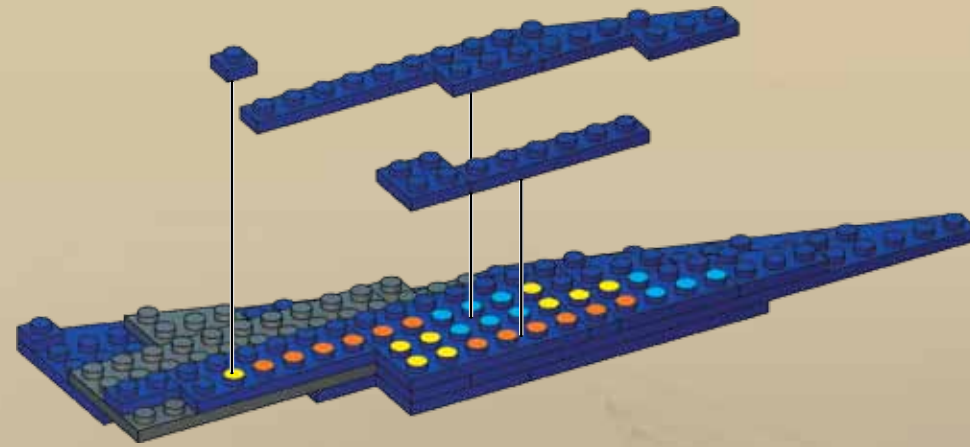



**23**

1X 1X

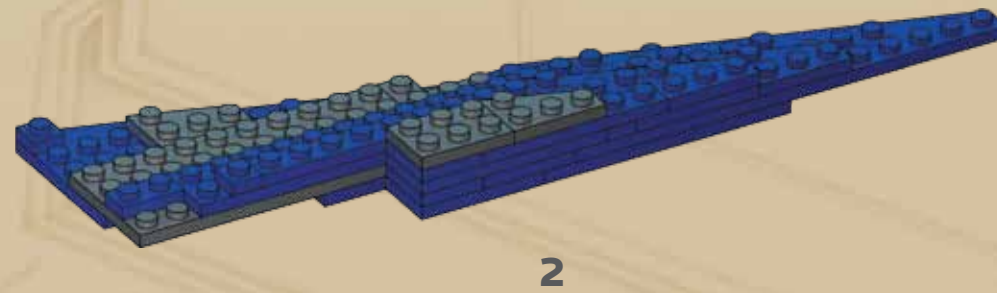
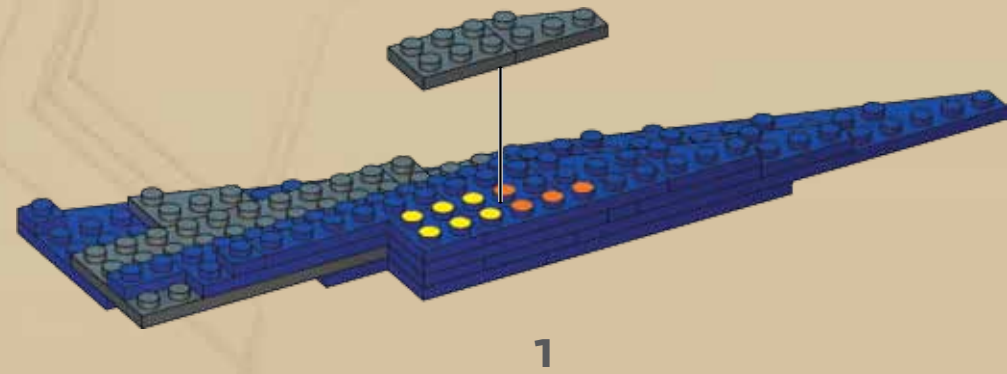

**24**

3X 1X

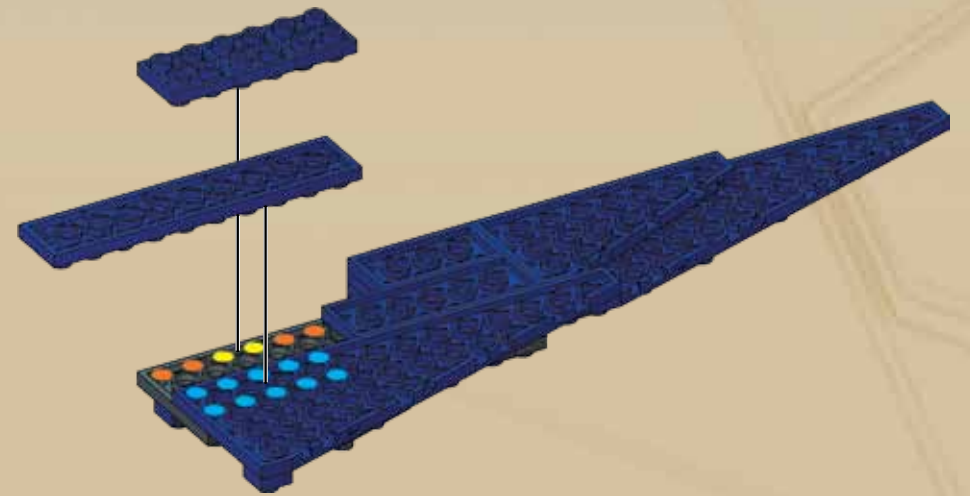

**25**

2X

Place temporary pieces.  
 Colocar las piezas provisionales.  
 Installer les pièces temporaires.  
 Provisorische Teile einsetzen.  
 Instaleer de tijdelijke onderdelen.  
 Piazzare i pezzi temporanei.  
 Colocar peças temporárias.

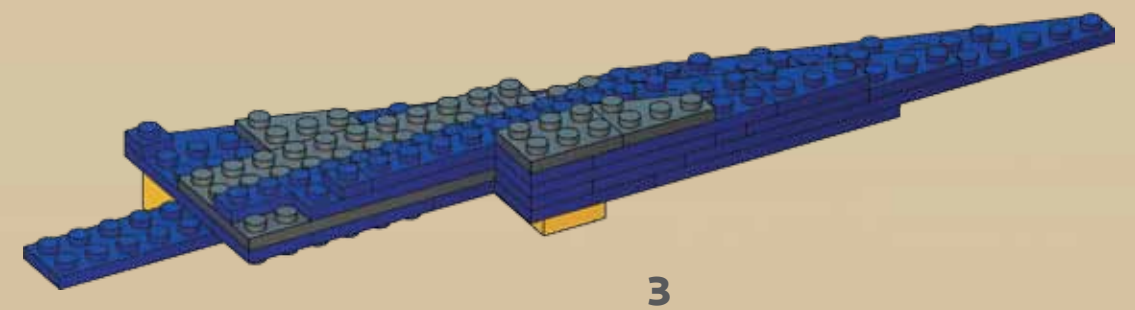
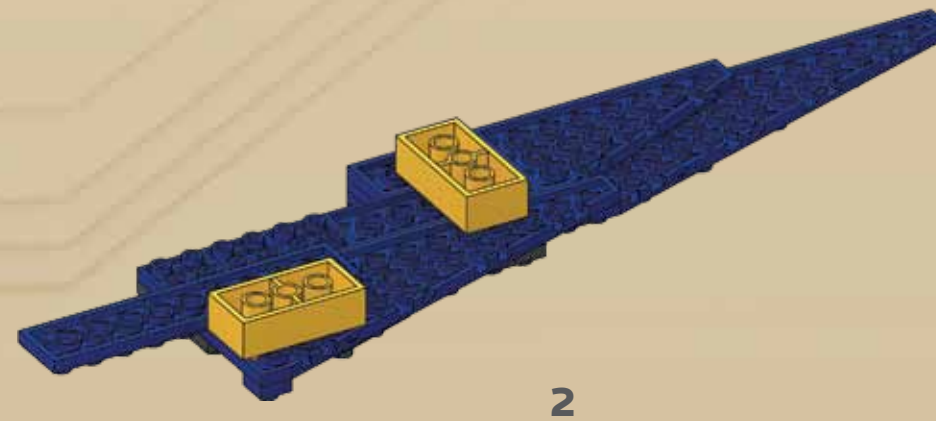
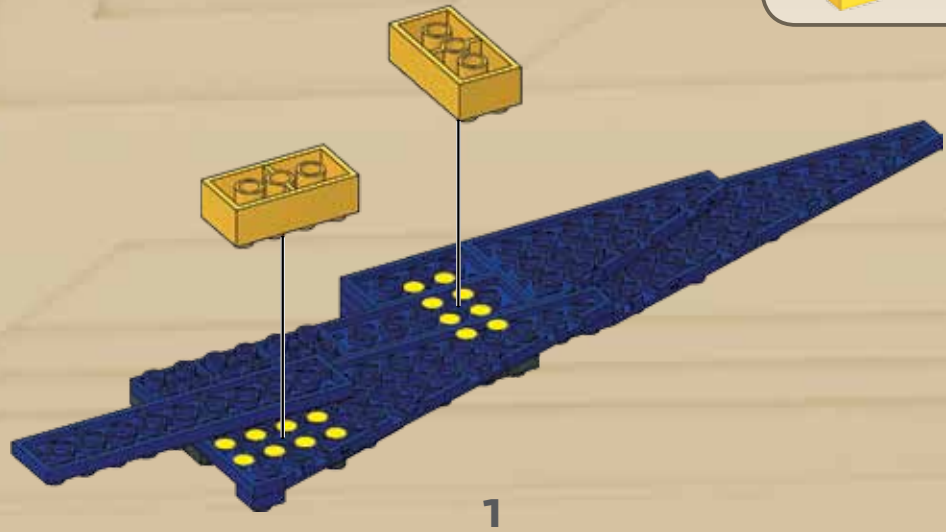



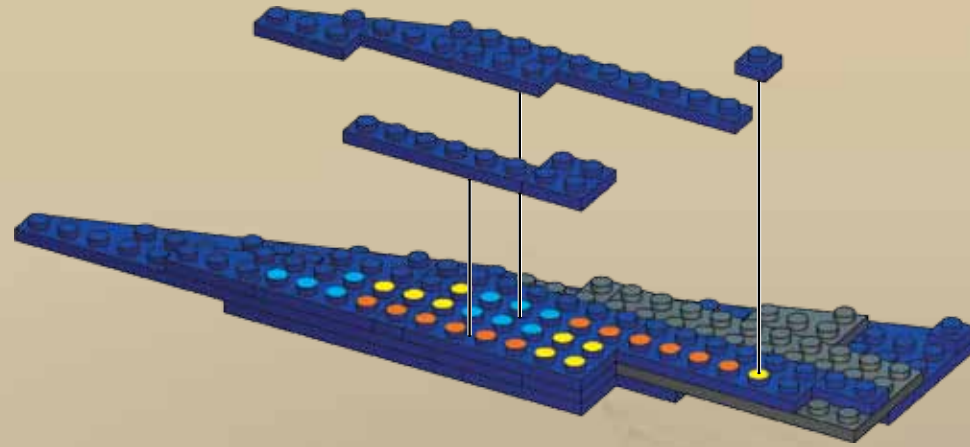
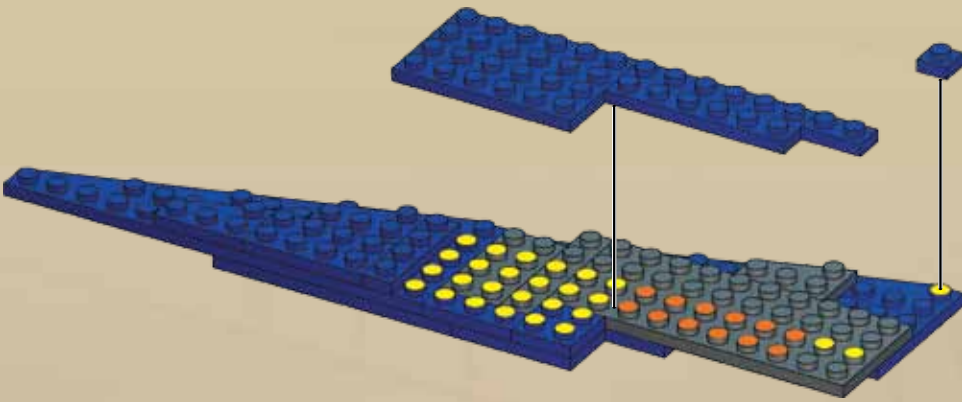
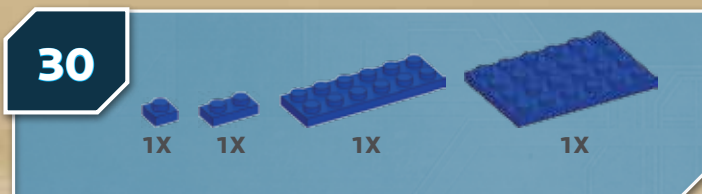
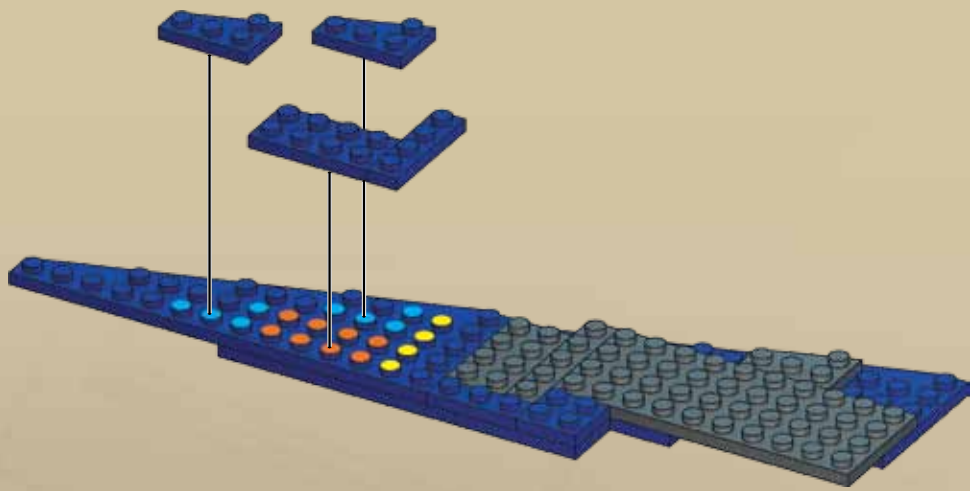
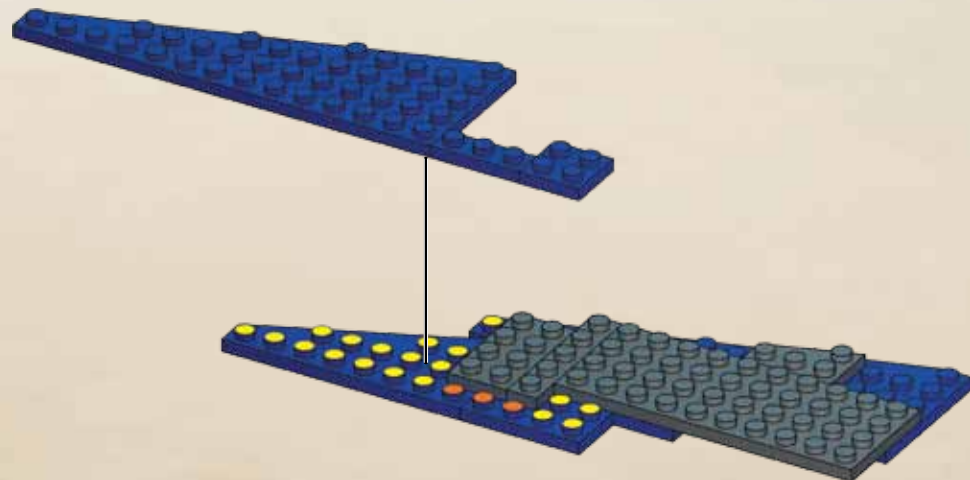
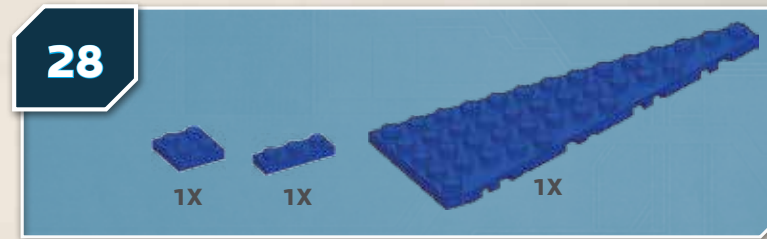
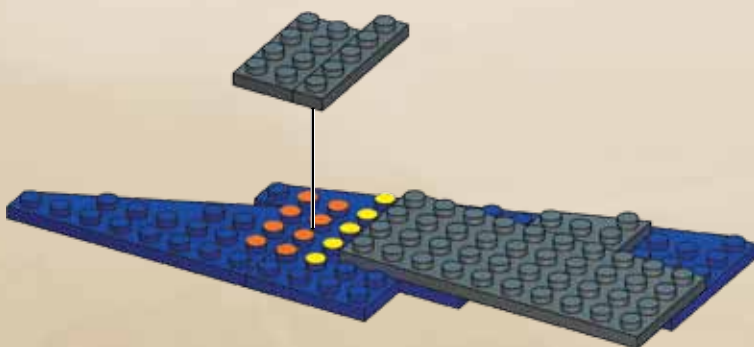
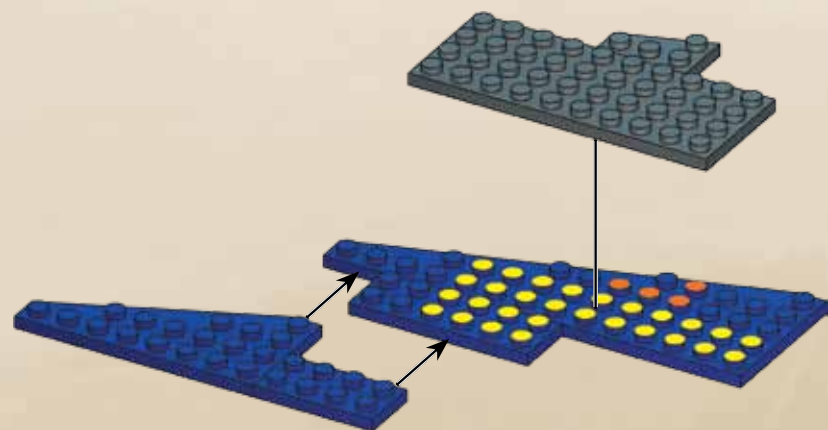
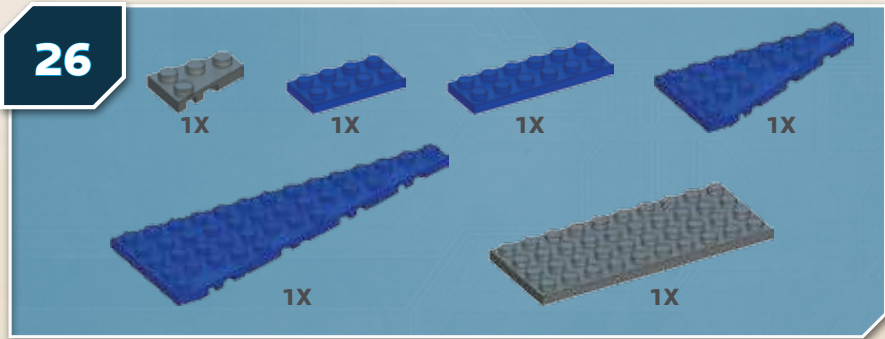





**32**

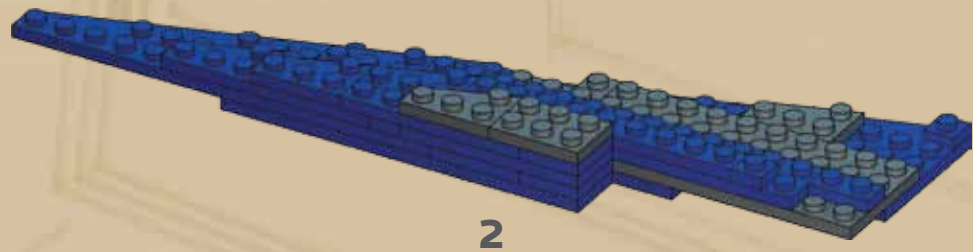
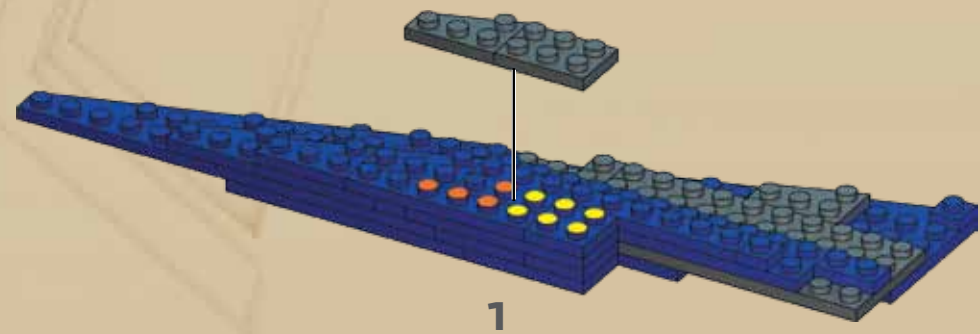

1X 1X



**33**



3X 1X

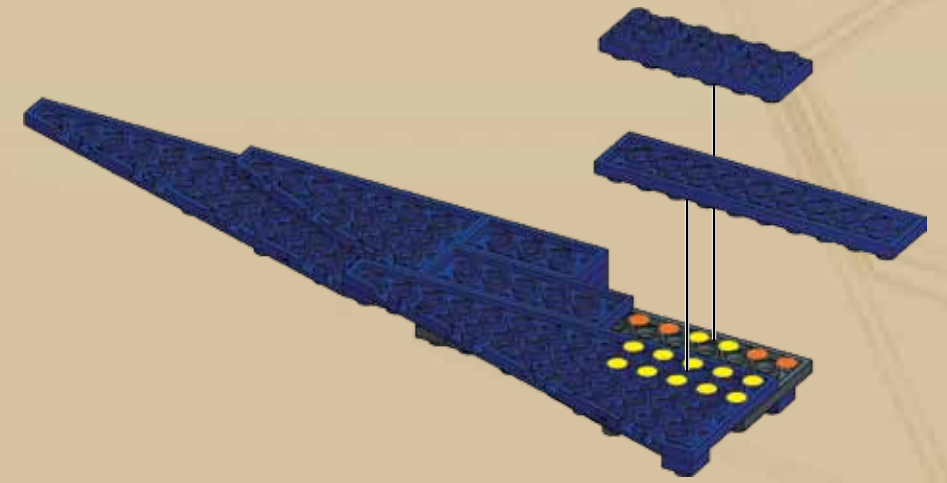

**34**



2X

Place temporary pieces.  
 Colocar las piezas provisionales.  
 Installer les pièces temporaires.  
 Provisorische Teile einsetzen.  
 Instaleer de tijdelijke onderdelen.  
 Piazzare i pezzi temporanei.  
 Colocar peças temporárias.

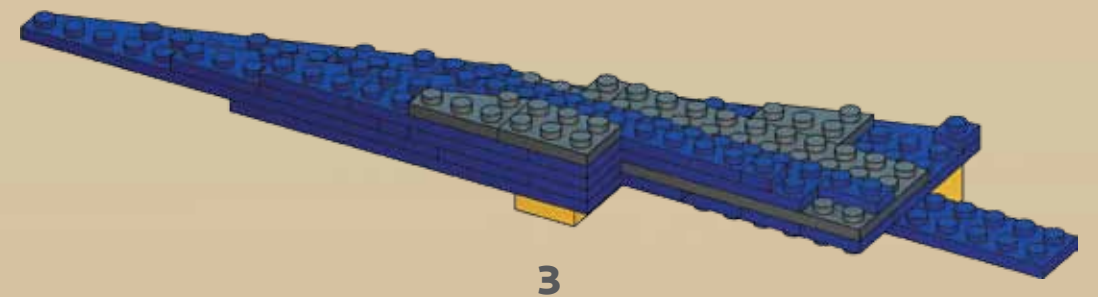
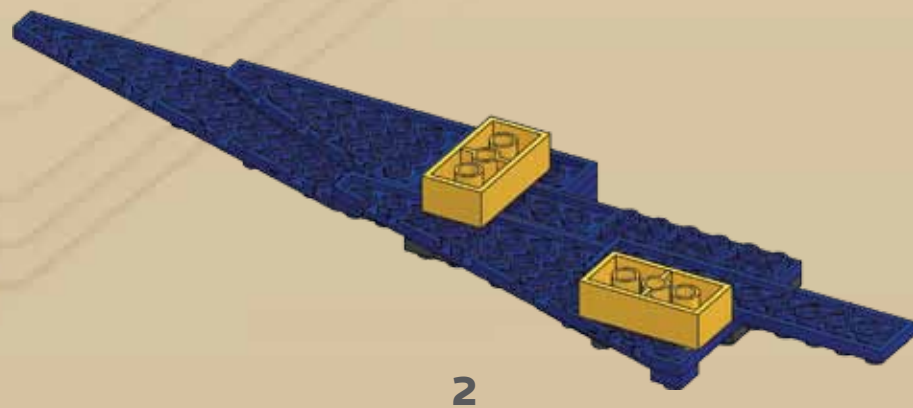
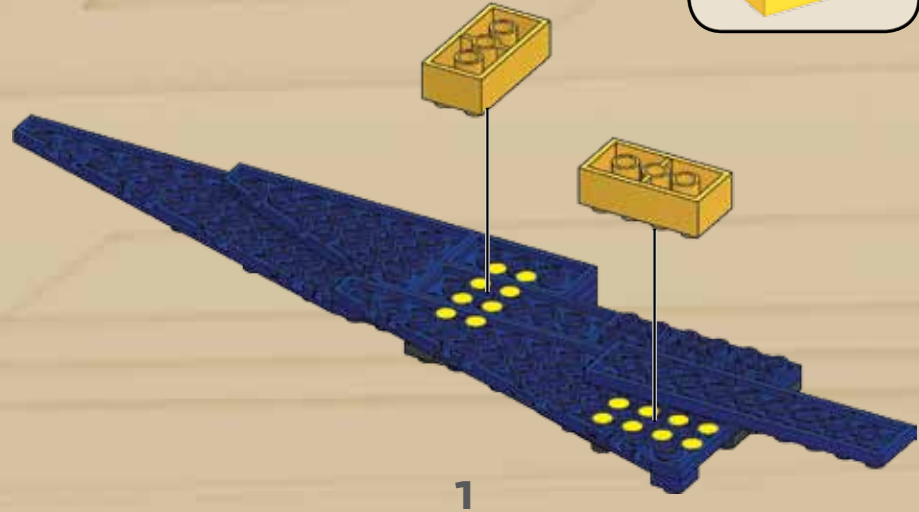



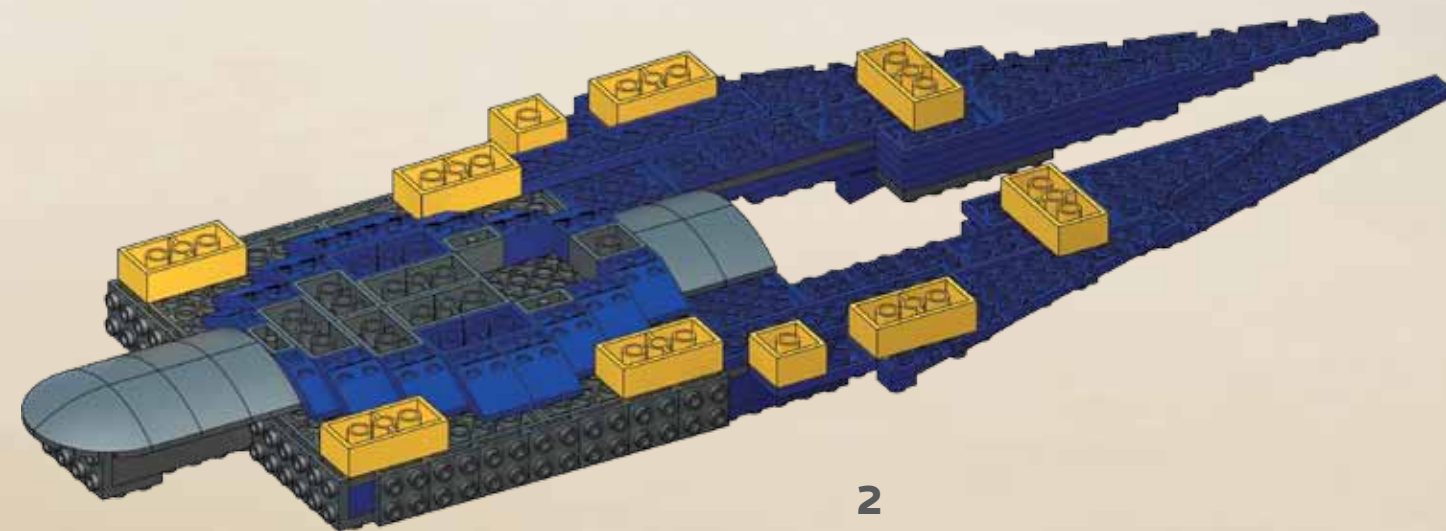
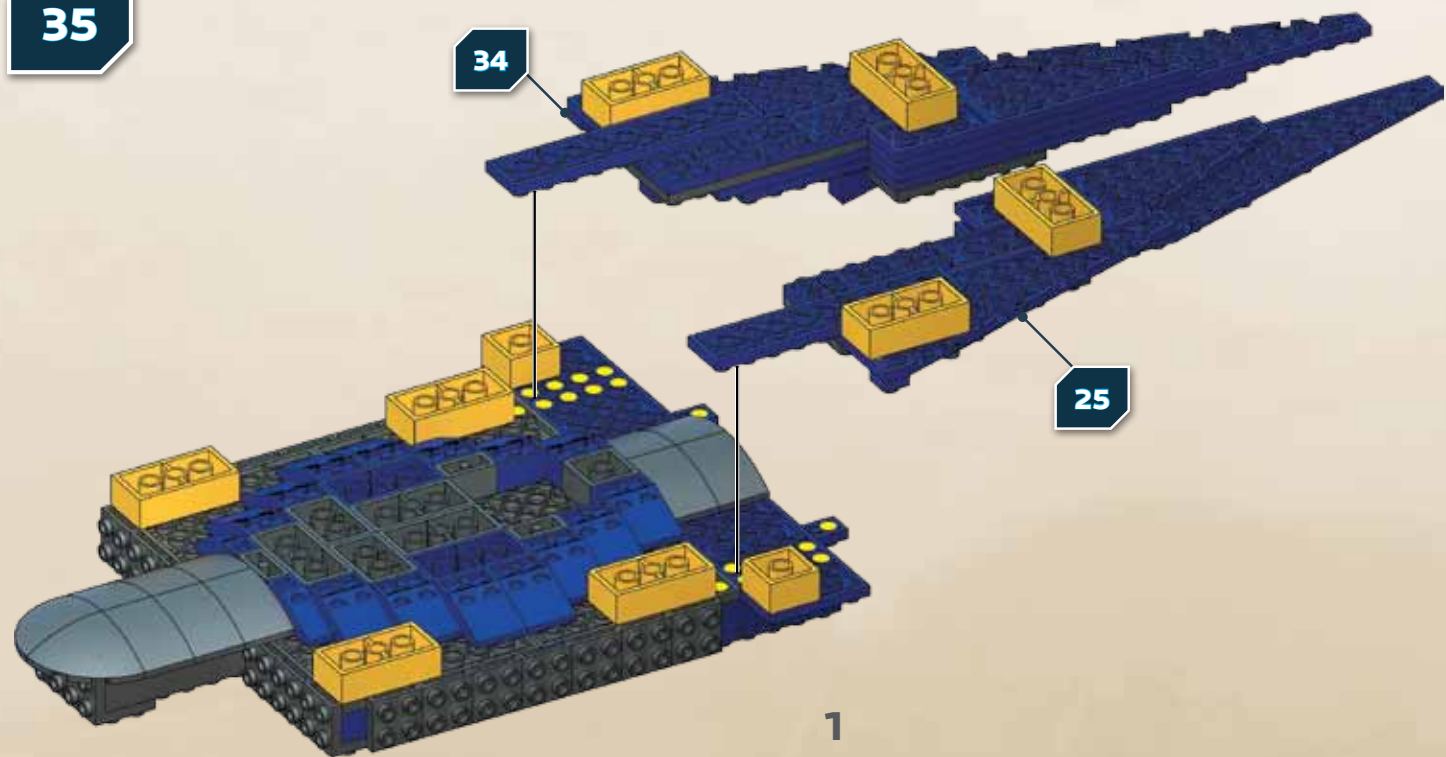

35

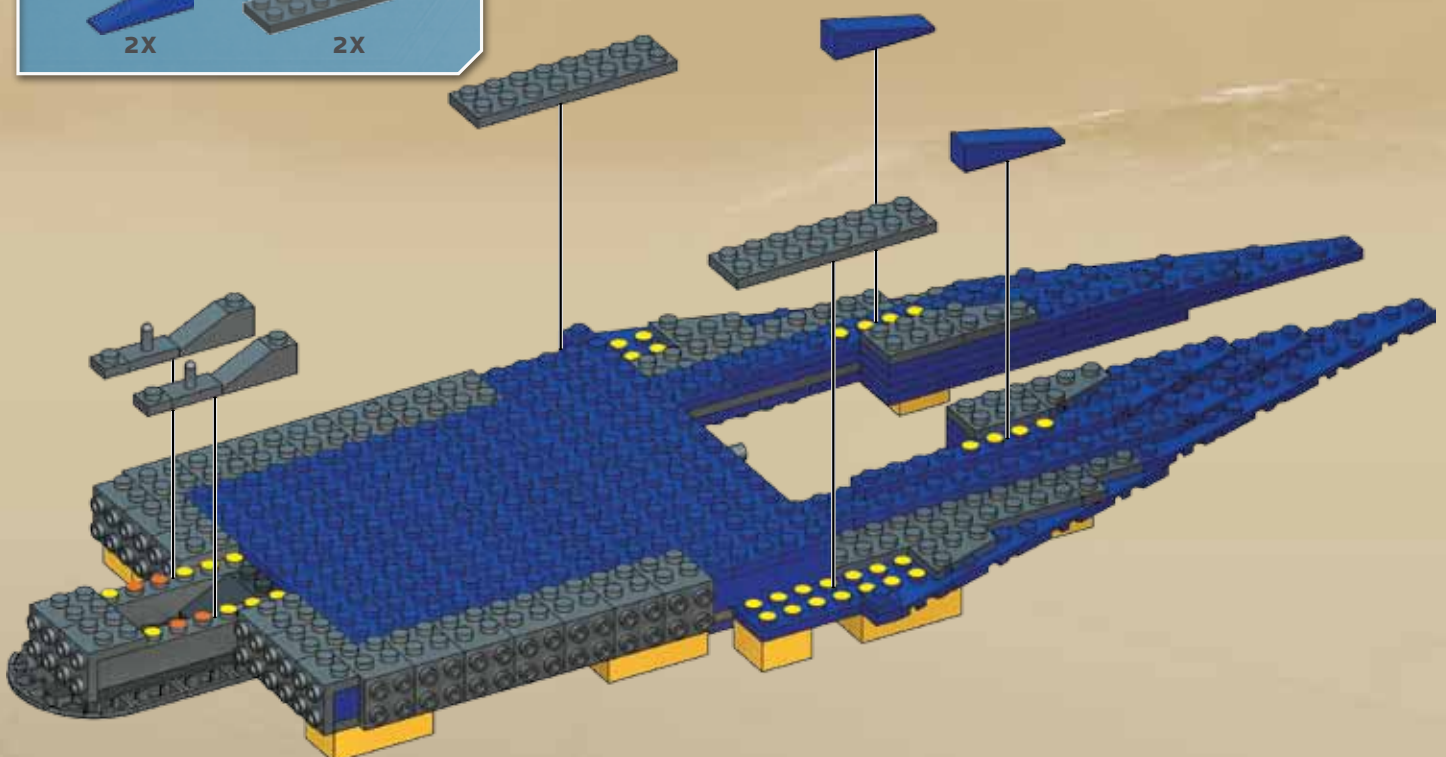
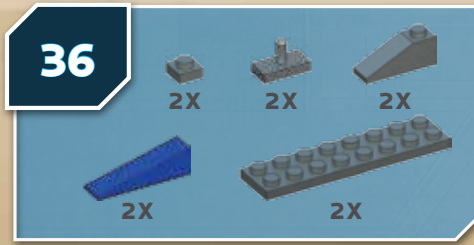

36



37

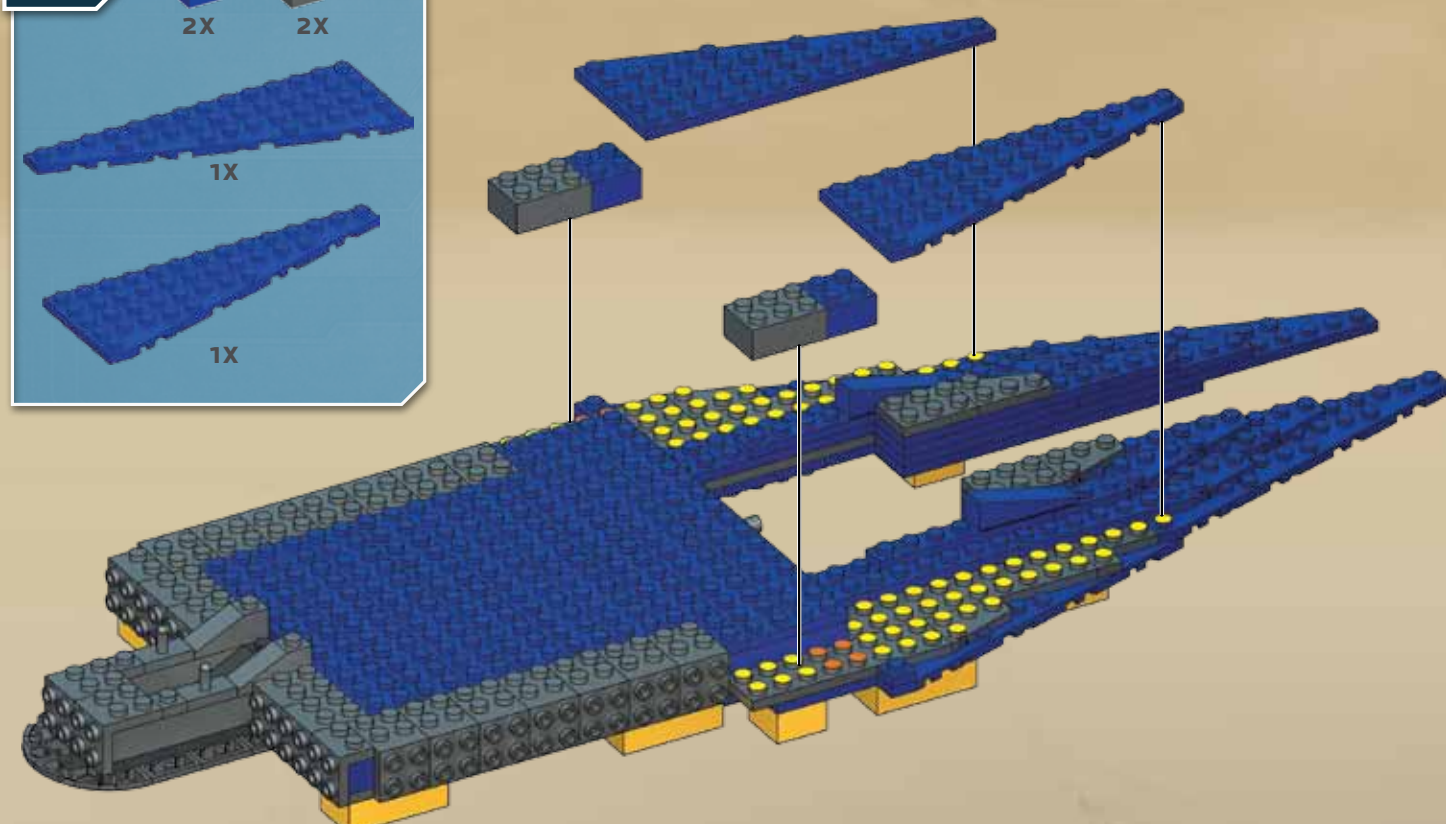
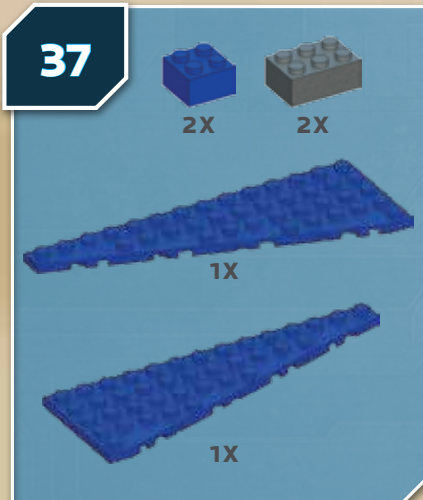



38

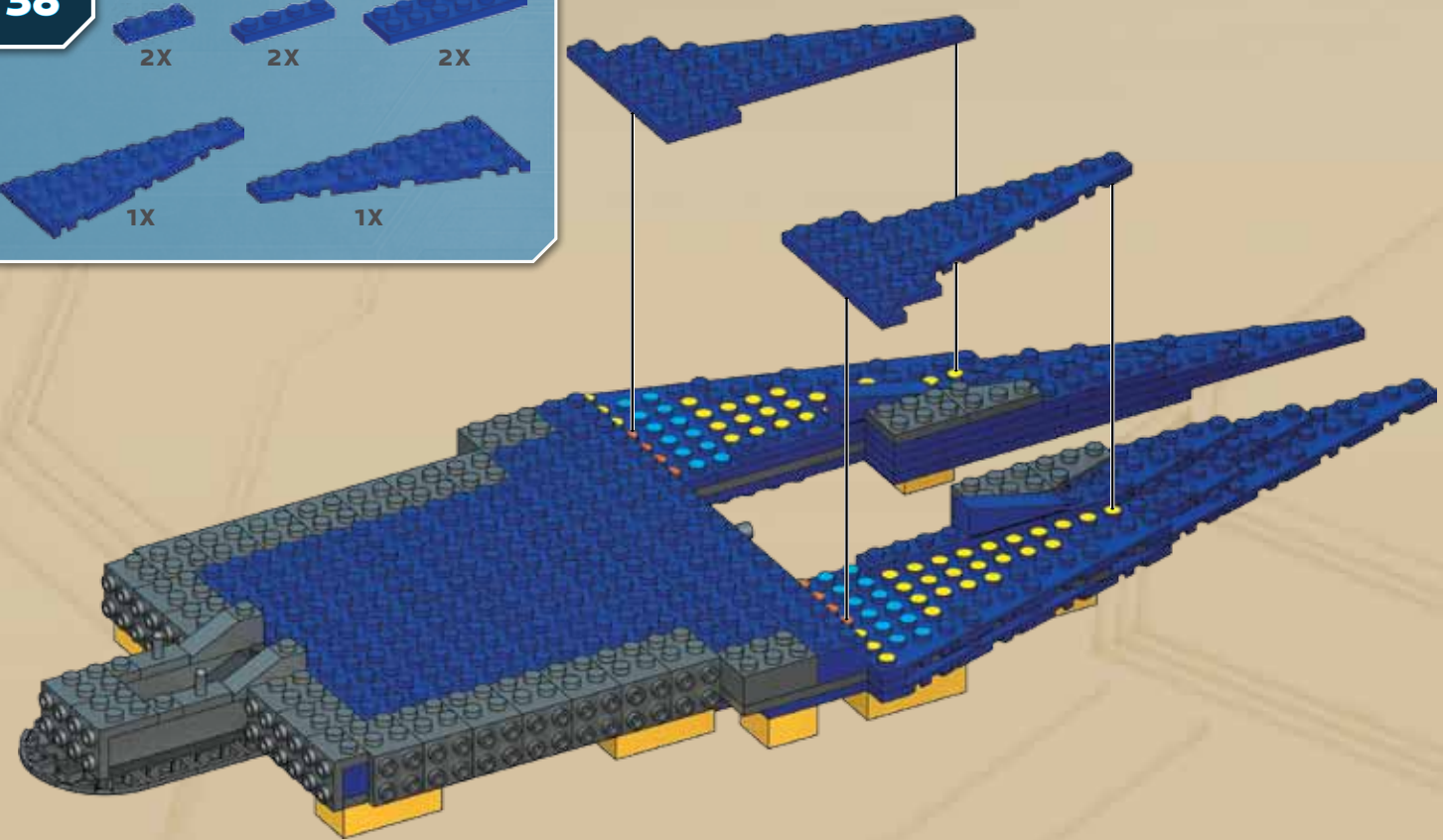
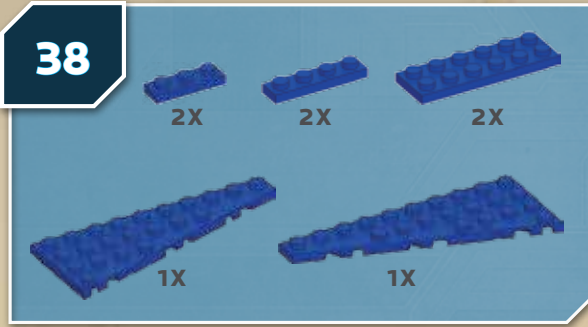

39

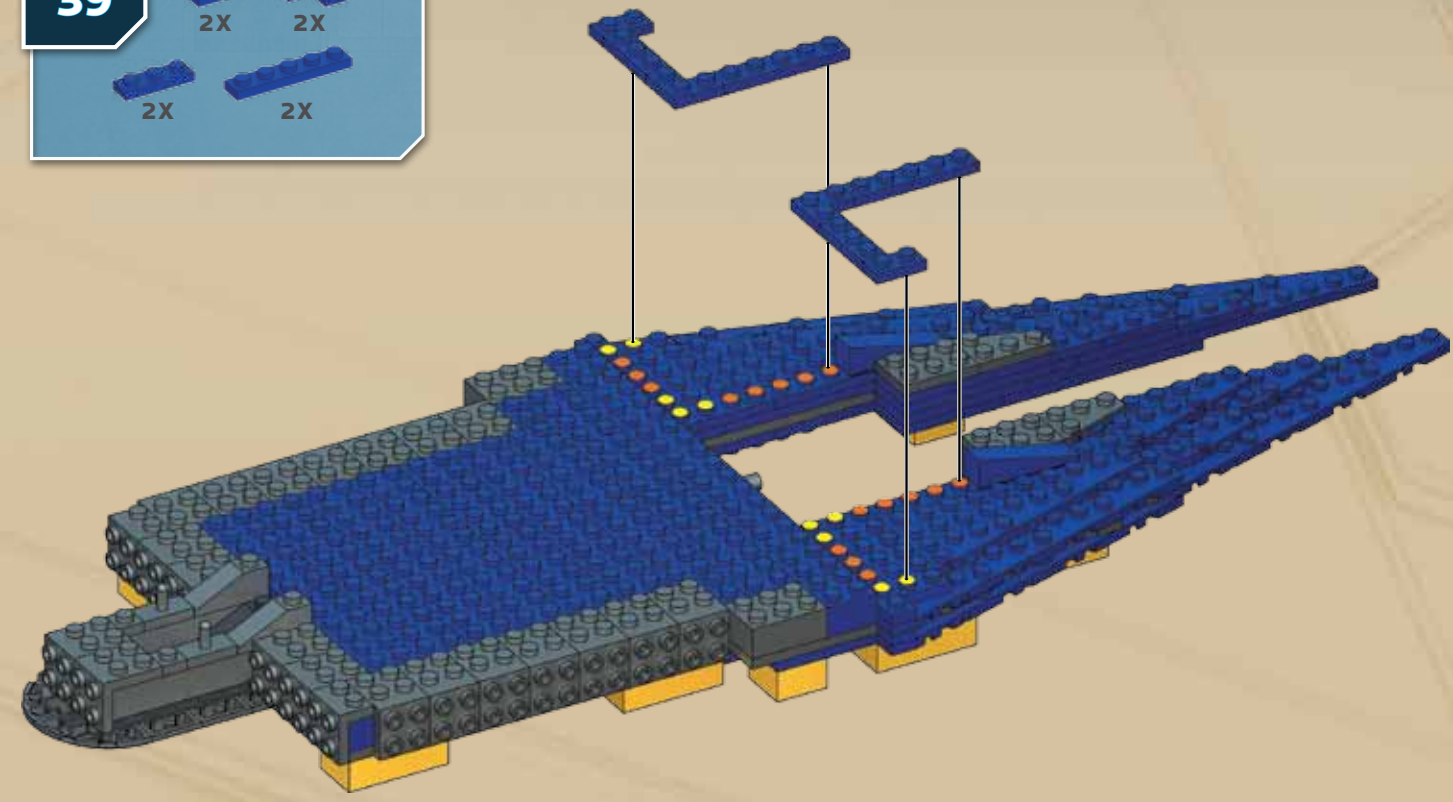

40

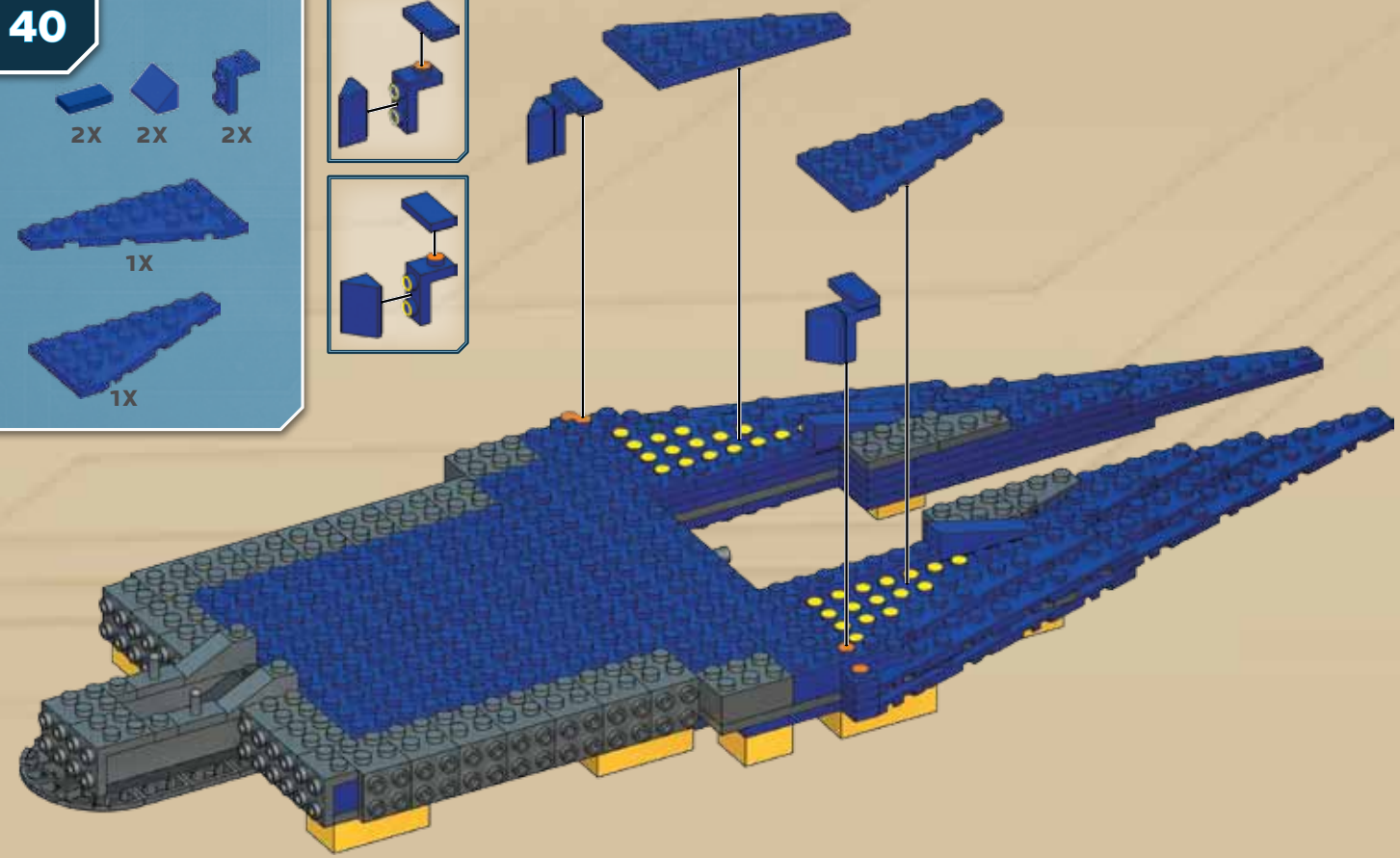

41

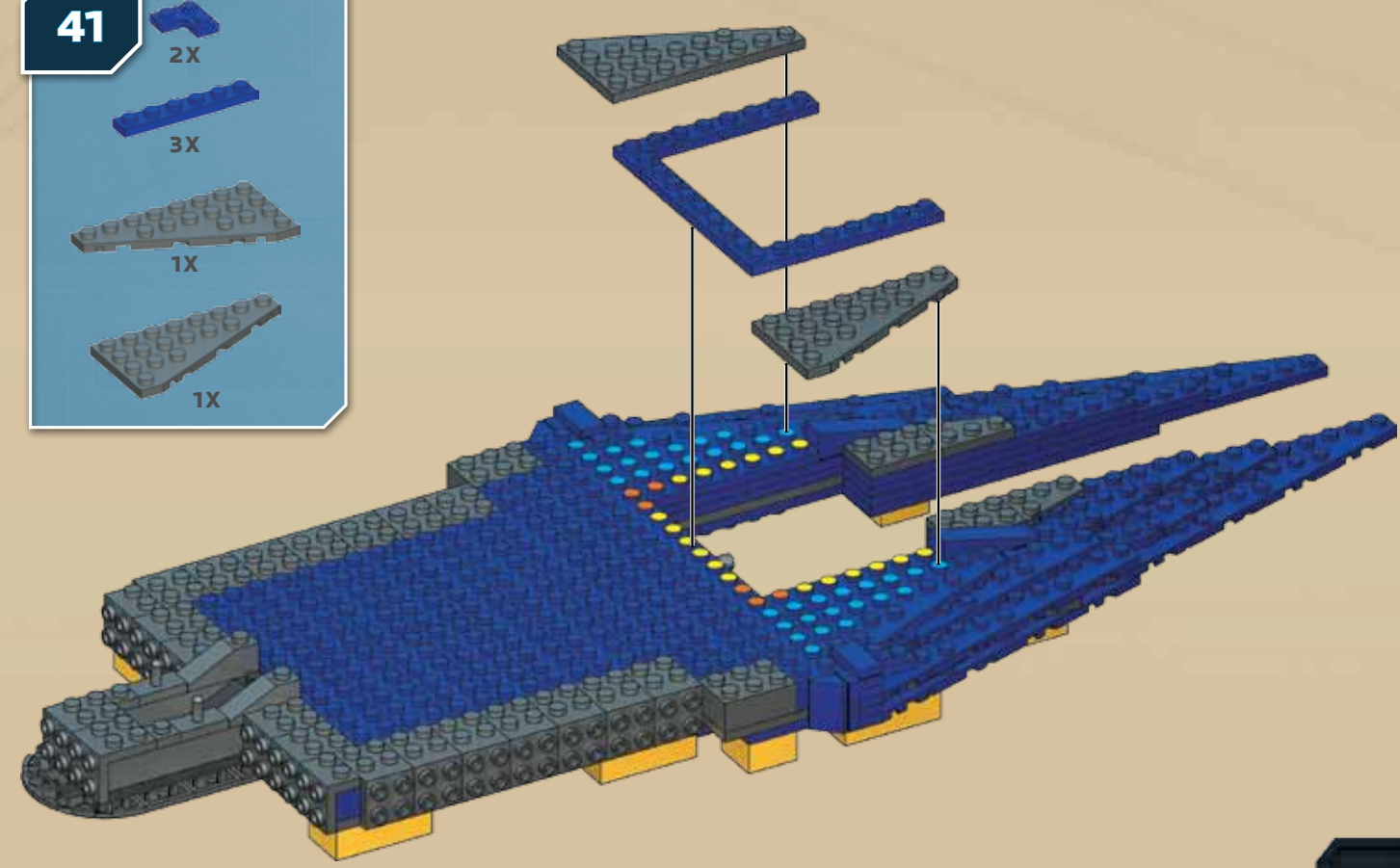



42

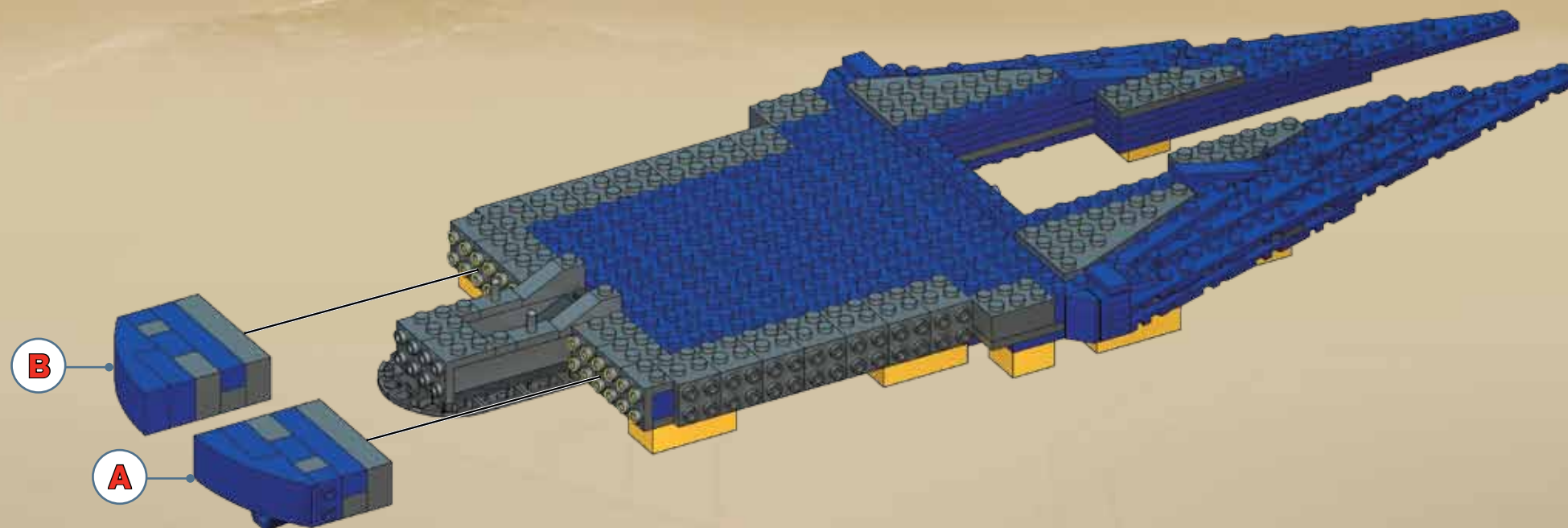
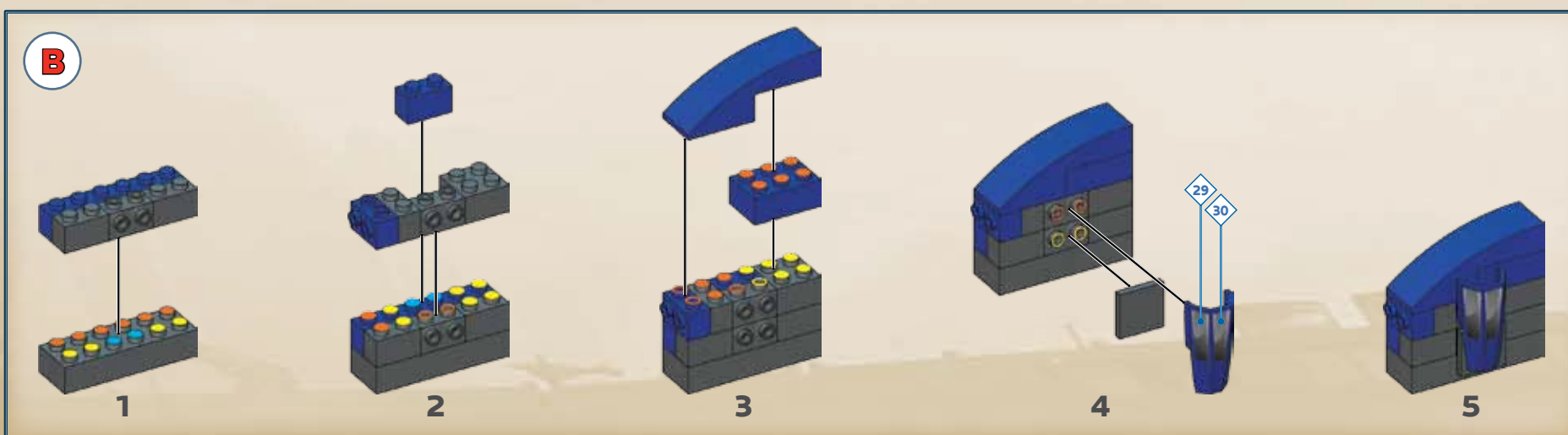
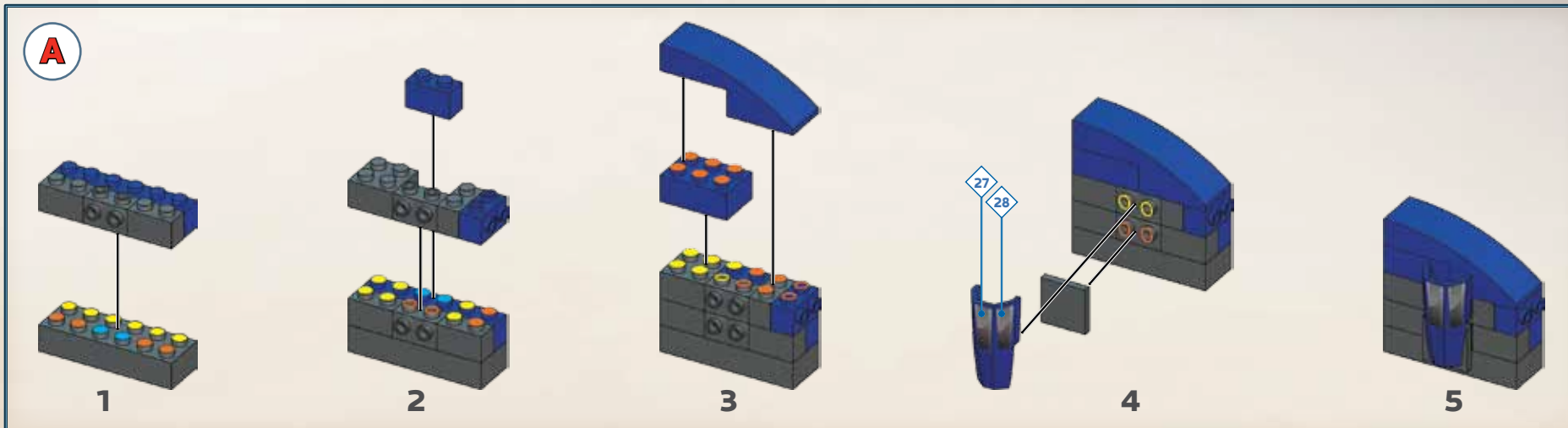
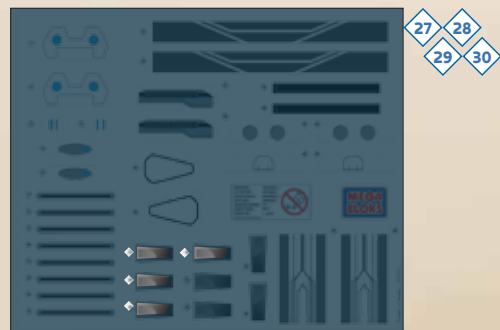
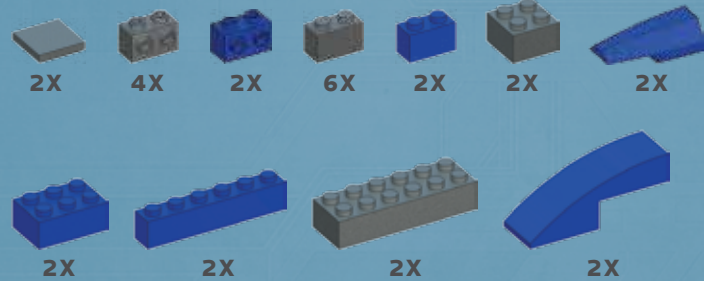



**43**

1X 2X

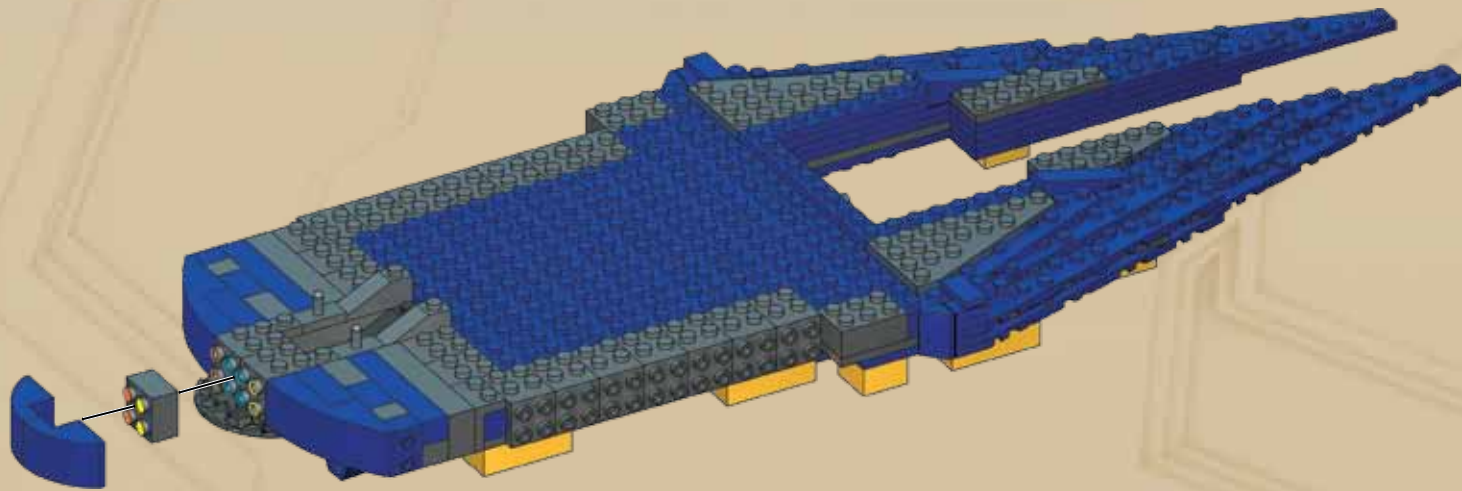

**44**

2X 2X 1X

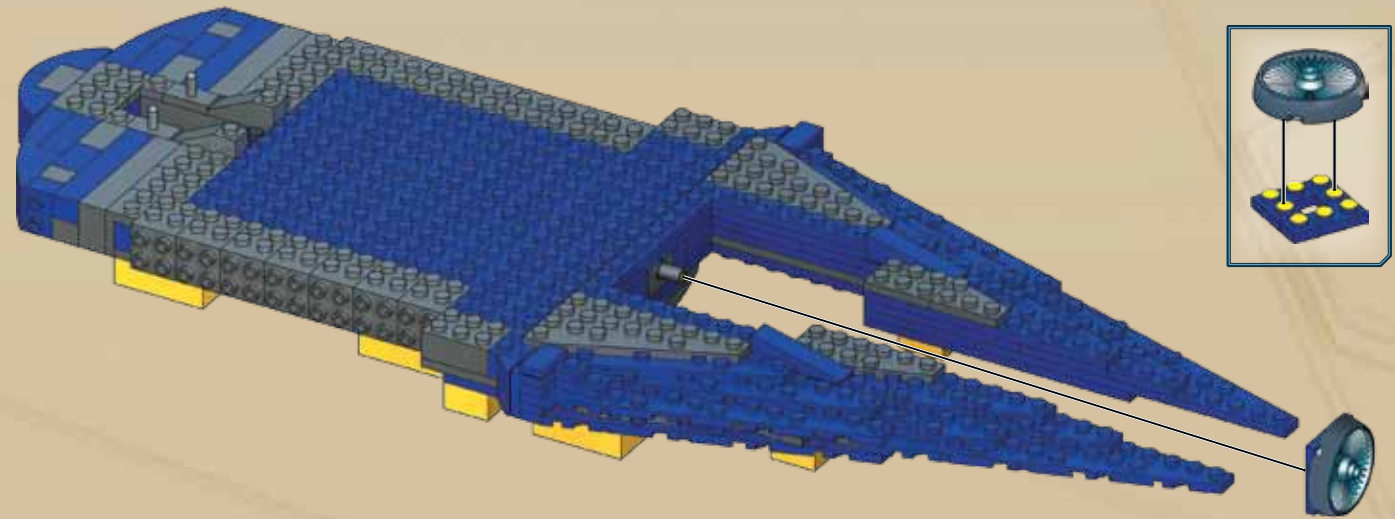

**45**

2X 1X 1X

1X 1X

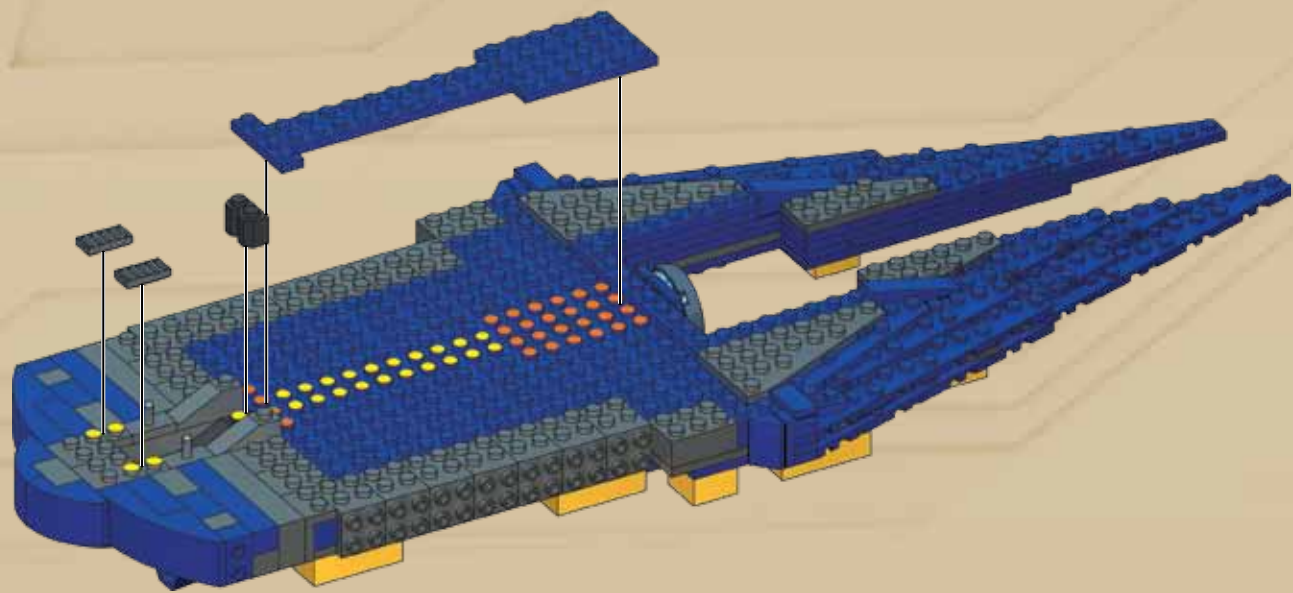

**46**

2X 10X

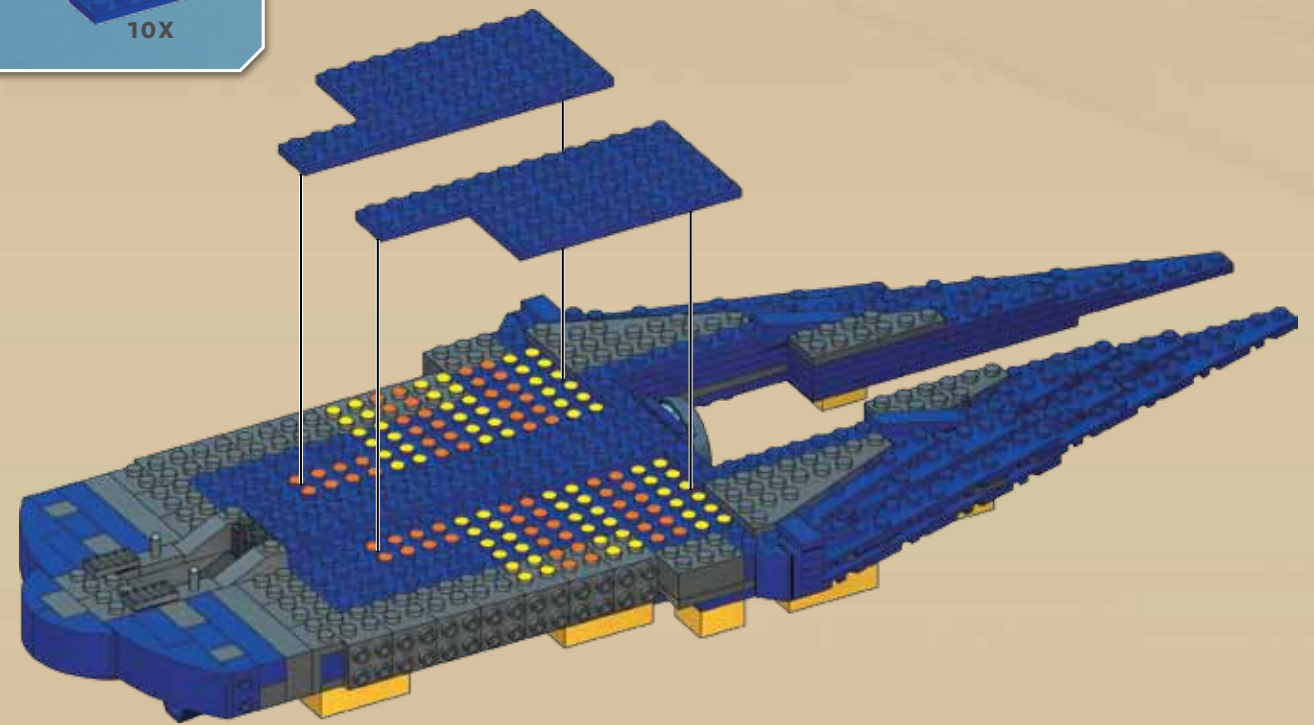



47

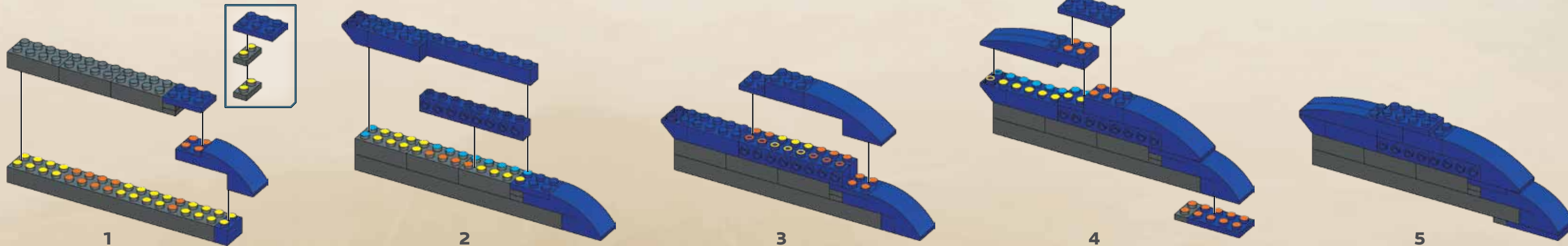
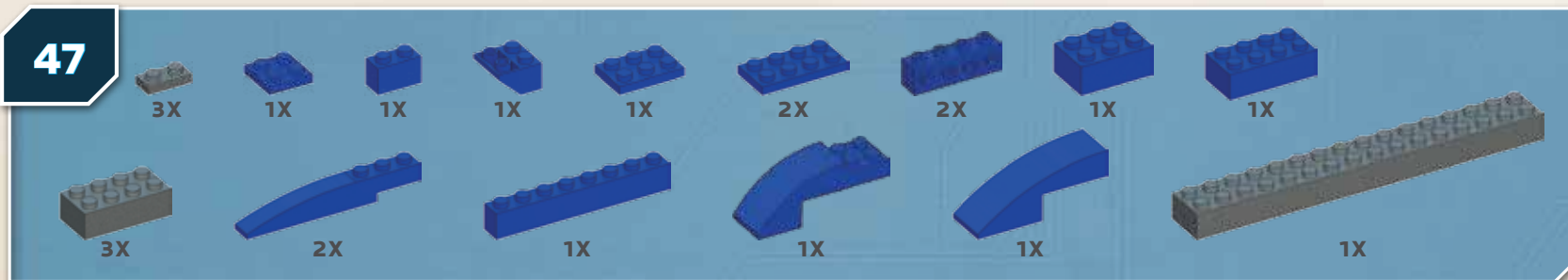

48

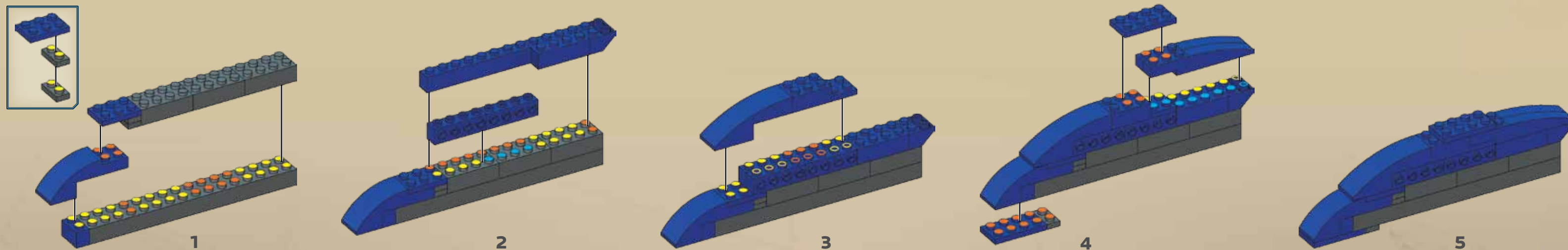
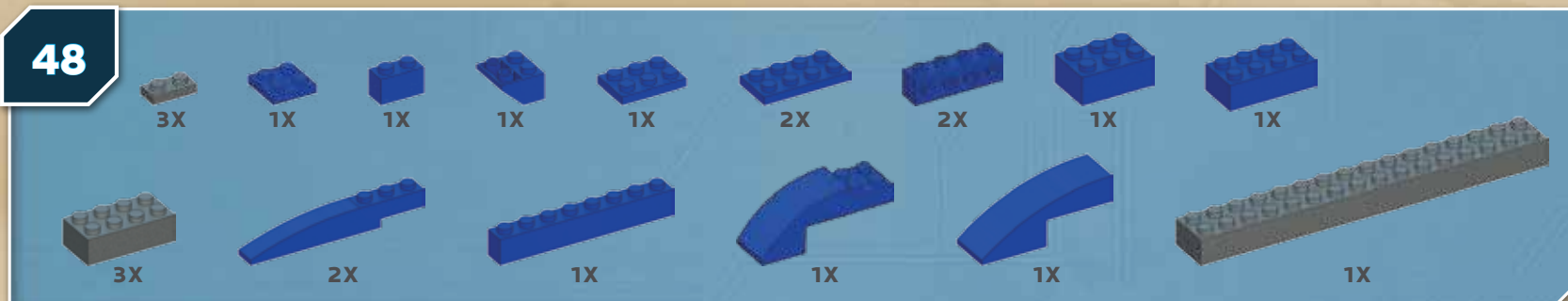



49

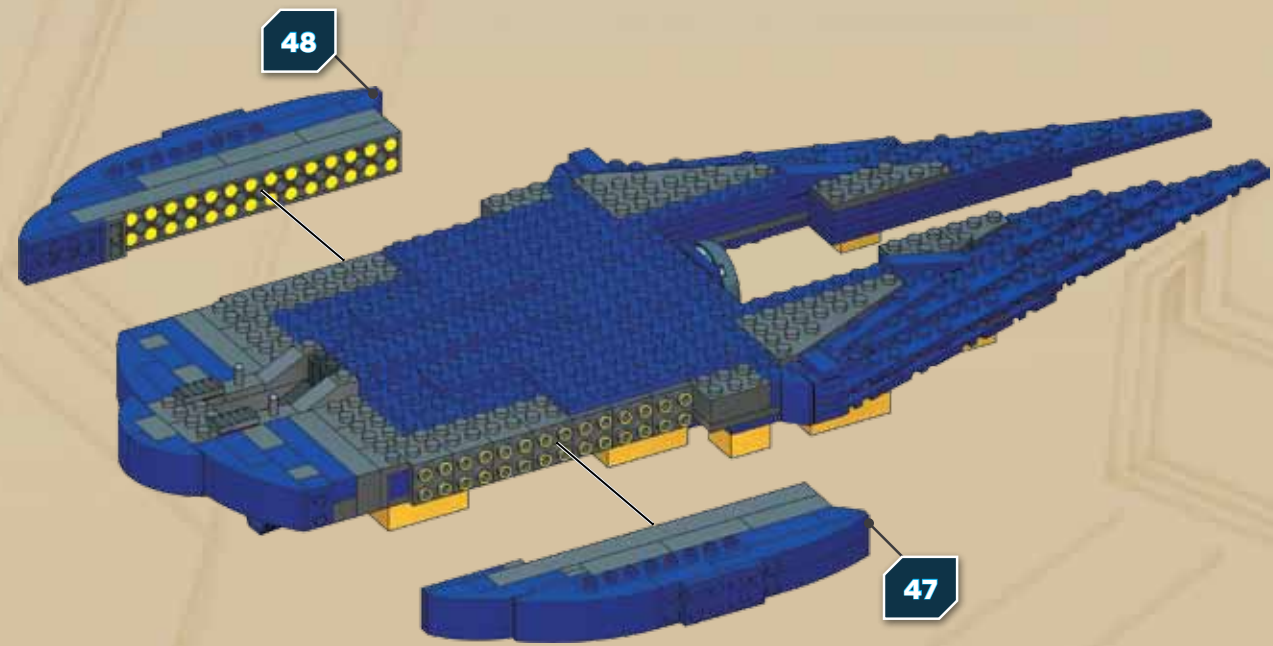

50

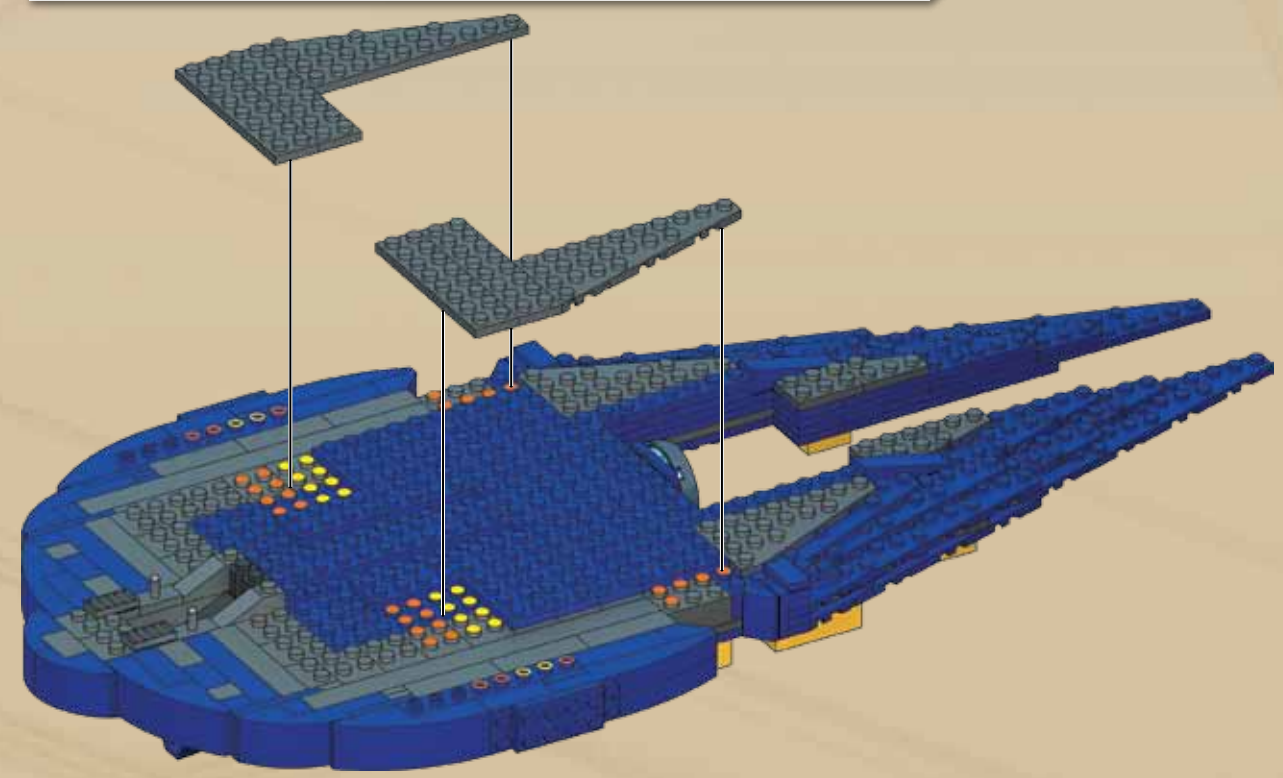
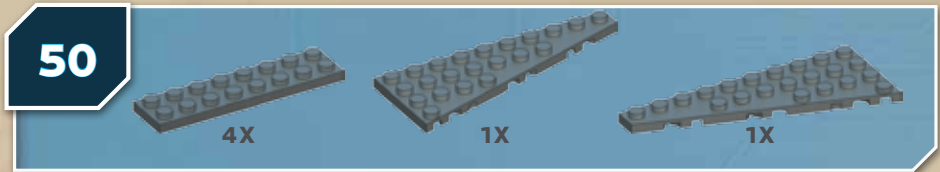

51

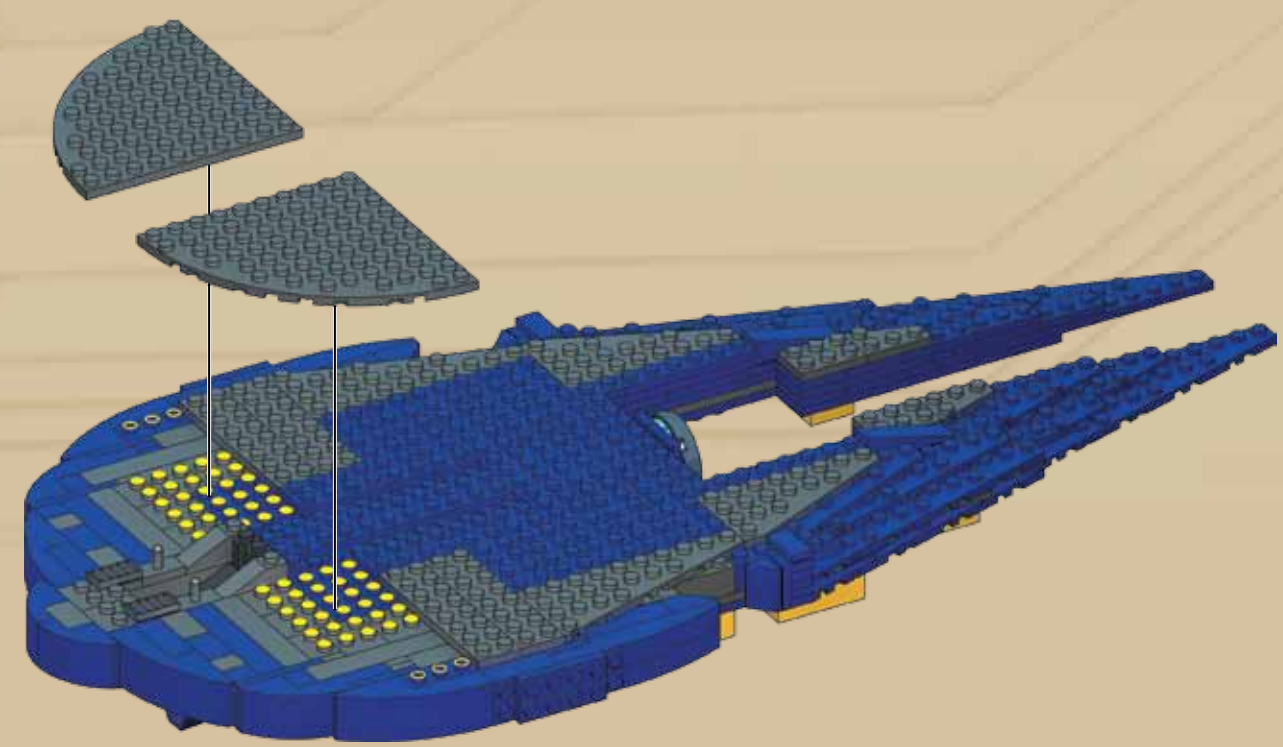

52

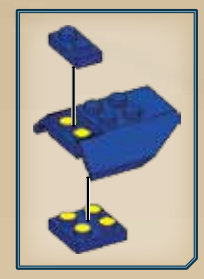
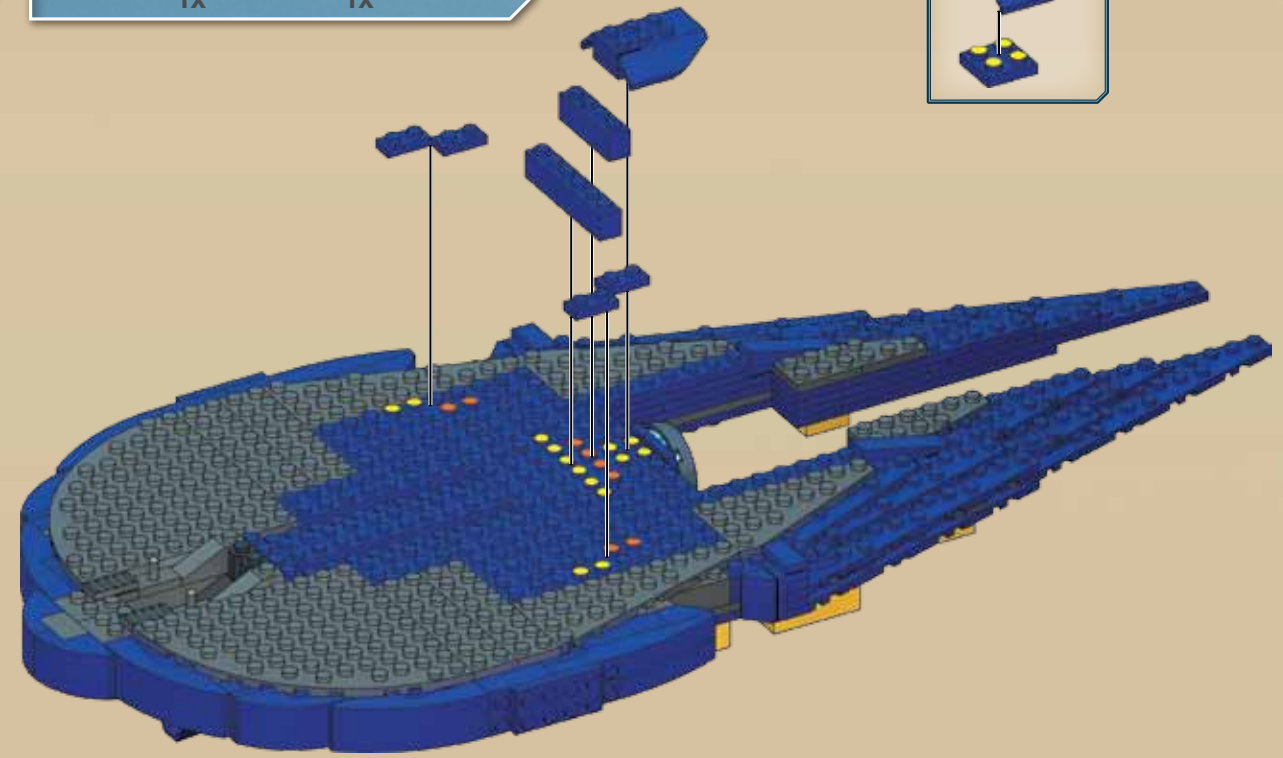
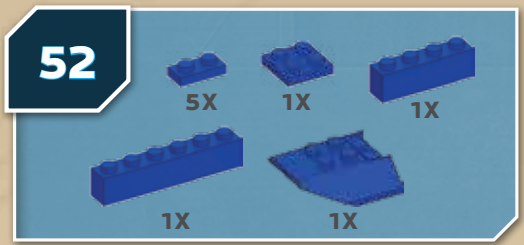



53

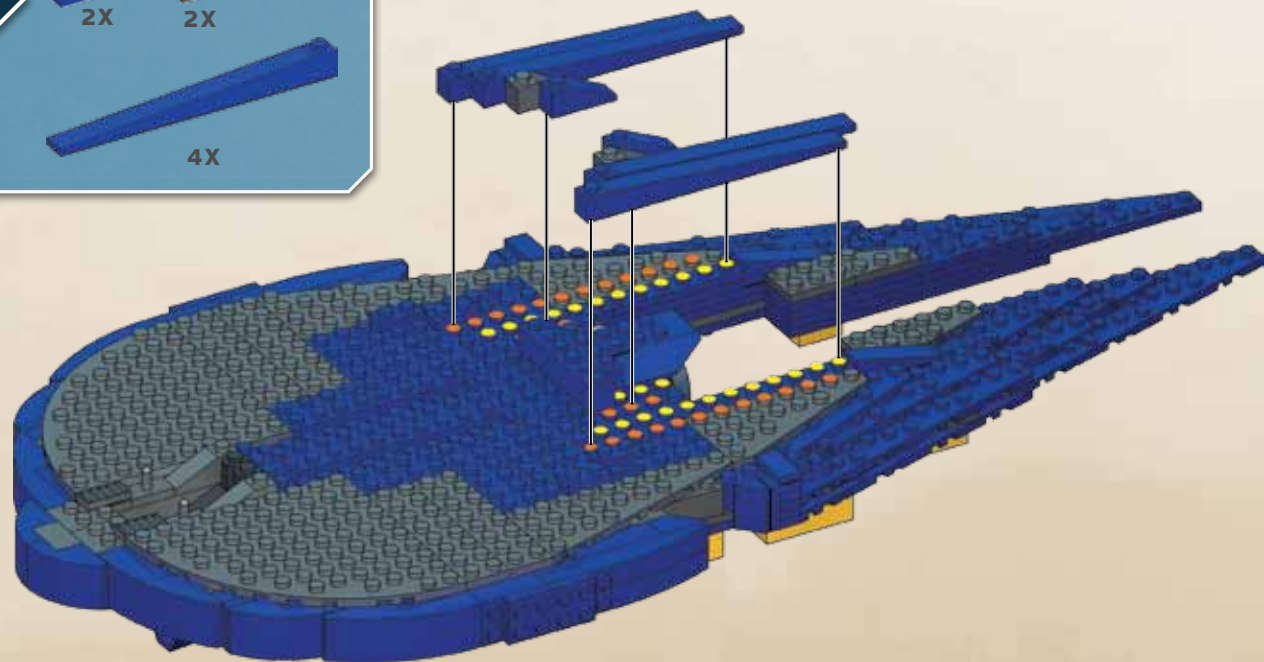
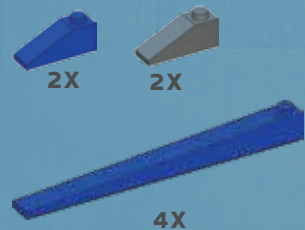

54

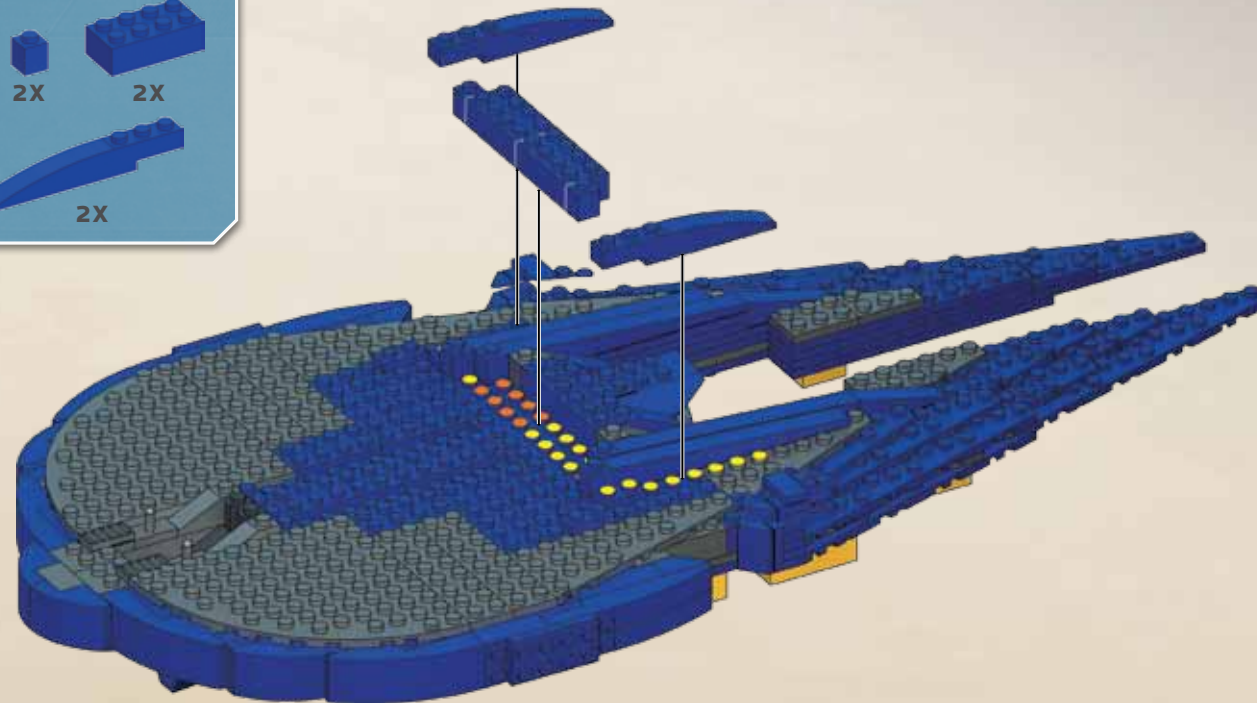
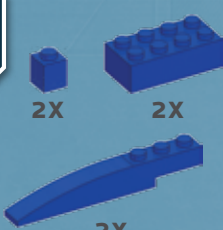

55

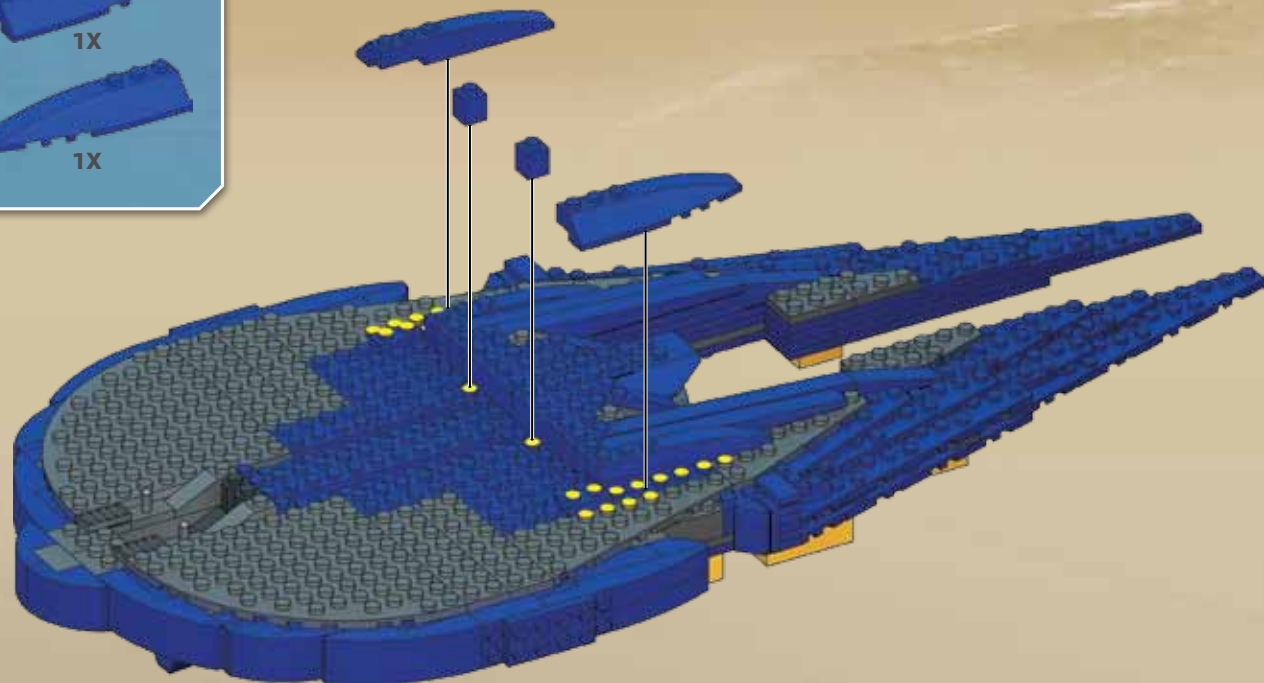

56

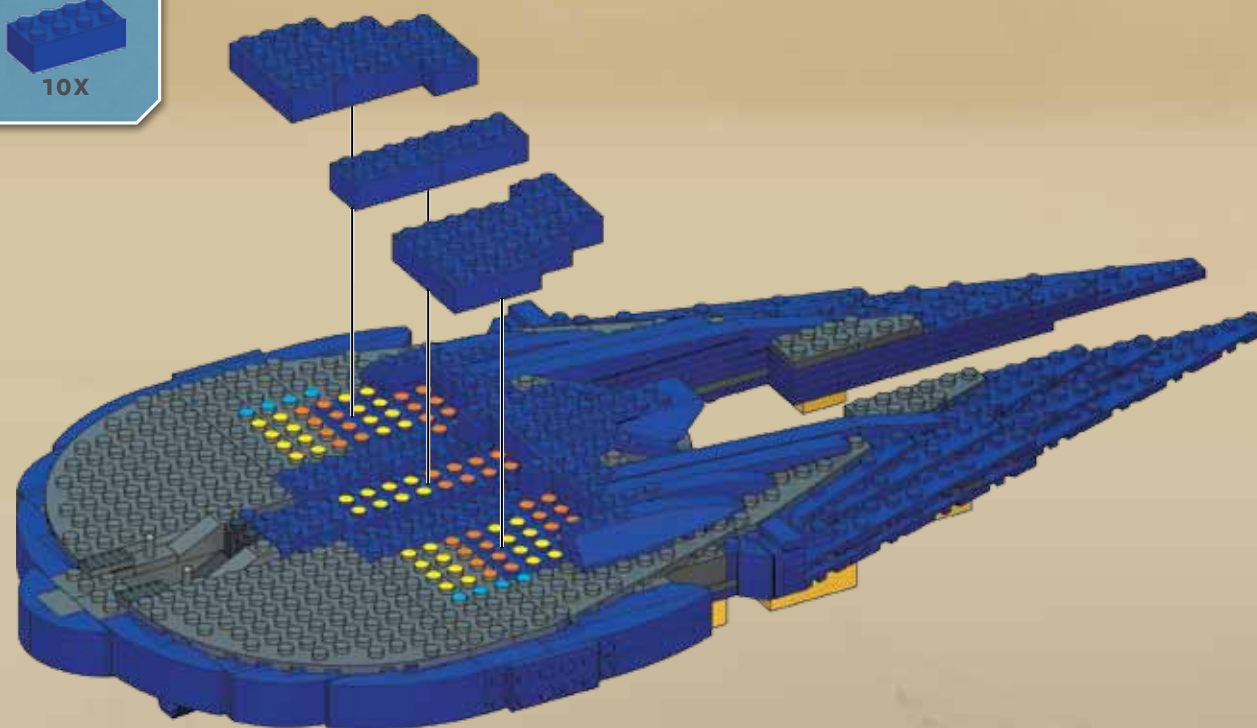



**57**

1X 6X

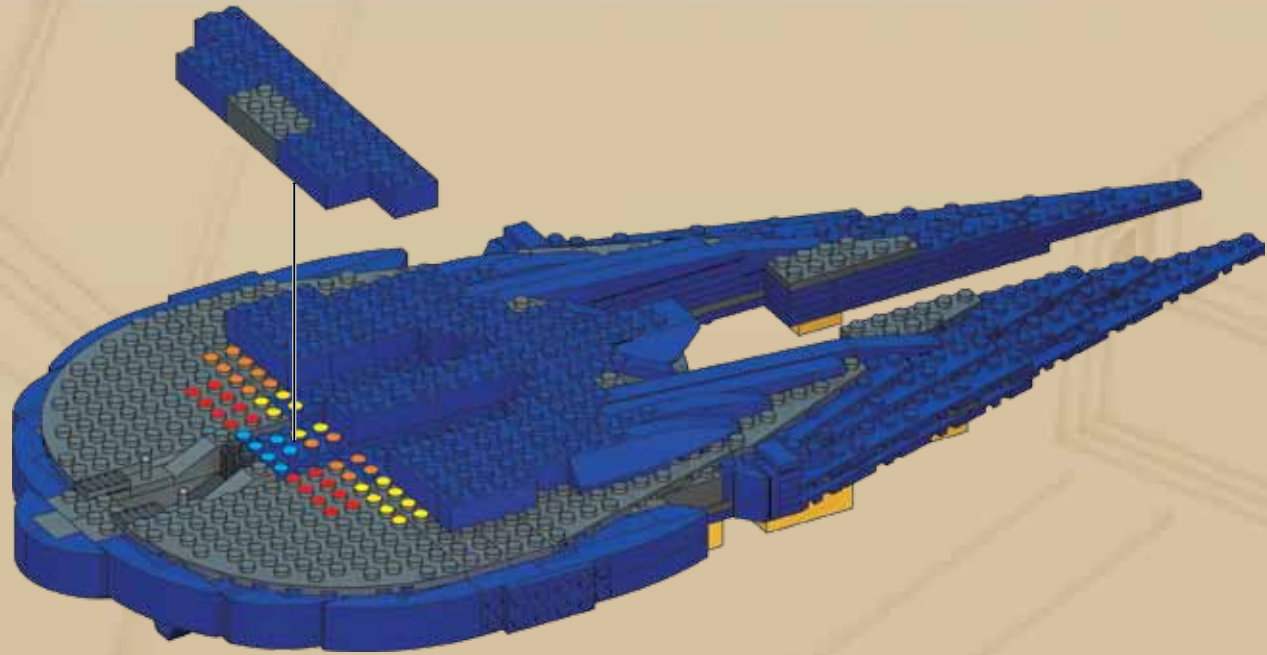

**58**

2X 4X 1X 2X

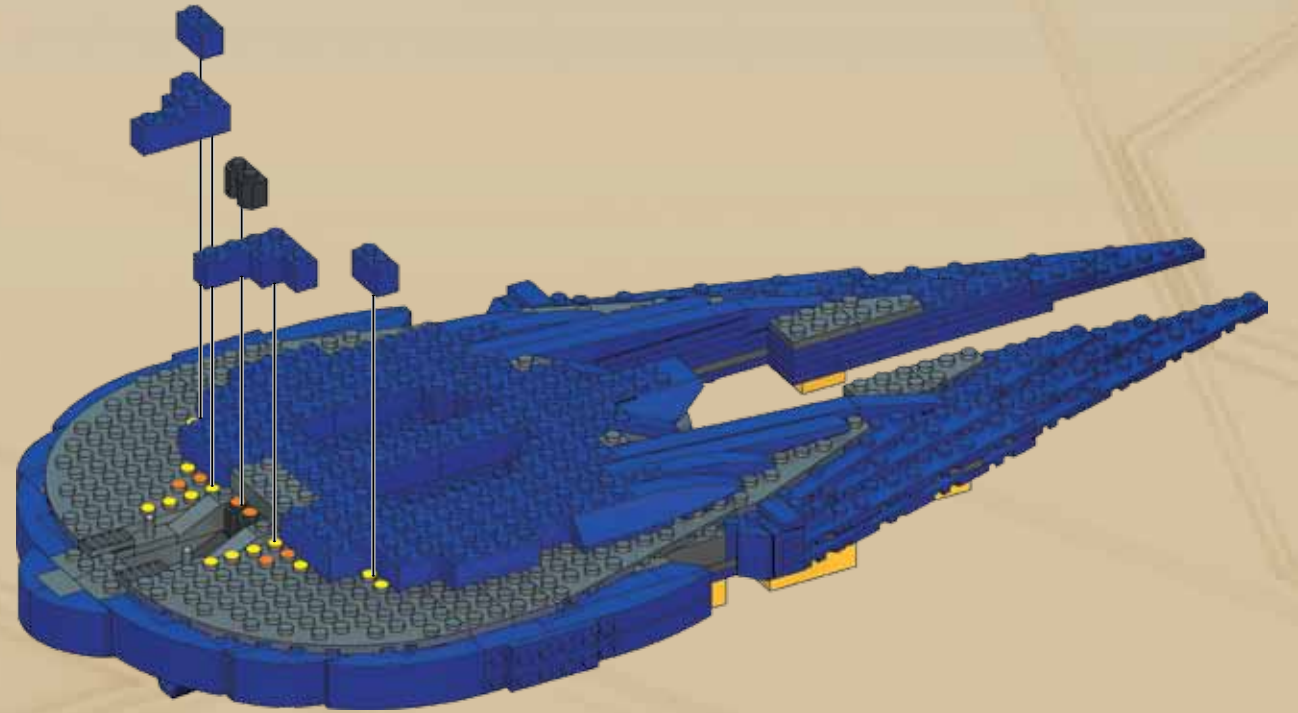

**59**

2X 8X

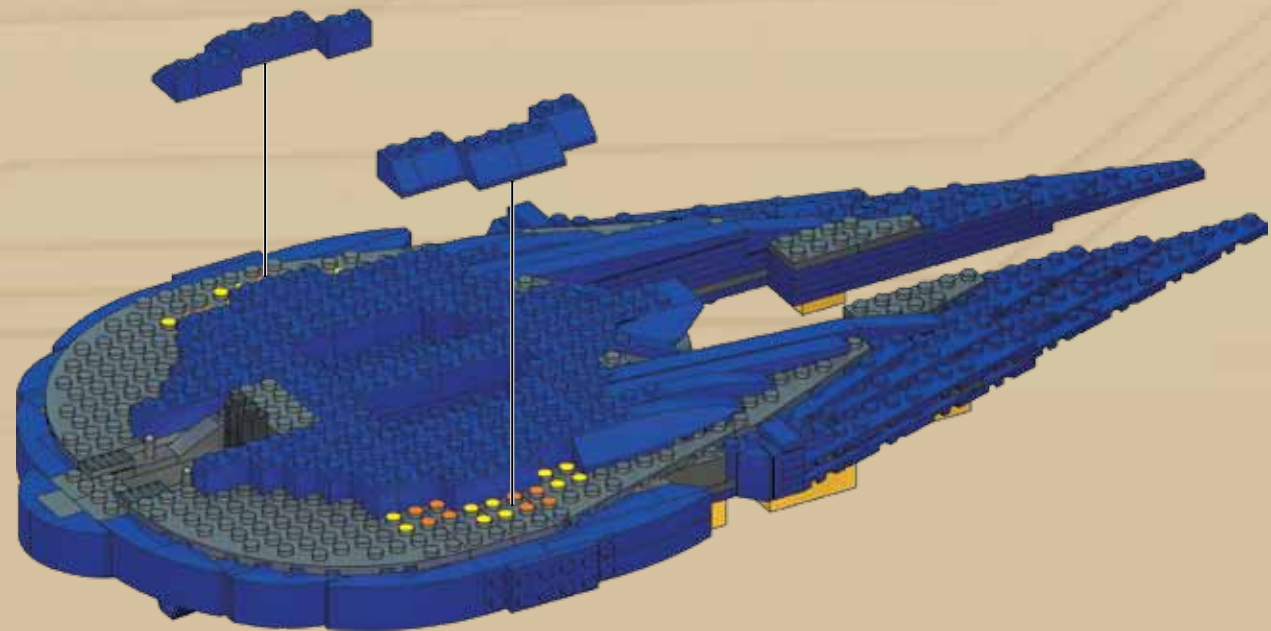

**60**

4X 2X 2X

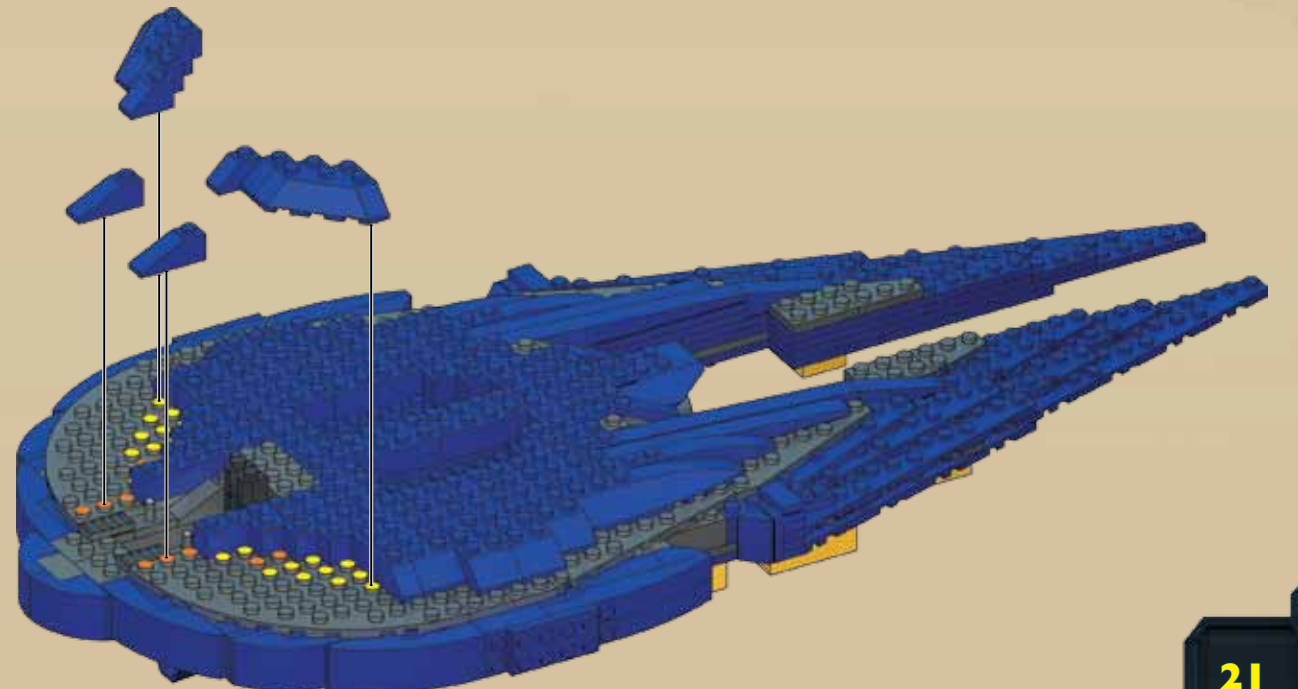



61

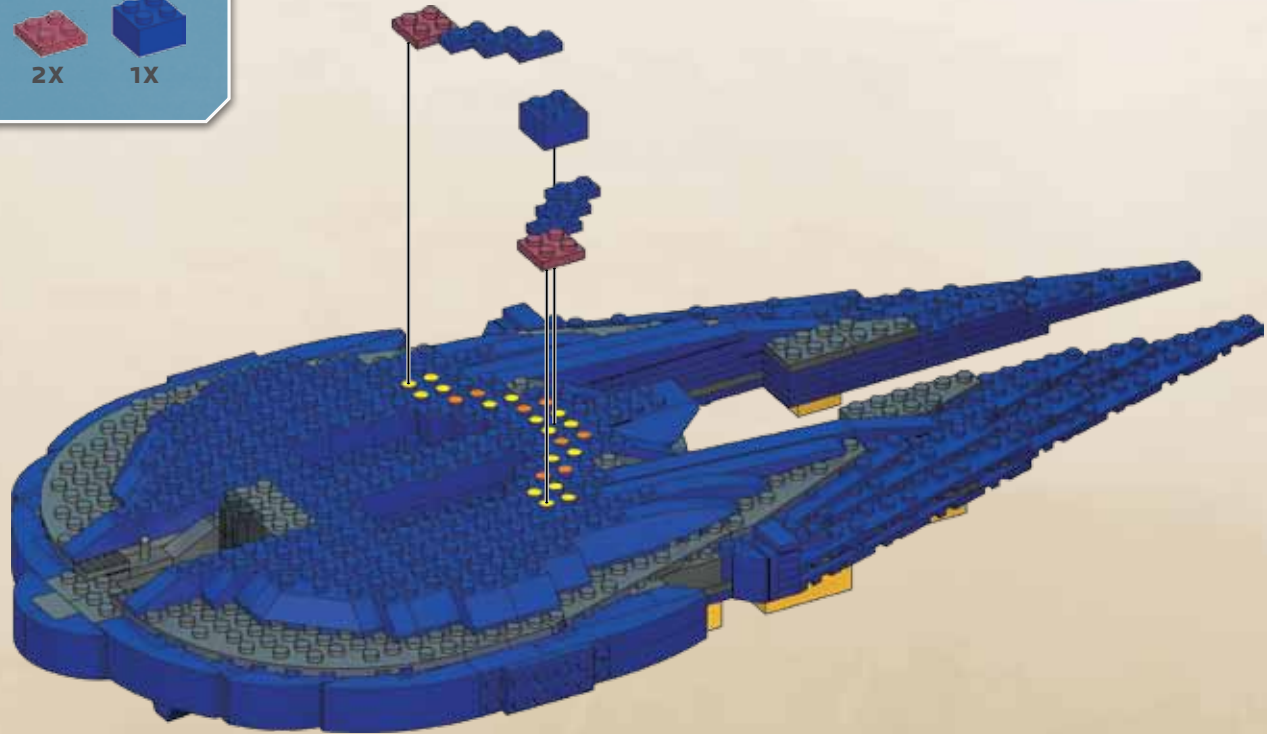

62

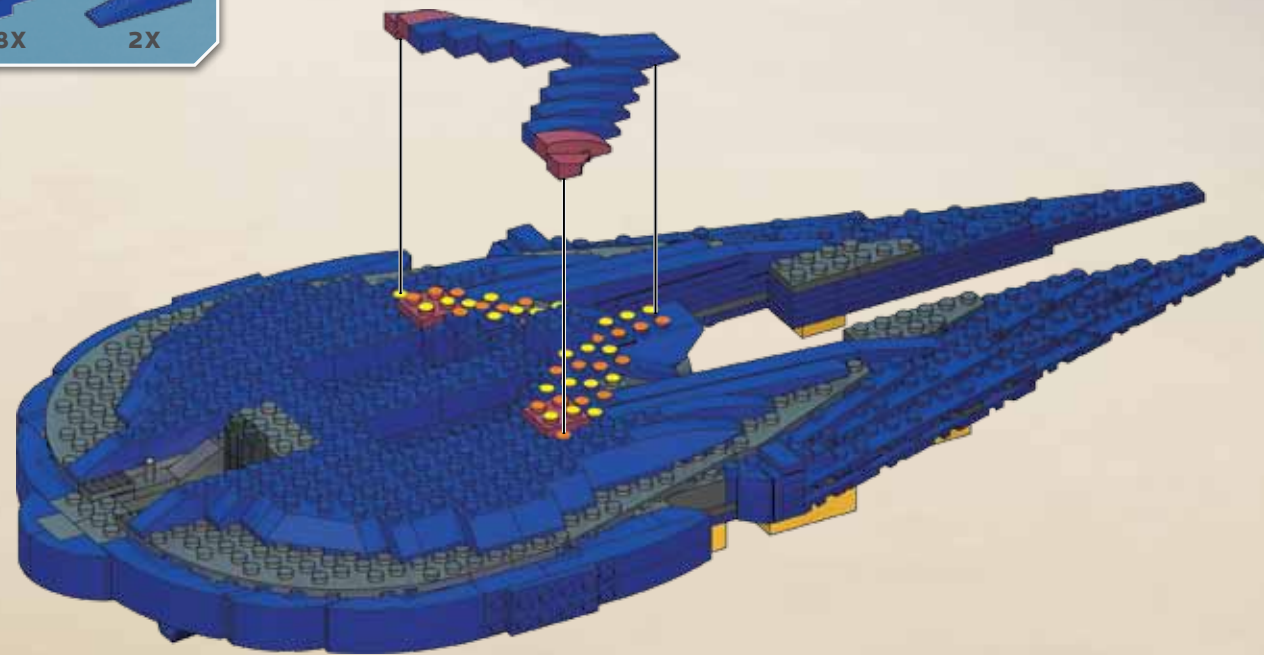

63

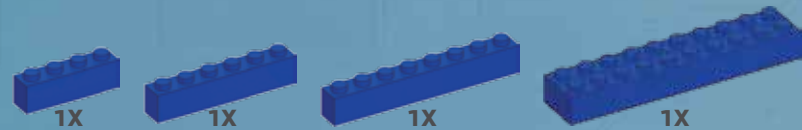

64

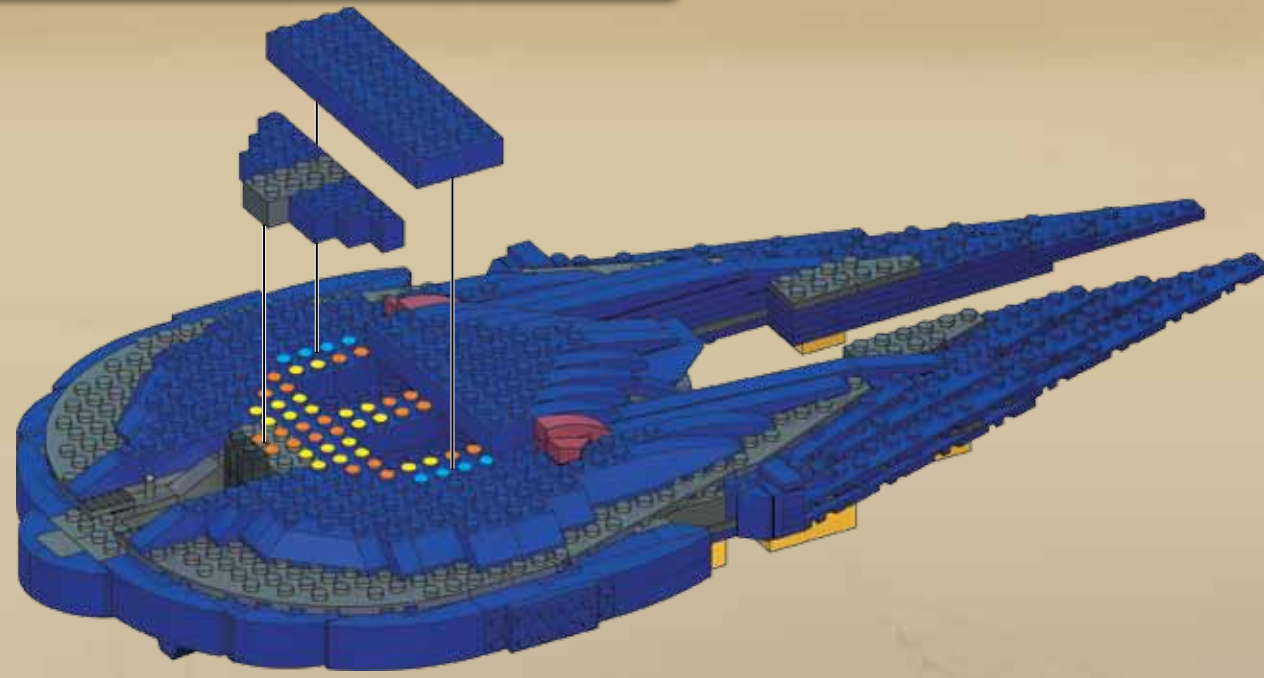
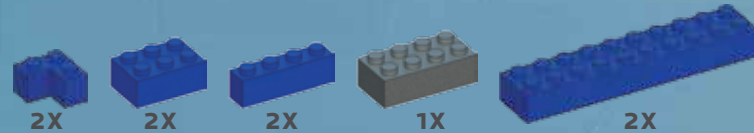



**65**

2X 6X

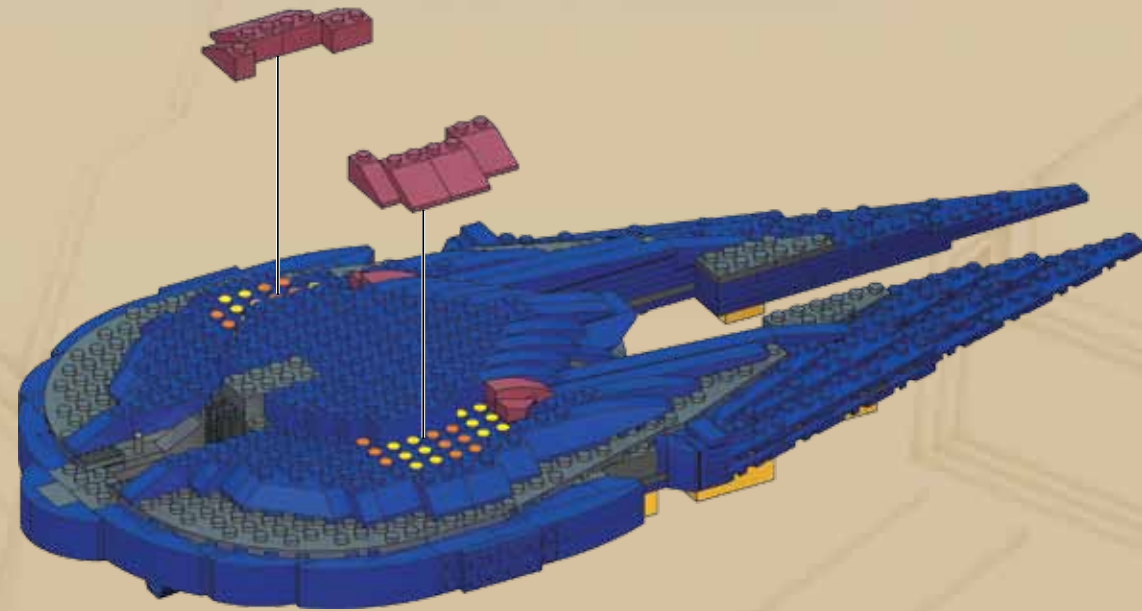

**66**

2X 2X 2X

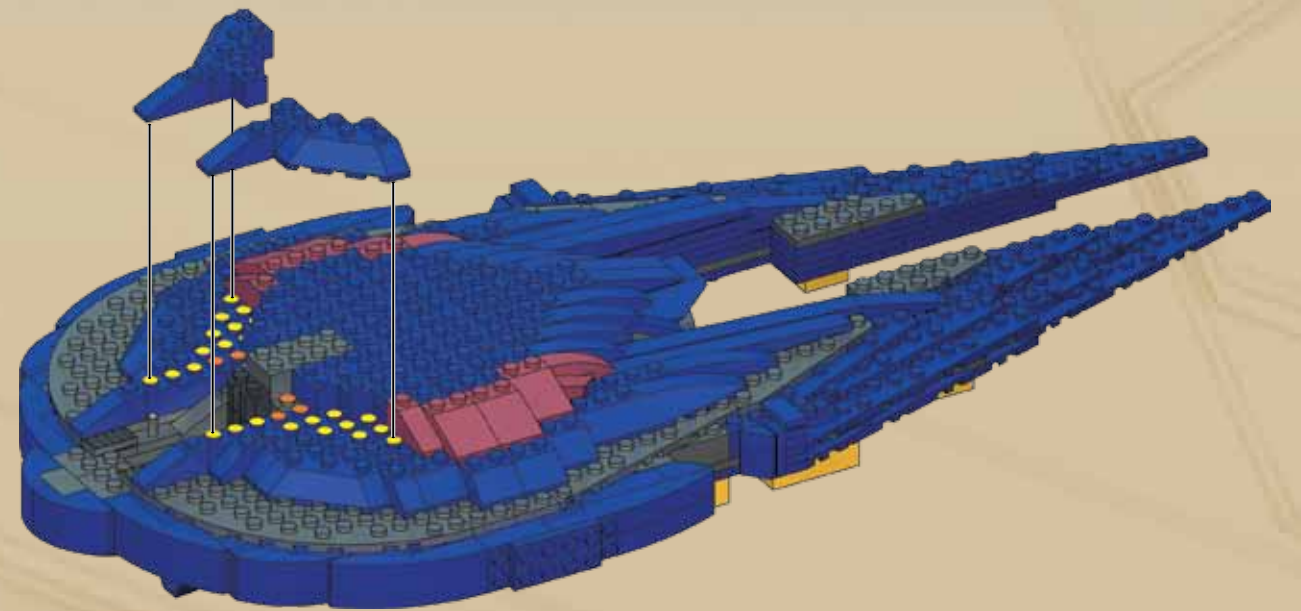

**67**

1X 1X 1X 1X 1X 1X 2X

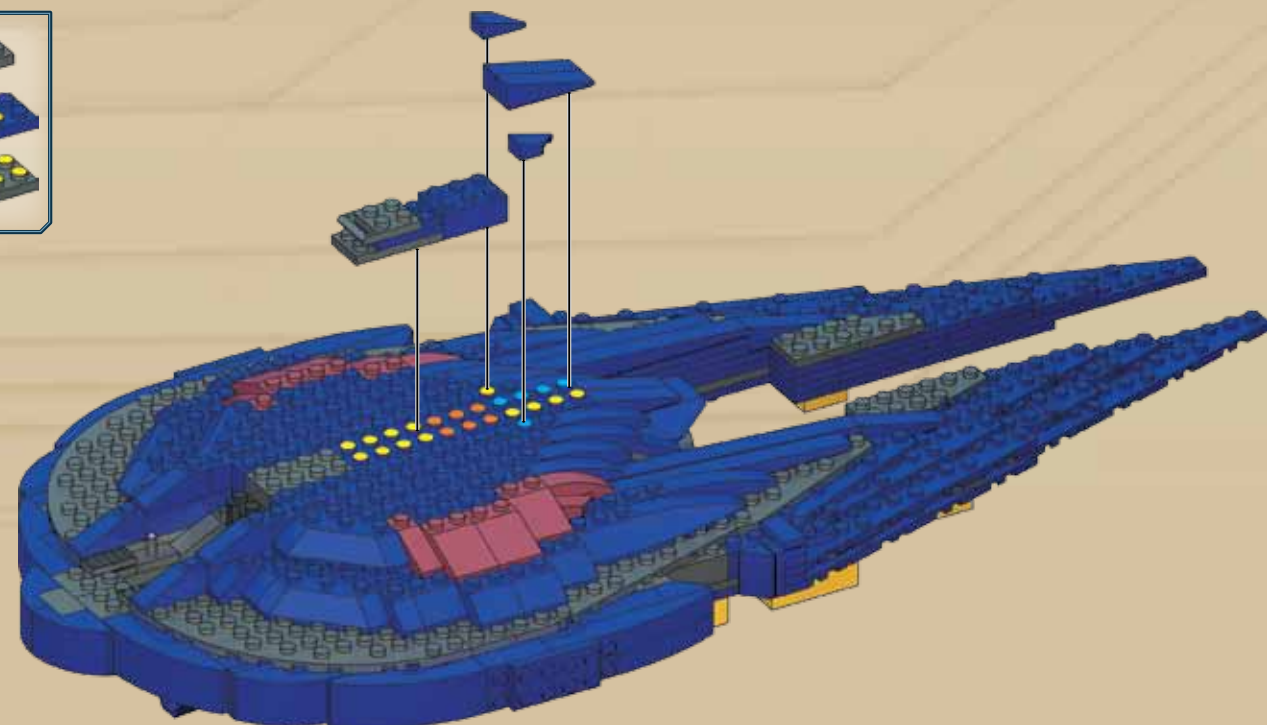

**68**

4X 2X





69

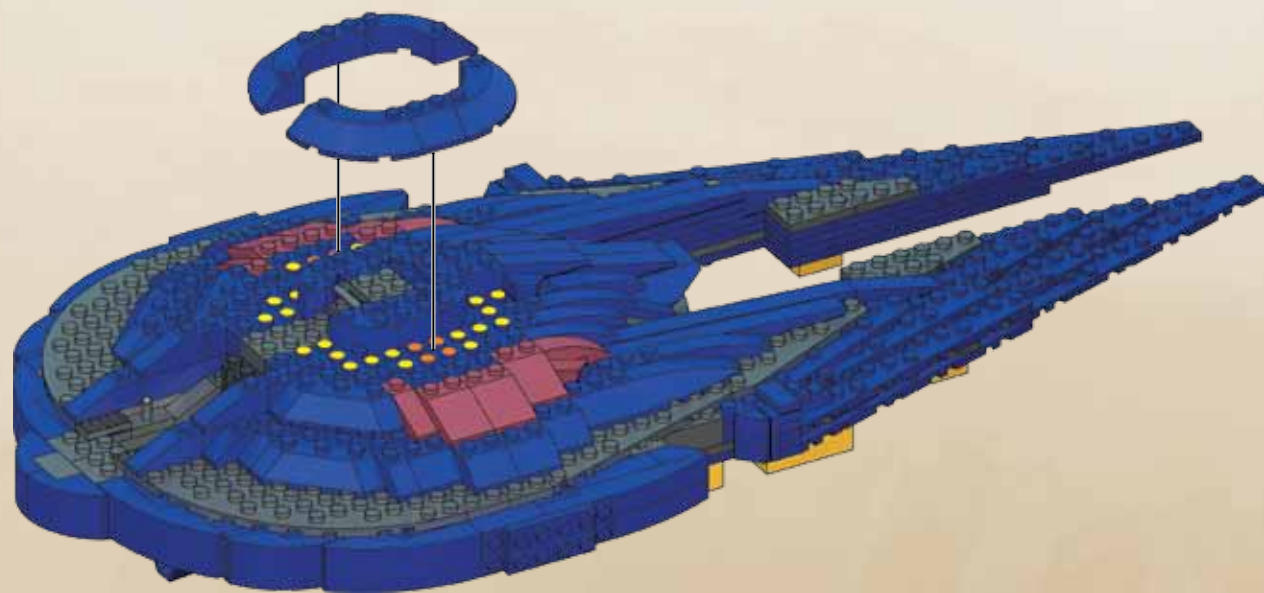
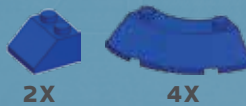

70



31 32  
33 34

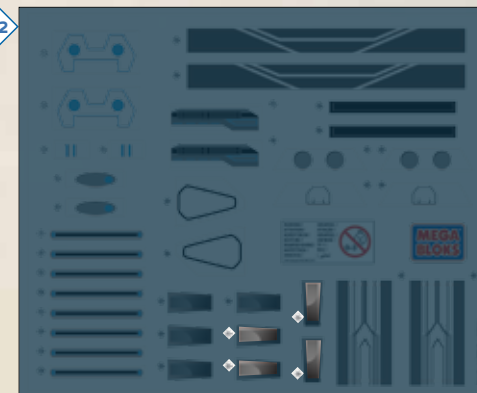

71

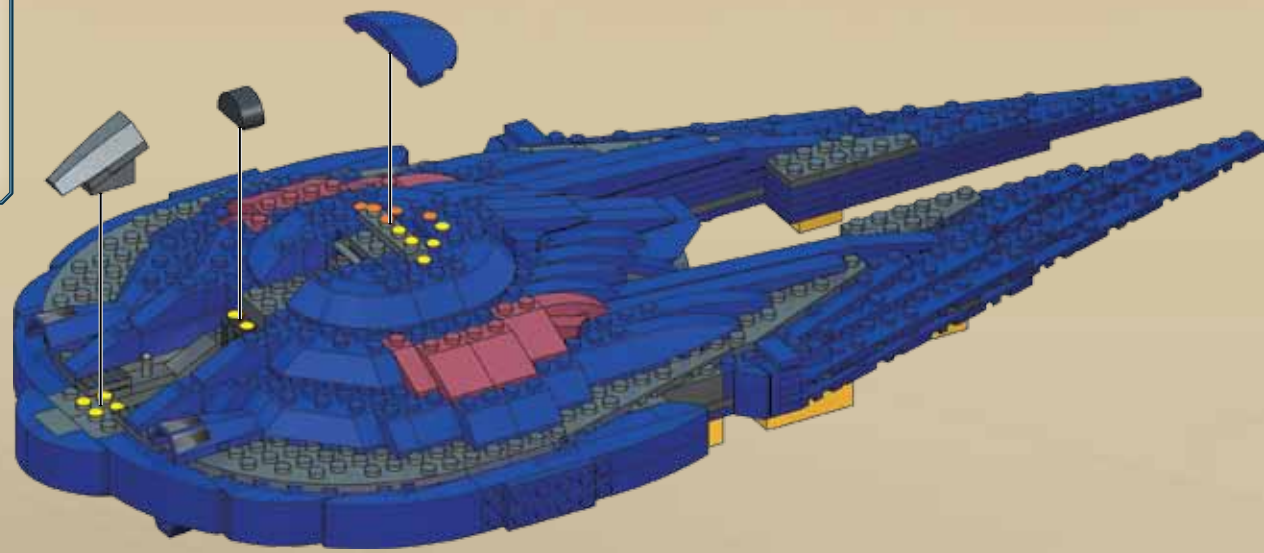

72

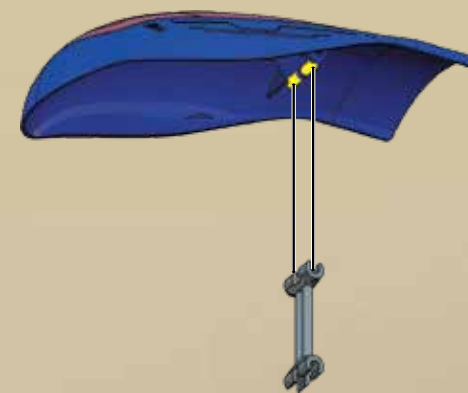
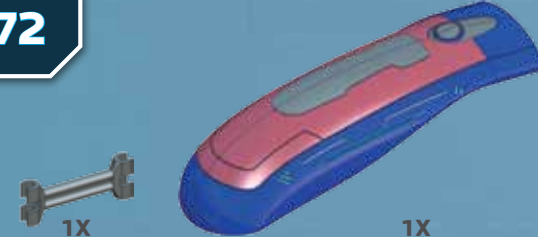

1



2





1

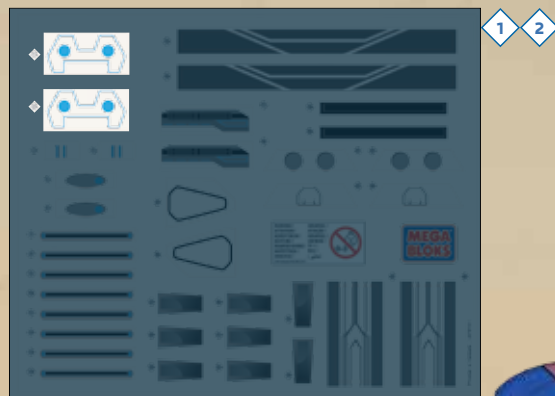

1 2

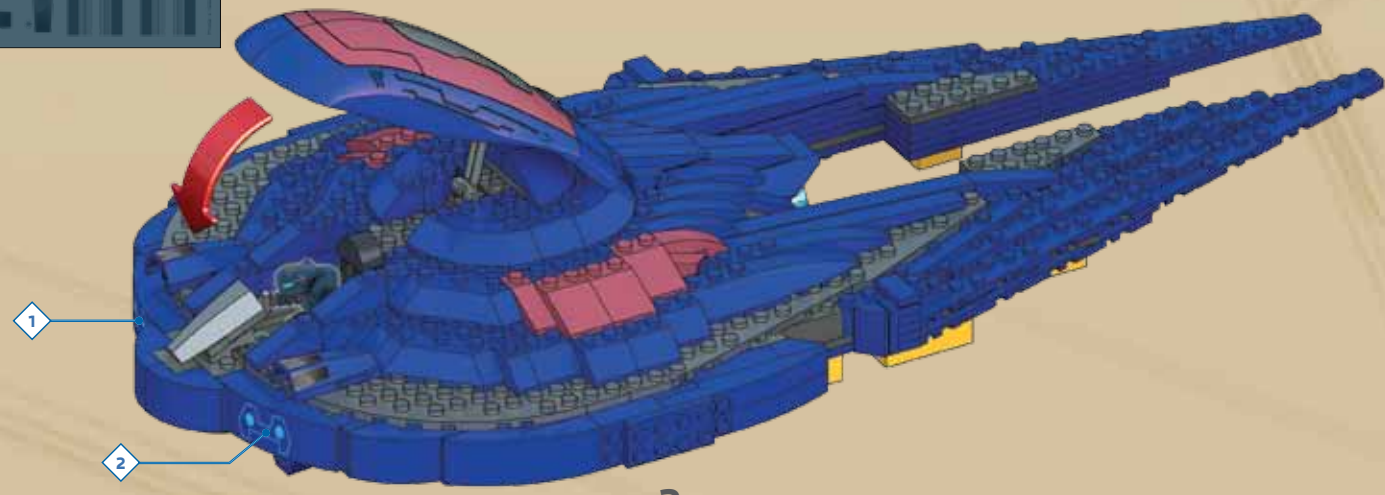

2

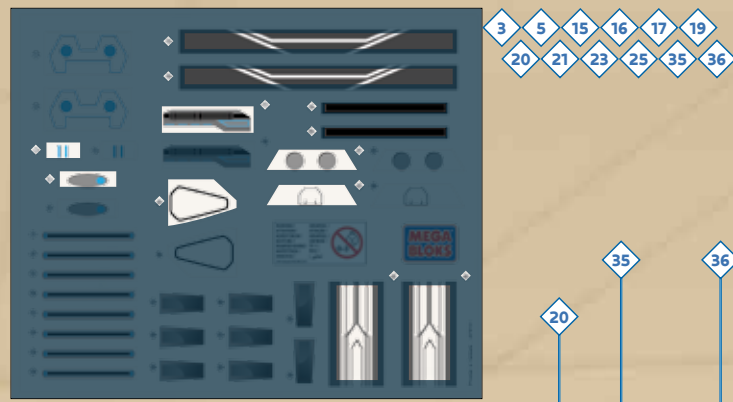

3 5 15 16 17 19  
20 21 23 25 35 36

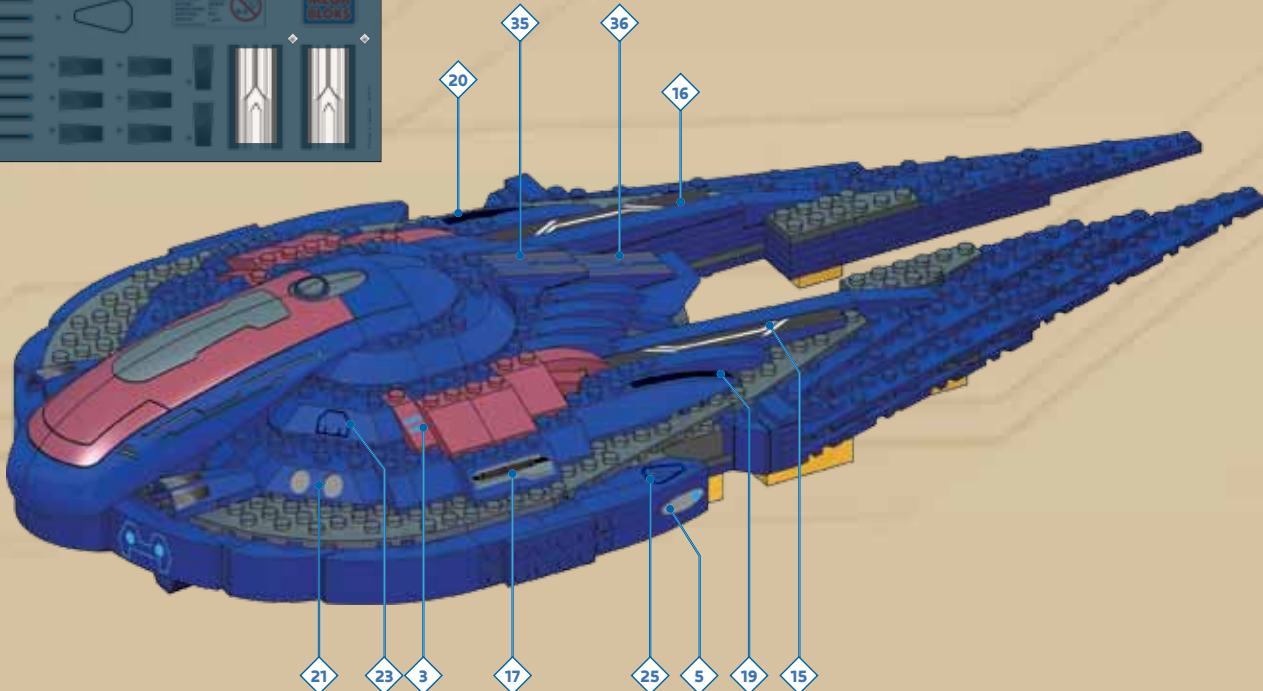

3

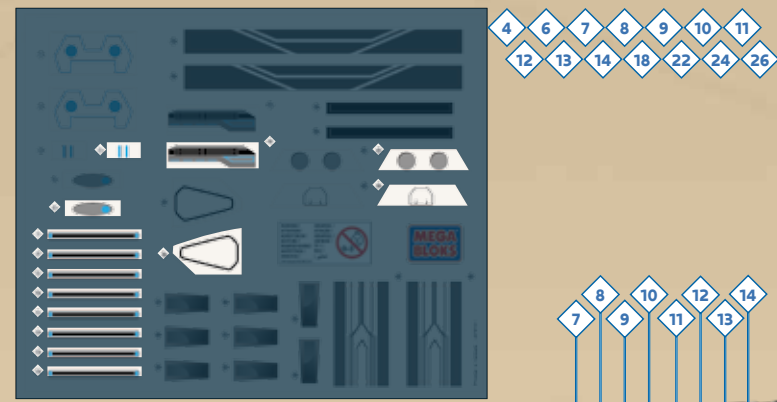

4 6 7 8 9 10 11  
12 13 14 18 22 24 26

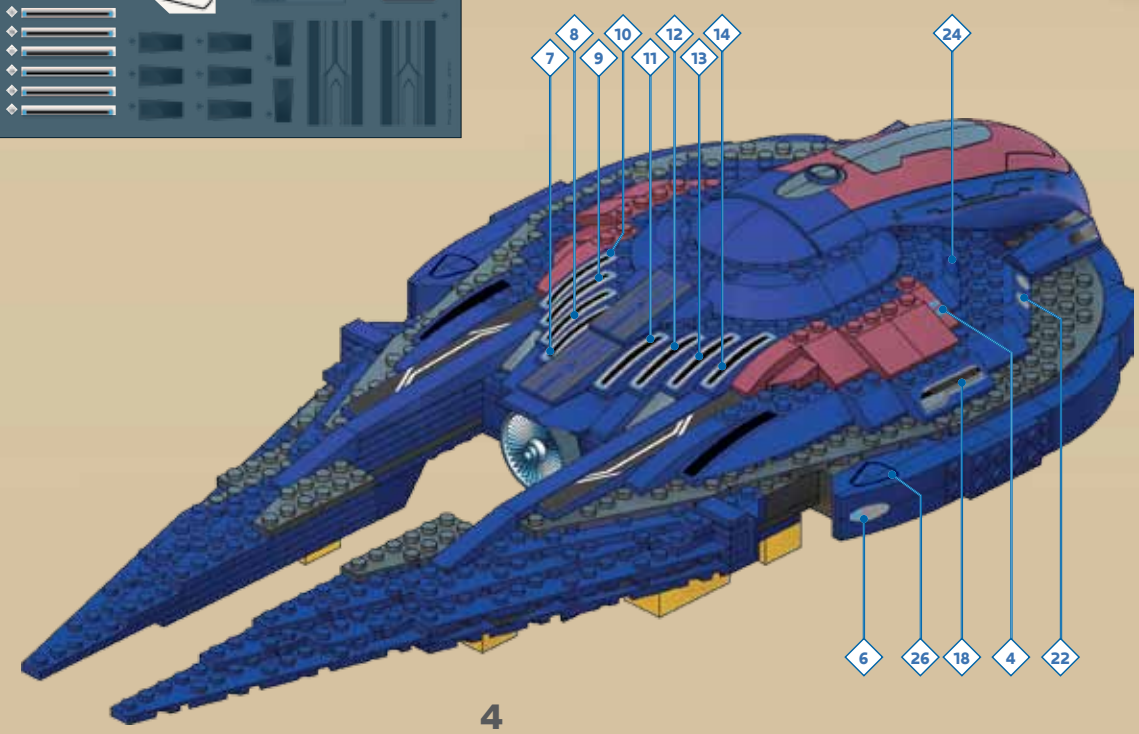

4



74

Remove temporary pieces.  
 Retirar las piezas provisionales.  
 Enlever les pièces temporaires.  
 Provisorische Teile entfernen.  
 Verwijder de tijdelijke onderdelen.  
 Rimuovere i pezzi temporanei.  
 Retirar peças temporárias.

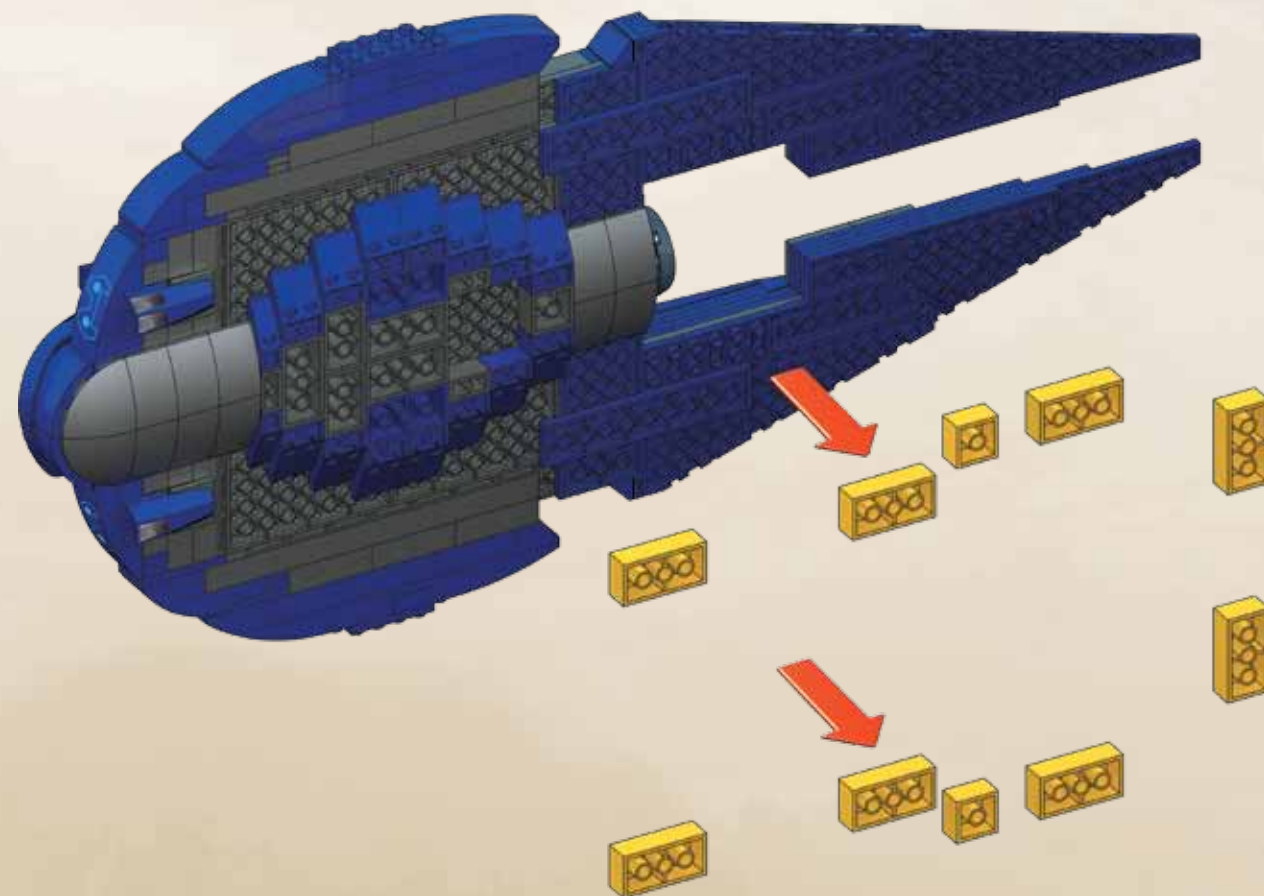

75

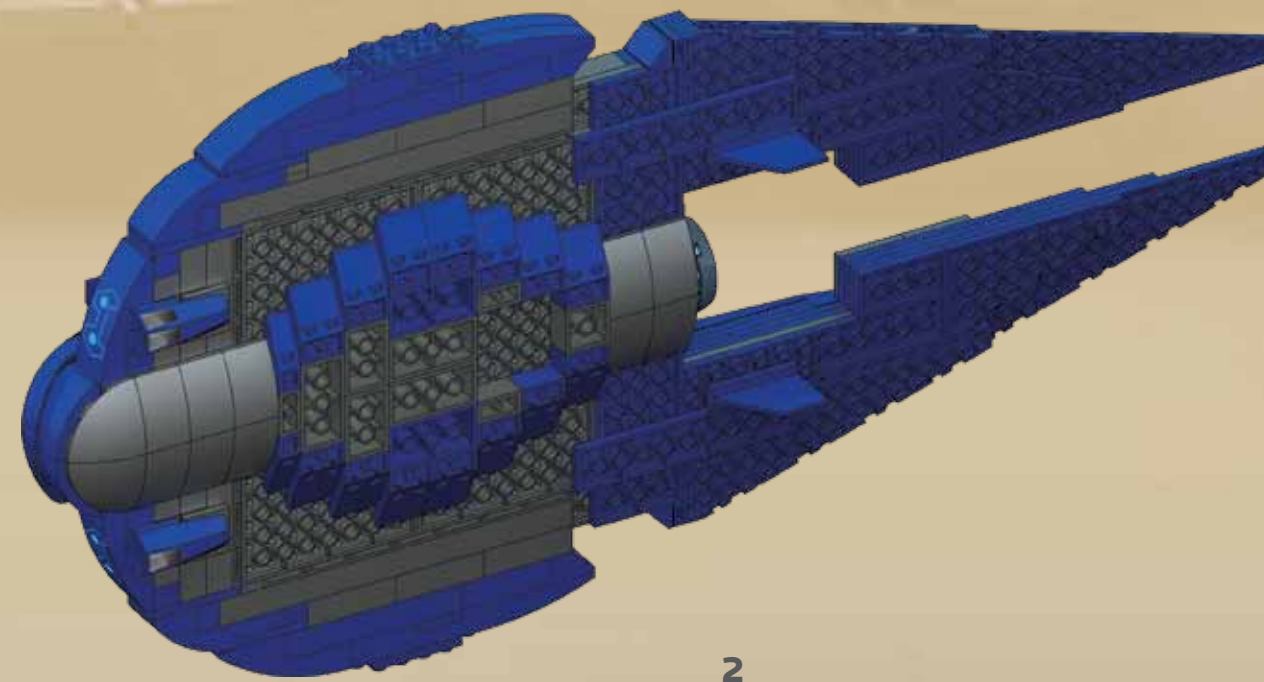
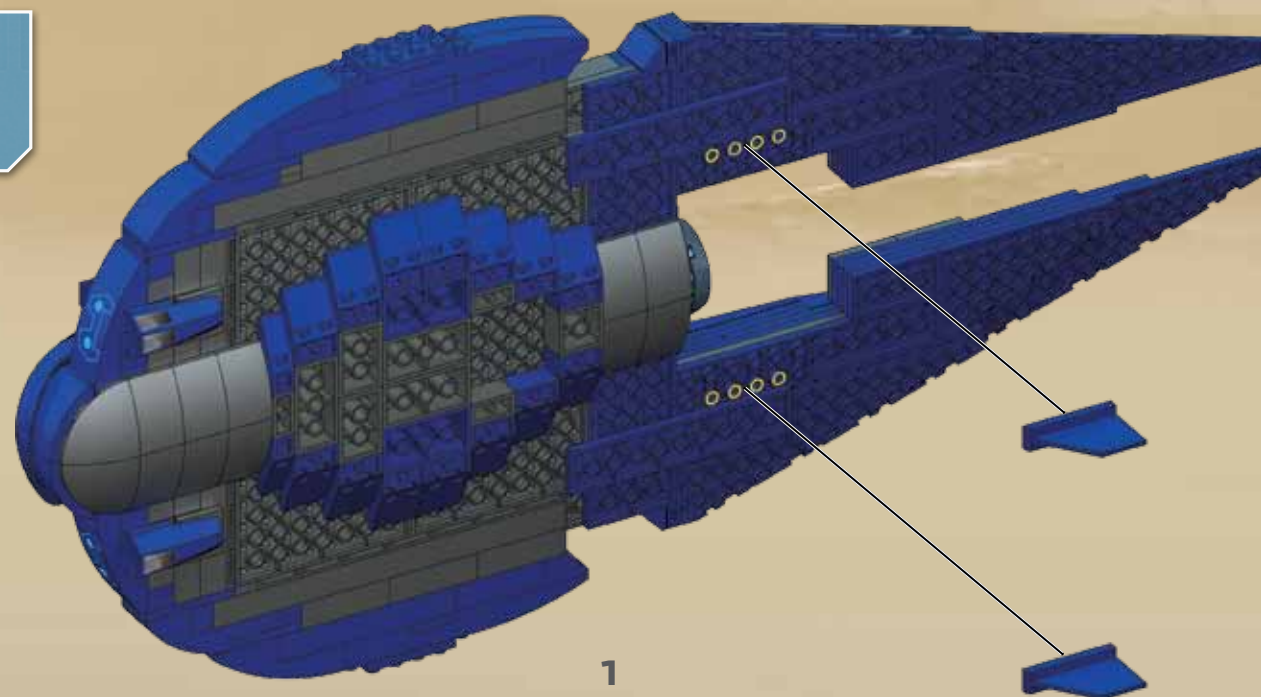



76

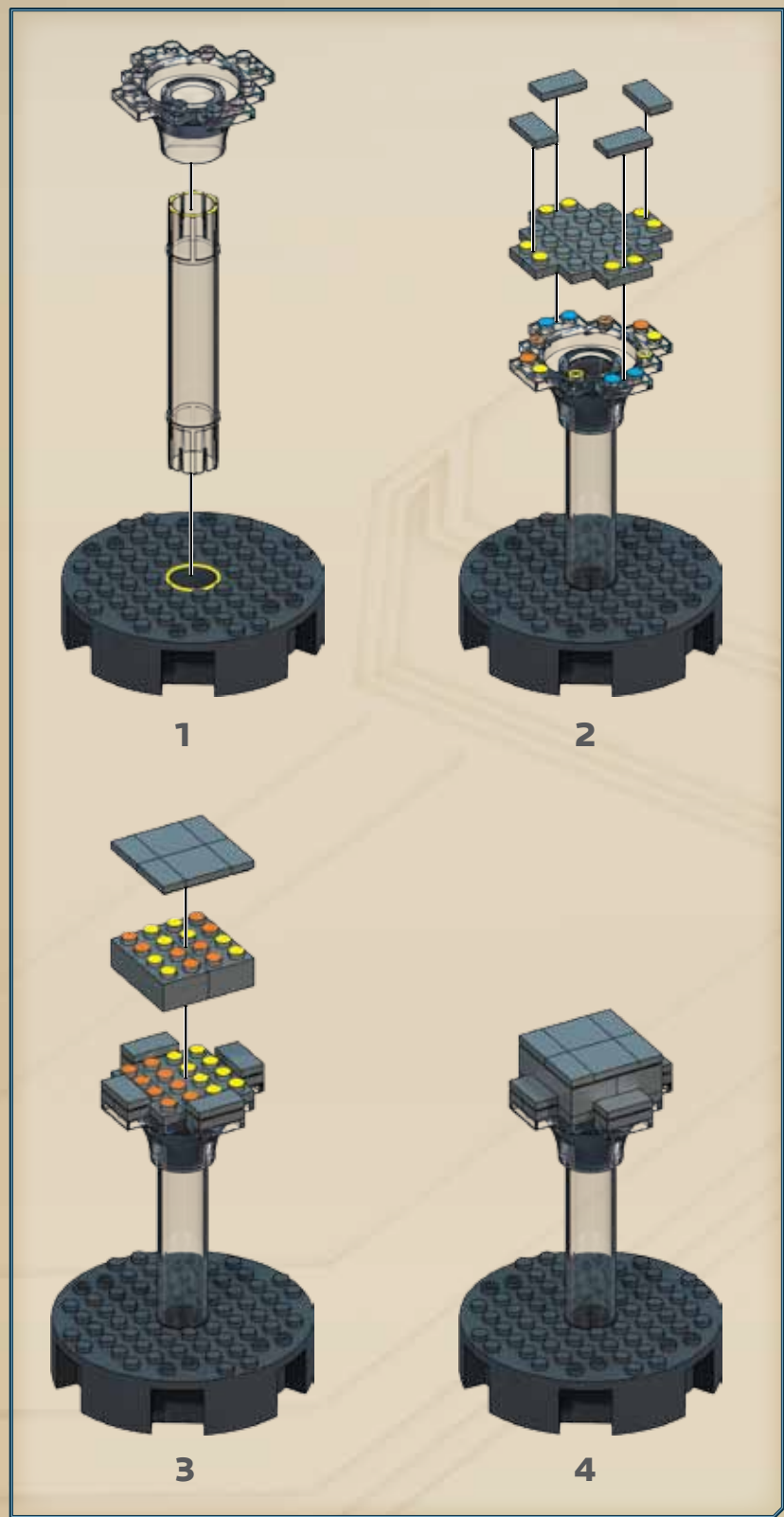
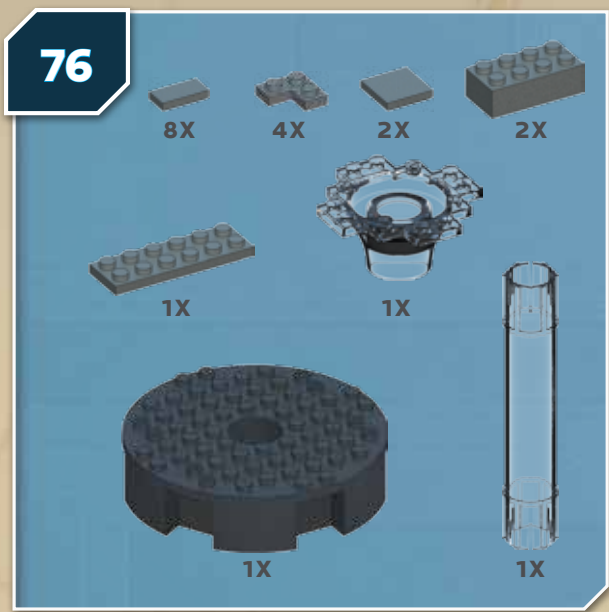



# HALO

## COVENANT SERAPH

The Covenant Seraph is the multi-role fighter of the Covenant. Armed with a pair of heavy plasma cannons and protected by an energy shield, this superior Indigo craft is incredibly versatile.

### Seraph de Covenant

El Seraph de Covenant es el caza multifunción de Covenant. Armado con un par de cañones de plasma pesados y protegidos por un escudo de energía, esta nave indigo superior es increíblemente versátil.

### Seraph du Covenant

Le Seraph est le chasseur de choix des Covenants. Armé d'une paire de puissants canons au plasma et protégé par un bouclier d'énergie, cet aéronef bleu indigo de calibre supérieur est incroyablement polyvalent.

### Covenant Seraph

Der Covenant Seraph ist der universelle Kämpfer des Covenant. Ausgerüstet mit ein Paar schwere Plasmakanonen und geschützt durch ein Energieschild, ist diese überlegene indigofarbene Kampfmaschine unglaublich vielseitig.

### Covenant Seraph

De Covenant Seraph is een multifunctionele jager van de Covenant. Deze ongelofelijk veelzijdige blauwe jager is uitgerust met een tweetal Heavy Plasma Cannons en wordt beschermd door een Energy Shield.

### Seraph Covenant

Il Seraph Covenant è il caccia multi-funzione di Covenant. Armato con una coppia di cannoni pesanti al plasma e protetto da uno scudo ad energia, questo velivolo indaco superiore è incredibilmente versatile.

### Seraph Covenant

O Seraph Covenant é o caça multi-funções do Covenant. Equipado com dois Canhões Pesados de Plasma e protegido por um Escudo de Energia, esta nave superior azul é incrivelmente versátil.



**NEW / NUEVO / NOUVEAU / NEU / NIEUW / NUOVO / NOVO**

**COVENANT ELITE GENERAL**  
 Generale Covenant Elite  
 Général Elite du Covenant  
 Covenant Elite-generaal  
 General de Elite de Covenant  
 General Elite Covenant

**COVENANT ELITE PILOT**  
 Piloto Elite de Covenant  
 Pilote d'élite du Covenant  
 Covenant elite Pilot  
 Covenant-elite piloot  
 Pilota Covenant Elite  
 Piloto de Elite Covenant

**COMBAT ELITE**  
 Elite de Combate  
 Elite de combat  
 Elite-Kampfeinheit  
 Gevechtseenheid  
 Combat Elite  
 Elite da combattimento

Collect them all! - ¡Colecciónalos todos! - Collectionne-les tous!  
 Hol sie dir alle! - Verzamel ze allemaal! - Collezionali tutti! - Colecione todos eles!

