



# HALO

THE AUTHENTIC COLLECTOR'S SERIES  
LA AUTÉNTICA SERIE PARA COLECCIONISTAS  
SERIE AUTHENTIQUE POUR COLLECTIONNEUR  
DIE AUTHENTISCHE SAMMLER-SERIE • DE AUTHENTIEKE VERPAMMELAARSSERIE  
L'AUTENTICA SERIE PER COLLEZIONISTI • A SERIE DO VERDADEIRO COLECCIONADOR



**96941**

**Covenant Phantom • Phantom de los Covenant • Phantom Covenant  
Covenant-Phantom • Covenant Phantom • Covenant Phantom • Phantom Covenant**





Thank you for purchasing **COVENANT PHANTOM** an authentic licensed product by MEGA Bloks based on the legendary Halo universe. The collectible construction toy line features the heroic UNSC and enemy Covenant vehicles, characters and weapons. Choose an alliance, build the battle and emerge victorious!

Gracias por comprar **PHANTOM DE LOS COVENANT** un producto auténtico con licencia de MEGA Bloks según el legendario Halo universe. La línea de juguetes de construcción coleccionable ofrece vehículos, personajes y armas heroicos de UNSC y enemigos de Covenants. ¡Elije una alianza, elabora la batalla y sal victorioso!

Nous vous remercions d'avoir acheté **PHANTOM COVENANT**, un produit certifié authentique par MEGA Bloks basé sur l'univers légendaire de Halo. La gamme d'articles de construction de collection met en vedette les membres héroïques du CSNU ainsi que les véhicules, personnages et armes de l'ennemi Covenant. Choisissez votre alliance, créez le combat et remportez la victoire.

Vielen Dank für den Kauf von **COVENANT-PHANTOM**. Hierbei handelt es sich um ein authentisches Lizenzprodukt von MEGA Bloks, das auf dem legendären Halo-Universum beruht. Die Spielzeug-Baureihe zum Sammeln besteht aus heldenhaften UNSC- und feindlichen Allianz-Fahrzeugen, Figuren und Waffen. Entscheide Dich, auf welcher Seite du kämpfen willst, baue das Schlachtfeld auf und gehe aus der Schlacht als Sieger hervor!

Hartelijk dank voor het aanschaffen van de of het authentiek gelicentieerde **COVENANT PHANTOM** van MEGA Bloks dat op de legendarische Halo wereld gebaseerd is. De lijn waardevolle bouwpakketten bevat modellen van de heldhaftige Covenant voertuigen, personages en vuurwapens van de UNSC en de vijand. Kies je bondgenoten, vervaardig je slagveld en win het gevecht!

La ringraziamo per avere acquistato **COVENANT PHANTOM** un prodotto autentico con licenza della MEGA Bloks basato sul leggendario universo Halo. La linea di giocattoli da collezione costruibili presenta i veicoli dell'eroica UNSC della nemica Alleanza, con i personaggi e le armi. Scegli un alleato, costruisci la battaglia e vieni fuori vincitore!

Obrigado por adquirir **PHANTOM COVENANT**, um produto autêntico licenciado pela MEGA Bloks baseado no lendário universo de Halo. A linha de brinquedos de construção colecionáveis conta com veículos dos heróis da UNSC e do inimigo Covenant, bem como personagens e armas. Escolha uma aliança, construa a batalha e saia vitorioso!







**HALO**  
THE AUTHENTIC COLLECTOR'S SERIES

Register for the Halo Bloks Brigade!  
Apuntate a la brigada Halo Bloks!  
Enrolez-vous dans la Brigade Halo Bloks!  
Registriere dich fur die Halo-Bloks Brigade! • Schrijf je in voor de Halo Bloks Brigade!  
Effetua la registrazione per la Brigata dei Blok Halo! • Regista-te para a Brigada Halo Bloks!

[halo.megabloks.com](http://halo.megabloks.com)

[www.facebook.com/halomegabloks](https://www.facebook.com/halomegabloks)   
[twitter.com/megabrands](https://twitter.com/megabrands) 

**MEGA  
BLOKS**



- 14X AMO7223MM
- 4X MAO3328MM
- 4X MAI140MM
- 9X AMI7003F
- 4X MAO2250IMM
- 4X MAO9393MM
- 16X AMI8756MM
- 2X AMI6680MM
- 1X AMI5480MM
- 1X AMI548IMM
- 8X MAI314MM
- 6X MAI5484MM
- 1X AMI8666MM
- 1X AMI8665MM

- 2X MAI086MM
- 4X MAO4430MM
- 2X MAO9013MM
- 1X AMI6968MM
- 2X AMI715IMM
- 1X AMI6967MM
- 16X MAI146MM
- 1X MAO3773MM
- 1X MAO948MM
- 14X MAI8329MM
- 15X MAI8328MM
- 1X AMI8527MM
- 4X AMO9106MM
- 1X AMI8746MM

- 4X MAI418MM
- 8X MAI139MM
- 1X AMI8742MM
- 1X AMI874IMM
- 2X AMI8658MM
- 2X AMI8715MM
- 6X MAO9593MM
- 2X AMI5492MM
- 4X MAI087MM
- 5X MAO9493MM
- 2X AMO3323MM
- 2X AMO3324MM

- 4X AMI7021MM
- 4X AMI8712MM
- 6X AMI8711MM
- 1X AMI8714MM
- 1X AMI8713MM
- 4X AS9694107
- 2X AMI8676MM
- 3X AMO4434MM
- 3X AMO4433MM
- 4X AMI8276MM
- 2X AMI7285MM

- 1X MAO9033MM
- 2X AMI8598MM
- 6X MAO9292MM
- 3X MAI480MM
- 10X MAO8483MM
- 7X MAO9923MM
- 4X AMI7055MM
- 4X AMO7646MM
- 2X AMO9924MM
- 3X AMI5476MM

- 1X AMI7611F
- 3X AMI7152MM
- 2X AMI8707MM
- 2X AMI8706MM
- 1X AMI8674MM
- 1X AMI8675MM
- 2X AMI8677MM
- 2X AMI8611MM

- 5X AMI78705X
- 3X AMI7003HJ
- 1X AMO8412HJ
- 12X MAO9393F
- 6X MAI314F
- 2X AMI8665F
- 2X AMI8666F
- 20X MAO33285X
- 2X MAI1405X
- 12X AMO76595X
- 14X MAI0865X
- 2X AMI87405X
- 12X AMI87105X
- 4X AMO43225X
- 39X MAO93935X
- 8X MAO44295X

- 1X MAO30195X
- 15X MAO90135X
- 2X AMO27995X
- 8X MAI54845X
- 3X AMI86655X
- 3X AMI86665X
- 4X MAO9485X
- 18X MAO37735X
- 2X AMO84805X
- 4X AMI71535X
- 4X MAI3235X
- 8X AMI63845X

- 10X MAO90235X
- 6X AS9694106
- 4X AMI82135X
- 1X AMI87755X
- 1X AMI87765X
- 4X MAI1395X
- 2X AMI70215X
- 4X AMI70745X
- 4X AMI70735X
- 10X MAI3145X
- 20X MAO95935X
- 19X MAO37725X
- 1X AMO44335X
- 1X AMO44345X

- 8X AMI87325X
- 2X AMI86575X
- 6X AMI86555X
- 2X AMO84165X
- 41X MAO94935X
- 1X AMO33245X
- 1X AMO33235X
- 2X AMI87365X
- 12X MAO38735X
- 11X MAI0875X
- 26X MAO90335X
- 15X MAO9033AMC
- 1X MO9033W
- 6X AS9694105

- 1X AMI87375X
- 1X AMI87385X
- 4X AMO42445X
- 2X AMI87185X
- 2X AMI87175X
- 2X AMI87345X
- 2X AMI87355X
- 12X AMI86565X
- 4X AMI87315X
- 8X AMI86535X
- 2X AMI86545X



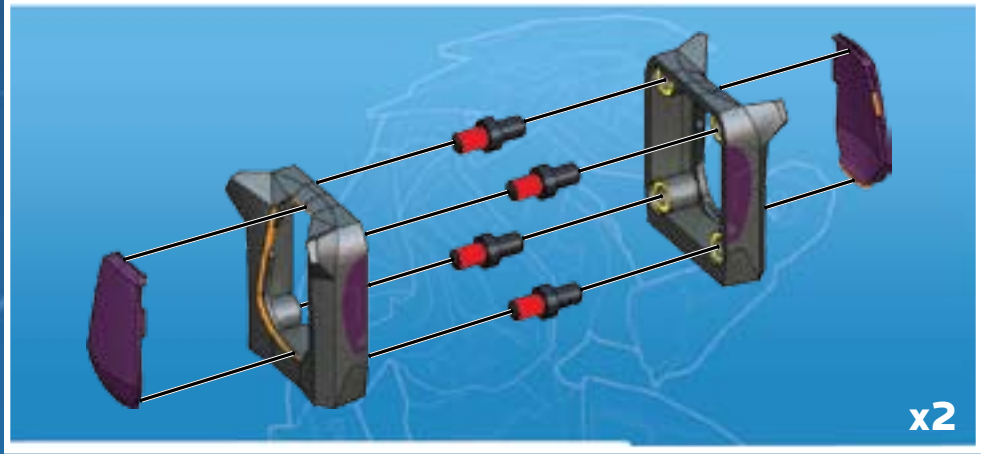
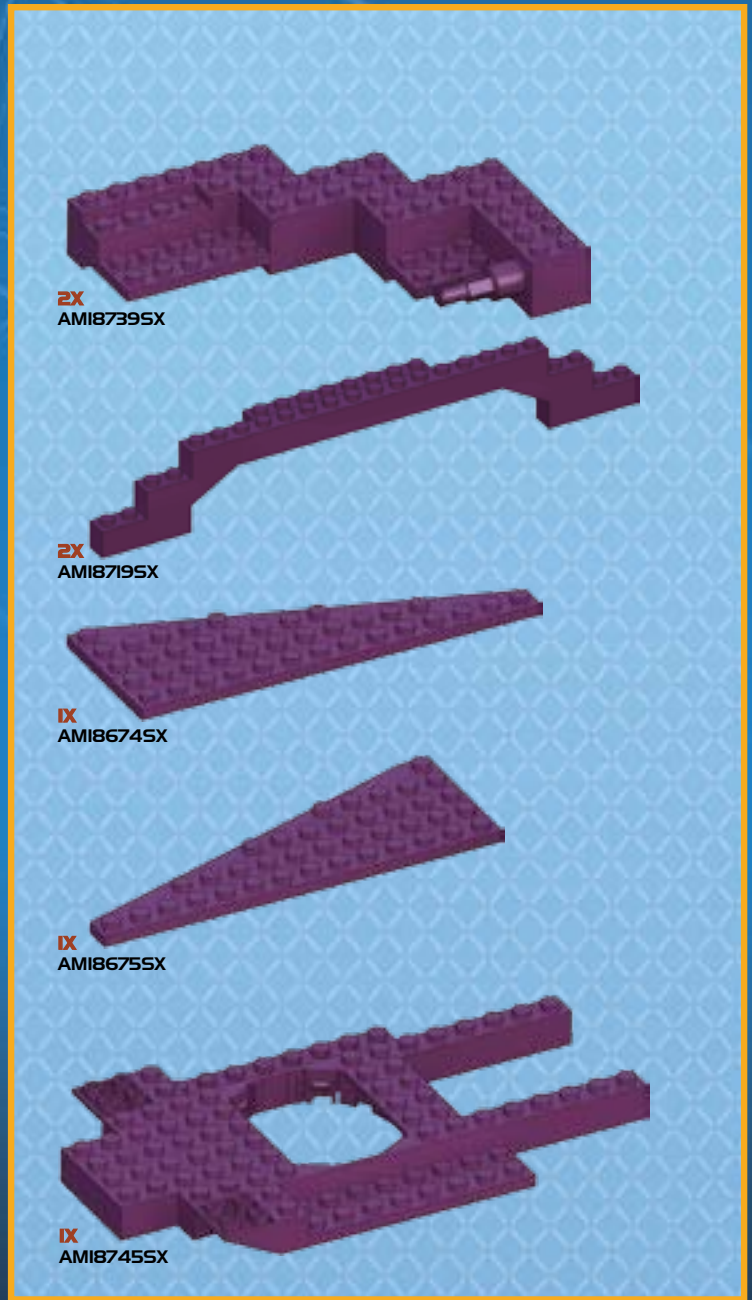
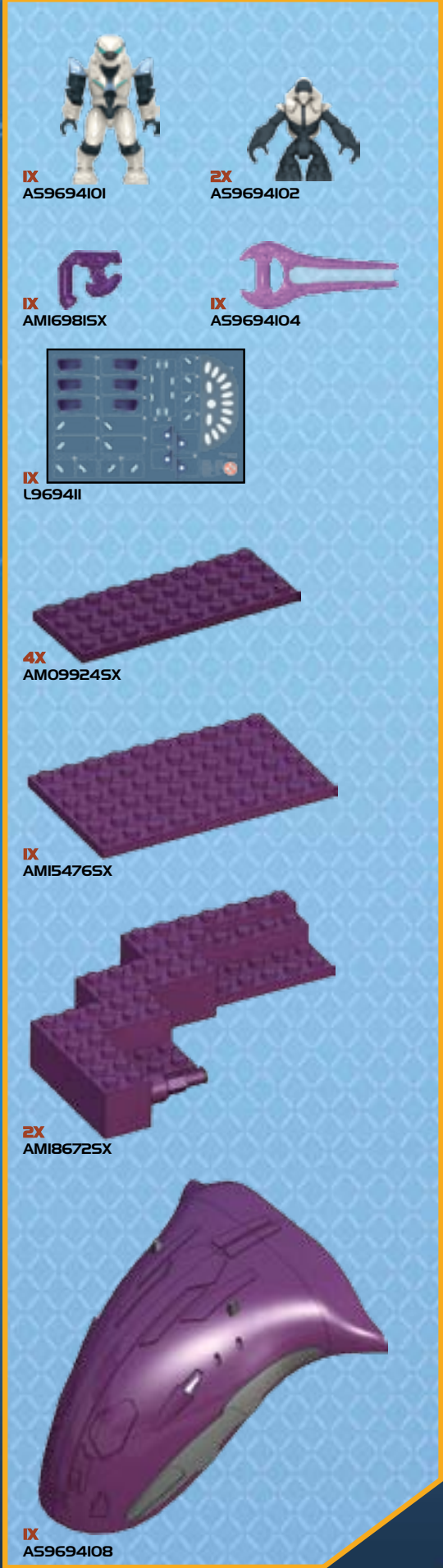

**EN** Please read these instructions carefully before first use and keep them for future reference.  
**ES** Leer estas instrucciones cuidadosamente antes de la primera utilización y guardarlas para referencia futura.  
**FR** Il est recommandé de lire attentivement ce feuillet avant la première utilisation et de le conserver pour référence future.  
**DE** Die Gebrauchsanleitung bitte durchlesen und aufbewahren.  
**NL** Wij raden u aan deze handleiding zorgvuldig te lezen en te bewaren voor eventuele raadpleging op een later tijdstip.  
**DA** Vær venlig at læse disse instruktioner omhyggeligt inden ibrugtagningen og opbevar dem til fremtidigt brug.  
**EL** Διαβάστε αυτές τις οδηγίες προσεκτικά πριν χρησιμοποιήσετε το προϊόν για πρώτη φορά και φυλάξτε τις για μελλοντική αναφορά.  
**FI** Lue nämä ohjeet huolellisesti ennen ensimmäistä käyttöä ja säilytä ne myöhempää tarvetta varten.  
**IT** Leggere le istruzioni prima di cominciare ad usare il gioco e conservarle per referenze future.  
**NO** Les disse instruksjonene nøye før første gangs bruk, og ta vare på dem for fremtidige oppslag.  
**PT** Leia as instruções antes do primeiro uso e guarde-as para futura referência.  
**SU** Läs noggrant igenom dessa instruktioner innan du använder produkten för första gången och spara dem för ev. framtida frågor.  
**JA** 初めてご使用になる前に、この説明書をよくお読みください。また、本書は将来いつでも参照できるように保管してください。  
**ZH** 请在初次使用前仔细阅读这些指示，并保留它们以便未来参考。  
**AR** يرجى قراءة هذه التعليمات بدقة قبل البدء بالاستعمال والاحتفاظ بها كمرجع للمستقل.

**EN** ⚠️ **WARNING :**  
**CHOKING HAZARD.** - Small parts.  
 Toy contains a small ball.  
 Not for children under 3 years.

**ES** ⚠️ **ADVERTENCIA :**  
**PELIGRO DE ASFIXIA.** - Contiene piezas pequeñas.  
 El juguete contiene una bola pequeña.  
 No recomendado para niños menores de 3 años.

**FR** ⚠️ **AVERTISSEMENT :**  
**RISQUE DE SUFFOCATION.** - Présence de petits éléments.  
 Le jouet contient une petite balle.  
 Ne convient pas aux enfants de moins de 3 ans.

**DE** ⚠️ **WARNUNG :**  
**ERSTICKUNGSGEFAHR.** - Enthält kleine Teile.  
 Ein kleiner Ball ist im Spielzeug inbegriffen.  
 Nicht für Kinder unter 3 Jahren geeignet.

**NL** ⚠️ **WAARSCHUWING :**  
**VERSTIKKINGSGEVAAR.** - Bevat kleine onderdelen.  
 Speelgoed bevat een klein balletje.  
 Niet geschikt voor kinderen onder de 3 jaar.

**DA** ⚠️ **ADVARSEL :**  
**KVÆLNINGSFARE.** - Indeholder smådele.  
 Legetojet indeholder en lille bold.  
 Ikke til børn under 3 år.

**EL** ⚠️ **ΠΡΟΕΙΔΟΠΟΙΗΣΗ :**  
**ΚΙΝΔΥΝΟΣ ΠΝΕΙΜΑΤΟΣ.** - Περιέχει μικρά αντικείμενα.  
 Το παιχνίδι περιέχει ένα μπαλάκι.  
 Όχι για παιδιά κάτω των 3 ετών.

**FI** ⚠️ **VAROITUS :**  
**TUKEHTUMISVAARA.** - Sisältää pieniä osia.  
 Lelun sisältyy pieni pallo.  
 Ei alle 3-vuotiaille lapsille.

**PT** ⚠️ **ATENÇÃO :**  
**PERIGO DE ASFIXIA.** - Contém peças pequenas.  
 O brinquedo contém uma pequena bola.  
 Não é concebido para crianças de menos de 3 anos.

**SU** ⚠️ **VARNING :**  
**KVÄVNINGSRISK.** - Innehåller små delar.  
 Leksaken innehåller en liten boll.  
 Inte för barn under 3 år.

**JA** ⚠️ **警告 :**  
 窒息の危険性 - 小さな部品が含まれています  
 小さな玉が含まれています。  
 3歳以下の子供には与えないで下さい。

**ZH** ⚠️ **警告 :**  
 有窒息危险 - 包含有小部件  
 此玩具含有一个球。  
 不适合3岁以下的儿童玩。

**AR** ⚠️ **تحذير :**  
 خطر اختناق - قطع صغيرة.  
 تحتوي اللعبة على كرة صغيرة.  
 غير صالحة للأطفال أقل من 3 سنوات.

Get the free mobile app for your phone  
<http://gettag.mobi>

© 2011 MICROSOFT CORPORATION. ALL RIGHTS RESERVED. MICROSOFT, 343 INDUSTRIES, THE HALO LOGO, XBOX, XBOX 360, AND THE XBOX LOGOS, ARE TRADEMARKS OF THE MICROSOFT GROUP OF COMPANIES.



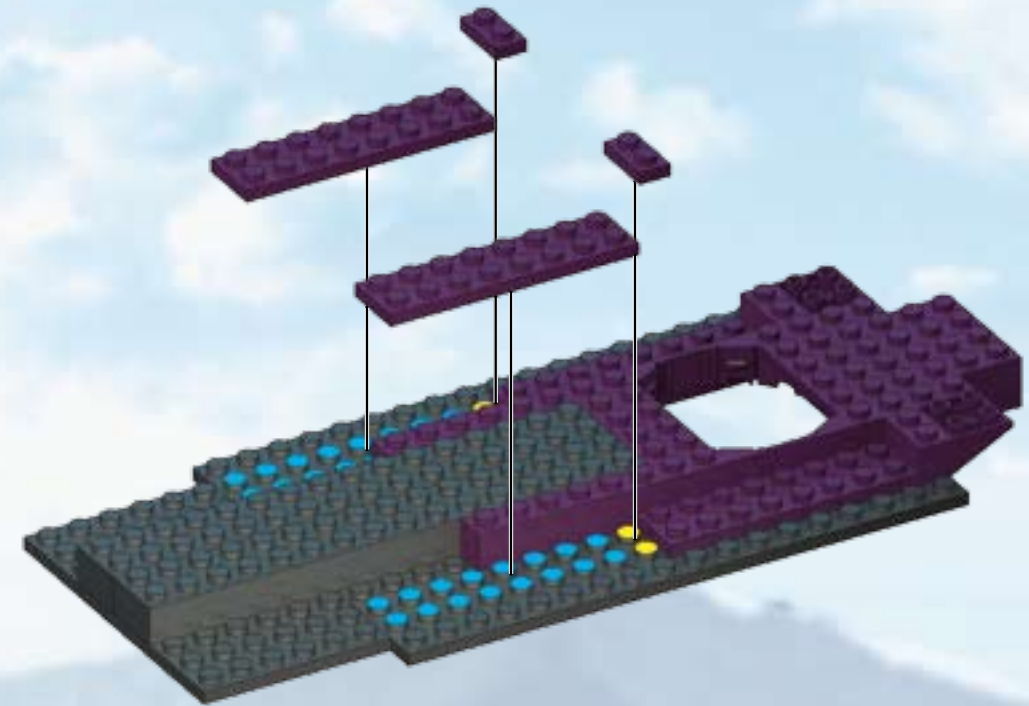
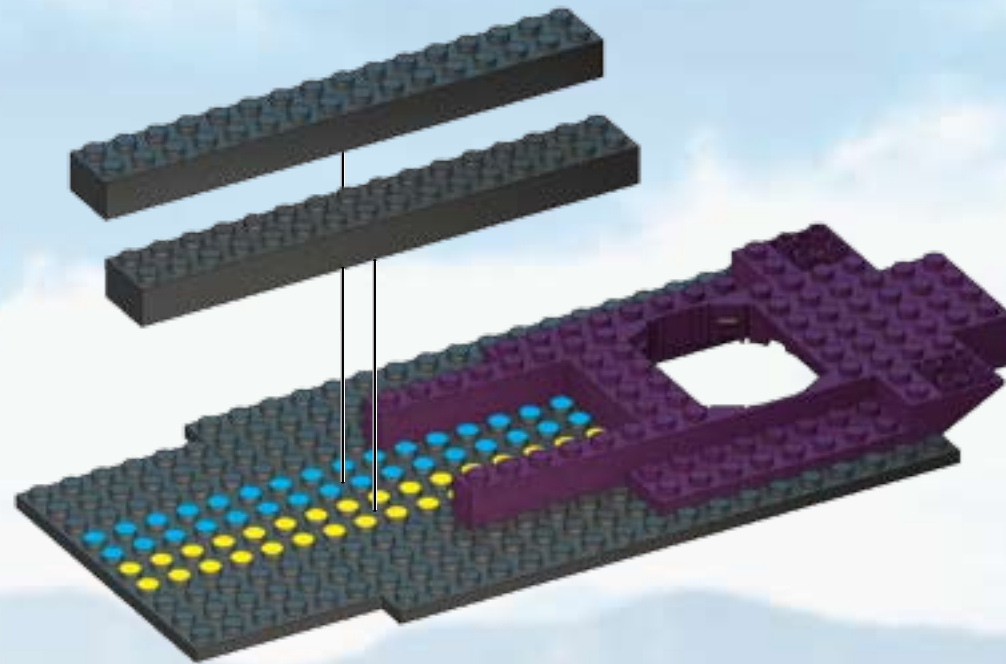
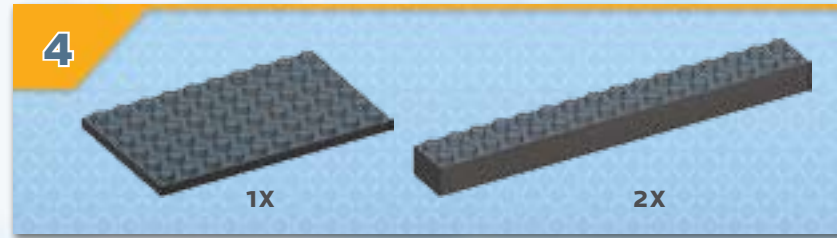
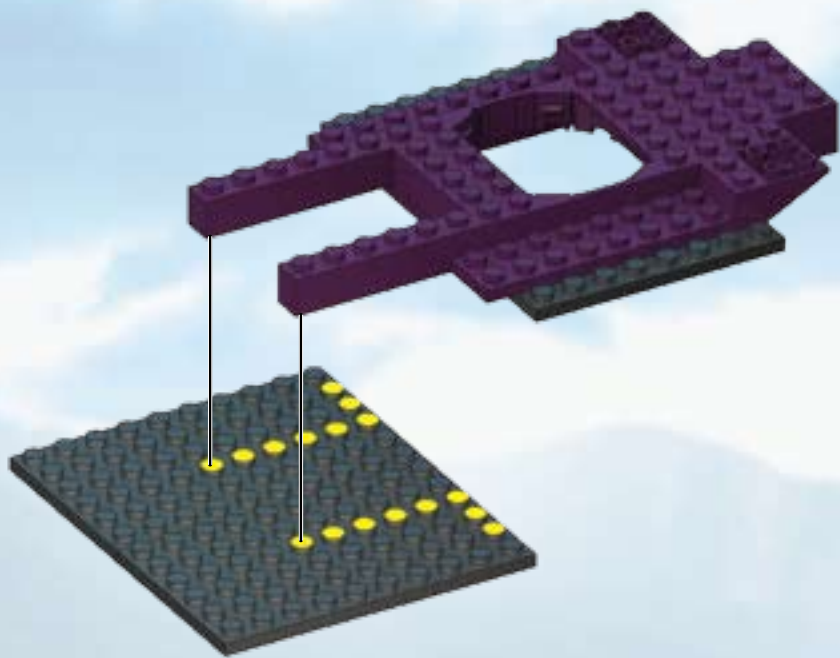
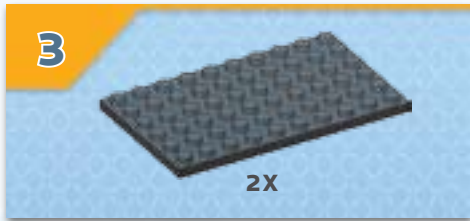
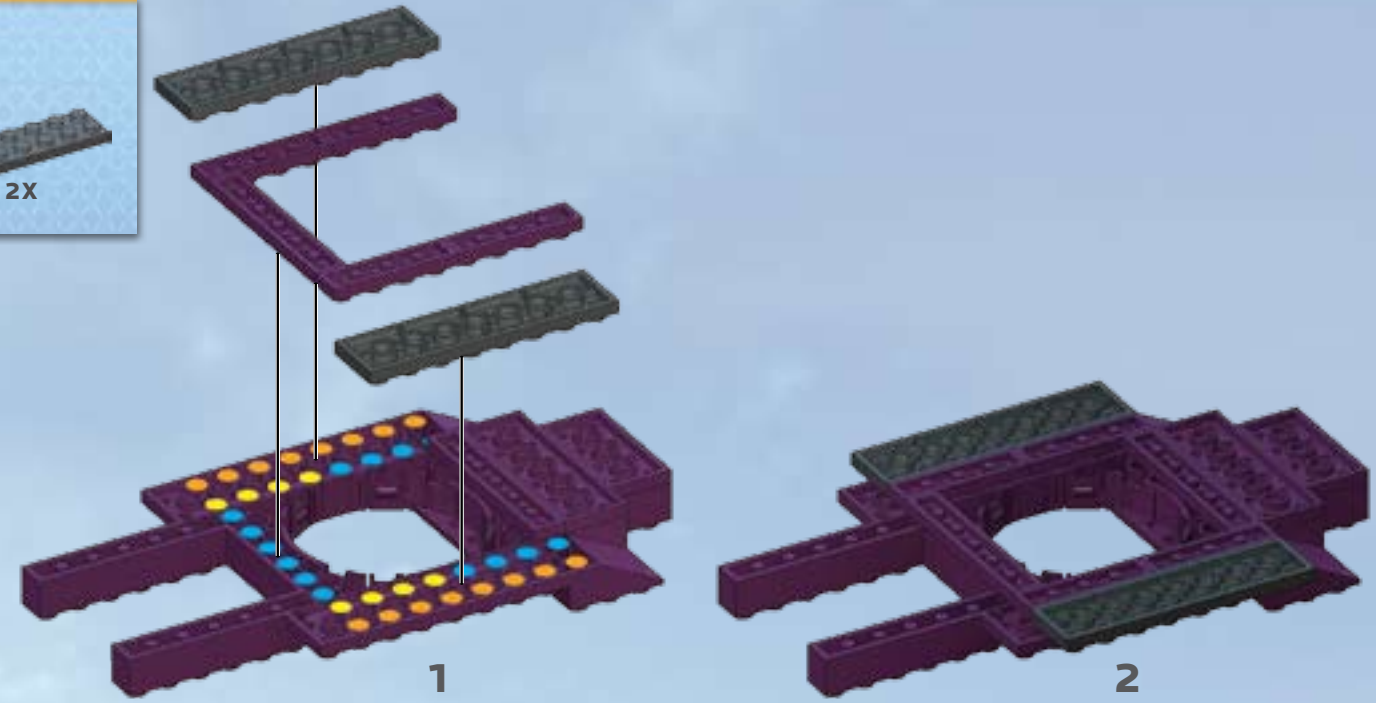
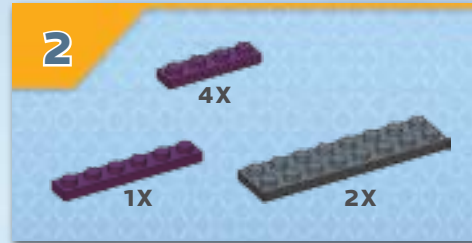
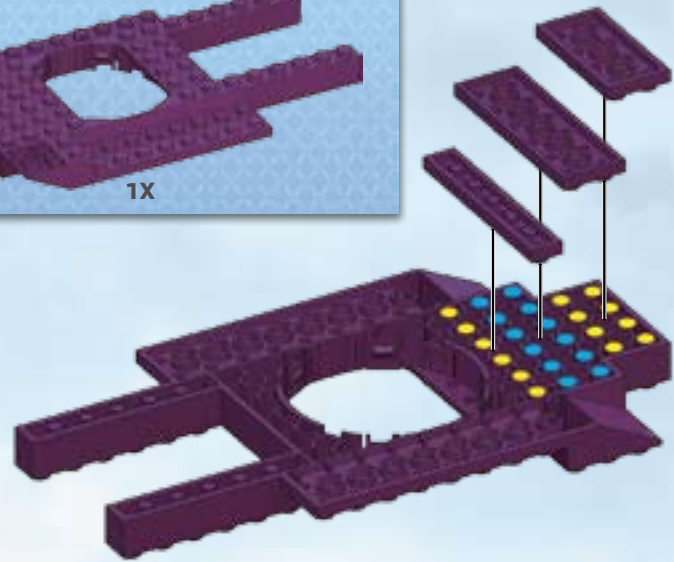
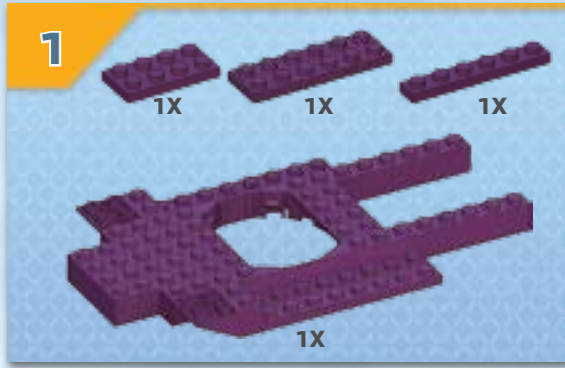



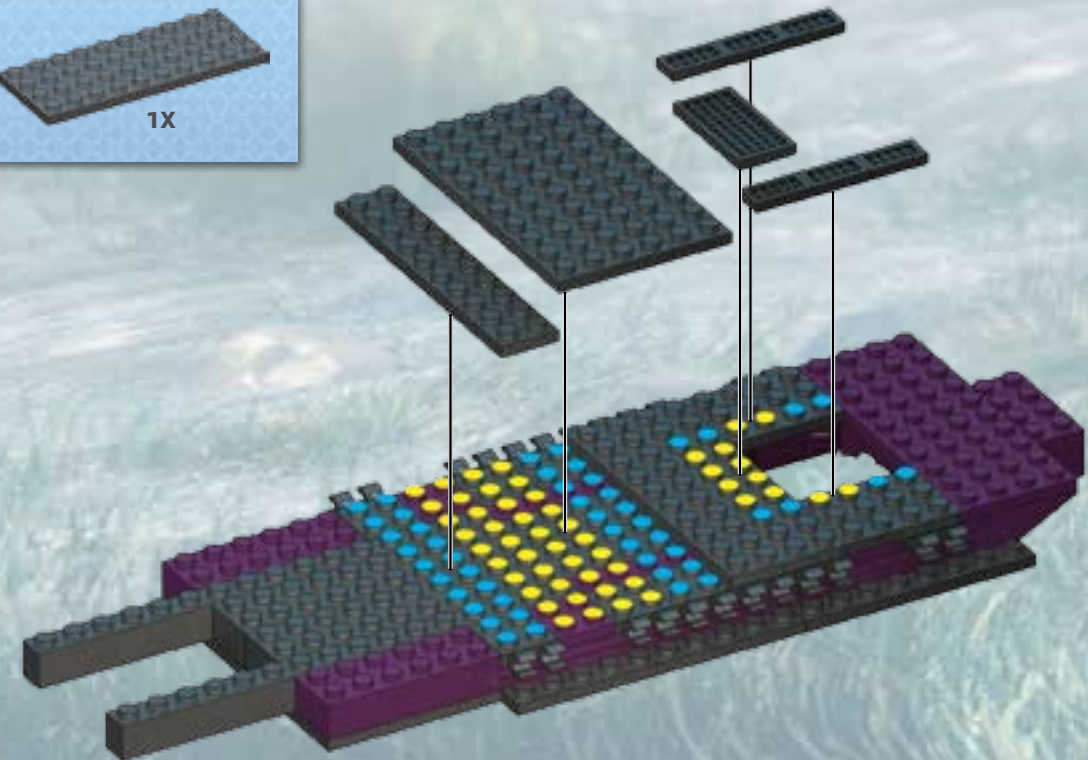
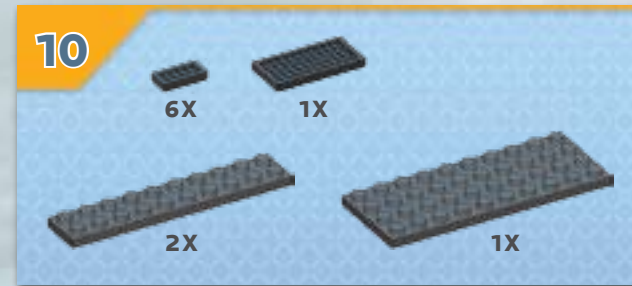
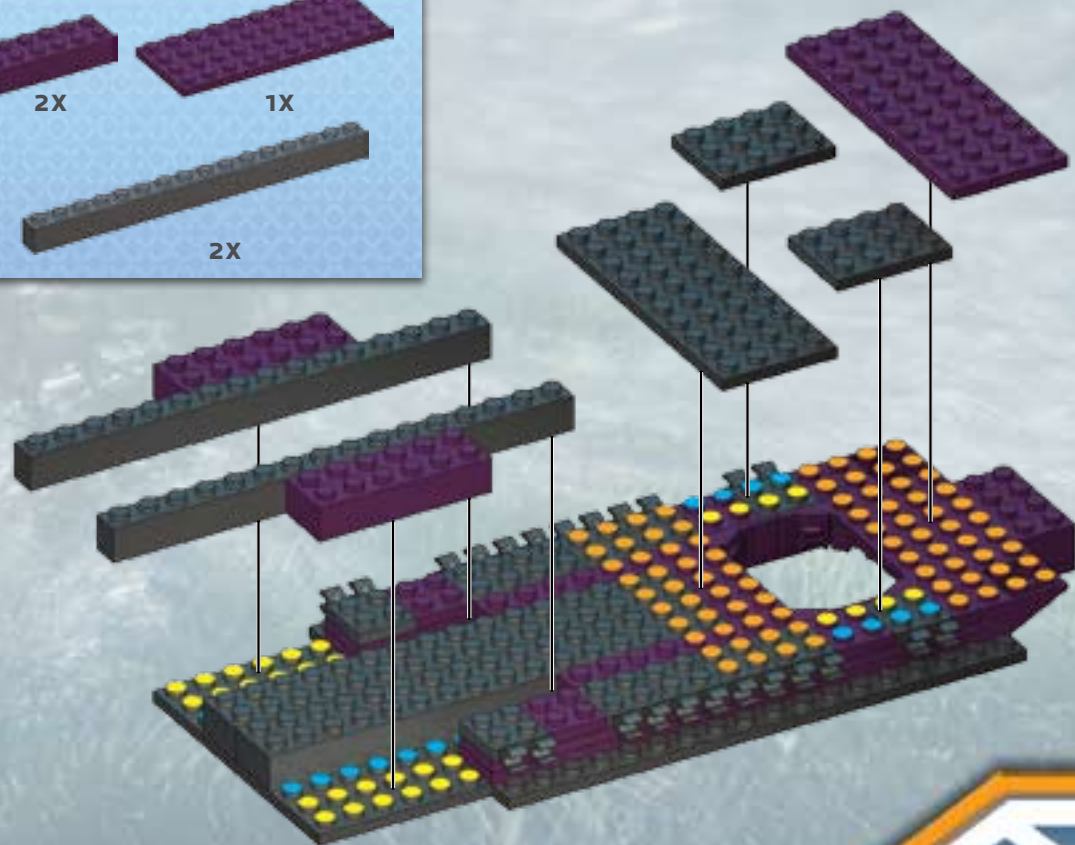
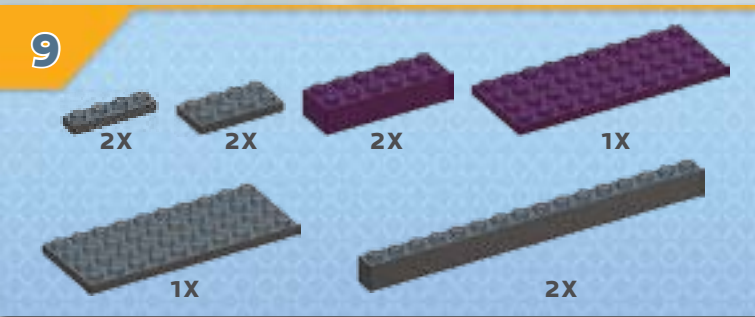
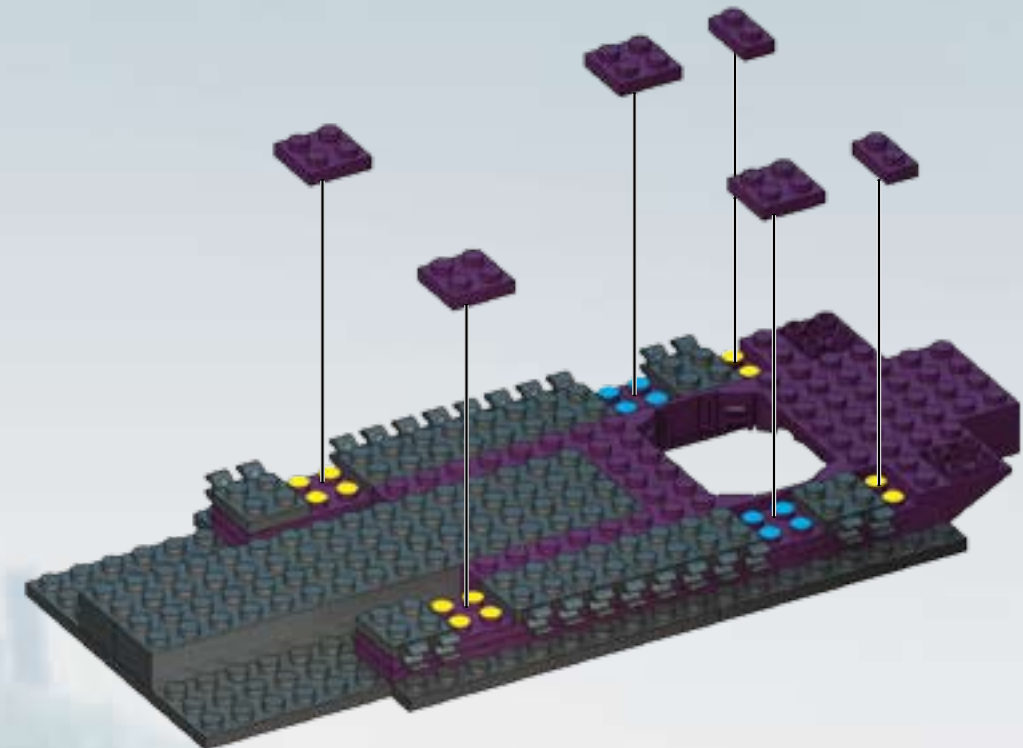
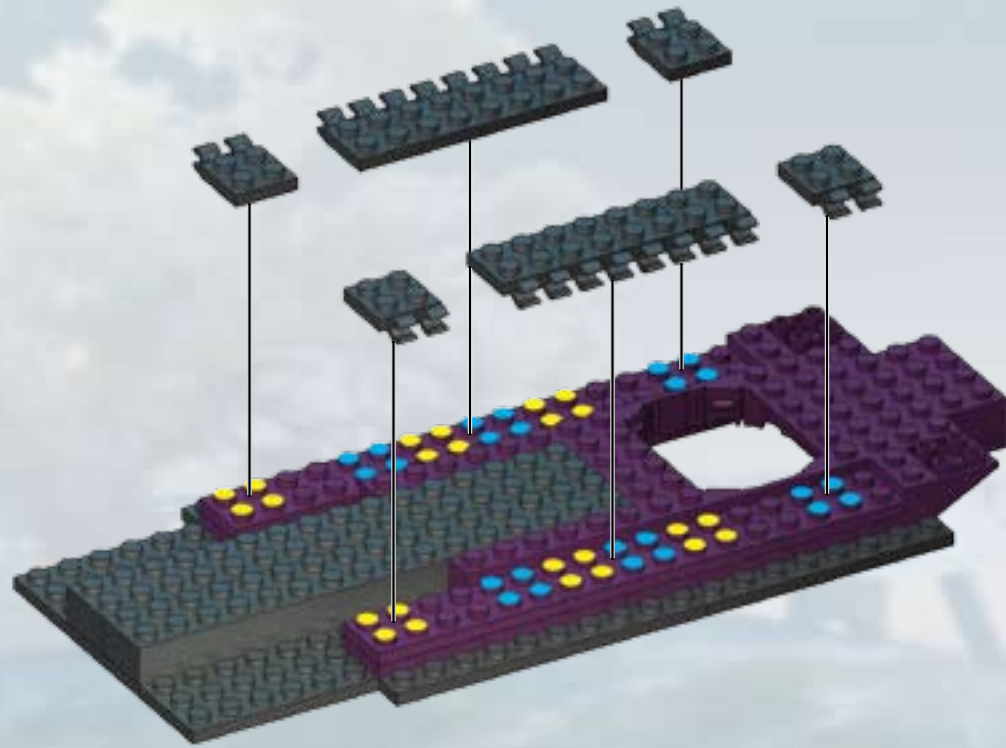
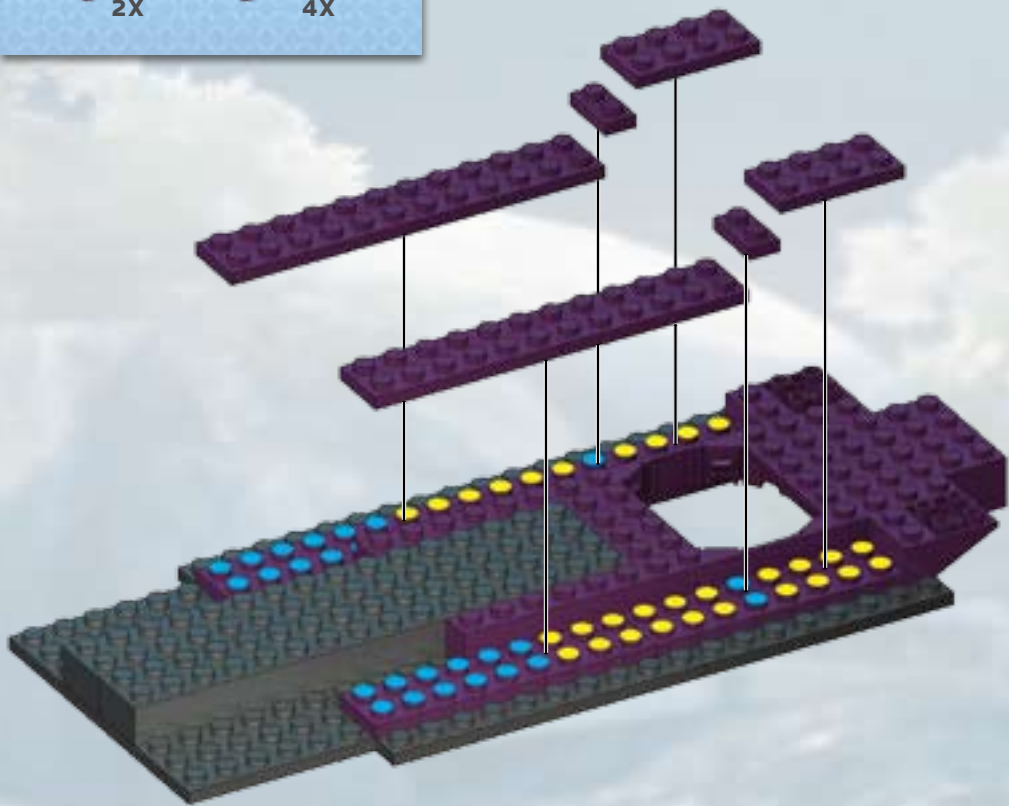
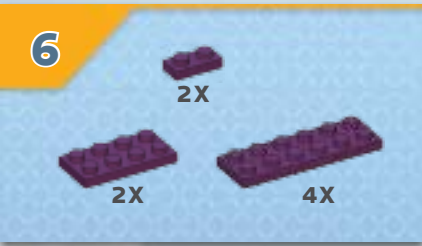



**11**

- 2X
- 2X
- 1X
- 1X

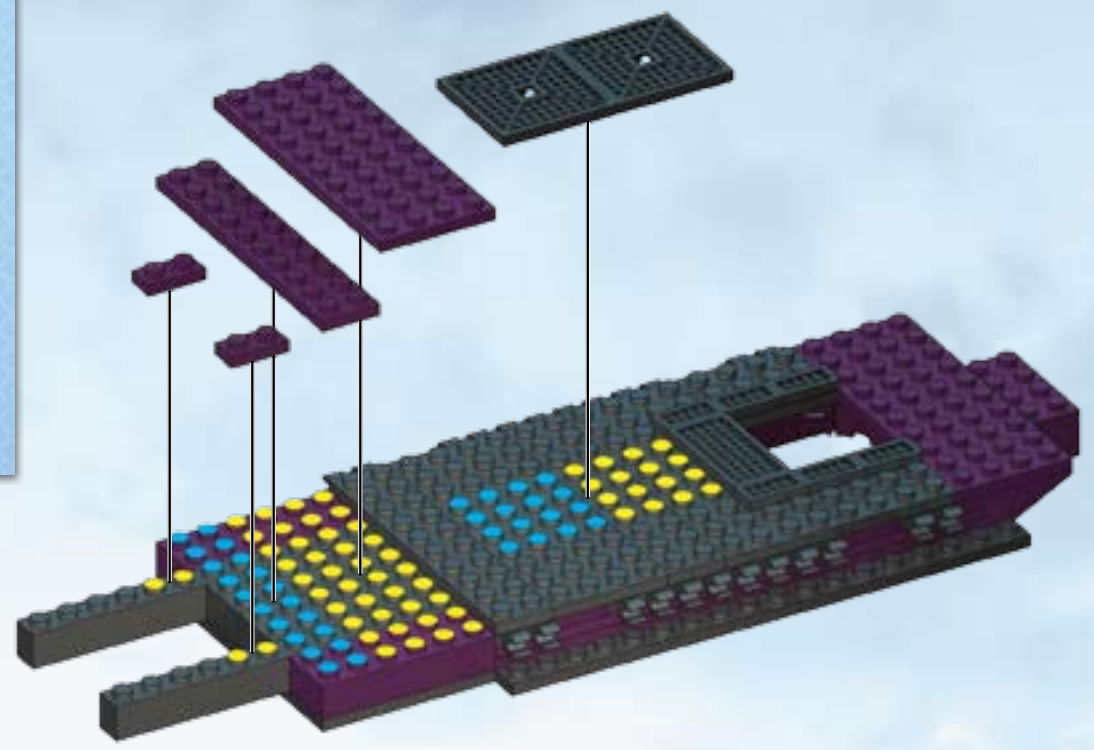

**12**

- 10X
- 1X

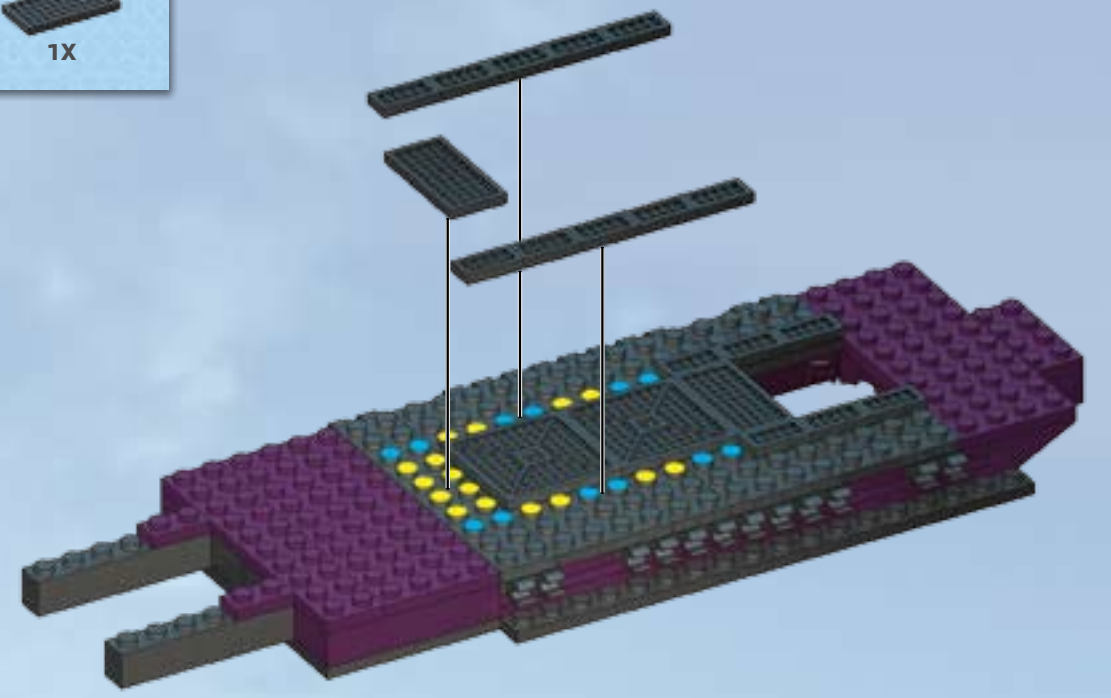

**13**

15X

1      2

x5

Place temporary pieces.  
Colocar las piezas provisionales.  
Installer les pièces temporaires.  
Provisorische Teile einsetzen.  
Instaleer de tijdelijke onderdelen.  
Piazzare i pezzi temporanei.  
Colocar peças temporárias.

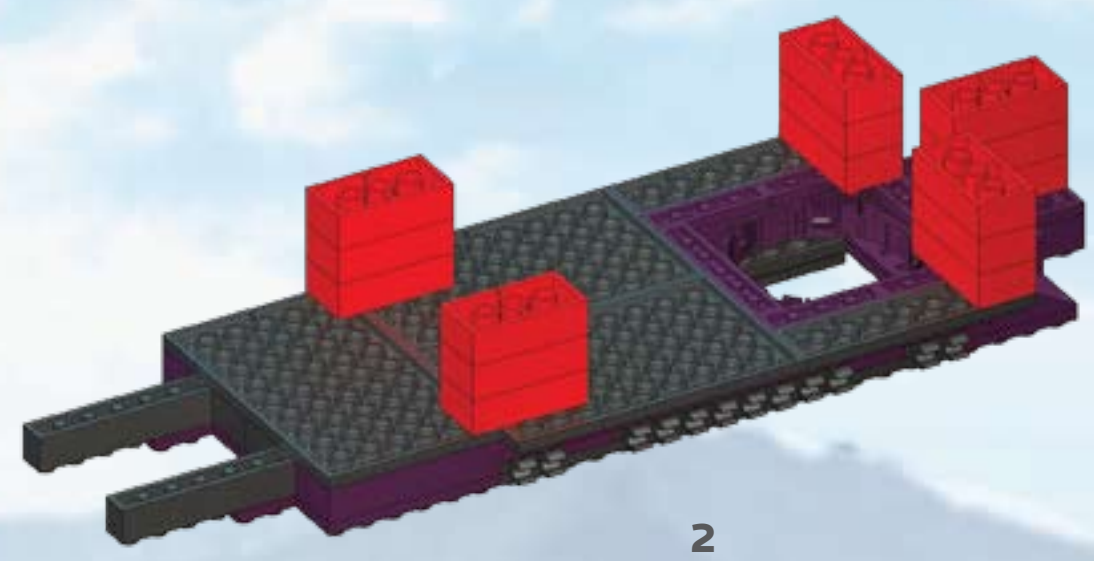
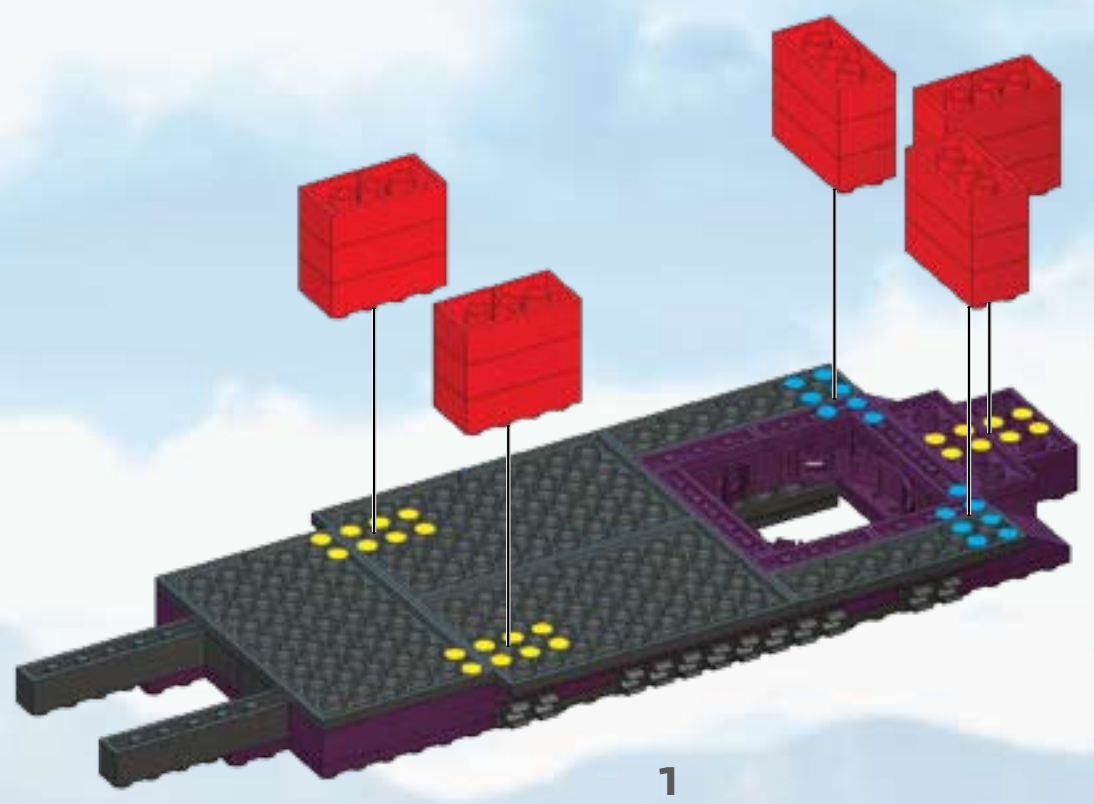



14



1

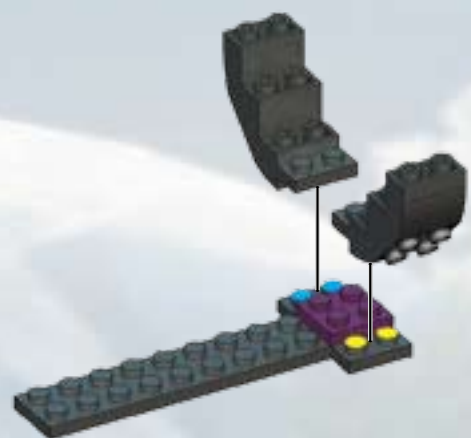

2

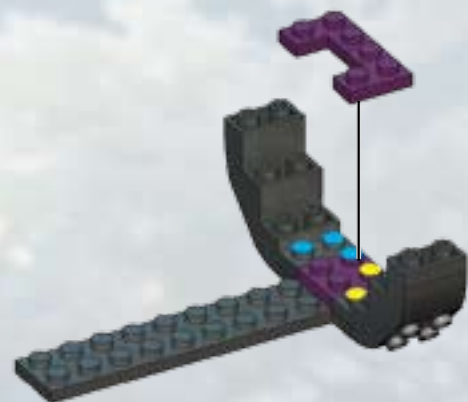

3



4

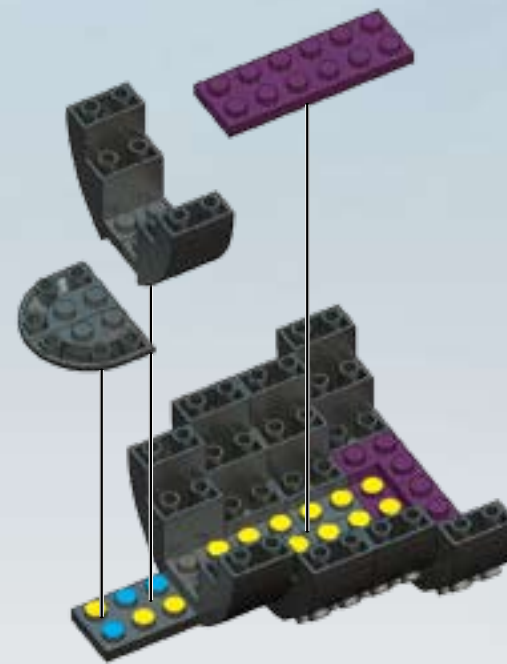

5



6

15



16

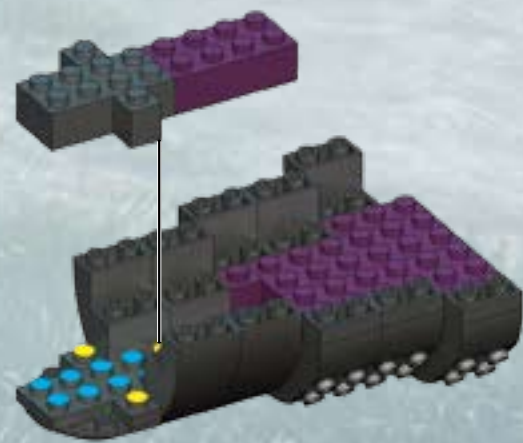
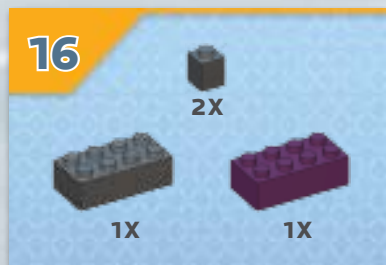

17

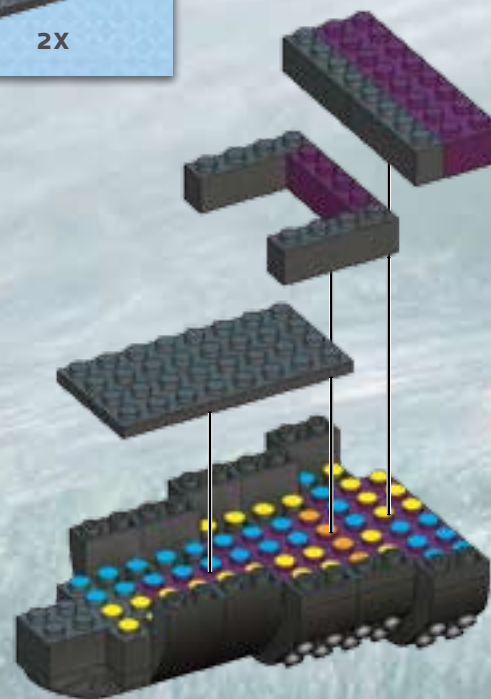
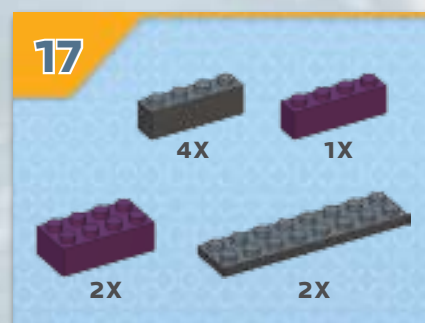

18

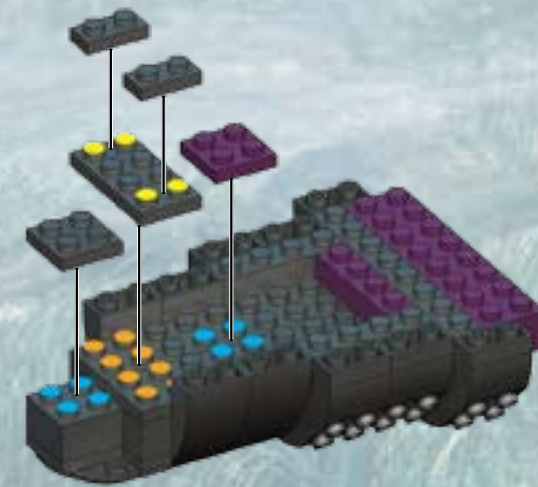
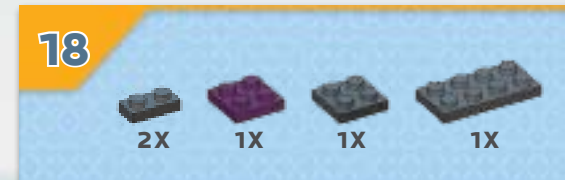



**19**



2X  
1X  
1X

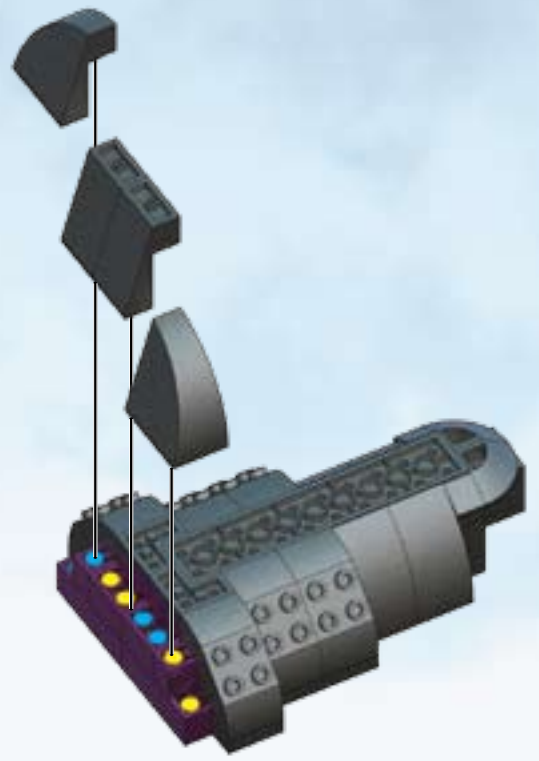

1

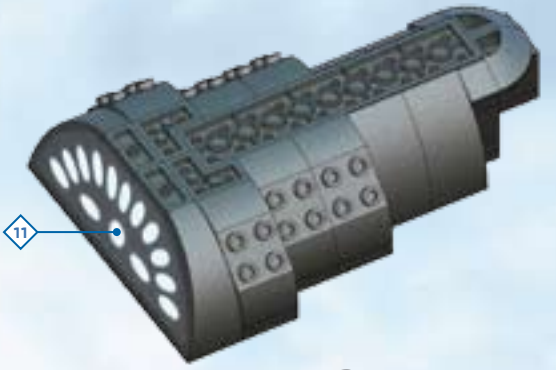

2

**20**



2X 2X 2X 1X 2X

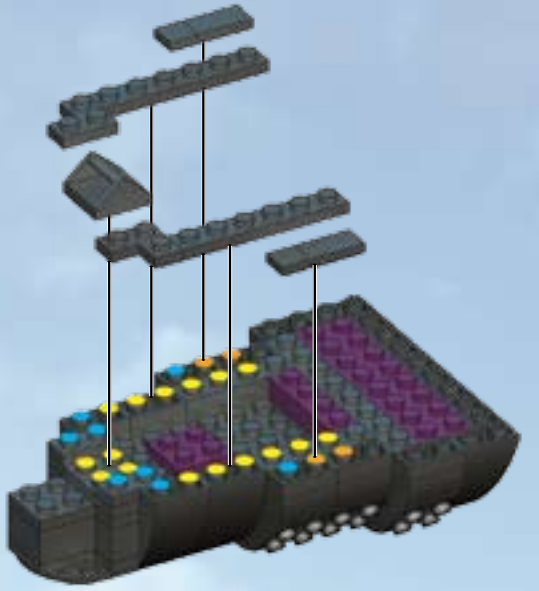

1



2

**21**



2X

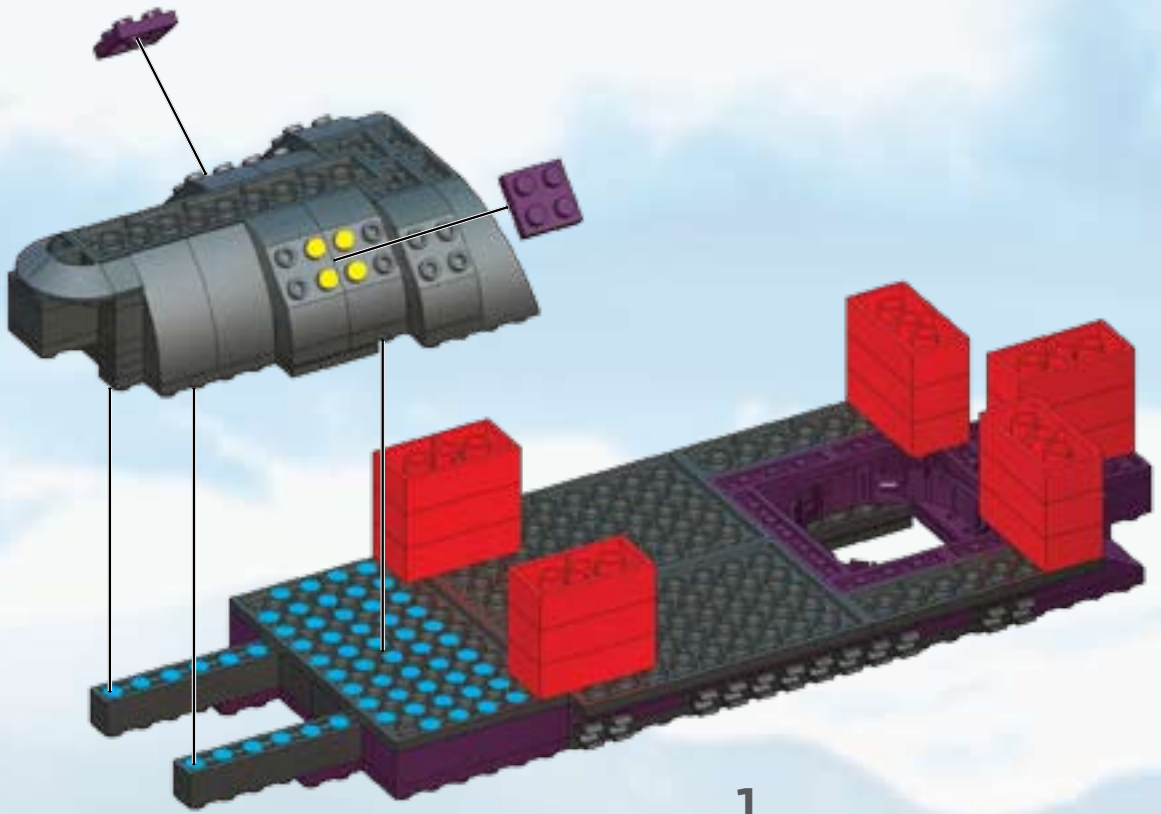

1

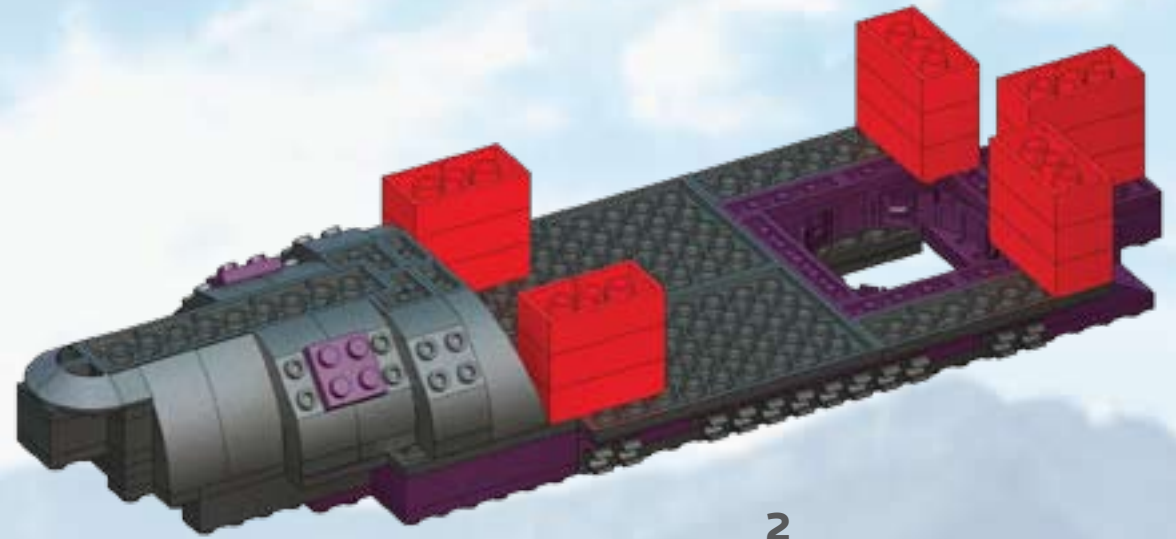

2



**22**

2X	2X
4X	4X
	2X

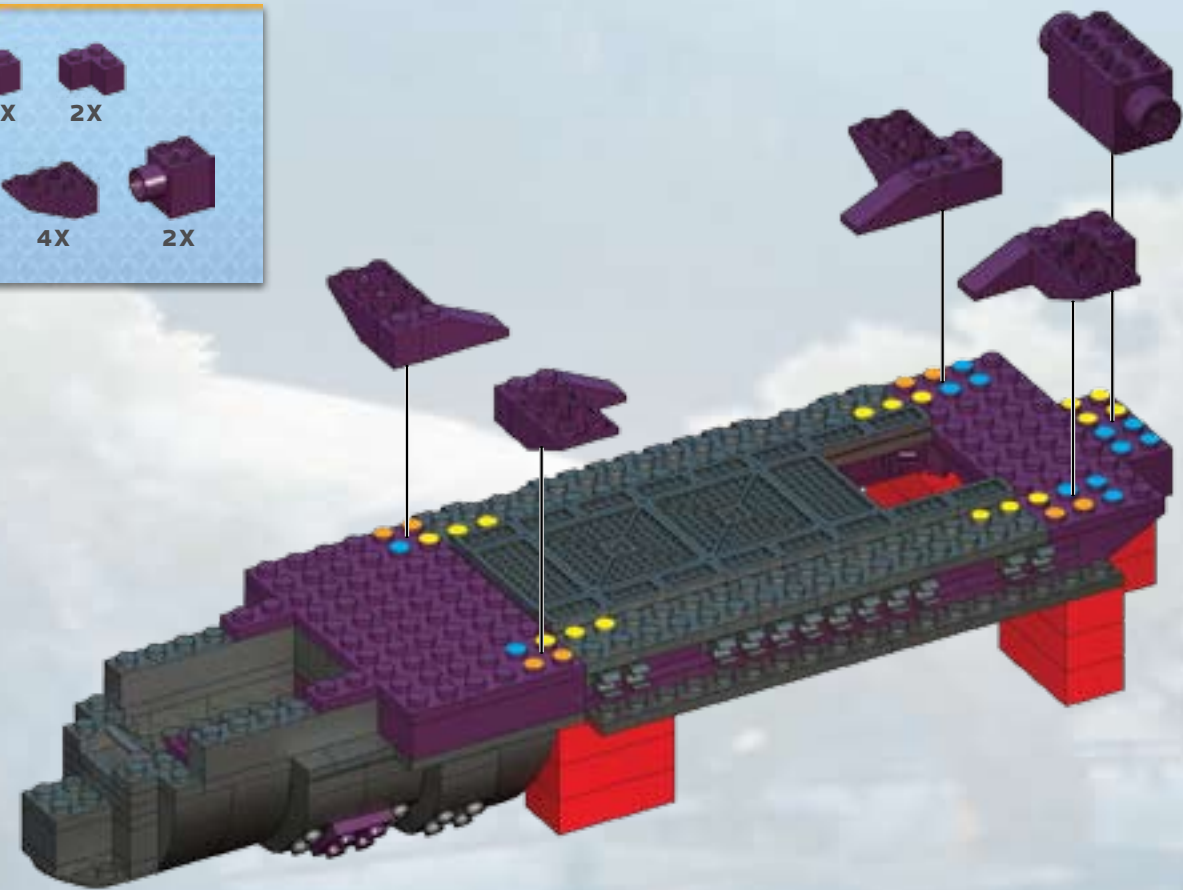

**23**

5X	3X

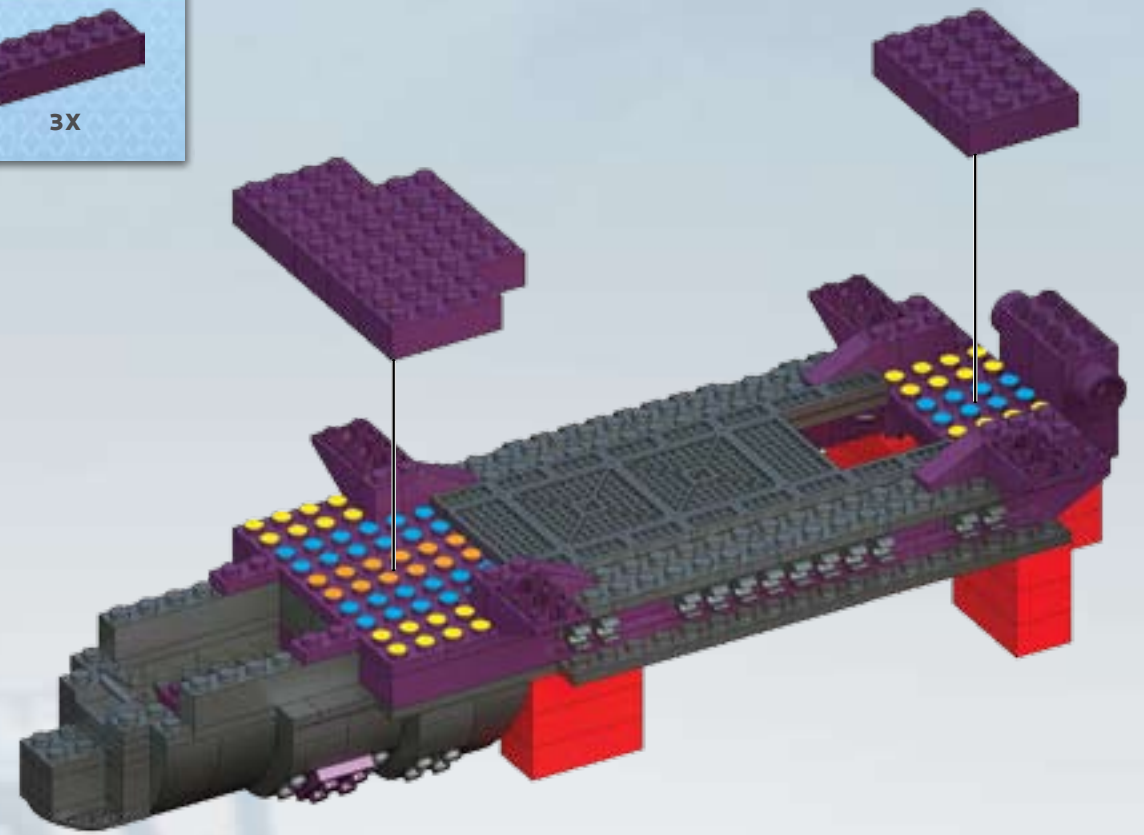

**24**

2X	2X	2X

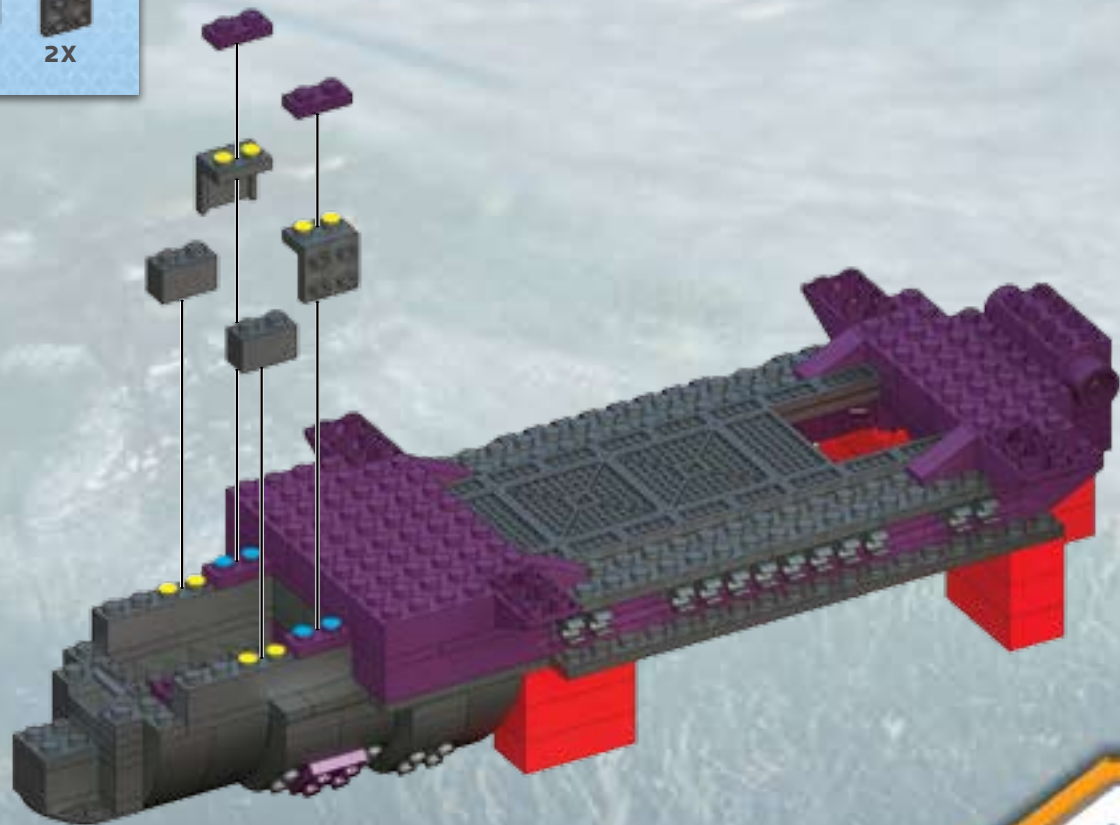

**25**

1X	2X	2X
2X	1X	
1X	1X	

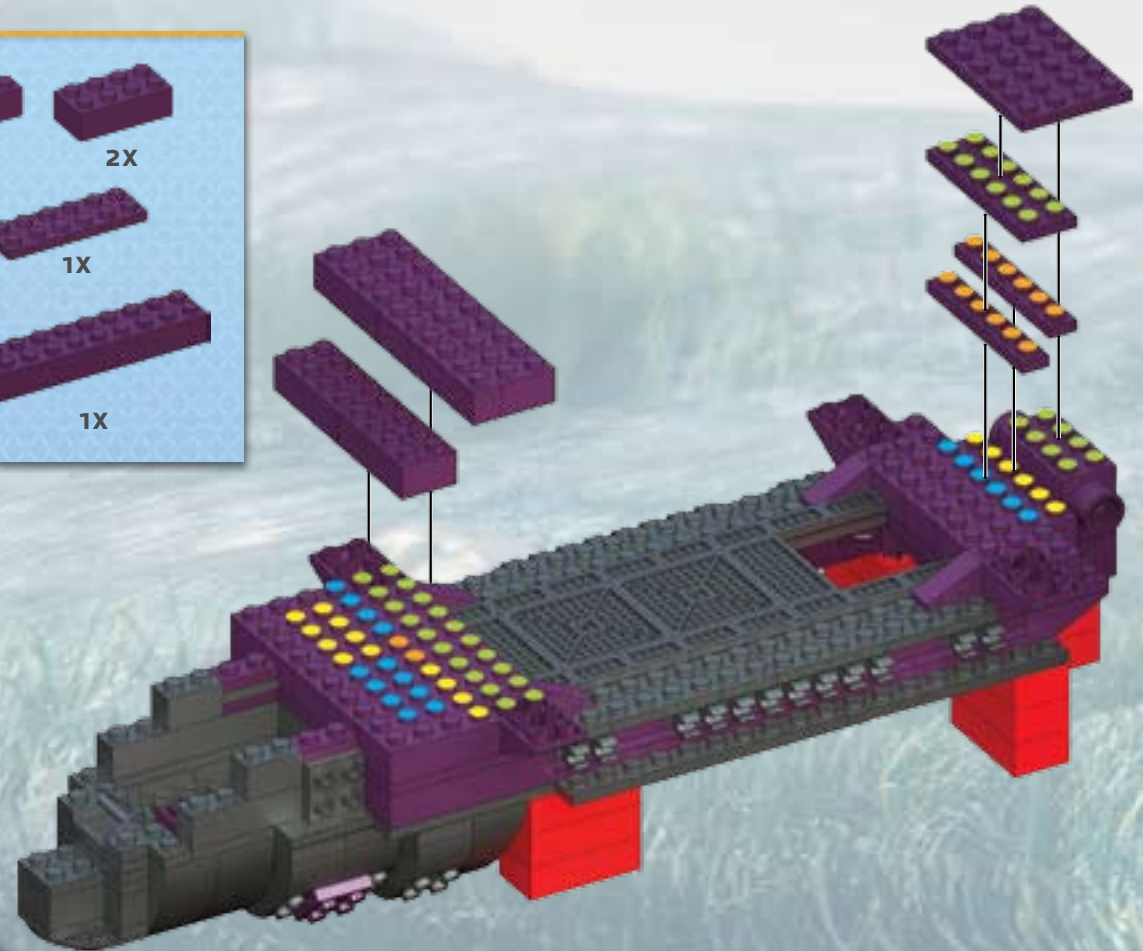



26

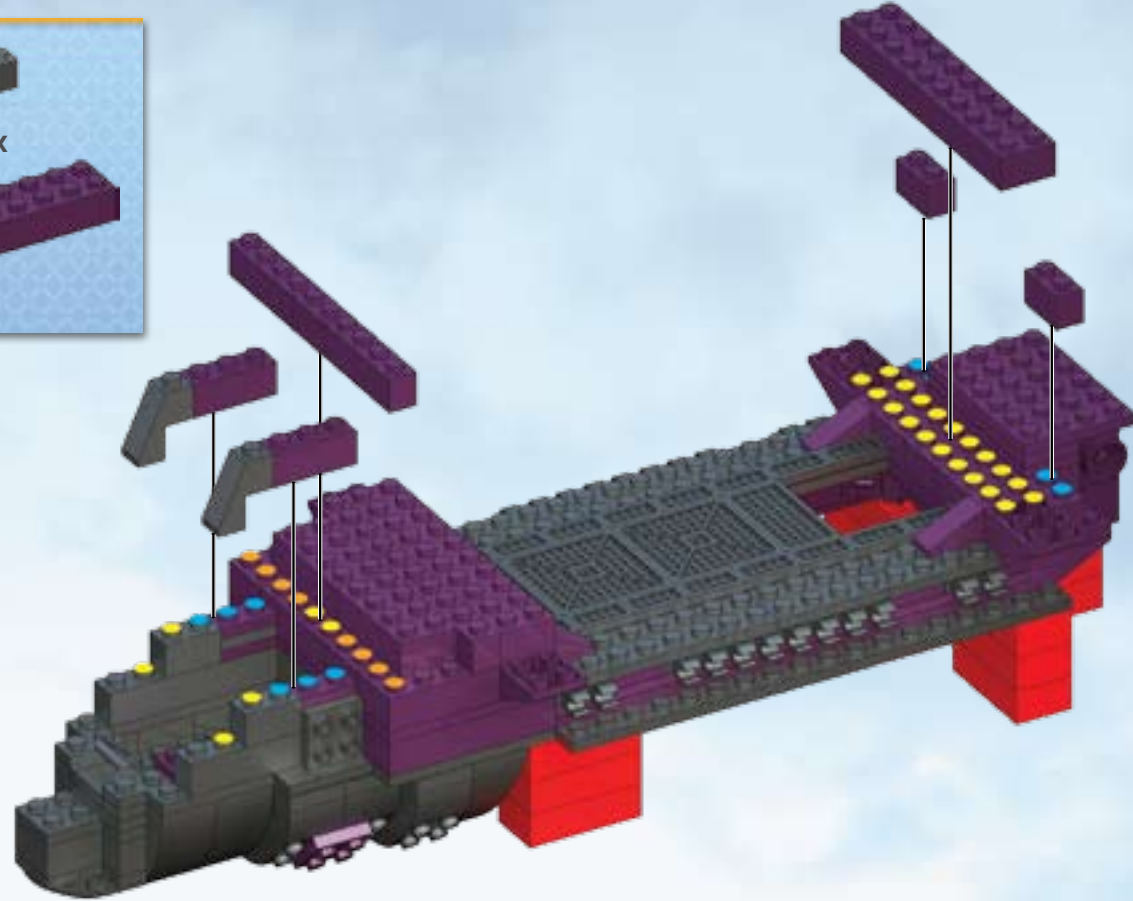
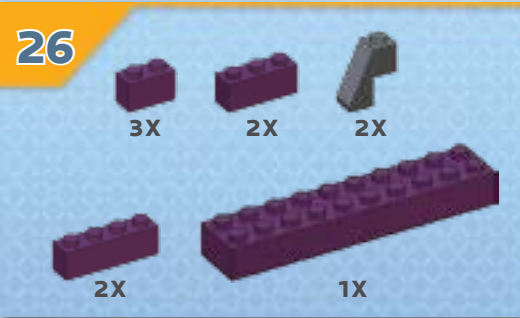

27

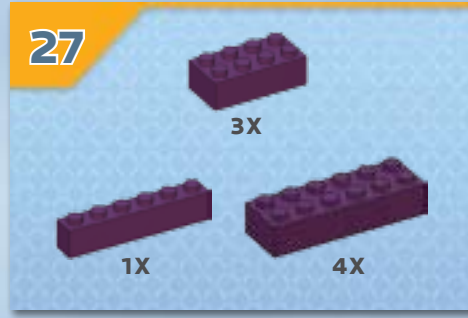

28

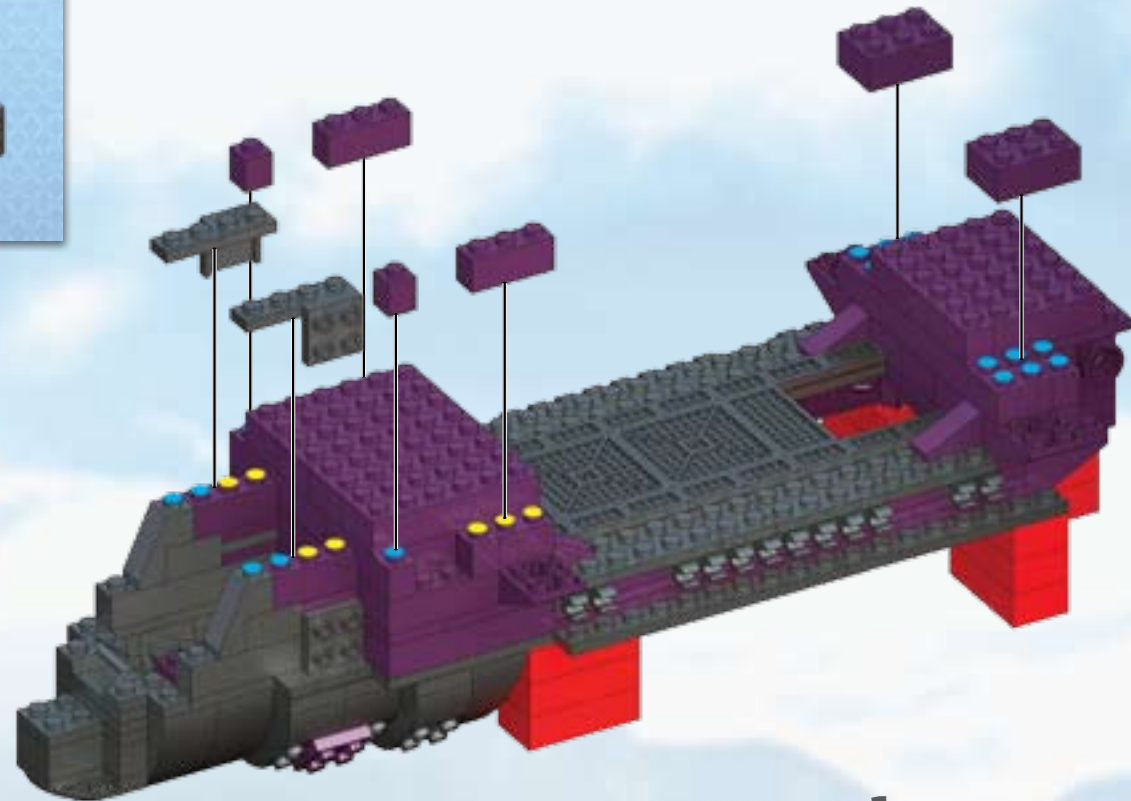

1

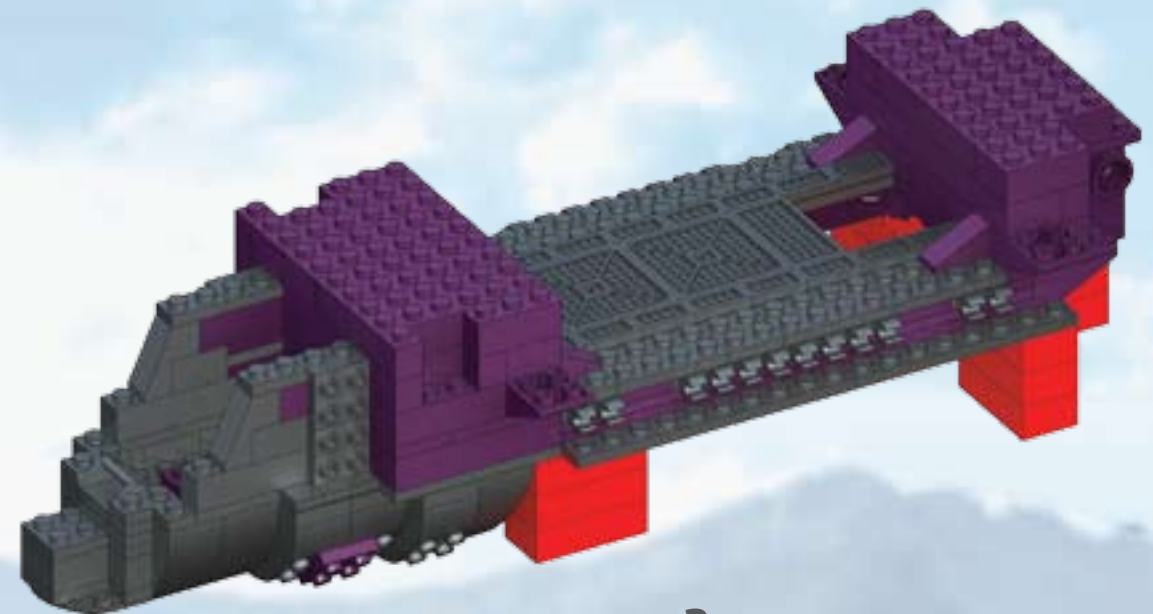

2



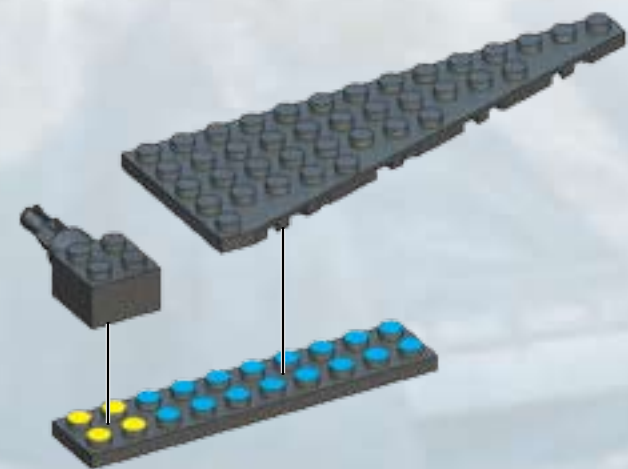
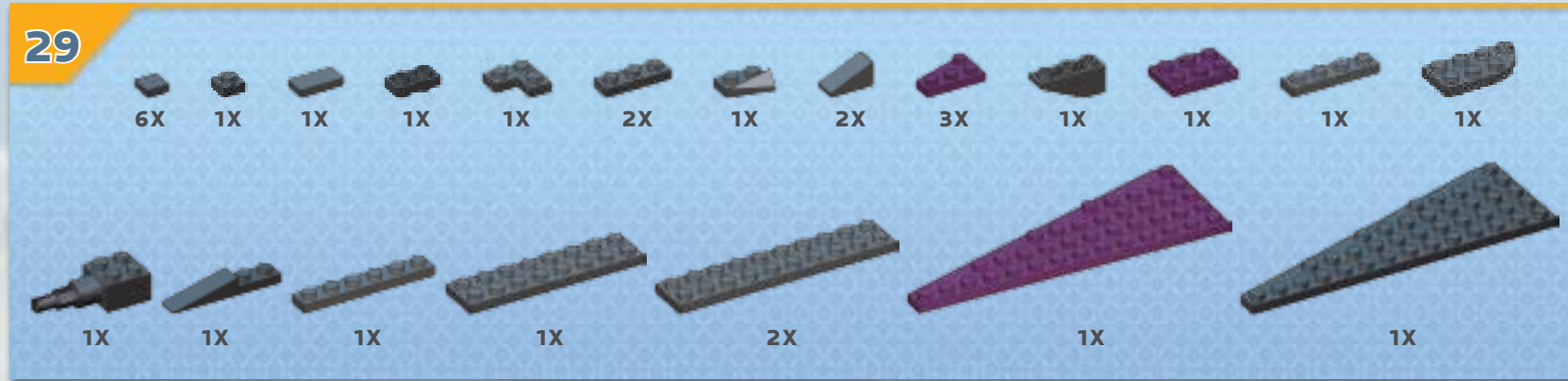

1

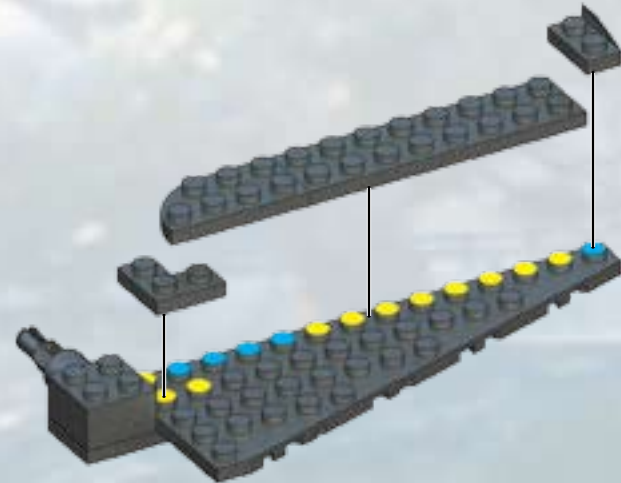

2

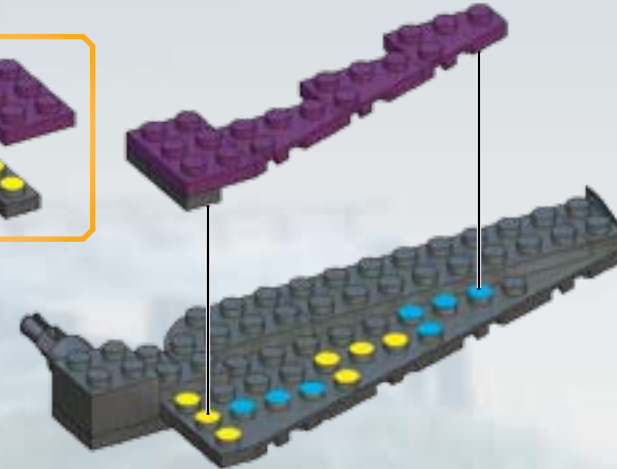

3

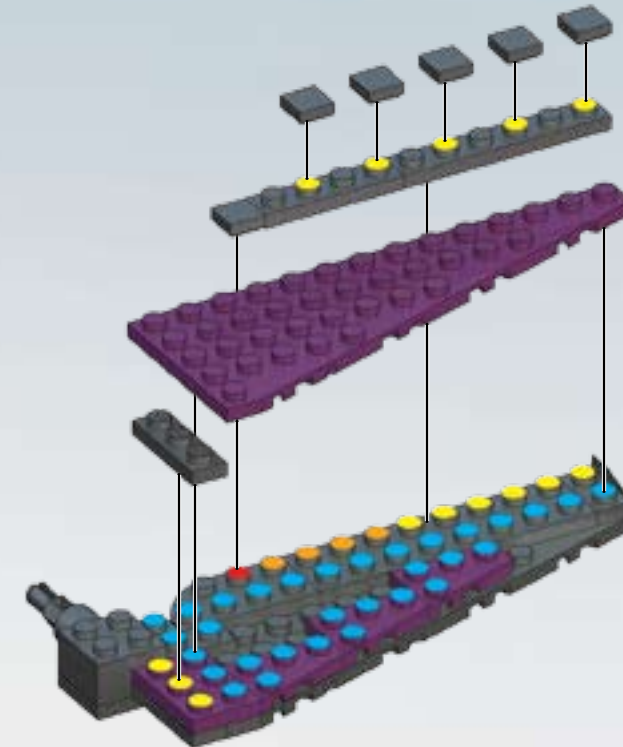

4

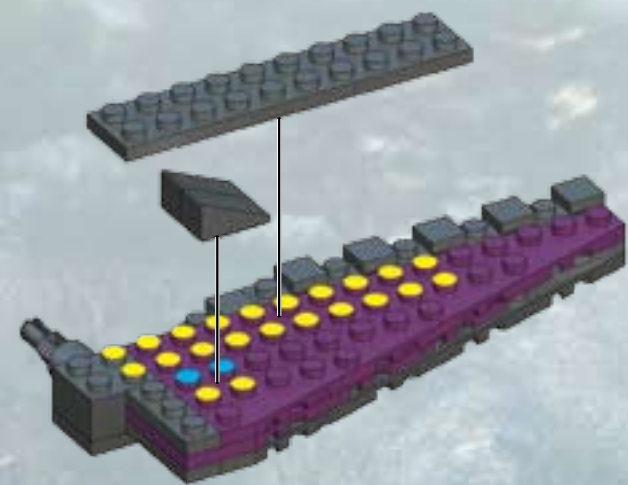

5

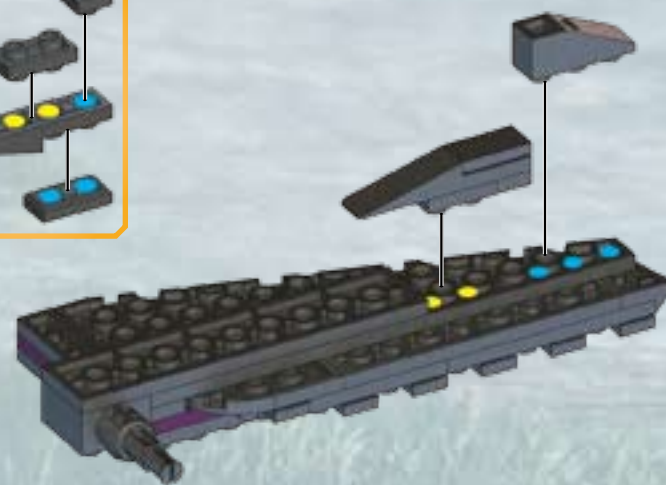
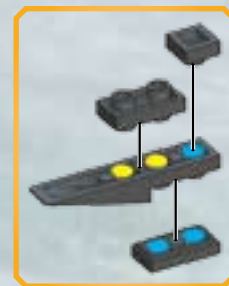

6



7



8



30

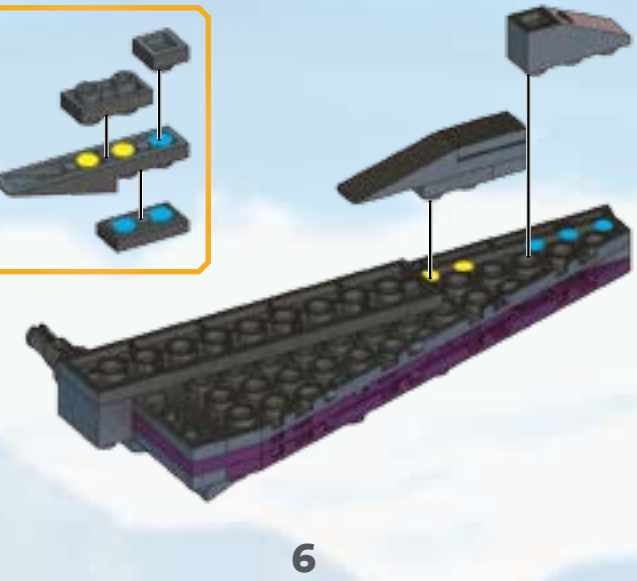
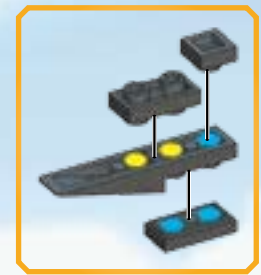
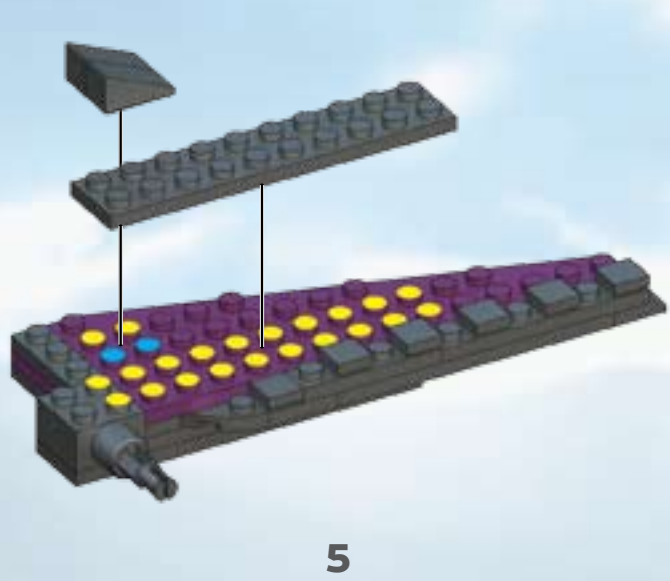
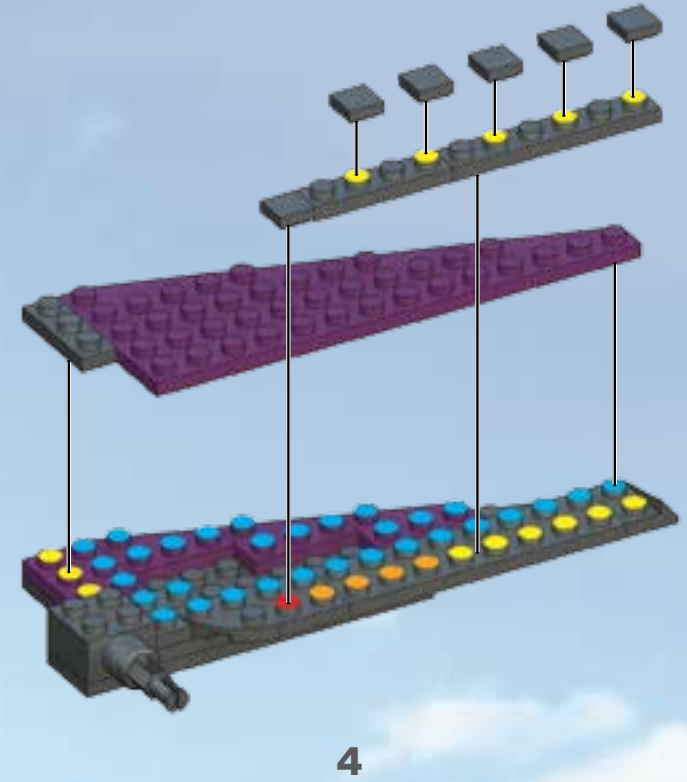
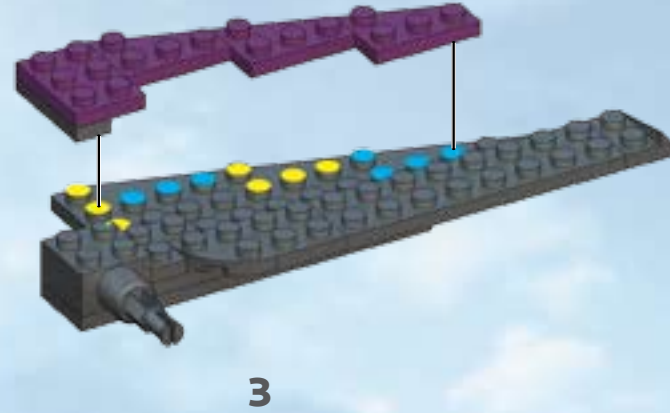
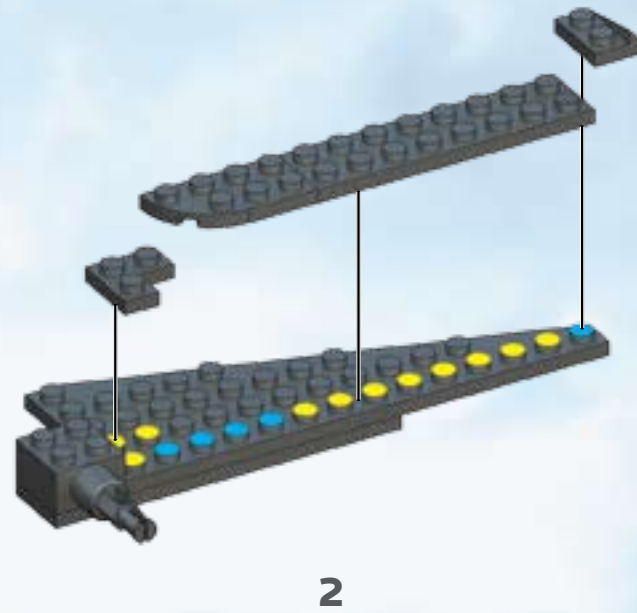
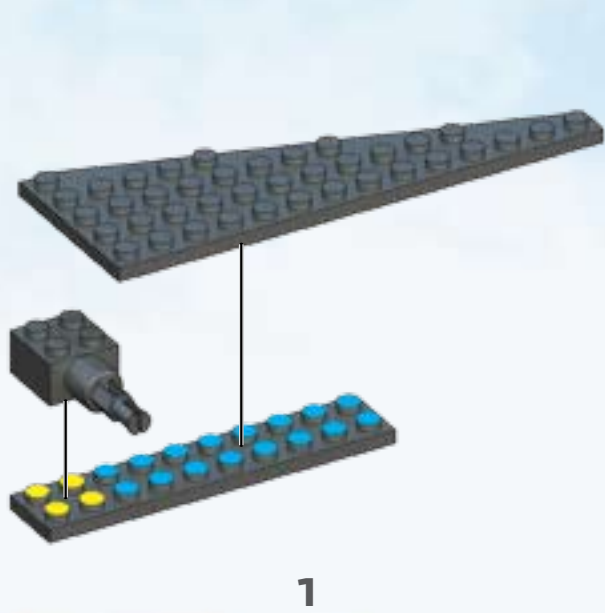
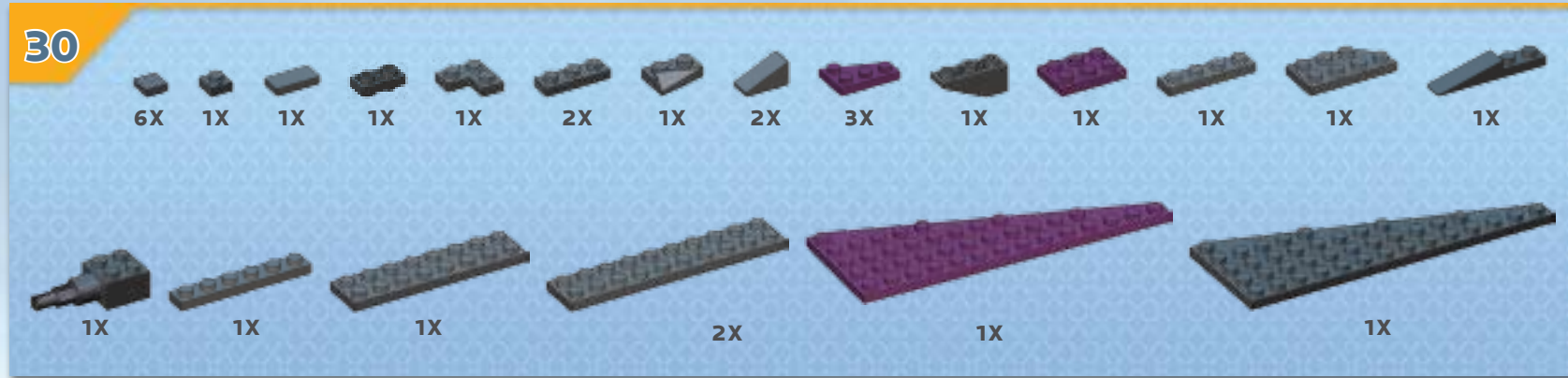



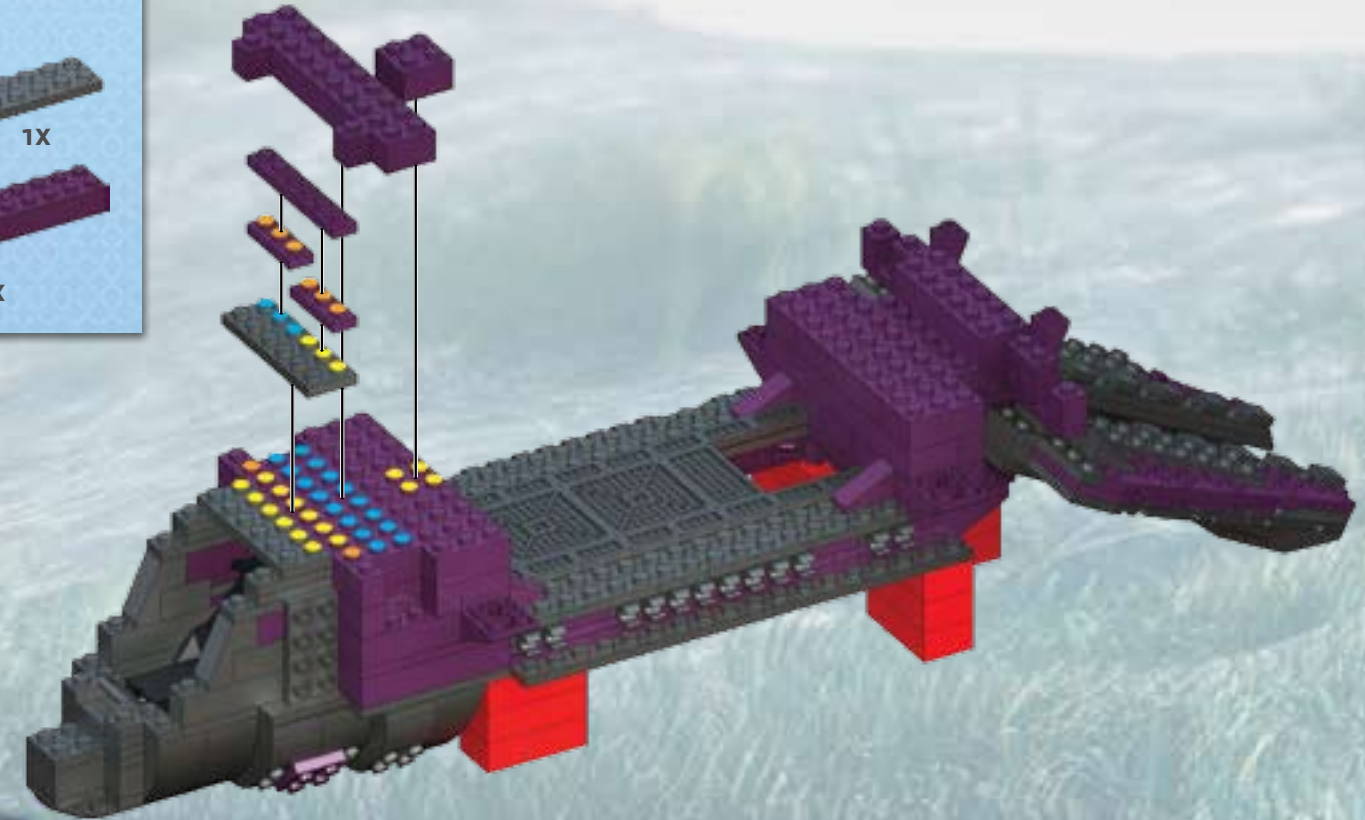
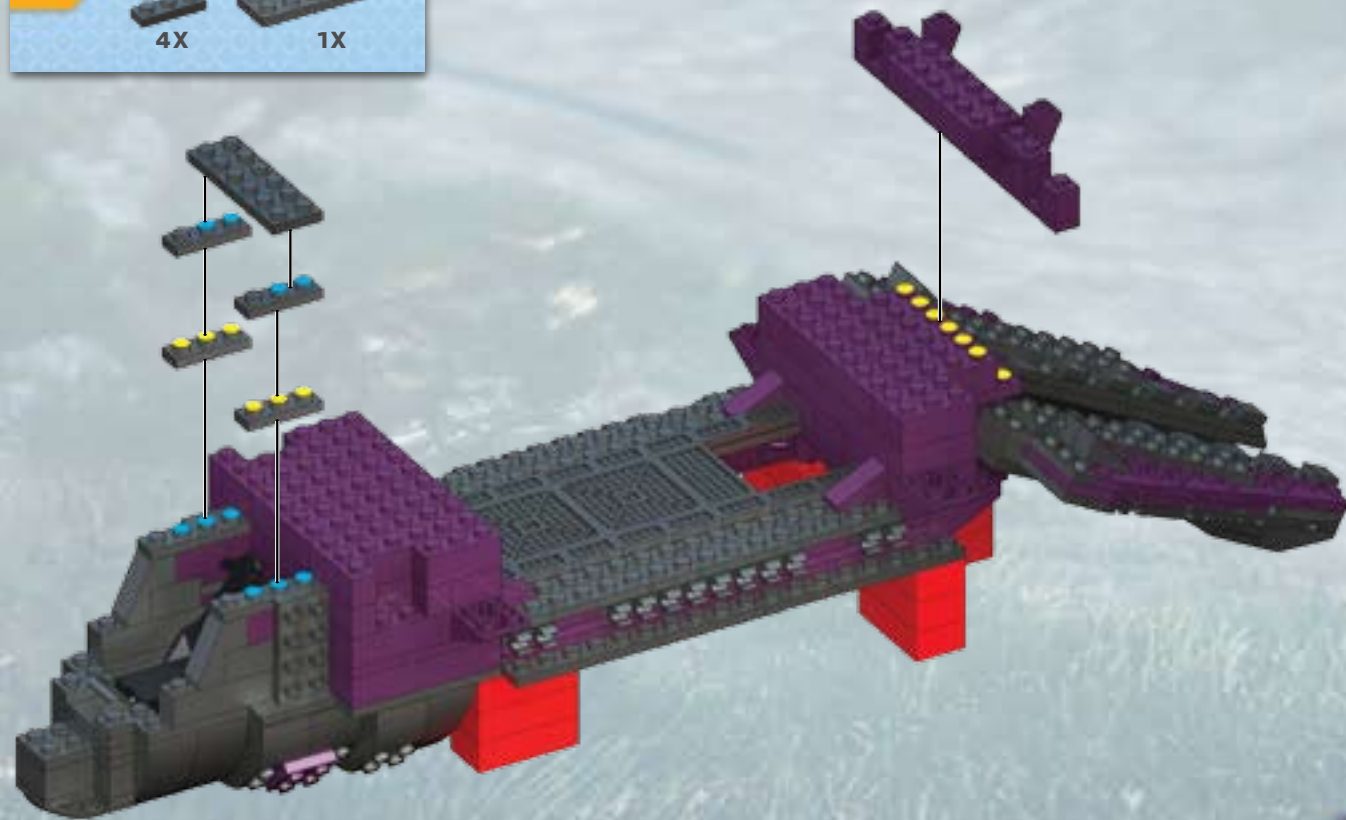
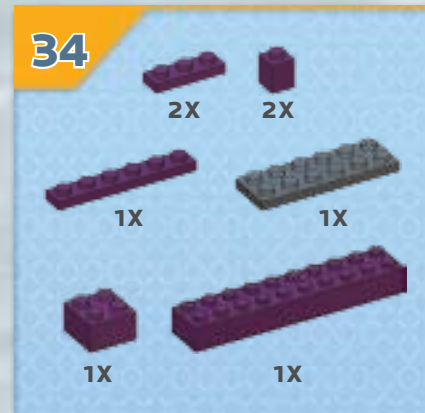
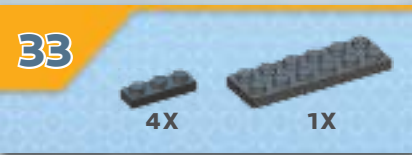
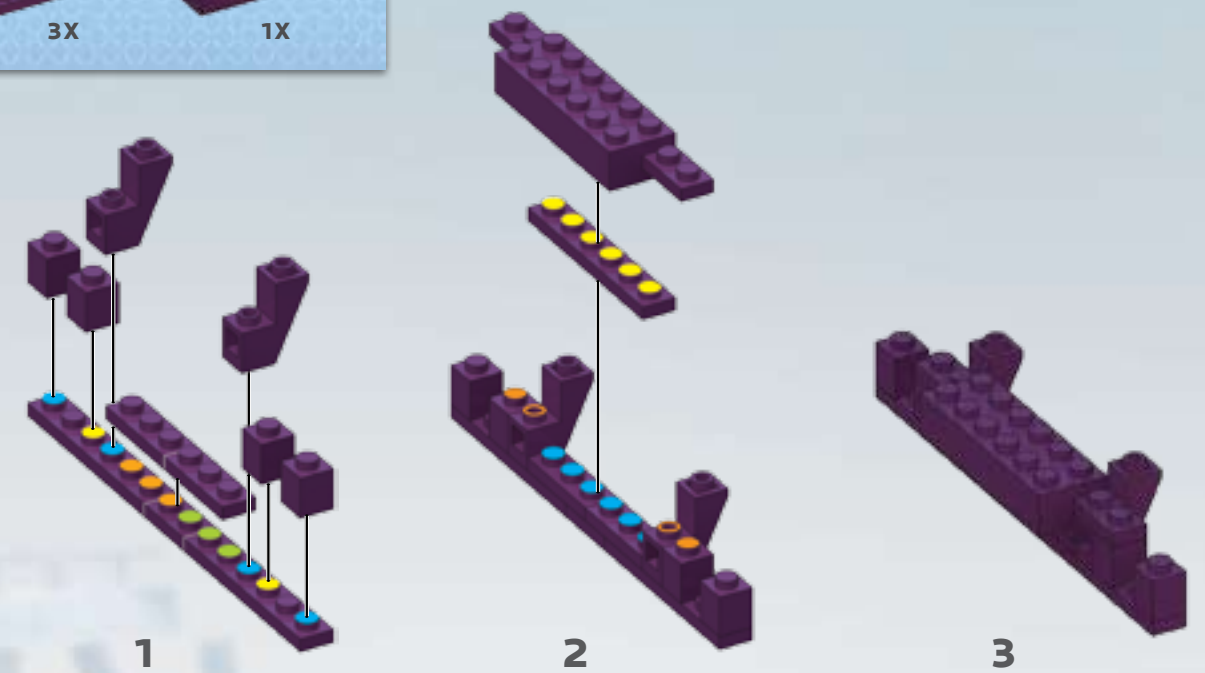
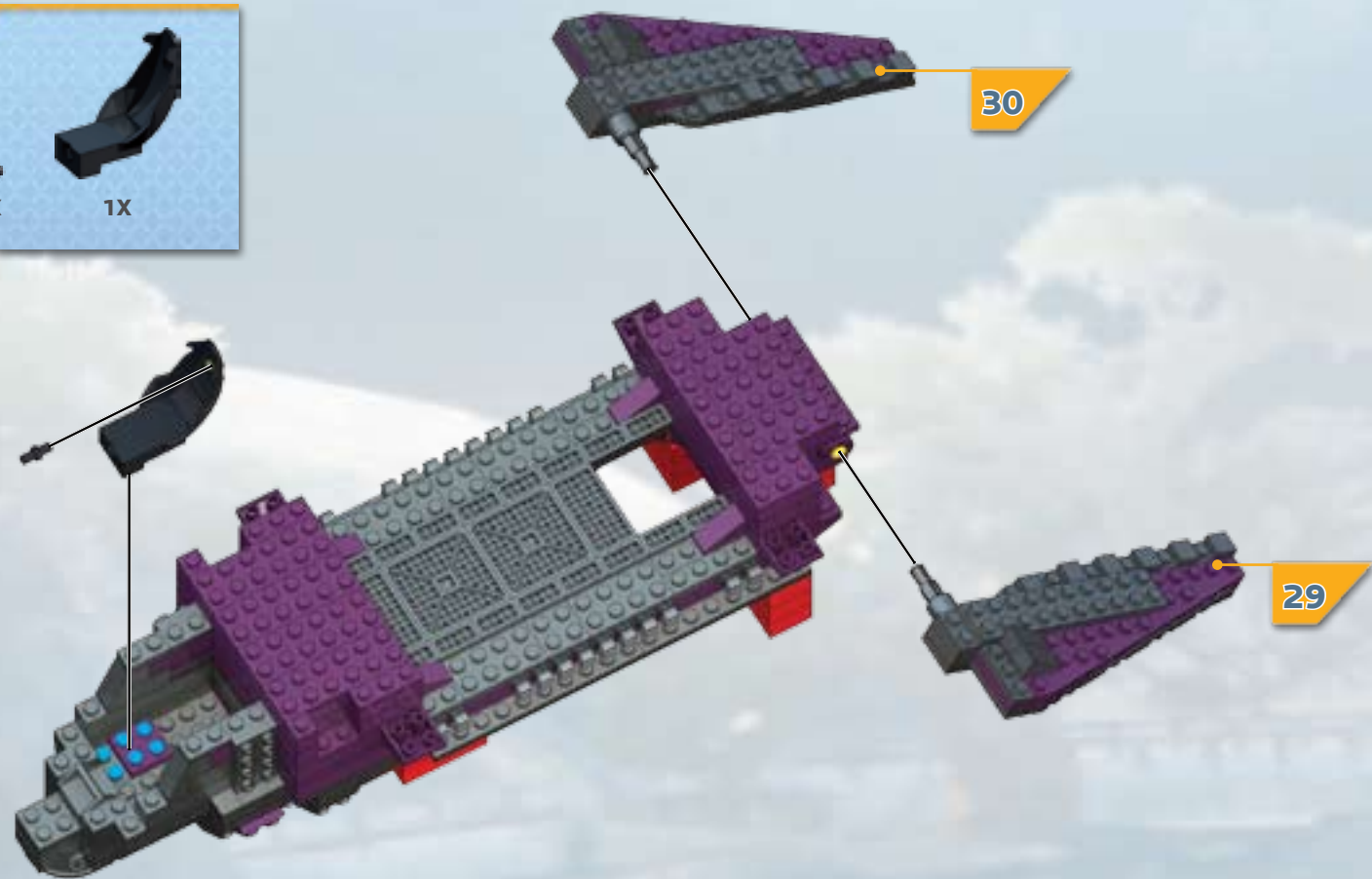
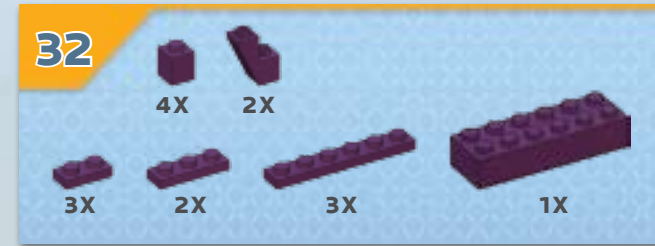



35

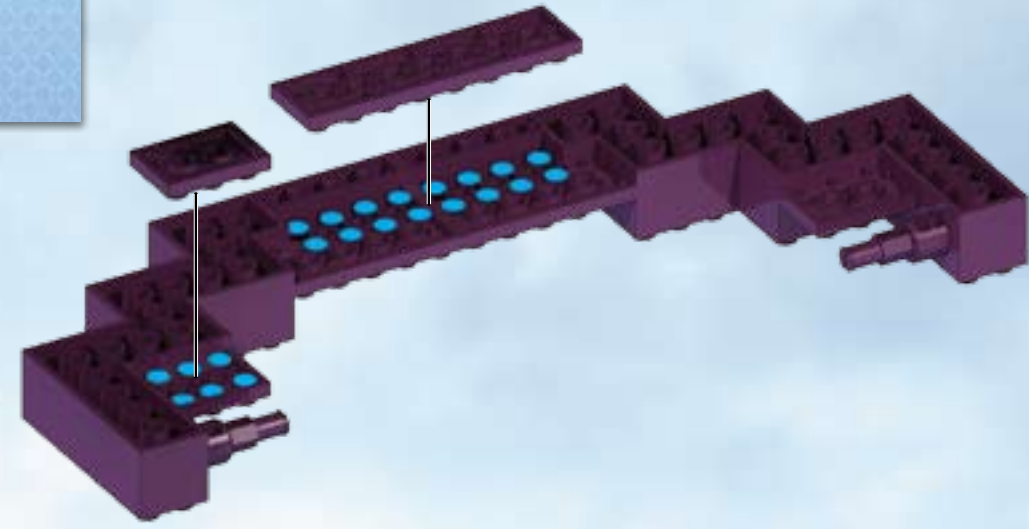
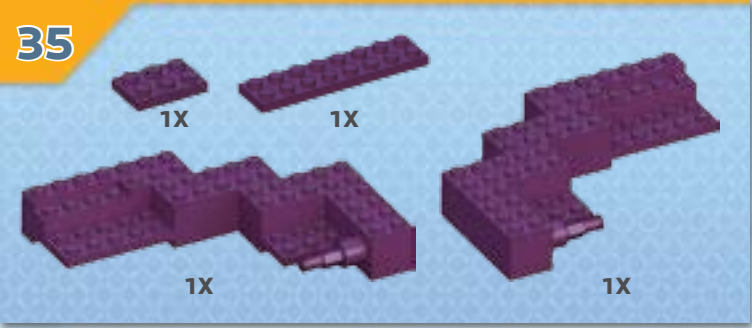

36

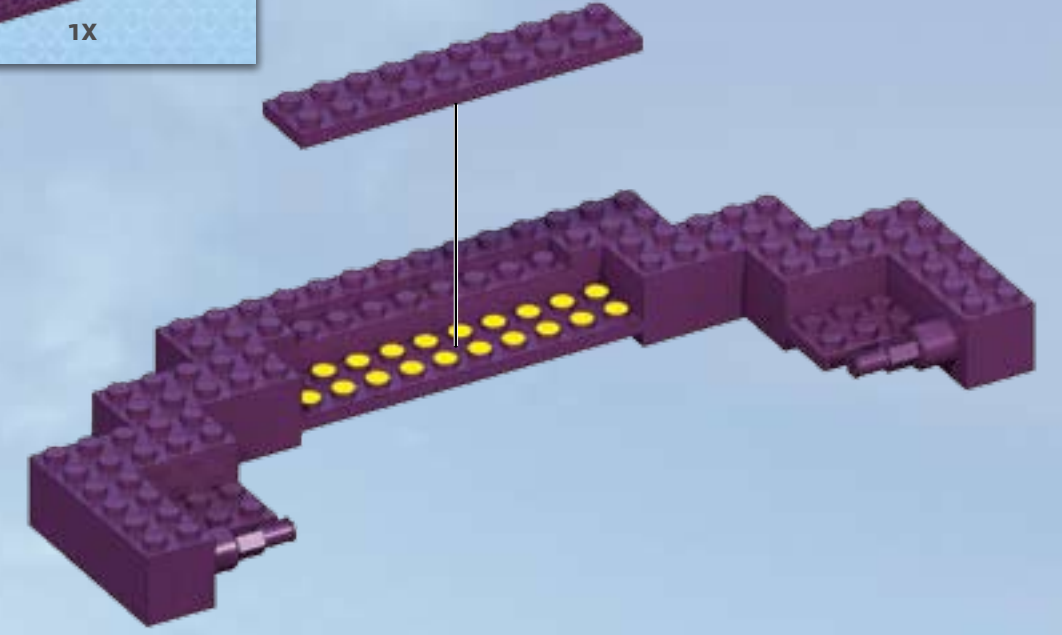
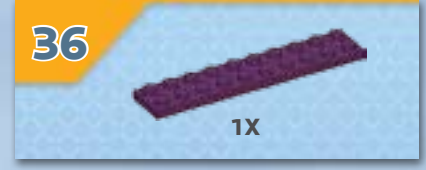

37

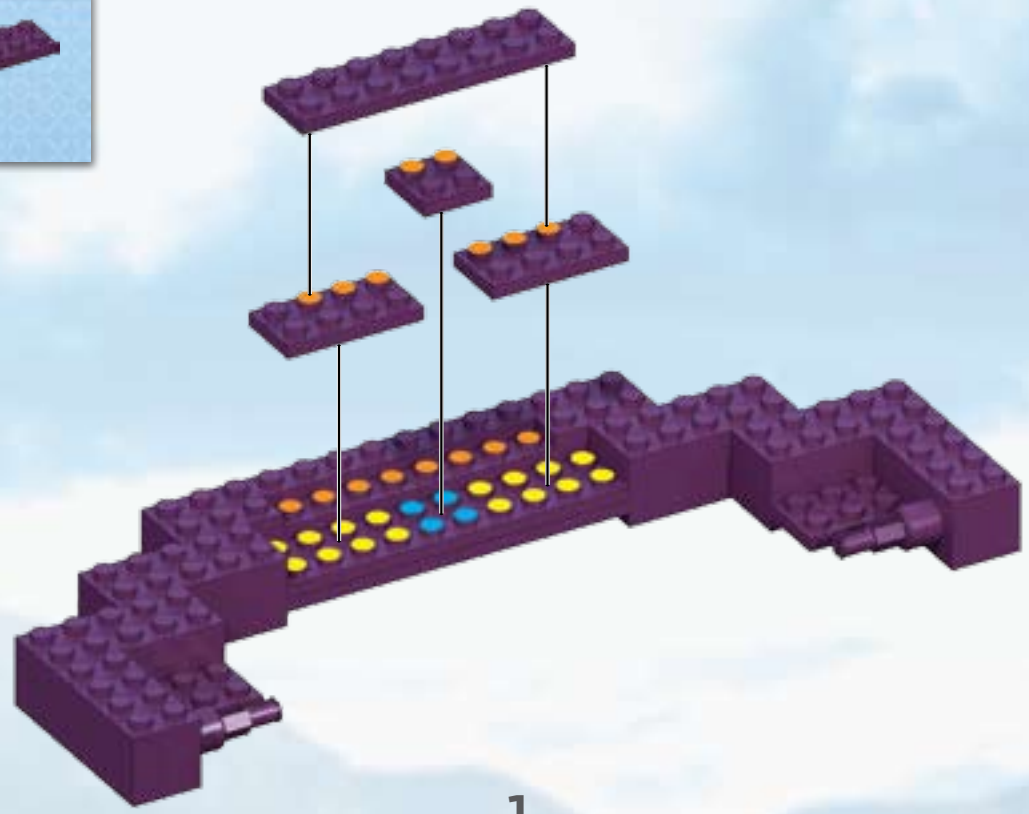

1



2



**38**

1X 2X 1X 1X

**39**

4X 2X 1X

**40**

1X 4X 2X

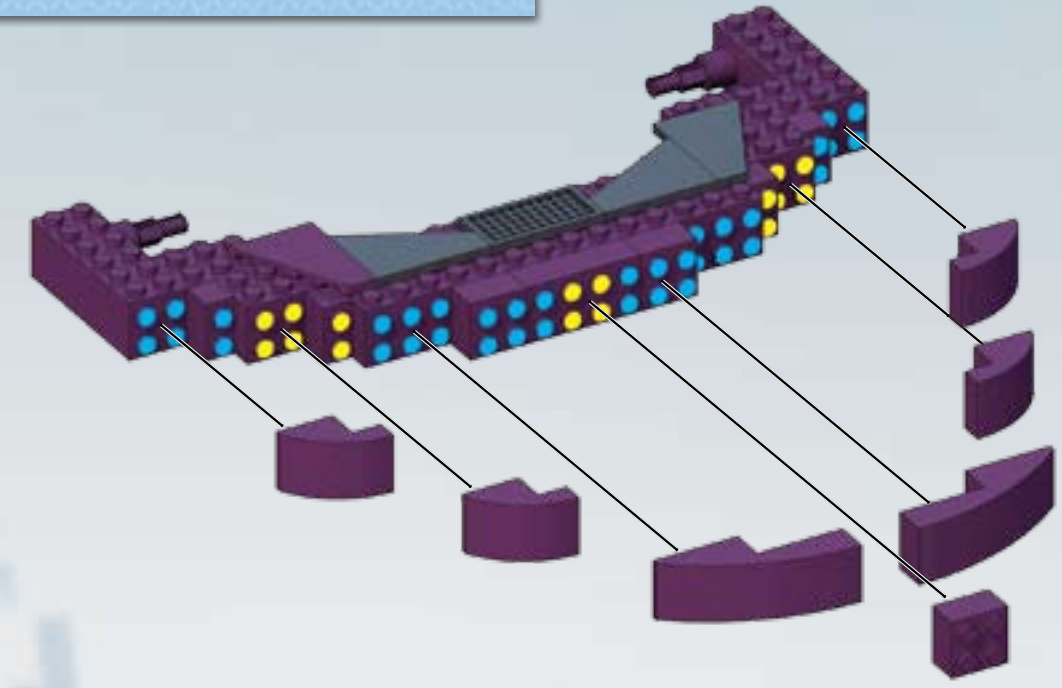
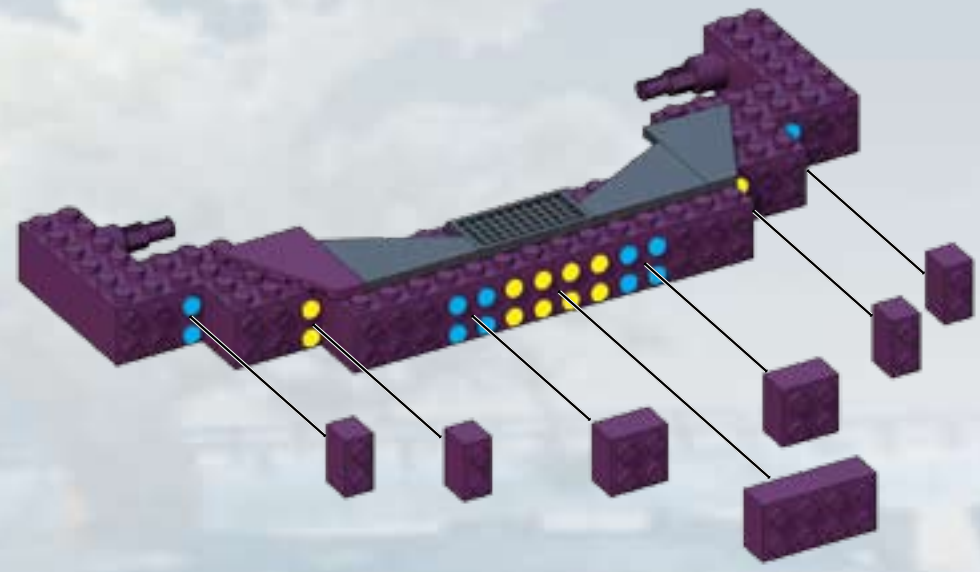
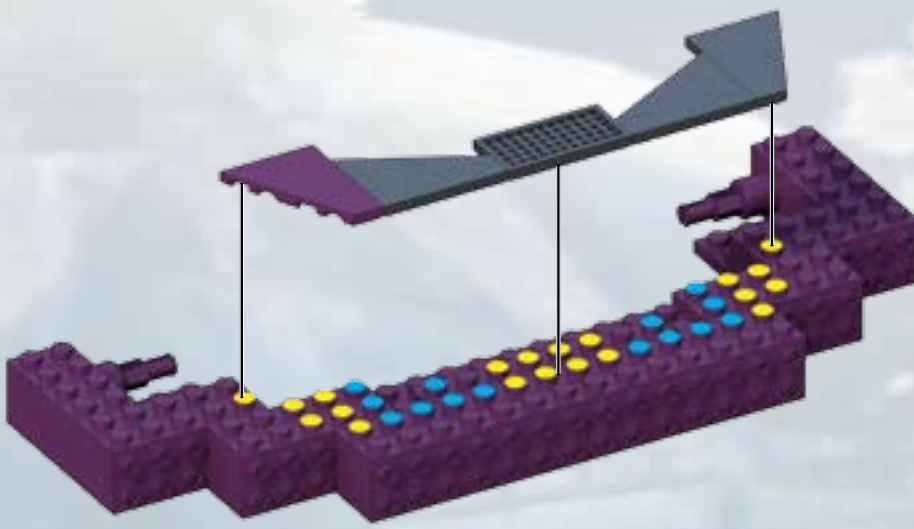

**41**

1X 2X

**42**

2X

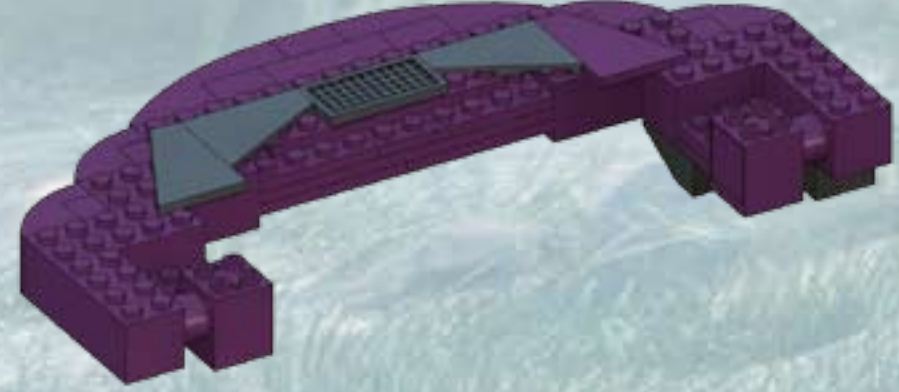
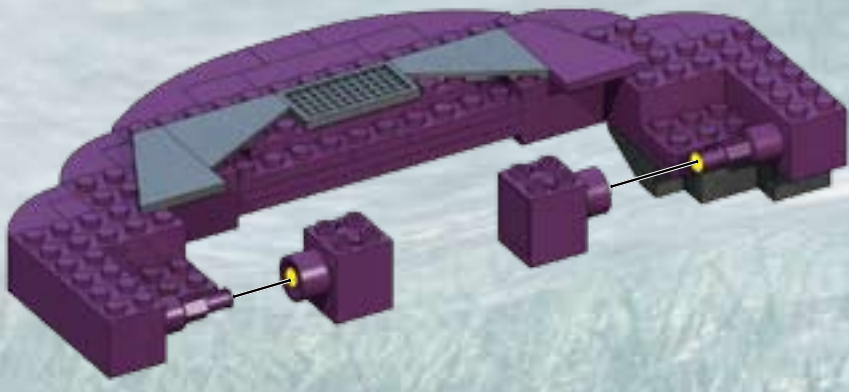
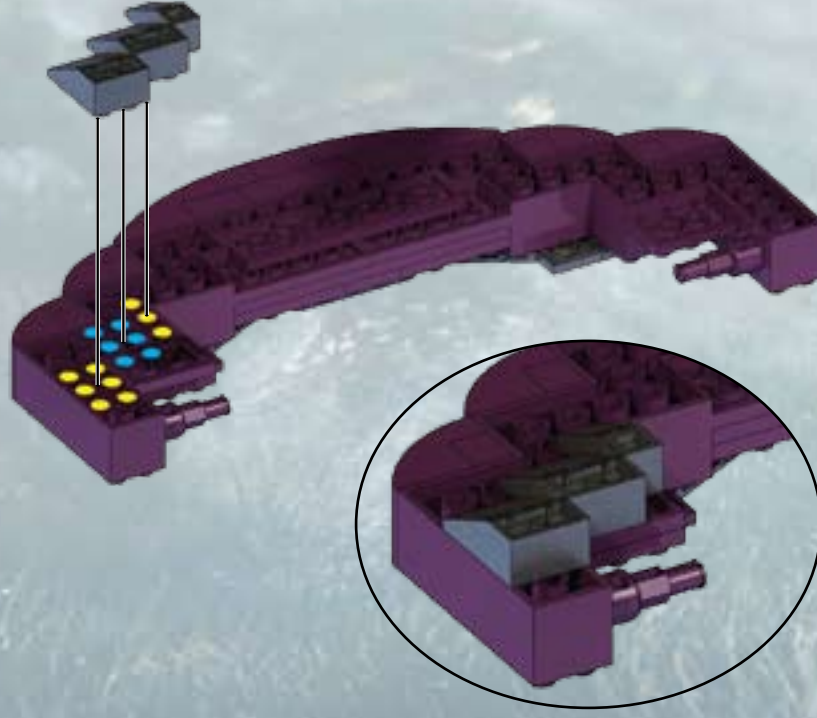

1

2



43

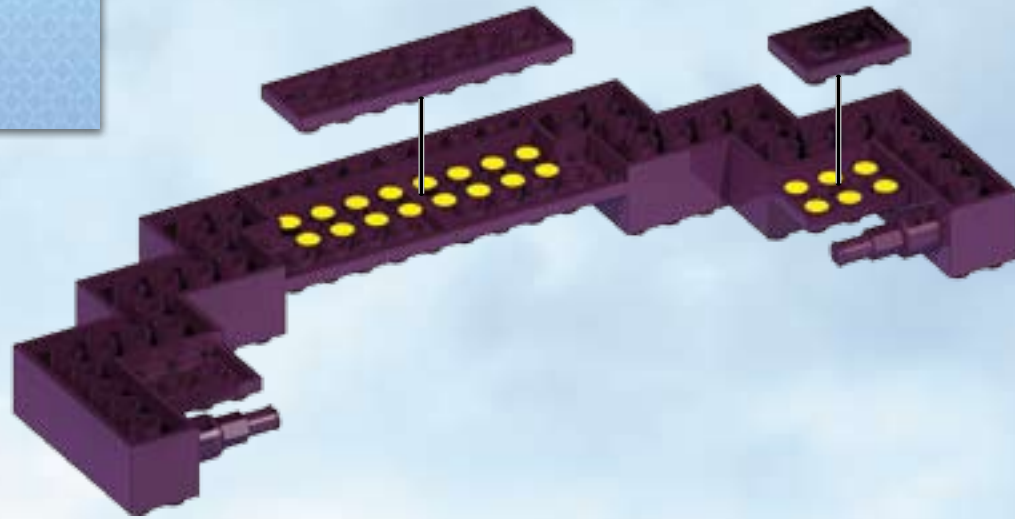
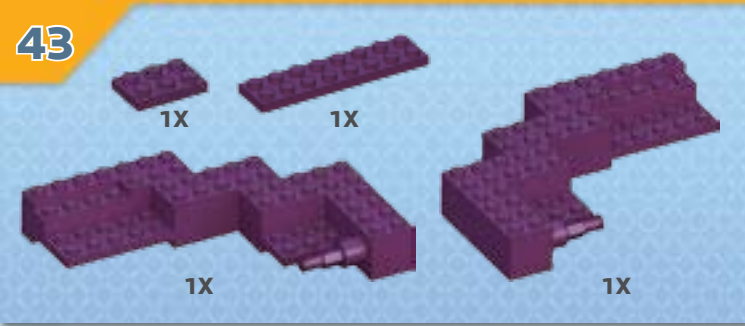

44

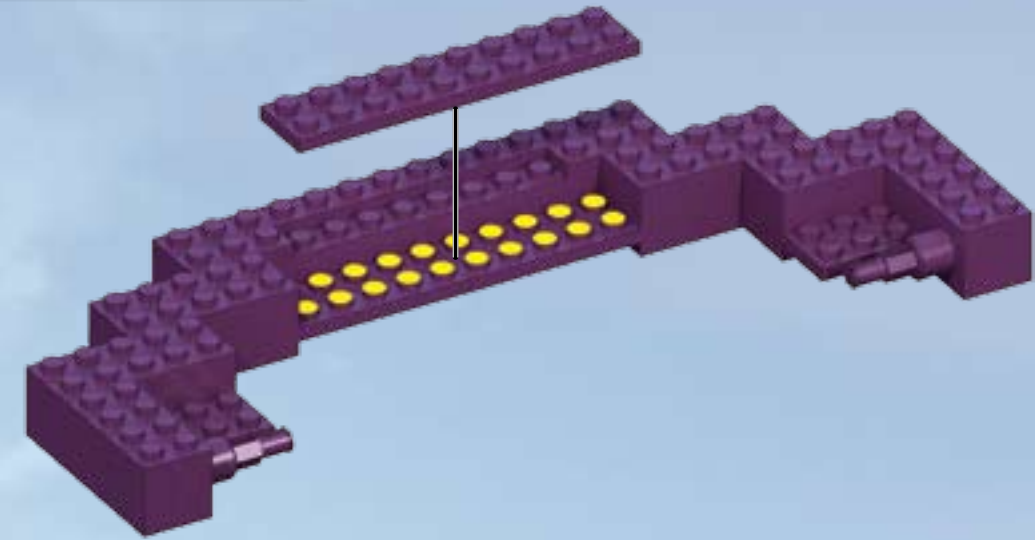
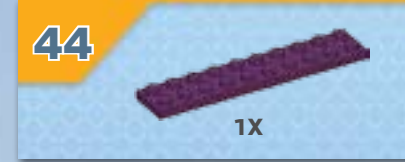

45

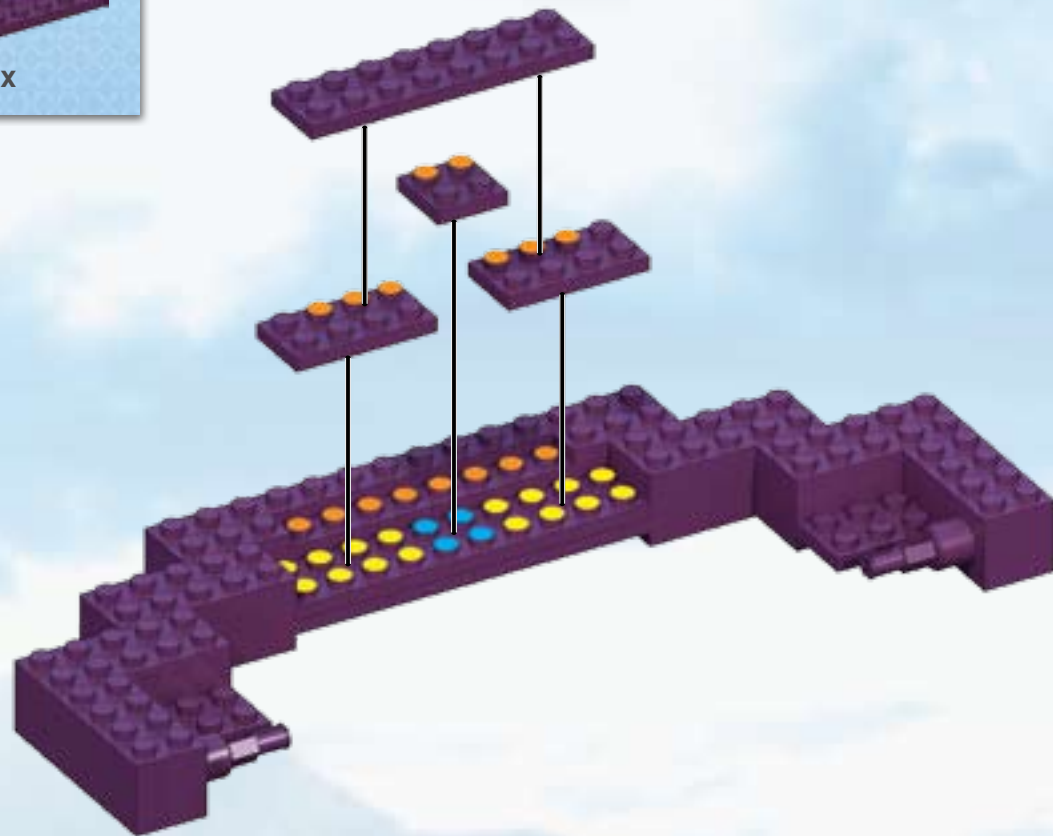

1

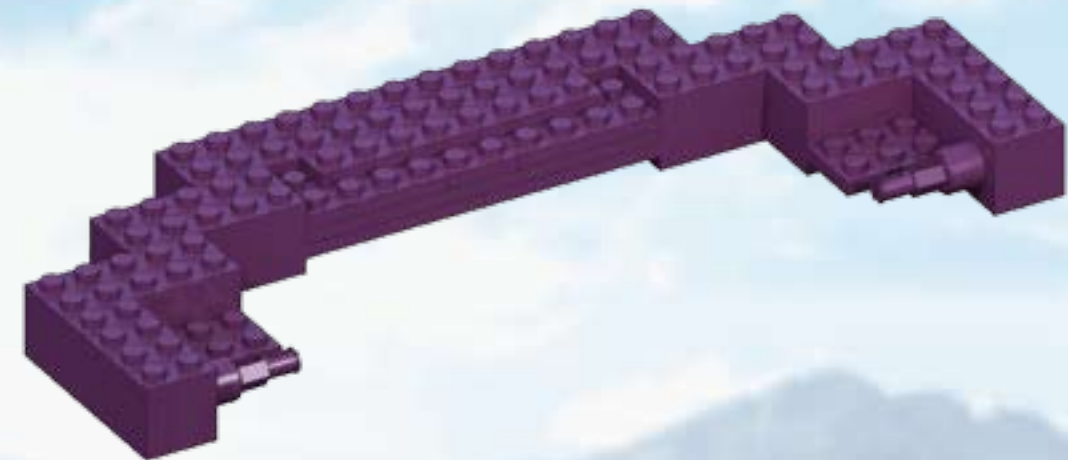

2



**46**

1X 1X 2X 1X

**47**

4X 2X 1X

**48**

1X 4X 2X

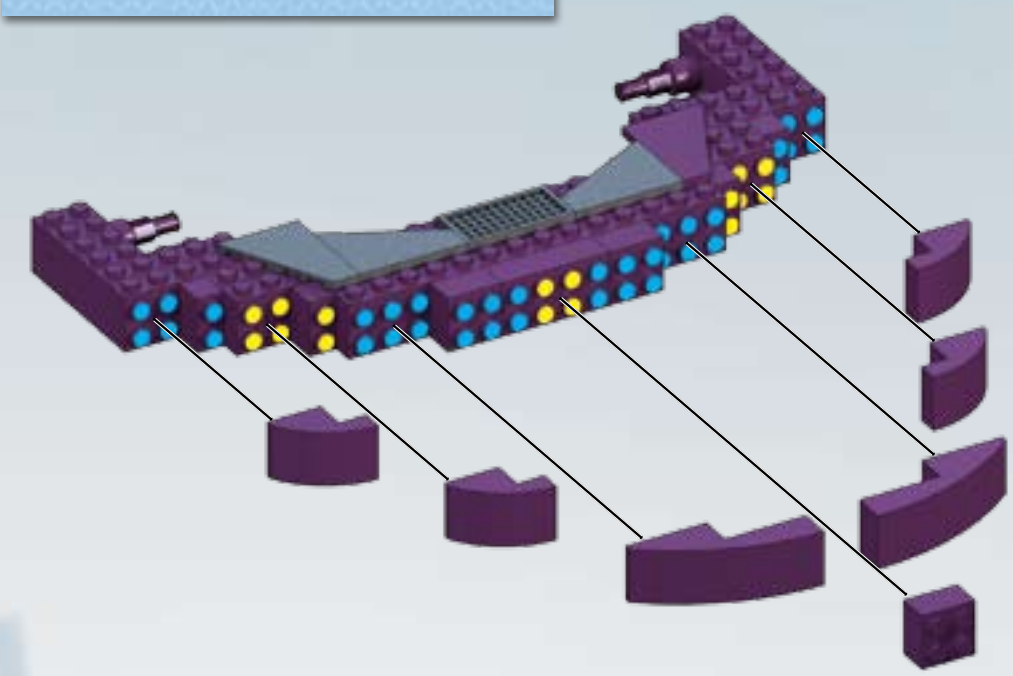
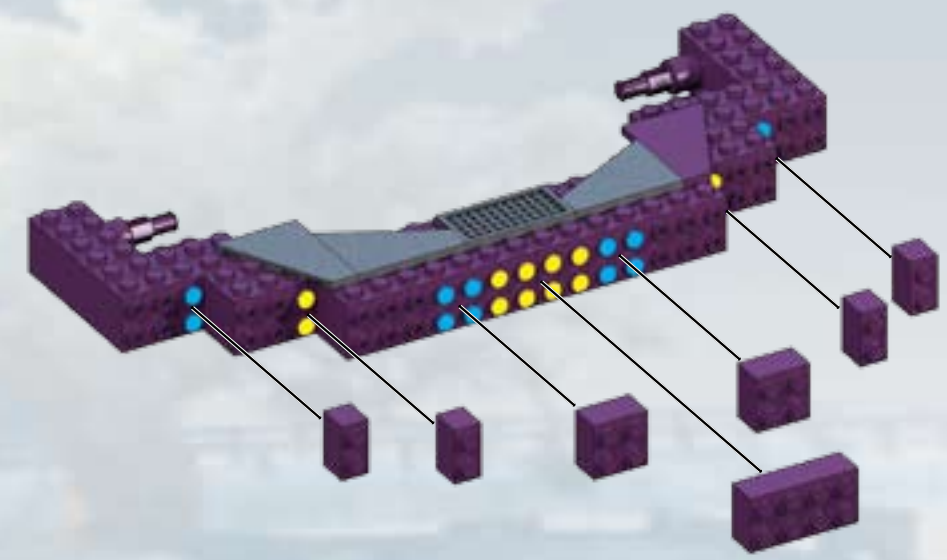
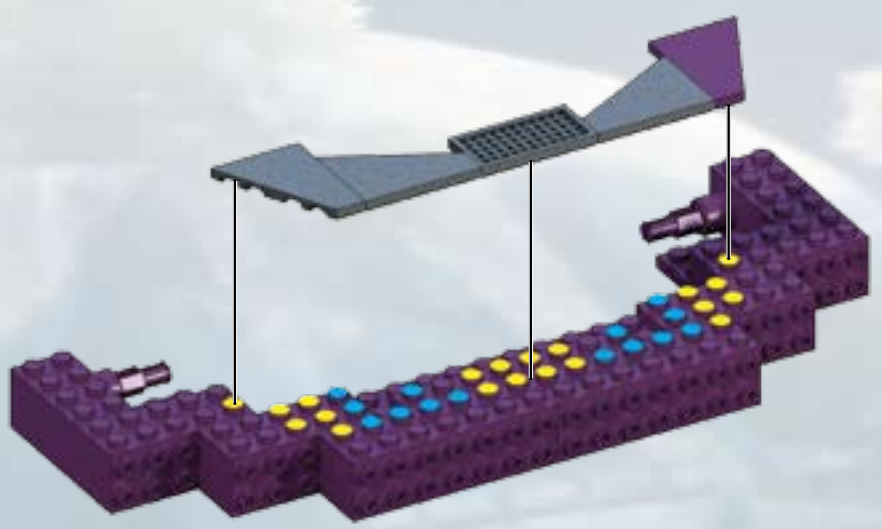

**49**

1X 2X

**50**

2X

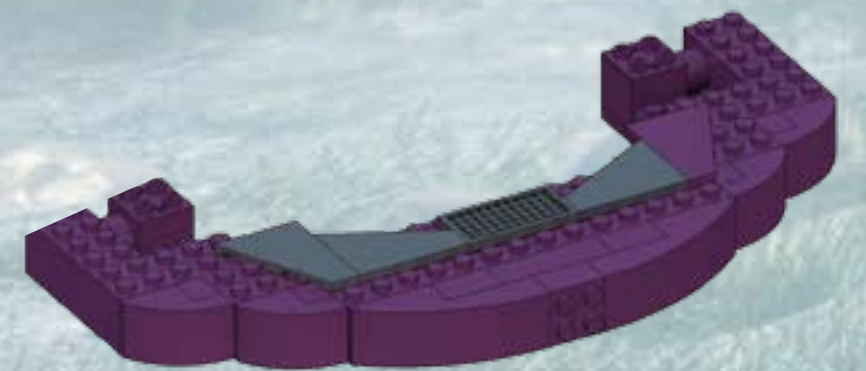
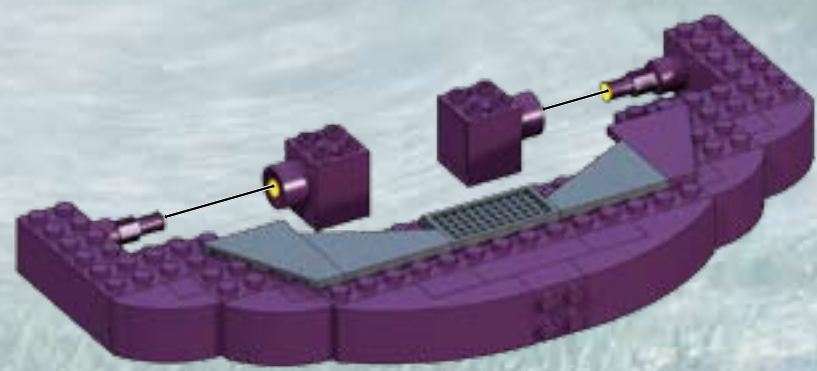
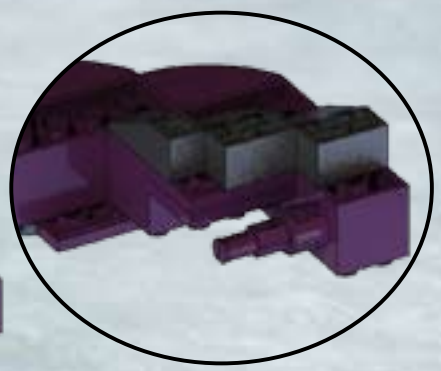
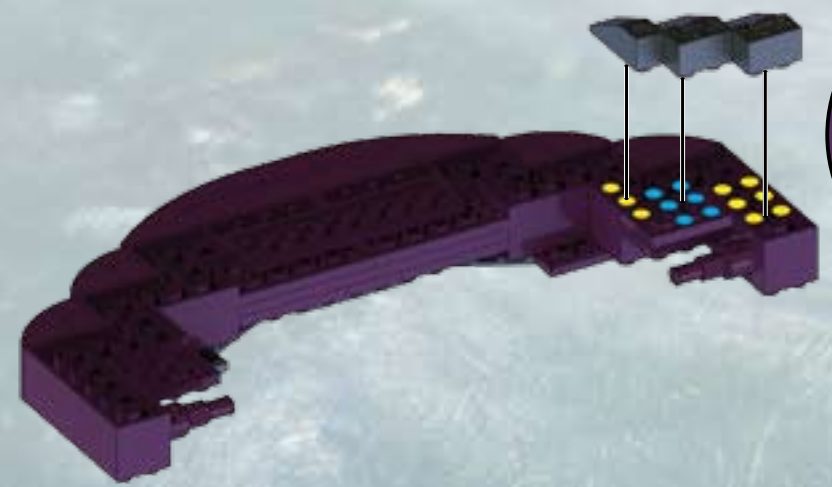

1

2



51



52

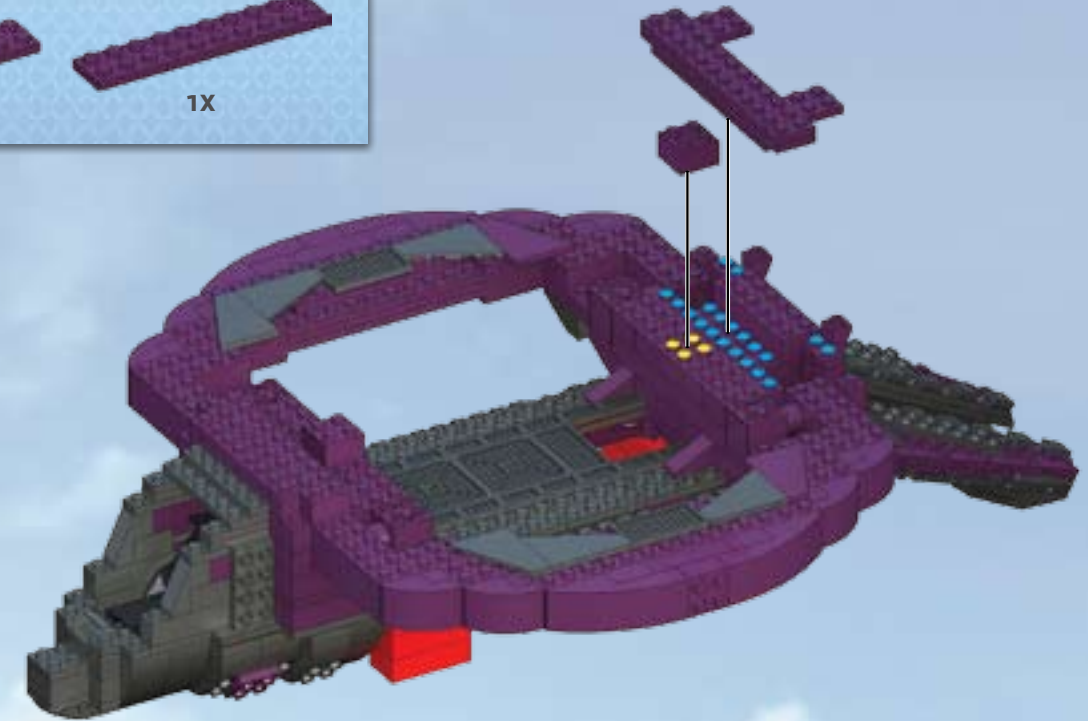
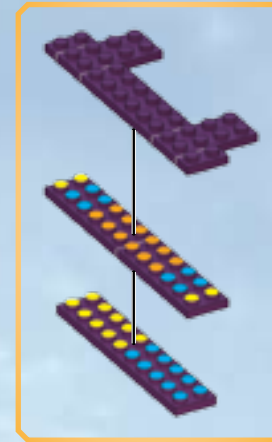
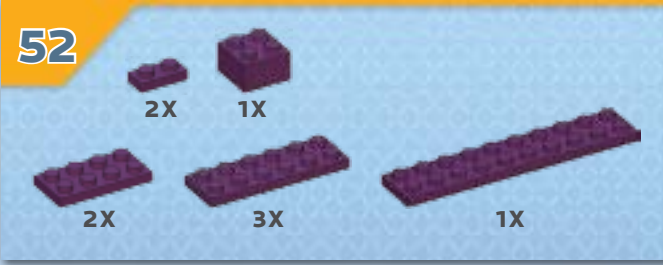

53

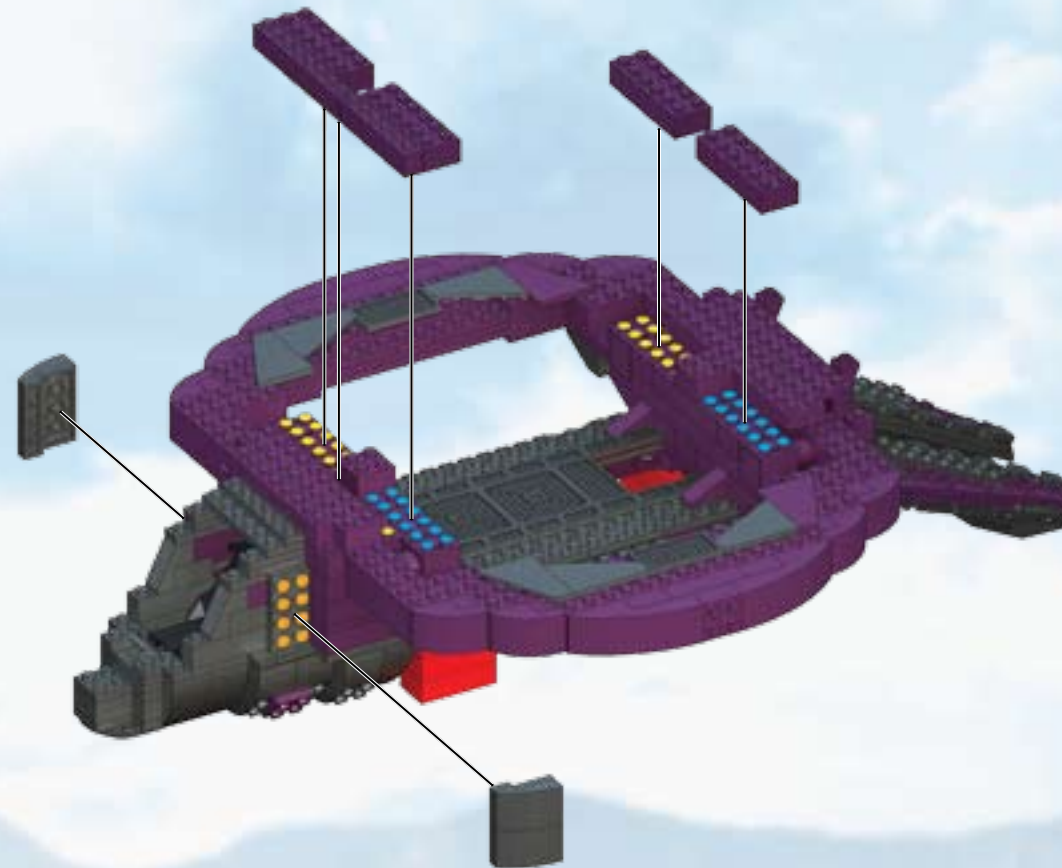
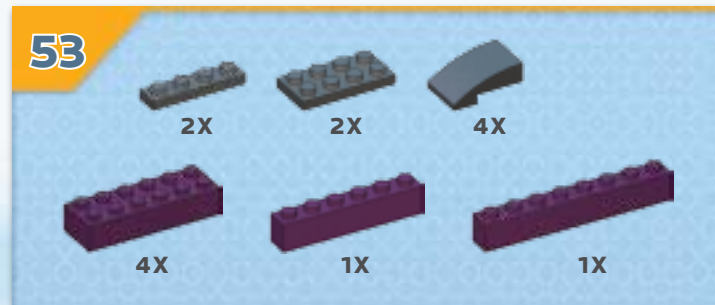



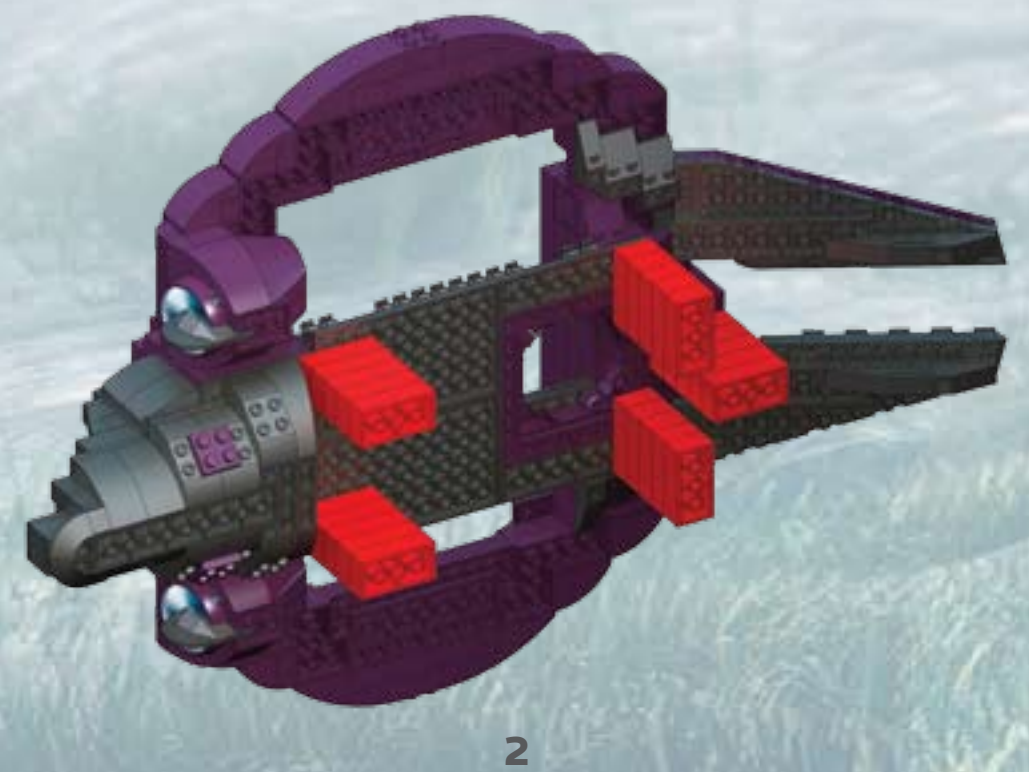
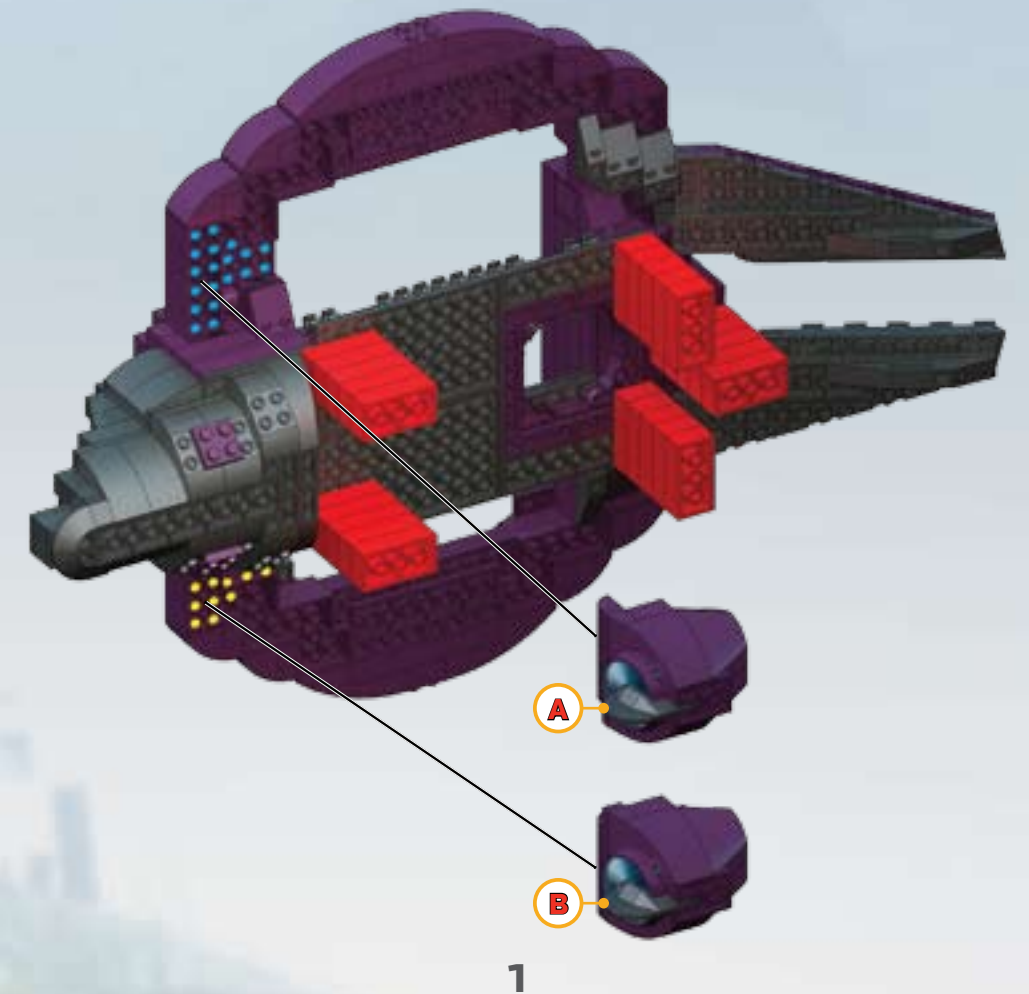
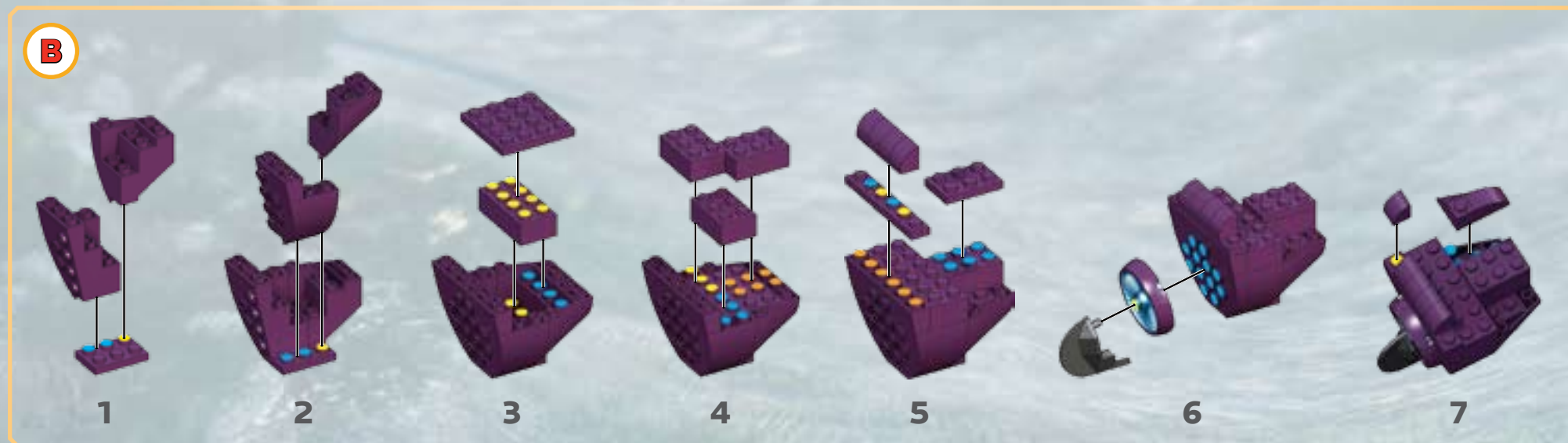
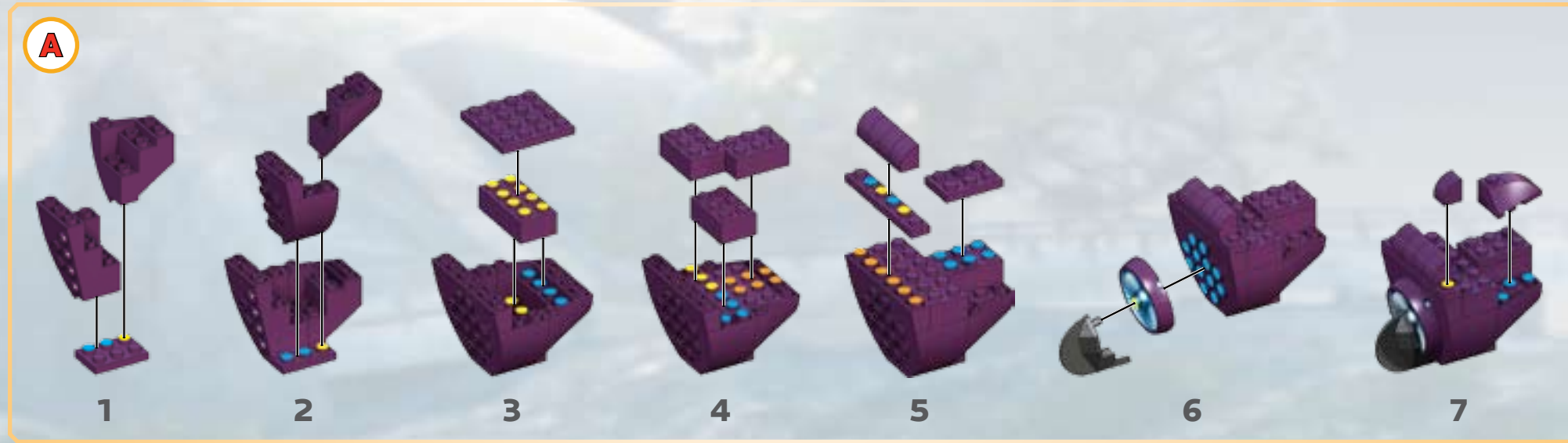



55

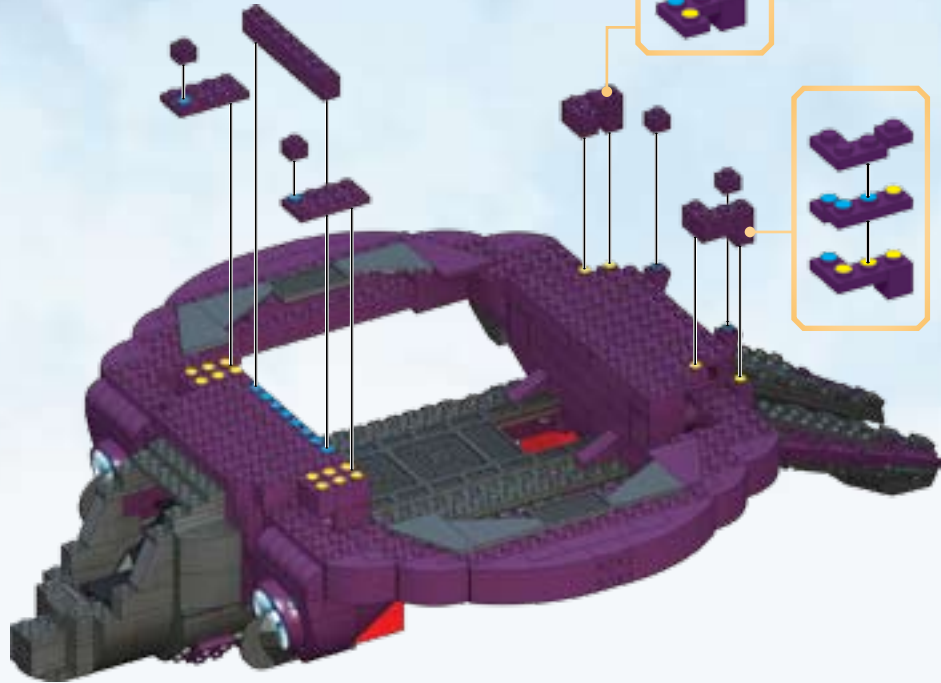
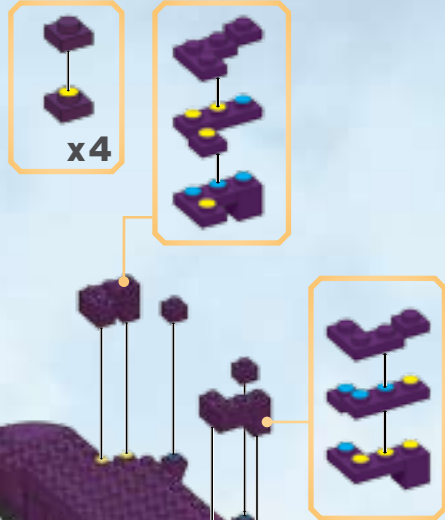
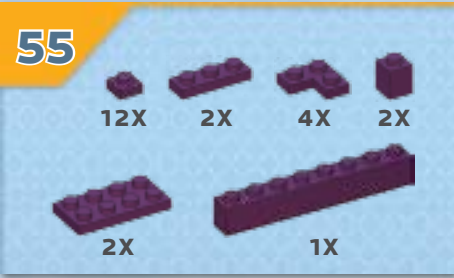

56

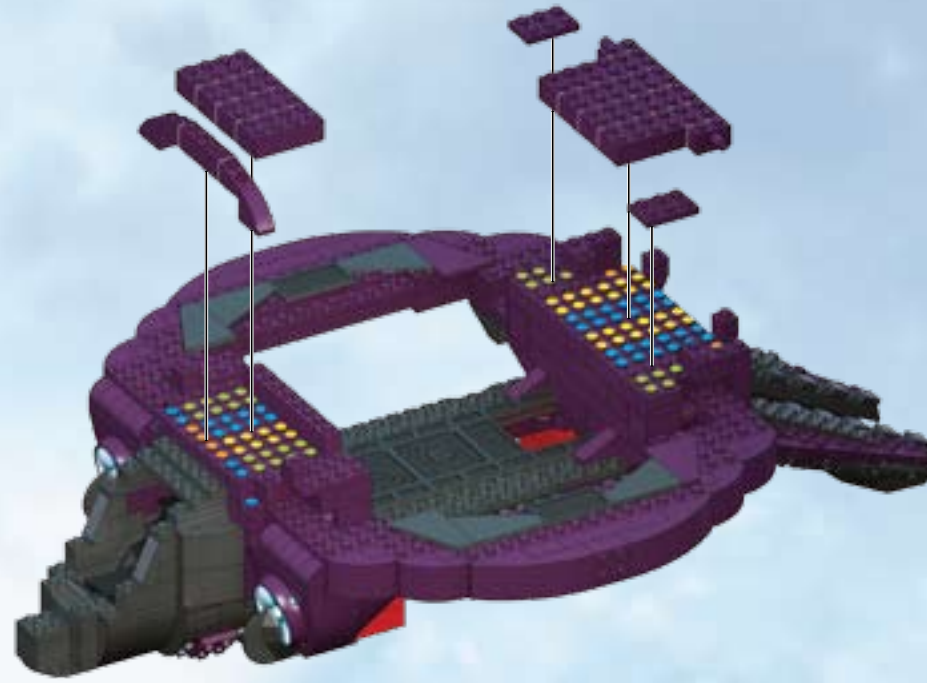
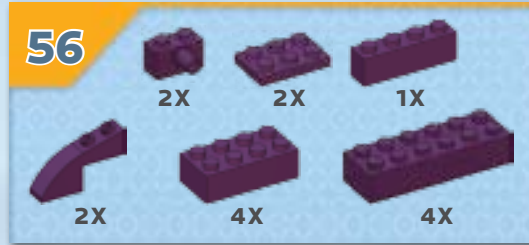

57

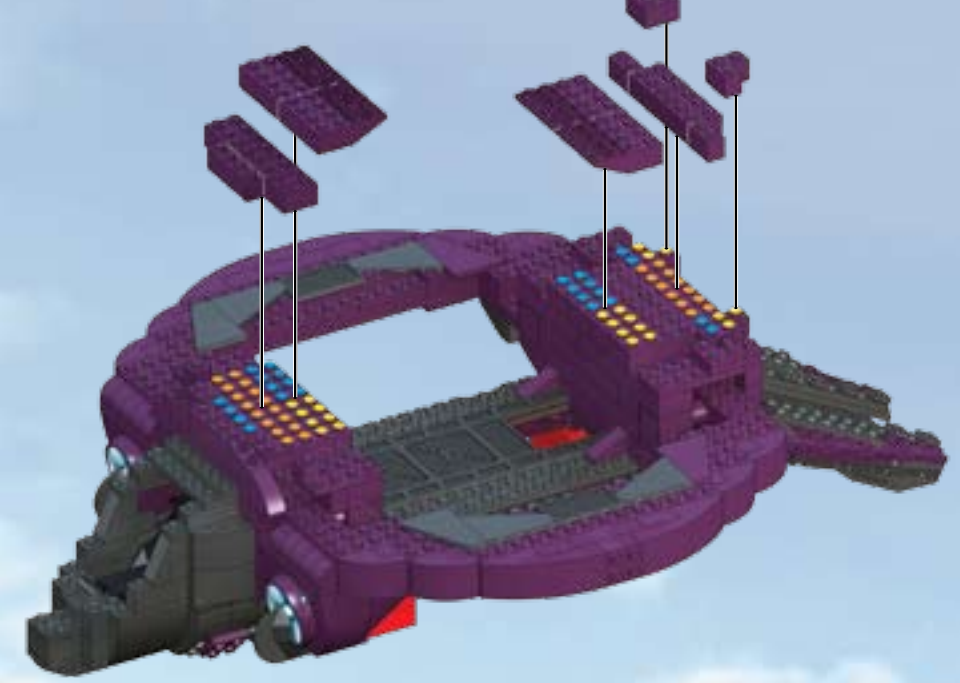
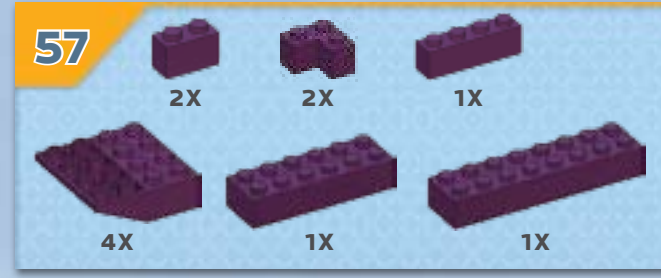

58

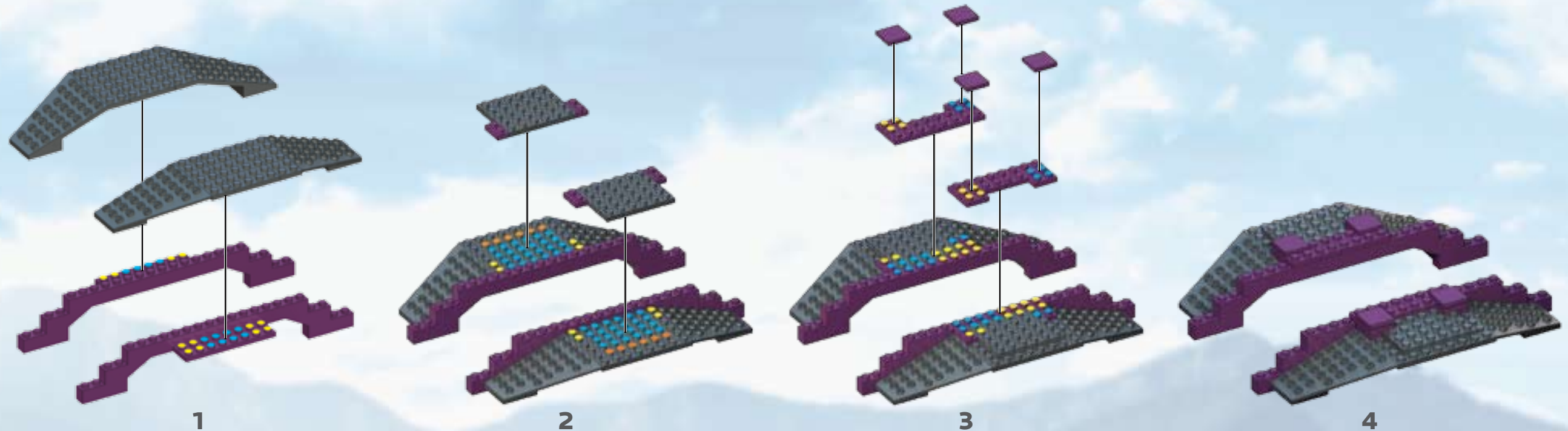
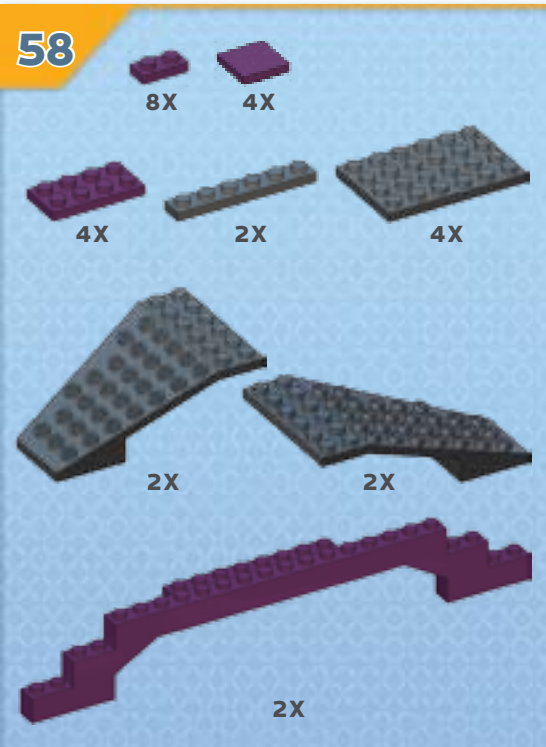



**59**

1X	1X	1X

**1**

**2**



**60**

2X	2X	2X	1X
1X	2X	2X	
2X	2X		

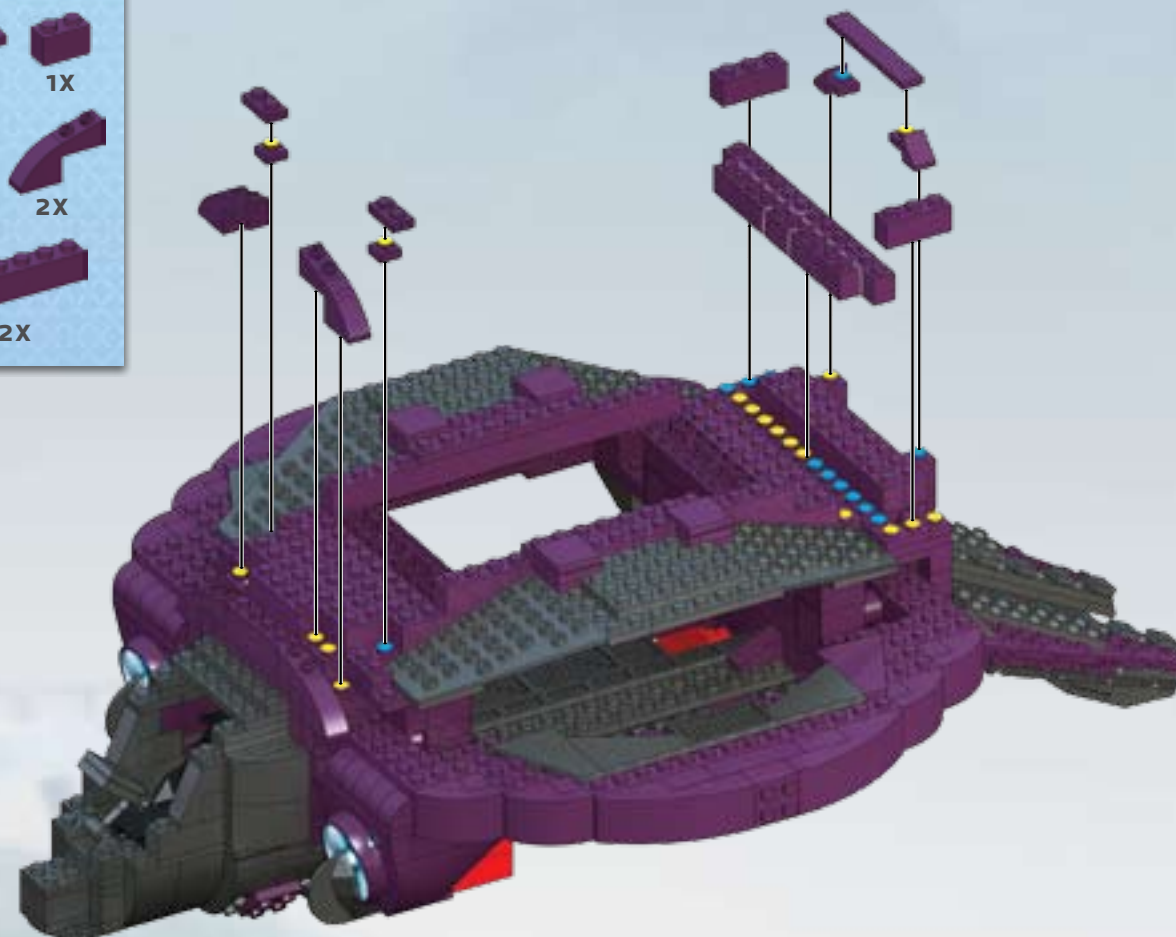

**61**

2X	2X
2X	1X
2X	2X

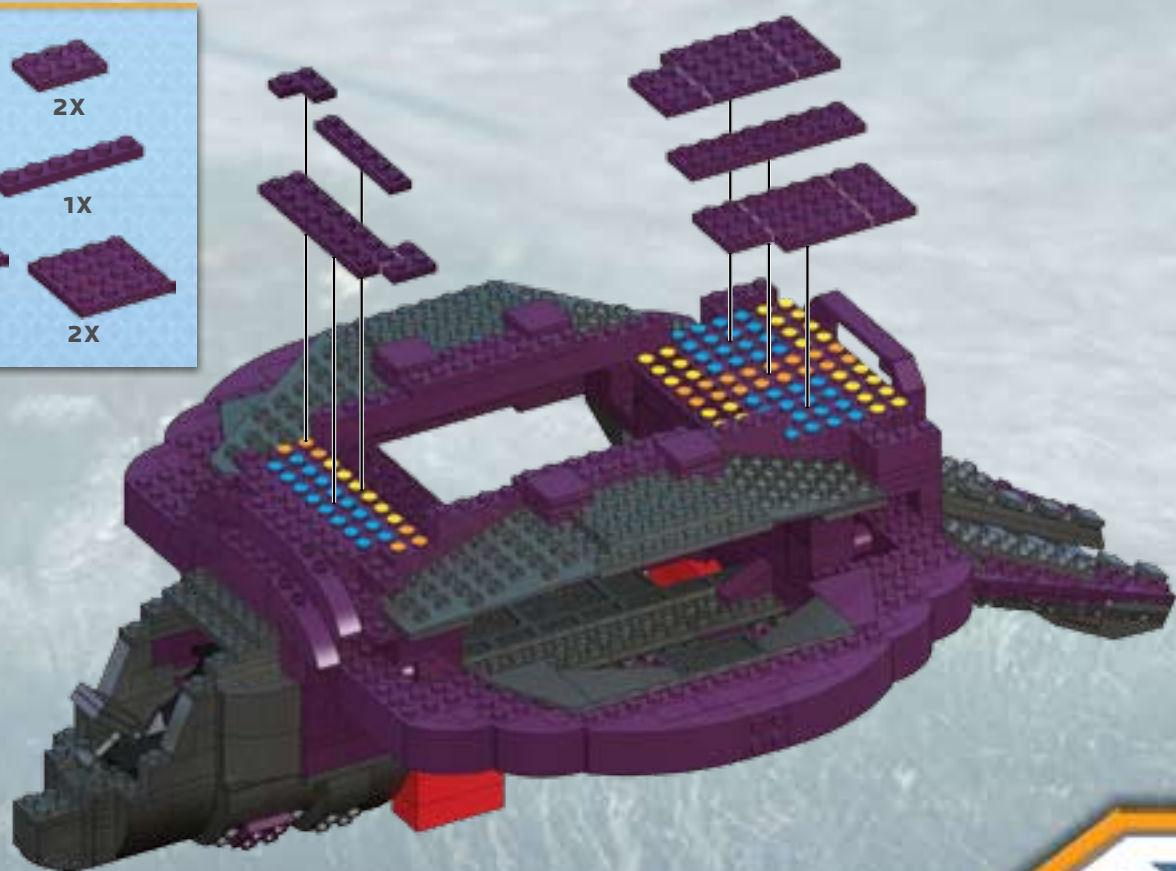

**62**

2X	2X	4X
2X	2X	2X

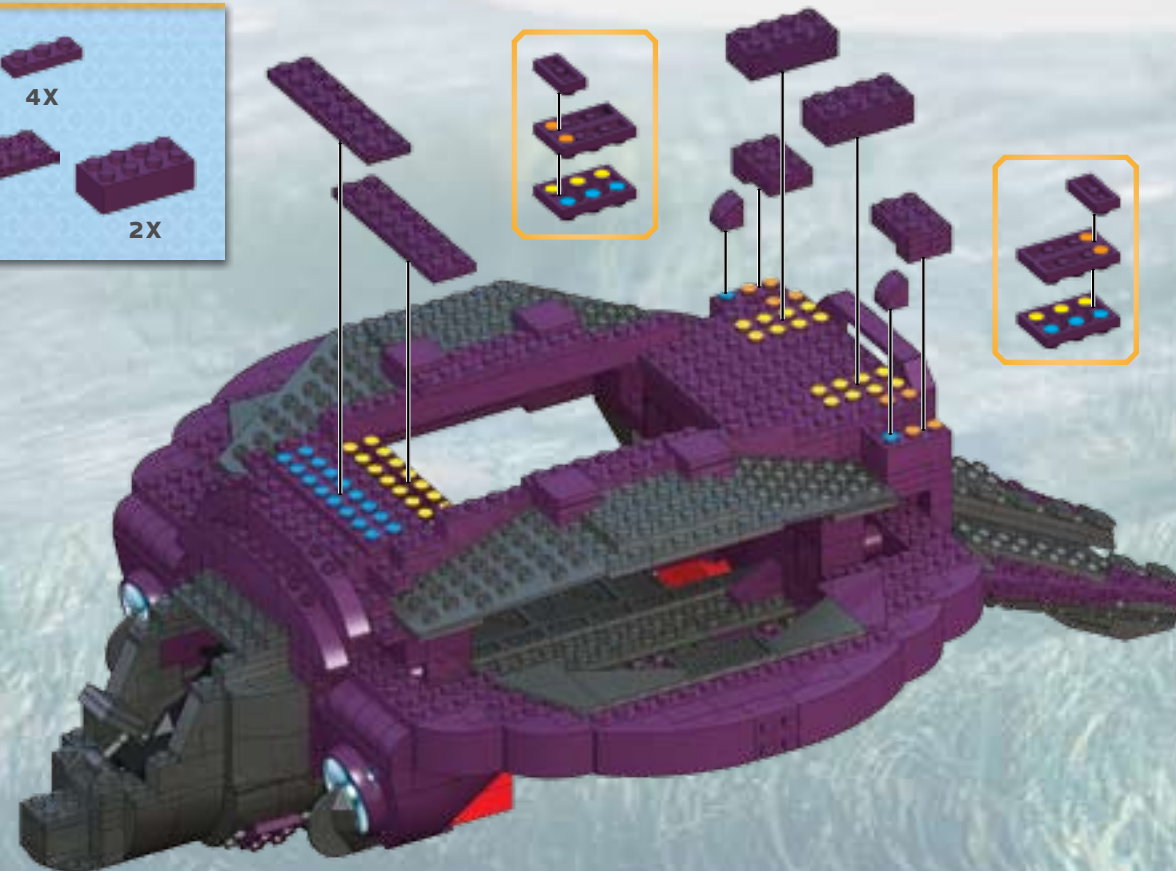



63

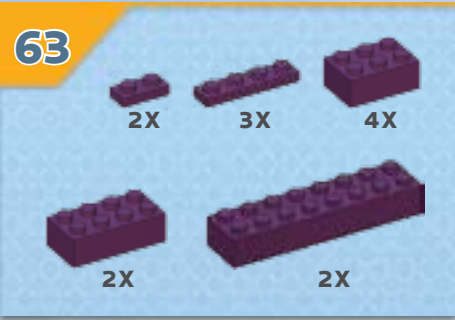

64

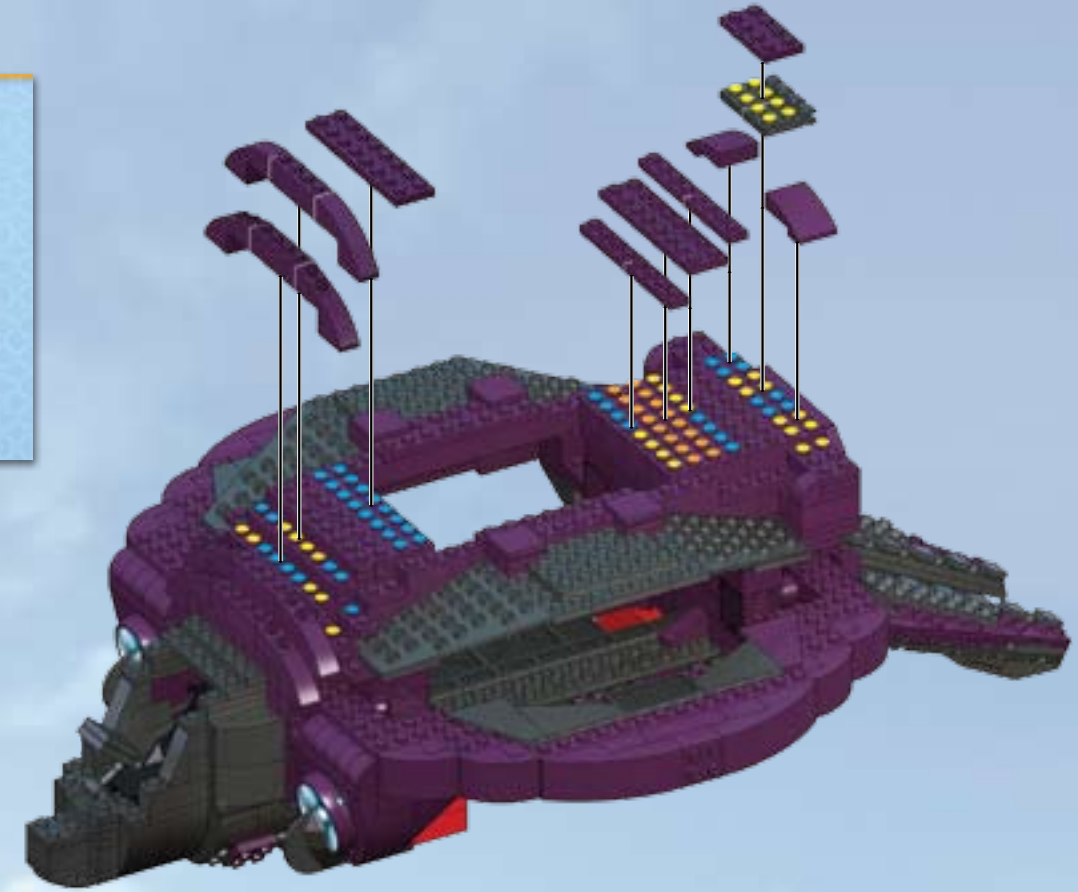
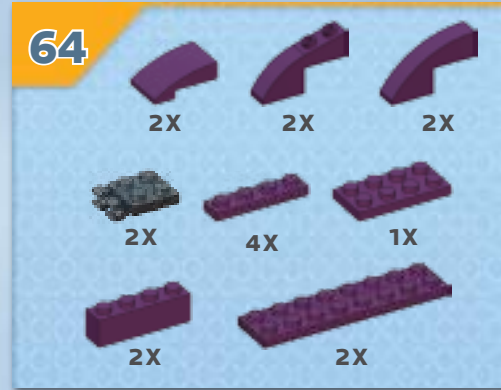

65

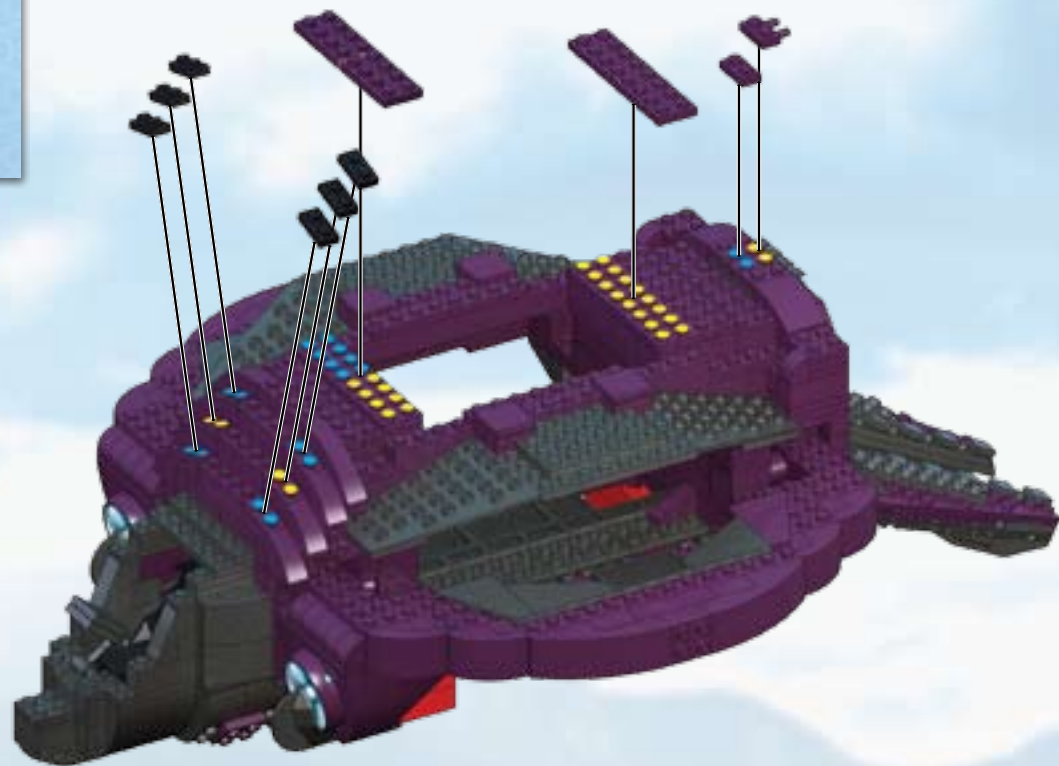
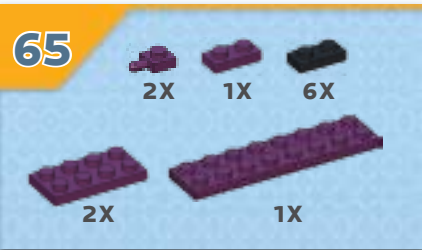

66

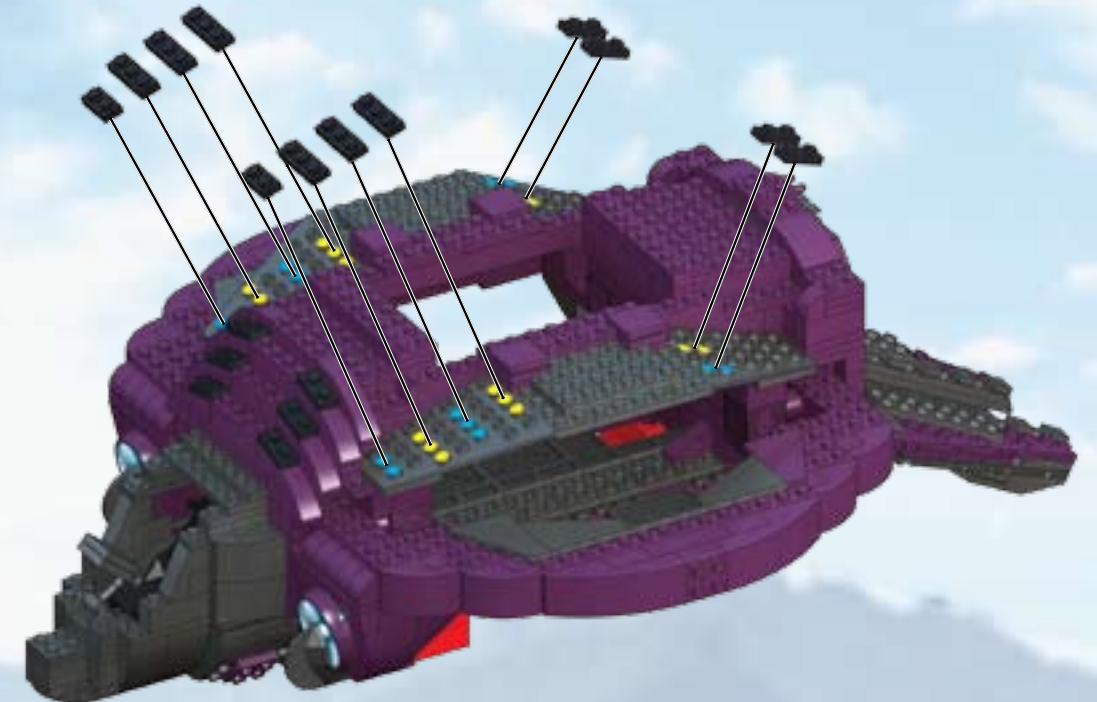
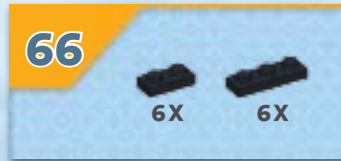



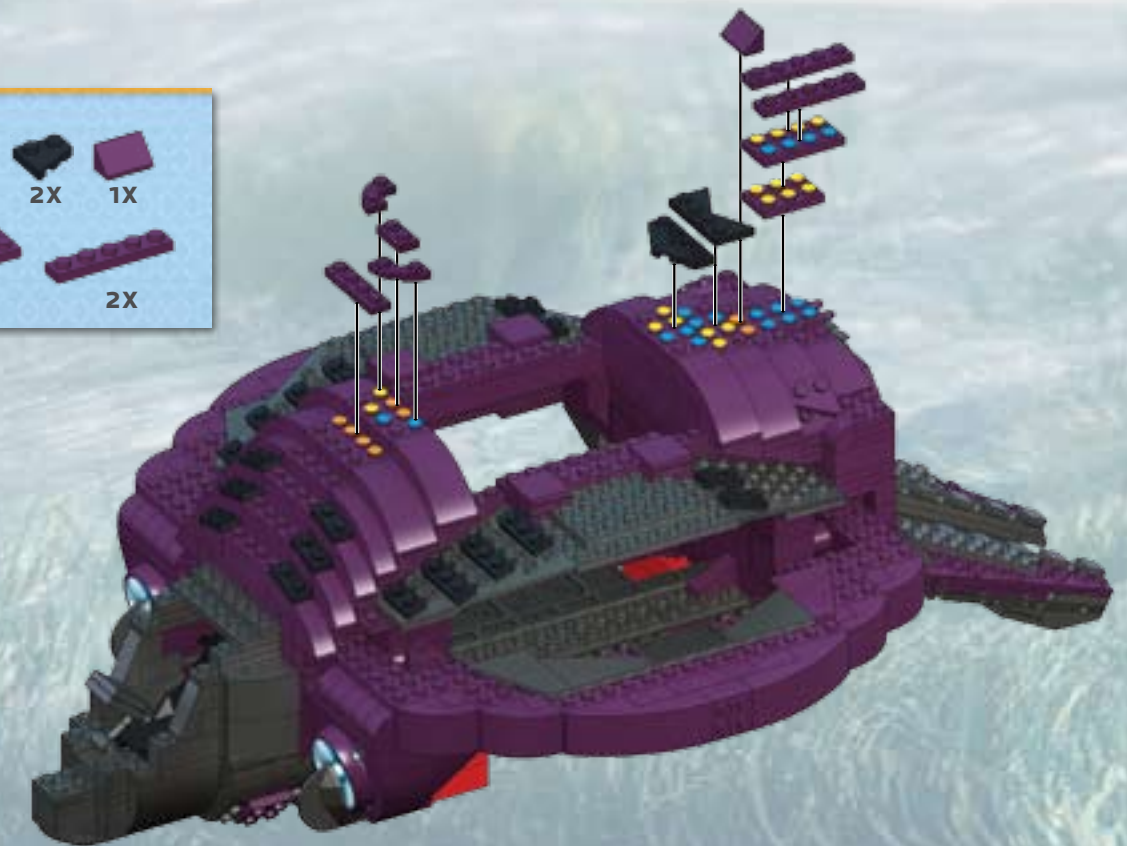
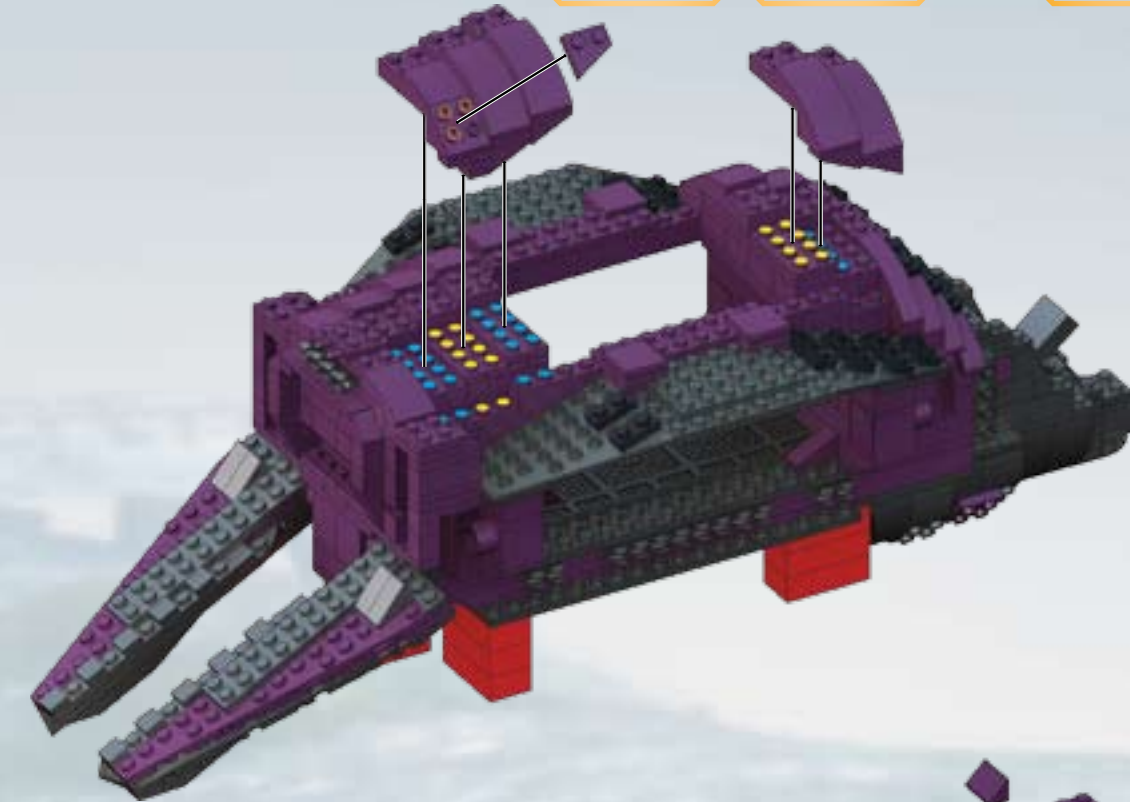
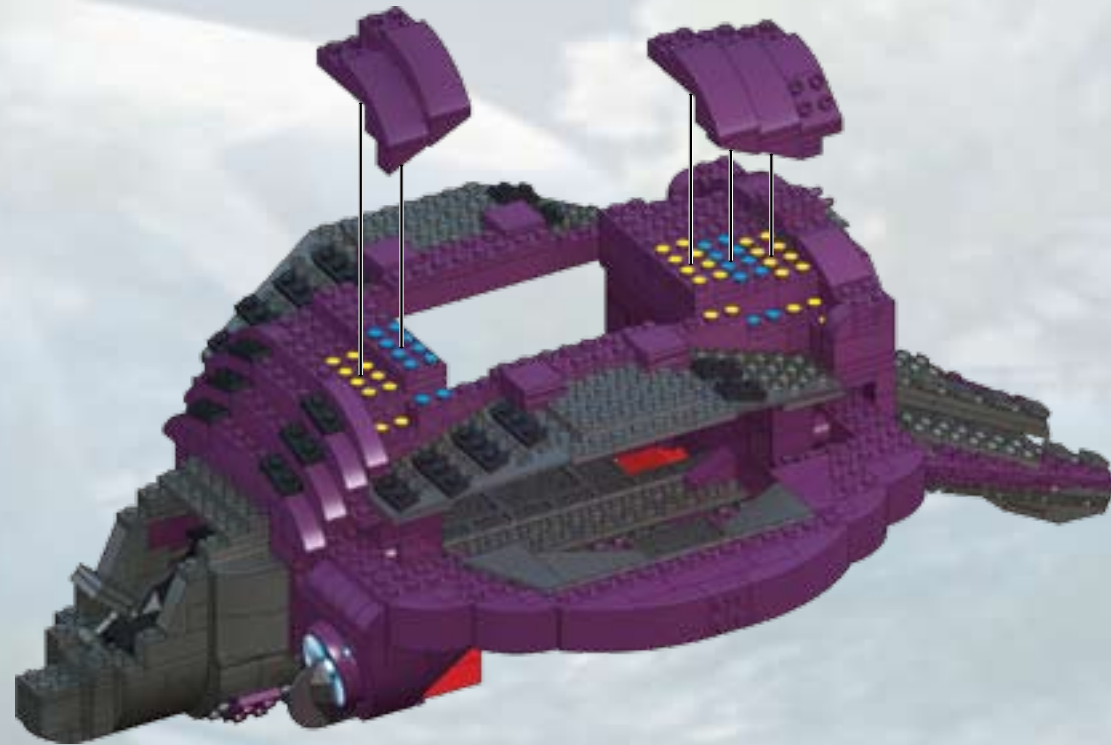
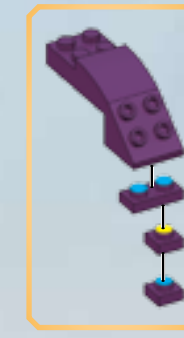
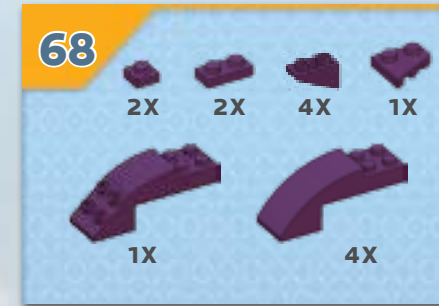
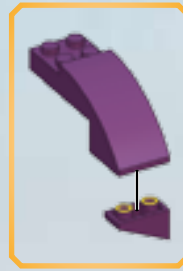
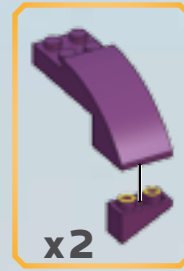



71



72

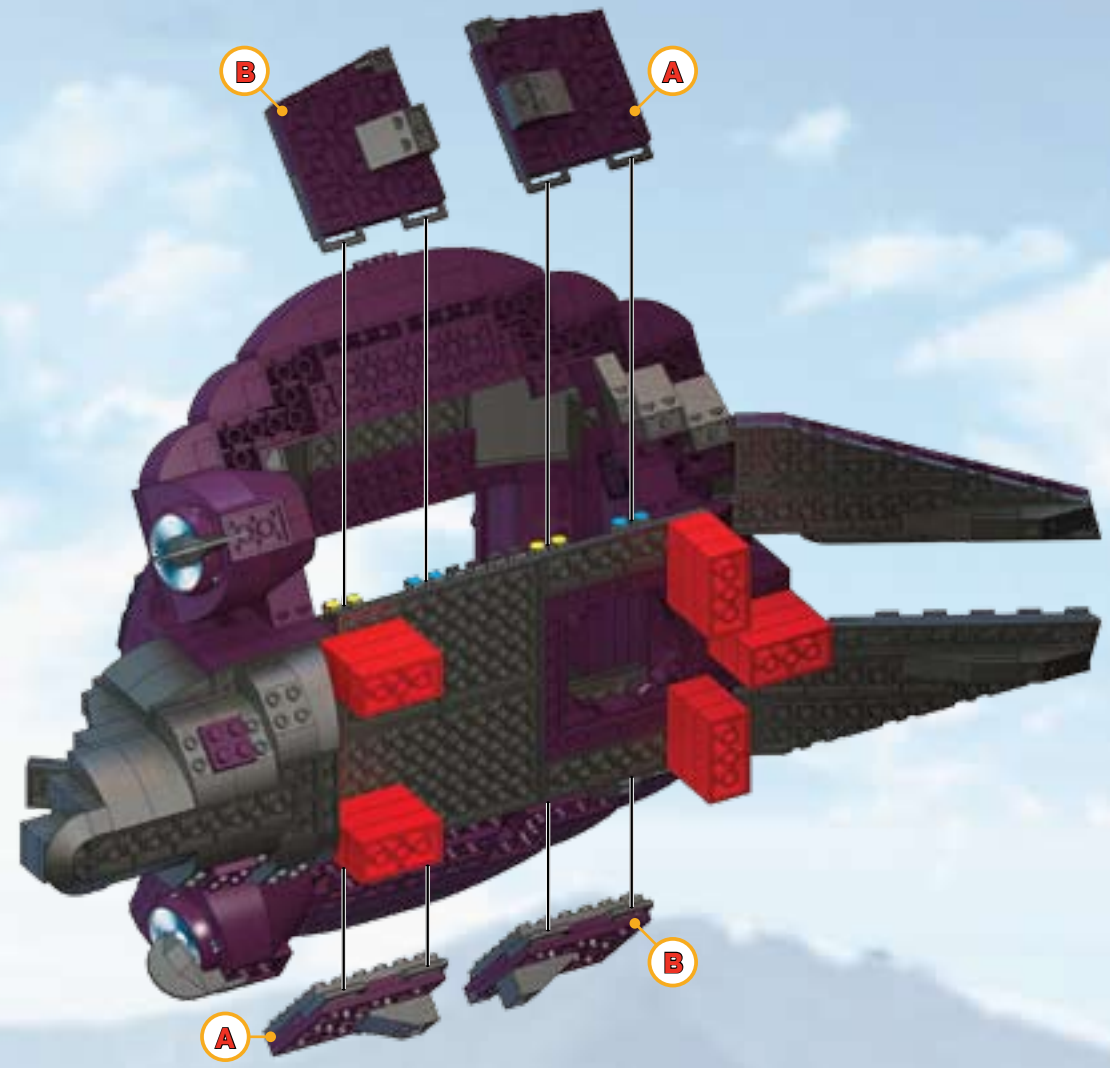
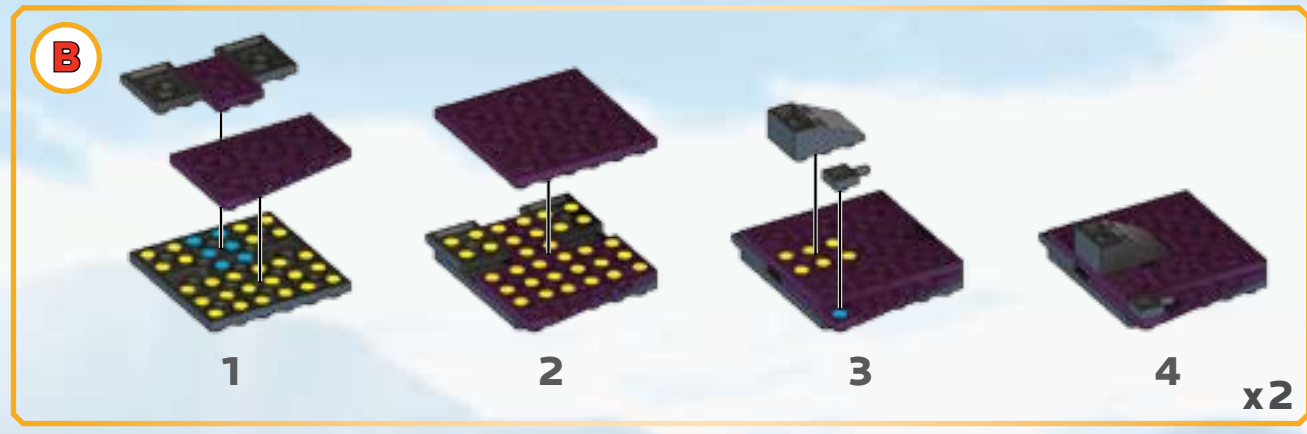
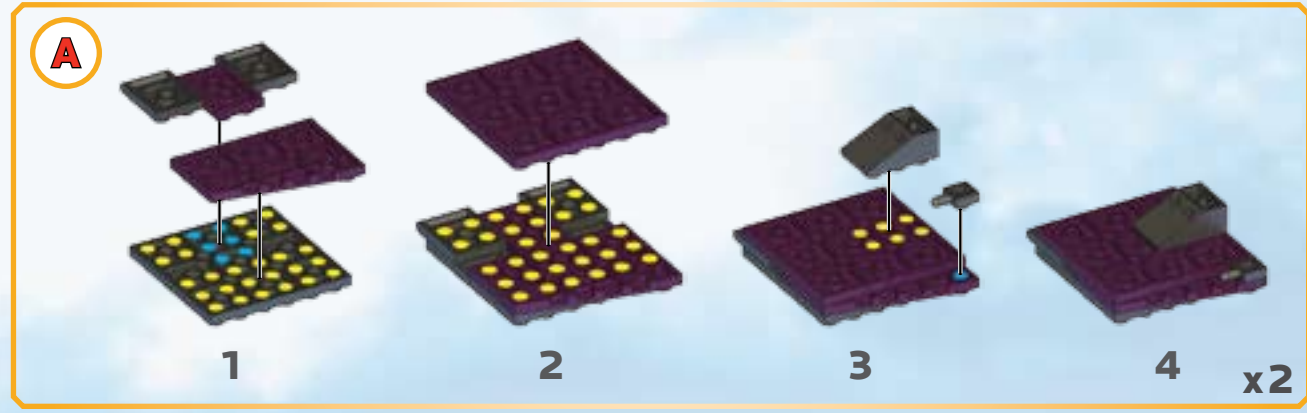
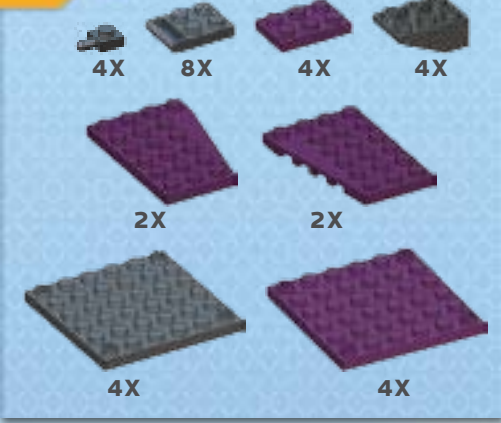



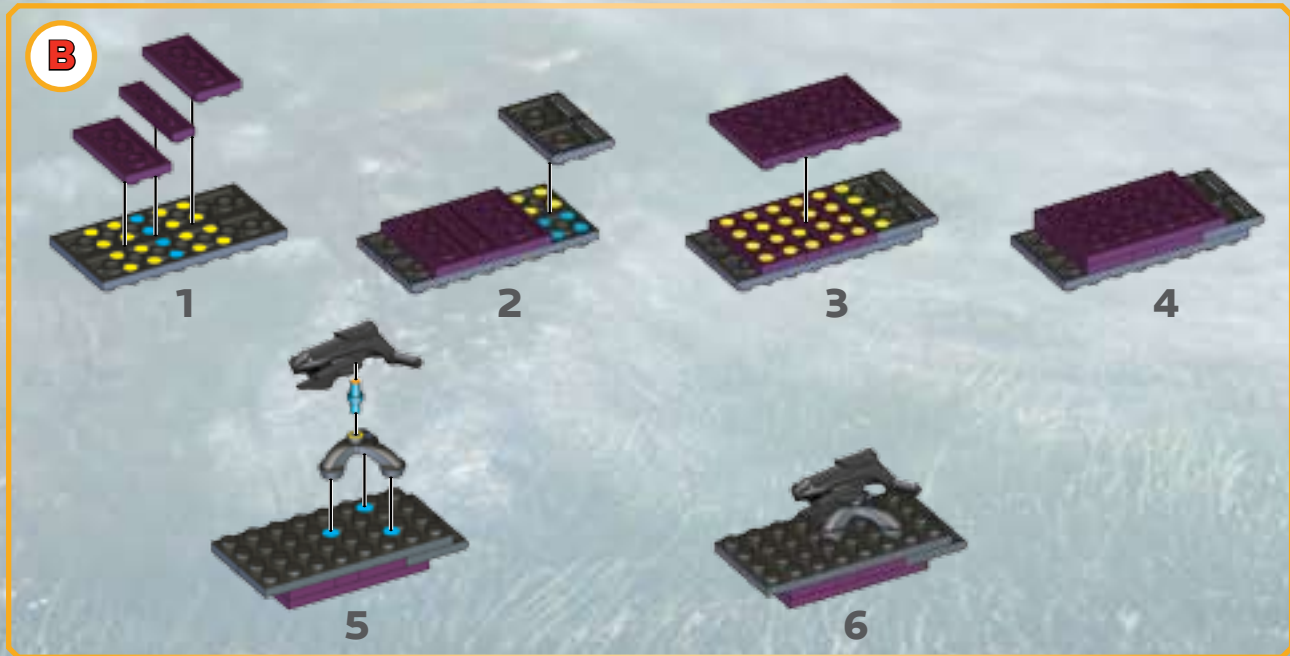



74

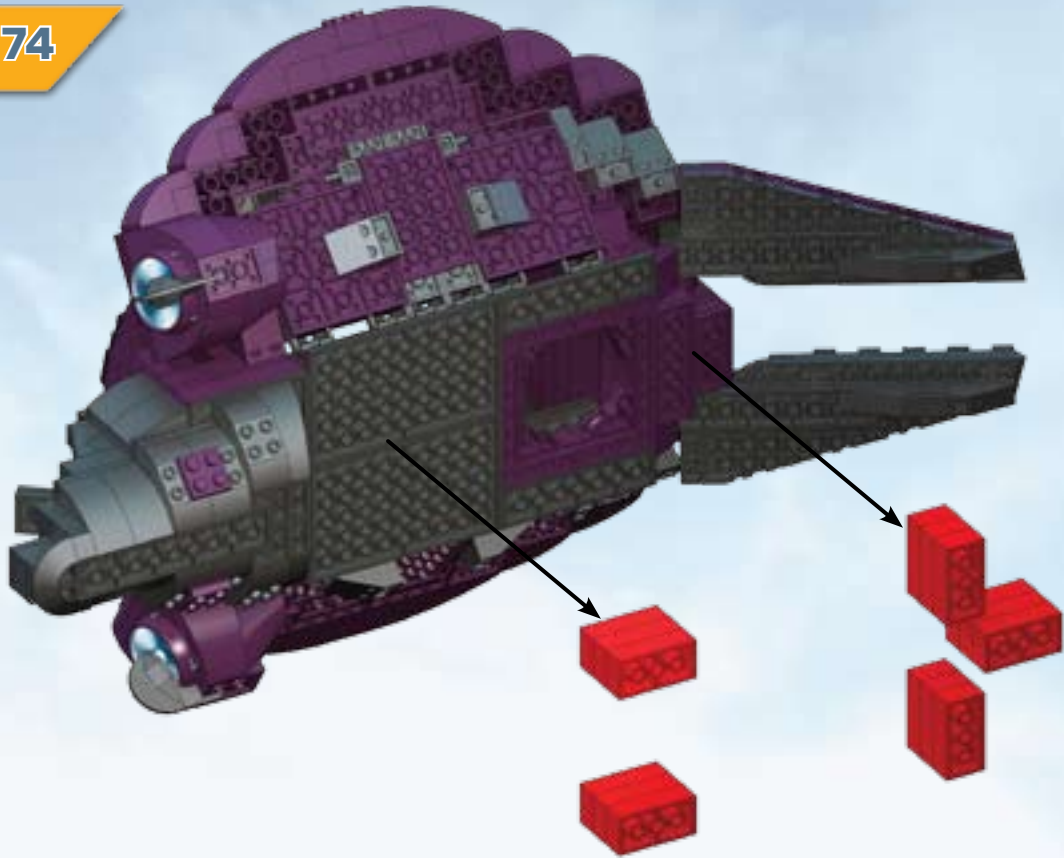

Remove temporary pieces.  
 Retirar las piezas provisionales.  
 Enlever les pièces temporaires.  
 Provisorische Teile entfernen.  
 Verwijder de tijdelijke onderdelen.  
 Rimuovere i pezzi temporanei.  
 Retirar peças temporárias.

75

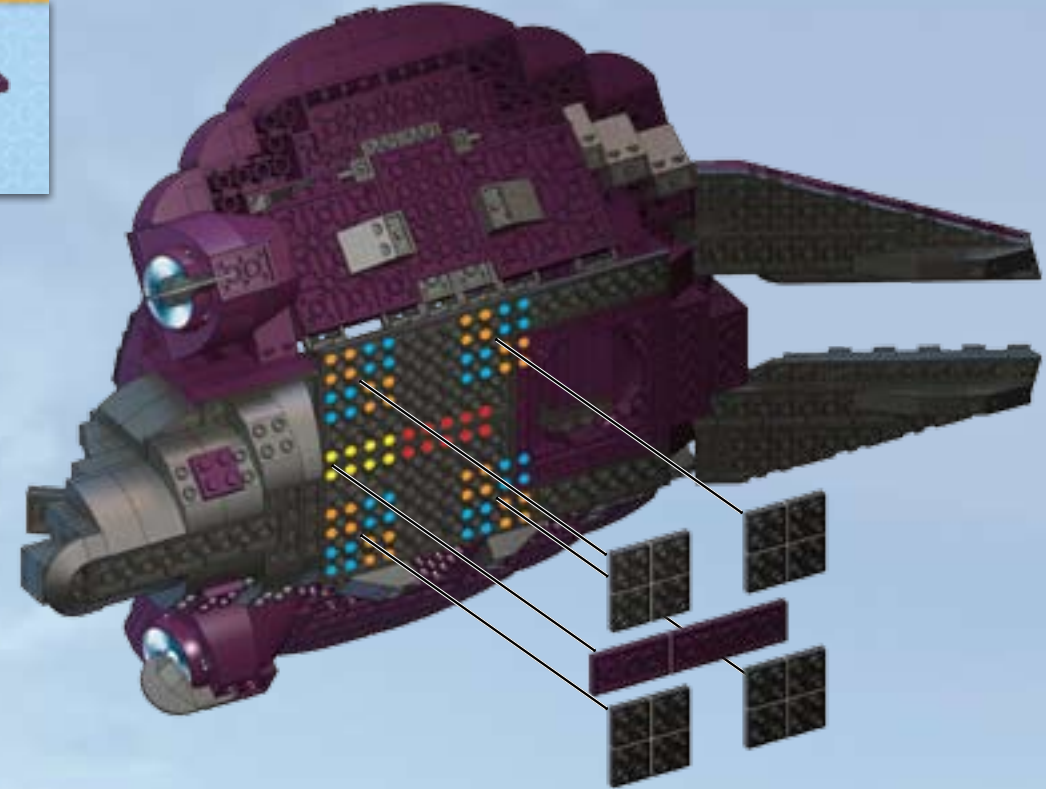

76

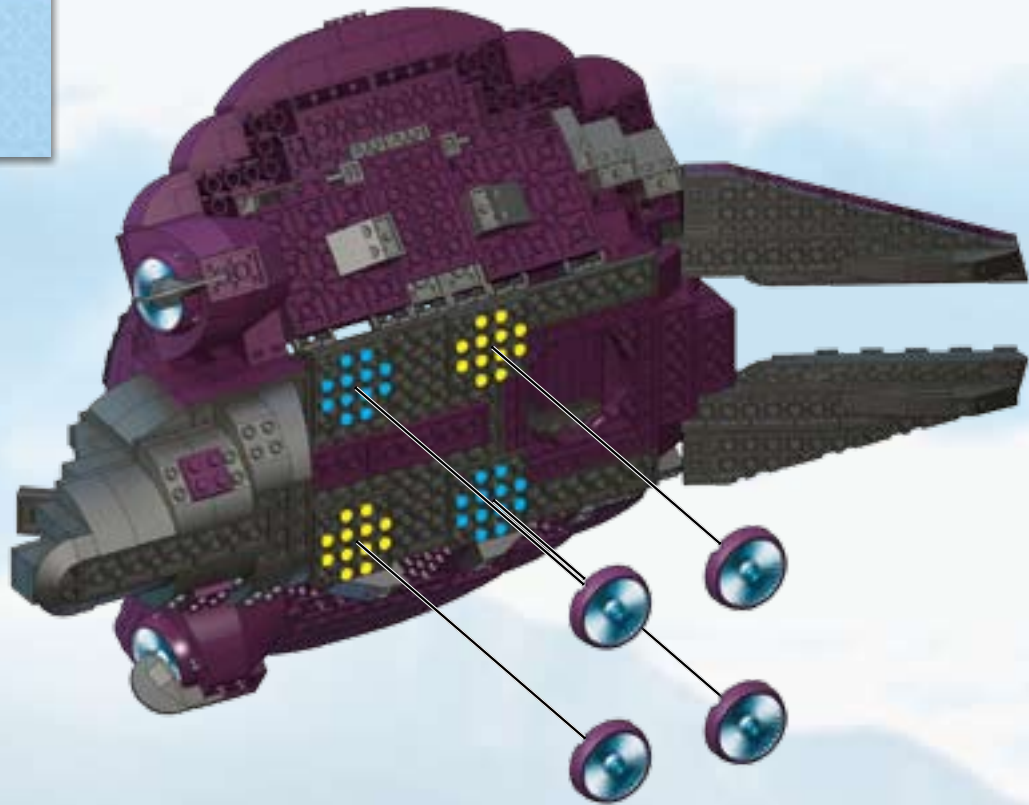
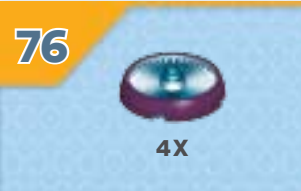

77

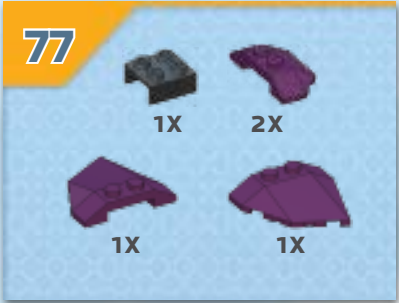



78

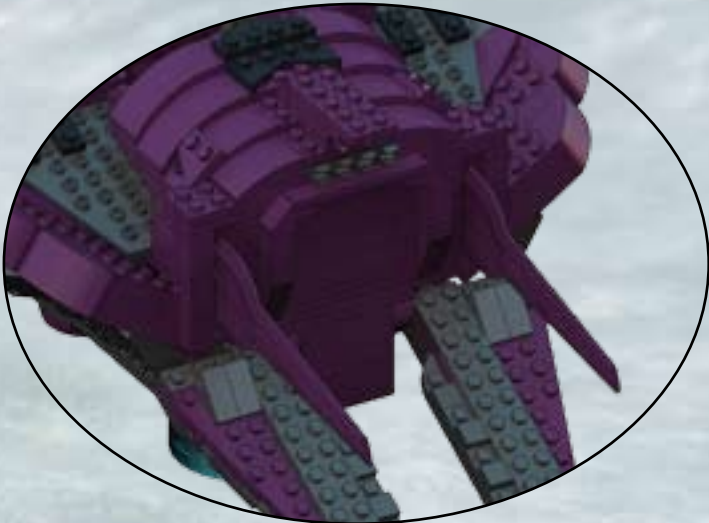
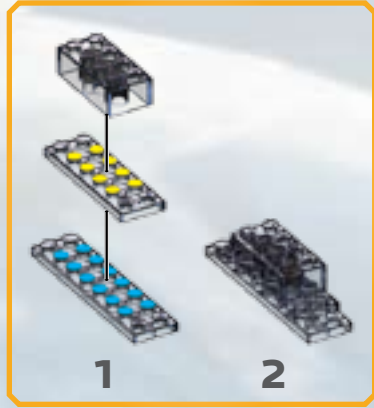
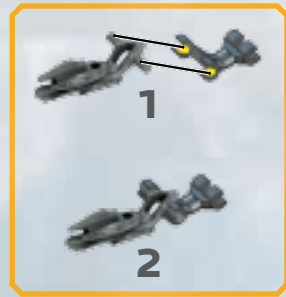
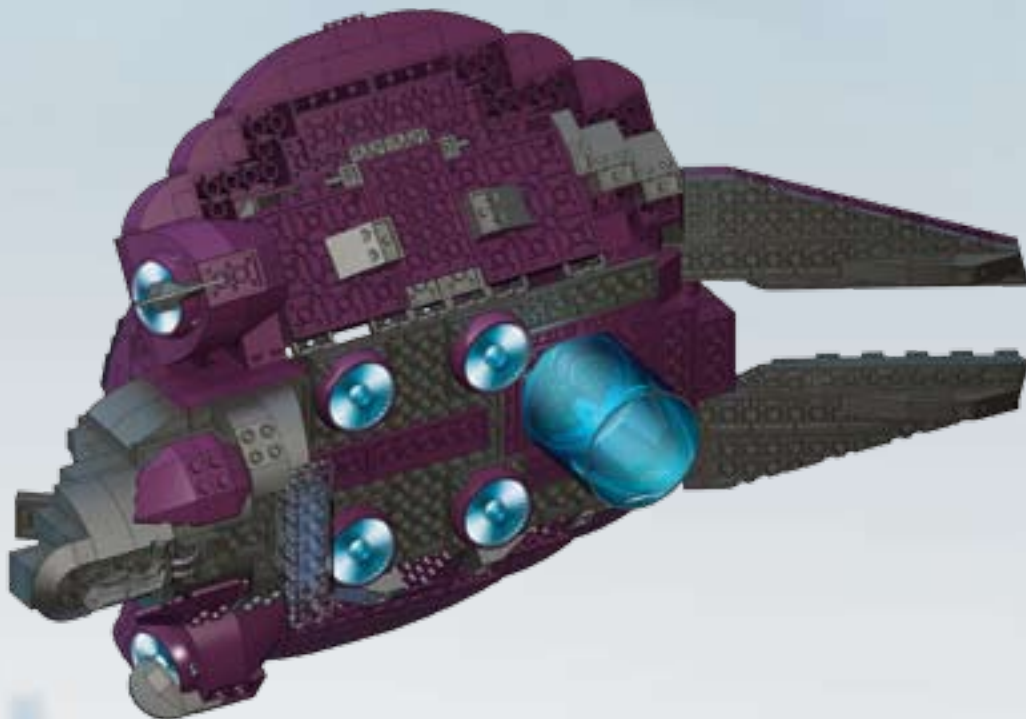
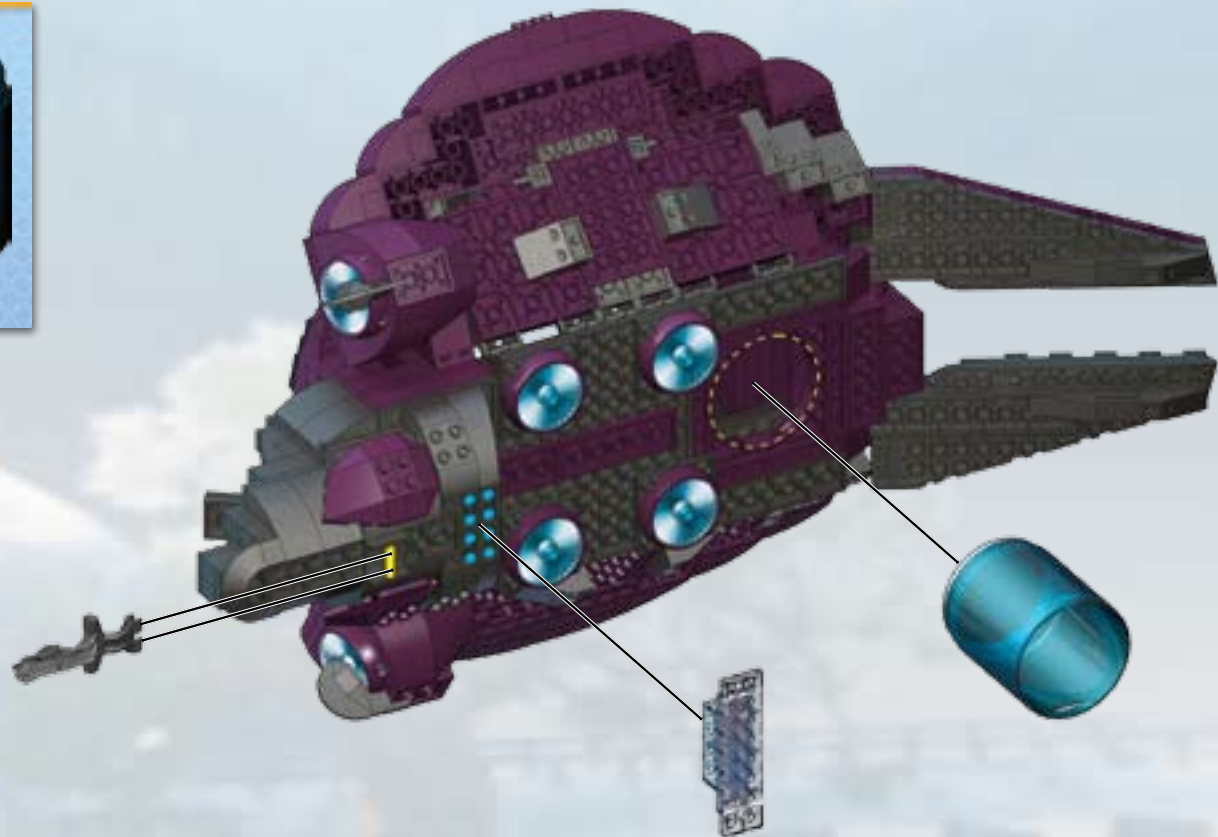
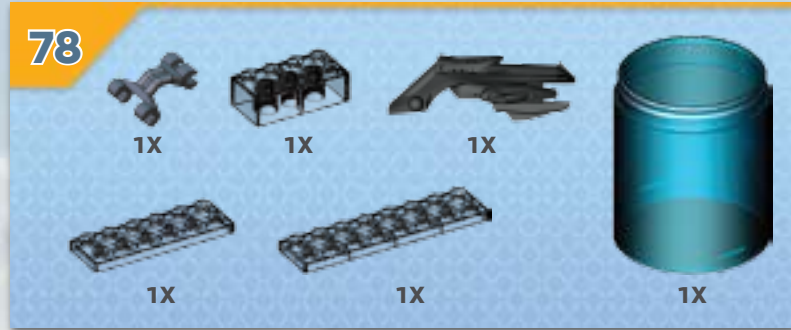



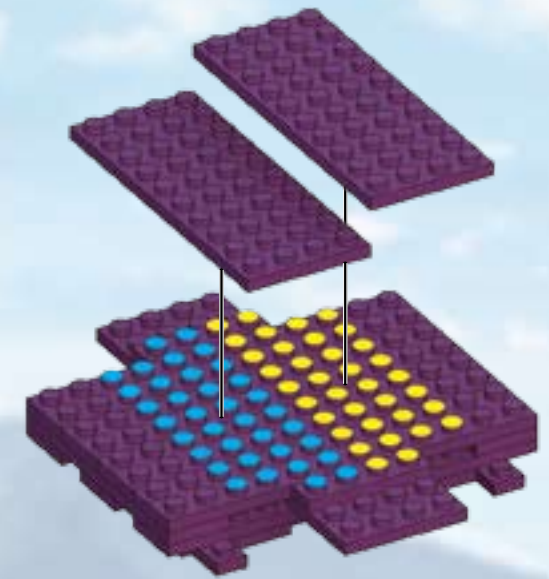
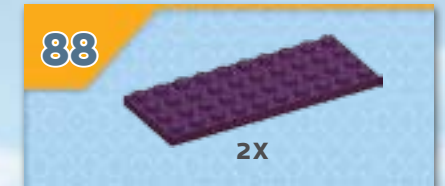
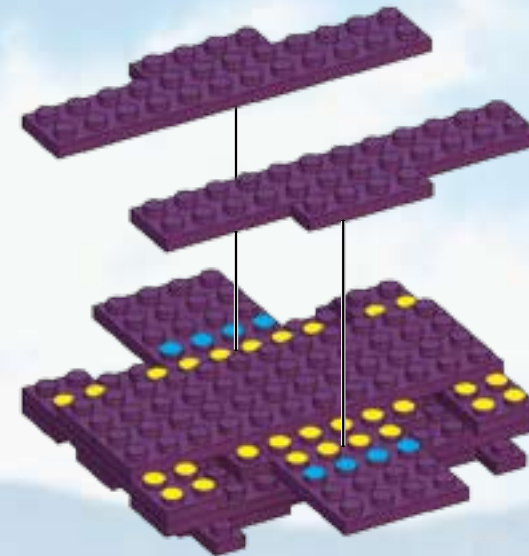
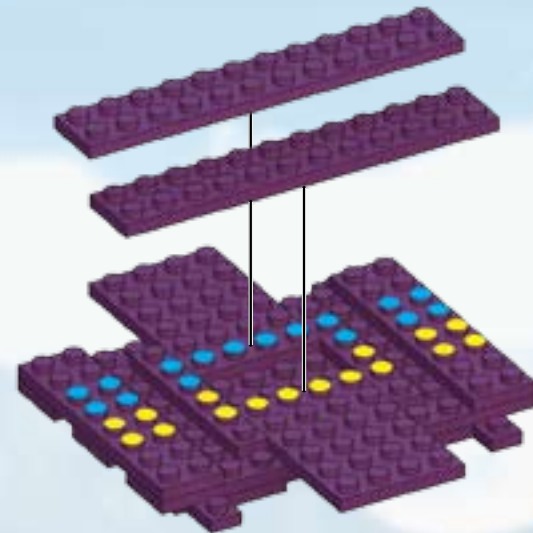
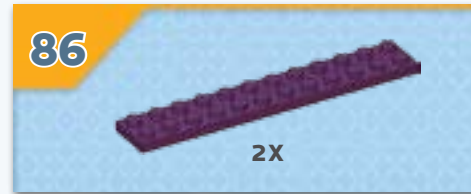
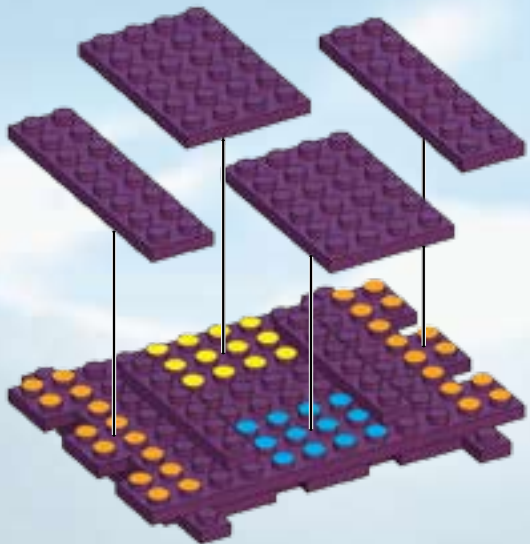
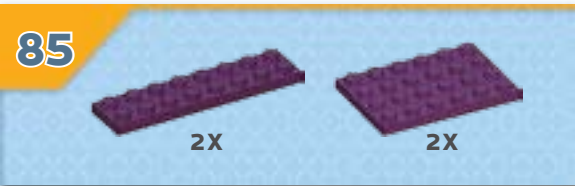
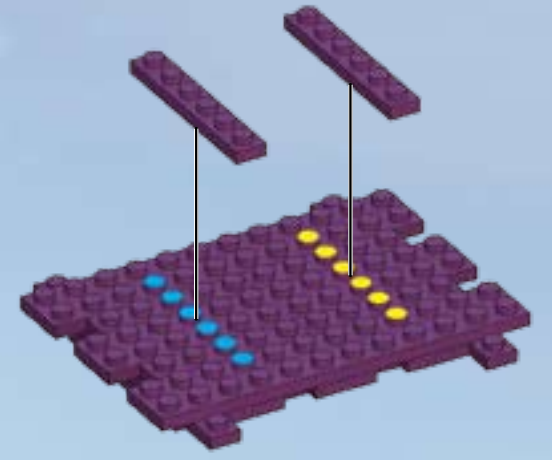
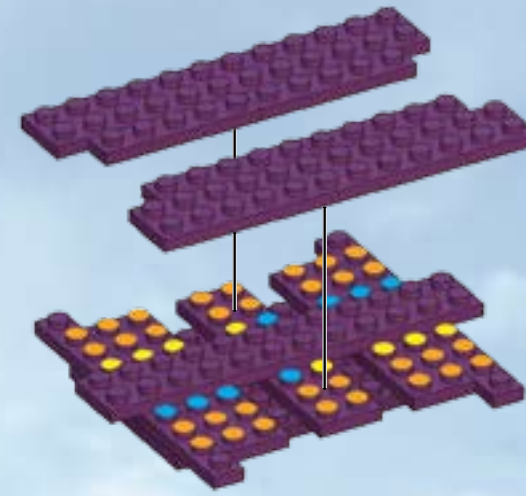
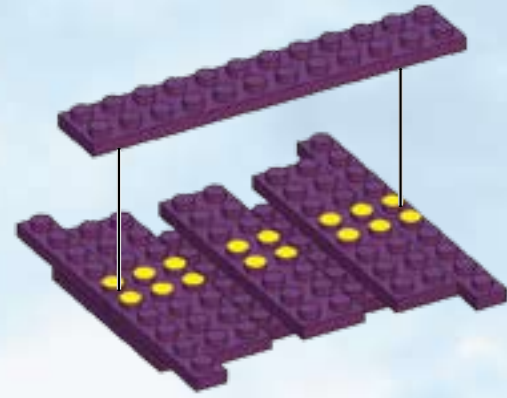
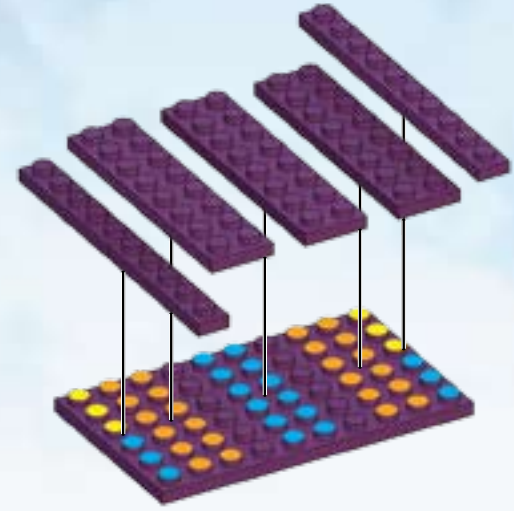
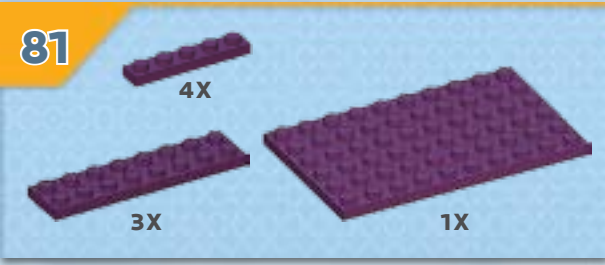



**89**



2X 2X 1X

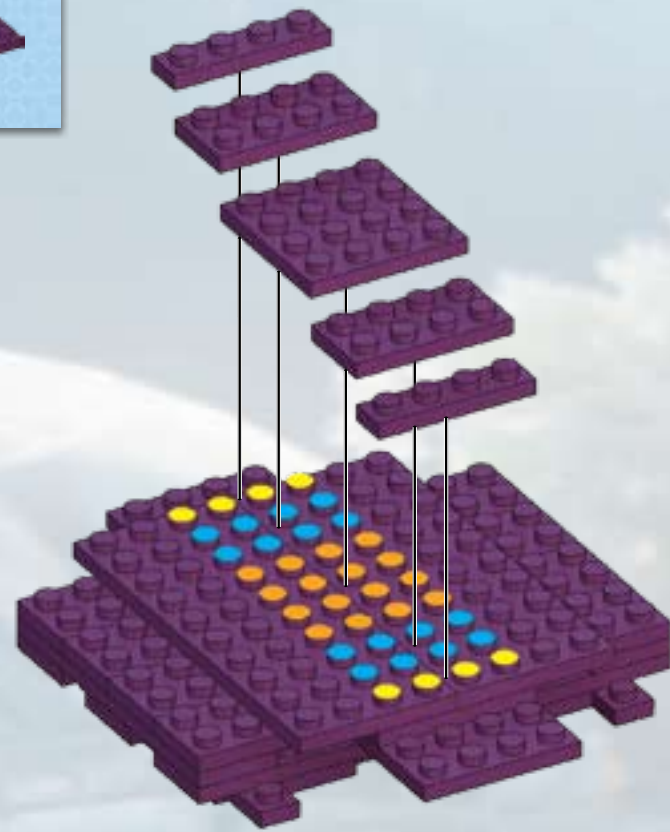

**90**



2X 2X 2X

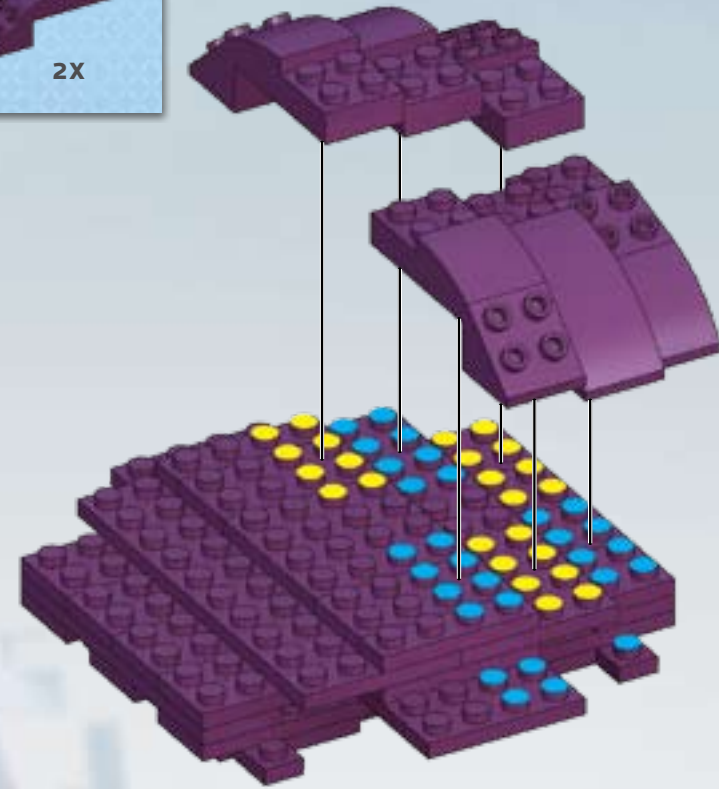

**91**



2X 4X

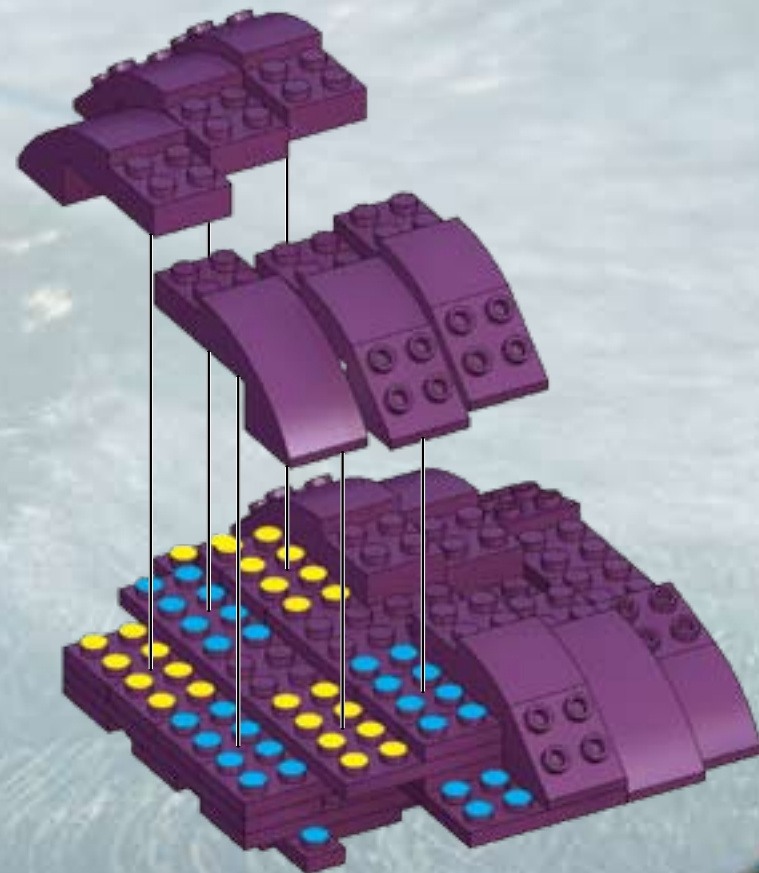

**92**



2X 1X

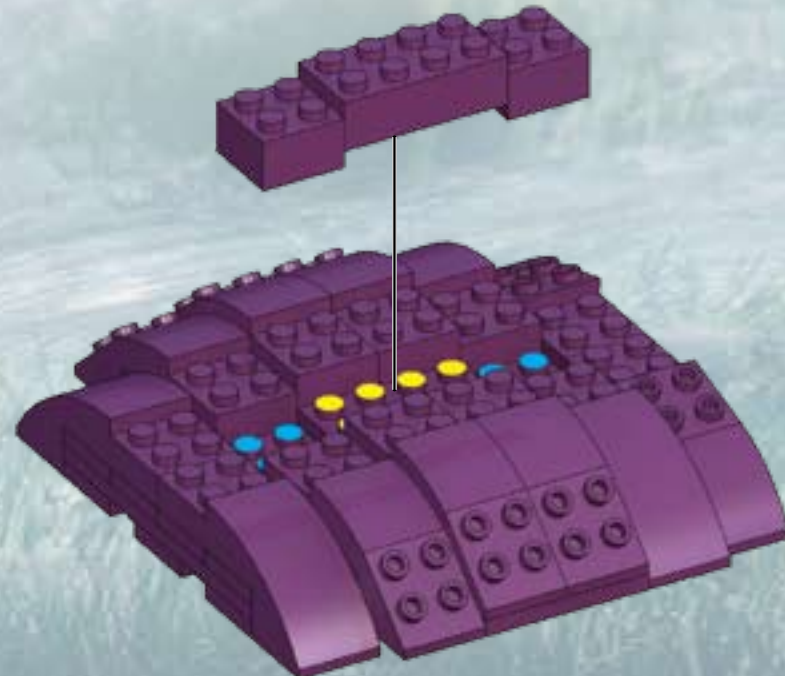



93

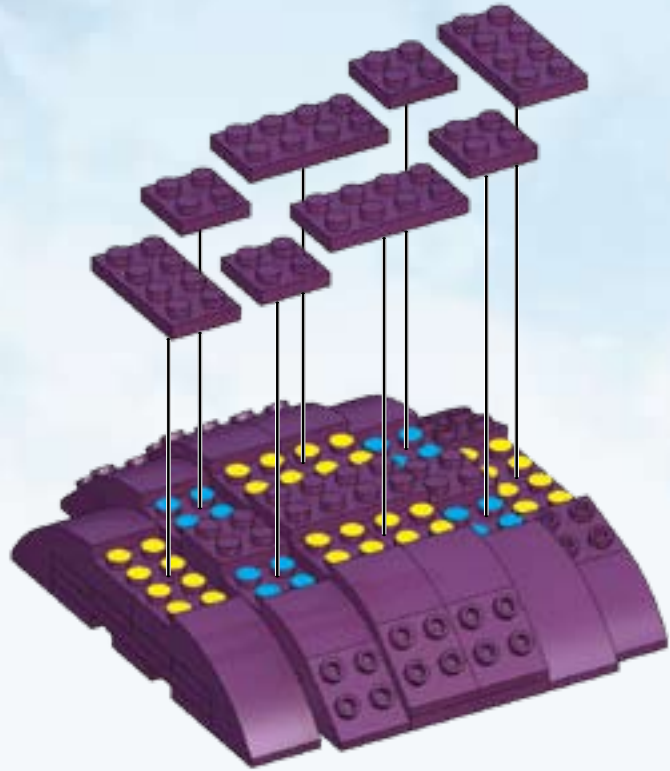

94

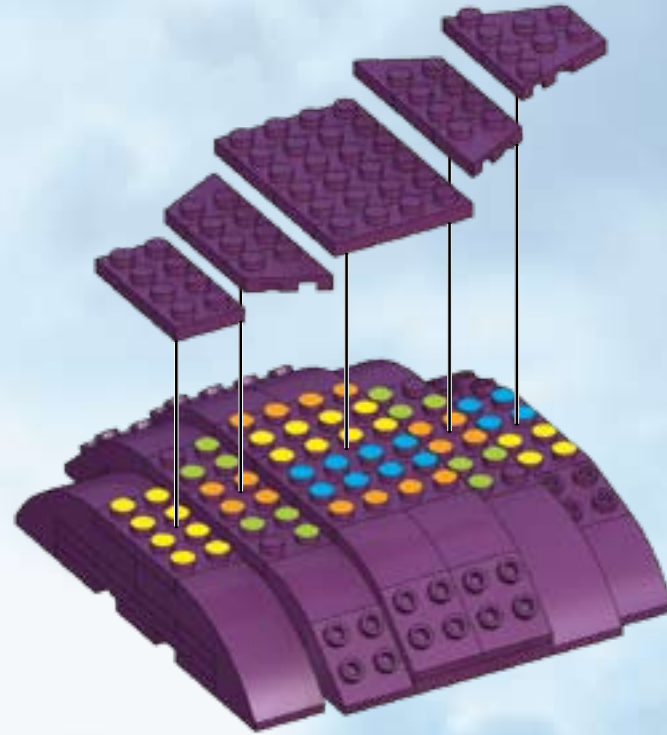
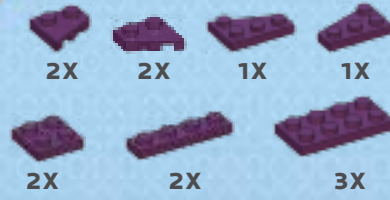

95

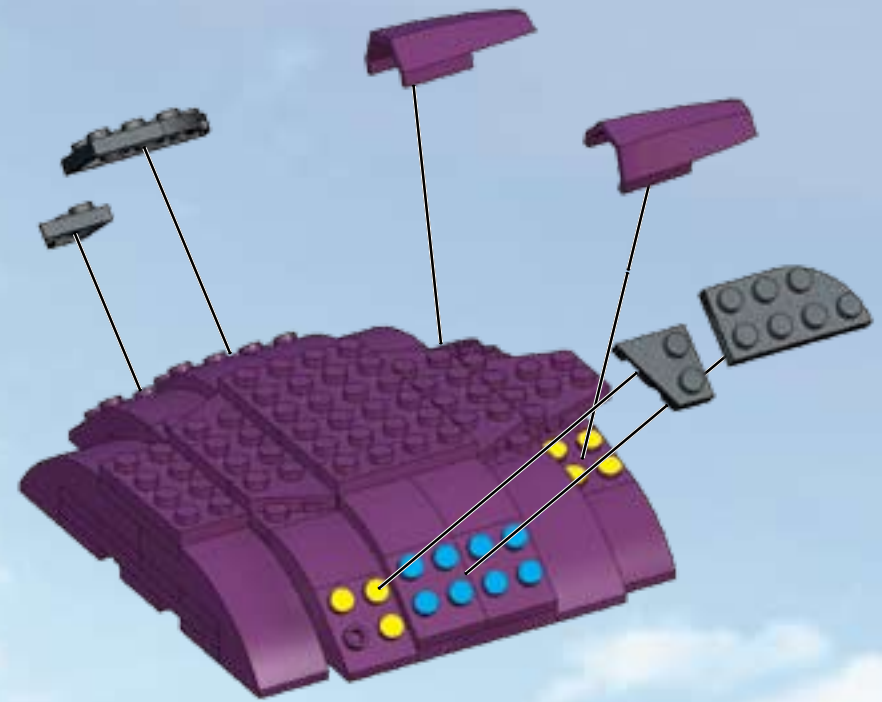

96

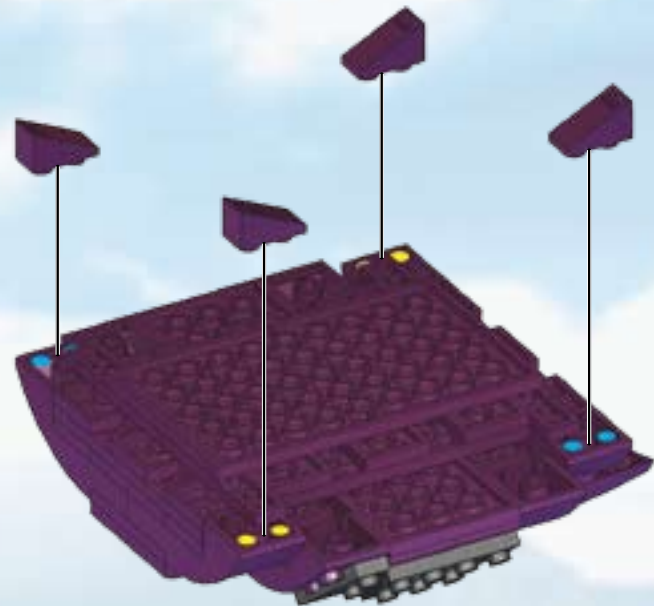

1

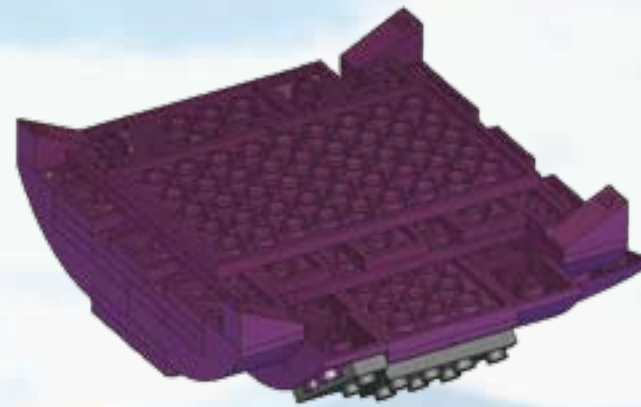

2



3



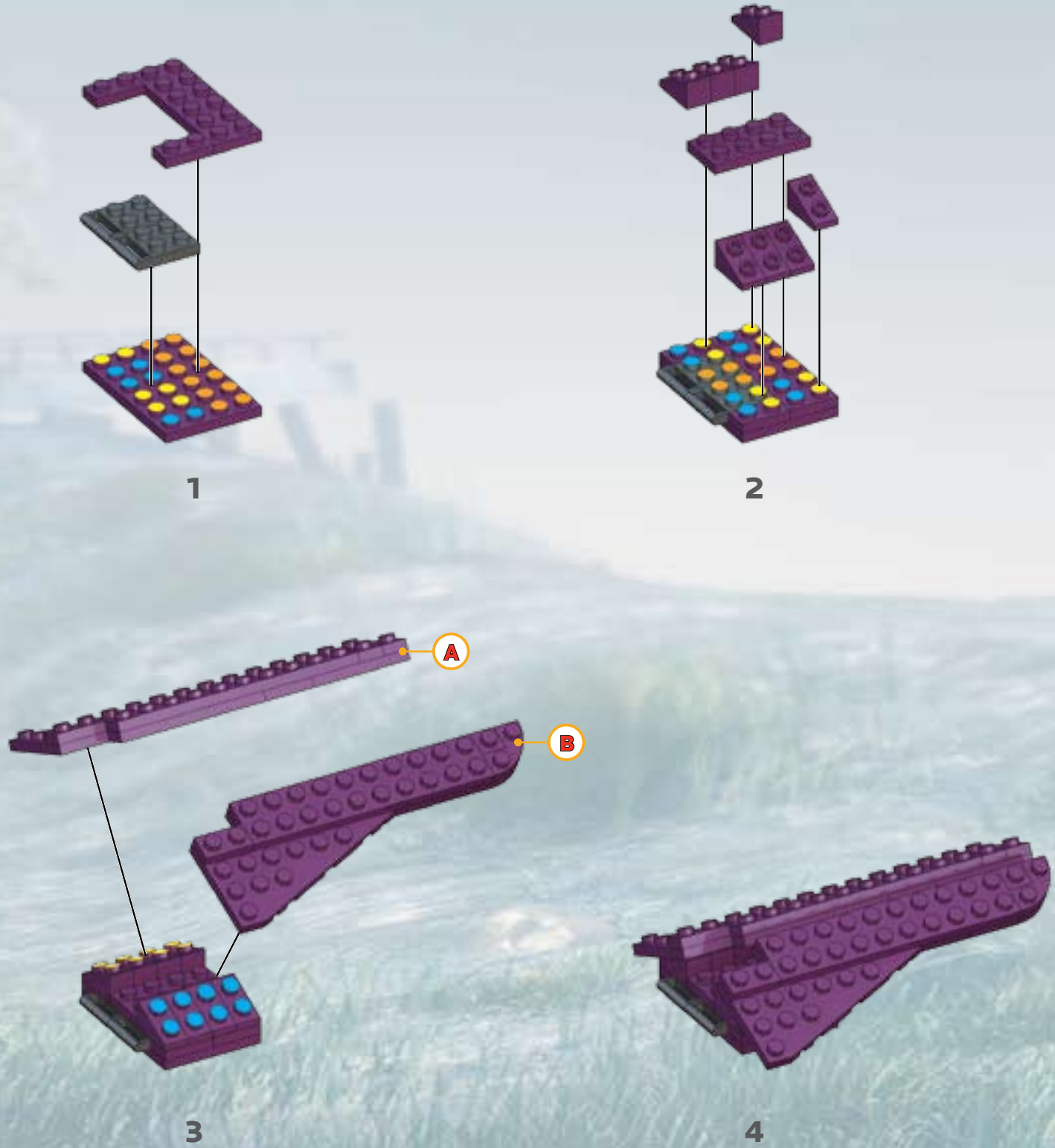
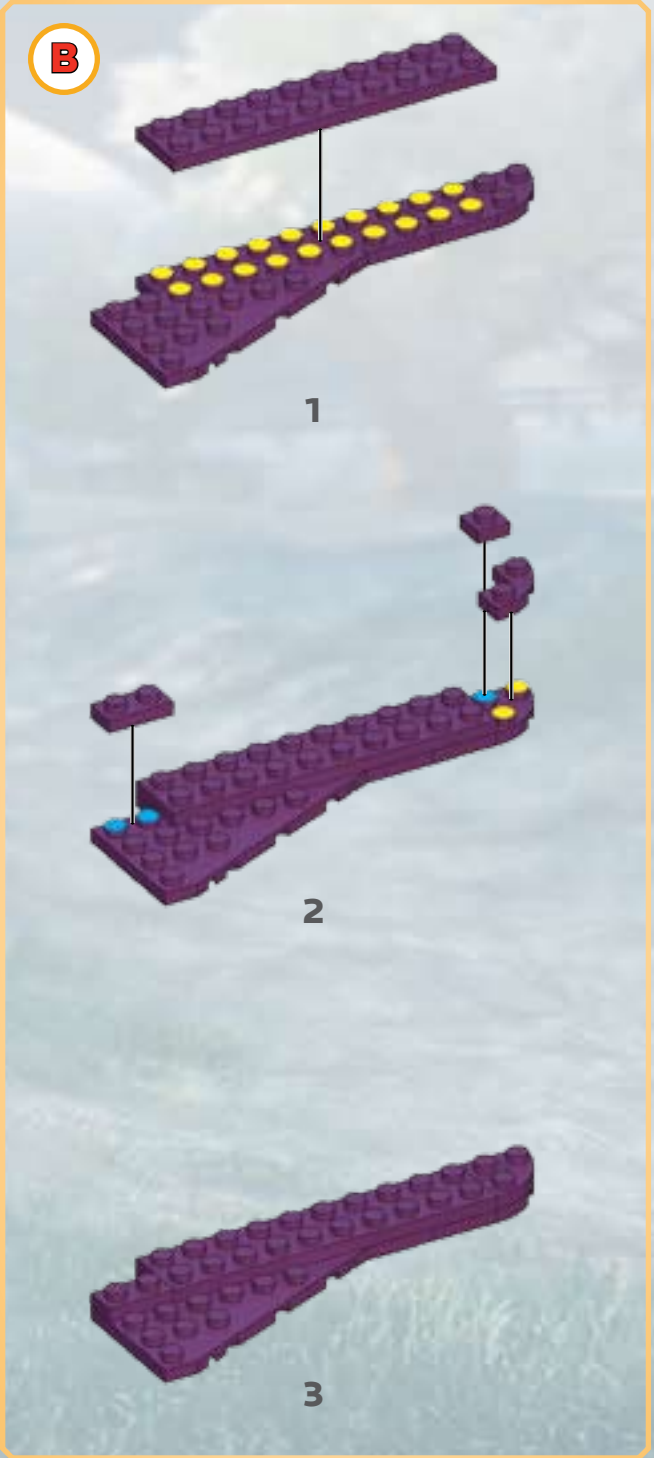
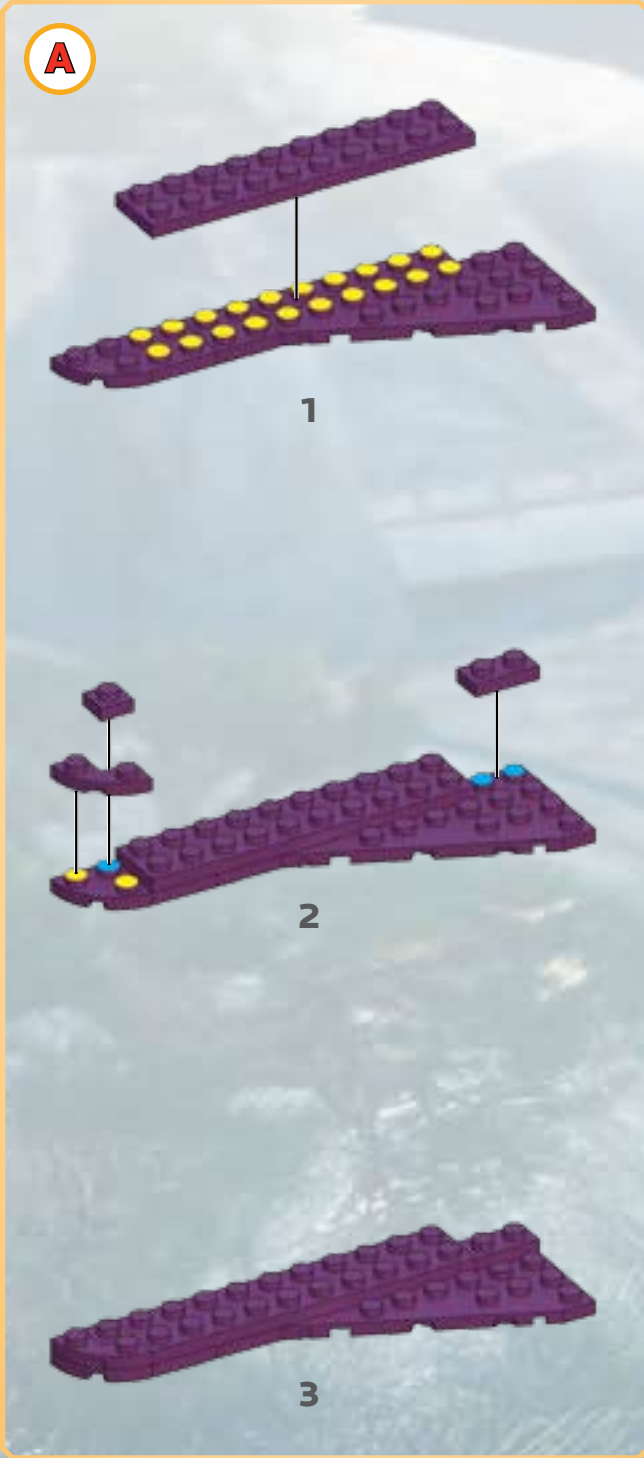
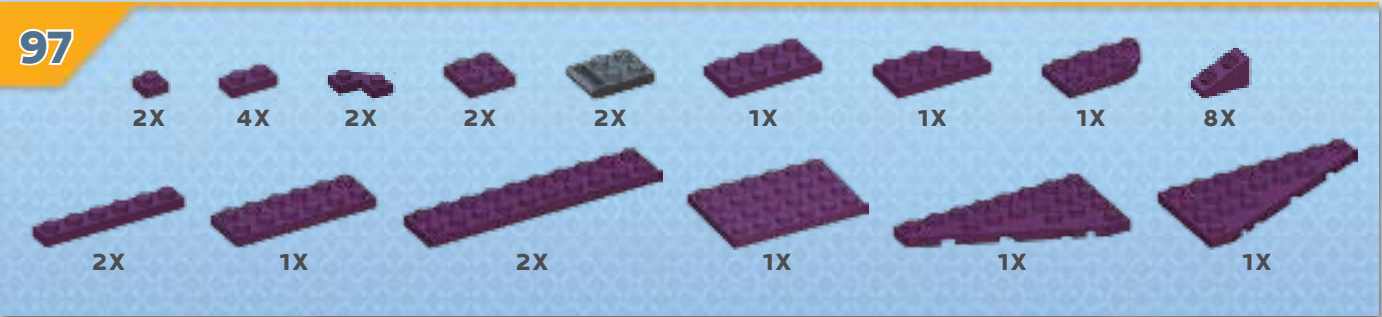



98

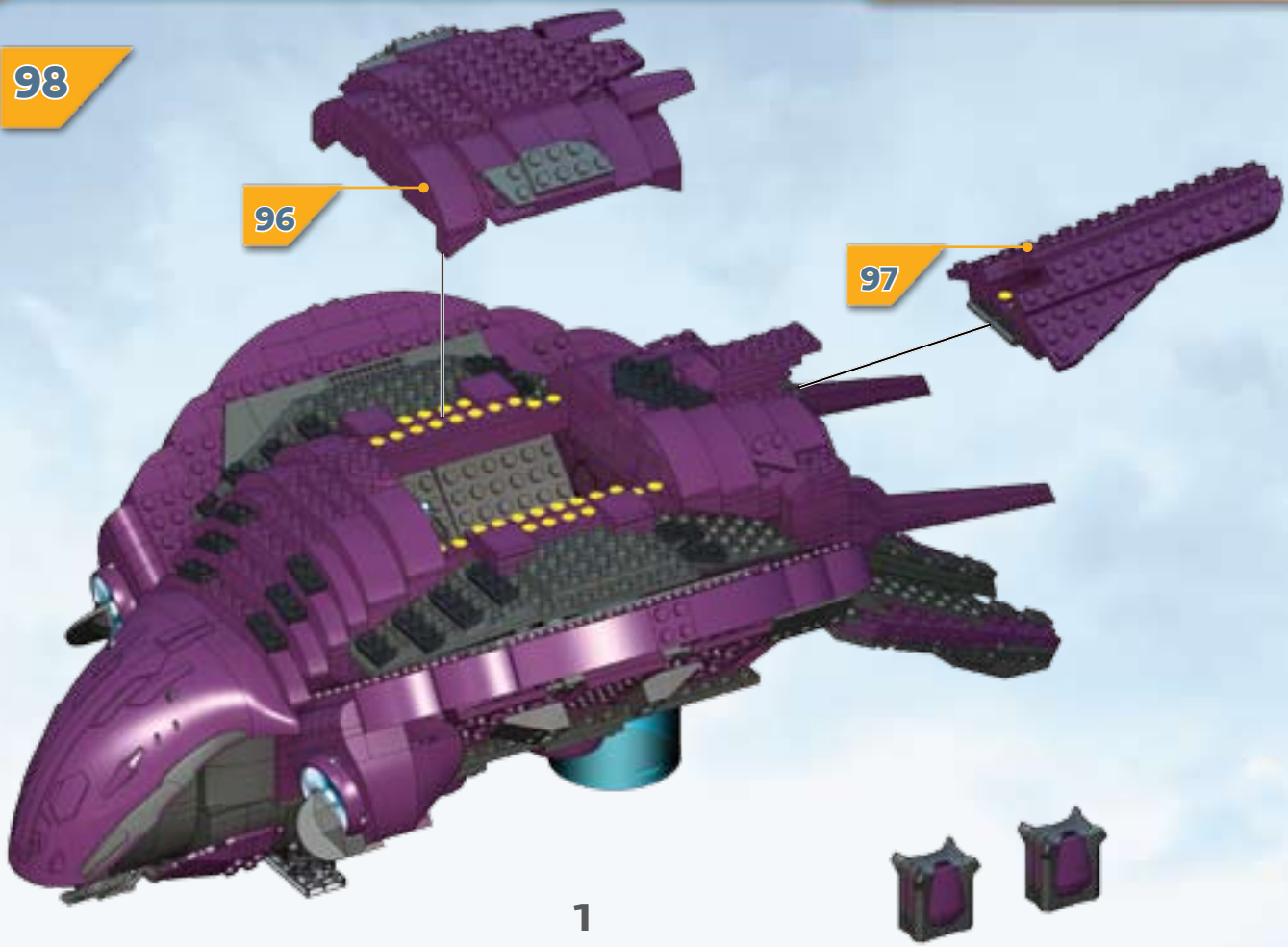

1



2

99

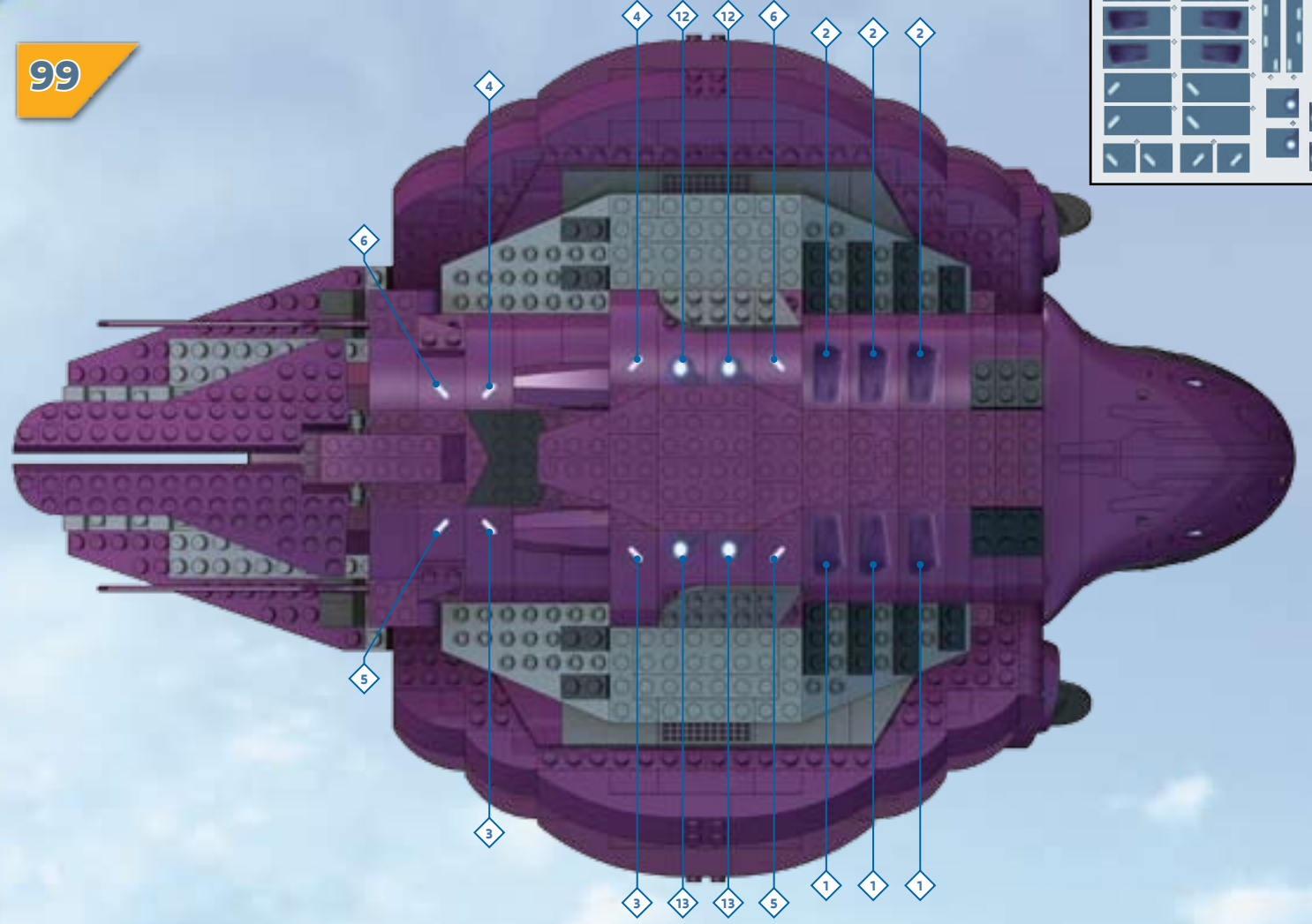

3

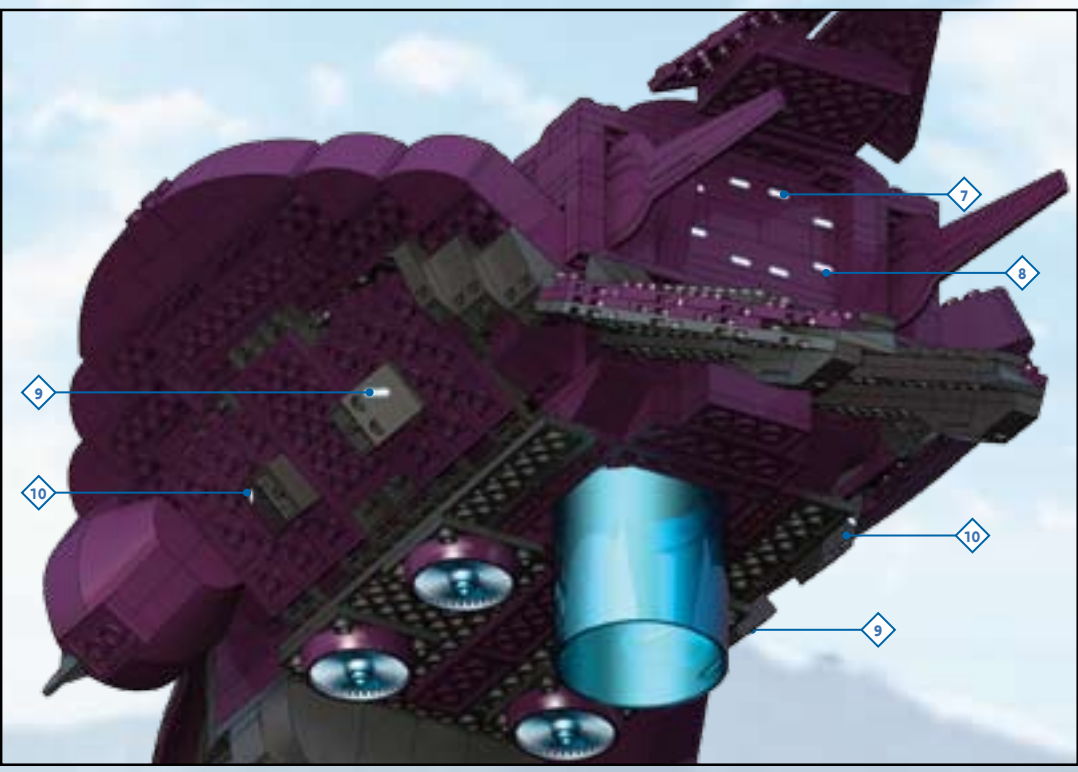

10

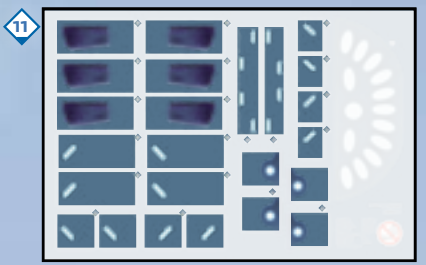

11

4 12 12 6 2 2 2

6

5

3 13 13 5 1 1 1

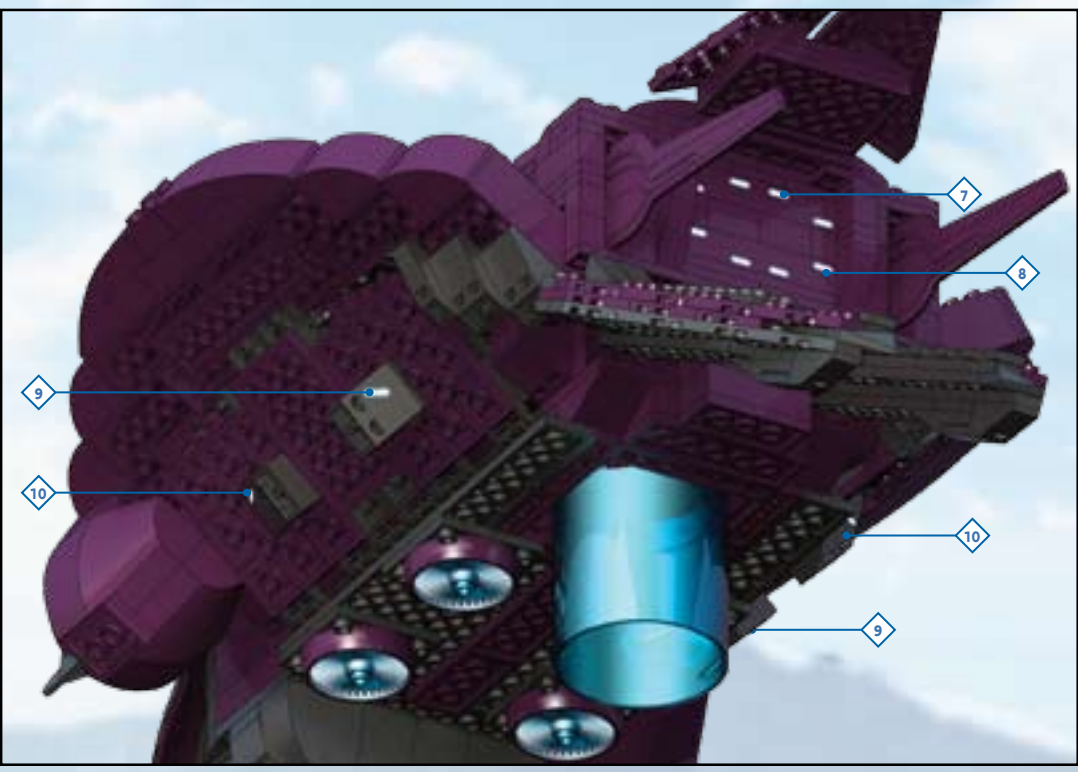

9

10

7

8

10

9



Covenant Phantom  
Phantom de los Covenant  
Phantom Covenant  
Covenant-Phantom  
Covenant Phantom  
Covenant Phantom  
Phantom Covenant





# HALO

THE AUTHENTIC COLLECTOR'S SERIES  
 LA AUTÉNTICA SERIE PARA COLECCIONISTAS  
 SÉRIE AUTHENTIQUE POUR COLLECTIONNEUR  
 DIE AUTHENTISCHE SAMMLER-SERIE - DE AUTHENTIEKE VERZAMELAARSSERIE  
 L'AUTENTICA SERIE PER COLLEZIONISTI - A SÉRIE DO VERKADENDE COLECCIONADOR

## COVENANT PHANTOM

An Elite Pilot maneuvers a Covenant Phantom into action-providing heavy cover fire from its three rotating plasma cannons, as it delivers a deadly Arbiter and two Ultra Grunts to the battlefield, tipping the scales against their UNSC foes.

### Phantom de los Covenant

Un piloto de élite maneja un Phantom del Covenant, escupiendo un devastador fuego de distracción por sus tres cañones rotantes de plasma mientras un mortífero árbitro de la Élite y dos Ultra Grunts saltan al campo de batalla, inclinando la balanza a su favor contra los enemigos de la UNSC.

### Phantom Covenant

Un Elite Covenant manoeuvre un Phantom Covenant pour plonger en pleine action, fournissant une lourde puissance de feu grâce à ses trois canons rotatifs à plasma. Il lance un redoutable Arbiter Élite et deux Grunts Ultra dans la bataille pour faire pencher la balance de leur côté et écraser leurs ennemis CSNU.

### Covenant Phantom

Ein Elite-Pilot manövriert ein Allianz-Phantom durch das Krisengebiet. Dabei leistet er Feuerschutz aus den drei rotierenden Plasmakanonen des Fahrzeugs und setzt einen tödlichen Elite-Arbiter und zwei Ultra Grunts auf dem Schlachtfeld ab, um den Kampf gegen die feindlichen UNSC-Einheiten für sich zu entscheiden.

### Covenant Phantom

Een Elitepiloot bestuurt een Covenant Spook richting de actie en levert hevig dekkingvuur vanaf zijn drie roterende plasmakanonnen terwijl het een dodelijke Elite Arbiter en twee Ultra Grunts op het strijdveld afzet om de vijanden van UNSC te bekampen.

### Covenant Phantom

Un pilota Élite manœvre un Phantom del Covenant nel cuore dell'azione e assicura un fitto fuoco di copertura grazie ai tre cannoni al plasma rotanti. Trasportando il micidiale Arbiter Élite e due Grunt Ultra sul campo di battaglia, il Phantom fa pendere la bilancia a favore dei nemici dell'UNSC.

### Phantom Covenant

Um Elite Pilot manobra um Phantom Covenant na ação e oferece fogo de proteção pesado de seus três canhões de plasma rotativos, ao mesmo tempo em que coloca no campo de batalha um Elite Arbiter mortal e dois Ultra Grunts, desequilibrando o jogo para seus inimigos UNSC.



## COVENANT INTEL

Collect them all! - ¡Colecciónalos todos! - Collectionne-les tous!  
 Hot sie dir alle! - Verzamel ze allemaal! - Collezionali tutti! - Colecione todos etes!

- 

Árbitro del Pacto  
 Arbitre Covenant  
 Covenant-Gebleter  
 Covenant Arbiter  
 Arbitro Covenant  
 Arbitro Covenant

**COVENANT ARBITER**
- 

Piloto Élite de Covenant  
 Pilote d'élite du Covenant  
 Covenant elite Pilot  
 Covenant-elite pilot  
 Pilota Covenant Elite  
 Piloto de Elite Covenant

**COVENANT ELITE PILOT**
- 

Ultra Grunt de Covenant  
 Grunt du Covenant Ultra  
 Ultra Bundeslandsar  
 Covenant Ultra-Grunt  
 Grunt Ultra Covenant  
 Grunt Ultra Covenant

**COVENANT ULTRA GRUNT**

