

# HALO

THE AUTHENTIC COLLECTOR'S SERIES



**96837**

Halo Battlescape • Campo de batalla Halo • Champ de bataille Halo • Halo-Kampfarena • Halo Slagveld • Battlescape di Halo • Battlescape Halo

**MEGA  
BLOKS**

The conflict continues on the Halo Battlescape as UNSC and Covenant forces engage on the war torn Halo terrain. Interconnect and tile multiple Battlescapes to expand your Halo Universe. Display your Halo builds using the deluxe display rods to create your ultimate battle scene!

El conflicto continúa en el campo de batalla Halo puesto que las fuerzas UNSC y Covenant luchan en el campo Halo arrasado. Interconecta y solapa varios campos de batalla para ampliar tu universo Halo. Muestra tus construcciones Halo utilizando las barras de visualización deluxe para recrear la de batalla definitiva.

Le conflit se poursuit sur le champ de bataille Halo alors que les forces Covenantes et de l'Alliance se lancent dans un territoire déchiré par la guerre. Interconnecte et assemble des champs de bataille multiples pour élargir ton univers Halo. Expose tes constructions Halo en utilisant l'étalage deluxe et crée une scène de combat ultime !

Der Konflikt auf dem Halo-Schlachtfeld besteht weiter, und die UNSC- und Covenant-Truppen greifen sich gegenseitig auf dem vom Krieg zerstörten Halo-Gelände an. Erweitere dein Halo-Universum durch die Verbindung und Anordnung mehrerer Battlescape-Schlachtfelder. Zeig deine Halo-Kreationen mit Hilfe der Deluxe-Display-Stangen, um deine ultimative Kampfszene aufzubauen!

Het conflict duurt voort op het HALO-slagveld waar de troepen van UNSC en Covenant zich op het door oorlog geteisterde Halo-terrein begeven. Breng jullie zelf in verbinding met elkaar en versla de tegenstander op het slagveld om uw Halo-universum uit te breiden. Toon uw Halo-constructies door middel van de luxueuze weer-gavestaven om zo het ultieme strijdtoneel te creëren!

Il conflitto continua sullo scenario Halo, poiché le forze UNSC e Covenant si attaccano sul terreno Halo, devastato dalla guerra. Puoi collegare e affiancare scenari di battaglia multipli per espandere il tuo Universo Halo. Visualizza le tue strutture Halo utilizzando le aste di visualizzazione deluxe per creare l'ultima scena della battaglia!

O conflito continua no campo de batalha Halo enquanto as forças UNSC e Covenant se atacam no terreno Halo dilacerado pela guerra. Interliga e monta múltiplos campos de batalha para expandir teu Universo Halo. Mostra tuas construções Halo ao utilizar a barra de exposição luxuosa para criar tua cena de batalha máxima!





**HALO**  
THE AUTHENTIC COLLECTOR'S SERIES

[halo.megabloks.com](http://halo.megabloks.com)  
[www.facebook.com/halomegabloks](https://www.facebook.com/halomegabloks)  
[twitter.com/megabrands](https://twitter.com/megabrands)



- 1X** AMO7223AJL
- 2X** AMO3328AJL
- 1X** AMI5258AJL
- 2X** AMO9393AJL
- 1X** AMO9393F
- 2X** AMO901BAJL
- 1X** AMO17065F
- 1X** AMI7064F
- 3X** AMO4429AJL
- 1X** AMI7067F
- 1X** AMI70025U

- 1X** AMOBI4AJL
- 2X** AMOBI4F
- 2X** AMI7000AJL
- 2X** AMI7001AJL
- 1X** AMOBI23F
- 1X** AS968370B
- 1X** AMI7116F
- 1X** AMO3772AJL
- 2X** AMO9493KM
- 2X** AMI7832KM

- 2X** AMI5605KM
- 2X** AMI5603KM
- 2X** AS060007
- 4X** AMI6998N
- 4X** AMI6997F
- 1X** AMO7475F
- 1X** AS9684905
- 1X** AMI7063AJL

- 1X** AMO9238AJW
- 1X** AMI7035MM
- 1X** AMI7622MM
- 1X** AMI5625W
- 1X** AMI5626W
- 1X** AMI7730ANW
- 1X** AS9683702

- 4X** AMI7870AJC
- 1X** AMI7037W
- 2X** AS9683704
- 1X** AL968371

**2X** AMO3773KM

**2X** AMO9493KM

**1X** AMOI480KM

Suspend and display other MEGA Bloks Halo vehicles using these parts. • Cuelga y muestra otros vehículos Halo MEGA Bloks utilizando estas piezas. • Suspend et expose d'autres véhicules Halo MEGA Bloks en utilisant ces pièces • Ergänze und erweitere deine MEGA Bloks Halo-Fahrzeugsammlung mit diesen Ersatzteilen • Hang als voorbeeld andere Halo-voertuigen van MEGA Bloks op die deze onderdelen gebruiken • Sospendi e visualizza gli altri veicoli MEGA Bloks Halo usando queste parti • Suspender e mostrar outros veículos Halo MEGA Bloks, utilizando estas peças.

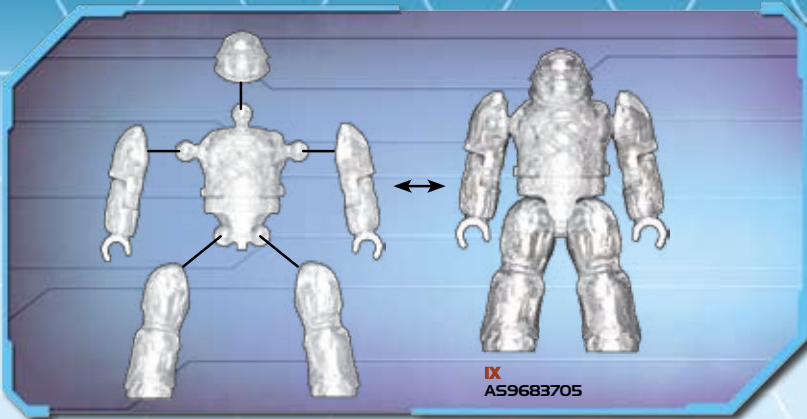

**IX**  
AS9683705

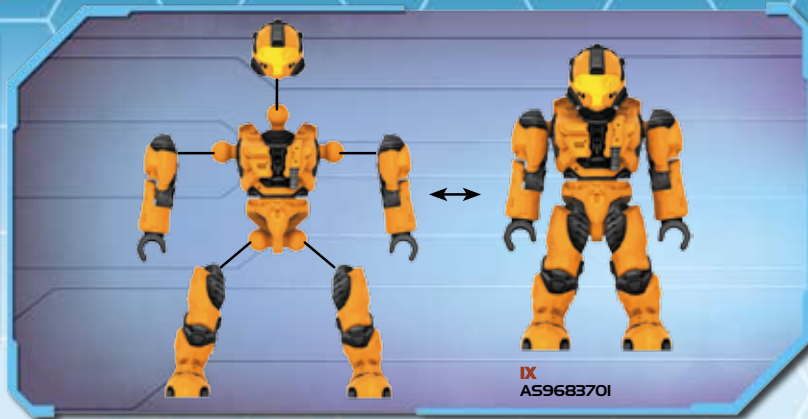

**IX**  
AS968370I

- EN** Please read these instructions carefully before first use and keep them for future reference.  
**ES** Leer estas instrucciones cuidadosamente antes de la primera utilización y guardarlas para referencia futura.  
**FR** Il est recommandé de lire attentivement ce feuillet avant la première utilisation et de le conserver pour référence future.  
**DE** Die Gebrauchsanleitung bitte durchlesen und aufbewahren.  
**NL** Wij raden u aan deze handleiding zorgvuldig te lezen en te bewaren voor eventuele raadpleging op een later tijdstip.  
**DA** Vær venlig at læse disse instruktioner omhyggeligt inden ibrugtagning og opbevar dem til fremtidigt brug.  
**EL** Διαβάστε αυτές τις οδηγίες προσεκτικά πριν χρησιμοποιήσετε το προϊόν για πρώτη φορά και φυλάξτε τις για μελλοντική αναφορά.  
**FI** Lue nämä ohjeet huolellisesti ennen ensimmäistä käyttöä ja säilytä ne myöhempää tarvetta varten.  
**IT** Leggere le istruzioni prima di cominciare ad usare il gioco e conservarle per referenze future.  
**NO** Les disse instruksjonene nøye før første gangs bruk, og ta vare på dem for fremtidige oppslag.  
**PT** Leia as instruções antes do primeiro uso e guarde-as para futura referência.  
**SV** Läs noggrant igenom dessa instruktioner innan du använder produkten för första gången och spara dem för ev. framtida frågor.  
**JA** 初めてご使用になる前に、この説明書をよくお読みください。また、本書は将来いつでも参照できるように保管してください。  
**ZH** 请在初次使用前仔细阅读这些指示，并保留它们以便未来参考。  
**AR** يرجى قراءة هذه التعليمات بدقة قبل البدء بالاستعمال والاحتفاظ بها كمرجع للمستقبل

**EN** ⚠ **WARNING :**  
**CHOKING HAZARD.** - Small parts.  
Not for children under 3 years.

**ES** ⚠ **ADVERTENCIA :**  
**PELIGRO DE ASFIXIA.** - Contiene piezas pequeñas.  
No recomendado para niños menores de 3 años.

**FR** ⚠ **Avertissement :**  
**RISQUE DE SUFFOCATION.** - Présence de petits éléments.  
Ne convient pas aux enfants de moins de 3 ans.

**DE** ⚠ **WARNUNG :**  
**ERSTICKUNGSGEFAHR.** - Enthält kleine Teile.  
Nicht für Kinder unter 3 Jahren geeignet.

**NL** ⚠ **WAARSCHUWING :**  
**VERSTIKKINGSGEVAAR.** - Bevat kleine onderdelen.  
Niet geschikt voor kinderen onder de 3 jaar.

**DA** ⚠ **ADVARSEL :**  
**KVÆLNINGSFARE.** - Indeholder smådele.  
Ikke til børn under 3 år.

**EL** ⚠ **ΠΡΟΕΙΔΟΠΟΙΗΣΗ :**  
**ΚΙΝΔΥΝΟΣ ΠΝΙΞΙΜΑΤΟΣ.** - Περιέχει μικρά αντικείμενα  
Όχι για παιδιά κάτω των 3 ετών.

**FI** ⚠ **VAROITUS :**  
**TUKEHTUMISVAARA.** - Sisältää pieniä osia.  
Ei alle 3-vuotiaille lapsille.

**IT** ⚠ **ATTENZIONE :**  
**PERICOLO DI SOFFOCAMENTO.** - Contiene piccole parti.  
Non indicato per bambini sotto i 3 anni.

**NO** ⚠ **ADVARSEL :**  
**KVELNINGSFARE.** - Inneholder små deler.  
Kun for barn over 3 år.

**PT** ⚠ **ATENÇÃO :**  
**PERIGO DE ASFIXIA.** - Contém peças pequenas.  
Não é concebido para crianças de menos de 3 anos.

**SV** ⚠ **WARNING :**  
**KVÄVNINGSRISK.** - Innehåller små delar.  
Inte för barn under 3 år.

**JA** ⚠ **警告 :**  
窒息の危険性 - 小さな部品が含まれています  
3歳以下の子供には与えないで下さい。

**ZH** ⚠ **警告 :**  
有窒息危险。- 包含有小部件  
不适合3岁以下的小孩玩。

**AR** ⚠ **تحذير :**  
خطر اختناق - قطع صغيرة.  
غير صالحة للأطفال أقل من 3 سنوات.



© 2010 MICROSOFT CORPORATION. ALL RIGHTS RESERVED. MICROSOFT, 343 INDUSTRIES, THE 343 INDUSTRIES LOGO, HALO, THE HALO LOGO, XBOX, XBOX 360, AND THE XBOX LOGOS, ARE TRADEMARKS OF THE MICROSOFT GROUP OF COMPANIES.

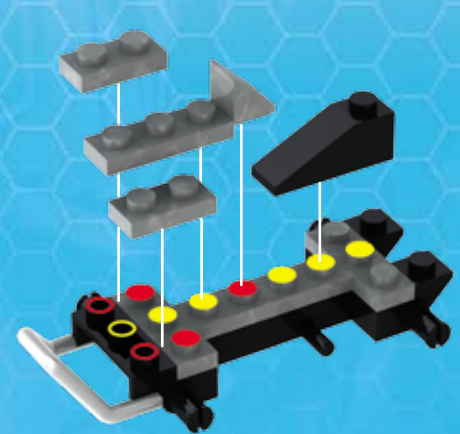
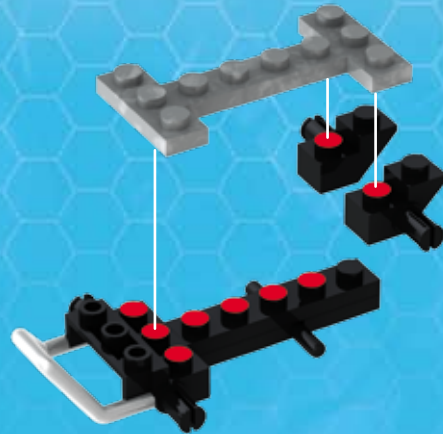
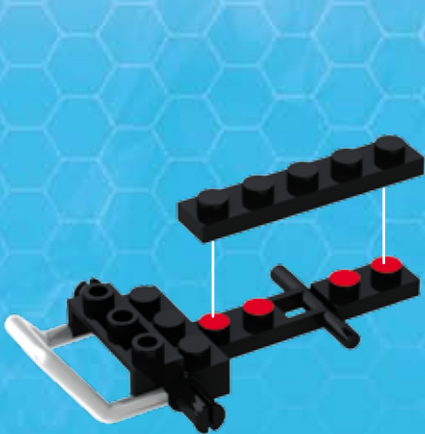
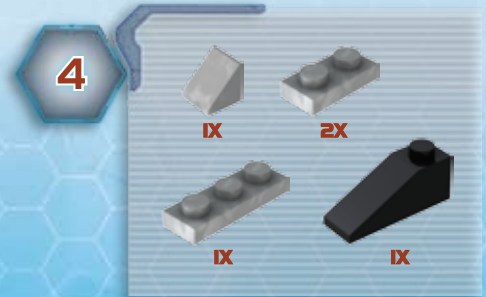
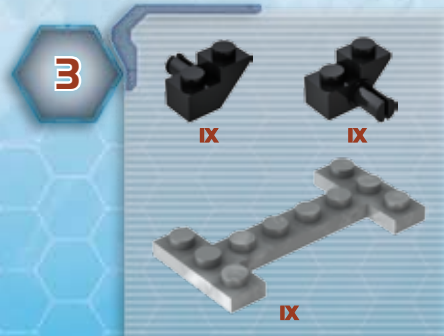
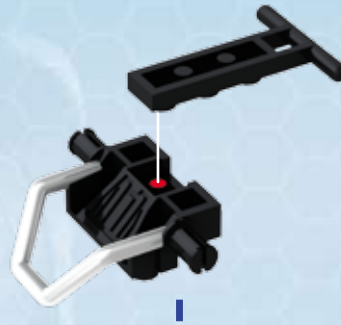

5

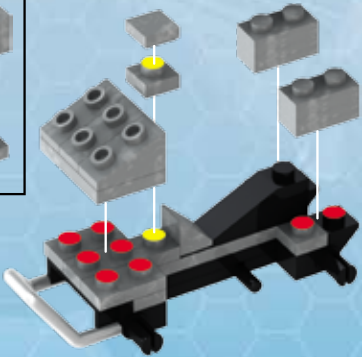
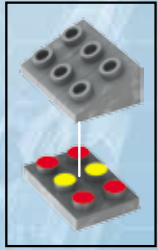
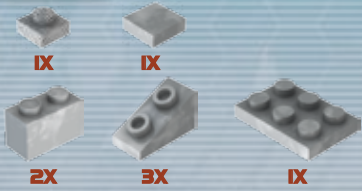

6

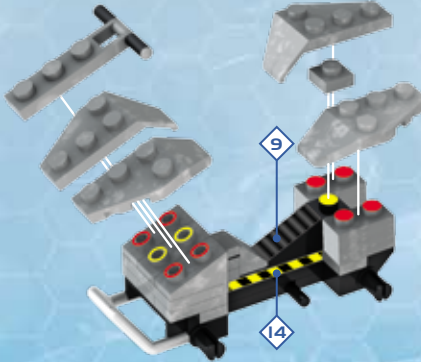
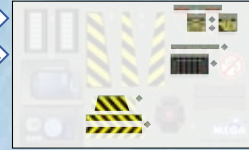
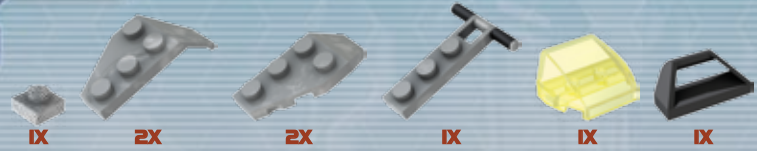

1

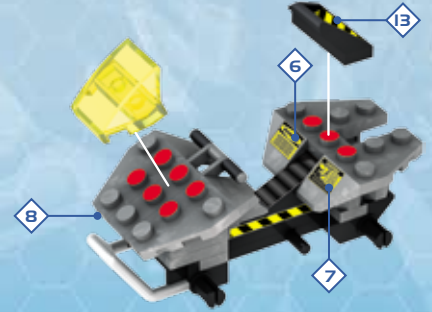

2

7

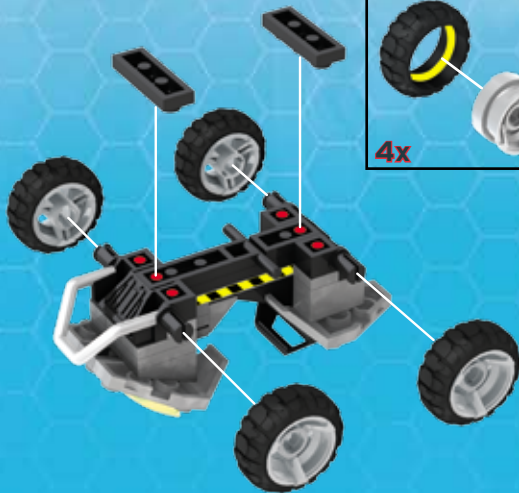

1



2



3

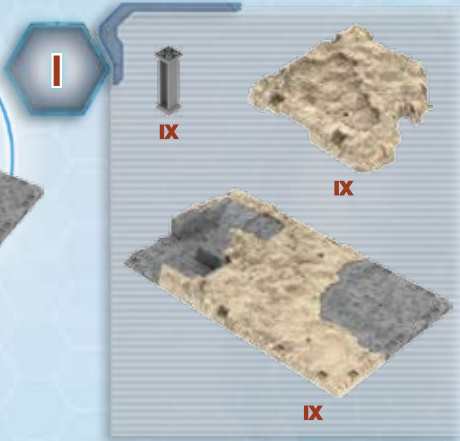
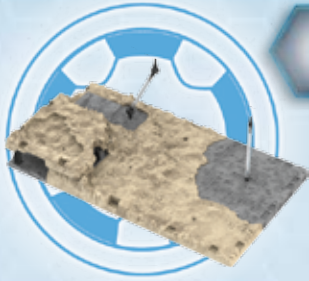

- 1
- 1
- 2
- 3
- 4
- 10
- 11
- 12
- 15

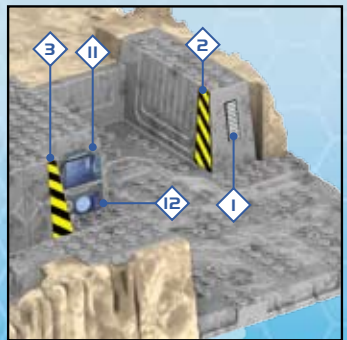



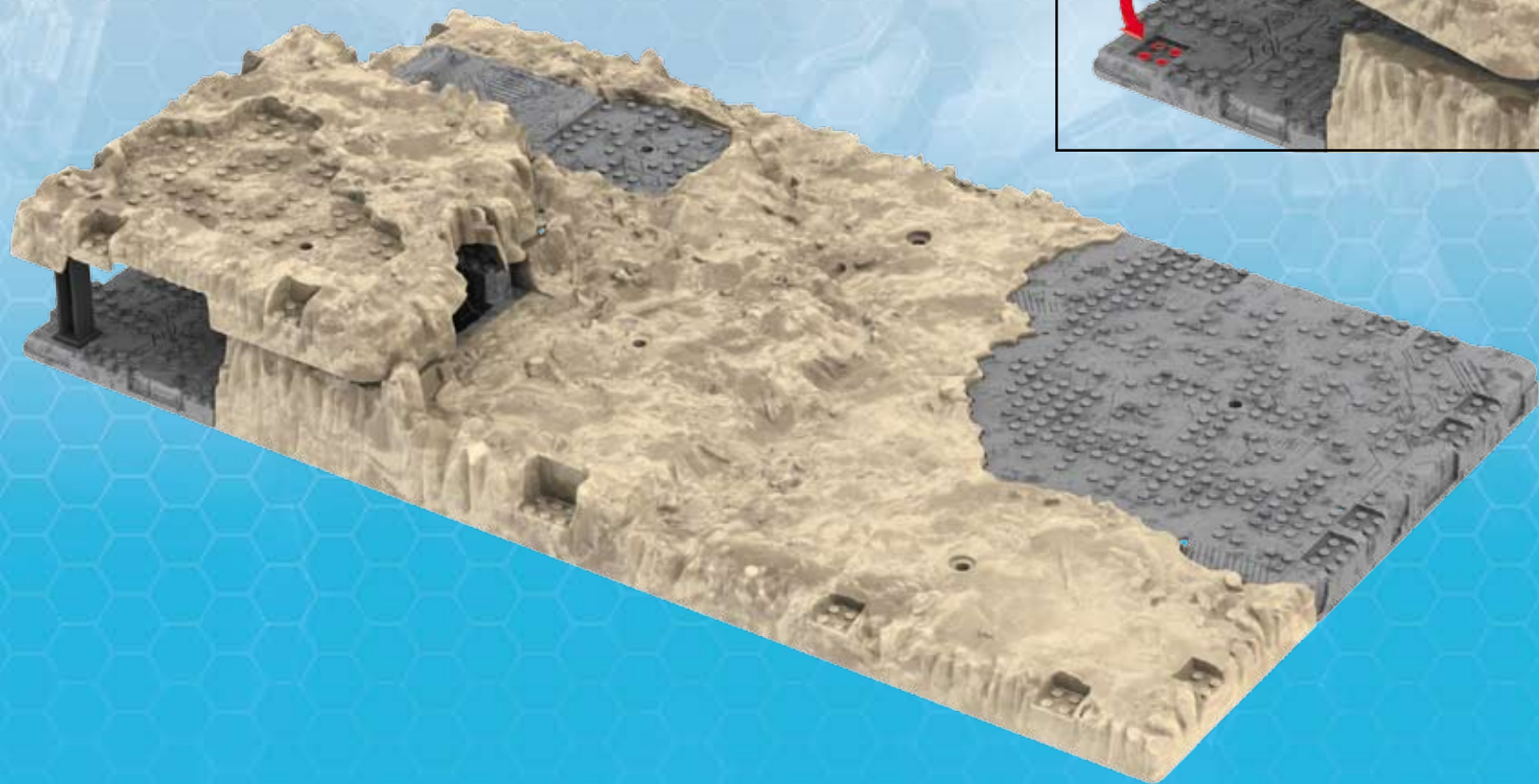

3



2X



2X



2X



1X



1X



4

IX

IX



\*Additional purchases required to collect all elements shown. • Para coleccionar todos los elementos mostrados se precisa realizar unas compras adicionales. • Des achats additionnels sont nécessaires afin d'obtenir tous les articles de la collection illustrés. • Um alle dargestellten Elemente zu sammeln sind zusätzliche Käufe erforderlich. • Verdere aankopen zijn nodig om alle afgebeelde artikelen te verzamelen. • Acquisti supplementari necessari per collezionare tutti gli elementi illustrati. • Compras adicionais são necessárias para coleccionar todos os elementos exibidos.

Banshee not included    Banshee nicht enthalten  
 Banshee no incluido    Banshee niet inbegrepen  
 Banshee non compris    Banshee não incluso  
 Banshee não incluso

Alternative Build • Otro ensamblaje • Autre construction • Alternative Bau-Möglichkeit  
Alternatieve bouw • Costruzione alternativa • Construcção alternativa

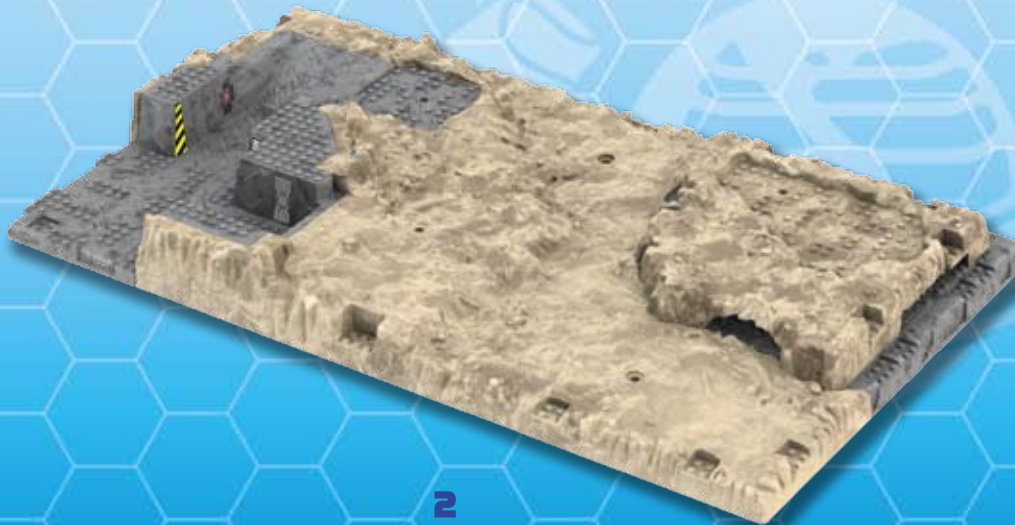
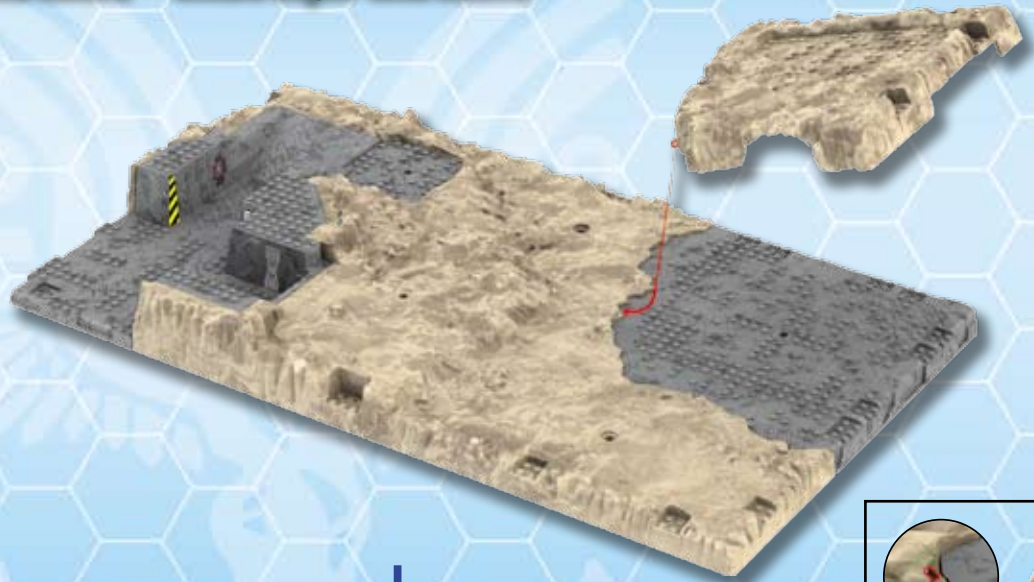

Alternative Build • Otro ensamblaje • Autre construction • Alternative Bau-Möglichkeit  
Alternatieve bouw • Costruzione alternativa • Construcção alternativa

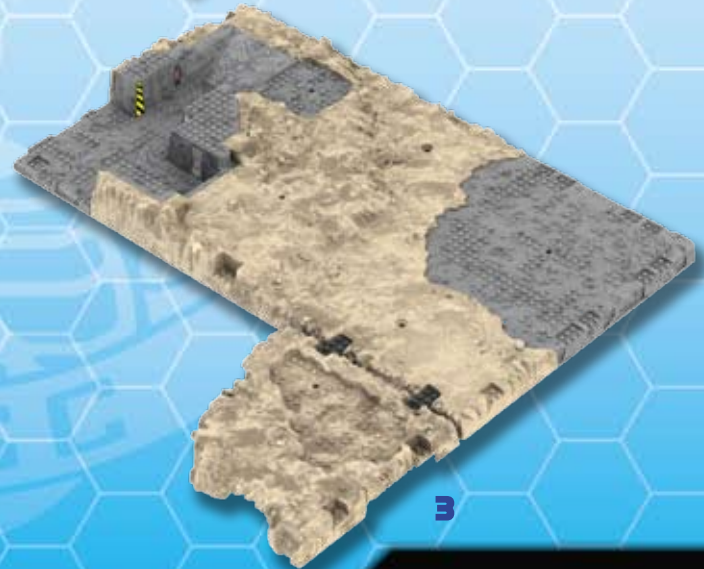
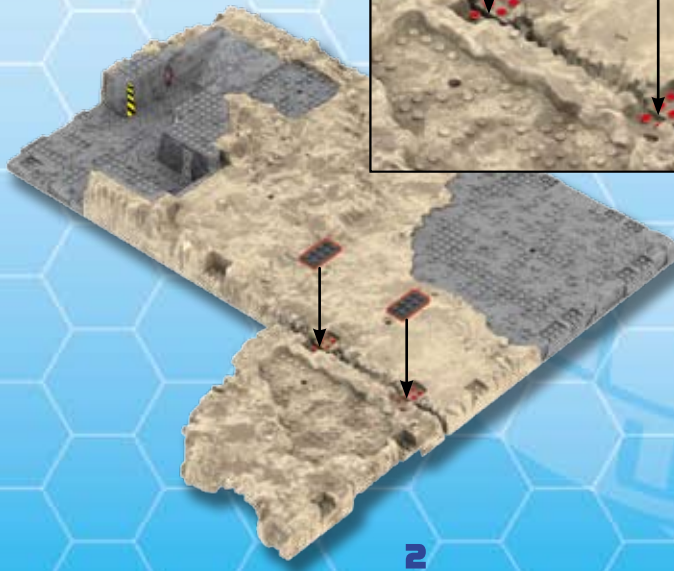
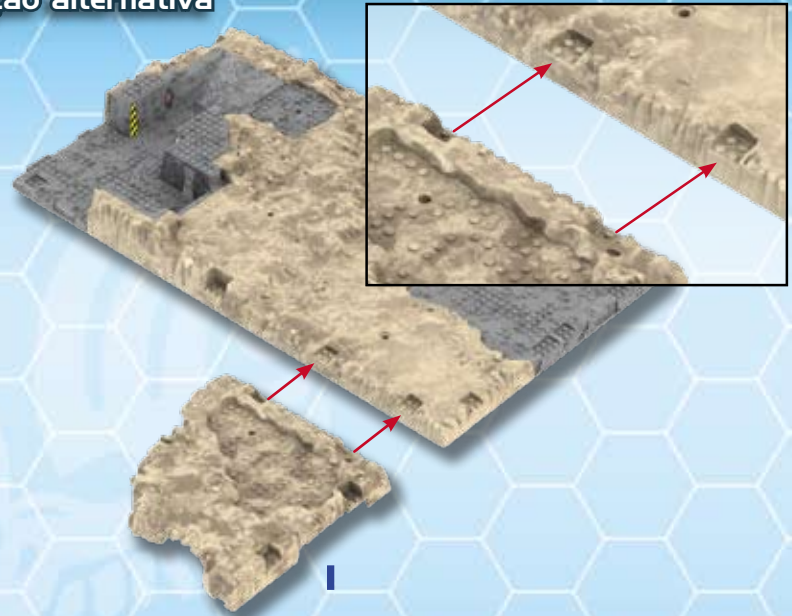
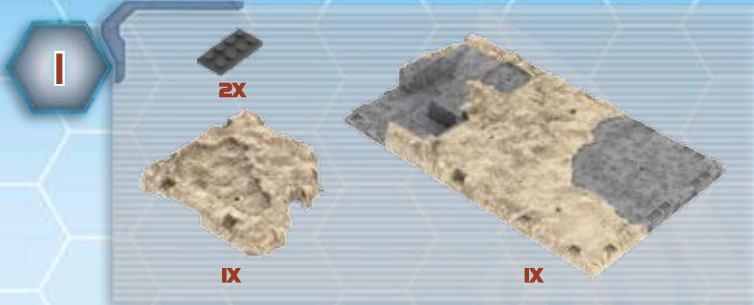

**Connect and expand!**

**Conecta y amplía!**

**Assembler et agrandir!**

**Verbindungen knüpfen und erweitern!**

**Verbinden en groter maken!**

**Collegare e ampliare!**

**Conecte e expanda!**

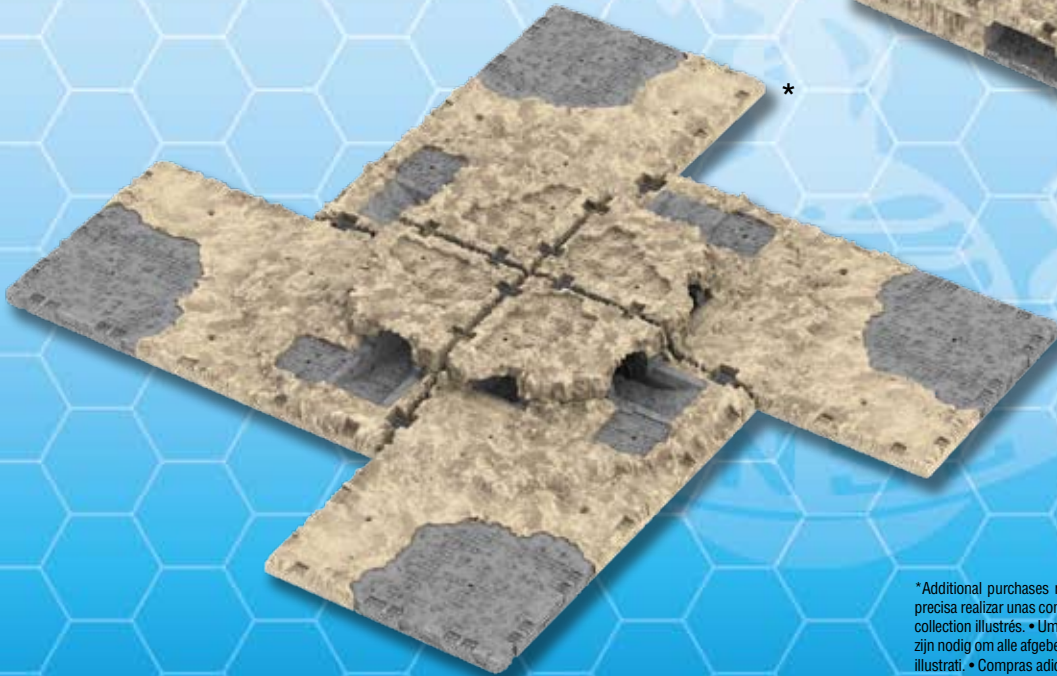
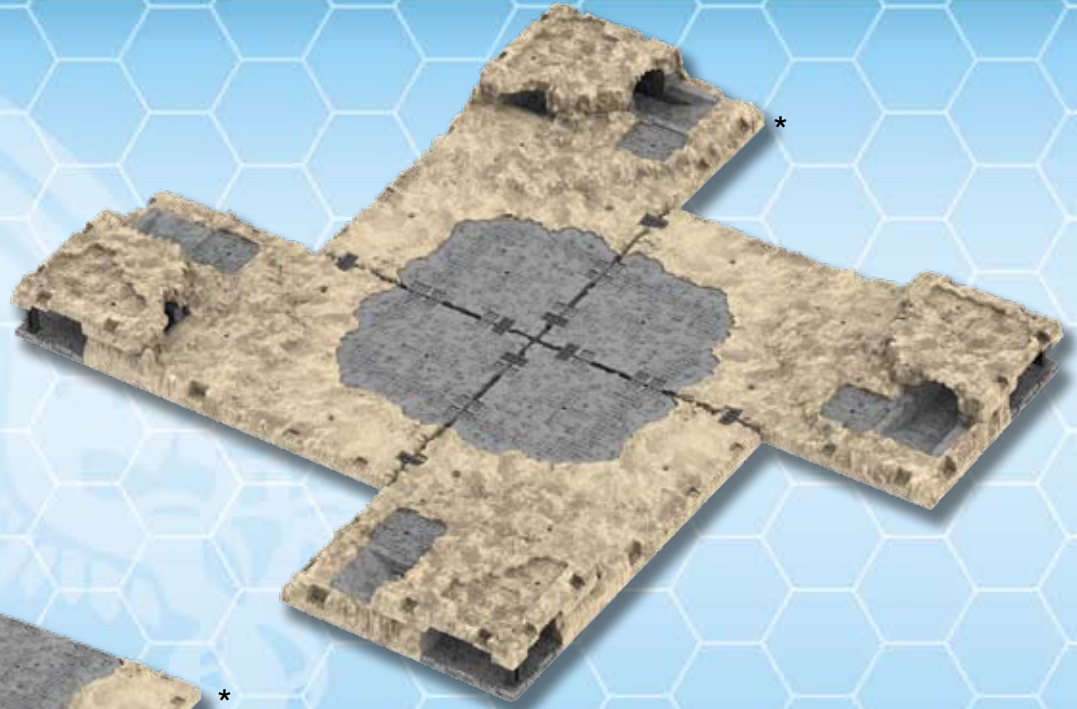

\*Additional purchases required to collect all elements shown. • Para coleccionar todos los elementos mostrados se precisa realizar unas compras adicionales. • Des achats additionnels sont nécessaires afin d'obtenir tous les articles de la collection illustrés. • Um alle dargestellten Elemente zu sammeln sind zusätzliche Käufe erforderlich. • Verdere aankopen zijn nodig om alle afgebeelde artikelen te verzamelen. • Acquisti supplementari necessari per collezionare tutti gli elementi illustrati. • Compras adicionais são necessárias para coleccionar todos os elementos exibidos.

Banshee not included  
Banshee no incluido  
Banshee non compris

Banshee nicht enthalten  
Banshee niet inbegrepen  
Banshee non incluso  
Banshee não incluido

23'  
(0.58m)

13.5'  
(0.34m)

Halo Battlescape • Campo de batalla Halo  
Champ de bataille Halo • Halo-Kampfarena • Halo Slagveld  
Battlescape di Halo • Battlescape Halo

# HALO

THE AUTHENTIC COLLECTOR'S SERIES

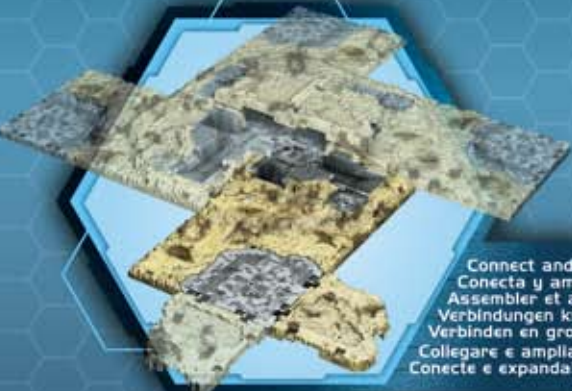

Connect and expand!  
 Conecta y amplial  
 Assemble et agrandirl  
 Verbindungen knüpfen und erweitern!  
 Verbinden en groter maken!  
 Collegare e ampliare!  
 Conecte e expandal



Covenant Grunt  
 Grunt du Covenant  
 Alianz-Grunts  
 Verdragsinfanterist  
 Grunt dl Covenant  
 Grunt dl Covenant



CQB Spartan  
 Armadura CQB de los Spartan  
 Armure CQB des Spartans  
 Nahkampf-Spartaner-Rüstung  
 CQB Spartaan  
 Spartan in combattimento a corpo a corpo  
 Spartan CQB



Covenant Brute  
 Covenant Brute  
 Brute Covenant  
 Covenant Brute  
 Bruto da Covenant



© 2010, MEGA Brands Inc.  
 © and ™ denote trademarks of  
 MEGA Brands Inc.  
 Printed in China AD968371

Collect them all! - ¡Colecciónalos todos! - Collectionne-les tous!  
 Hol sie dir alle! - Verzamel ze allemaal  
 Collezionali tutti! - Colezione todos eles!