

**MEGA
BLOKS**

**SKYLANDERS
GIANTS**



2 IN 1

BUILD AND REBUILD
CONSTRUYE Y RECONSTRUYE
CONSTRUIS ET RECONSTRUIS



95442

Crusher's Pirate Quest • Misión pirata de Crusher • Conquête Pirate de Crusher
Crushers Piratensuche • Crushers piratenzoektocht • La missione piratesca di Crusher • Missão pirata do Crusher

2x MA03328DH
15x M1113ARG
1x MA1113NS
1x M07223ARG
3x AM17062APG
6x MA1086BLG
4x MA1086DH
1x AS954424
1x AM18623NS
1x M17506ARG
4x AM18597NS
13x MA09393DH
4x M022501ARG
1x AM03103ZD
2x AM18014DH
2x MA09013DH
6x MA09013BLG

4x M09013ARG
1x AS95400505
2x M1322ARG
2x M1417ARG
2x AM19660APG
2x MA11101DH
1x AM02799DH
1x AM15773BOR
1x AM73296ARG
4x MA15484DH
6x MA03773DH
13x MA0948NS
1x MA1146KM
1x AM01495MY
1x AM01495KM

6x AM03329ARG
40x MA09023DH
4x M09023ARG
1x AM10931MY
2x AM18715BLG
4x AM19132ACW
2x AM16975ARG
2x AM16954ARG
2x M1139ARG
8x MA1087BLG
6x MA1087DH
6x M1087ARG
5x MA09493DH
12x MA09033F

7x MA09033DH
2x AM19131BLG
1x AS954425
1x AS9544211
9x MA09593DH
2x MA07475DH
1x AM04755MY
1x AM04756MY
1x AM02637NS
1x AM16331ARG
1x AM73297APG

1x AS9544213
3x MA09292DH
1x MA1313DH
2x MA1313BLG
1x AM02676ARG
2x MA1321BLG
3x MA1480DH
1x AM72860ARG
1x AM04983F
2x AM04983DH

6x AM03767DH
2x AM18284ARG
9x AM09922ARG
3x MA10233DH
1x MA10233BLG
1x AM04339NS
1x AS954439
1x AM01895NS
1x AM04984F
2x AM04984DH

1x AM04338NS
1x AM73295APG
1x AS9544215
1x AS954429
1x AM72347DH
1x AS954433
1x AS9544210
2x AM04985DH
2x AM02237ACW



1x
AM72346DH

1x
AM04850DH



1x
AM72345DH



1x
AS9544214



3x
AM18567ACW



1x
AS9544216



1x
AS954428



4x
MA1172ACW



1x
AM18611F



1x
AX9544201



1x
AS95400509



1x
AS95400203



1x
AS95400302



1x
AS95400114



1x
AS95400403



1x
AS95400402

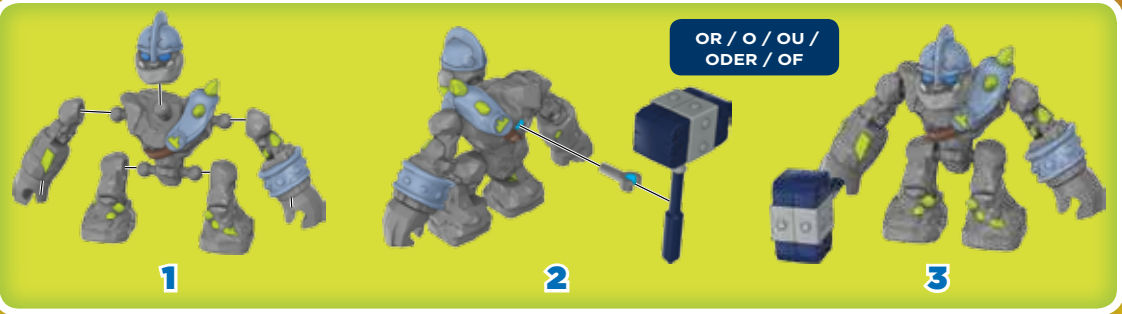

1

2

3

OR / O / OU /
ODER / OF



1

2

3

OR / O / OU /
ODER / OF



1

2

⚠️ **WARNING :**
CHOKING HAZARD. - Small parts.
Toy contains a small ball.
Not for children under 3 years.

⚠️ **ATTENTION :**
DANGER D'ÉTOUFFEMENT. - Présence de petits éléments.
Le jouet contient une petite balle.
Ne convient pas aux enfants de moins de 3 ans.

⚠️ **ADVERTENCIA :**
RIESGO DE ASFIXIA. - Contiene piezas pequeñas.
El juguete contiene una bola pequeña.
No recomendado para niños menores de 3 años.

⚠️ **ACHTUNG :**
ERSTICKUNGSGEFAHR. - Enthält kleine Teile.
Ein kleiner Ball ist im Spielzeug inbegriffen.
Nicht für Kinder unter 3 Jahren geeignet.

⚠️ **WAARSCHUWING :**
VERSTIKKINGSGEVAAR. - Bevat kleine onderdelen.
Speelgoed bevat een klein balletje.
Niet geschikt voor kinderen onder de 3 jaar.

⚠️ **AVVERTENZA :**
PERICOLO DI SOFFOCAMENTO. - Contiene piccole parti.
Il giocattolo comprende una pallina.
Non indicato per bambini sotto i 3 anni.

⚠️ **ATENÇÃO :**
PERIGO DE ASFIXIA. - Contém peças pequenas.
O brinquedo contém uma pequena bola.
Não é concebido para crianças de menos de 3 anos.

⚠️ **OSTRZEŻENIE :**
ZAGROŻENIE ZADŁAWIENIEM. - Małe elementy.
Zabawka zawiera element w kształcie małej kulki.
Nie nadaje się dla dzieci poniżej 3 lat.

⚠️ **ADVARSEL :**
FARE FOR KVÆLNING. - Inneholder smådele.
Legetøyet inneholder en liten ball.
Ikke til barn under 3 år.

⚠️ **ΠΡΟΕΙΔΟΠΟΙΗΣΗ :**
ΚΙΝΔΥΝΟΣ ΠΝΙΓΜΟΥ. - Περιέχει μικρά αντικείμενα.
Το παιχνίδι περιέχει ένα μπαλάκι.
Όχι για παιδιά κάτω των 3 ετών.

⚠️ **VAROITUS :**
TUKEHTUMISVAARA. - Sisältää pieniä osia.
Leluun sisältyy pieni pallo.
Ei alle 3-vuotiaille lapsille.

⚠️ **ADVARSEL :**
KVÆLNINGSFARE. - Inneholder små deler.
Leketøyene inneholder en liten ball.
Kun for barn over 3 år.

⚠️ **WARNING :**
KVÄVNINGSRISIK. - Innehåller små delar.
Leksaken innehåller en liten boll.
Inte för barn under 3 år.

⚠️ **警告 :**
のどにつまる危険。小さな部品が含まれています。
小さな玉が含まれています。
3歳以下の子供には与えないで下さい。

⚠️ **警告 :**
嚥住危険。包含有小部件。
此玩具含有一个球。
不适合3岁以下的小孩玩。

⚠️ **تحذير :**
الخطر الاختناق - قطع صغيرة.
تحتوي اللعبة على كرة صغيرة.
غير صالحة للأطفال أقل من 3 سنوات.

ⓘ Please read these instructions carefully before first use and keep them for future reference.

ⓘ Il est recommandé de lire attentivement ce feuillet avant la première utilisation et de le conserver pour référence future.

ⓘ Leer estas instrucciones cuidadosamente antes de la primera utilización y guardarlas para referencia futura.

ⓘ Die Gebrauchsanleitung bitte durchlesen und aufbewahren.

ⓘ Wij raden u aan deze handleiding zorgvuldig te lezen en te bewaren voor eventuele raadpleging op een later tijdstip.

ⓘ Leggere le istruzioni prima di cominciare ad usare il gioco e conservarle per referenze future.

ⓘ Leia as instruções antes do primeiro uso e guarde-as para futura referência.

ⓘ Proszę uważnie przeczytać instrukcję obsługi przed pierwszym użyciem, a następnie zachować ją na przyszłość.

ⓘ Vær venlig at læse disse instruktioner omhyggeligt inden ibrugtagning og opbevar dem til fremtidigt brug.

ⓘ Διαβάστε αυτές τις οδηγίες προσεκτικά πριν χρησιμοποιήσετε το προϊόν για πρώτη φορά και φυλάξτε τις για μελλοντική αναφορά.

ⓘ Lue nämä ohjeet huolellisesti ennen ensimmäistä käyttöä ja säilytä ne myöhempää tarvetta varten.

ⓘ Les disse instruksjonene nøye før første gangs bruk, og ta vare på dem for fremtidige oppslag.

ⓘ Läs noggrant igenom dessa instruktioner innan du använder produkten för första gången och spara dem för ev. framtida frågor.

ⓘ 初めてご使用になる前に、この説明書をよくお読みください。また、本書は将来いつでも参照できるように保管してください。

ⓘ 请在初次使用前仔细阅读这些指示，并保留它们以便未来参考。

ⓘ يرجى قراءة هذه التعليمات بدقة قبل البدء بالاستعمال والاحتفاظ بها كمرجع للمستقبل.

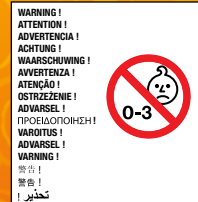

WARNING !
ATTENTION !
ADVERTENCIA !
ACHTUNG !
WAARSCHUWING !
AVVERTENZA !
ATENÇÃO !
OSTRZEŻENIE !
ADVARSEL !
ΠΡΟΕΙΔΟΠΟΙΗΣΗ !
VAROITUS !
VARNING !
تحذير !

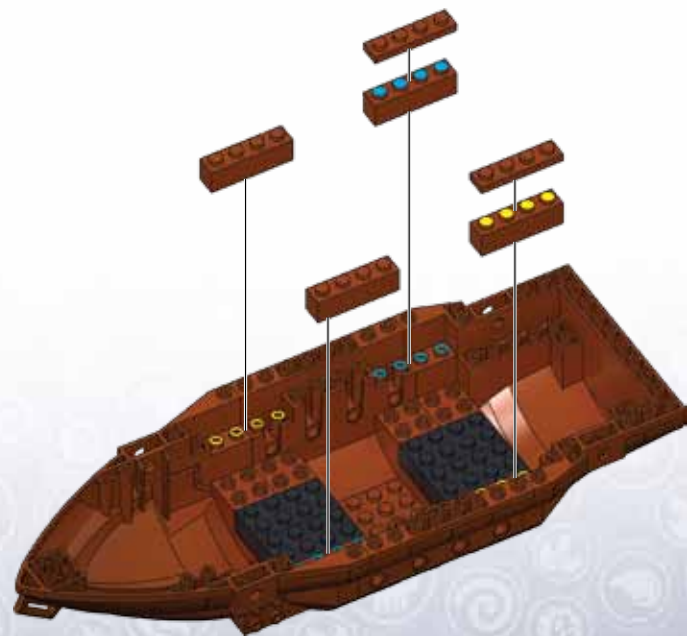
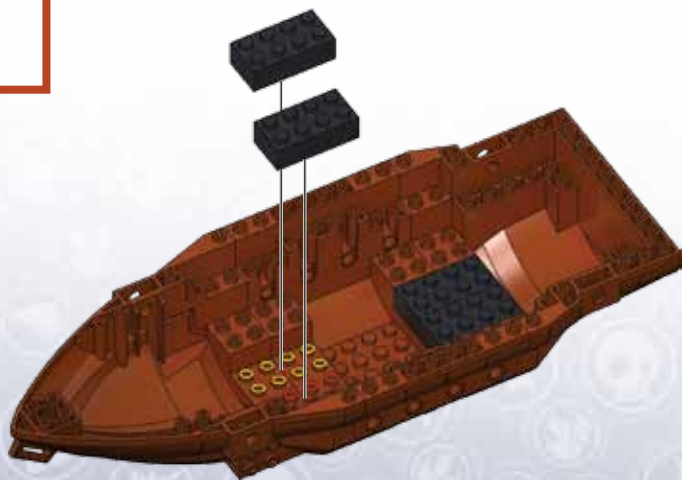
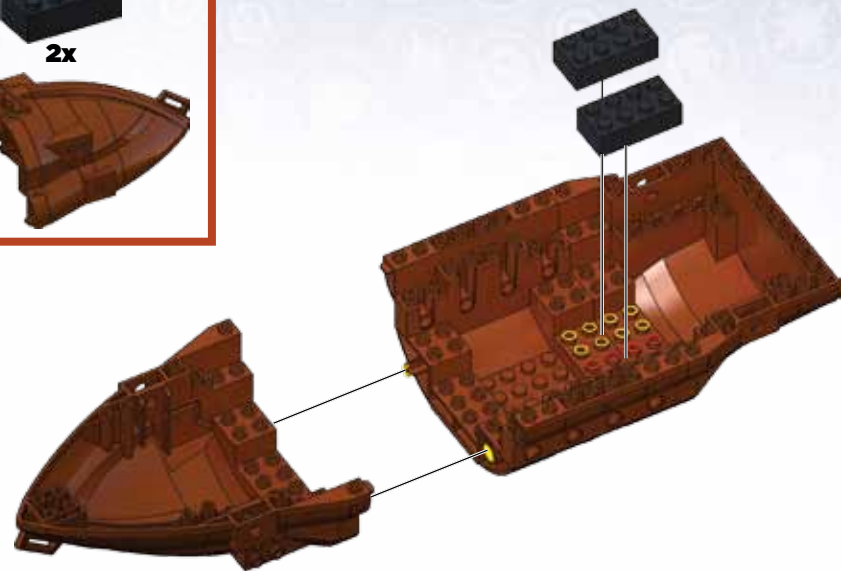
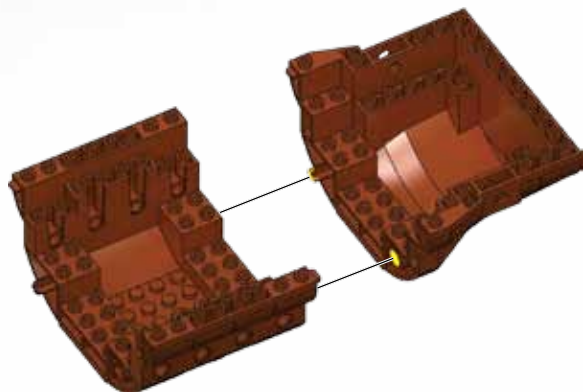

5

- 1x [1x 1-hole brown Technic brick]
- 2x [2x 1-hole brown Technic brick]
- 2x [2x 2-hole brown Technic brick]
- 1x [1x 3-hole brown Technic brick]
- 1x [1x 5-hole brown Technic brick]

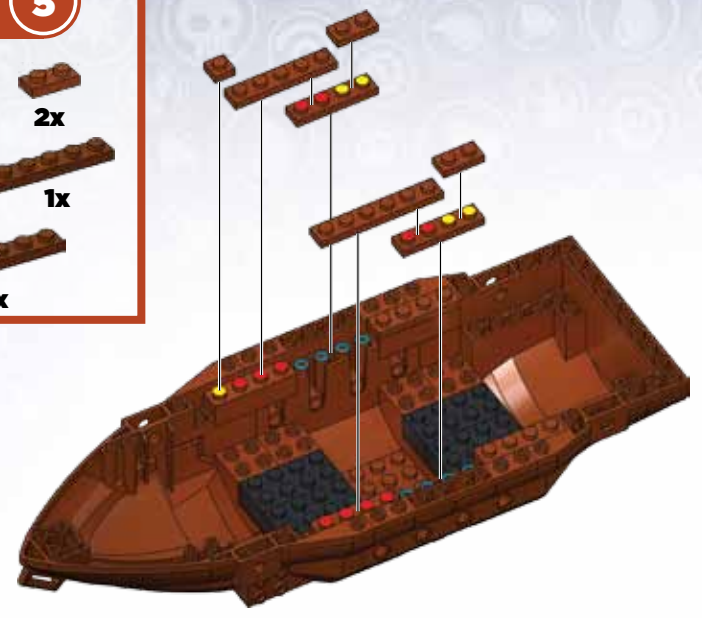

6

- 1x [1x 3-hole black Technic brick]
- 1x [1x 5-hole brown Technic brick]
- 1x [1x 5-hole blue Technic brick]
- 2x [2x 5-hole blue Technic brick]
- 1x [1x 10-hole black Technic brick]



7

- 3x [3x 1-hole brown Technic brick]
- 2x [2x 2-hole brown Technic brick]
- 3x [3x 3-hole black Technic brick]
- 1x [1x 5-hole brown Technic brick]
- 1x [1x 10-hole black Technic brick]

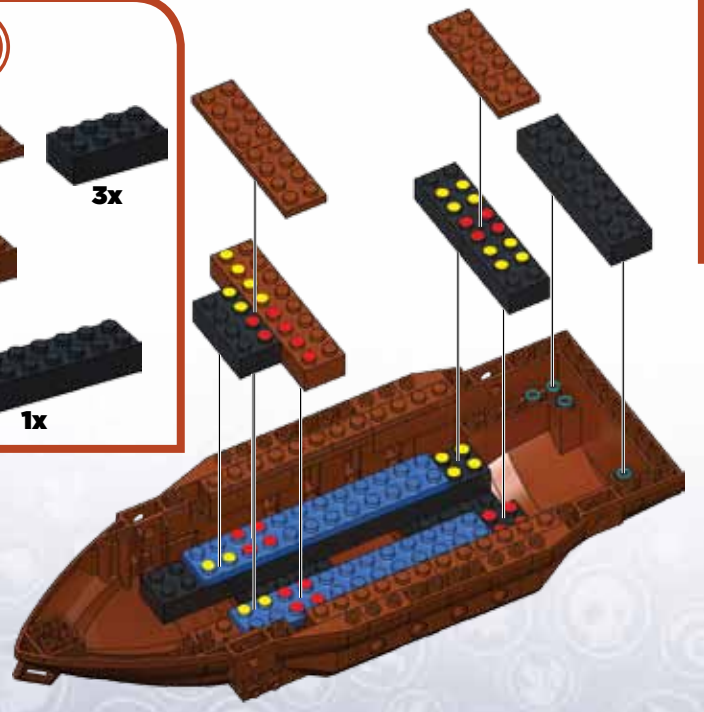

8

- 1x [1x 10-hole blue Technic brick]

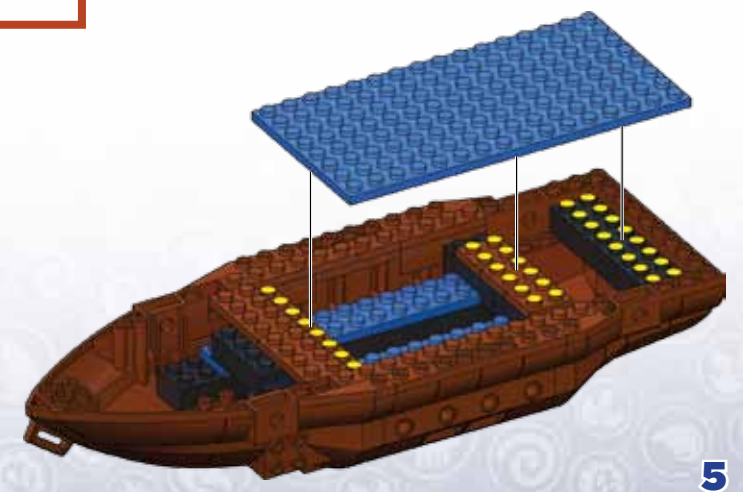

9



2x



6x



2x

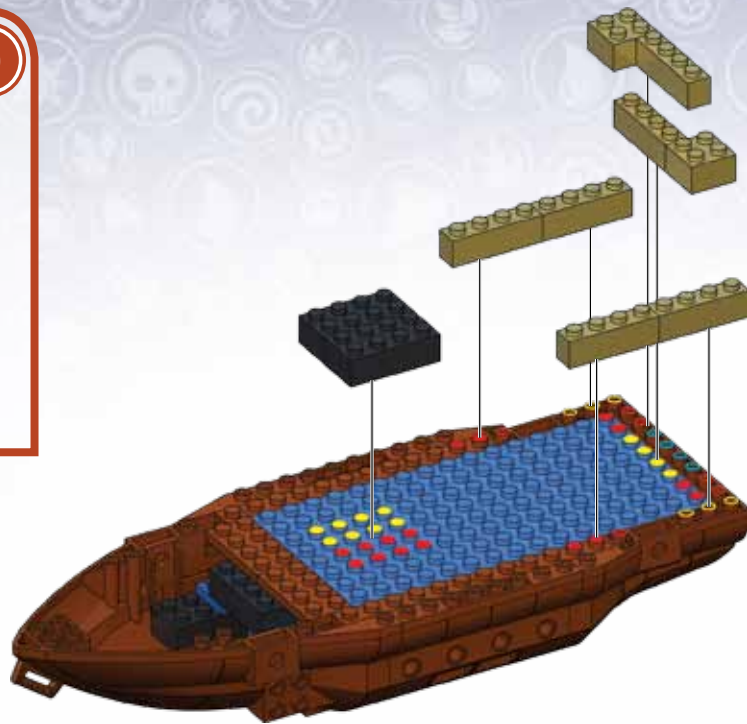

10



1x



1x



2x



11



2x



1x



1x

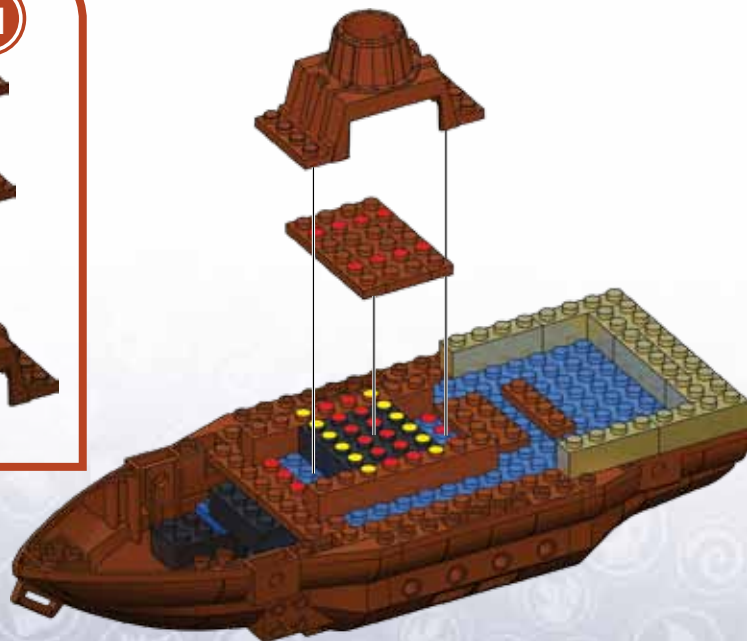

12



2x



2x



2x



1x

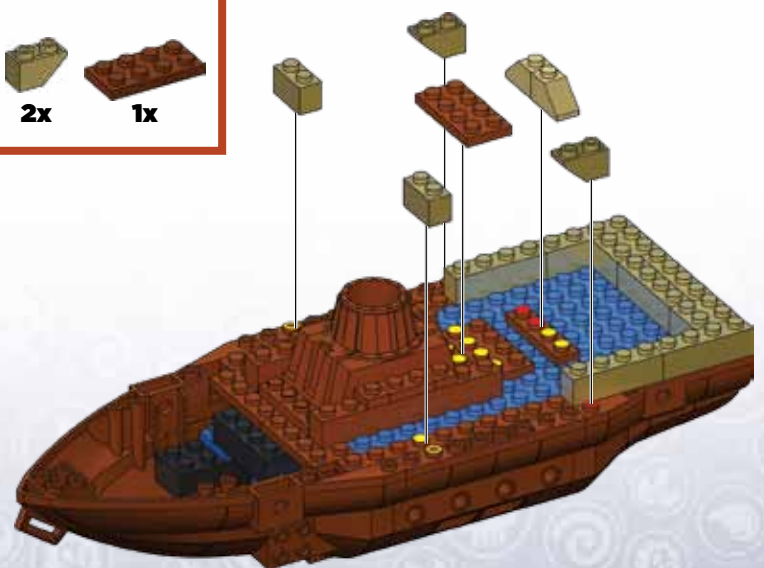

13

- 2x
- 2x
- 2x

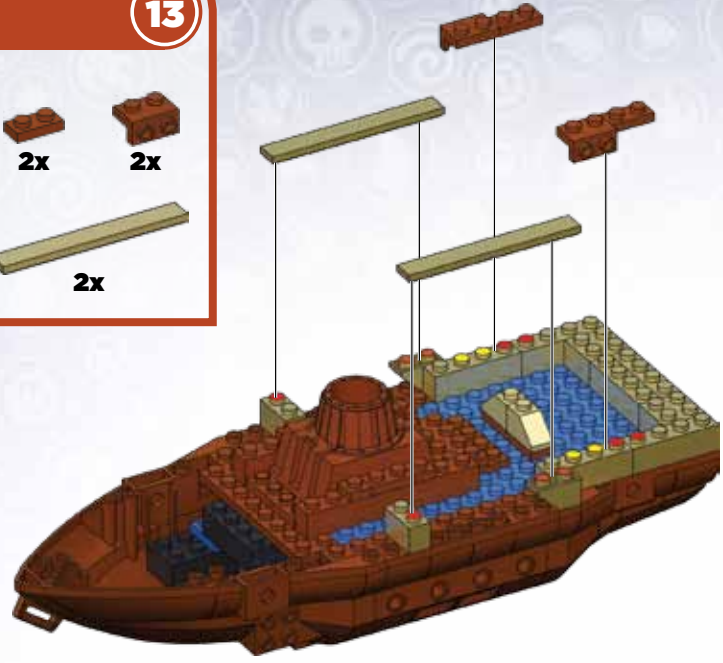

14

- 2x
- 2x
- 2x

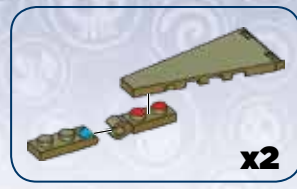

x2

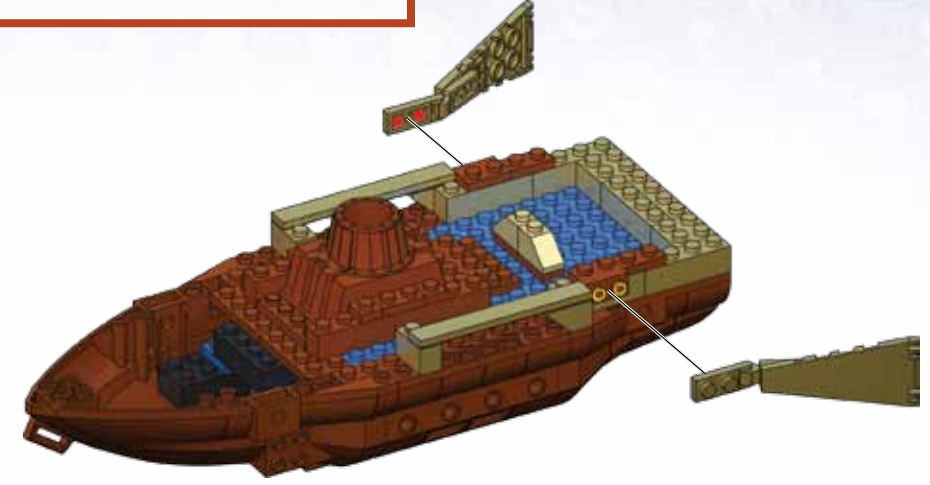

15

- 2x
- 1x

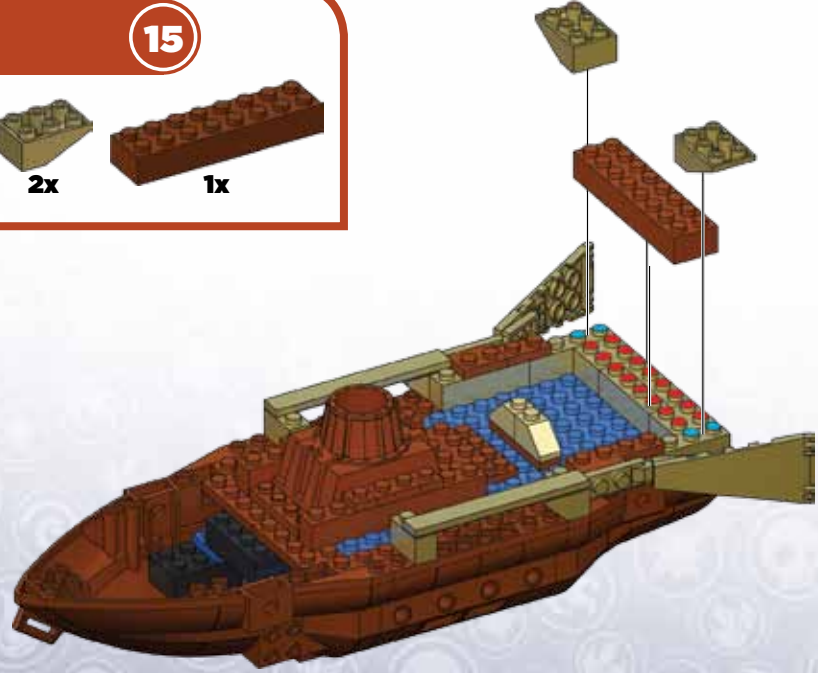

16

- 2x
- 1x
- 2x

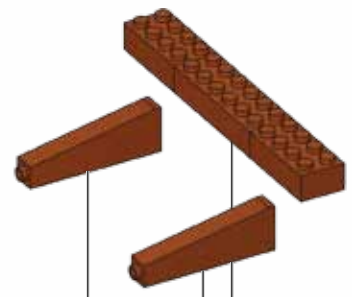

17

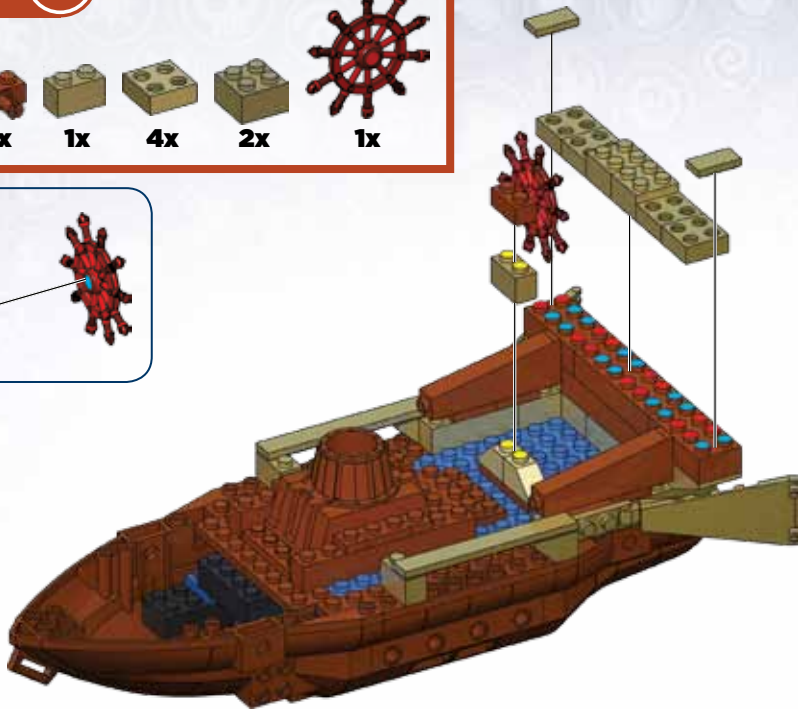
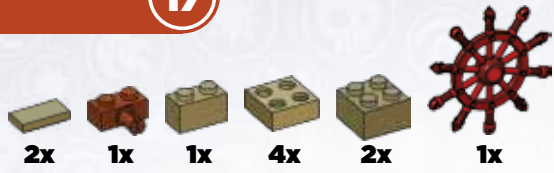

18

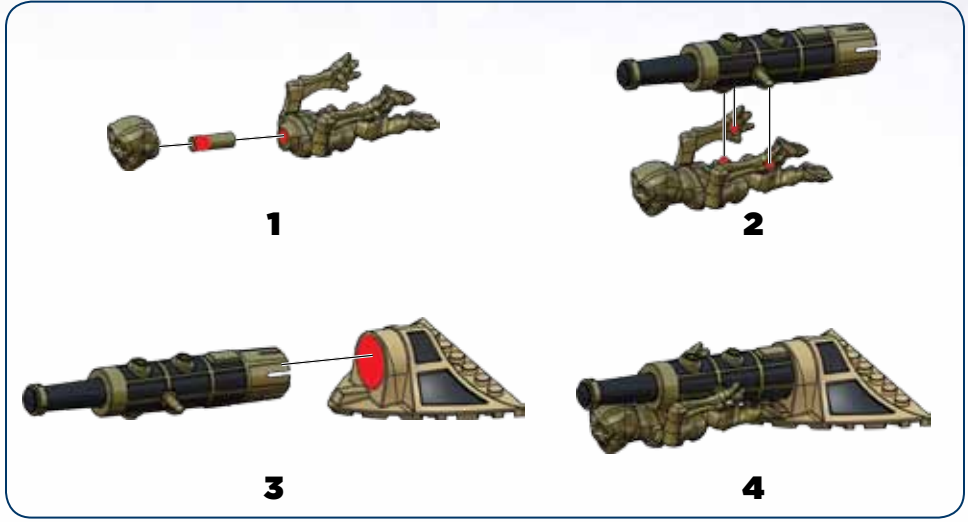

19

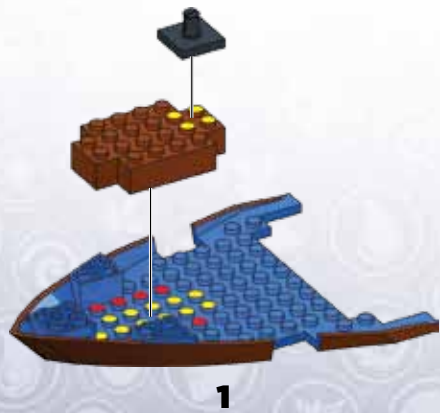
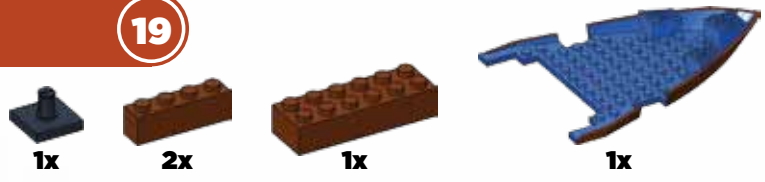

20

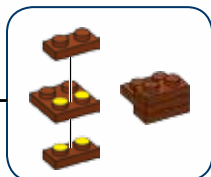

21



22



4x



1x

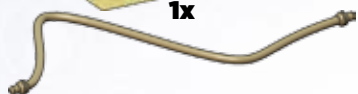

1x



1x



1x

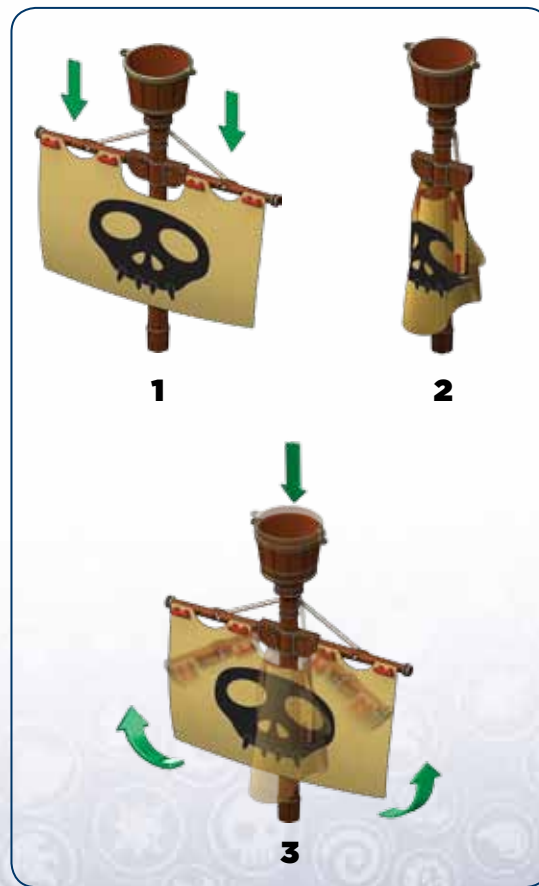
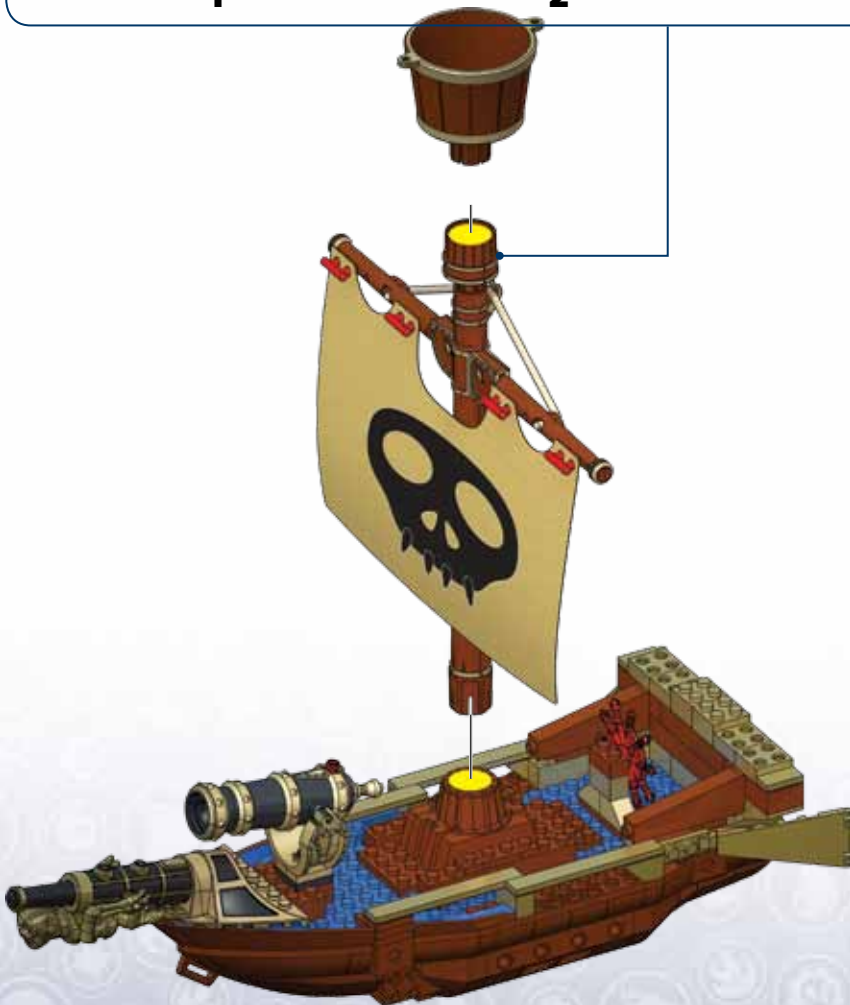
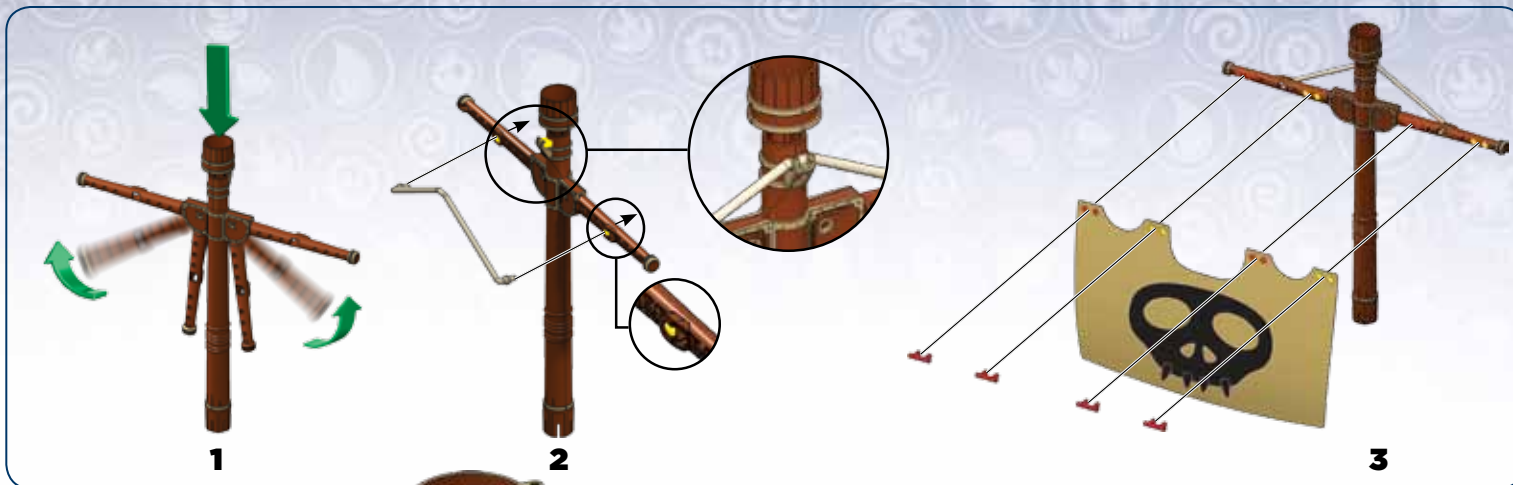

23



1x



1x



1x



24



1x

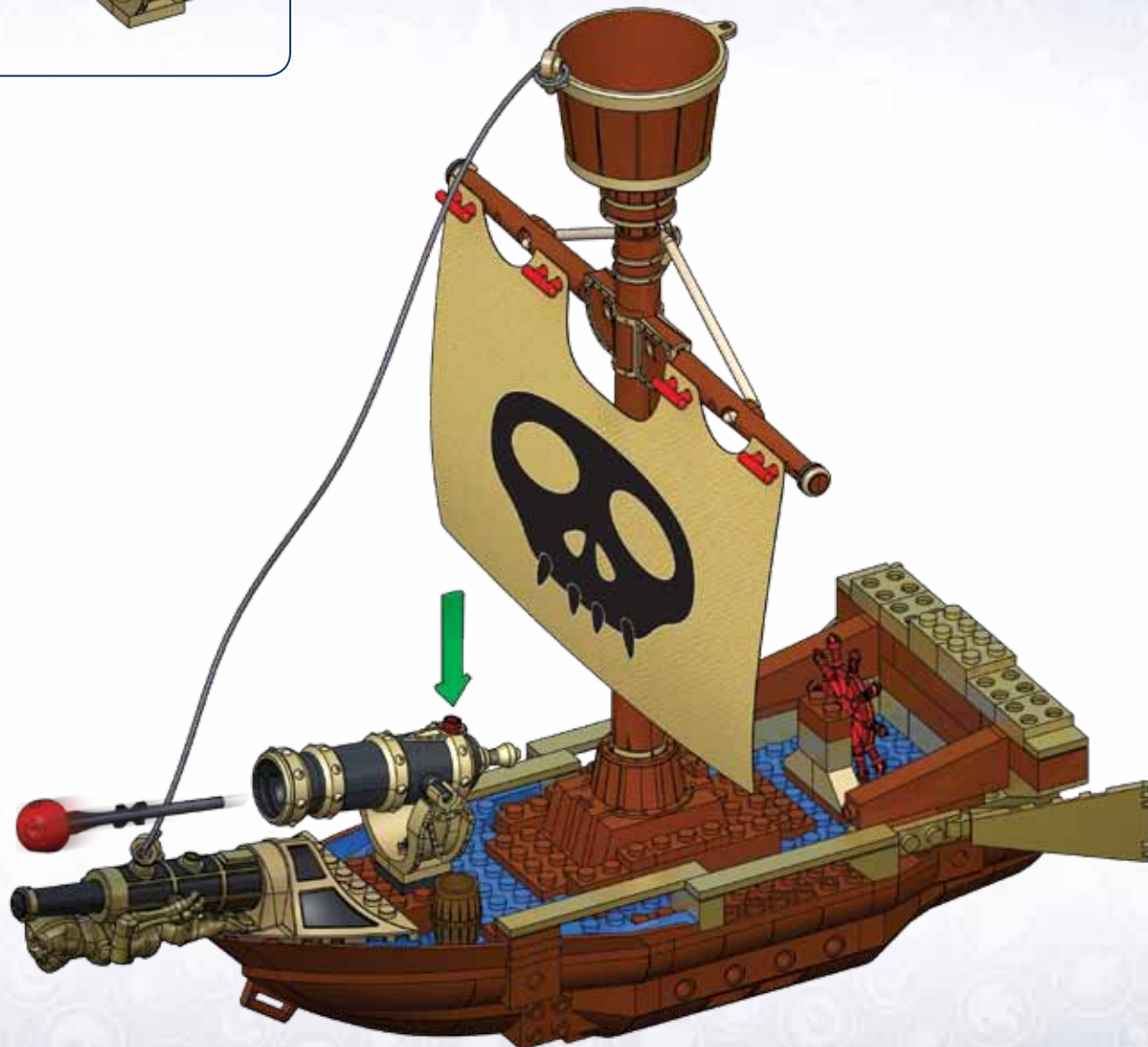

Use only the projectile included with this toy.
 Utiliser seulement le projectile fourni avec le jouet.
 Utilizar solamente el proyectil incluido con el juguete.
 Nur das mit dem Spielzeug mitgelieferte Projektil verwenden.
 Alleen het met het speelgoed bijgeleverde projectiel gebruiken.
 Utilizzare soltanto il proiettile fornito con questo giocattolo.
 Usar somente o projéctil incluido com este brinquedo.
 Nie celować w oczy lub twarz. Należy stosować jedynie nabój dołączony do zabawki.

إستخدم فقط القذيفة المرافقة لهذه اللعبة

- ⒺⓁ ⚠️ WARNING ! Do not aim at eyes or face.
- ⒺⓅ ⚠️ ATTENTION ! Ne pas viser les yeux ou le visage.
- ⒺⓆ ⚠️ ADVERTENCIA ! NO dirigir nunca los proyectiles hacia los ojos o la cara.
- ⒺⓇ ⚠️ ACHTUNG ! Nicht auf das Gesicht oder die Augen richten.
- ⒺⓈ ⚠️ AVVERTENZA ! Non puntare verso gli occhi o il viso.
- ⒺⓉ ⚠️ ATENÇÃO ! Não apontar para os olhos ou o rosto.
- ⒺⓃ ⚠️ OSTRZEŻENIE ! Nie celować w oczy lub twarz.
- ⒺⓄ ⚠️ WAARSCHUWING ! Sikt ikke mot øyne eller ansikt.
- ⒺⓅ ⚠️ ADVARSEL ! Peg ikke i retning af øjne eller ansigt.
- ⒺⓆ ⚠️ ΠΡΟΕΙΔΟΠΟΙΗΣΗ !! Να μην σκοπεύετε προς τα μάτια ή το πρόσωπο.
- ⒺⓇ ⚠️ VAROITUS ! Älä tähtää silmiin tai kasvoihin.
- ⒺⓈ ⚠️ ADVARSEL ! Sikt ikke mot øyne eller ansikt.
- ⒺⓉ ⚠️ WARNING ! Rikta inte med ögon eller ansikte.
- ⒺⓃ ⚠️ 注意！目や顔に使用しないで下さい。
- ⒺⓄ ⚠️ 警告！不要对准眼睛或脸。
- ⒺⓅ ⚠️ تنبيه! لا توجه للعينين أو الوجه



1



2



1

2x 1x

1x

2x

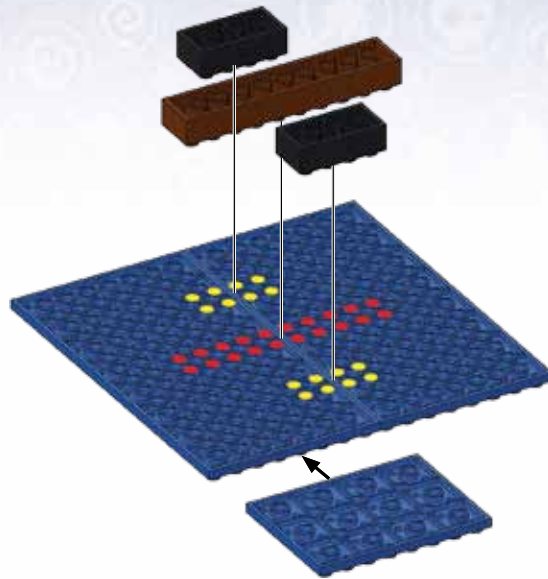

2

5x

3

2x 3x 5x

X3

X2

1

2

4



4x

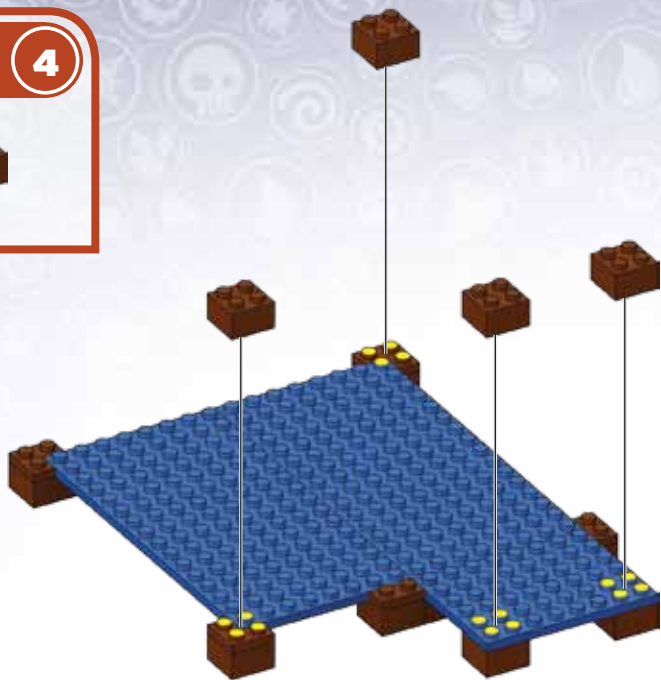

5



1x



1x



3x

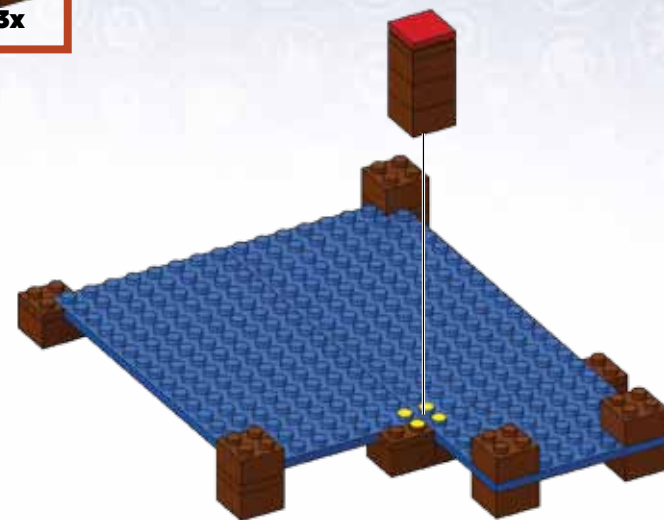
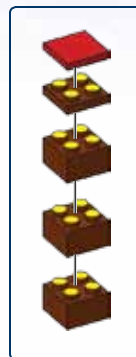

6



6x

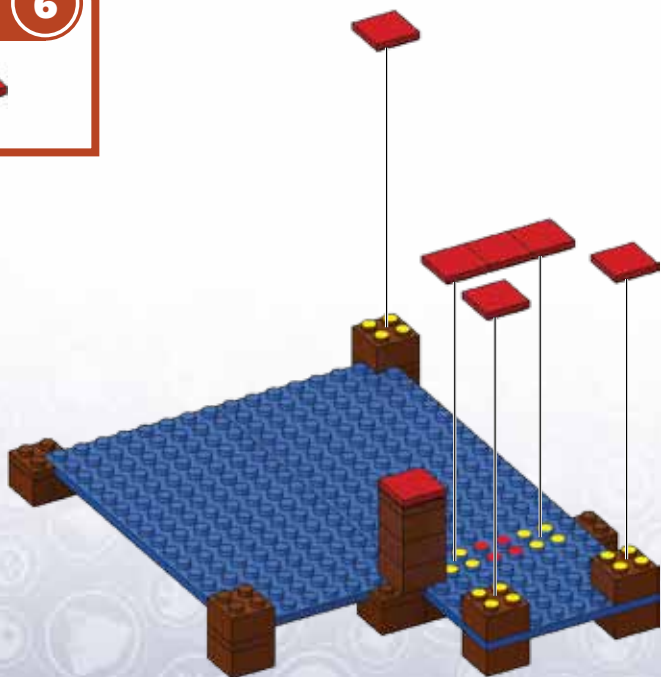

7



1x



1x



1x



1x

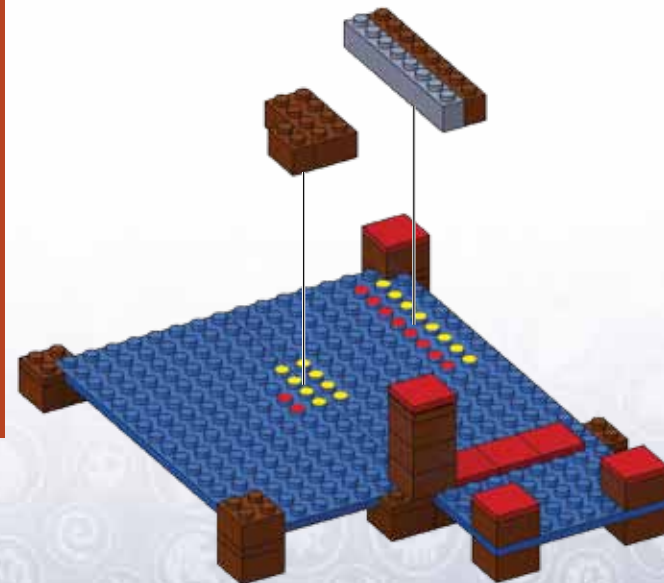

8



5x



1x



1x

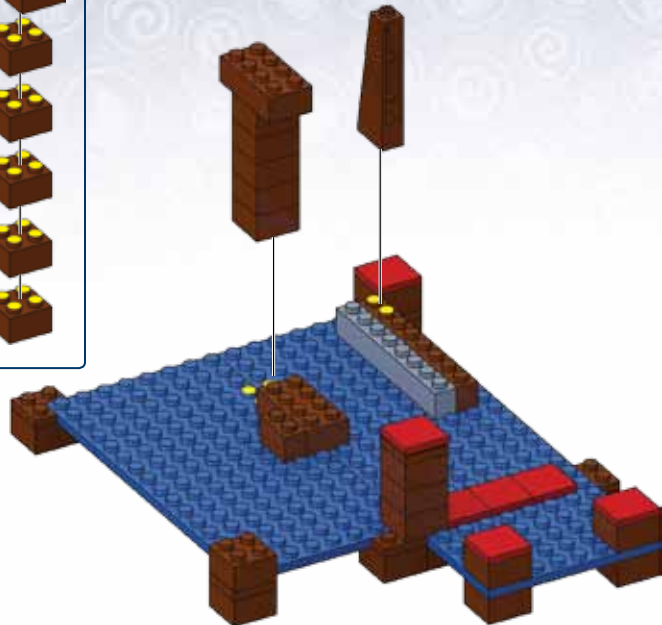

9



4x



1x



1x

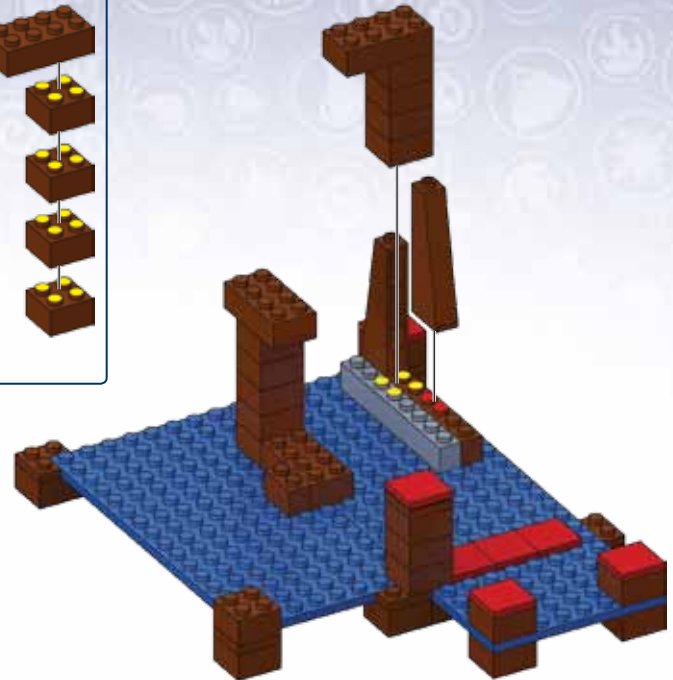

10



1x

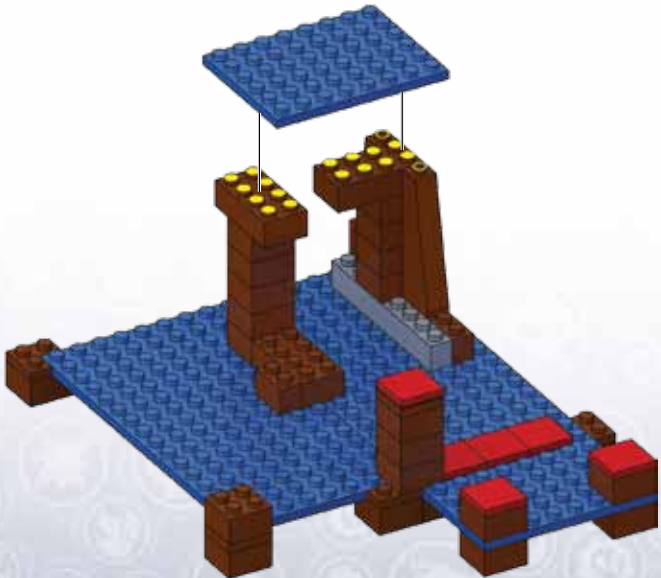

11

-  3x
-  1x
-  1x



12

-  1x
-  2x
-  1x



13

-  1x
-  2x
-  1x

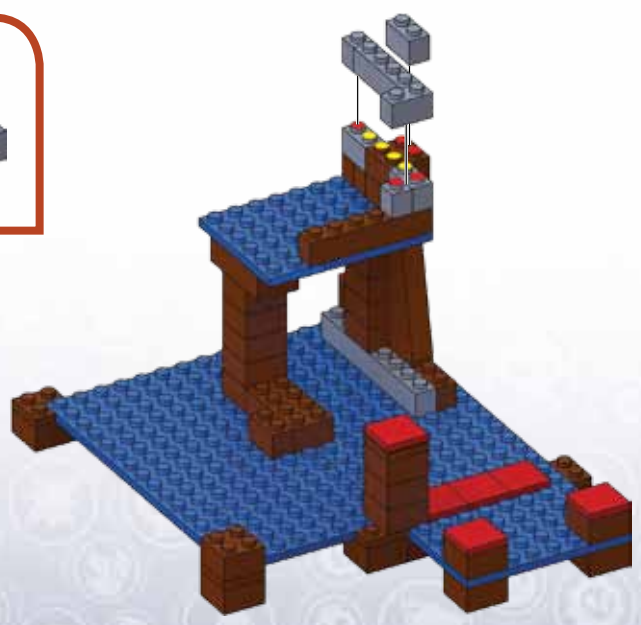

14



15

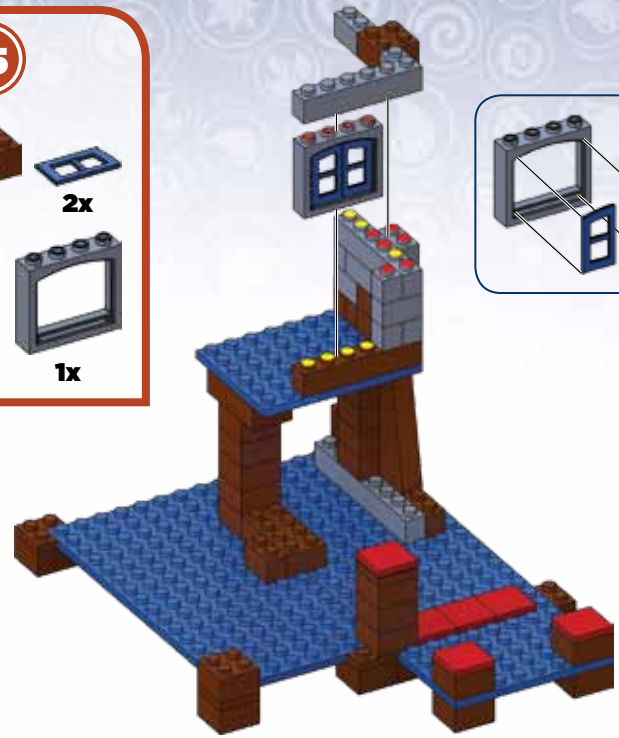
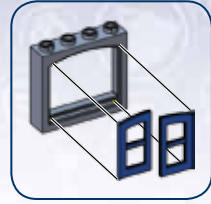
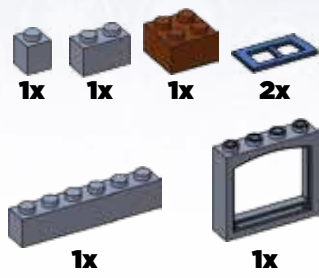

16

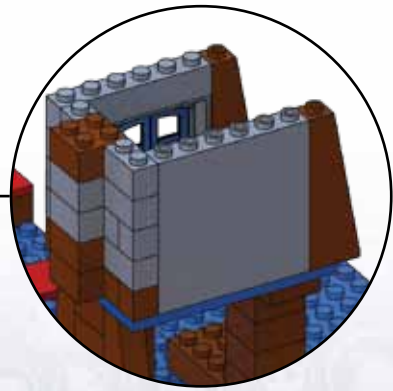
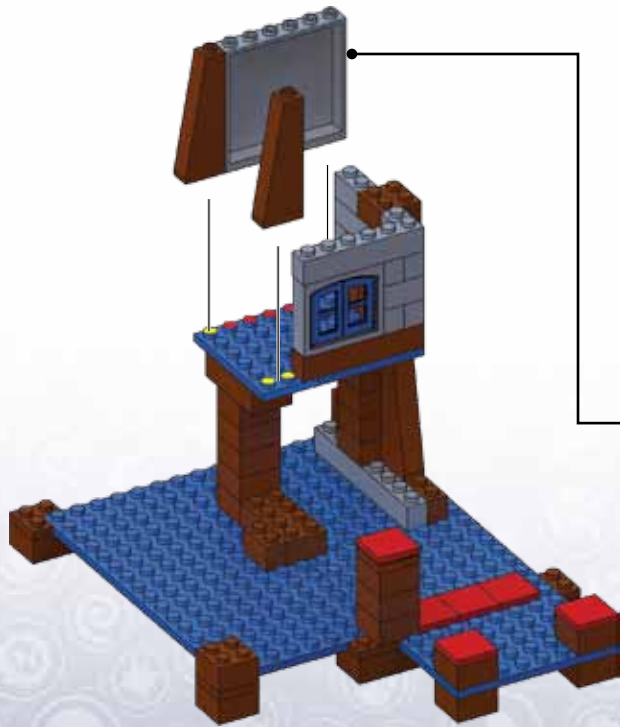

17



5x

18



3x



1x



1x

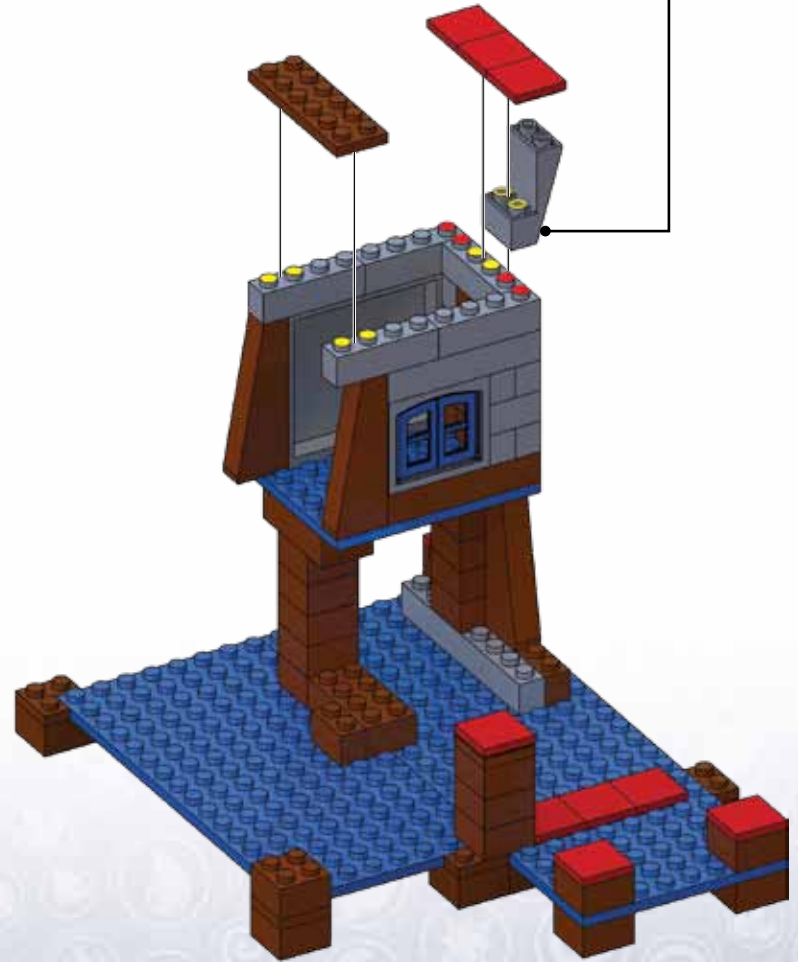
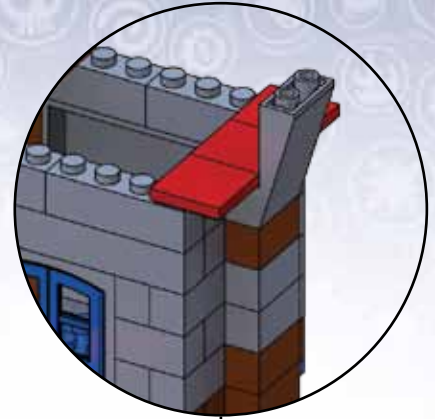

19



20

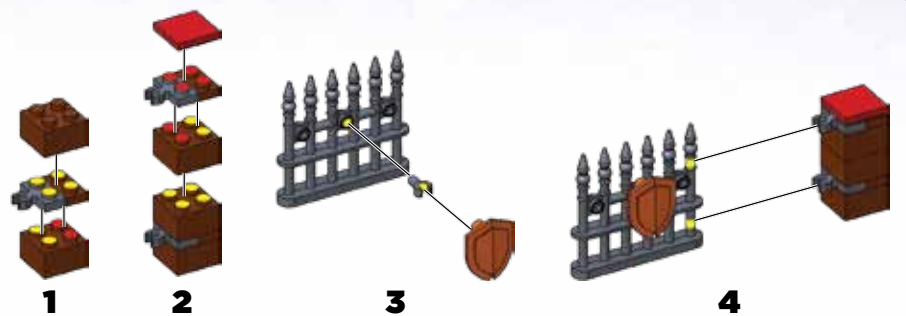

21

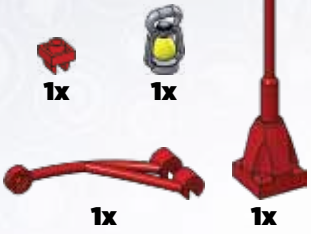

22



23

15x

1x

1x

1x

1x

1

2

3

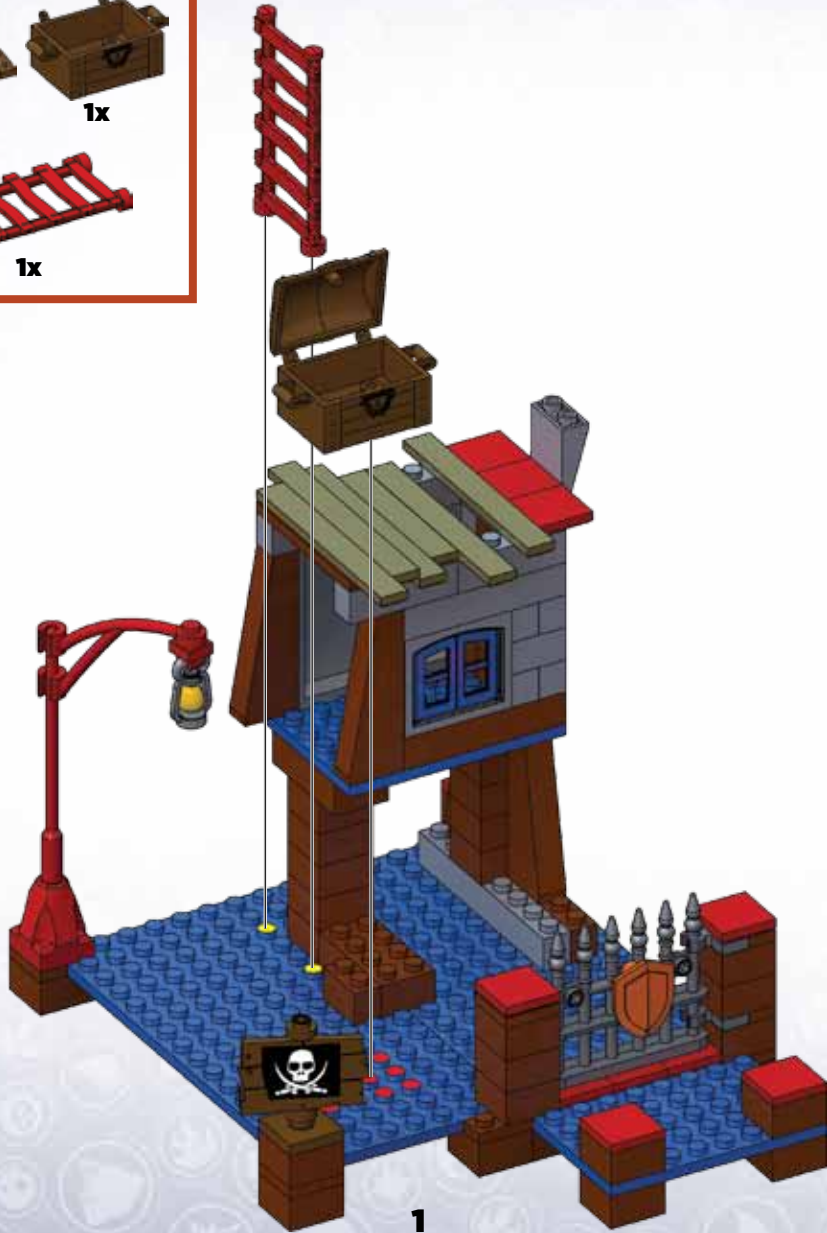

1



2



MEGA BLOKS



CYNDER



CRUSHER



2 IN 1 BUILD AND REBUILD
 CONSTRUYE Y RECONSTRUYE
 CONSTRUIS ET RECONSTRUIS
 BAUE IMMER WIEDER NEU / BOUWEN EN HERBOUW
 COSTRUISCI E RICOSTRUISCI / CONSTRŌI E RECONSTRŌI

BUILD THE ADVENTURE!
 ¡CONSTRUYA SU AVENTURA!
 CONSTRUISEZ VŌTRE AVENTURE!

BAUE DIR OEBN EIGENES ABENTEUER!
 MAAK JE EIGEN AVONTUUR!
 COSTRUIE LA VOSTRA AVVENTURA!
 CONSTRUA A SUA AVENTURA!

SUMMON THE ATTACK!
 CONQUER THE FORTRESS!
 ¡CONVOCA EL ATAQUE!
 ¡CONQUISTA LA FORTALEZA!
 PRÉPAREZ L'ATTAQUE ! PARTEZ Á
 LA CONQUÊTE DE LA FORTERESSE !

BEFÖHRE OEBN ANHERRSCH VERFÜGUNG DIE FORTUNE!
 ZEE JE AANVAL! IK VEROVER DE VESTING!
 ALL'ATTACCO! CONQUISTALO LA FORTENZA!
 CONVOCA O ATAQUE! CONQUISTA A FORTALEZA!



© 2012, MEGA Brands Inc. © &
 MEGA Brands Inc.
 Printed in Canada D954422A



© 2012 Activision Publishing, Inc.
 SKYLANDERS GIANTS is a trademark,
 and ACTIVISION is a registered trademark of
 Activision Publishing, Inc.

