

NEO MACHINES™



TRANSFORMS INTO VEHICLE / SE TRANSFORMA EN VEHÍCULO
SE TRANSFORME EN VÉHICULE / VERWANDELT SICH IN EIN FAHRZEUG
VERANDERT IN EEN VOERTUIG / SI TRASFORMA IN UN VEICULO /
TRANSFORMA-SE EM VEÍCULO

6382 | **Jetstrike™**

**MEGA
BLOKS**

EN Please read these instructions carefully before first use and keep them for future reference. / **ES** Leer estas instrucciones cuidadosamente antes de la primera utilización y guardarlas para referencia futura. / **FR** Il est recommandé de lire attentivement ce feuillet avant la première utilisation et de le conserver pour référence future. / **DE** Die Gebrauchsanleitung bitte durchlesen und aufbewahren. / **NL** Wij raden u aan deze handleiding zorgvuldig te lezen en te bewaren voor eventuele raadpleging op een later tijdstip. / **IT** Leggere le istruzioni prima di cominciare ad usare il gioco e conservarle per referenze future. / **PT** Leia as instruções antes do primeiro uso e guarde-as para futura referência.

EN ⚠ **WARNING :**
CHOKING HAZARD. - Small parts.
Toy contains a small ball.
Not for children under 3 years.

ES ⚠ **ADVERTENCIA :**
PELIGRO DE ASFIXIA. - Contiene piezas pequeñas. El juguete contiene una bola pequeña. No recomendado para niños menores de 3 años.

FR ⚠ **AVERTISSEMENT :**
RISQUE DE SUFFOCATION. - Présence de petits éléments. Le jouet contient une petite balle. Ne convient pas aux enfants de moins de 3 ans.

DE ⚠ **WARNING :**
ERSTICKUNGSGEFAHR. - Enthält kleine Teile.
Ein kleiner Ball ist im Spielzeug inbegriffen.
Nicht für Kinder unter 3 Jahren geeignet.

NL ⚠ **WAARSCHUWING :**
VERSTIKKINGSGEVAAR. - Bevat kleine onderdelen. Speelgoed bevat een klein balletje. Niet geschikt voor kinderen onder de 3 jaar.

DA ⚠ **ADVARSEL :**
KVÆLNINGSFARE. - Inneholder små deler. Legetøjet indeholder en lille bold. Ikke til børn under 3 år.

EL ⚠ **ΠΡΟΕΙΔΟΠΟΙΗΣΗ :**
ΚΙΝΔΥΝΟΣ ΠΝΙΣΜΑΤΟΣ. - Περιέχει μικρά αντικείμενα Το παιχνίδι περιέχει ένα μαλάκι. Όχι για παιδιά κάτω των 3 ετών.

FI ⚠ **VAROITUS :**
TUKEUTUMISVAARA. - Sisältää pieniä osia. Leluun sisältyy pieni pallo. Ei alle 3-vuotiaalle lapsille.

IT ⚠ **ATTENZIONE :**
PERICOLO DI SOFFOCAMENTO. - Contiene piccole parti. Il giocattolo comprende una pallina. Non indicato per bambini sotto i 3 anni.

NO ⚠ **ADVARSEL :**
KVÆLNINGSFARE. - Inneholder små deler. Leketøyet inneholder en liten ball. Kun for barn over 3 år.

PT ⚠ **ATENÇÃO :**
PERIGO DE ASFIXIA. - Contém peças pequenas. O brinquedo contém uma pequena bola. Não é concebido para crianças de menos de 3 anos.

SV ⚠ **VARNING :**
KVÄVNINGSRISK. - Innehåller små delar. Leksaken innehåller en liten boll. Inte för barn under 3 år.

JA ⚠ **警告 :**
窒息の危険性 - 小さな部品が含まれています。小さな玉が含まれています。3歳以下の子供には与えないで下さい。

ZH ⚠ **警告 :**
有窒息危險 - 包含有小朋友此玩具含有一個小球。不适合3岁以下的孩子玩。

AR ⚠ **تحذير :**
خطر اختناق - قطع صغيرة تحتوي اللعبة على كرة صغيرة. غير صالحة للأطفال أقل من 3 سنوات.



- EN** CAUTION! Do not aim at eyes or face.
- ES** ¡ADVERTENCIA! NO dirigir nunca los proyectiles hacia los ojos o la cara.
- FR** ATTENTION! Ne pas viser les yeux ou le visage.
- DE** VORSICHT! Nicht auf das Gesicht oder die Augen richten.
- NL** LET OP: Niet op ogen of gezicht richten.
- DA** ADVARSEL! Peg ikke i retning af øjne eller ansigt.
- EL** ΠΡΟΣΟΧΗ! Να μην σκοπεύετε προς τα μάτια ή το πρόσωπο.
- FI** VARO! Älä tähtää silmiin tai kasvoihin.
- IT** Attenzione! Non puntare verso gli occhi o il viso.
- NO** FORSIKTIG! Sikt ikke mot øyne eller ansikt.
- PT** ATENÇÃO: Não apontar para os olhos ou o rosto.
- SV** VAR FÖRSIKTIG! Rikta inte med ögon eller ansikte.
- JA** 注意！目や顔に使用しないで下さい。
- ZH** 警告！不要对准眼睛或脸。
- AR** تنبيه! لا توجه للعينين أو الوجه

Use only the projectiles included with this toy.
Utilizar solamente los proyectiles incluidos con el juguete.
Utiliser seulement les projectiles fournis avec le jouet.
Nur die mit dem Spielzeug mitgelieferten Projektile verwenden.
Alleen de met het speelgoed bijgeleverde projectielen gebruiken.
Utilizzare soltanto i proiettili forniti con questo giocattolo.
Usar somente os projécteis incluídos com este brinquedo.
استخدم فقط القذيفة المرافقة لهذه اللعبة

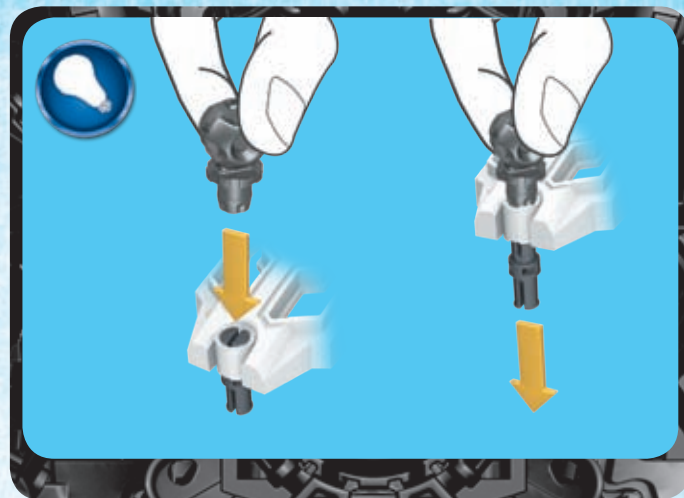

2x
AS0638214



8x
AM01793TY



1x
AM16538TY



6x
AS0638208



1x
AM16542ADD



4x
AM16556TY



1x
AS0638216



6x
AM09731KM



1x
AS0638213



1x
AS0638202



1x
AS0638201



2x
AM16555TY



1x
AM16536KM



2x
AM16547ADD



2x
AS0638205



1x
AM16543KM



1x
AM16537KM



1x
AS0638215

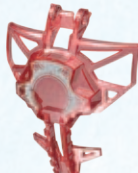

9 IN
23 CM

JETSTRIKE™

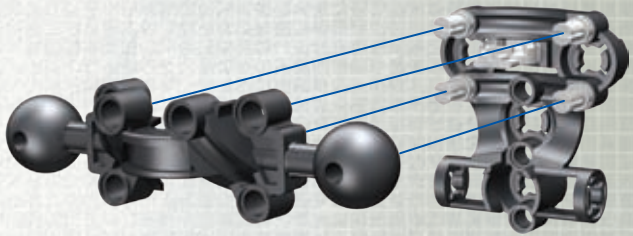
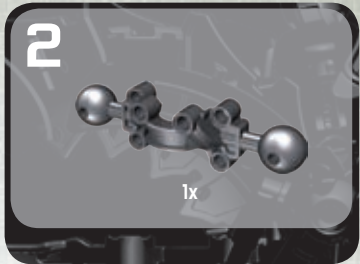
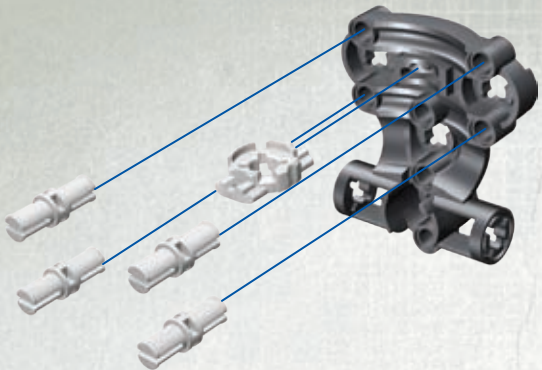
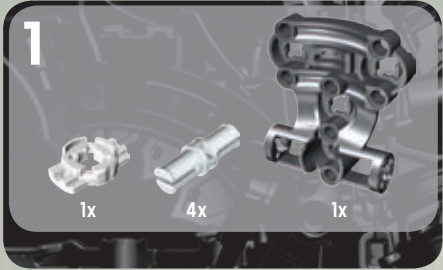

3



2x



1x

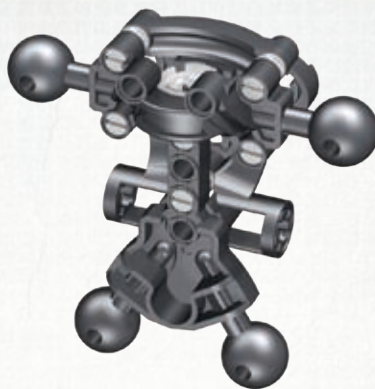
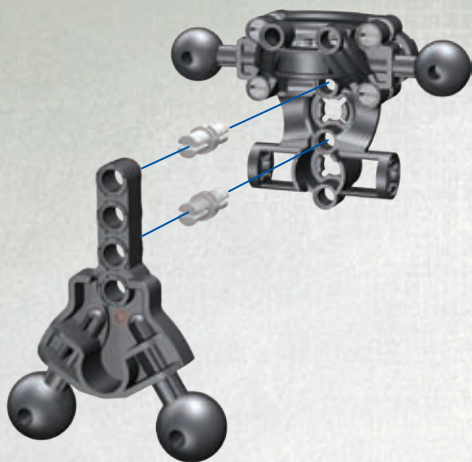

p. 6



p. 14



4



1x

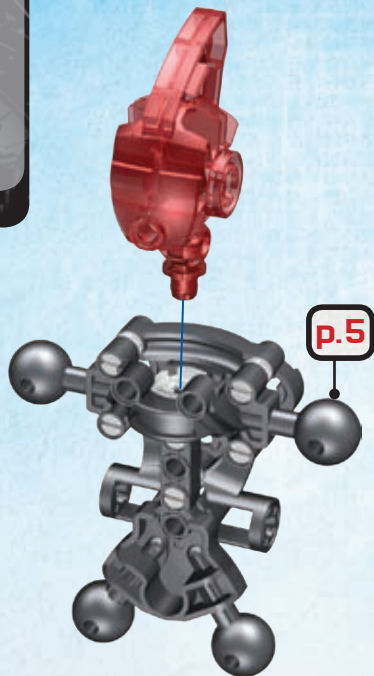

p.5

5



2x



2x



2x



x2

6

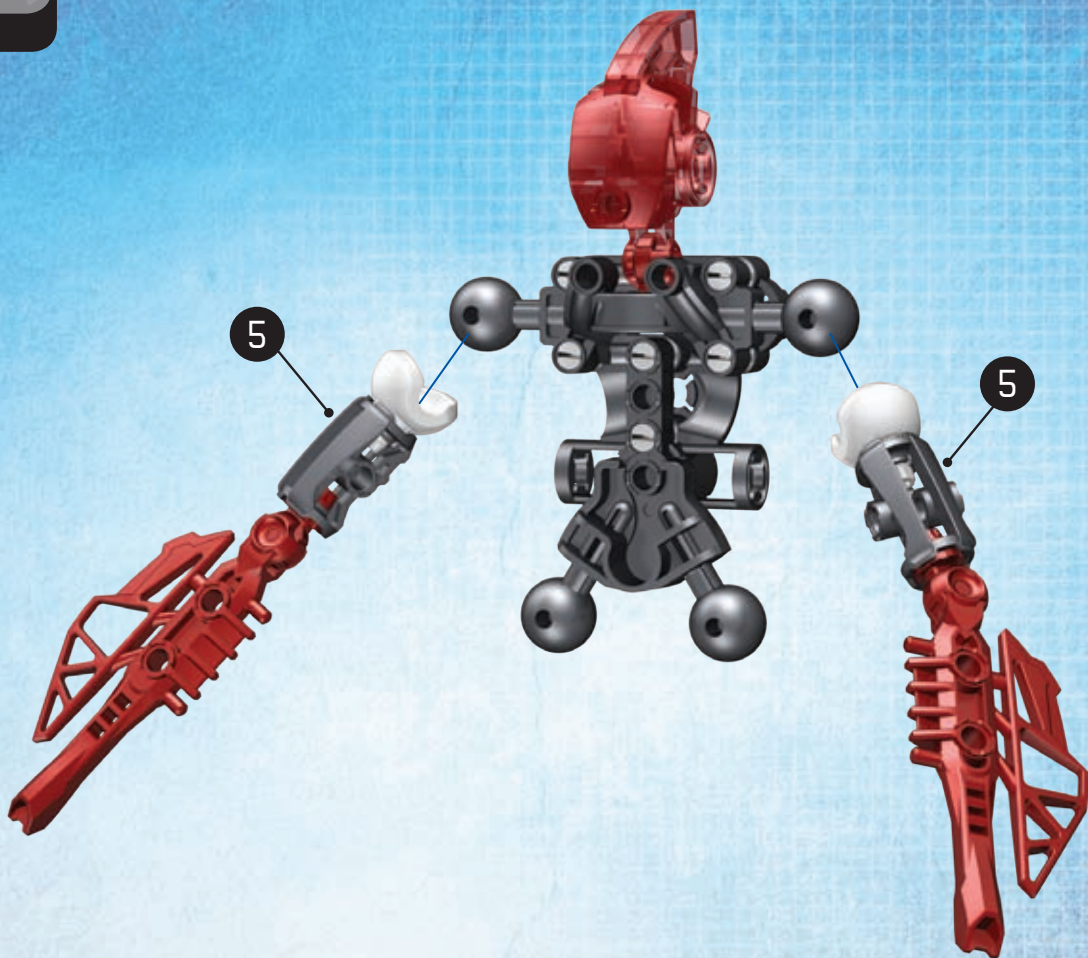

7



2x



4x



4x



2x

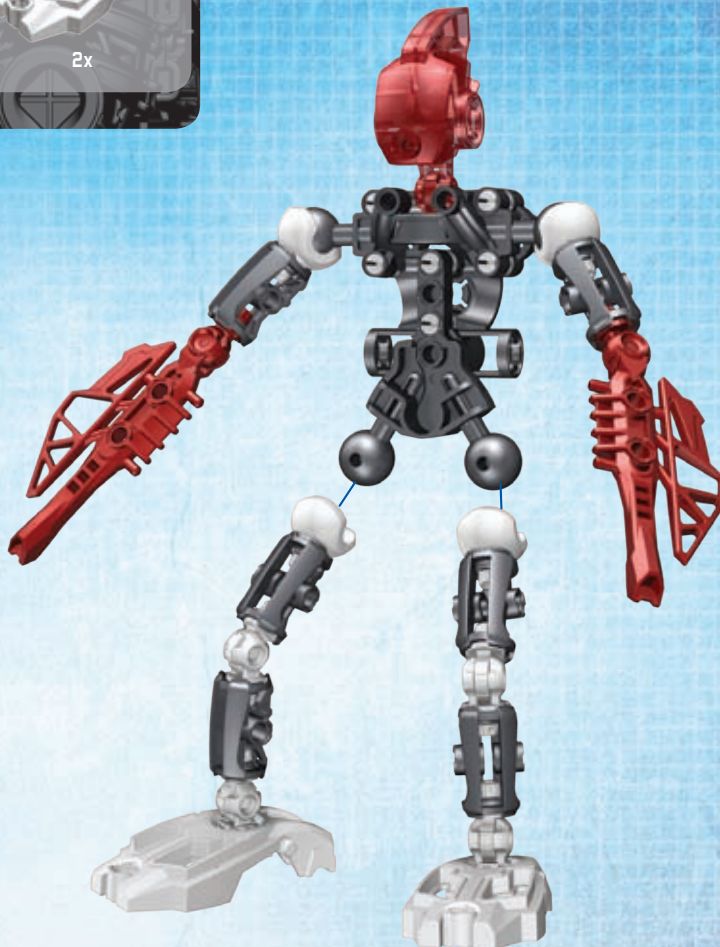

8



2x



2x

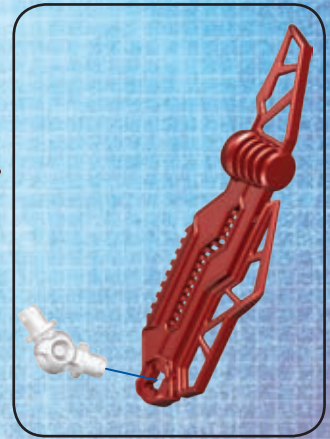
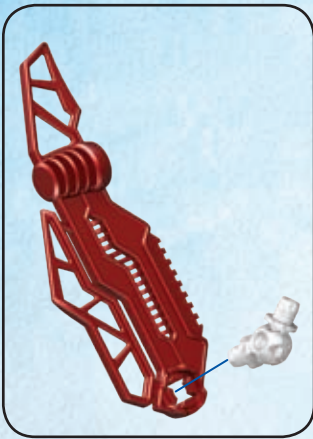
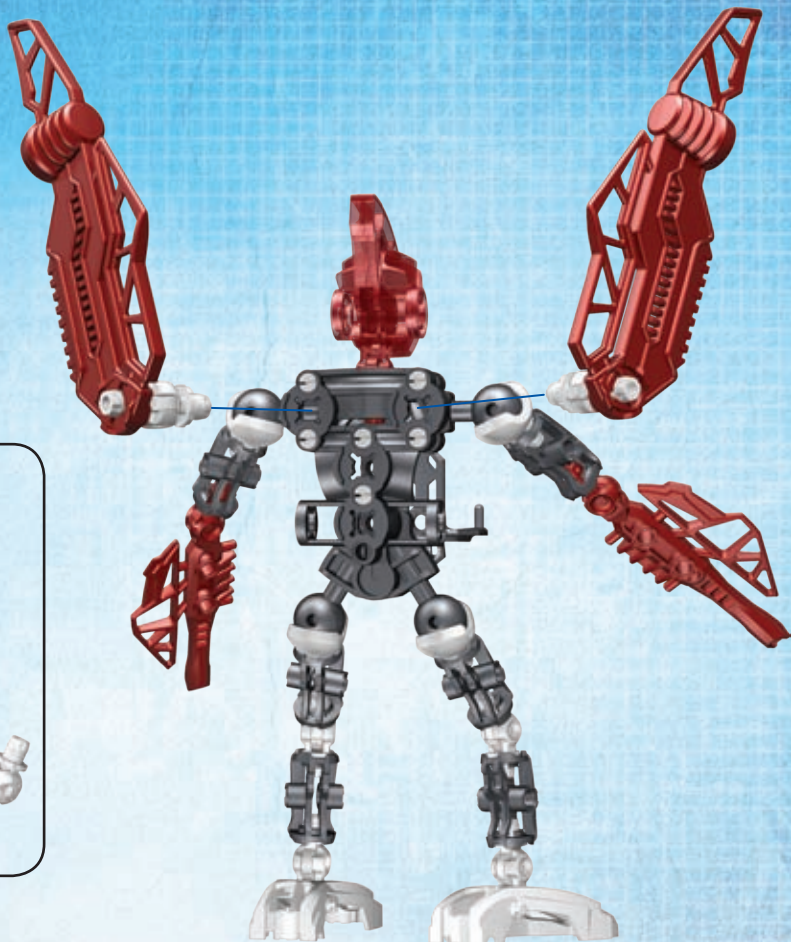

9



1x



10



1x



1x



1



2

11



12

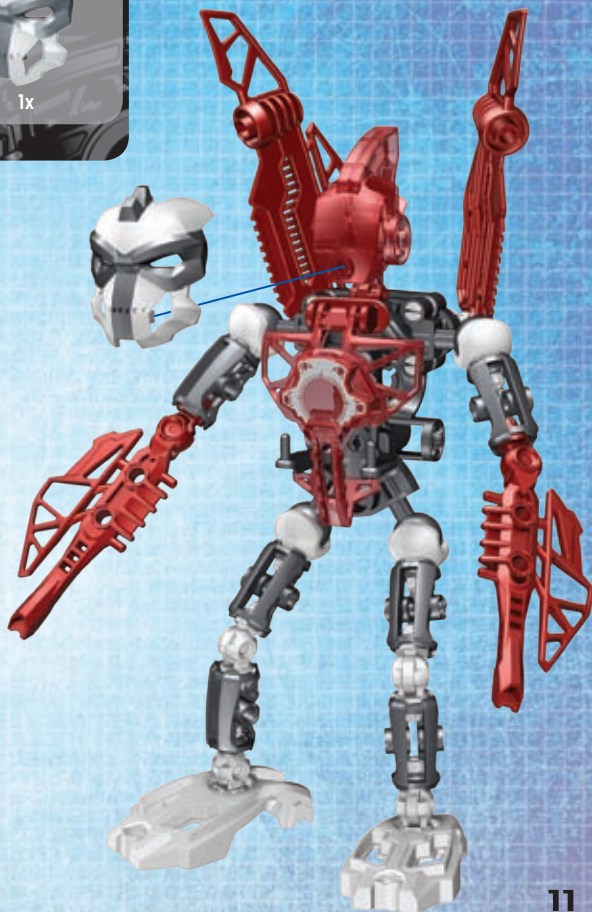

13



1x



1x

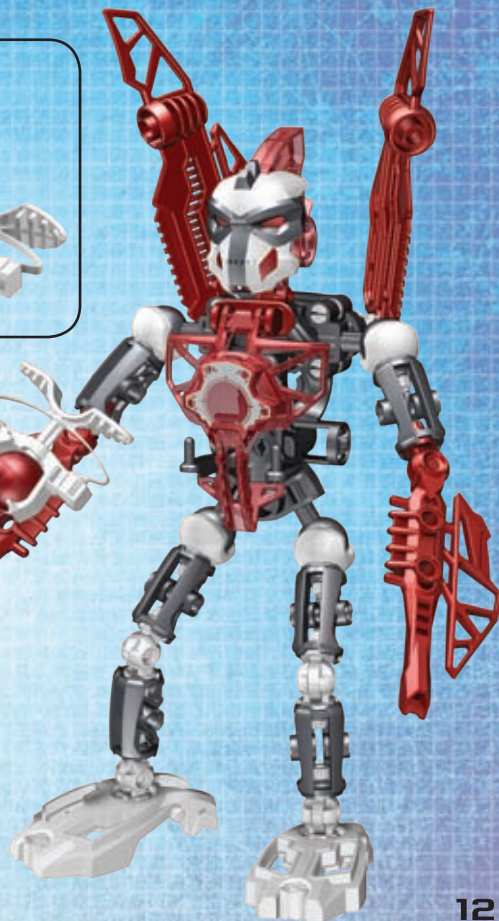
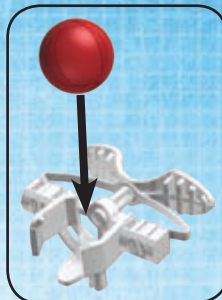

NEO
MACHINES™

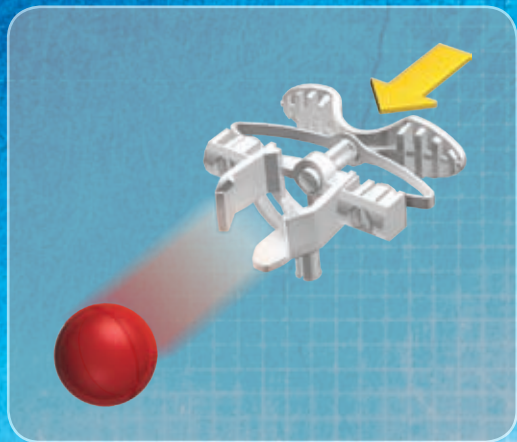

4



2x



2x

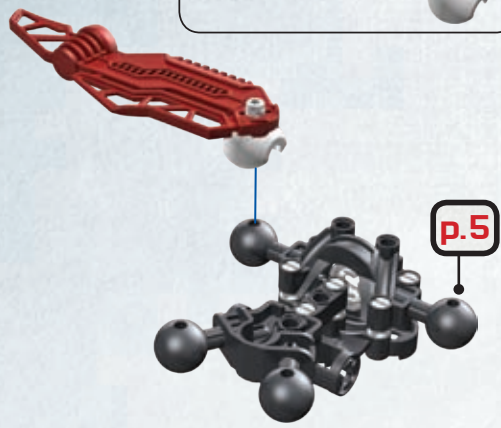
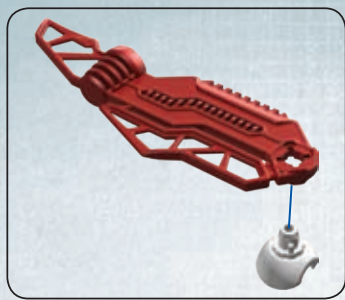

p.5

1

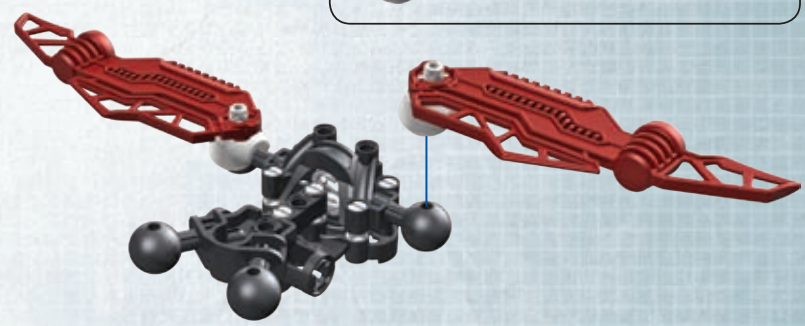
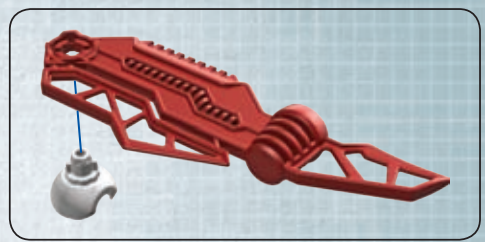

2

5



2x

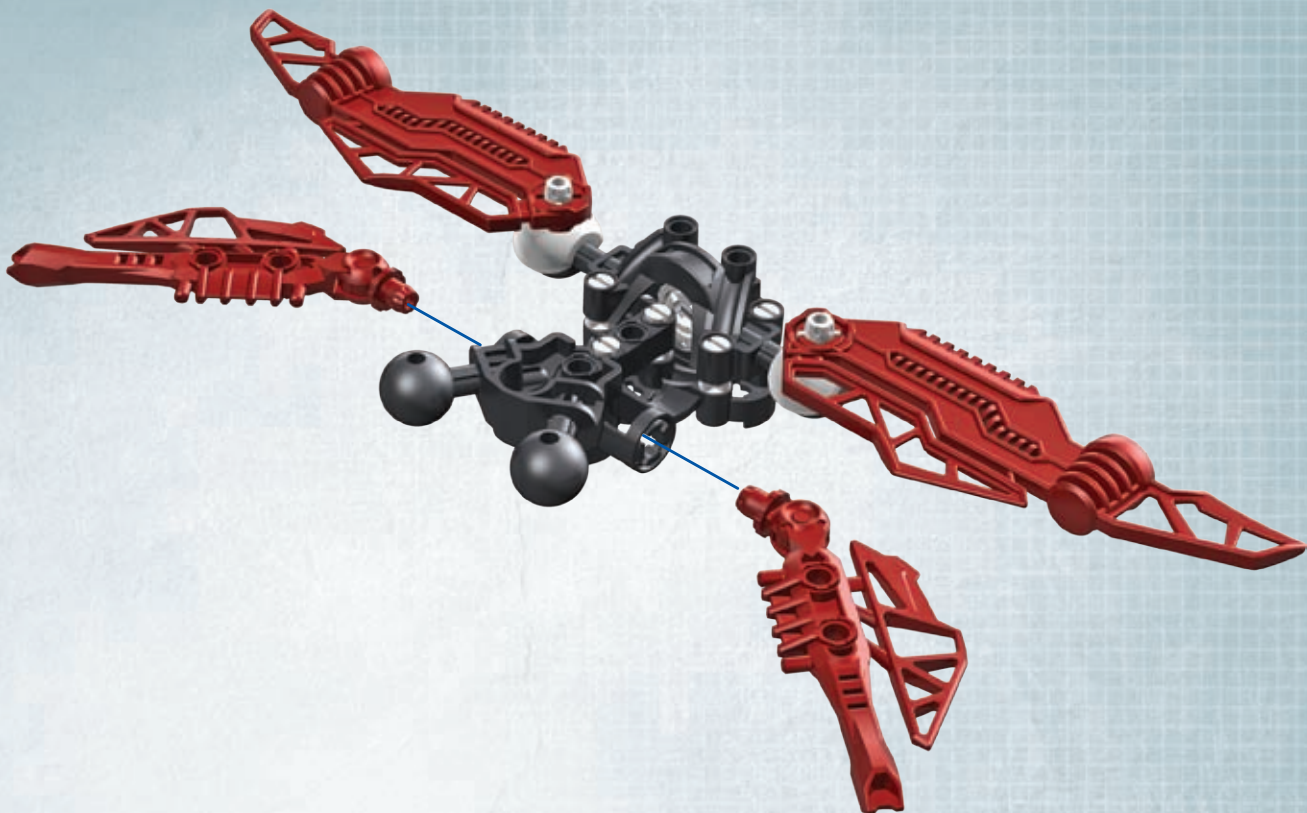

6



2x



2x

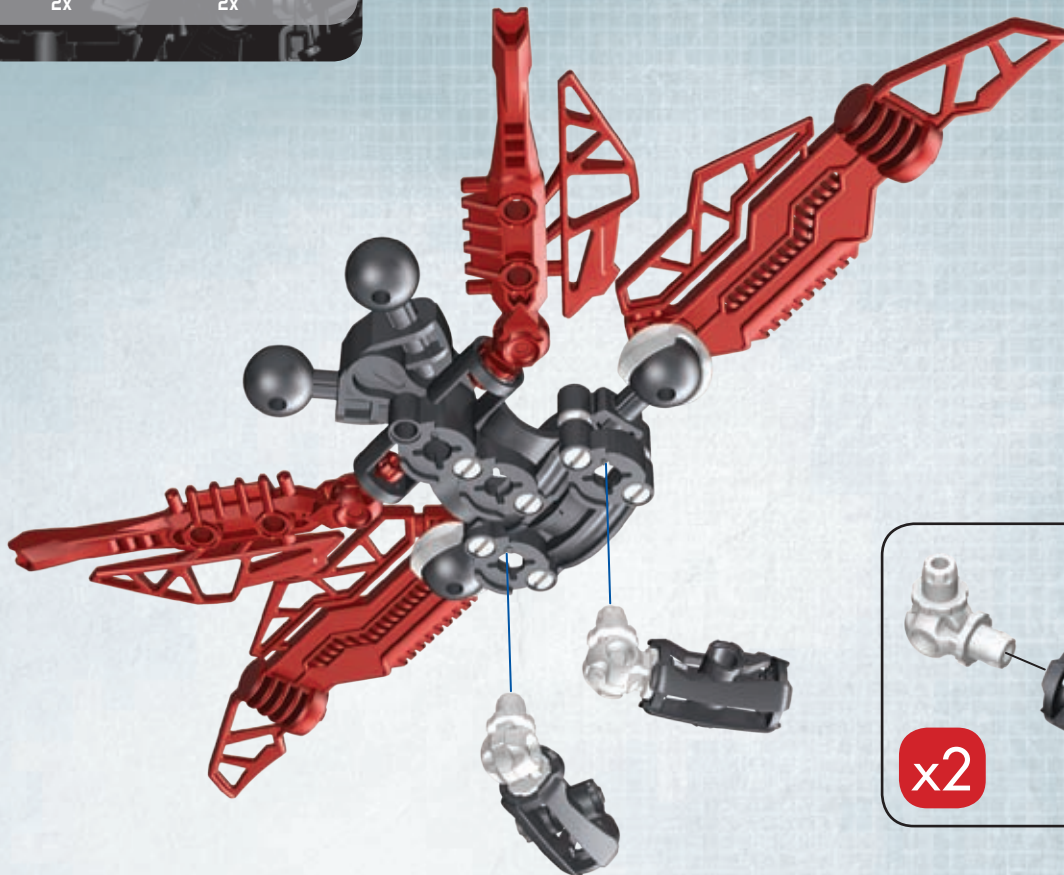

x2



7



4x



2x



4x

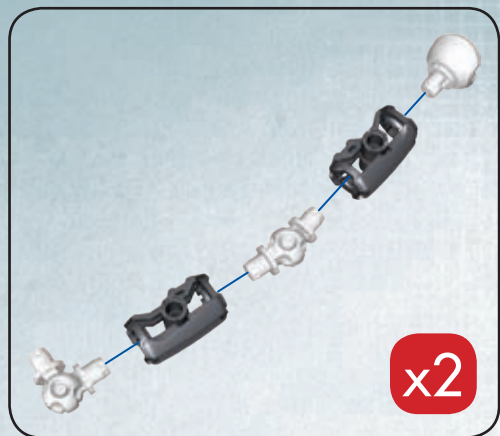

x2

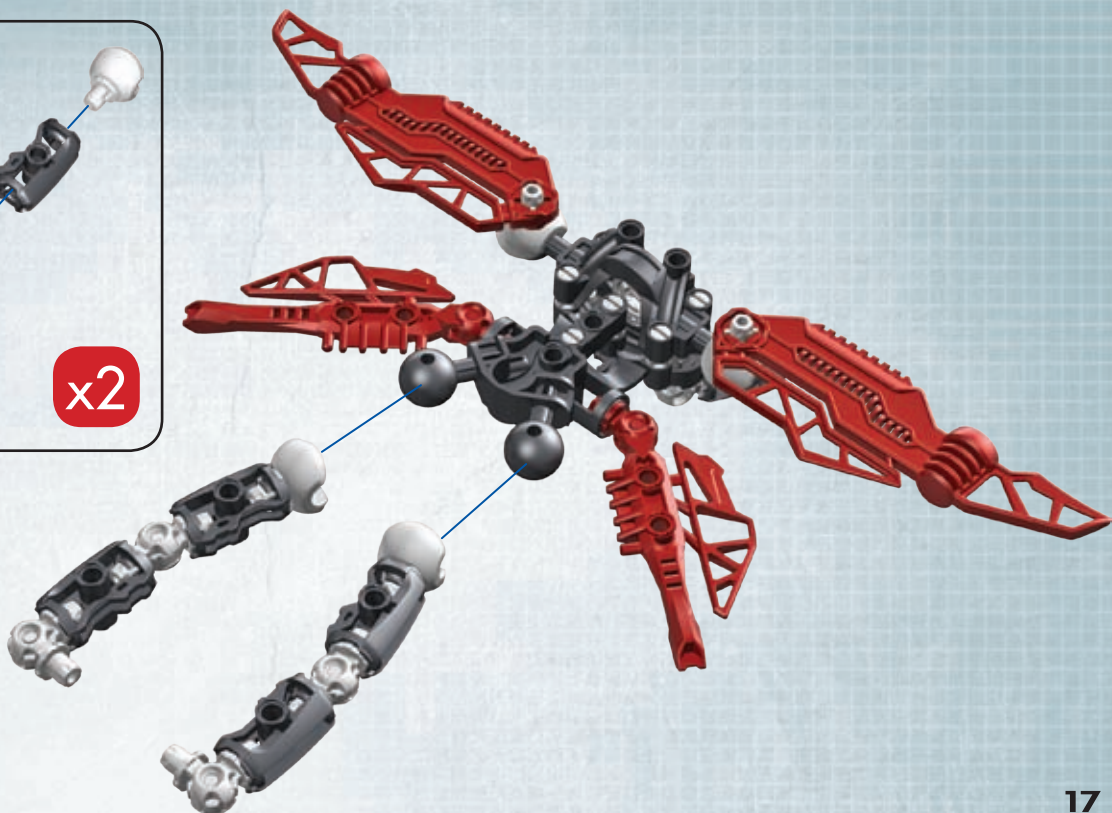

8

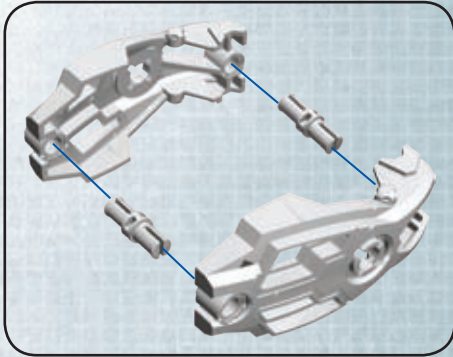
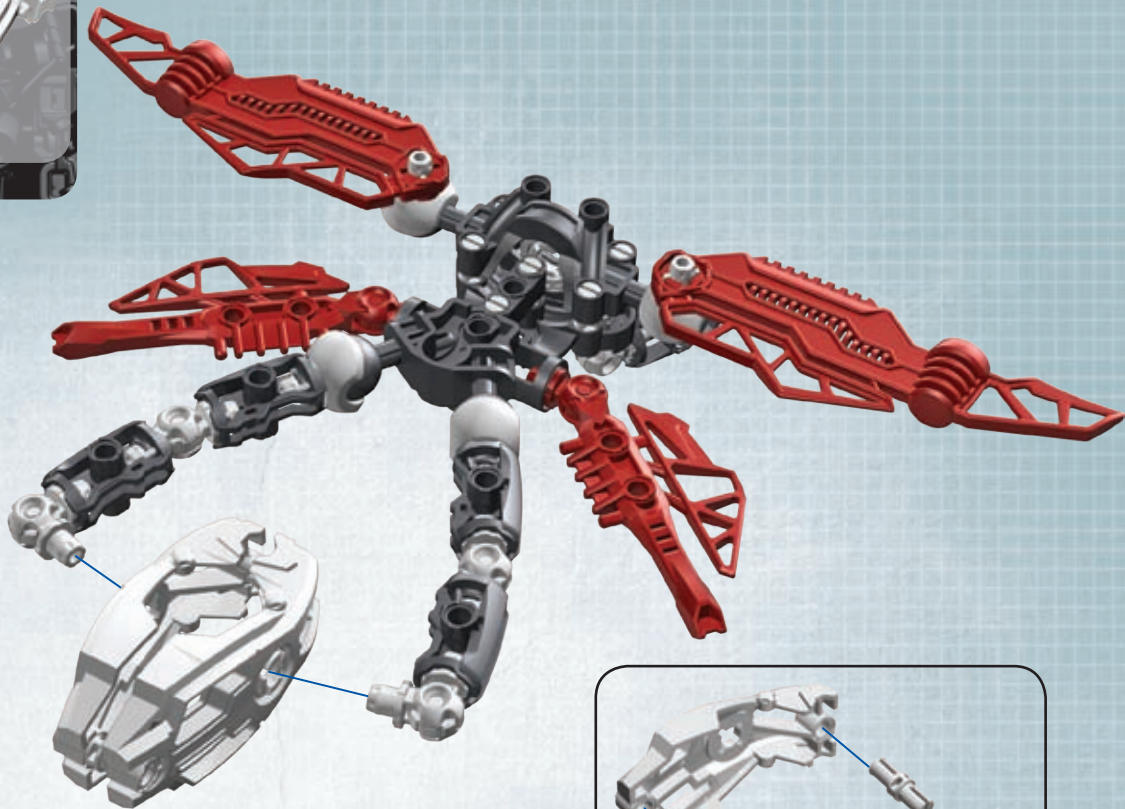

9



1x



10

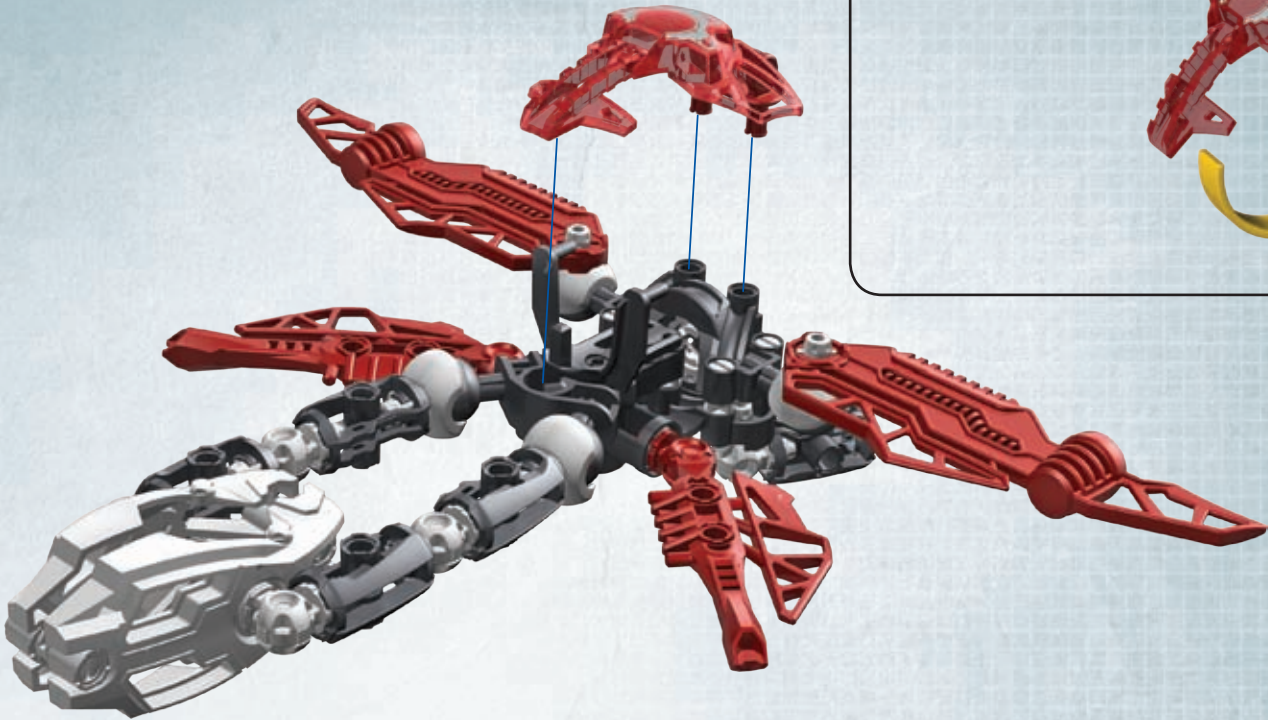
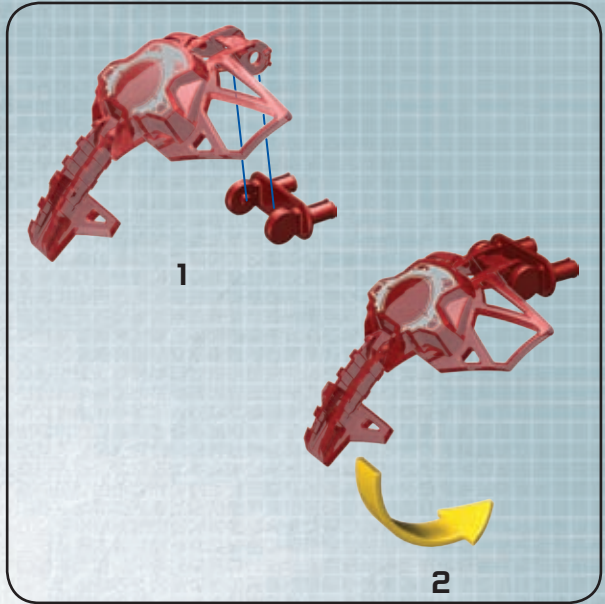

11



1x



1x

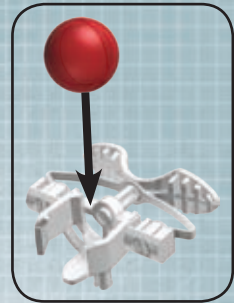



NEO
MACHINES™

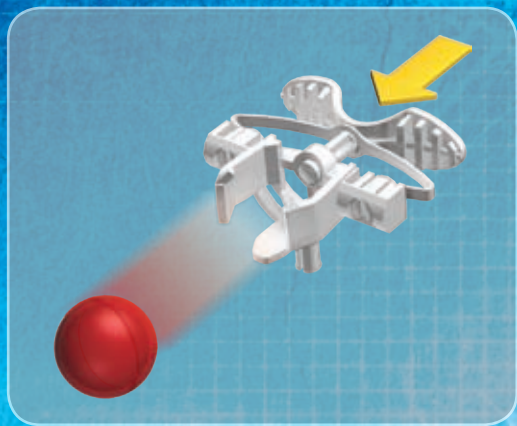

The age of the NED Shifters® is long gone, and the humanoids of Hydraxx-Tor™ use components salvaged from the destroyed Shifters to build massive robotic creations - the NED MACHINES™. With the awesome power to transform into land, sea or air vehicles, The NED MACHINES™ are ready to battle in any terrain!

La historia de los NED Shifters® es larga y los humanoides de Hydraxx-Tor™ utilizan los elementos sobrantes de los Shifters desaparecidos para construir poderosas máquinas robóticas, denominadas NED MACHINES™. Con la increíble capacidad para transformarse en vehículos terrestres, marítimos o aéreos, las MÁQUINAS NED están preparadas para librar batalla en cualquier terreno!

L'ère des NED Shifters® est révolue. Les humanoïdes d'Hydraxx-Tor™ ont utilisé des composants récupérés sur les Shifters détruits pour construire de massives créations robotisées appelées NED MACHINES™. Dotées de la capacité de se transformer en véhicule terrestre, marin ou aérien, les NED MACHINES™ sont prêtes à combattre sur n'importe quel terrain!

Das Zeitalter der NED-Shifters® ist schon lange vorbei, und die Humanoiden von Hydraxx-Tor™ bauen aus den Komponenten zerstörter Shifters massive Roboter - die NED MACHINES™. Durch ihre unglaubliche Fähigkeit, sich in Land-, See- oder Luftfahrzeuge zu verwandeln können die NED MACHINES™ überall kämpfen!

Het tijdperk van de NED Shifters® is voorgoed voorbij en de humanoiden van Hydraxx-Tor gebruiken onderdelen van de restanten van de vernietigde Shifters om geweldige robotcreaties te bouwen - de NED MACHINES™. Met de vernietigende kracht om zich in land-, zee- of luchtmachines te veranderen, zijn de NED MACHINES™ in staat om op elk terrein strijd te leveren!

L'era dei NED Shifter® è tramontata da tempo, e gli umanoidi di Hydraxx-Tor usano i componenti recuperati dalle carcasse degli Shifters per costruire creazioni robotiche gigantesche - le NED MACHINES™. Con il grandioso potere di trasformarsi in veicoli di terra, mare o aria, le NED MACHINES™ sono in grado di combattere in ogni ambiente!

A era dos NED Shifters® passou, e os humanoides de Hydraxx-Tor usam componentes recuperados a partir dos Shifters destruídos para construir criações robóticas massivas - as NED MACHINES™. Com a capacidade impressionante de se transformarem em veículos terrestres, marítimos ou aéreos, As NED MACHINES™ estão prontas para lutar em qualquer terreno!



ALSO AVAILABLE
TAMBIÉN DISPONIBLE
ÉGALEMENT DISPONIBLE
EBENFALLS ERHÄLTICH
EVENEENS BESCHIKBAAR
ANCHE DISPONIBILE
TAMBÉM DISPONÍVEL



6382



6383



6384



6387



6388



© 2008, MEGA Brands Inc.
MEGA Brands Inc. and the MEGA Brands Inc. logo are registered trademarks of MEGA Brands Inc.
MEGA Brands Inc. y el logotipo MEGA Brands Inc. son marcas registradas de MEGA Brands Inc.
MEGA Brands Inc. et le logo de MEGA Brands Inc. sont des marques de commerce déposées de MEGA Brands Inc.
MEGA Brands Inc. und das MEGA Brands Inc.-Logo sind eingetragene Warenzeichen von MEGA Brands Inc.
MEGA Brands Inc. en het MEGA Brands Inc. logo zijn gedeponeerde handelsmerken van MEGA Brands Inc.
MEGA Brands Inc. ed il logo di MEGA Brands Inc. sono marchi di fabbrica di MEGA Brands Inc.
MEGA Brands Inc. e o logo MEGA Brands Inc. são marcas registradas de MEGA Brands Inc.

Printed in China

AD063821A