



For On-line games go to:
Para juegos en linea, visita:
Pour les jeux en ligne, rendez-vous sur:
Hier findest du Online-Spiele:
Ga voor online games naar:
Per giocare online vai all'indirizzo:
Para acederes a jogos em rede:
www.neoshifters.com

Web code / Code Web
Código web / Web-Kode
Codice Web / Código Web



NEO SHIFTERS

Extra weapons!
¡Con armas adicionales!
Armes supplémentaires!

Mehr Waffen!
Meer extra wapens!
Armi extra!
Armas extra!



DUPLICON



6380 | Néo Shifters® Duplicon™

As tensions flare up between Paladins and Templars, Duplicon, the dominating infiltrator takes matters into his own hands. With the assurance of a massive launcher, he explores deeper underground for anything that will afford military leverage. With such firepower, this multifarious creature is poised to be an astounding robot that both factions will want on their side. . .

Mientras continúan los enfrentamientos entre Paladins y Templars, Duplicon, el poderoso infiltrado, decide tomar él mismo cartas en el asunto. Con la seguridad que le proporciona un lanzador masivo, Duplicon explora a fondo la las tierras subterráneas en busca de elementos que sirvan para el combate. Con este poderoso arsenal, esta versátil criatura está preparada para convertirse en una increíble máquina de combate que ambos grupos querrán de aliado. . .Multi-Lanzador

Comme les tensions s'exacerbent entre les Paladins et les Templars, Duplicon, l'agent infiltré dominateur prend les choses en ses propres mains. Avec l'assurance d'un lanceur massif, il explore les profondeurs souterraines à la recherche de tout ce qui procure la puissance militaire. Dotée d'une telle puissance de feu, cette créature multiforme est prête à devenir un robot incroyable que les deux factions veulent avoir de leur côté. . .

Die Spannungen zwischen den Paladinen und Templern steigen, und Duplicon, der mächtige Eindringling, legt los. Mit Hilfe eines massiven Werfers such er tief unter der Erde nach allem, was ihm militärisch Vorteile bringen kann. Diese facettenreiche Kreatur besitzt ungeheuerere Feuerkraft und ist ein erstaunlicher Roboter, den beide Gruppen gern auf ihrer Seite hätten...

Wanneer de spanningen tussen Paladins en Templars toenemen, neemt Duplicon, als dominante indringer, de zaken zelf in handen. Nu hij zich verzekerd heeft van een enorme lanceerbaan, gaat hij dieper ondergronds op zoek naar alles waarmee hij de militaire druk kan opvoeren. Met een dergelijke vuurkracht kan dit veelsoortige schepsel zich op elk moment in een alles verpletterende robot veranderen die beide partijen graag aan hun kant hebben...

Mentre la tension fra Paladins e Templars infuria, Duplicon, l'infiltrato dominante si occupa personalmente della questione. Aiutato da un enorme lanciamissili egli esplora gli abissi sotterranei in cerca di qualsiasi cosa che possa garantirgli un vantaggio militare. Grazie al suo potere di fuoco, questa versatile creatura è pronta a essere un incredibile robot che entrambe le fazioni vorranno al proprio fianco. . .

À medida que as tensões aumentam entre os Paladins e Templars, Duplicon, o intruso dominante assume os assuntos nas suas próprias mãos. Com a segurança de um lançador massivo, ele explora o subsolo mais profundo em busca de algo que possa propiciar poder militar. Com tal poder de fogo, esta criatura multifacetada está pronta para ser um assombro que ambas as facções desejarão do seu lado. . .





HYDRAX™

Hydrax™ Energy Level
 Nivel de energia Hydrax™
 Niveau d'énergie Hydrax™
 Hydrax™-Energiegrad
 Hydrax™ Krachtniveau
 Livello Energia Hydrax™
 Nivel de energia do Hydrax™



SKILL

Skill
 Técnica
 Technique
 Geschicklichkeit
 Bekwaamheid
 Specialità
 Habilidade



WEAPON

Weapon
 Arma
 Arme
 Waffe
 Wapen
 Arma
 Arma



DEFENSE

Defense
 Defensa
 Défense
 Verteidigung
 Verdediging
 Difesa
 Defesa

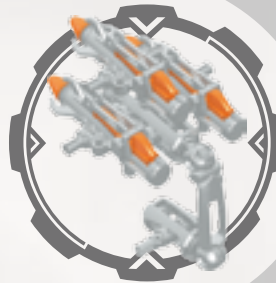

Orbital Multi-Launcher - penetrates underground bunkers with the brute force of hundred-kilogram rods traveling over 7,000 mph.

Orbital: penetra los bunkers subterráneos con la fuerza bruta de barras de cien kilogramos que viajan a más de 11.000 km/h.

Multi-lanceur orbital - pénètre dans des abris fortifiés souterrains avec la force brutale de barres de cent kilos filant à plus de 11 000 km/h.

Orbitaler Mehrfachwerfer - durchschlägt unterirdische Bunker mit der vollen Wucht von 100 kg schweren Geschossen, die mit über 11.000 km/h auftreffen.

Orbital Multi-Launcher - Penetreeet ondergrondse bunkers met de brute kracht van loodzware staalstaven die met een snelheid van meer dan 11.000 km p/u voortrazen.

Multi-Lanciamissili Orbitale - penetra i bunker sotterranei con la bruta forza di proiettili da un centinaio di chilogrammi sparati a più di 7.000 miglia all'ora.

Orbital Multi-Launcher - penetra os bunkers do subsolo com a força bruta de barras de cem quilos deslocando-se a mais de 11000 km/h.



Staff of Skandar - Tears through metals and impossibly hard objects with ease, leaving everything its path burning.

Barrenas de Skandar: atraviesan metales y destruyen objetos casi indestructibles con facilidad dejando a su paso todo en llamas.

L'équipement de Skandar - Défonce les métaux et les objets incroyablement durs avec facilité, incendiant tout sur son chemin.

Stab von Skandar - Durchbricht leicht Metalle und extrem harte Objekte und brennt dabei alles an.

De staf van Skandar - Doorklieft met gemak metalen en waanzinnig harde objecten en laat alles wat op zijn pad komt als een brandende puinhoop achter.

Bastone di Skandar - Squarcia con facilità metalli e altri oggetti estremamente duri, bruciando ogni cosa sul suo cammino.

Staff of Skandar - Penetra com facilidade os metais e os objectos extremamente duros, deixando tudo por onde passa queimado



Axle Spinner - Discharges an electromagnetic pulse that disables all electronics within a 100m diameter of the Spinner. A direct impact by the Spinner results in a powerful release of hydrogen causing enormous damage.

Eje giratorio - Descarga un pulso electromagnético que inhabilita todos los dispositivos electrónicos dentro de un diámetro de 100 mts del eje giratorio. Un impacto directo del eje giratorio puede producir una fuerte fuga de hidrógeno causando grandes daños.

Tourbillon à pivot - décharge une impulsion électromagnétique qui désactive tous les dispositifs électroniques à l'intérieur d'un diamètre de 100 m. Un impact direct du tourbillon dégage une forte quantité d'hydrogène causant des dommages gigantesques.

Achsen-Wirbler - Stoßt einen elektromagnetischen Impuls aus, der alle elektronischen Geräte in 100 m Umkreis deaktiviert. Ein Voltreffer durch den Wirbler führt zur Freigabe von Wasserstoff und erzeugt enorm viel Schaden.

Axle Spinner - Ontlaadt een elektromagnetische stroomstoot die alle elektronica binnen een straal van 100 m van de Spinner in waardeloze rommel verandert. Bij elke rechtstreekse klap van de Spinner komt een wolk waterstofgas vrij met een verwoestende werking op de omgeving.

Rotatore Assiale - Emette un impulso elettromagnetico che mette fuori uso tutti gli apparecchi elettronici nel raggio di 100 m. Un colpo diretto del Rotatore rilascia idrogeno causando danni enormi.

Axle Spinner - Descarrega um impulso electromagnético que neutraliza todos os dispositivos electrónicos num diâmetro de 100 m do Spinner. Um impacto directo pelo Spinner resulta numa poderosa libertação de hidrogénio provocando enormes danos.



24. ft.
7.3 m.

Ø2 ft.
.6 m.



4. ft.
1.2 m.



6. ft.
1.8 m.



Ø11.3 ft.
3.4 m.



- 2x
AM01793KJ
- 1x
AM09877F
- 1x
AM09785JS
- 1x
AM09784JS
- 2x
AS063807
- 2x
AM09806KJ
- 1x
AM09765JS
- 1x
AS0638011
- 2x
AM09738KJ
- 2x
AS063808

- 1x
AM09797JS
- 1x
AM09770JS
- 1x
AM09757JS
- 1x
AM09759JS
- 1x
AS0638020
- 1x
AS0638019

- 1x
AS063806
- 1x
AS063805
- 1x
AS063802
- 1x
AS063801
- 1x
AS0638023

- 1x
AS0638012
- 1x
AS0638017
- 1x
AM16213NW
- 1x
AM09808NW
- 1x
AS063804
- 1x
AM09810KJ

- 1x
AM09763JS
 - 1x
AM09761JS
 - 2x
AM09734KJ
 - 2x
AM09731F
 - 2x
AM09727F
 - 2x
AM09731KJ
 - 1x
AM09727KJ
 - 2x
AX063802
 - 2x
AX063803
 - 2x
AM09733KJ
- 1.315" - 3.492 cm
- 2.125" - 5.397 cm

- 1x
AM15303JS
- 3x
AS063809
- 1x
AS0638010
- 1x
AM09788NW
- 3x
AS0638022
- 2x
AM16212KJ
- 1x
AS063803
- 2x
AM09767JS

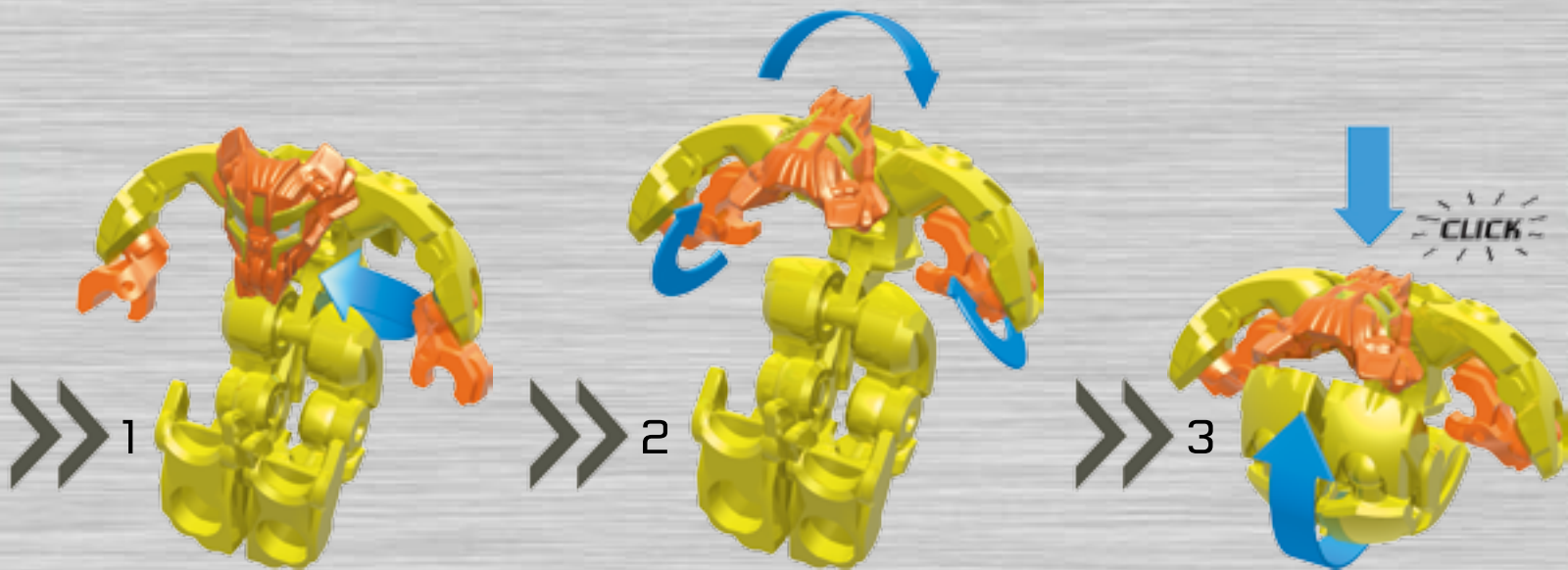

1



2

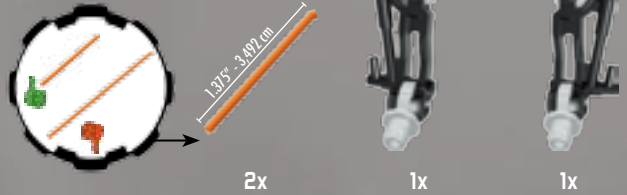

6

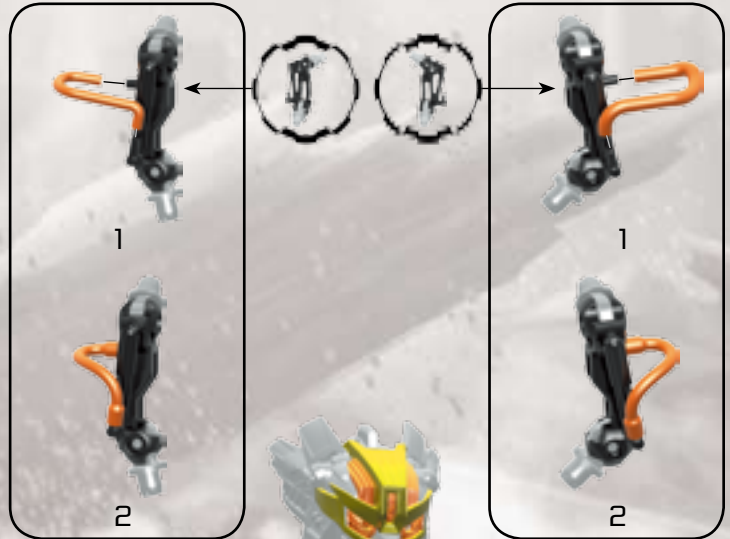
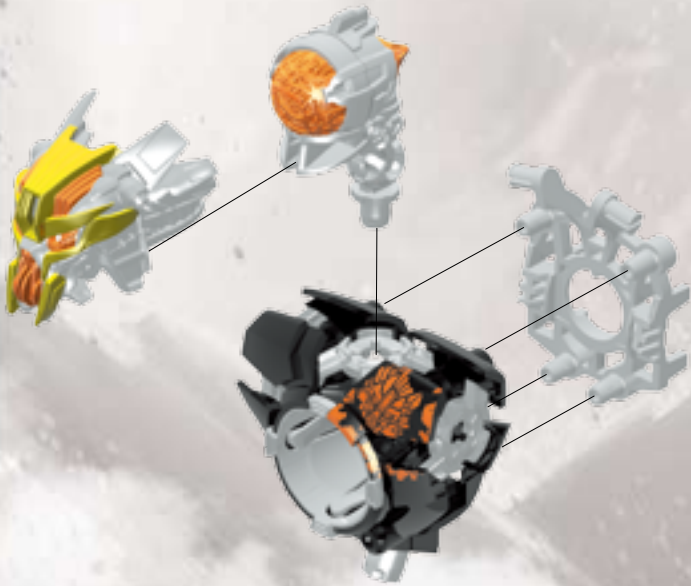

3



2x



2x



2x

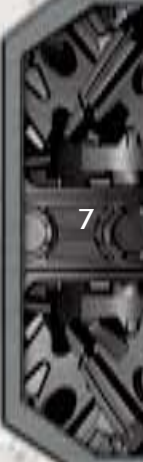
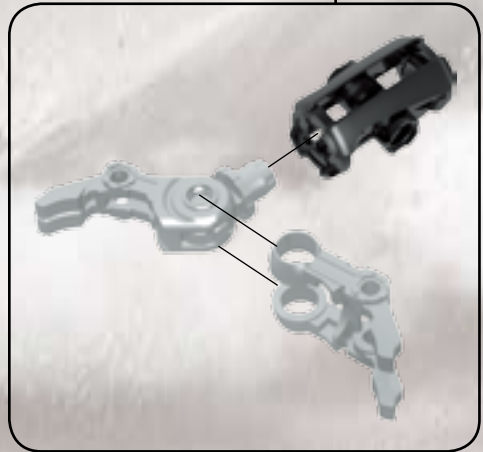
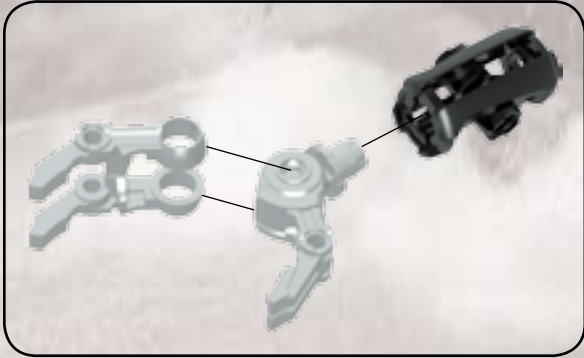

7

4



1x

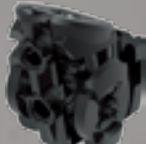

1x

8

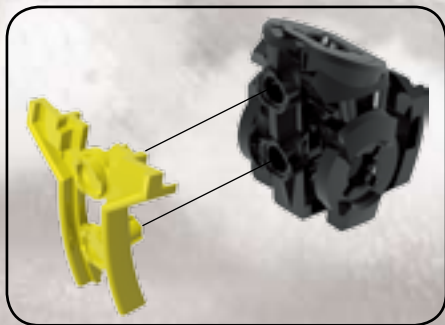

5

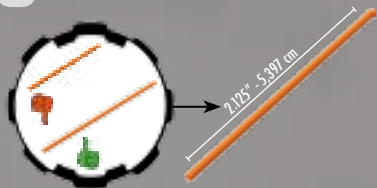

2x

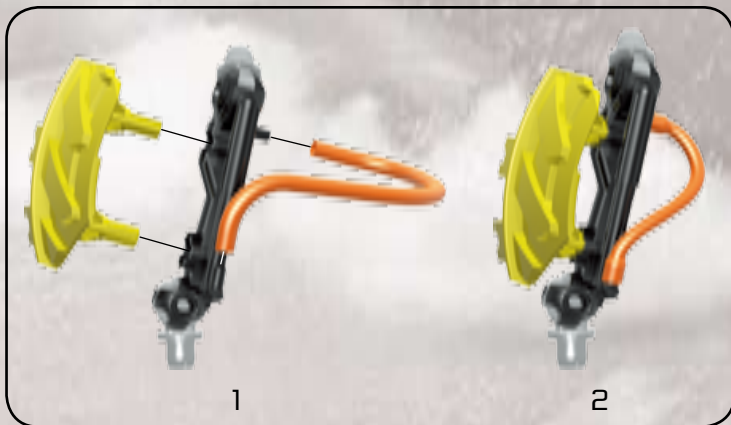
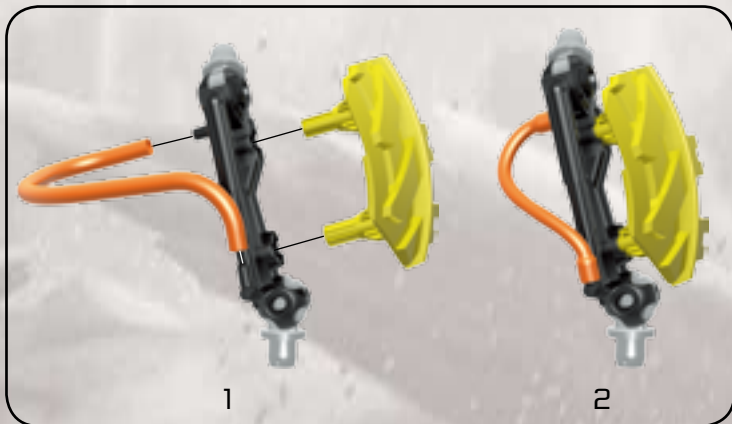

6



2x



2x



1x



1x

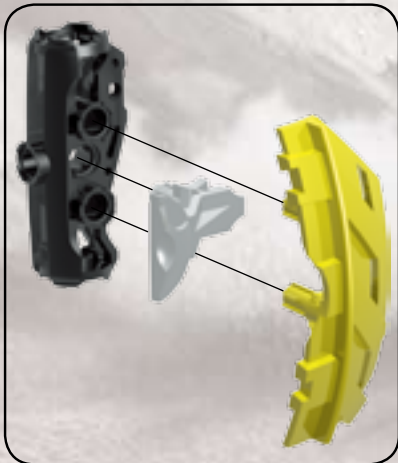
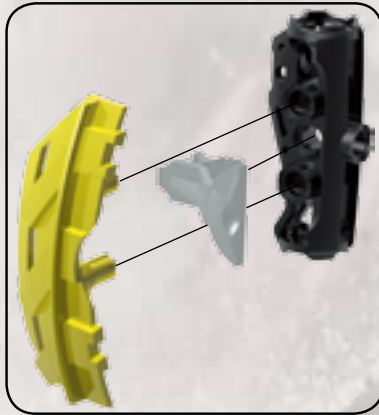

10

7



2x



2x



1x



1x



2x

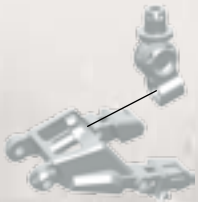

1

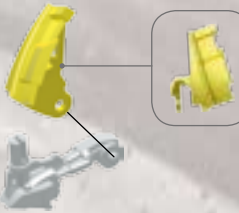

2



3



1

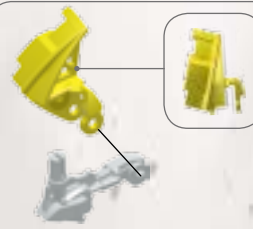

2



3

8



1x

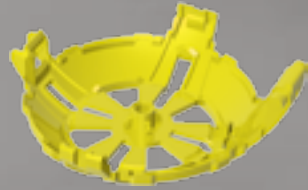

2x



stretch before using
estiralo antes de usarlo
étirer avant utilisation
vor Gebrauch dehnen
uitrekken voor gebruik
allungare prima dell'uso
esticar antes de usar

12

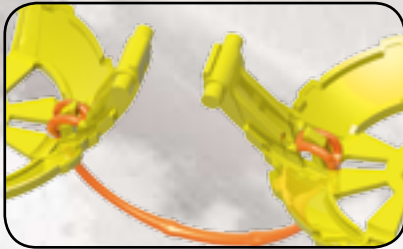
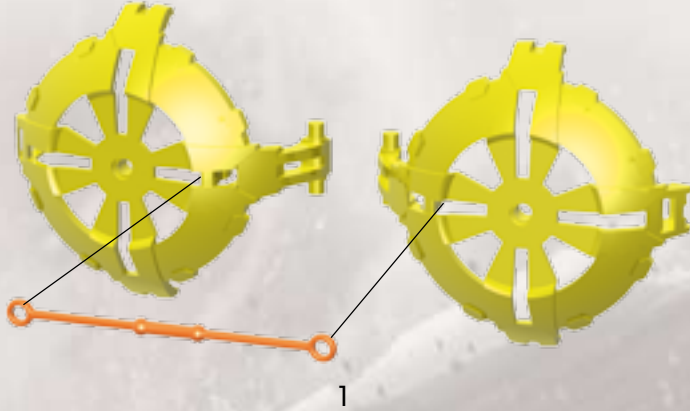

2

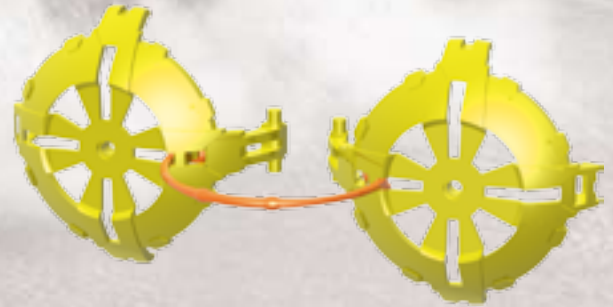

3

9



1x



10



13



- ⓘ Adult assistance may be required.
- ⓘ Puede ser necesaria la ayuda de un adulto.
- ⓘ L'assistance d'un adulte peut être requise.
- ⓘ Hilfe eines Erwachsenen kann erforderlich sein.
- ⓘ De hulp van een volwassene kan nodig zijn.
- ⓘ L'assistenza di un adulto può essere necessaria.
- ⓘ Assistència por um adulto poder ser necessária.

11



12



14



13



1x



1x

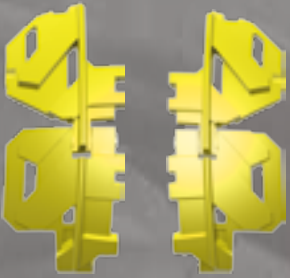

1x

1x



15

14



1x



1x



1x



16

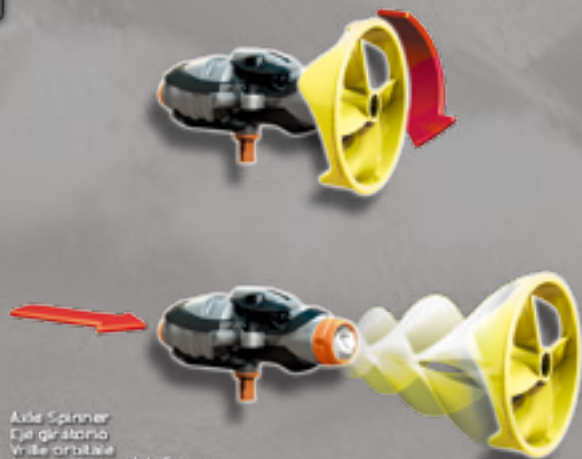

Axis Spinner
Cyl giratorio
Welle orbitale
Achsen-Wirler / Axis Spinner
Rotazione Assiale / Axis Spinner

15

1



17



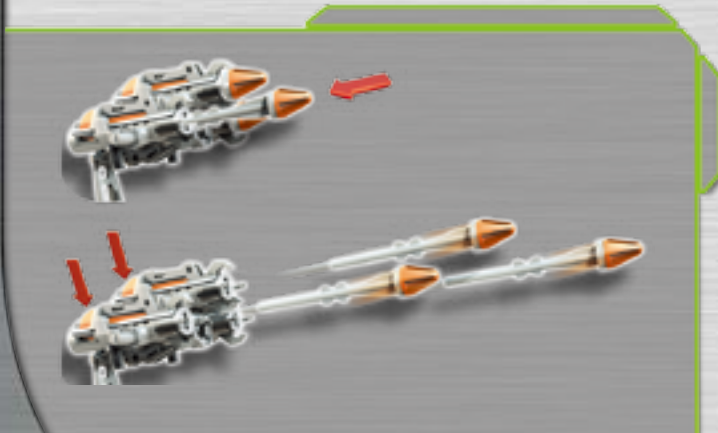
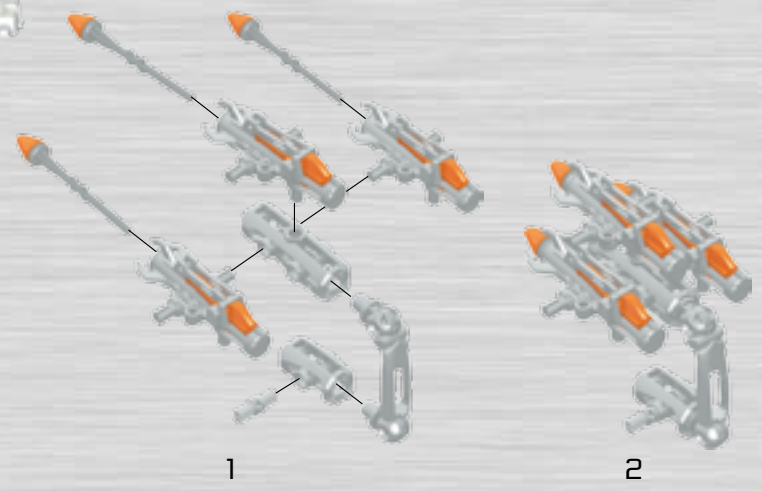
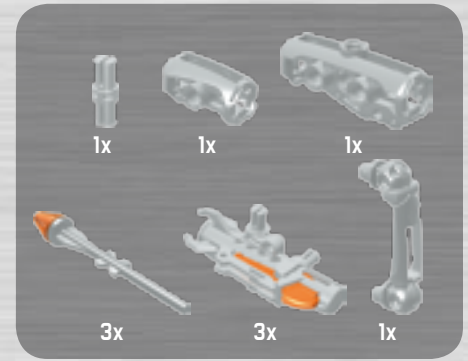



3

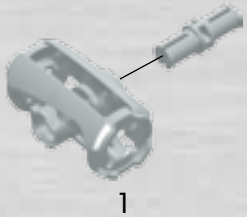
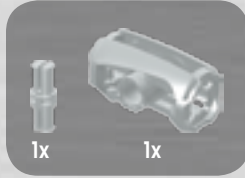

1



2



4

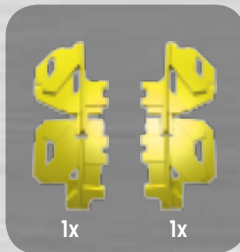

1x

1x

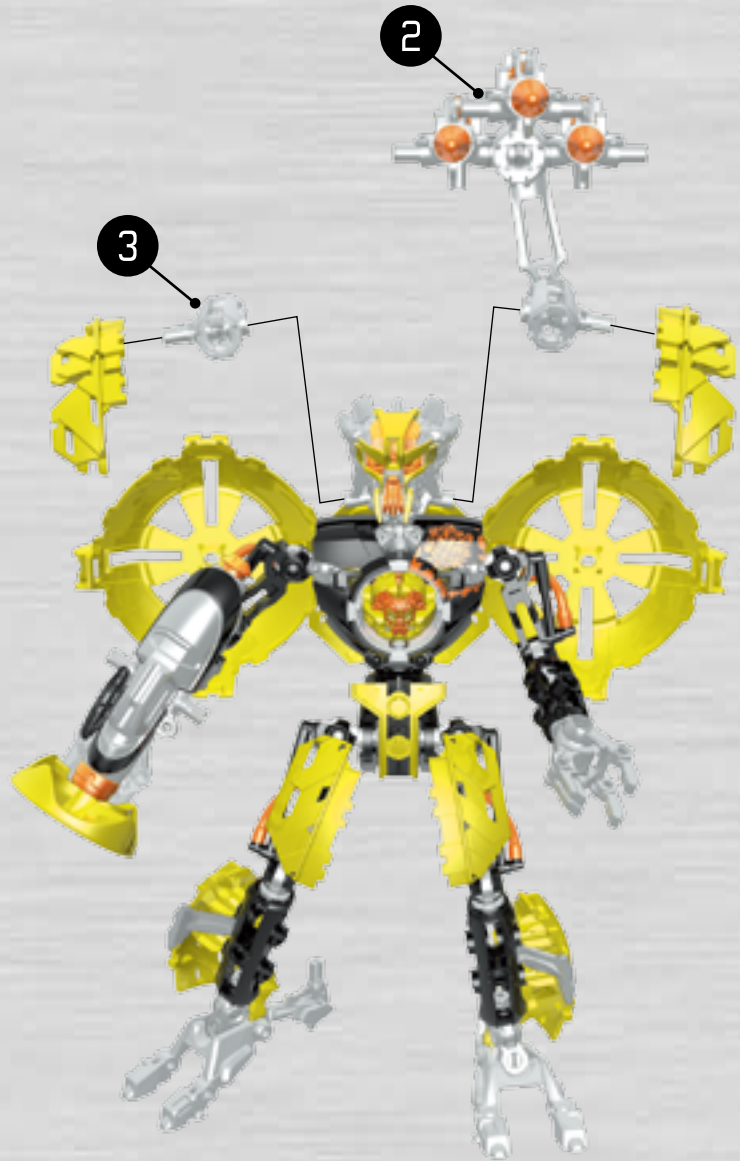

2

3



5

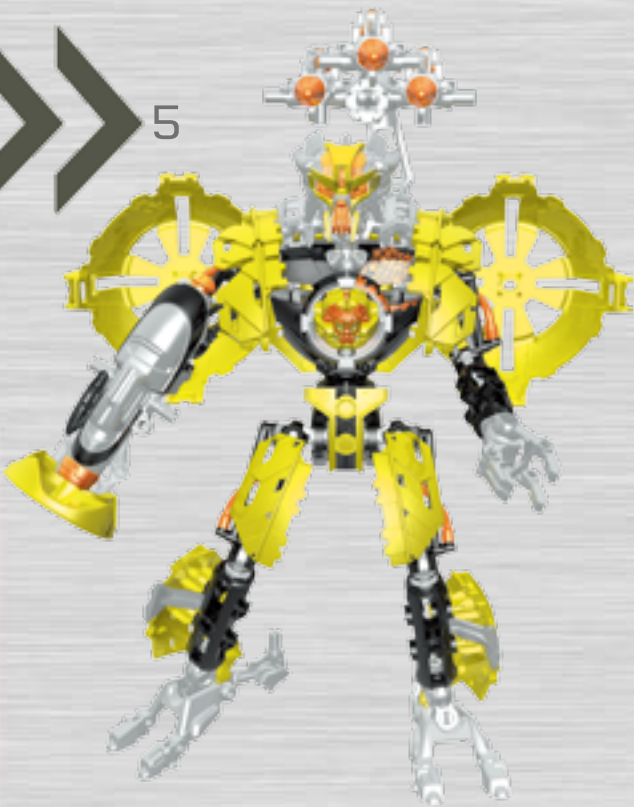

6

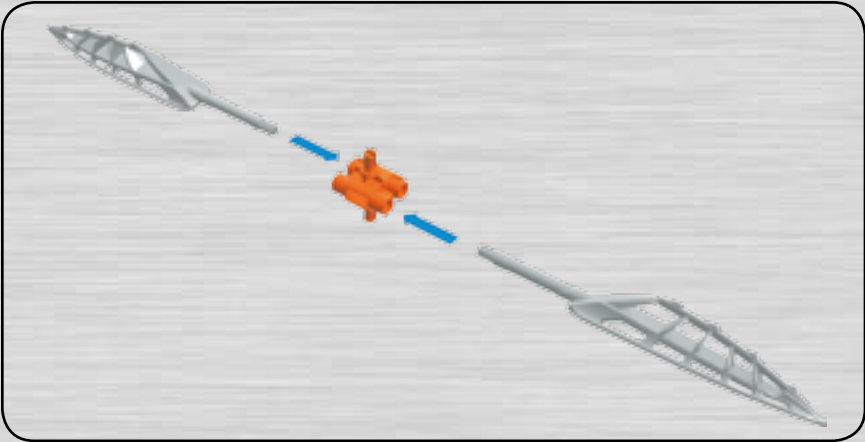
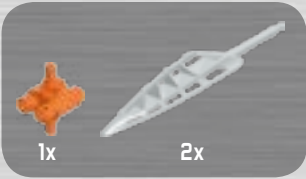

20

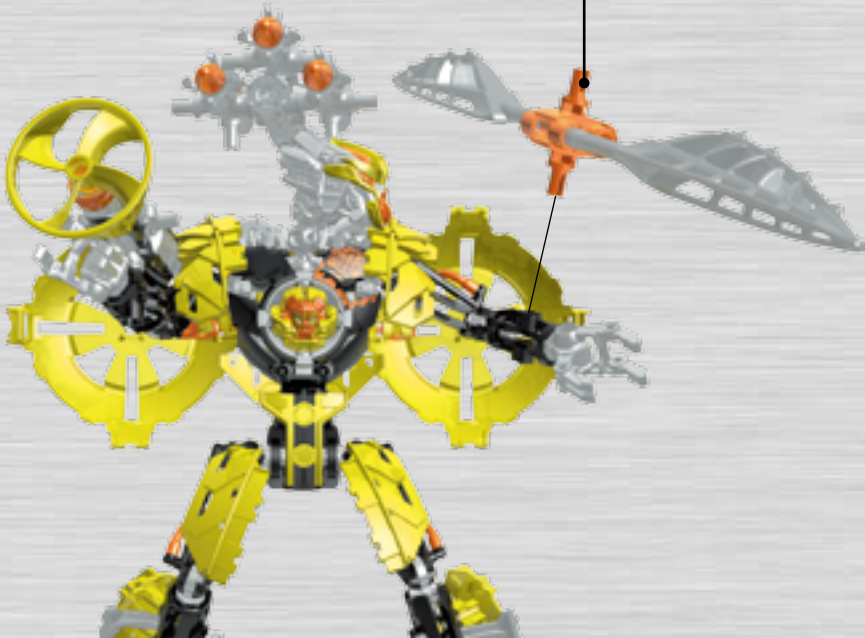



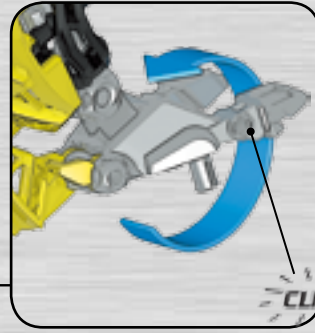

1



2

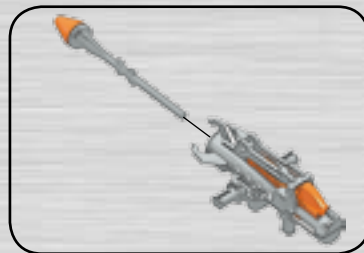

3

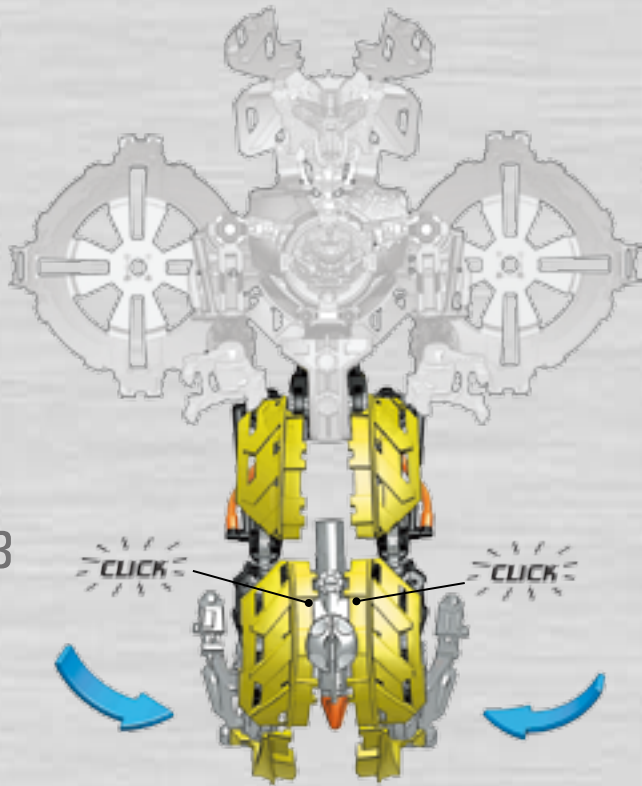

4

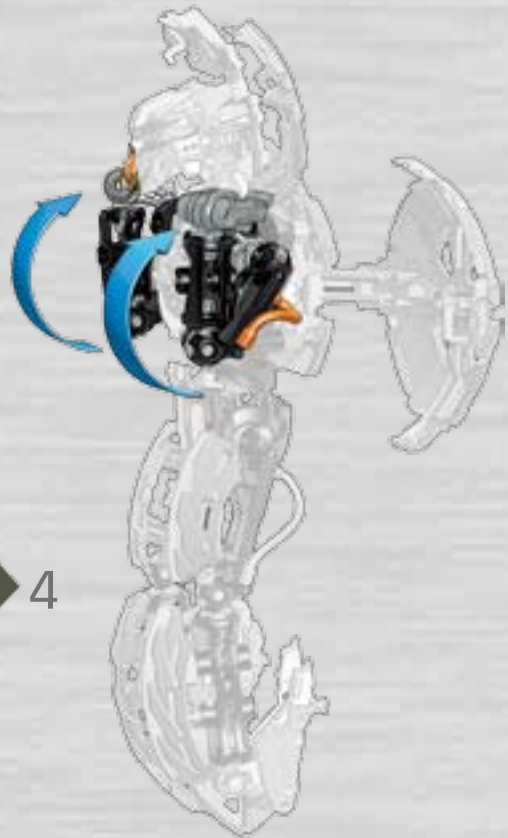

5

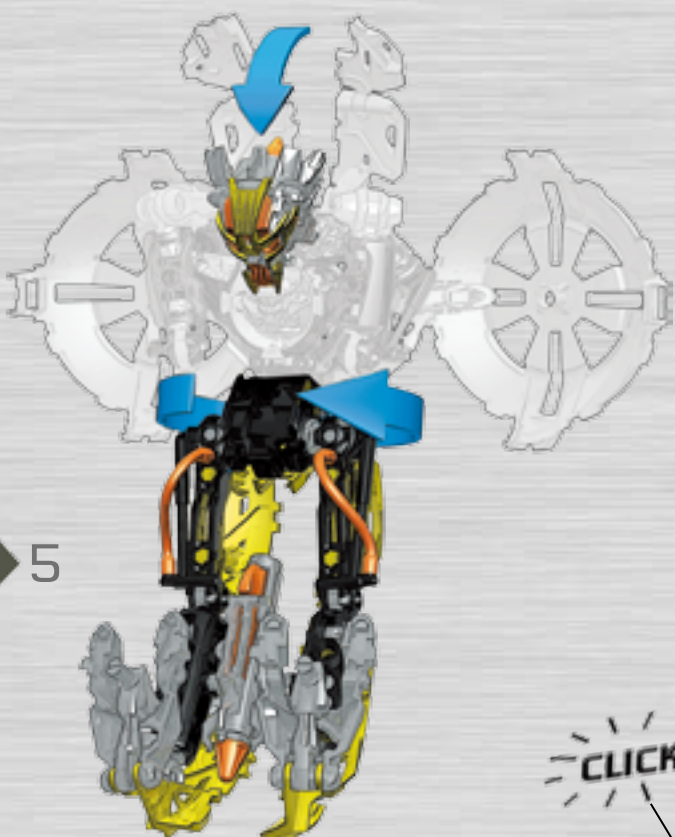

6

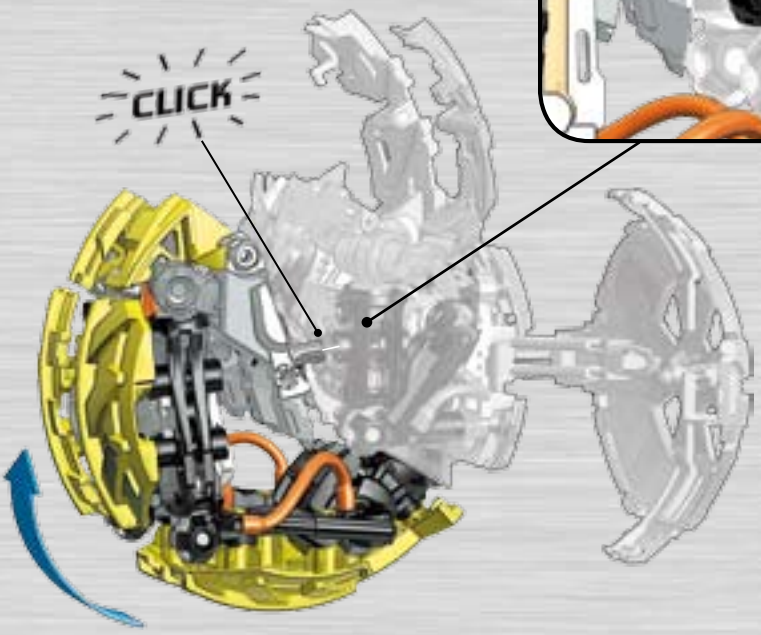

7

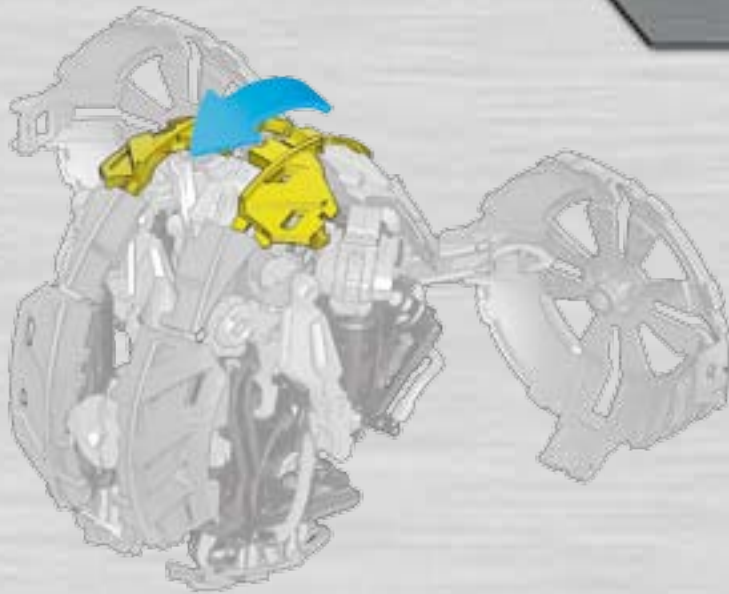

8

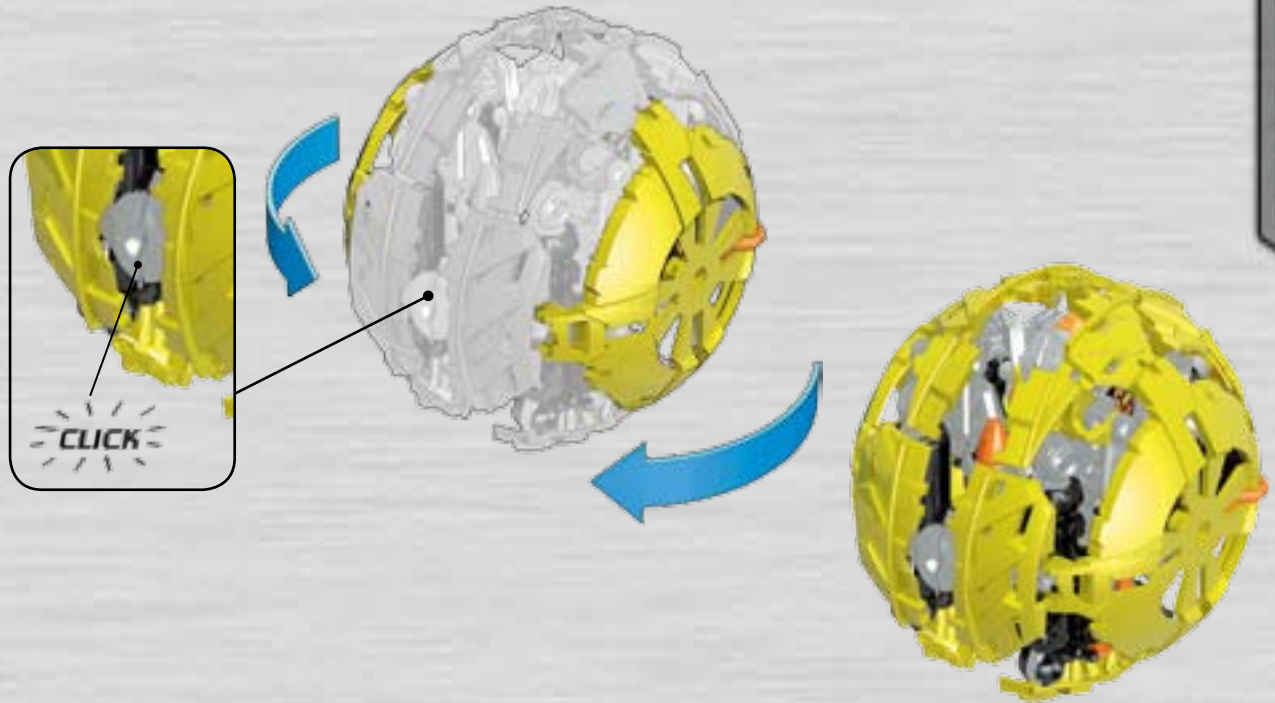

ⓘ Please read these instructions carefully before first use and keep them for future reference. / ⓘ Leer estas instrucciones cuidadosamente antes de la primera utilización y guardarlas para referencia futura. / ⓘ Il est recommandé de lire attentivement ce feuillet avant la première utilisation et de le conserver pour référence future. / ⓘ Die Gebrauchsanleitung bitte durchlesen und aufbewahren. / ⓘ Wij raden u aan deze handleiding zorgvuldig te lezen en te bewaren voor eventuele raadpleging op een later tijdstip. / ⓘ Leggere le istruzioni prima di cominciare ad usare il gioco e conservarle per referenze future. / ⓘ Leia as instruções antes do primeiro uso e guarde-as para futura referência.

EN ⚠ **WARNING:**
CHOKING HAZARD. - Small parts.
Not for children under 3 years.

ES ⚠ **ADVERTENCIA:**
PELIGRO DE ASFIXIA. - Contiene
piezas pequeñas.
No recomendado para niños menores de 3 años.

FR ⚠ **AVERTISSEMENT:**
RISQUE DE SUFFOCATION. - Présence de
petits éléments.
Ne convient pas aux enfants de moins de 3 ans.

DE ⚠ **WARNUNG:**
ERSTICKUNGSGEFAHR. - Enthält kleine Teile.
Nicht für Kinder unter 3 Jahren geeignet.

NL ⚠ **WAARSCHUWING:**
VERSTIKKINGSGEVAAR. - Bevat
kleine onderdelen.
Niet geschikt voor kinderen onder de 3 jaar.

DA ⚠ **ADVARSEL:**
KVÆLNINGSFARE. - Indeholder smådele.
Ikke til børn under 3 år.

EL ⚠ **ΠΡΟΕΙΔΟΠΟΙΗΣΗ:**
ΚΙΝΔΥΝΟΣ ΠΝΙΞΙΜΑΤΟΣ. - Περιέχει μικρά
αντικείμενα.
Όχι για παιδιά κάτω των 3 ετών.

FI ⚠ **VAROITUS:**
TUKEHTUMISVAARA. - Sisältää pieniä osia.
Ei alle 3-vuotiaalle lapsille.

IT ⚠ **ATTENZIONE:**
PERICOLO DI SOFFOCAMENTO. - Contiene
piccole parti.
Non indicato per bambini sotto i 3 anni.

NO ⚠ **ADVARSEL:**
KVÆLNINGSFARE. - Inneholder små deler.
Kun for barn over 3 år.

PT ⚠ **ATENÇÃO:**
PERIGO DE ASFIXIA. - Contém peças pequenas.
Não é concebido para crianças de menos
de 3 anos.

SV ⚠ **VARNING:**
KVÄVNINGSRISK. - Innehåller små delar.
Inte för barn under 3 år.

JA ⚠ **警告:**
窒息の危険性 - 小さな部品が含まれています
3歳以下の子供には与えないで下さい。

ZH ⚠ **警告:**
有窒息危險。 - 包含有小部件
不适合3岁以下的小孩玩。

AR ⚠ **تحذير:**
خطر اختناق - قطع صغيرة.
غير صالحة للأطفال أقل من 3 سنوات.

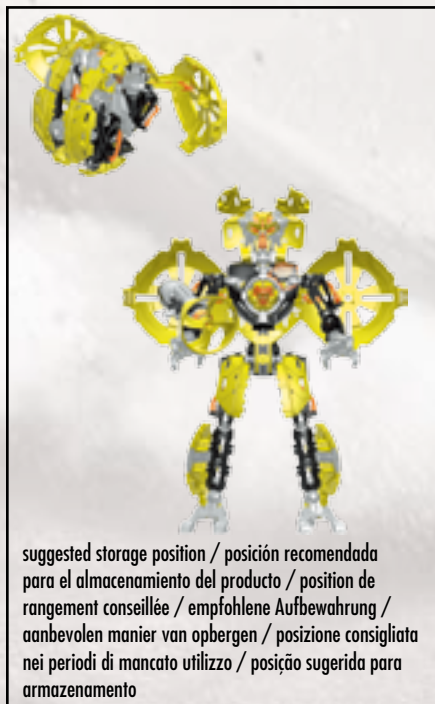

EN Latex free toy.
ES Juguete sin látex.
FR Jouet sans latex.
DE Latexfreies Spielzeug.
NL Speelgoed vrij van latex.
DA Dette legetøj indeholder ikke latexgummi.
EL Παιχνίδι χωρίς λάτεξ.
FI Lelu ei sisällä lateksia.
IT Non contiene latex.
NO Lateks fri leketøy.
PT Brinquedo sem conteúdo de latex.
SV Leksak utan latex.
JA この玩具にはラテックスは使用されていません。
ZH 無乳膠玩具。
AR لعبة خالية من مادة اللاتكس

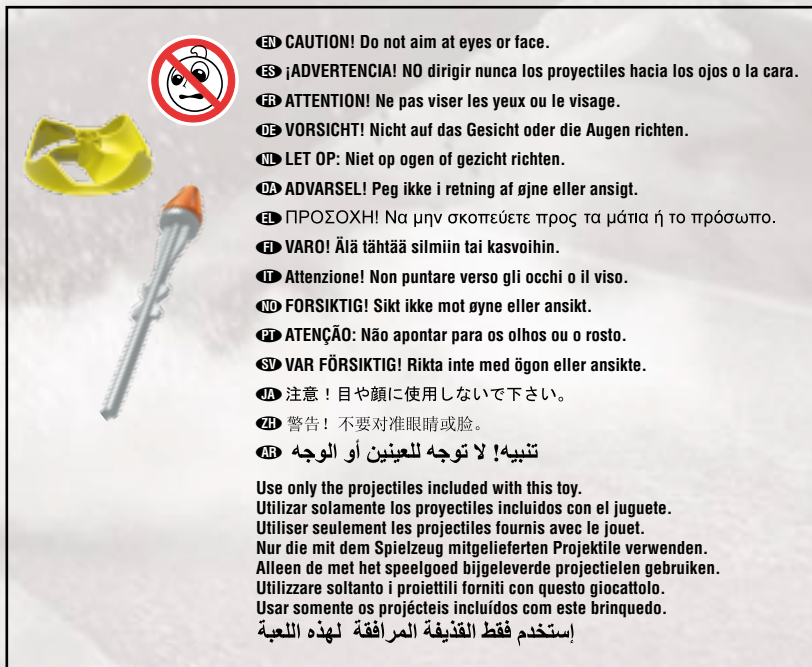



NEO SHIFTERS



Axle Spinner
Eje giratorio
Vrille orbitale
Achsen-Wirbler / Axle Spinner
Rotatori Assiale / Axle Spinner



Orbital Multi-Launcher
Multi-Lanzador Orbital
Multi-lanceur orbital
Orbitaler Mehrfachwerfer / Orbital Multi-Launcher
Multi-Lanzierer Orbital / Orbital Multi-Launcher



Shifts
Se transforma
Se transforme
Verwandelt sich
Transformeert
Si trasforma
Transforma-se

Also available
Também disponível / Egalement disponible
Dienfalls erhältlich / Dienens beschikbaar
Anche disponibile / Também disponível



Staff of Skandar
Barreras de Skandar
Lance de Skandar
Slab von Skandar
De staf van Skandar
Blasione di Skandar
Staff of Skandar



Additional purchases required to collect all elements shown. / Para coleccionar todos los elementos mostrados se precisa realizar unas compras adicionales. / Des achats additionnels sont nécessaires afin d'obtenir tous les articles de la collection illustrés. / Um alle dargestellten Elemente zu sammeln sind zusätzliche Käufe erforderlich. / Verderre aankopen zijn nodig om alle afgebeelde artikelen te verzamelen. / Acquisti supplementari necessari per collezionare tutti gli elementi illustrati. / Compras adicionais são necessárias para coleccionar todos os elementos exibidos.



© 2008, MEGA Brands Inc. ® and ™ denote trademarks of MEGA Brands Inc. This toy

conforms to: Voluntary Product Standard F963 U.S., Canadian Hazardous Products Act, CEN Standards E.N. 71. Products and colors may vary. ® and ™ designan la marca registrada y la marca comercial de MEGA Brands Inc. Este juguete es de conformidad con: Voluntary Product Standard F963 U.S., Canadian Hazardous Products Act, CEN Standards E.N. 71. Las piezas y los colores pueden variar. ® et ™ désignent des marques de commerce de MEGA Brands Inc. Ce jouet est conforme aux: Voluntary Product Standard F963 U.S., Canadian Hazardous Products Act, CEN Standards E.N. 71. Les items et les couleurs peuvent varier. ® und ™ sind Markenzeichen der Firma MEGA Brands Inc. Dieses Spielzeug stimmt mit: Voluntary Product Standard F963 U.S., Canadian Hazardous Products Act, CEN Standards E.N. 71. In producten en kleuren kan variatie optreden. ® e ™ indicano dei marchio depositato di MEGA Brands Inc. Questo giocattolo è conforme a : Voluntary Product Standard F963 U.S., Canadian Hazardous Products Act, CEN Standards E.N. 71. Prodotti e colori possono variare. ® e ™ denotam marcas registradas de MEGA Brands Inc. Este brinquedo conforma-se ao Produto Padrão Voluntário F963 EE.UU., Decreto Canadense de Produtos Perigosos, Padrões CEN, E.N. 71. Produtos e cores podem variar.
Printed in China AD063801

WWW.NEOSHIFTERS.COM