

# MEGA BLOKS®

## COMMAND OPS

Build the ultimate adventure system and command land, sea, and air special operation forces. Heroic Command Ops take on covert missions allowing the protection and capture of hi-tech weapons from the menacing X-Ops forces in order to secure the future.

Crea el imbatible sistema de aventura y de comando supremo de fuerzas armadas especiales aéreas, marítimas y terrestres. Heroicos Command Ops cumplen misiones ultrasecretas con el fin de proteger y capturar armas de alta tecnología de las feroces tropas X-Ops para salvaguardar el porvenir.

Construisez un système d'aventure et de commande suprême des forces aériennes, maritimes et terrestres. Des Command Ops héroïques abordent des missions clandestines pour protéger et capturer des armes de haute technologie des forces X-Ops afin de protéger le futur.

Bouw het uiterste adventuresysteem en voer het bevel over speciale land- zee- en luchtmachtstrijdkrachten. Heldhaftige Command Ops ondernemen geheime missies voor het beveiligen en buitmaken van high-tech wapens van de dreigende X-Ops strijdkrachten om de Toekomst Veilig te stellen.

### 5522

### Secret Case Capture



### 6+

Ages/Edades  
Åges/Leeftijden

### 225

Pieces/Piezas  
Pièces/Stuks

**COLLECT THEM ALL!**  
**¡COLECCIONALOS TODOS!**  
**COLLECTIONNE-LES TOUS!**  
**VERZAMEL ZE ALLEMAAL!**



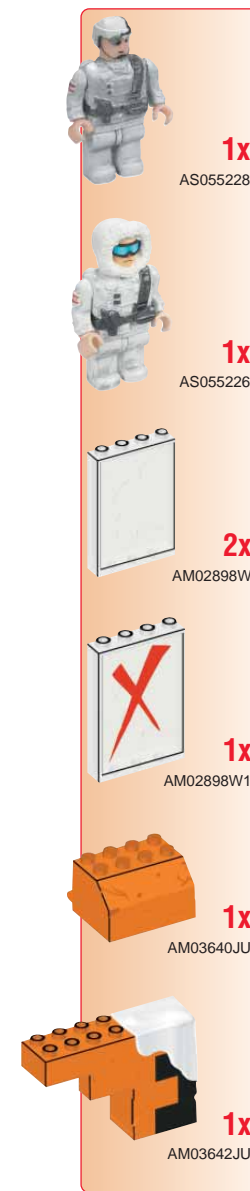
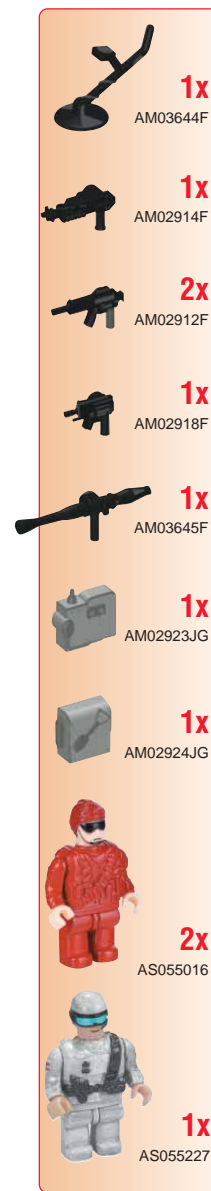
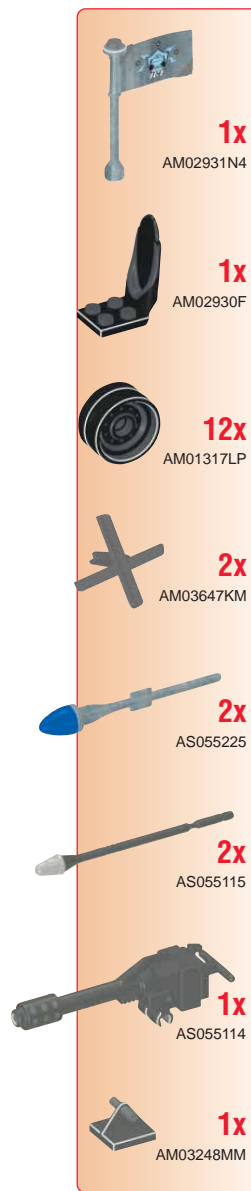
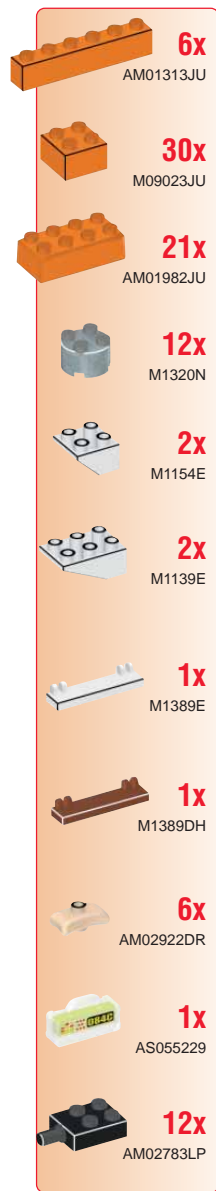
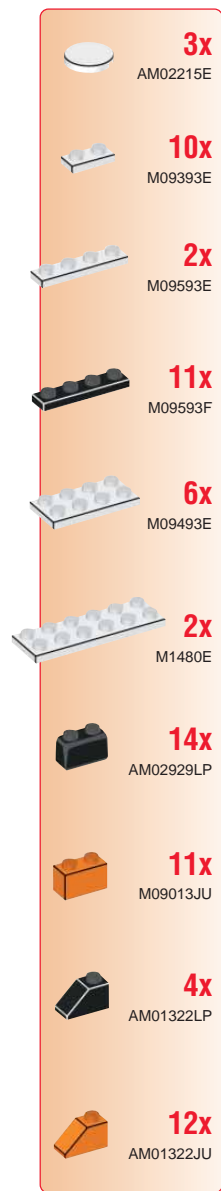



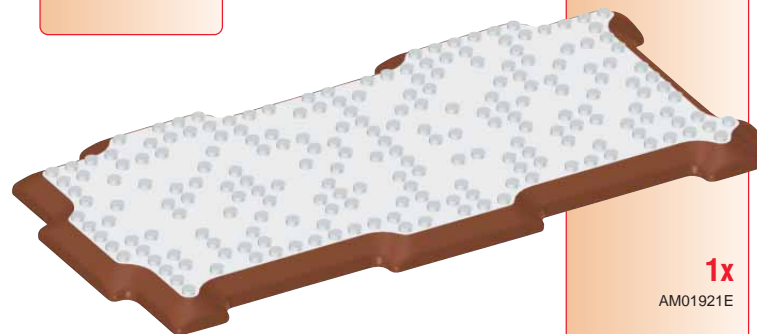
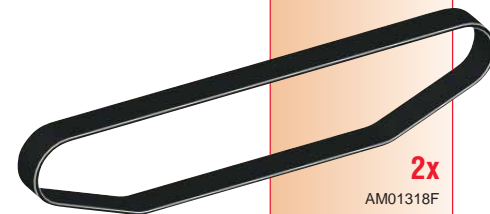
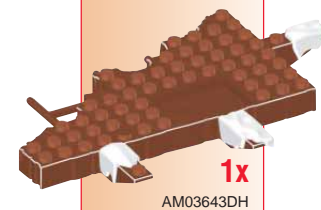
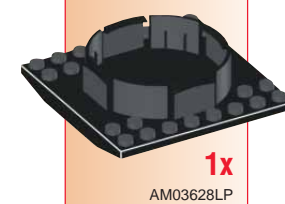
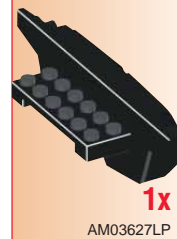
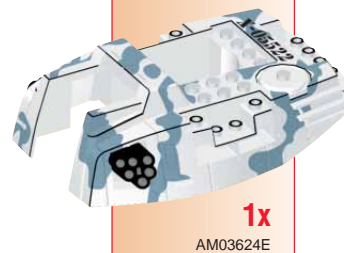
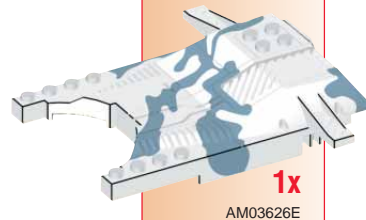
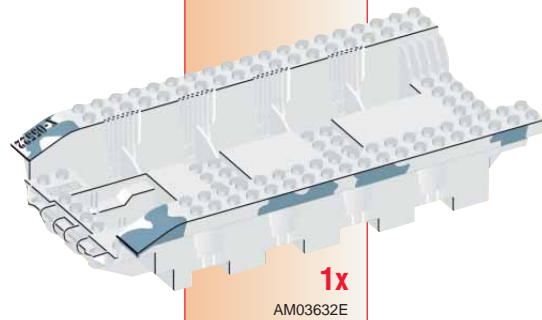
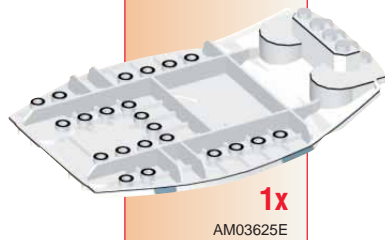
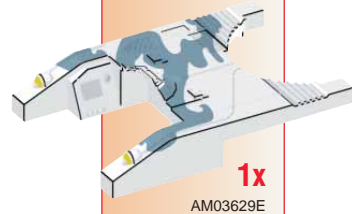
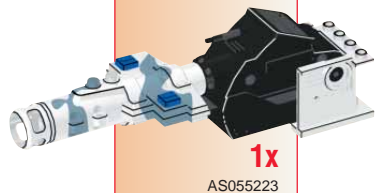
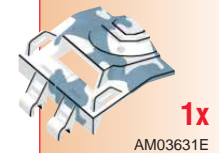
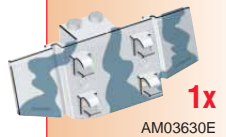
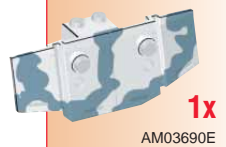
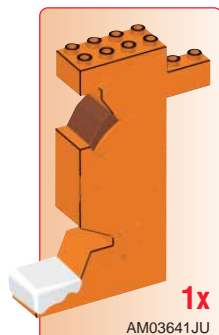

SECRET CASE CAP



Color chart.

Cuadro cromático-

Carte de couleurs.

Färgtabell.

Kleurenkaart.

Quadro cromatico.

カラーチャート

色彩表

Active step / Etapa activa / Étape active / Aktivt skede  
Active step / Azione attiva / アクティブなステップ / 積極步驟

Previous step / Etapa precedente / Étape précédente  
Föregående skedet / Vorige stap / Azione precedente  
前のステップ / 上一步驟



Active step / Etapa activa / Étape active / Aktivt skede  
Active step / Azione attiva / アクティブなステップ / 積極步驟

Previous step / Etapa precedente / Étape précédente  
Föregående skedet / Vorige stap / Azione precedente  
前のステップ / 上一步驟



Please read these instructions carefully before first use and keep them for future reference.

Leer estas instrucciones cuidadosamente antes de la primera utilización y guardarlas para referencia futura.

Il est recommandé de lire attentivement ce feuillet avant la première utilisation et de le conserver pour référence future.

Wij raden u aan deze handleiding zorgvuldig te lezen en te bewaren voor eventuele raadpleging op een later tijdstip.

**EN** ⚠️ **WARNING:**  
**CHOKING HAZARD.** - Small parts.  
Not for children under 3 years.

**ES** ⚠️ **ADVERTENCIA:**  
**PELIGRO DE ASFIXIA.** - Contiene piezas pequeñas.  
No recomendado para niños menores de 3 años.

**FR** ⚠️ **AVERTISSEMENT:**  
**RISQUE DE SUFFOCATION.** - Présence de petits éléments.  
Ne convient pas aux enfants de moins de 3 ans.

**NL** ⚠️ **WAARSCHUWING:**  
**VERSTIKKINGSGEVAAR.** - Bevat kleine onderdelen.  
Niet geschikt voor kinderen onder de 3 jaar.

**DE** ⚠️ **WARNING:**  
**ERSTICKUNGSGEFAHR.** - Enthält kleine Teile.  
Nicht für Kinder unter 3 Jahren geeignet.

**DA** ⚠️ **ADVARSEL:**  
**KVELNINGSFARE.** - Indeholder smådele.  
Ikke til børn under 3 år.

**EL** ⚠️ **ΠΡΟΕΙΔΟΠΟΙΗΣΗ:**  
**ΚΙΝΔΥΝΟΣ ΠΝΙΞΙΜΑΤΟΣ.** - Περιέχει μικρά αντικείμενα  
Όχι για παιδιά κάτω των 3 ετών.

**FI** ⚠️ **VAROITUS:**  
**TUKEHTUMISVAARA.** - Sisältää pieniä osia.  
Ei alle 3-vuotiaalle lapsille.

**IT** ⚠️ **ATTENZIONE:**  
**PERICOLO DI SOFFOCAMENTO.** - Contiene piccole parti.  
Non indicato per bambini sotto i 3 anni.

**NO** ⚠️ **ADVARSEL:**  
**KVELNINGSFARE.** - Inneholder små deler.  
Kun for barn over 3 år.

**PT** ⚠️ **ATENÇÃO:**  
**PERIGO DE ASFIXIA.** - Contém peças pequenas.  
Não é concebido para crianças de menos de 3 anos.

**SV** ⚠️ **WARNING!**  
**KVÄVNINGSRISK.** - Innehåller små delar.  
Inte för barn under 3 år.

**JA** ⚠️ **警告:**  
窒息の危険性 小さな部品が含まれています  
3歳以下の子供には与えないで下さい。

**ZH** ⚠️ **警告:**  
有窒息危險。包含有小部件  
不适合3岁以下的小孩玩。





Page / Páginá / Page / Bladzij 6



Page / Páginá / Page / Bladzij 7

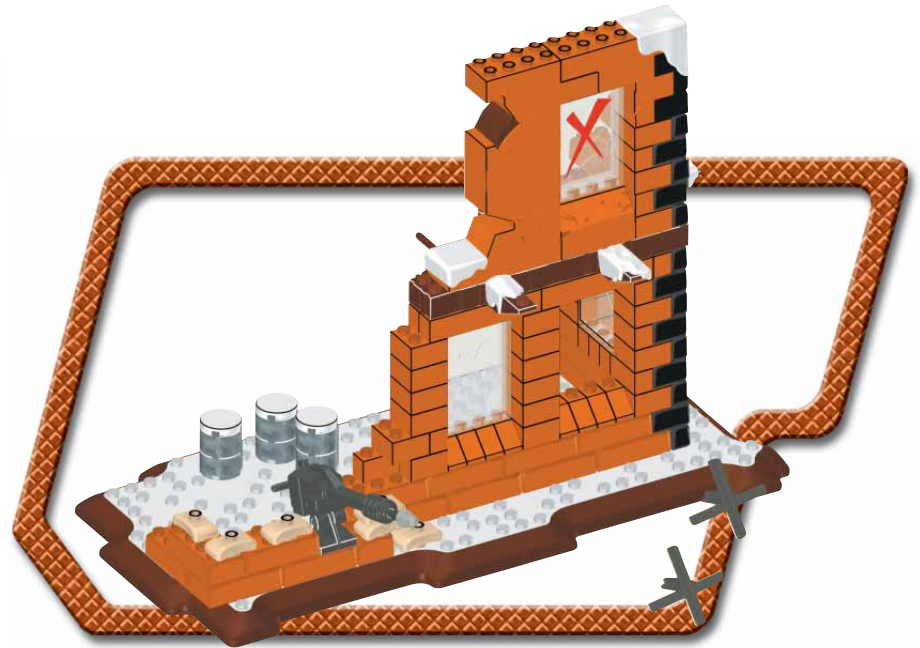

Page / Páginá / Page / Bladzij



# COMMAND OPS™



*INCLUDES 5 FIGURES    INCLUYE 5 FIGURITAS*  
*5 FIGURINES INCLUSES    5 FIGUURTJES INBEGREPEN*



1



2



3



1



2

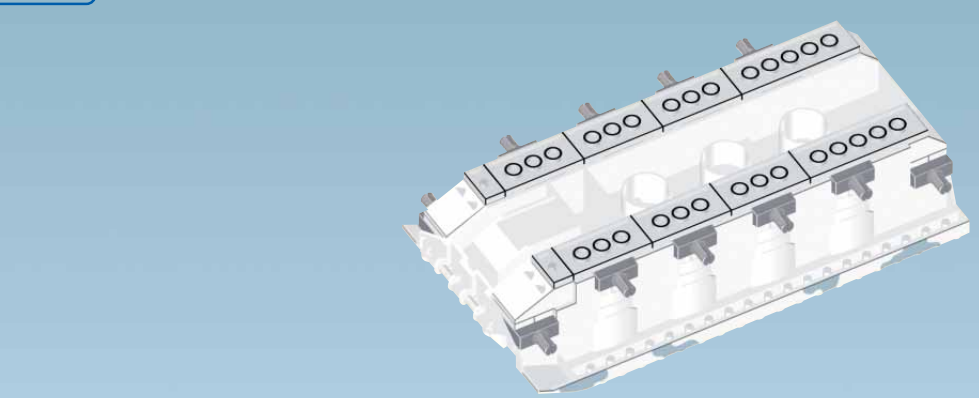
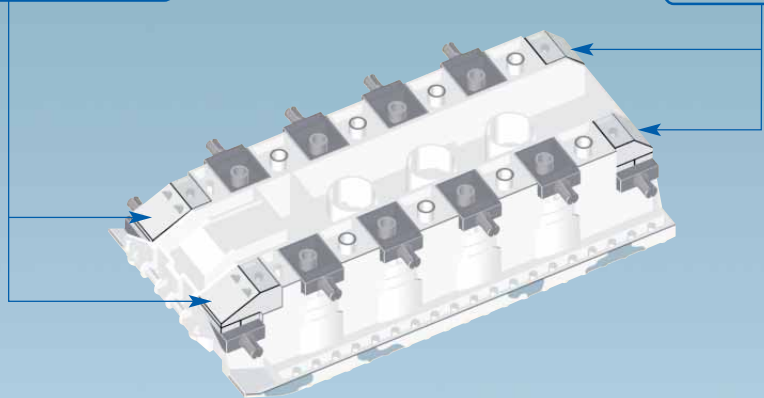
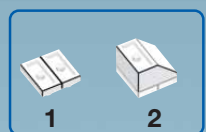
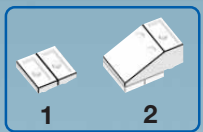
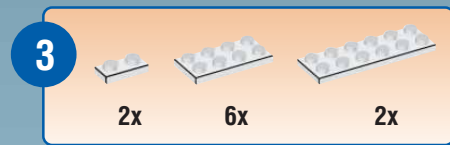
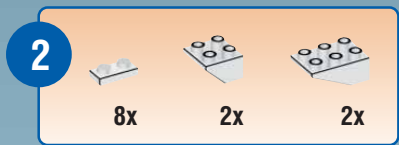
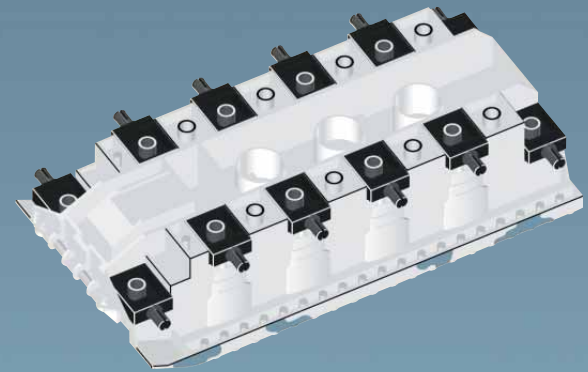
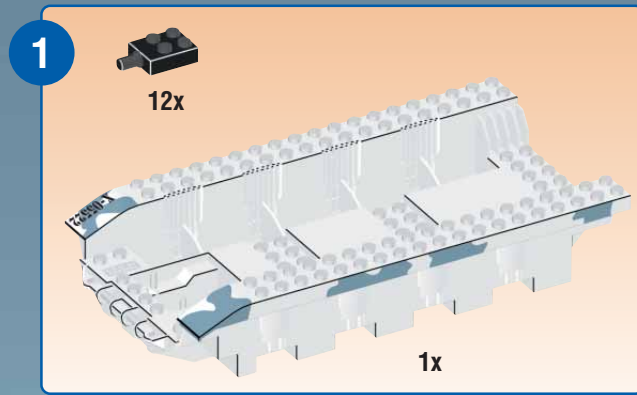

4



5x

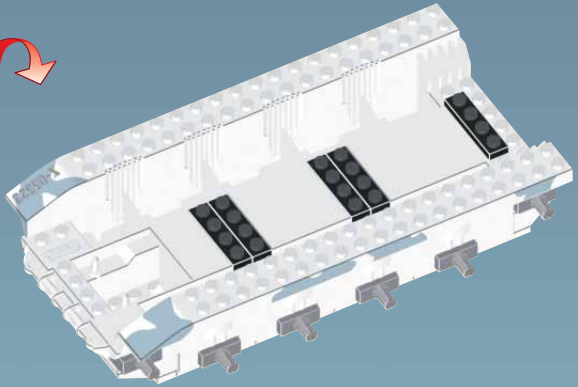

5



2x

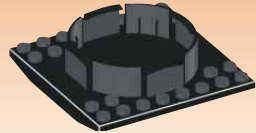

1x

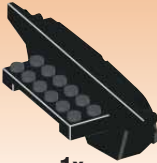

1x

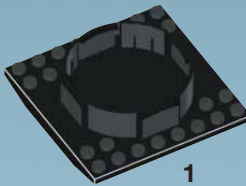

1

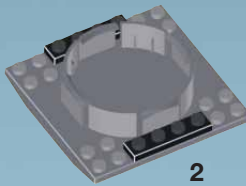

2

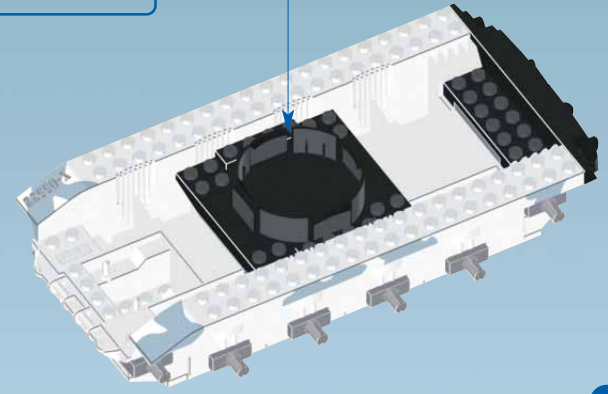



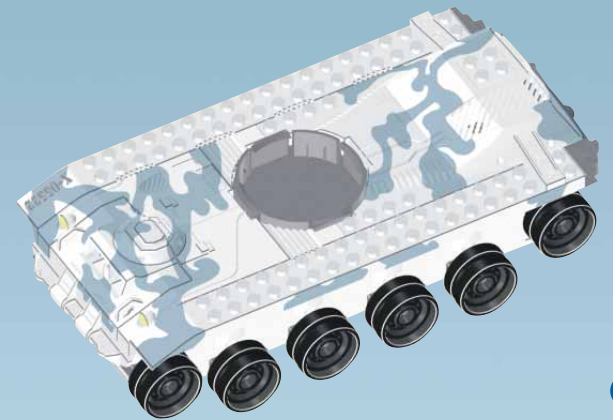
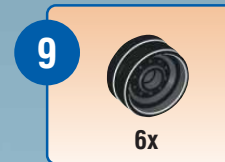
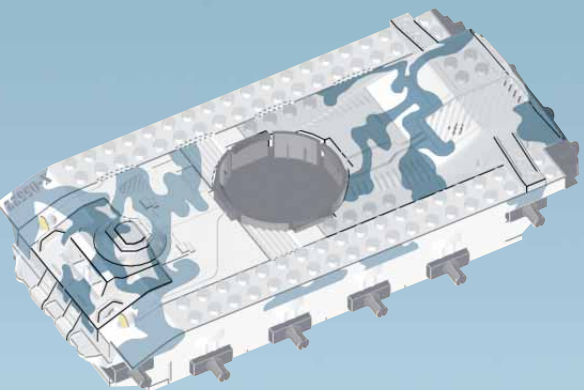
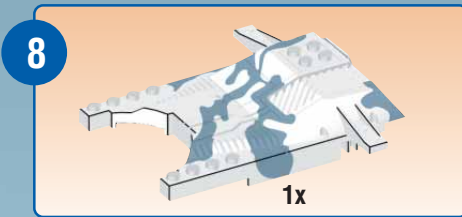
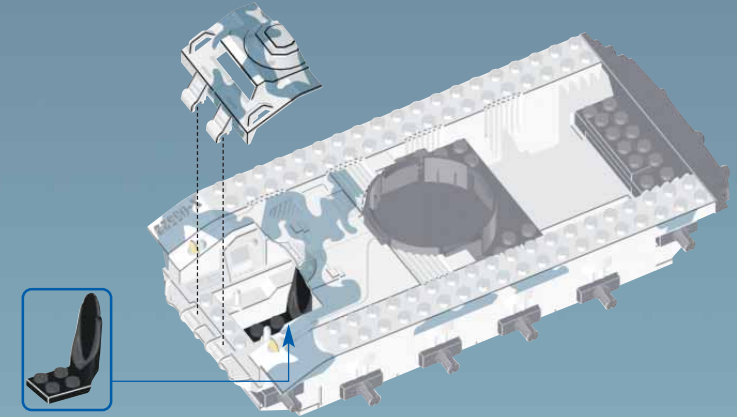
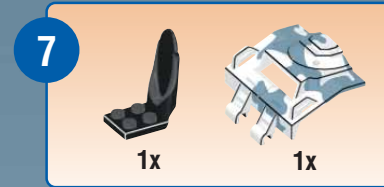
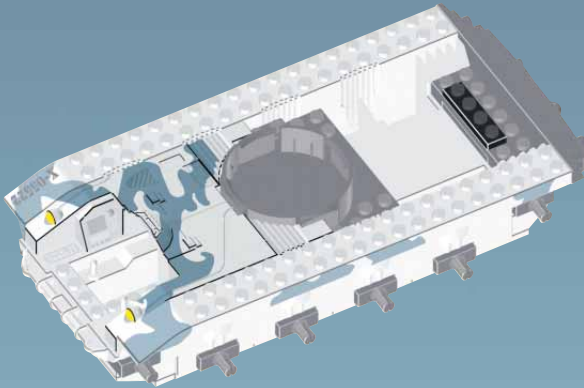
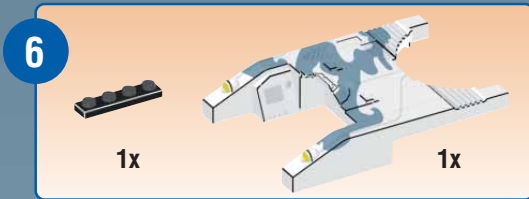

10

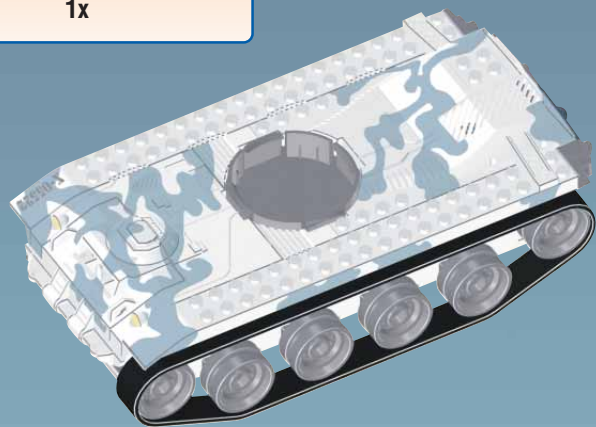
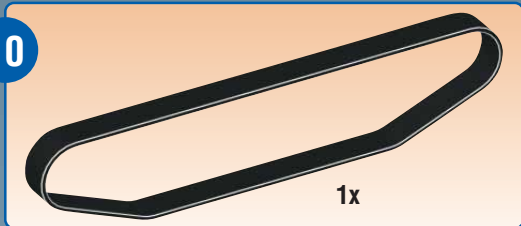

11

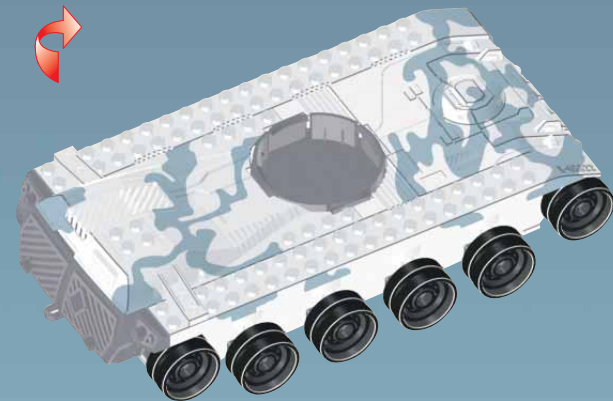
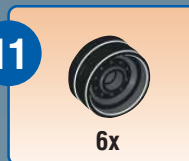

12

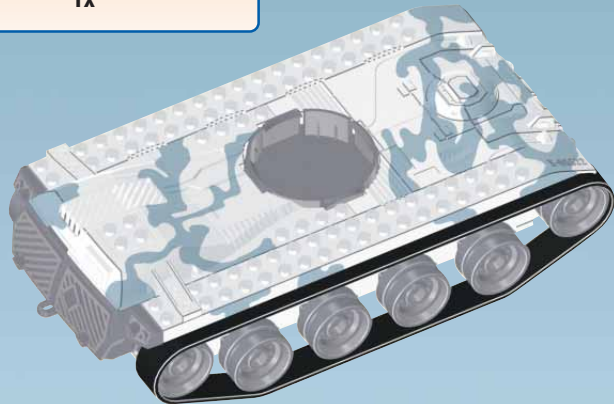
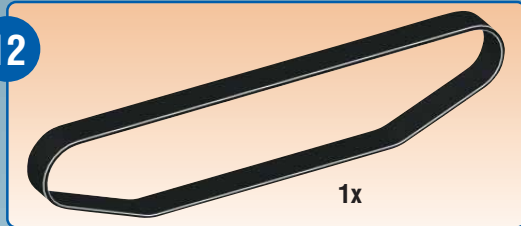

13

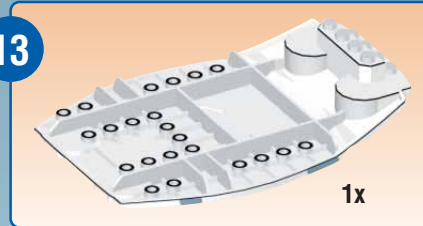

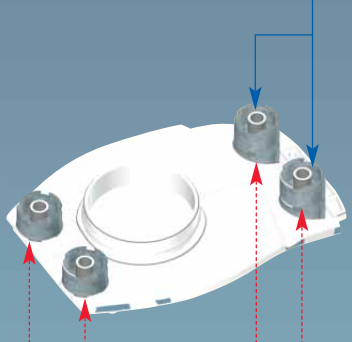
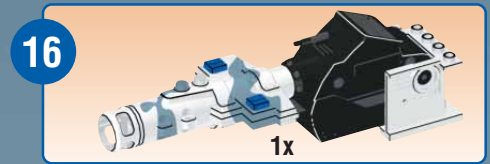
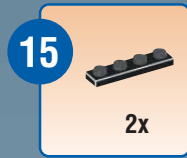
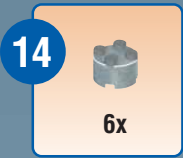

Place temporary pieces.  
Colocar las piezas provisionales.  
Poser les pièces temporaires.  
Tijdelijke delen plaatsen.

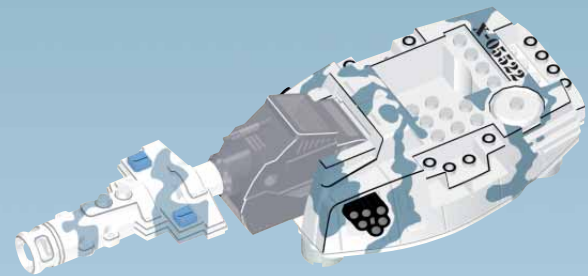
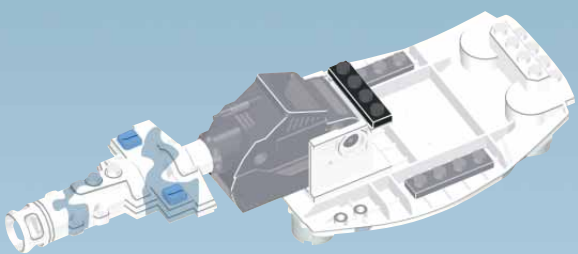
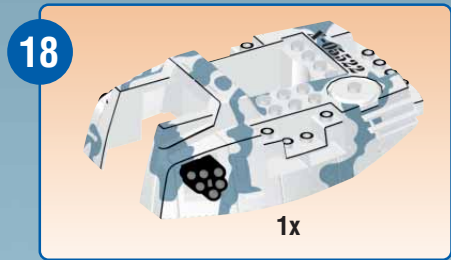
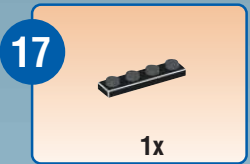
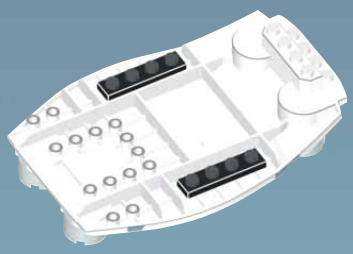



19

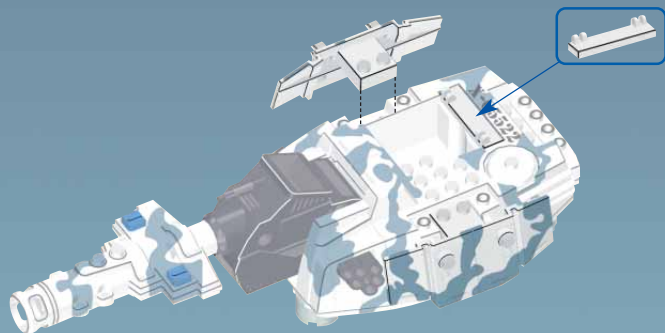

20

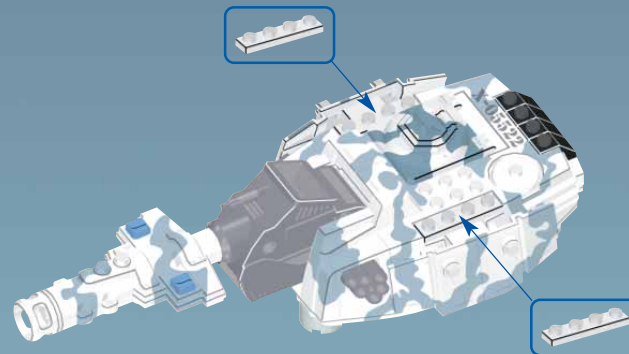
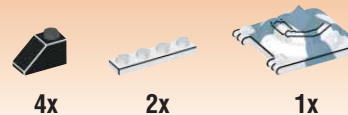

21

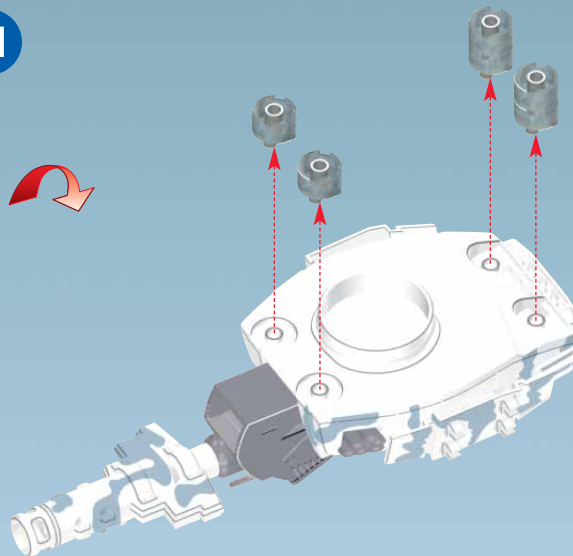

Remove temporary pieces.  
 Retirar las piezas provisionales.  
 Enlever les pièces temporaires.  
 Verwijder tijdelijkedelen.

22



21

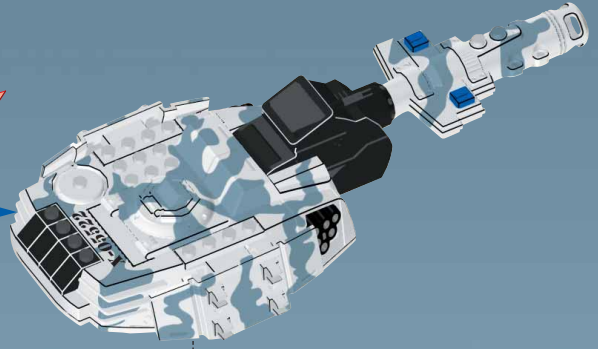

23

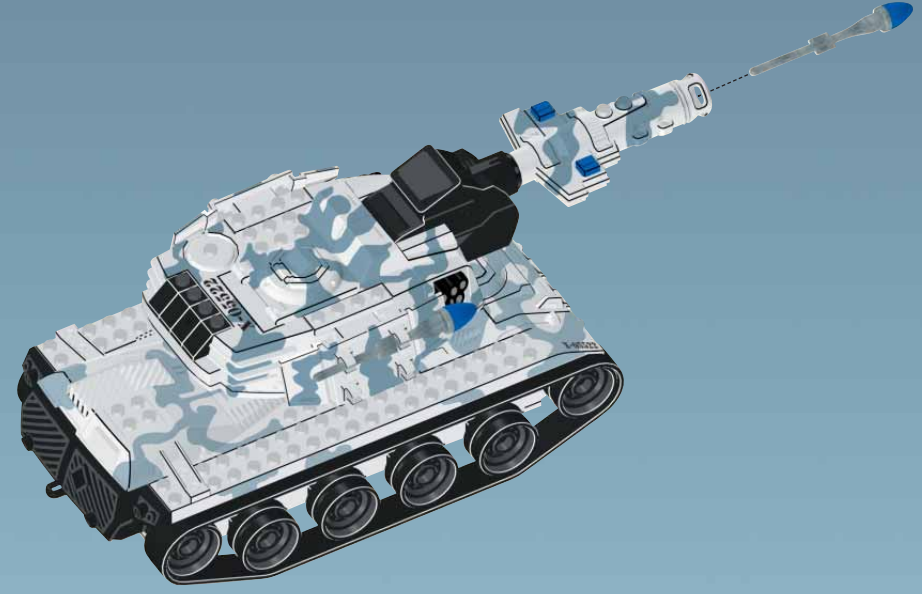
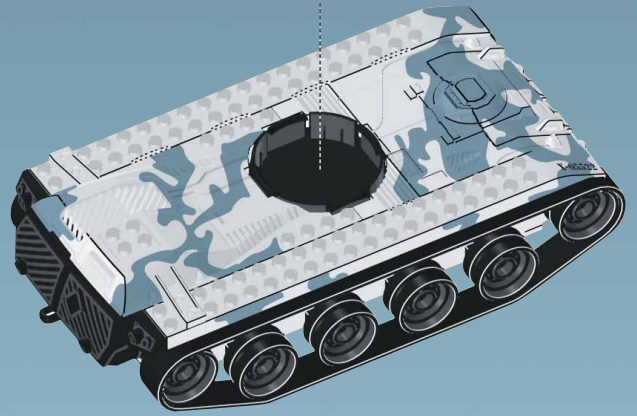
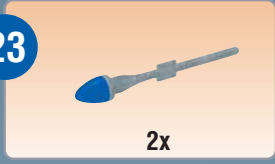

24



# COMMAND

## OPS™





# COMMAND OPS™

*VIEWING LENS  
FOR REAL FIRING MISSILE*

*LENTE DE OBSERVACIÓN  
PARA COHETE QUE DISPARA*

*LENTILLE D'OBSERVATION  
POUR TIR DE MISSILE*

*VIZIERLENS VOOR ECHE  
AFSCHIETBARE RAKET*



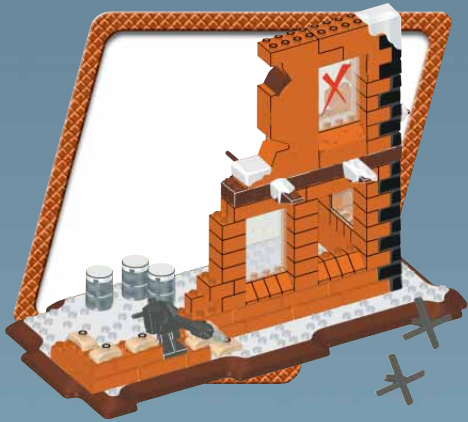

**1**

1x 10x 1x

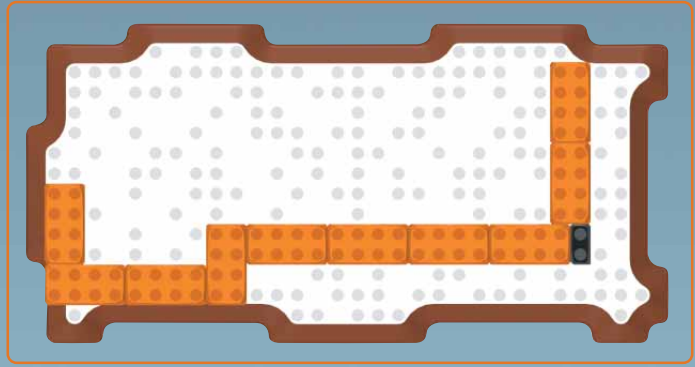
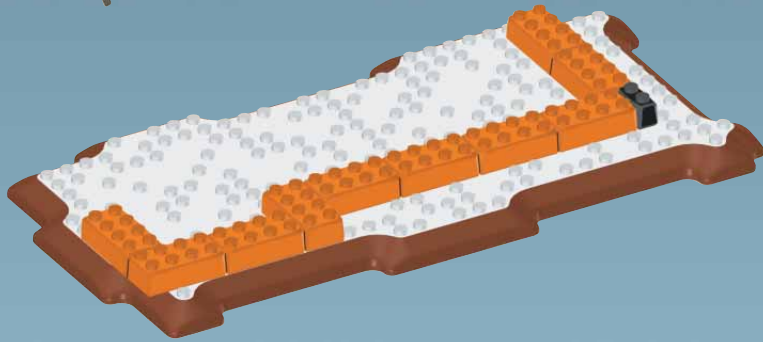

**2**

1x 8x

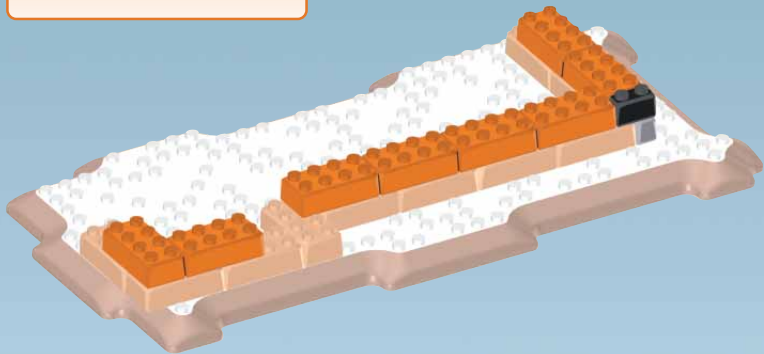

**3**

12x

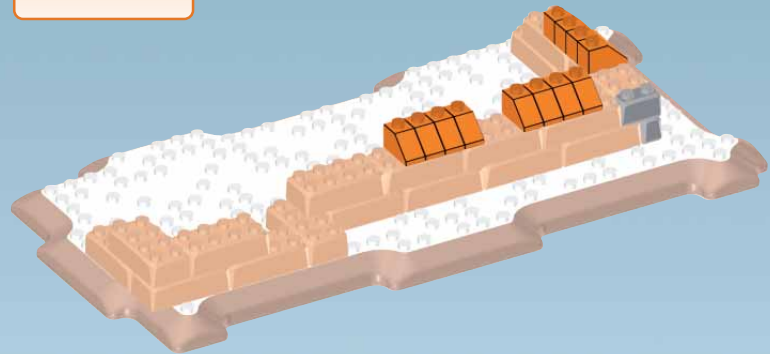

**4**

1x 2x 4x

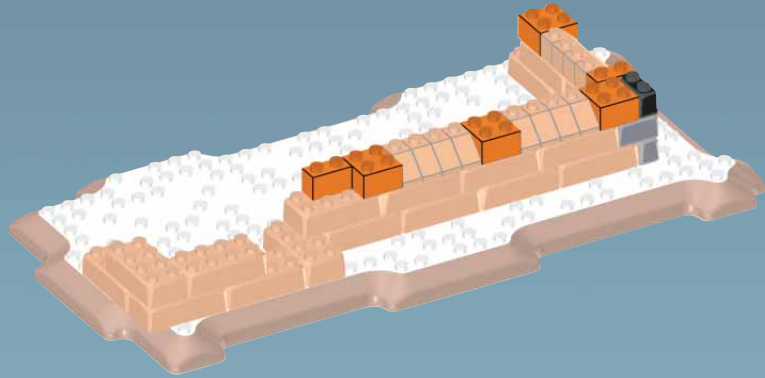

**5**

1x 5x

1 2

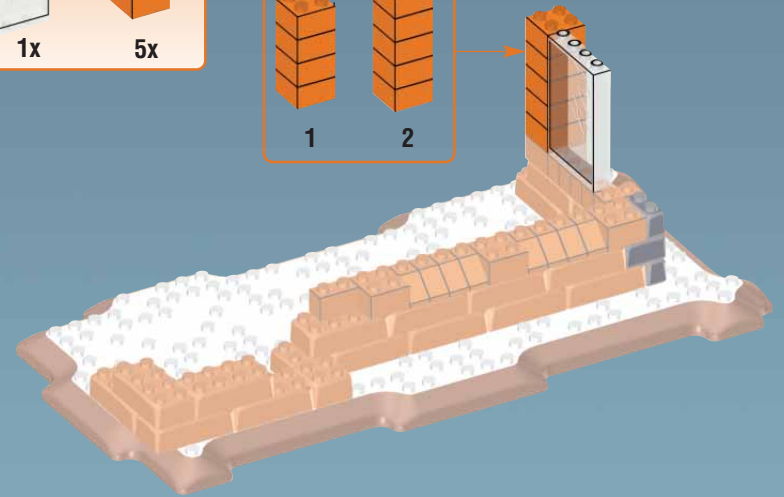

**6**

5x 5x 5x

1 2 3 4 5

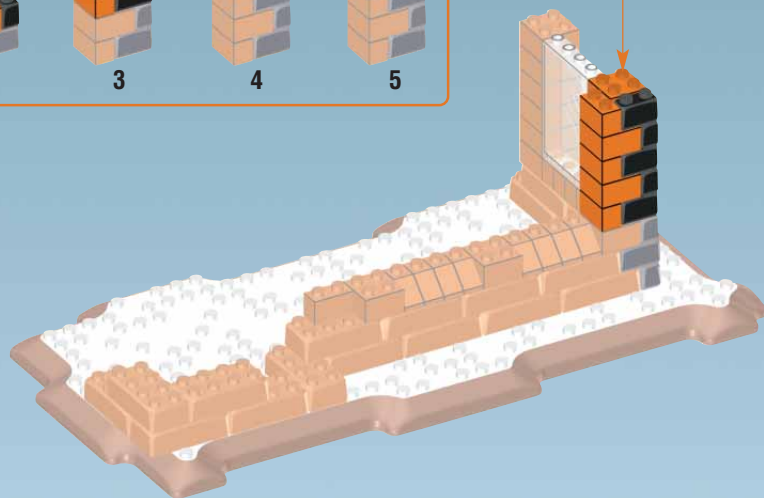



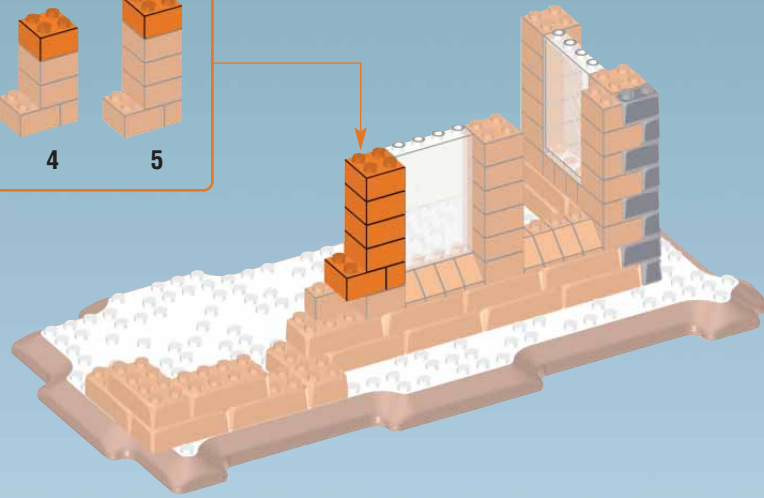
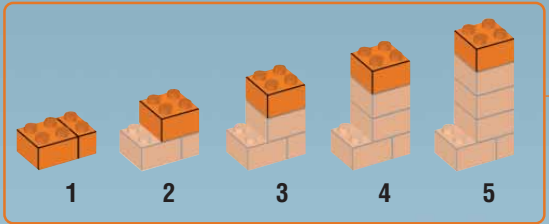
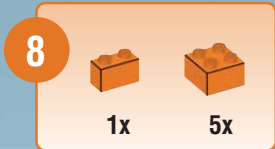
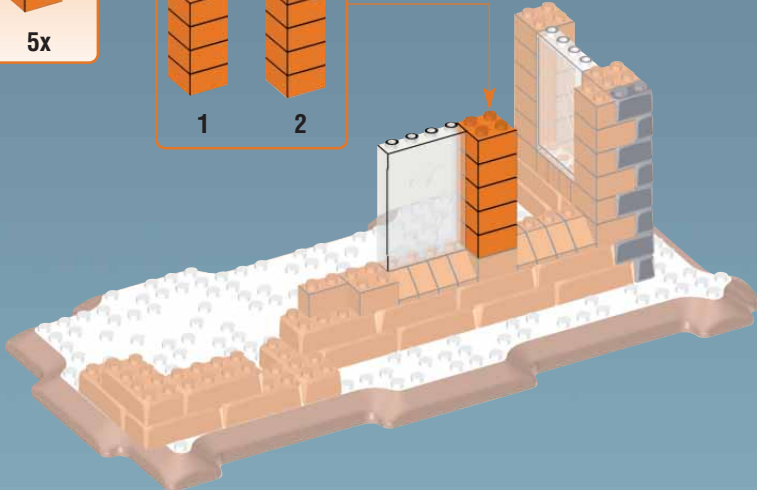
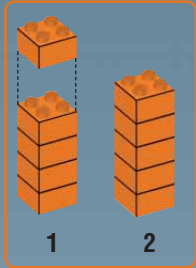
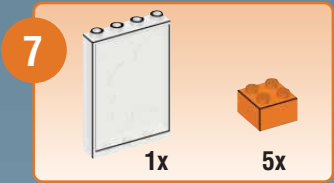



9

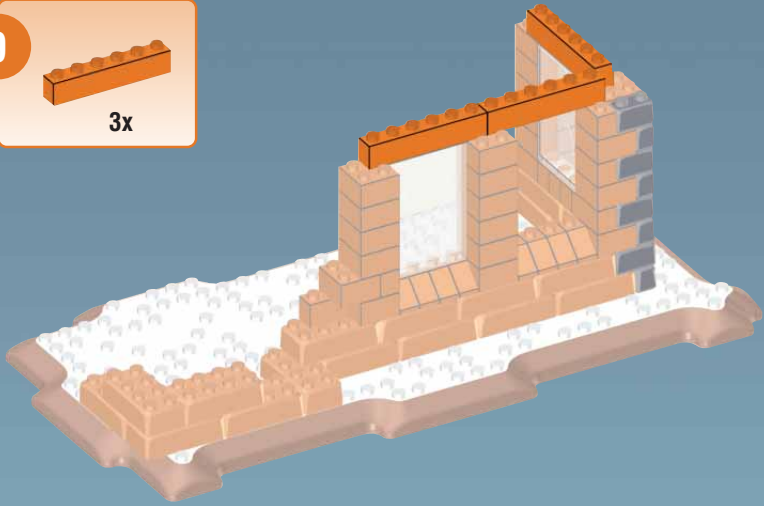

3x



10



1x 1x 3x

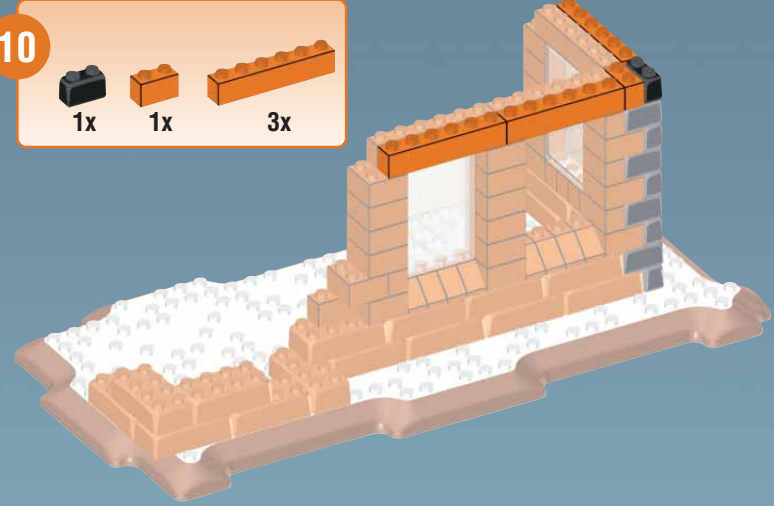

11

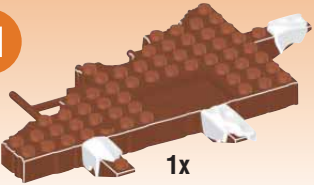

1x



12



1x 1x

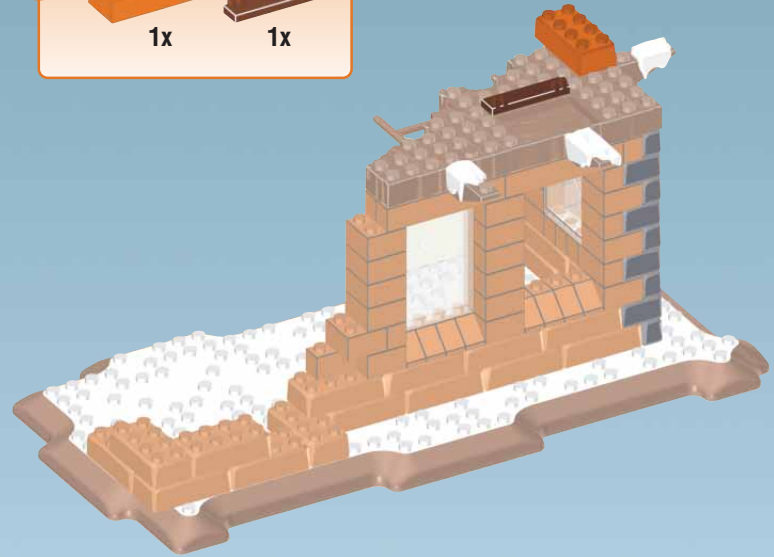

13



1x



1x

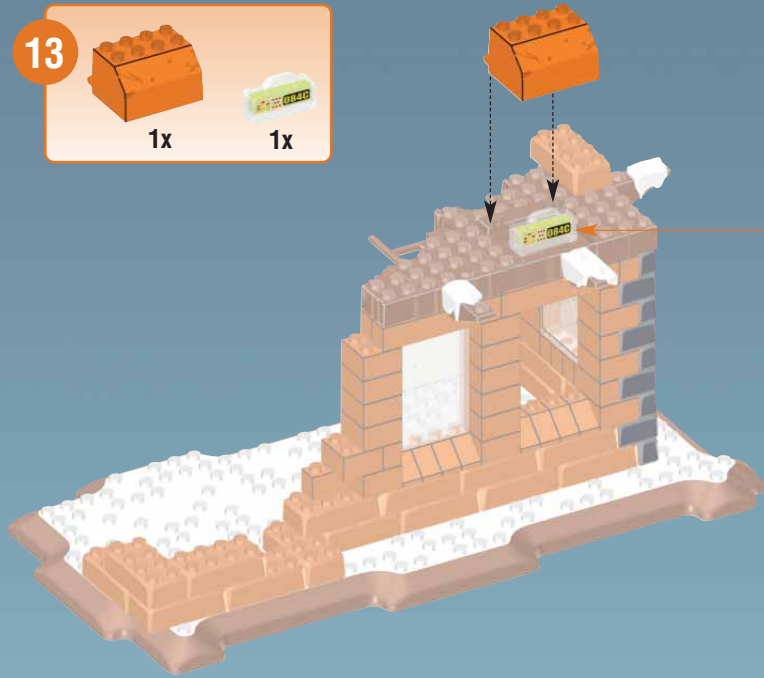

14



2x



6x



2x



5x



1x

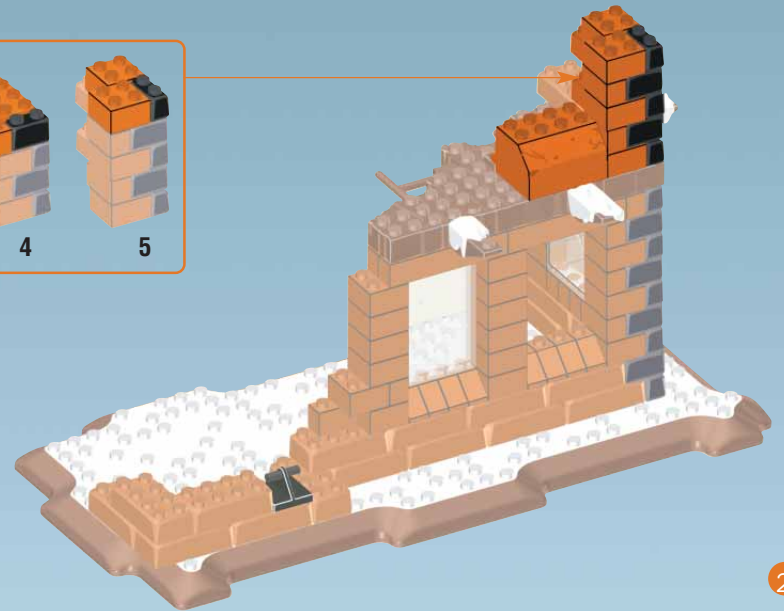
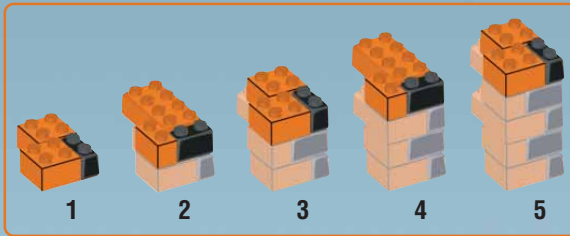



**15**

1x 6x

1 2

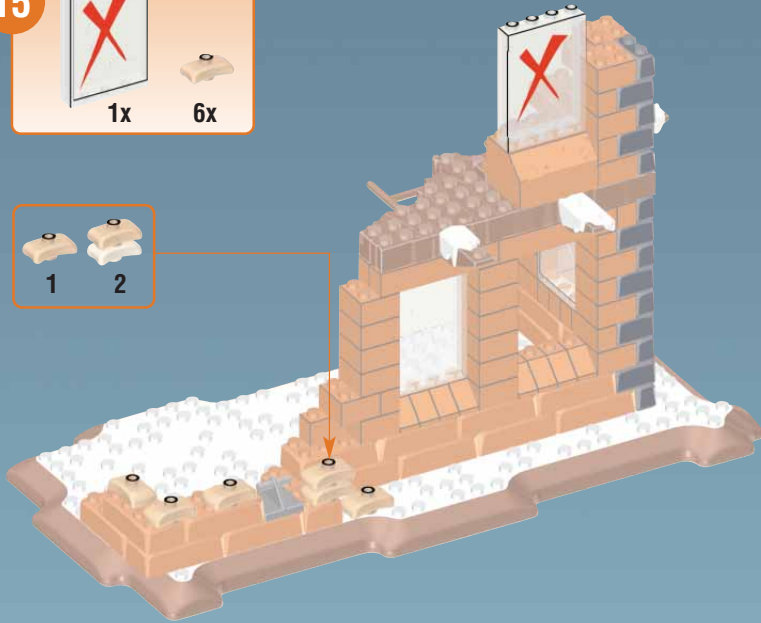

**16**

3x 6x 1x

1 2

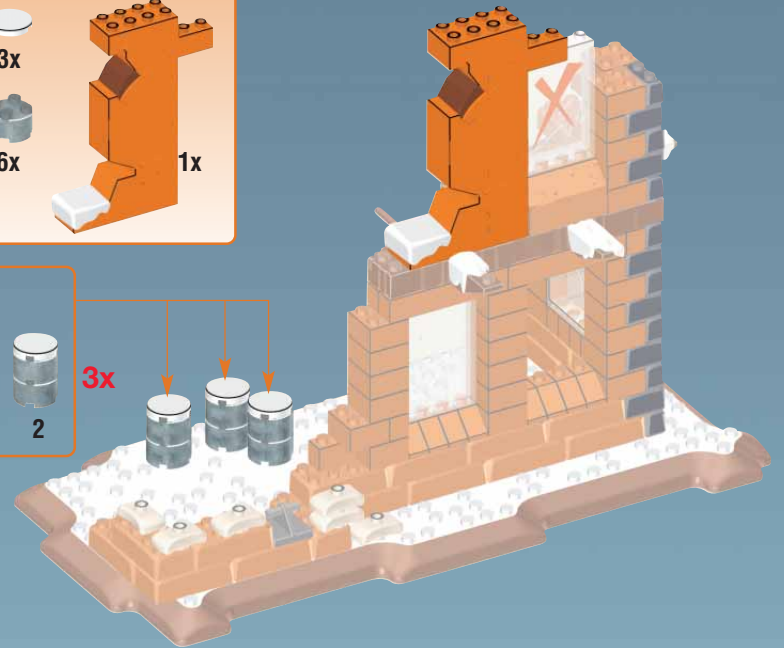

**17**

1x 1x 1x

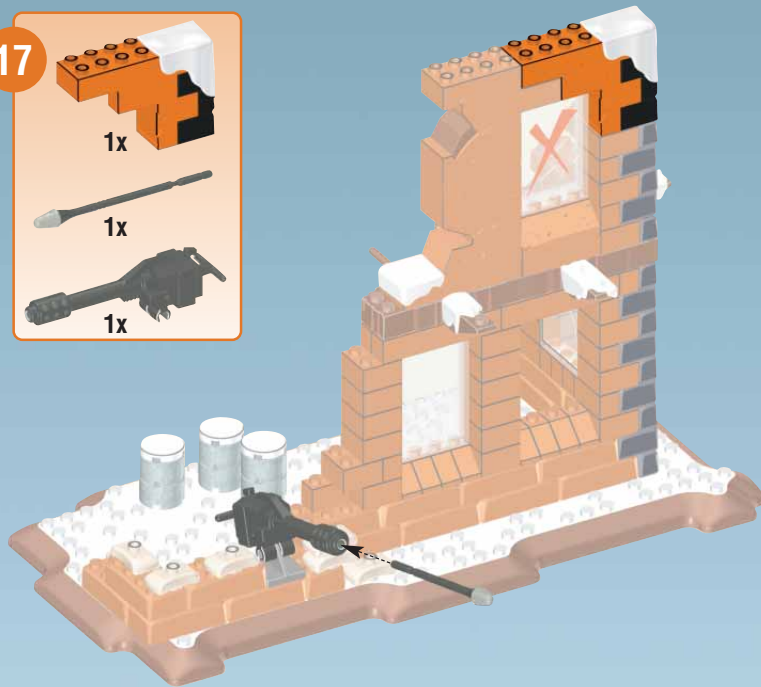

**18**

2x

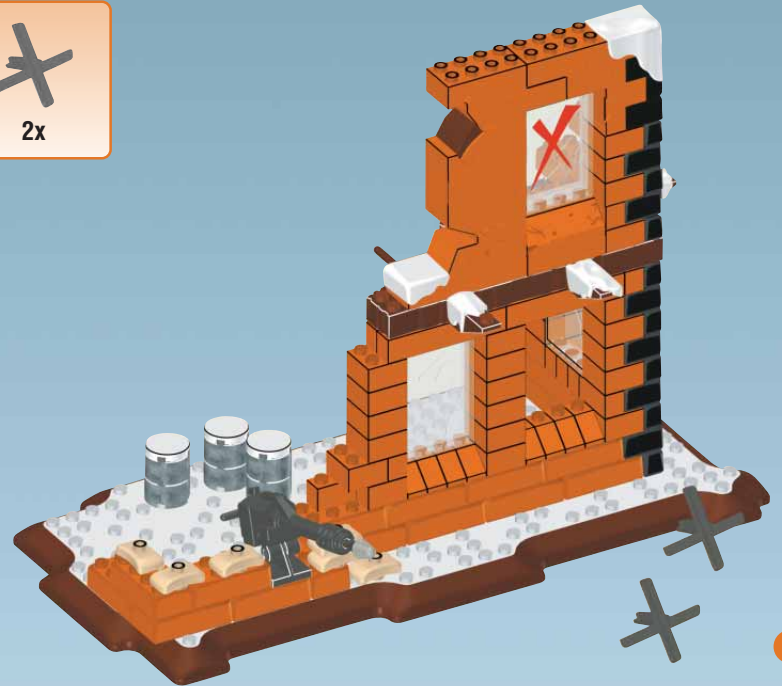

# COMMAND OPS™



*A DIRECT HIT TO THE TARGET  
REVEALS THE SECRET CASE.*

*UN GOLPE DIRECTO AL BLANCO  
DESCUBRE LA CAJA SECRETA*

*UN COUP DIRECT À LA CIBLE  
RÉVÈLERA LA BOÎTE SECRÈTE.*

*EEN VOLTREFFER OP HET DOEL  
OPENBAART DE GEHEIME DOOS.*





# COMMAND OPS™



*A MISSED TARGET CAUSES THE BUILDING TO FALL.*

*UN GOLPE QUE NO DA EN EL BLANCO HARA DERRUMBAR EL EDIFICIO.*

*UN COUP MANQUÉ À LA CIBLE CAUSERA L'EFFONDREMENT DE L'ÉDIFICE.*

*EEN MISSEER DOET HET GEBOUW INSTORTEN.*





# COMMAND OPS™



**EN** CAUTION! Do not aim at eyes or face.

**ES** ¡ADVERTENCIA! NO dirigir nunca los proyectiles hacia los ojos o la cara.

**FR** ATTENTION! Ne pas viser les yeux ou le visage.

**NL** LET OP: Niet op ogen of gezicht richten.

**DE** VORSICHT! Nicht auf das Gesicht oder die Augen richten.

**DA** ADVARSEL! Peg ikke i retning af øjne eller ansigt.

**EL** ΠΡΟΣΟΧΗ! Να μην σκοπεύετε προς τα μάτια ή το πρόσωπο.

**FI** VARO! Älä tähtää silmiin tai kasvoihin.

**IT** Attenzione! Non puntare verso gli occhi o il viso.

**NO** FORSIKTIG! Sikt ikke mot øyne eller ansikt.

**PT** ATENÇÃO: Não apontar para os olhos ou o rosto.

**SV** VAR FÖRSIKTIG! Rikta inte med ögon eller ansikte.

**JA** 注意！目や顔に使用しないで下さい。

**ZH** 警告！不要对准眼睛或脸。



**EN** Use only the projectiles included with this toy.

**ES** Utilizar solamente los proyectiles incluidos con el juguete.

**FR** Utiliser seulement les projectiles fournis avec le jouet.

**NL** Alleen de met het speelgoed bijgeleverde projectielen gebruiken.

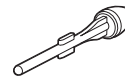

**MEGA BLOKS**

© 2003, MEGA BLOKS INC.  
 ® and ™ denote trademarks of MEGA BLOKS INC.  
 ® y ™ designan la marca registrada y la marca comercial de MEGA BLOKS INC.  
 ® et ™ désignent des marques de commerce de MEGA BLOKS INC.  
 © en ™ duiden op handelsmerken van MEGA BLOKS INC.

PRINTED IN CHINA AD055221