

**MEGA  
BLOKS**

**PROBUILDER**

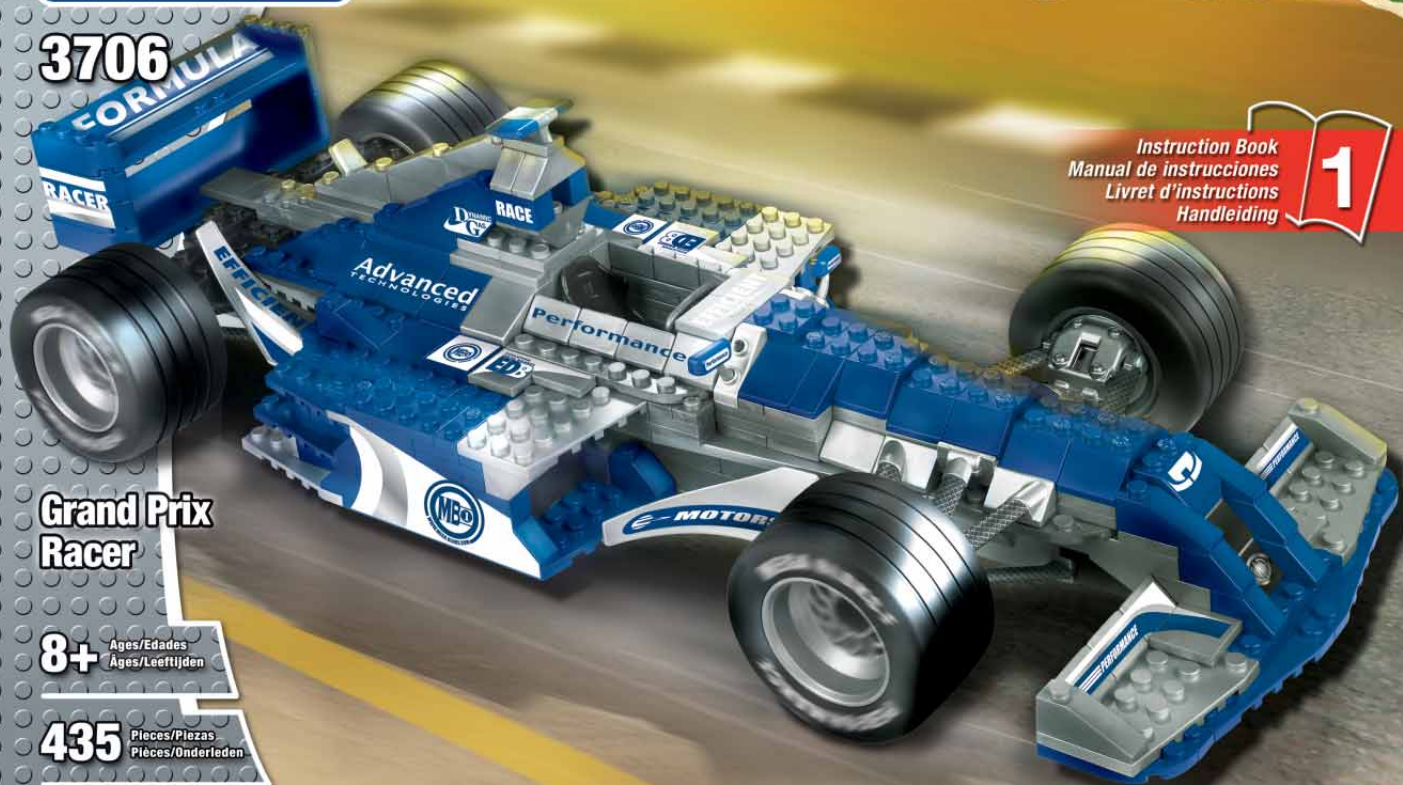

**3706**



Instruction Book  
Manual de instrucciones  
Livret d'instructions  
Handleiding

**1**

**Grand Prix  
Racer**

**8+** Ages/Edades  
Ages/Leeftijd

**435** Pieces/Piezas  
Píeces/Onderdelen

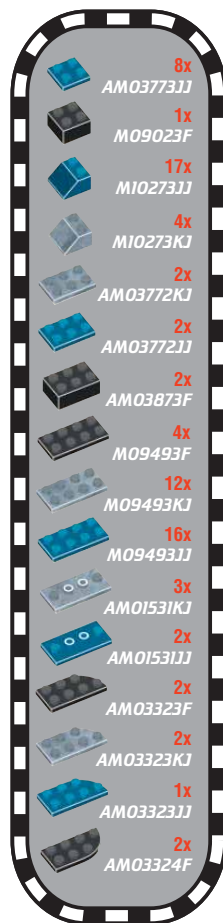
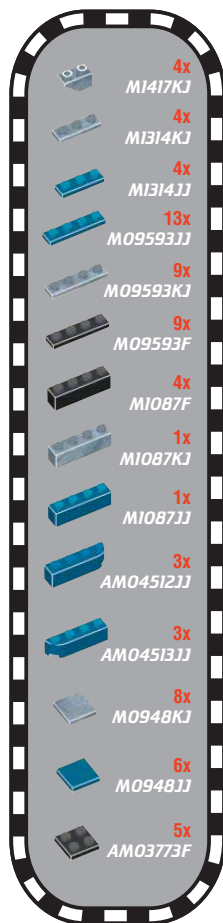
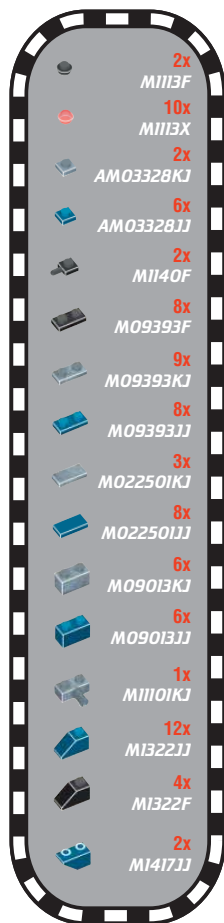

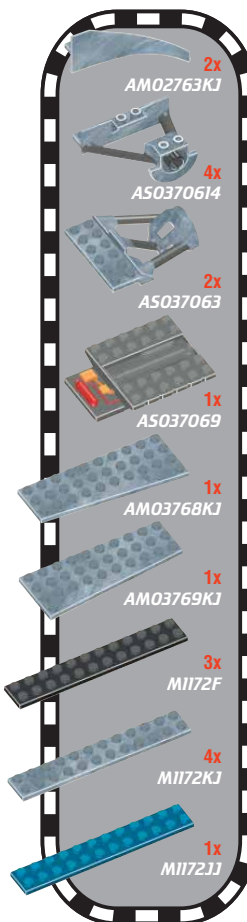
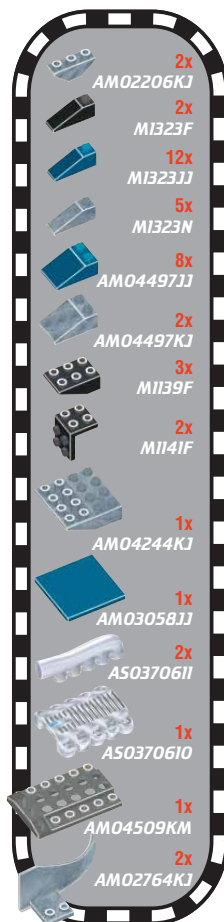
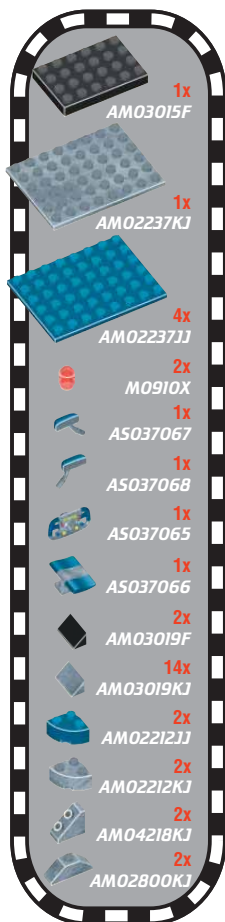
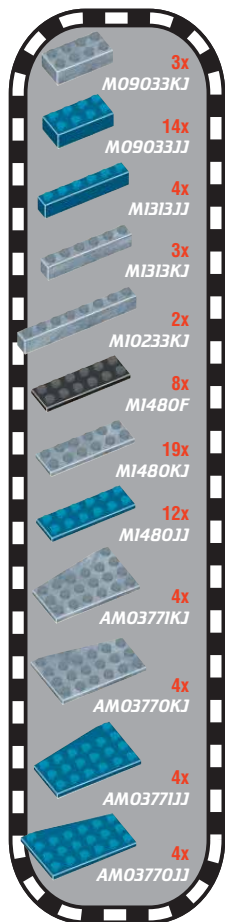

Please read these instructions carefully before first use and keep them for future reference.  
 Leer estas instrucciones cuidadosamente antes de la primera utilización y guardarlas para referencia futura.  
 Il est recommandé de lire attentivement ce feuillet avant la première utilisation et de le conserver pour référence future.  
 Wij raden u aan deze handleiding zorgvuldig te lezen en te bewaren voor eventuele raadpleging op een later tijdstip.

⚠️ **WARNING :**  
**CHOKING HAZARD.** - Small parts.  
 Not for children under 3 years.

⚠️ **ADVERTENCIA :**  
**PELIGRO DE ASFIXIA.** - Contiene piezas pequeñas.  
 No recomendado para niños menores de 3 años.

⚠️ **AVERTISSEMENT :**  
**RISQUE DE SUFFOCATION.** - Présence de petits éléments.  
 Non convient pas aux enfants de moins de 3 ans.

⚠️ **WAARSCHUWING:**  
**VERSTIKKINGSGEVAAR.** - Bevat kleine onderdelen.  
 Niet geschikt voor kinderen onder de 3 jaar.

⚠️ **WARNING:**  
**ERSTICKUNGSGEFAHR.** - Enthält kleine Teile.  
 Nicht für Kinder unter 3 Jahren geeignet.

⚠️ **ADVARSEL:**  
**KVÆLNINGSFARE.** - Indeholder smådele.  
 Ikke til børn under 3 år.

⚠️ **ΠΡΟΕΙΔΟΠΟΙΗΣΗ:**  
**ΚΙΝΔΥΝΟΣ ΠΝΕΙΜΑΤΟΣ.** - Περιέχει μικρά αντικείμενα  
 Δεν για παιδιά κάτω των 3 ετών.

⚠️ **VAROITUS:**  
**TUKKUTUNNUSVAARA.** - Sisältää pieniä osia.  
 Ei alle 3-vuotiaalle lapsille.

⚠️ **ATTENZIONE:**  
**PERICOLO DI SOFFOCAMENTO.** - Contiene piccole parti.  
 Non indicato per bambini sotto i 3 anni.

⚠️ **ADVARSEL:**  
**KVÆLNINGSFARE.** - Indeholder små deler.  
 Kun for børn over 3 år.

⚠️ **ATENÇÃO:**  
**PERIGO DE ASFIXIA.** - Contém peças pequenas.  
 Não é concebido para crianças de menos de 3 anos.

⚠️ **VAROITUS:**  
**KVÄVNINGSFARE.** - Innehåller små delar.  
 Inte för barn under 3 år.

⚠️ **警告:**  
 窒息の危険性。小さな部品が含まれています。  
 3歳以下の子供には与えないで下さい。

⚠️ **警告:**  
 有窒息危险。包含有小部件。  
 不适合3岁以下的小孩玩。



Color chart.

Cuadro cromático.

Charte de couleurs.

Färgtabell.

Kleurenkaart.

Quadro cromatico.

カラーチャート

色彩表

Active step / Etapa activa / Étape active / Aktiv skede  
 Active step / Azione attiva / アクティブなステップ / 積極步驟

Previous step / Etapa precedente / Étape précédente  
 Föregående skedet / Vorige stap / Azione precedente

前のステップ / 上一步驟

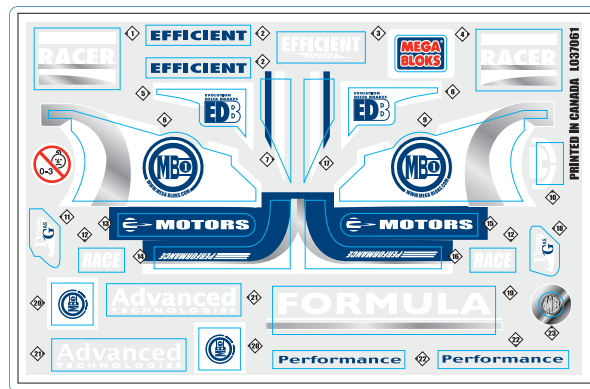
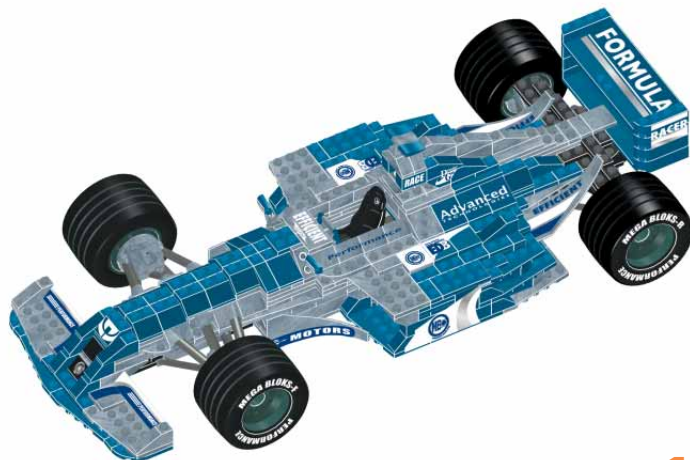
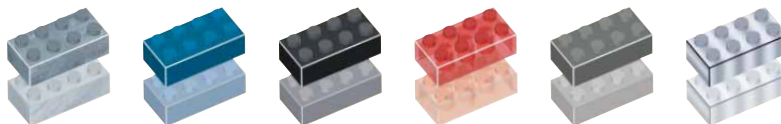

1x  
 L037061

Apply stickers  
 Aplicar autocollantes  
 Apposer les autocollants  
 Stickers aanbrengen



1

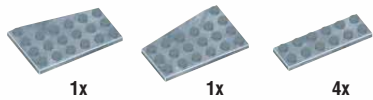

2

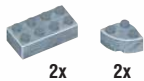

3

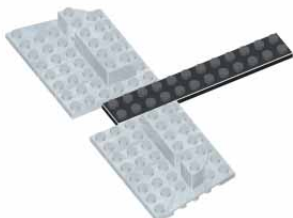

4

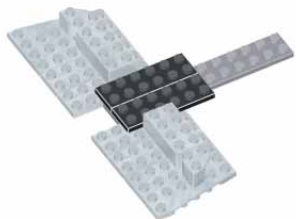

**5**

2x      4x

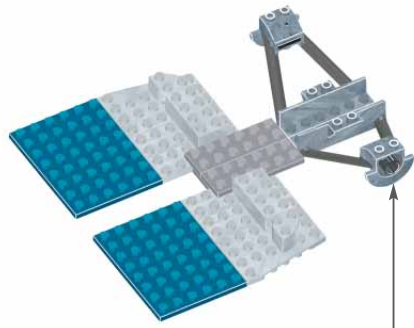

**click**

1      2

Adult assistance may be required.  
 Puede ser necesaria la ayuda de un adulto.  
 L'assistance d'un adulte peut être requise.  
 De hulp van een volwassene kan nodig zijn.

4x

**6**

2x      2x      1x      2x      2x

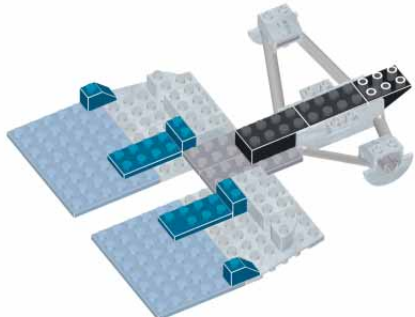

**7**

1x      1x      8x

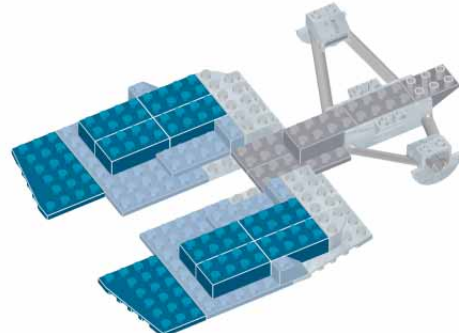

8

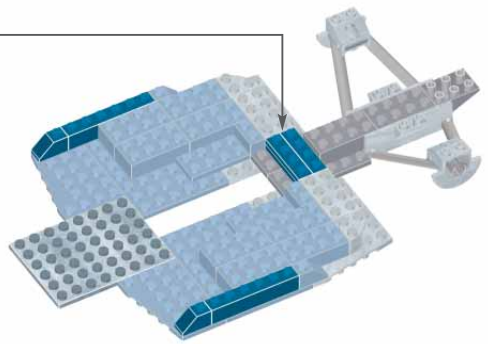
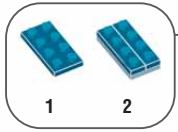
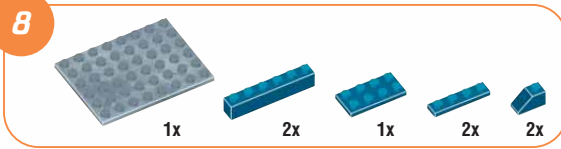

9

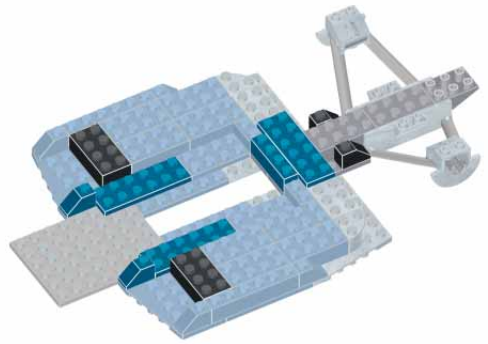

10

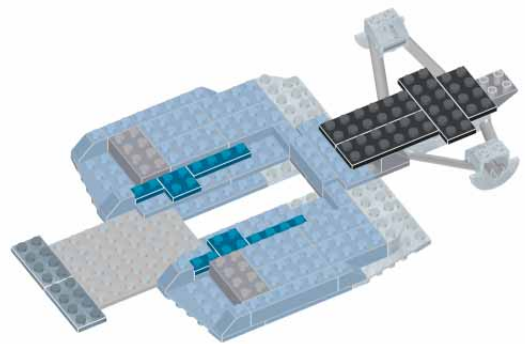
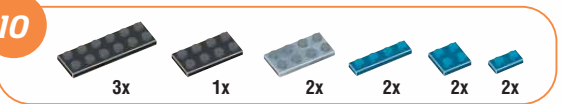

11

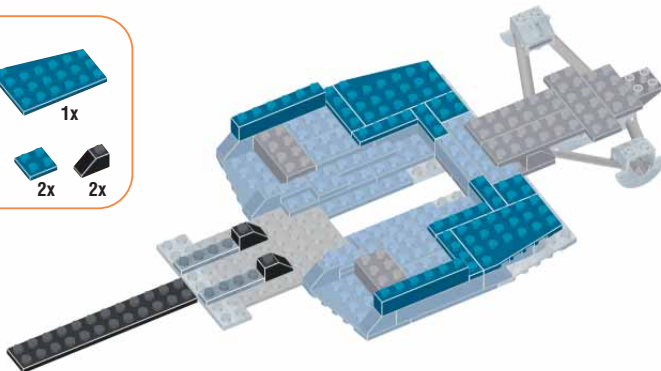
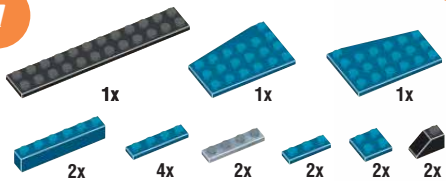

12

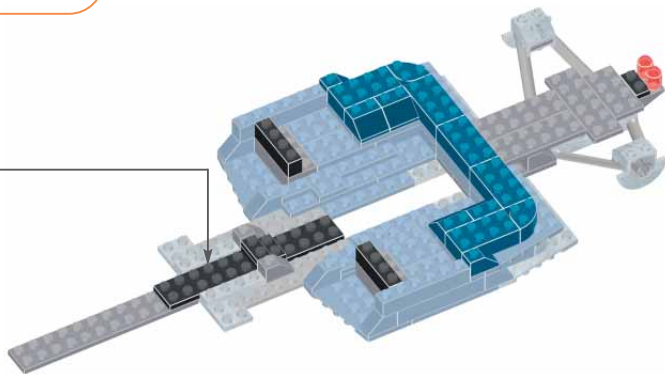
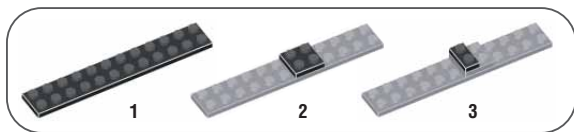
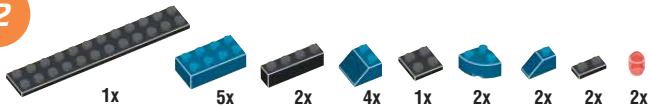



13

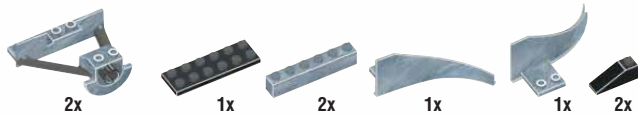

Apply stickers  
Aplicar autoadhesivos  
Apposer les autocollants  
Stickers aanbrengen

5

5

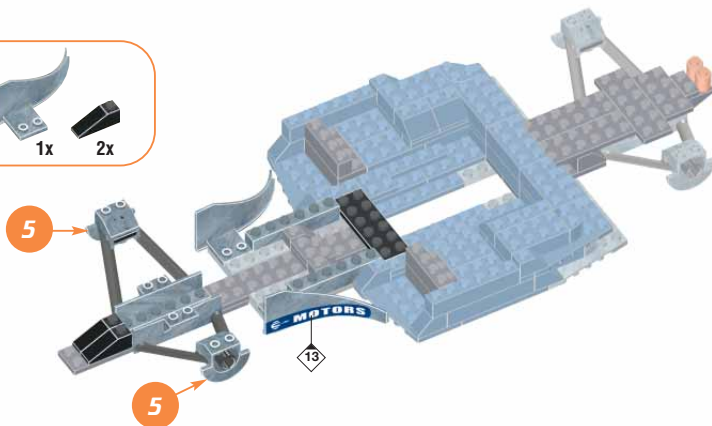

14

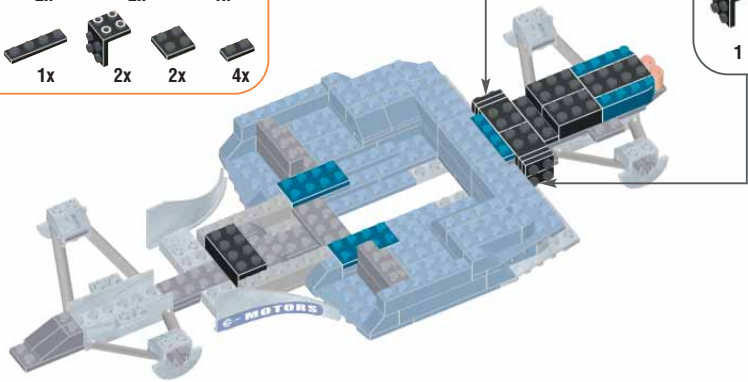
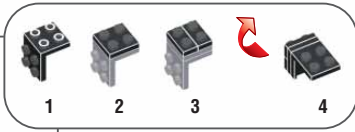
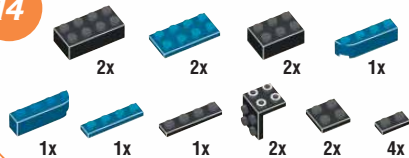

15

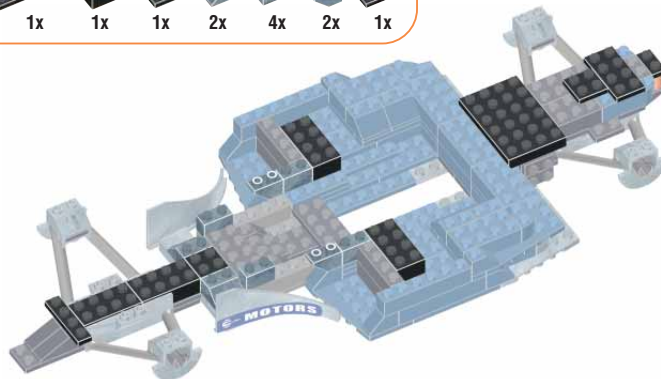
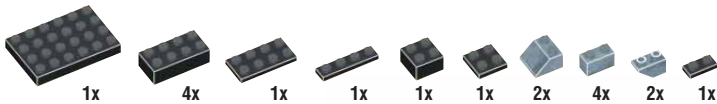

16

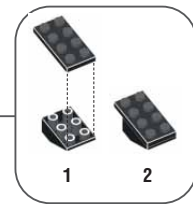
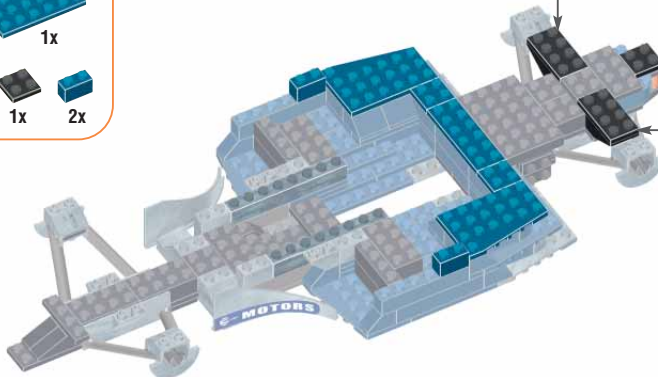
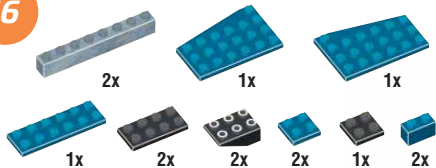

2x



17

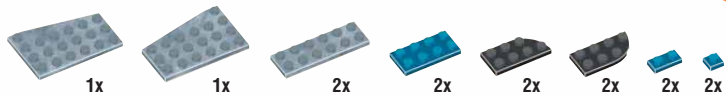

**Hold down firmly.  
Detener firmemente.  
Tenir fermement.  
Stevig vasthouden.**

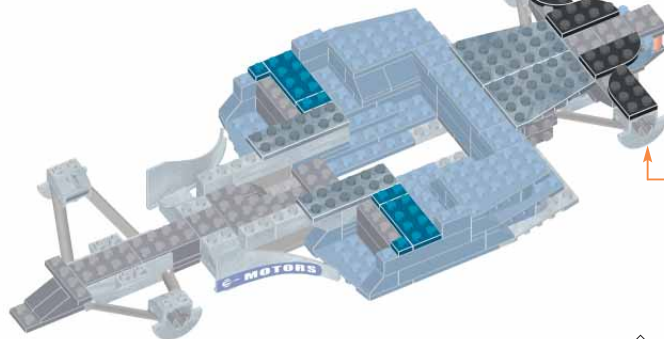

18



**Apply stickers  
Aplicar autoadhesivos  
Apposer les autocollants  
Stickers aanbrengen**

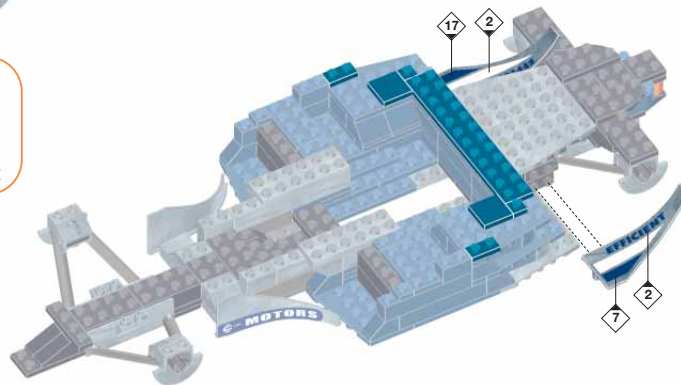

19

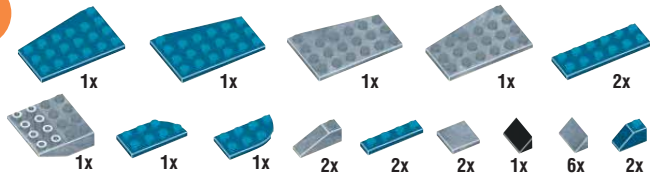

Apply stickers  
 Aplicar autoadhesivos  
 Apposer les autocollants  
 Stickers aanbrengen

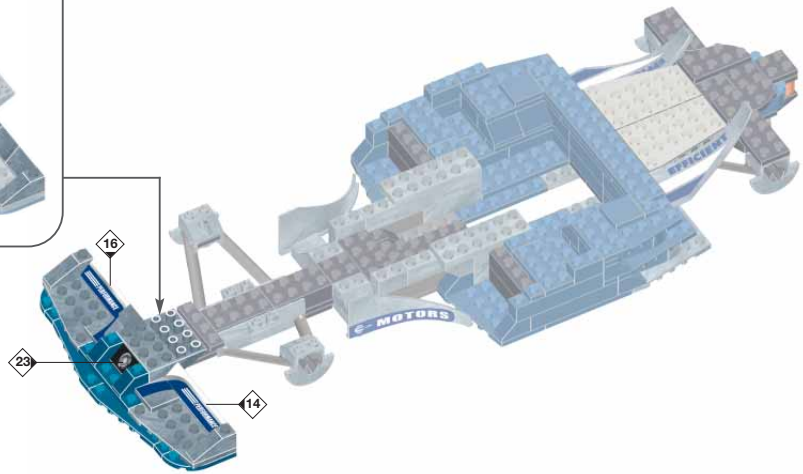
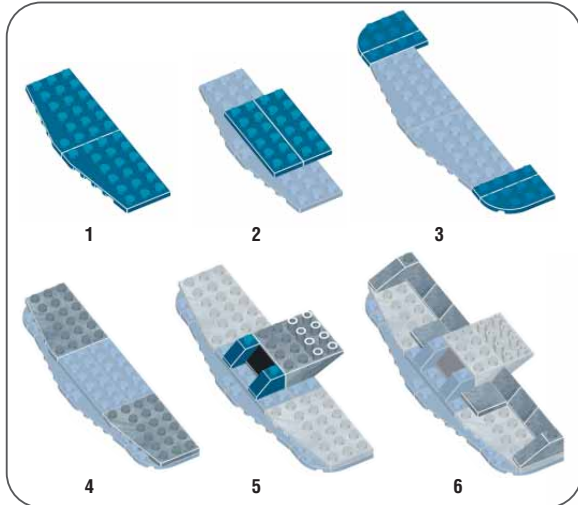

20

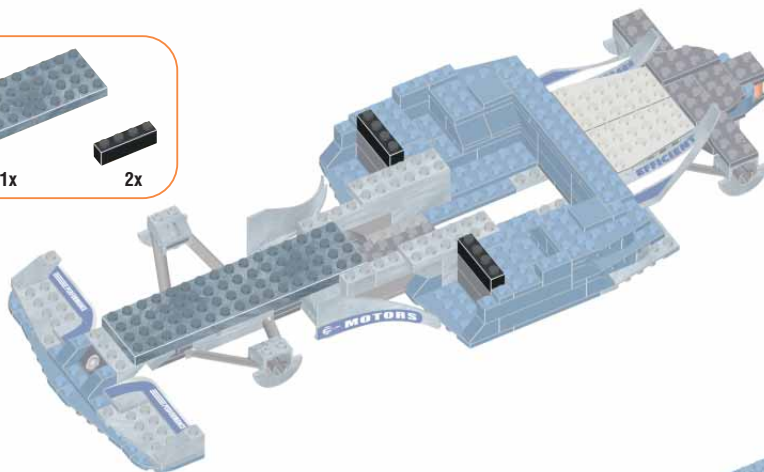
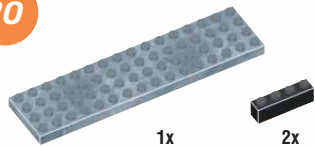

21

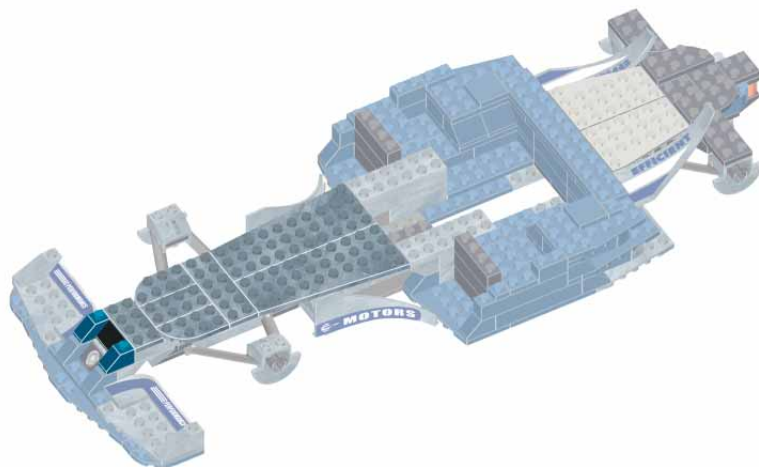
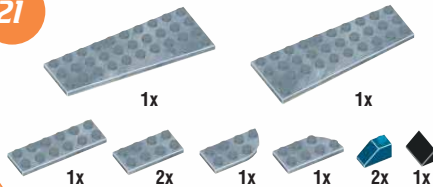

22

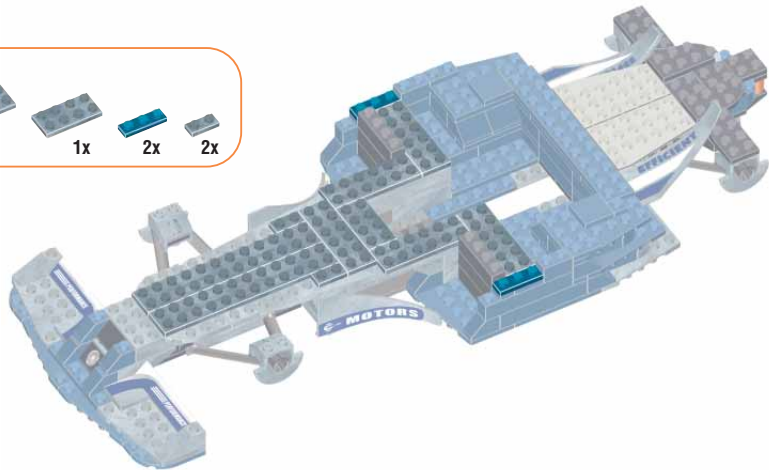
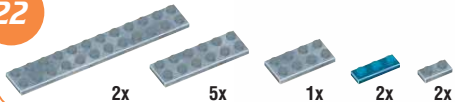

23

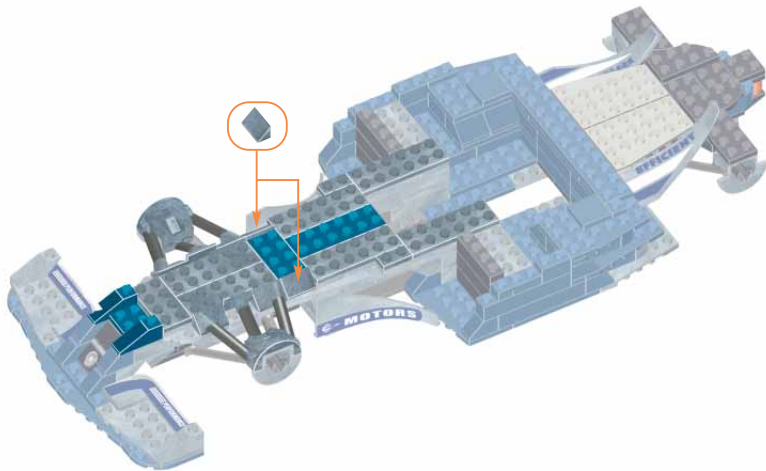
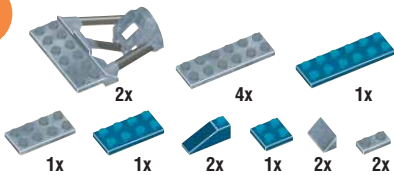

24

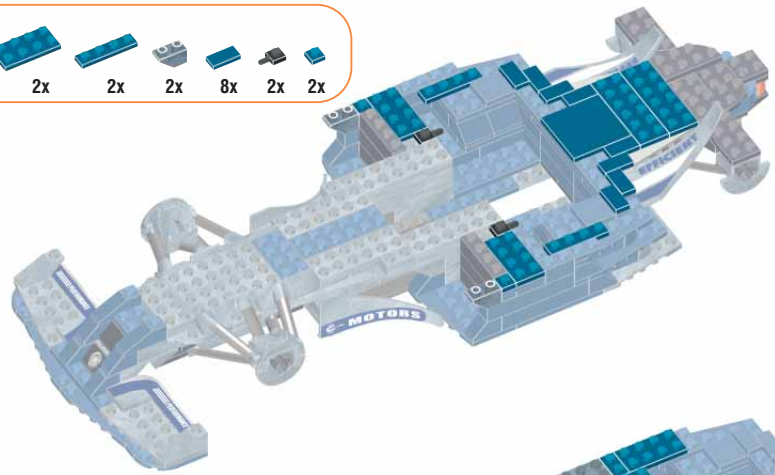
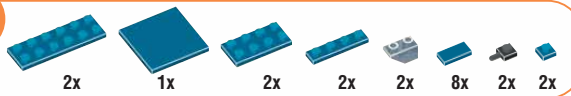

25

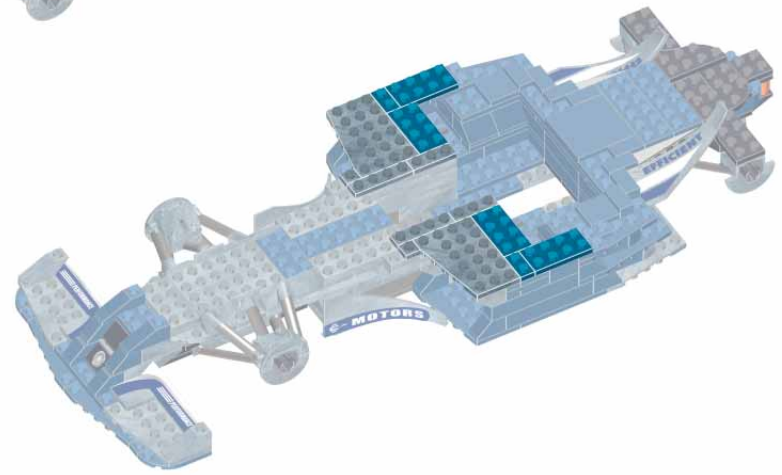
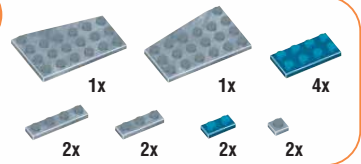

26

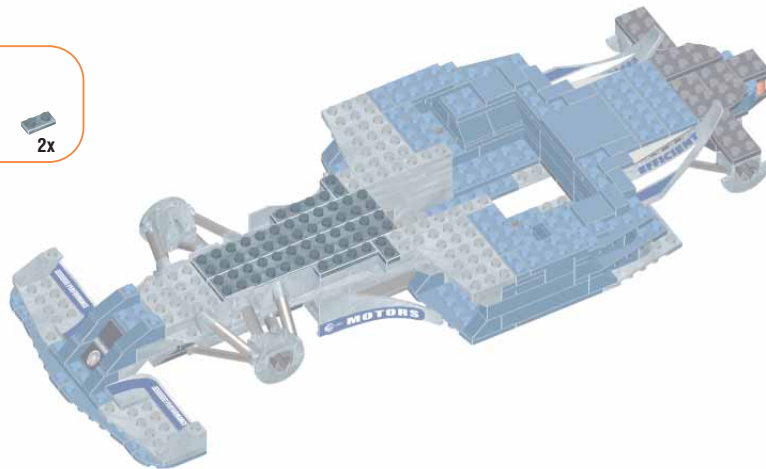
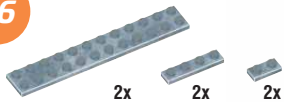

27

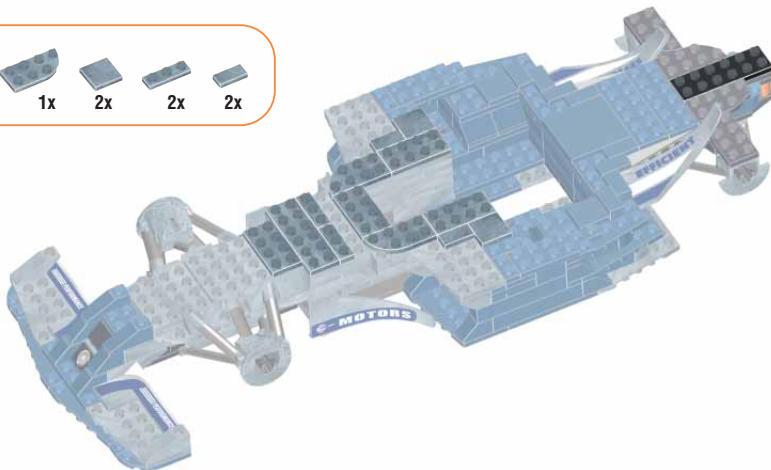
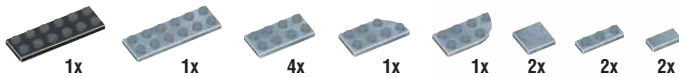



28



1x



4x



2x



1x



2x

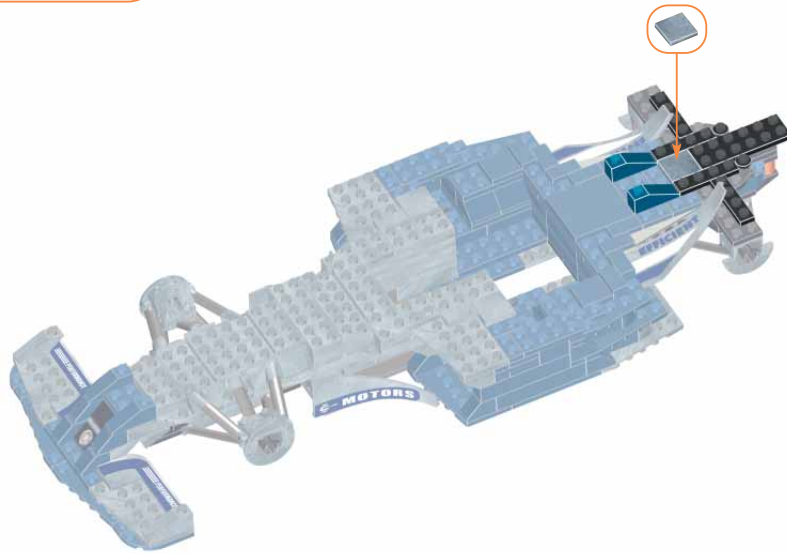

29

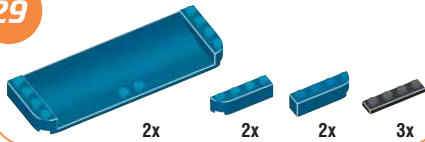

Apply stickers  
Aplicar autoadhesivos  
Apposer les autocollants  
Stickers aanbrengen

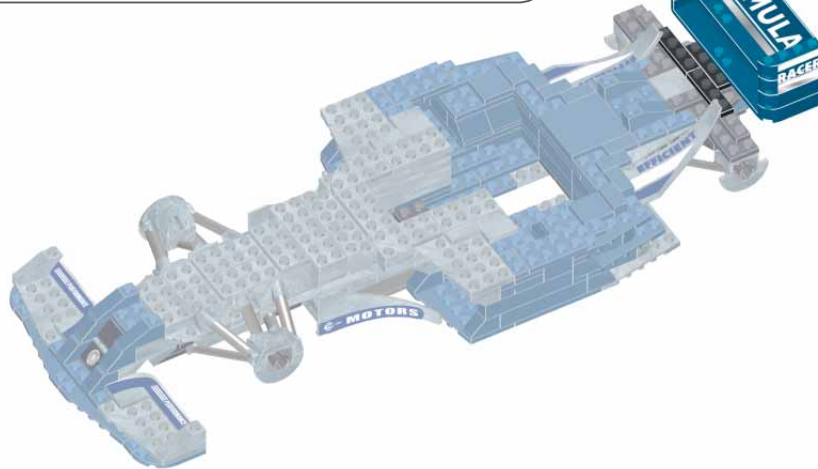
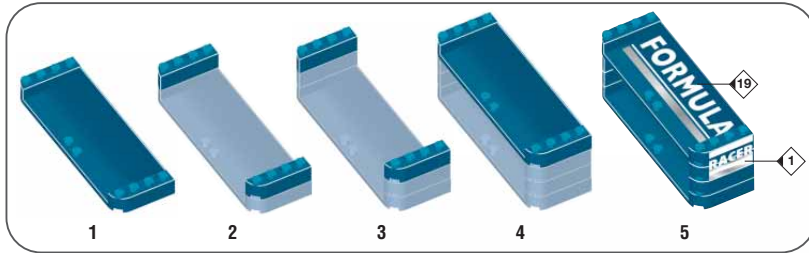

30

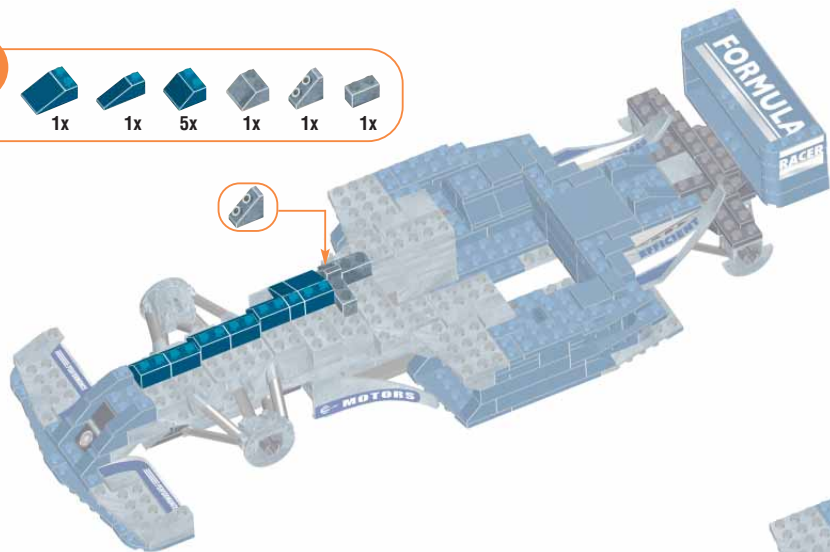
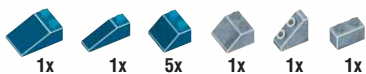

31

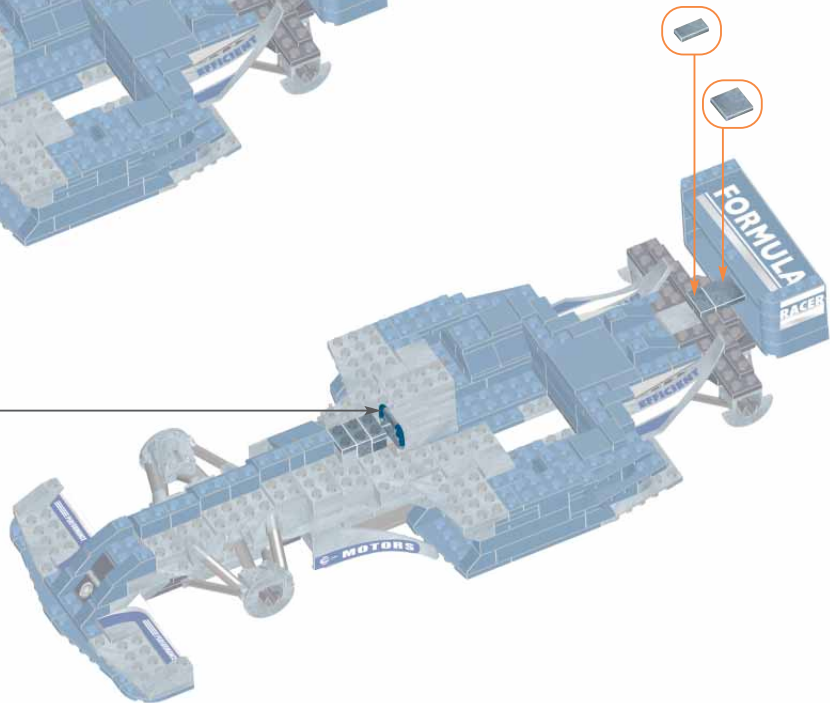



# PROBUILDER

3706  
Grand Prix  
Racer



Rebuild a Dune Racer  
Reconstruir un Dune Racer  
Reconstruis un Dune Racer  
Assembleer een Duinracer



15.4 in. / 39 cm



Authentic Detailed Parts  
Piezas auténticas detalladas  
Pièces détaillées authentiques  
Authentieke Gedetailleerde Onderdelen



Also Available / También disponible  
Egalement disponible / Eveneens beschikbaar



FX Striker<sup>™</sup> 3701



Speed Bike 3702



Air Force Warthog 3707



Steam Express 9778



© 2004, MEGA BLOKS INC.  
© and <sup>™</sup> denote trademarks of MEGA BLOKS INC.  
© y <sup>™</sup> designan la marca registrada y la marca comercial de MEGA BLOKS INC.  
© et <sup>™</sup> désignent des marques de commerce de MEGA BLOKS INC.  
© en <sup>™</sup> duiden op handelsmerken van MEGA BLOKS INC.

**MEGA  
BLOKS**

**PROBUILDER**



**3706**

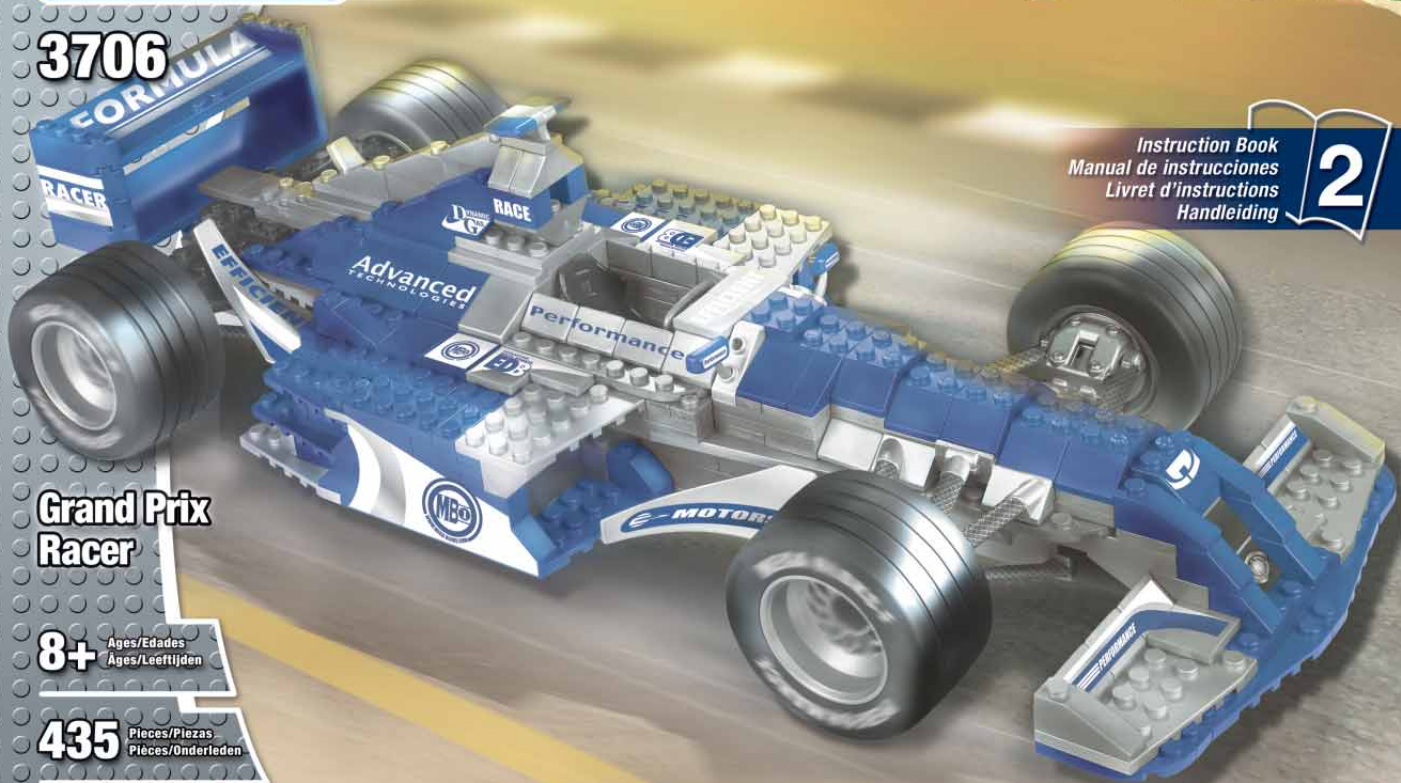

Instruction Book  
Manual de instrucciones  
Livret d'instructions  
Handleiding

**2**

**Grand Prix  
Racer**

**8+** Ages/Edades  
Ages/Leeftijden

**435** Pieces/Piezas  
Pièces/Onderdelen

Please read these instructions carefully before first use and keep them for future reference.  
 Leer estas instrucciones cuidadosamente antes de la primera utilización y guardarlas para referencia futura.  
 Il est recommandé de lire attentivement ce feuillet avant la première utilisation et de le conserver pour référence future.  
 Wij raden u aan deze handleiding zorgvuldig te lezen en te bewaren voor eventuele raadpleging op een later tijdstip.



- ⚠️ **WARNING:**  
CHOKING HAZARD. - Small parts.  
Not for children under 3 years.
- ⚠️ **ADVERTENCIA:**  
PELIGRO DE ASFIXIA. - Contiene piezas pequeñas.  
No recomendado para niños menores de 3 años.
- ⚠️ **AVERTISSEMENT:**  
RISQUE DE SUFFOCATION. - Présence de petits éléments.  
Ne convient pas aux enfants de moins de 3 ans.
- ⚠️ **WAARSCHUWING:**  
VERSTIKKINGSGEVAAR. - Bevat kleine onderdelen.  
Niet geschikt voor kinderen onder de 3 jaar.

- ⚠️ **WARNUNG:**  
ERSTICKUNGSGEFAHR. - Enthält kleine Teile.  
Nicht für Kinder unter 3 Jahren geeignet.
- ⚠️ **ADVARSEL:**  
KVÆLNINGSFARE. - Inneholder smådele.  
Ikke til barn under 3 år.
- ⚠️ **ΠΡΟΕΙΔΟΠΟΙΗΣΗ:**  
ΚΙΝΔΥΝΟΣ ΠΝΕΥΜΑΤΟΣ. - Περιέχει μικρά αντικείμενα.  
Οχι για παιδιά κάτω των 3 ετών.
- ⚠️ **VAROITUS:**  
TUKEHTUMISVAARA. - Sisältää pieniä osia.  
Ei alle 3-vuotiaalle lapsille.

- ⚠️ **ATTENZIONE:**  
PERICOLO DI SOFFOCAMENTO. - Contiene piccole parti.  
Non indicato per bambini sotto i 3 anni.
- ⚠️ **ADVARSEL:**  
KVÆLNINGSFARE. - Inneholder små deler.  
Kun for barn over 3 år.
- ⚠️ **ATENÇÃO:**  
PERIGO DE ASFIXIA. - Contém peças pequenas.  
Não é concebido para crianças de menos de 3 anos.
- ⚠️ **ARNINGI:**  
KVÄVNINGSRISIK. - Inneholder små delar.  
Inte för barn under 3 år.



Color chart.      Charte de couleurs.      Kleurenkaart.      カラーチャート  
 Cuadro cromático.      Färgtabell.      Quadro cromatico.      色彩表

**Active step / Etapa activa / Étape active / Aktivt skede**  
**Active step / Azione attiva / アクティブなステップ / 積極步驟**  
**Previous step / Etapa precedente / Étape précédente**  
**Føregående skedet / Yorige stap / Azione precedente**  
 前のステップ / 上一步驟

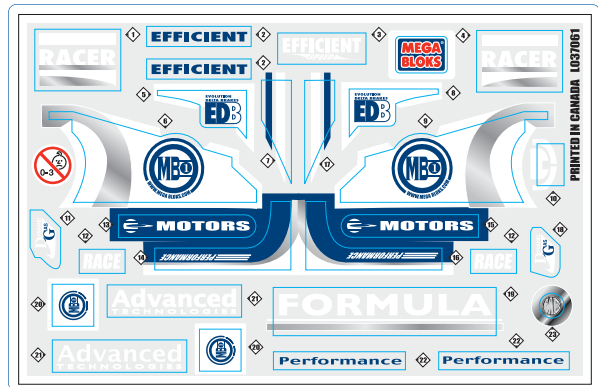
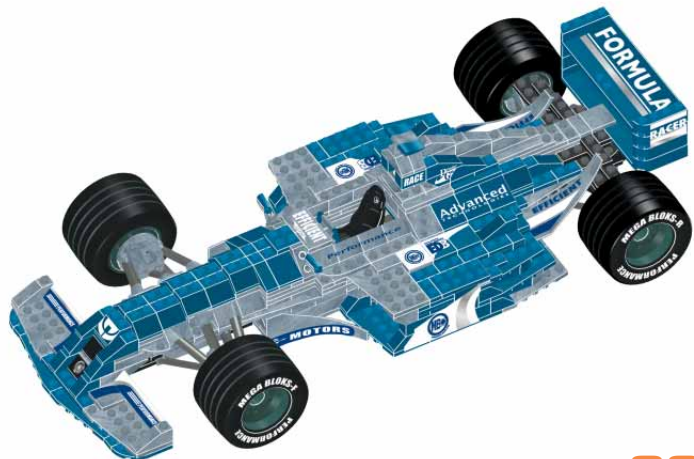
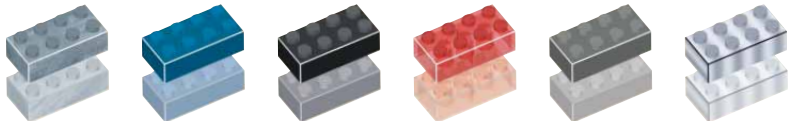

32

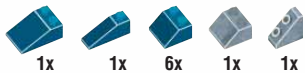

1x

1x

6x

1x

1x



Apply stickers  
Aplicar autoadhesivos  
Apposer les autocollants  
Stickers aanbrengen

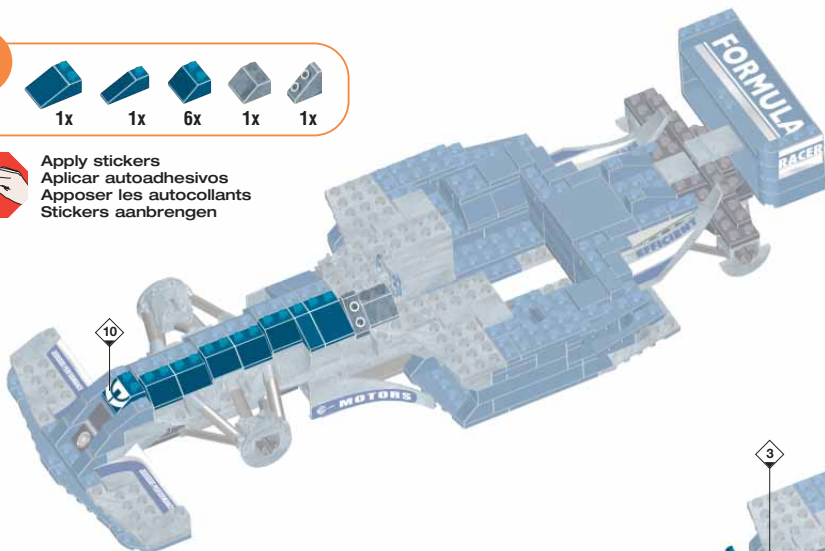

33



1x

2x

1x

1x

6x



Apply stickers  
Aplicar autoadhesivos  
Apposer les autocollants  
Stickers aanbrengen

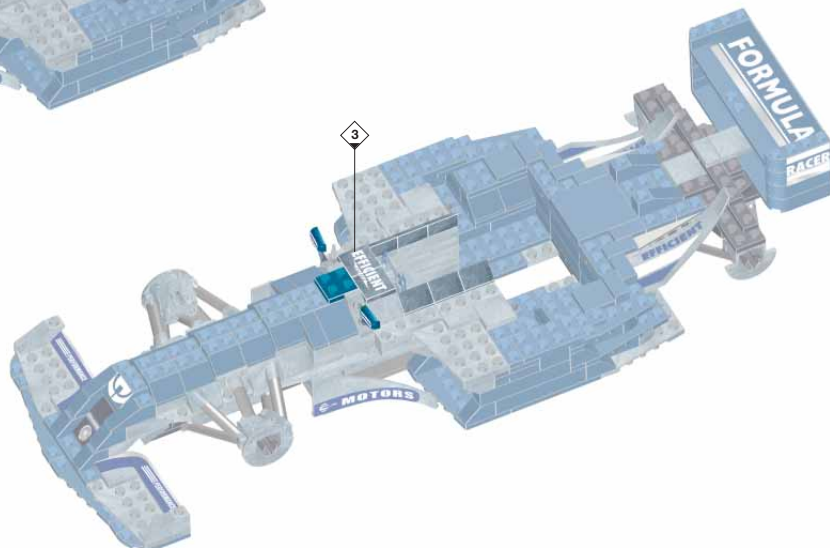

34

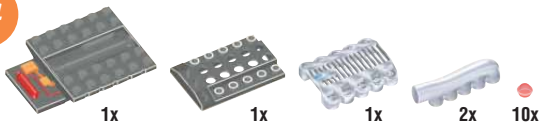

Apply stickers  
Aplicar autoadhesivos  
Apposer les autocollants  
Stickers aanbrengen

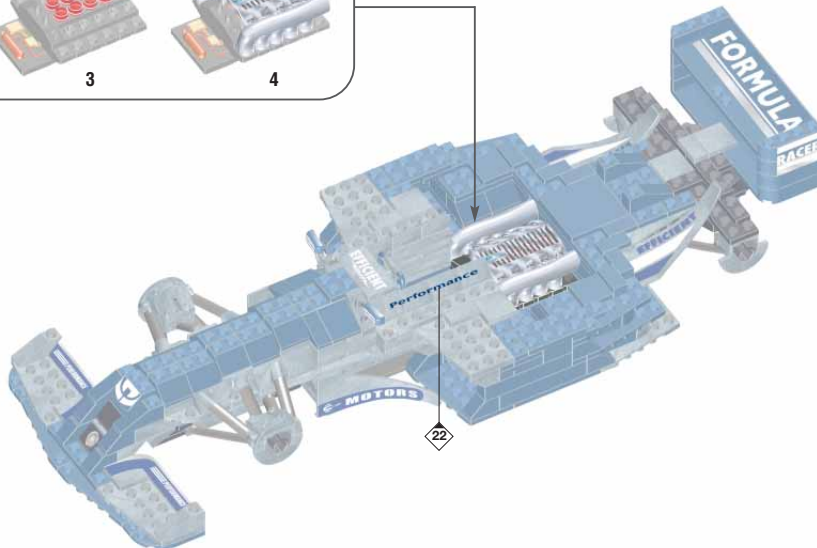
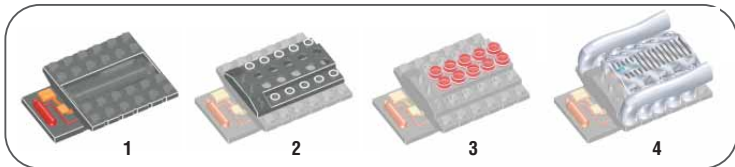



35



1x

1x



1

2

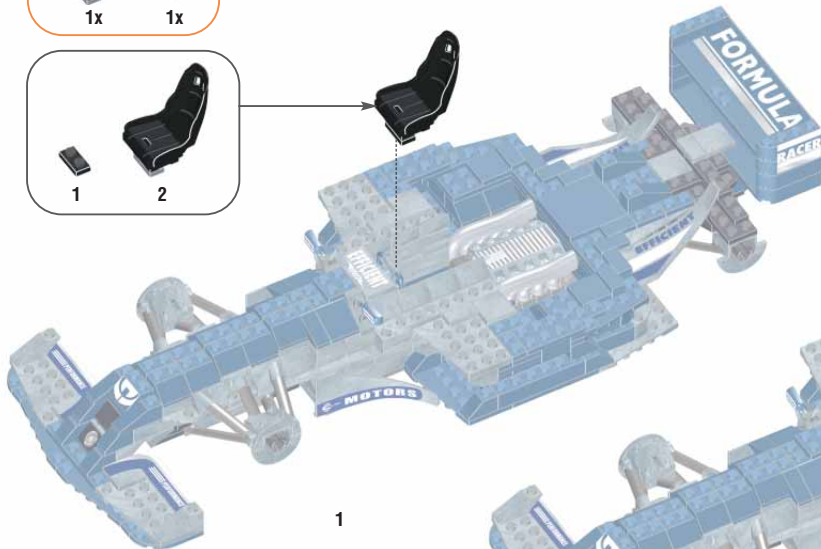

1

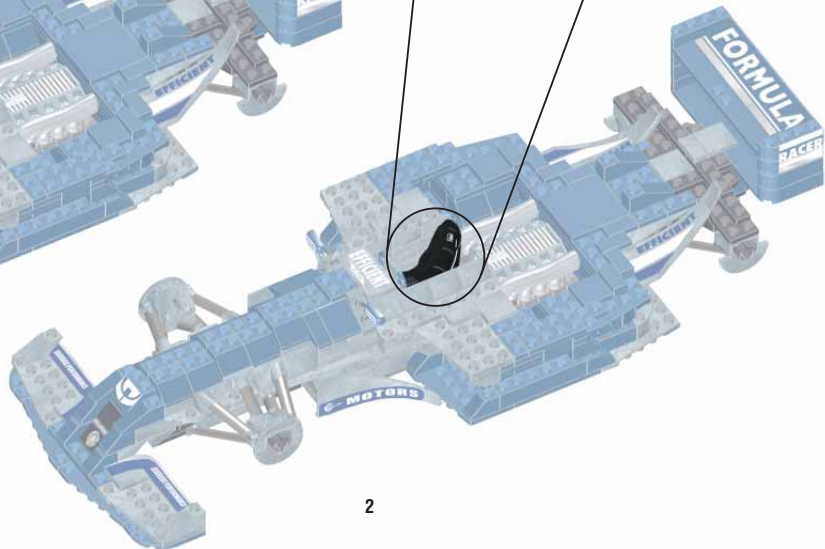

2

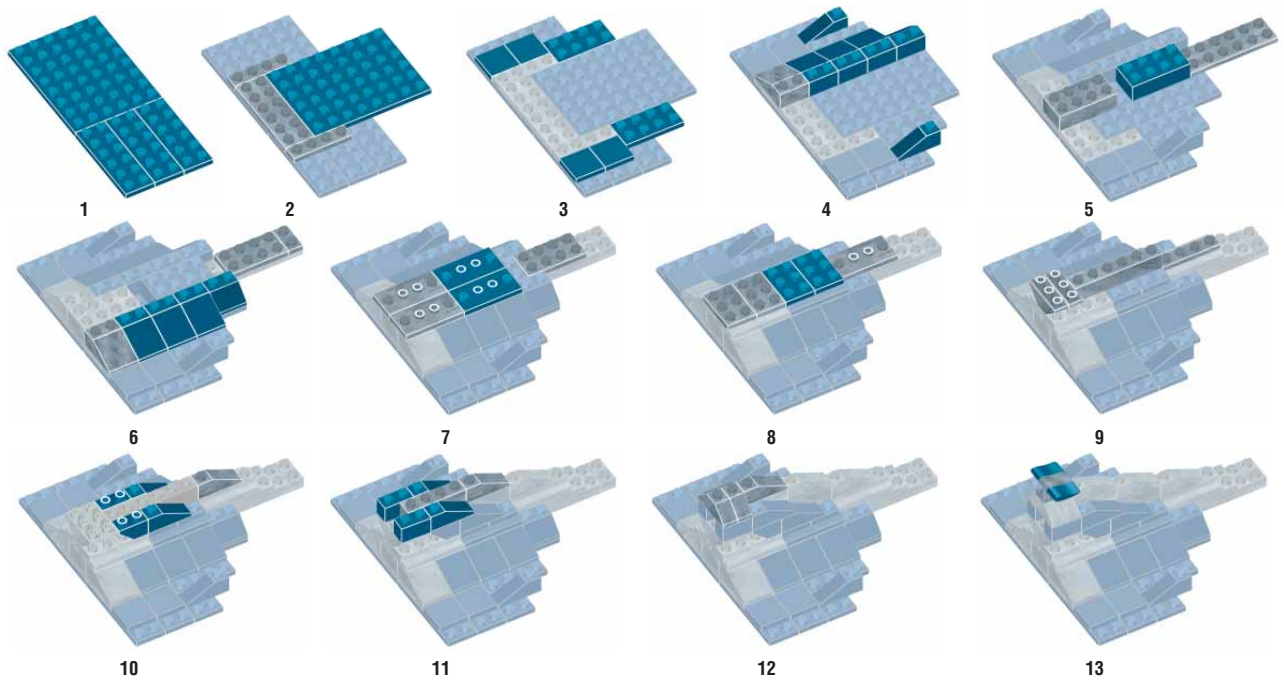
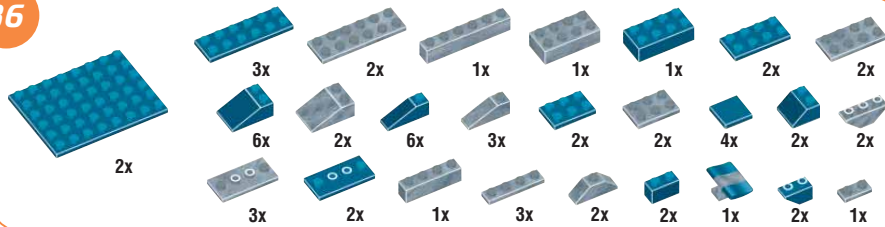

37

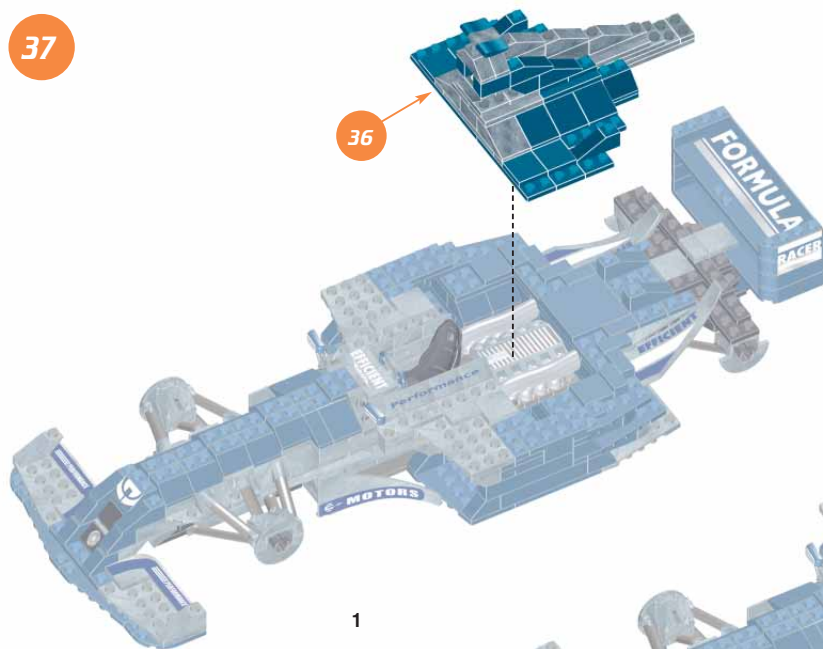

1



Apply stickers  
 Aplicar autoadhesivos  
 Apposer les autocollants  
 Stickers aanbrengen

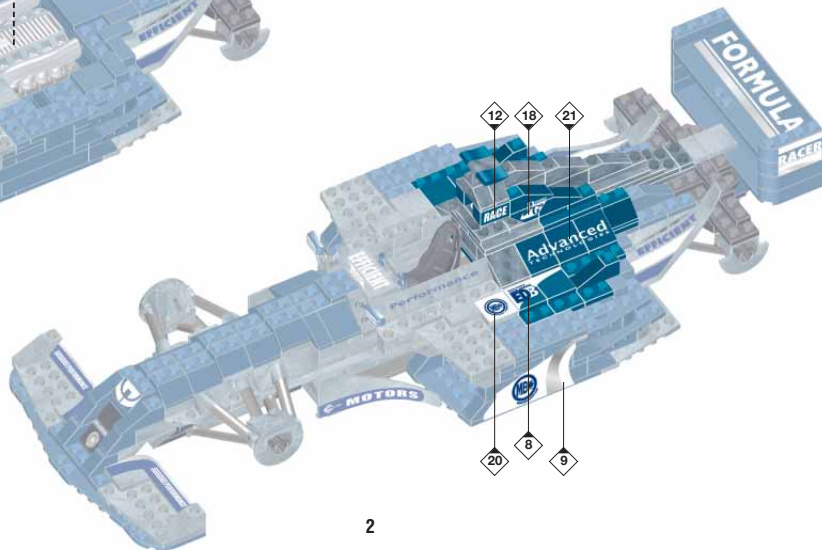

2

38



2x



2x



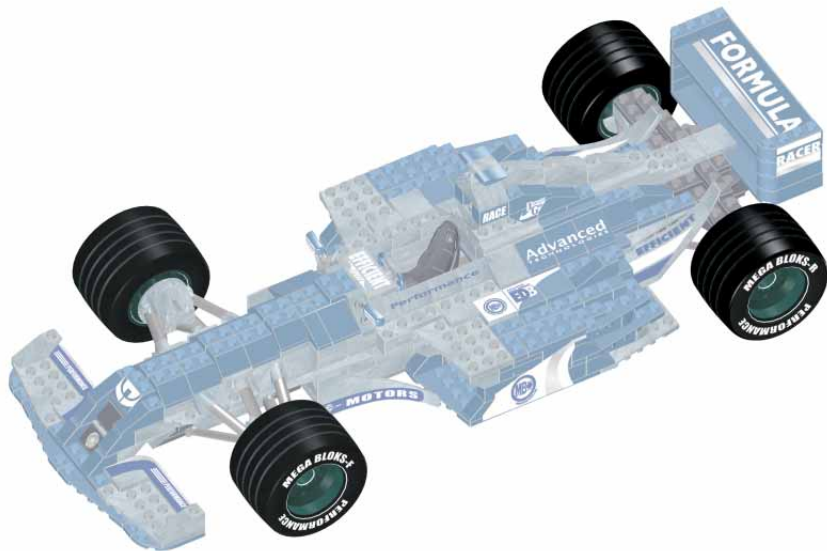

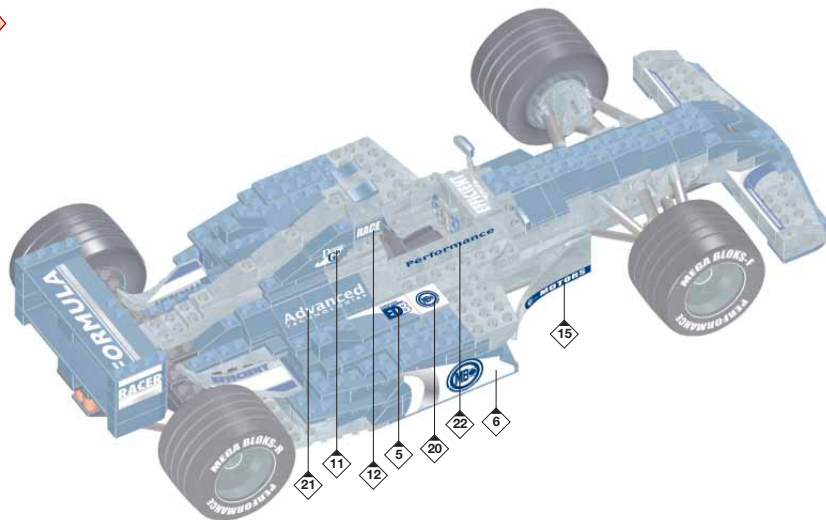

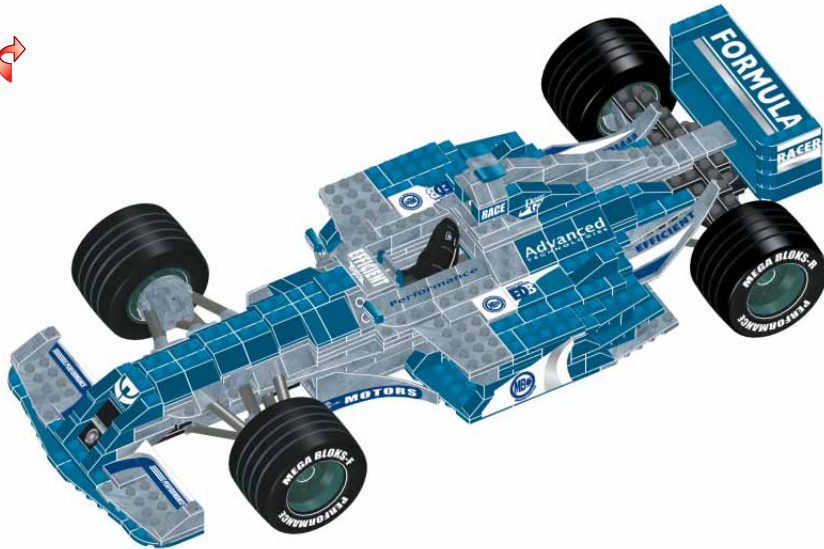

# Building Challenge • Desafío de construcción

*Rebuild a Dune Racer*  
*Reconstruir un Dune Racer*  
*Reconstruis un Dune Racer*  
*Assembleer een Duinracer*

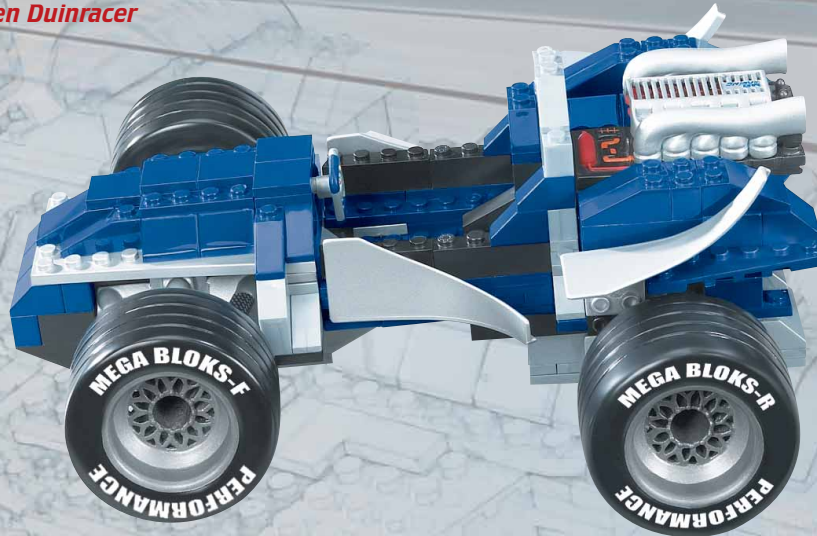

**Défi de construction • Bouwuitdaging**



## **Building Challenge • Desafío de construcción**

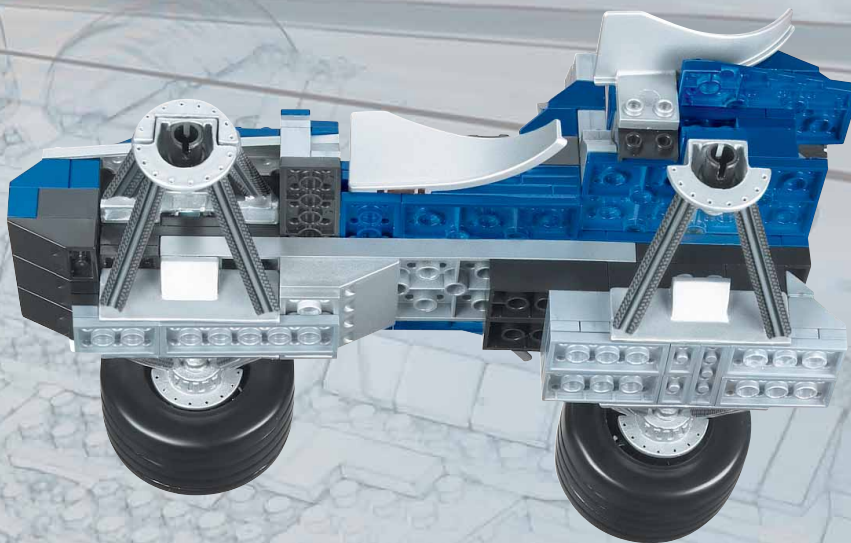

**Défi de construction • Bouwuitdaging**

# Building Challenge • Desafío de construcción

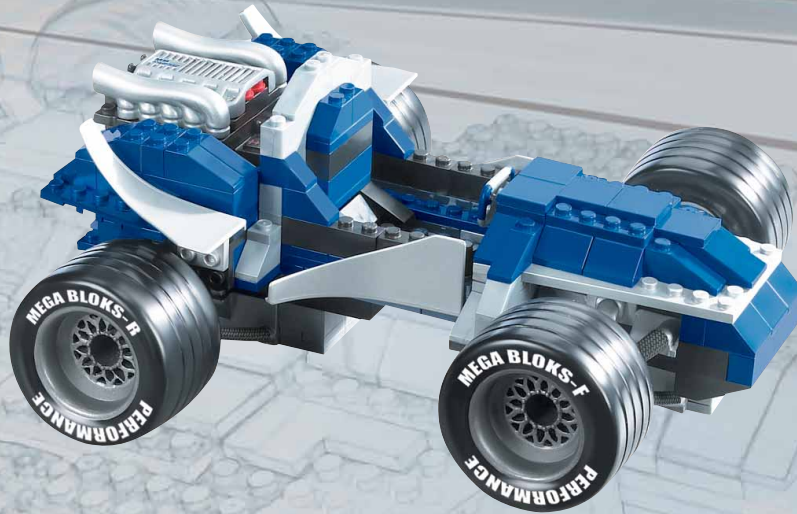

Défi de construction • Bouwuitdaging



North America consumer services  
Servicio al consumidor de Norteamérica  
Service à la clientèle, Amérique du Nord  
Consumentendienst Noord-Amerika

4505 Hickmore  
Montreal, QC  
H4T 1K4 CANADA

Rest of world consumer services  
Servicio al consumidor del resto del mundo  
Service à la clientèle, ailleurs dans le monde  
Consumentendienst rest van de wereld

Postbus 95  
B 9140 Temse  
BELGIUM

### We guarantee our products for life!

MEGA BLOKS products are guaranteed against defects in material and workmanship, excluding electronic components. Should you, as the original purchaser, encounter

such a defect in the course of normal use of our products:

- Send the defective part to the nearest Mega Bloks office
- Include a copy of your proof of purchase

### ¡Garantizamos nuestros productos de por vida!

Los productos MEGA BLOKS están garantizados contra defectos en los materiales y mano de obra, excluyendo los componentes electrónicos. Si usted, como comprador original,

encuentra dicho defecto en el curso del uso normal de nuestros productos:

- Envíe la parte defectuosa a la oficina de Mega Bloks más cercana.



We will repair or replace the product completely FREE OF CHARGE.

• Incluya una copia de su prueba de compra.  
Repararemos o reemplazaremos el producto completamente SIN COSTO.

- Ask about availability at your local retail store.
- Pregunte por la disponibilidad de este producto en tu tienda de juguetes.
- Demandez à votre détaillant local si le produit est disponible.
- Interesse, neem contact op met jouw plaatselijke verkooppunt.



Contact us!  
1-800-465-MEGA  
Call toll free between  
9 a.m. and 5 p.m. (EST)  
[www.megabloks.com](http://www.megabloks.com)

¡Comuníquese con nosotros!  
1-800-465-MEGA  
Llame gratis entre las  
9 a.m. y las 5 p.m. (EST)  
[www.megabloks.com](http://www.megabloks.com)

Communiquiez avec nous!  
1-800-465-MEGA  
Appelez sans frais  
entre 9 h et 17 h (HNE)  
[www.megabloks.com](http://www.megabloks.com)

**MEGA  
BLOKS**

# FIRE & ICE Dragons™



**9858  
DRAGON  
MOUNTAIN™**



**9879  
VORGAN  
ICE FANG™**



**Portal of Fire™ 9889**



**Fire Storm Fortress™ 9887**



**Frost Dragon™ 9893**



**Flame Dragon™ 9874**

**Ice Dragon™ 9875**

**Smoke Dragon™ 9892**



**Dragons DVD Movie**

**MEGA  
BLOKS**

# COMMAND OPS



**5530  
SECURE  
THE DAM™**



**5522  
SECRET CASE  
CAPTURE**



Satellite Rescue 5521



Laser Recon 5512



Laptop Recovery 5511



Scanner Recon 5502



Cellular Capture 5503



White Ops  
Whitewash™  
5504



Night Ops  
Navigator™  
5505



Troop™ Builder  
5503

**MEGA  
BLOKS**

**nano**<sup>TM</sup>  
Building System

**Customz**<sup>TM</sup>



5909



5907



5908



5910



5951



5952



5954



5901



5902



5903



5904



5905



5906



# PROBUILDER®

Also available  
También disponible  
Également disponible  
Eveneens beschikbaar

## Speed Bike

## 3702

4.6 in / 11.69 cm

8.5 in / 21.6 cm

2.5 in / 6.35 cm

Functional suspension  
Suspensión funcional  
Suspension fonctionnelle  
Doelmatige vering

Stabilized motion  
Movimiento estabilizado  
Mouvement stabilisé  
Stabiele voortbeweging

Ford Oval and Ford GT are registered trademarks  
owned and licensed by Ford Motor Company.



FX Striker™ 3701



Speed Bike 3702



Ford GT 9710



AirForce Warthog 3707



USS NIMITZ 9795



Steam Express 9778

**MEGA  
BLOKS**

# PROBUILDER<sup>®</sup>

**3706**  
Grand Prix  
Racer



Rebuild a Dune Racer  
Reconstruir un Dune Racer  
Reconstruis un Dune Racer  
Assembleer een Duinracer



15.4 In. / 39 cm



Authentic Detailed Parts  
Piezas auténticas detalladas  
Pièces détaillées authentiques  
Authentieke Gedetailleerde Onderdelen



Also Available / También disponible  
Egalement disponible / Eveneens beschikbaar



FX Striker<sup>®</sup> 3701



Speed Bike 3702



Air Force Warthog 3707



Steam Express 9778

**MEGA  
BLOKS**

© 2004, MEGA BLOKS INC.  
© and <sup>™</sup> denote Trademarks of MEGA BLOKS INC.  
© y <sup>™</sup> designan la marca registrada y la marca comercial de MEGA BLOKS INC.  
© et <sup>™</sup> désignent les marques de commerce de MEGA BLOKS INC.  
© en <sup>™</sup> duiden op handelsmerken van MEGA BLOKS INC.

PRINTED IN CANADA D037062