

IRON MAN



**MEGA
BLOKS**

1977 | Mark VI Techbot™



8x
AM01798AKL



2x
AS0197707



4x
AS0197708



4x
AM16866AKM



1x
AM16868AKM



1x
AM16542AKM



1x
AM16538AKL



2x
AM09738AKM



2x
AS0197706



1x
AM15615KM



1x
AS0197712



1x
AS0197713



1x
AM16213AKM



1x
AS0197709



2x
AS0197702



1x
AS0197704



1x
AS0197703



1x
AS0197705



2x
AM16866AKM



1x
AM16543AKM



1x
AS0197701



1x
AM16537AKM



1x
AM16536AKM



4x
AM09731AKM



2x
AM09731AKL



2x
AM09727AKM



2x
AM16867AKM



1x
AS0197710



1x
AS0197711



1x
AM16869W



1x
AS0197714

EN Please read these instructions carefully before first use and keep them for future reference. / **ES** Leer estas instrucciones cuidadosamente antes de la primera utilización y guardarlas para referencia futura. / **FR** Il est recommandé de lire attentivement ce feuillet avant la première utilisation et de le conserver pour référence future. / **DE** Die Gebrauchsanleitung bitte durchlesen und aufbewahren. / **NL** Wij raden u aan deze handleiding zorgvuldig te lezen en te bewaren voor eventuele raadpleging op een later tijdstip. / **IT** Leggere le istruzioni prima di cominciare ad usare il gioco e conservarle per referenze future. / **PT** Leia as instruções antes do primeiro uso e guarde-as para futura referência.

EN ⚠ **WARNING:**
CHOKING HAZARD. - Small parts.
Not for children under 3 years.

ES ⚠ **ADVERTENCIA:**
PELIGRO DE ASFIXIA. - Contiene piezas pequeñas. No recomendado para niños menores de 3 años.

FR ⚠ **AVERTISSEMENT:**
RISQUE DE SUFFOCATION. - Présence de petits éléments. Ne convient pas aux enfants de moins de 3 ans.

DE ⚠ **WARNUNG:**
ERSTICKUNGSGEFAHR. - Enthält kleine Teile.
Nicht für Kinder unter 3 Jahren geeignet.

NL ⚠ **WAARSCHUWING:**
VERSTIKKINGSGEVAAR. - Bevat kleine onderdelen. Niet geschikt voor kinderen onder de 3 jaar.

DA ⚠ **ADVARSEL:**
KVÆLNINGSFARE. - Indeholder smådele.
Ikke til børn under 3 år.

EL ⚠ **ΠΡΟΕΙΔΟΠΟΙΗΣΗ:**
ΚΙΝΔΥΝΟΣ ΠΝΙΞΙΜΑΤΟΣ. - Περιέχει μικρά αντικείμενα. Όχι για παιδιά κάτω των 3 ετών.

FI ⚠ **VAROITUS:**
TUKEHTUMISVAARA. - Sisältää pieniä osia.
Ei alle 3-vuotiaalle lapsille.

IT ⚠ **ATTENZIONE:**
PERICOLO DI SOFFOCAMENTO. - Contiene piccole parti. Non indicato per bambini sotto i 3 anni.

NO ⚠ **ADVARSEL:**
KVELNINGSFARE. - Inneholder små deler.
Kun for barn over 3 år.

PT ⚠ **ATENÇÃO:**
PERIGO DE ASFIXIA. - Contém peças pequenas. Não é concebido para crianças de menos de 3 anos.

SV ⚠ **VARNING:**
KVÄVNINGSRISK. - Innehåller små delar.
Inte för barn under 3 år.

JA ⚠ **警告:**
窒息の危険性 - 小さな部品が含まれています
3歳以下の子供には与えないで下さい。

ZH ⚠ **警告:**
有窒息危險。 - 包含有小部件
不适合3岁以下的的小孩玩。

AR ⚠ **تحذير:**
خطر اختناق - قطع صغيرة.
غير صالحة للأطفال أقل من 3 سنوات.





4x



1x



1x



1x

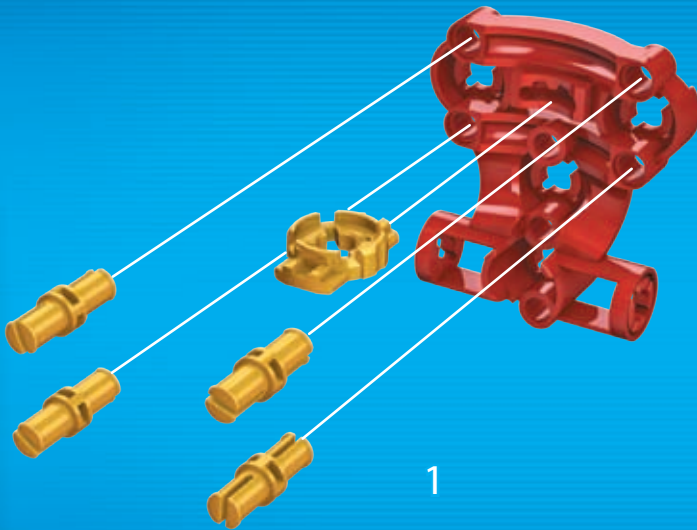

1

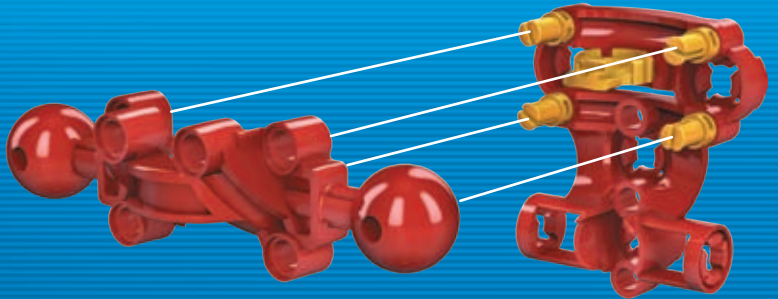

2

2



2x



1x

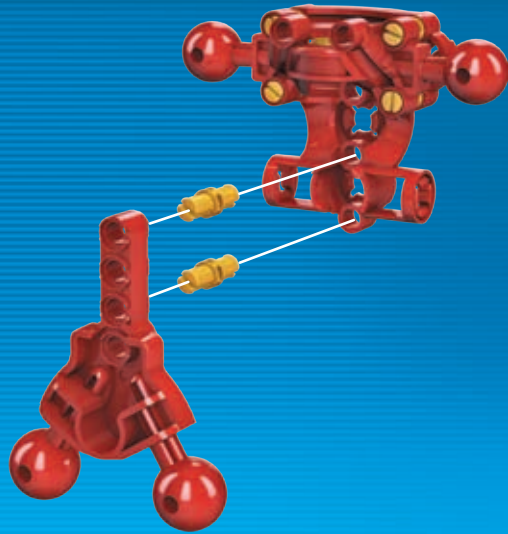

3



1x



4



2x



2x



2x



2x



2x



2x

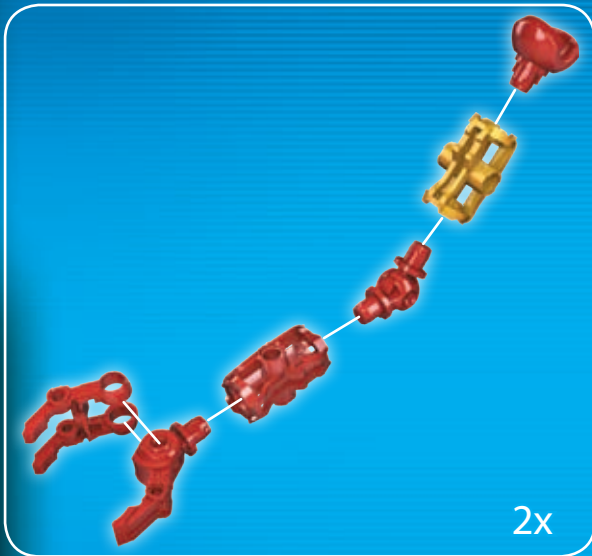

2x

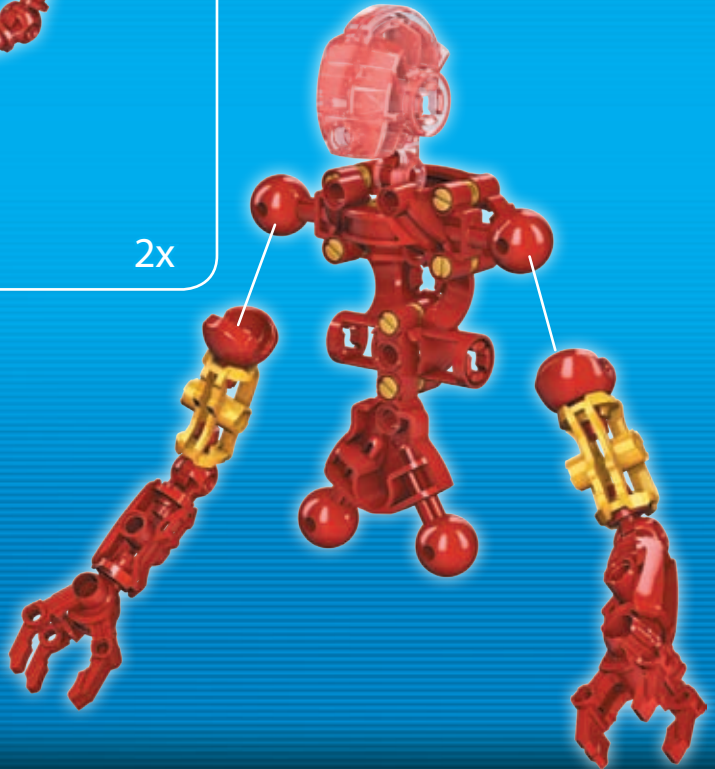

6



2x



1x



1x



2x

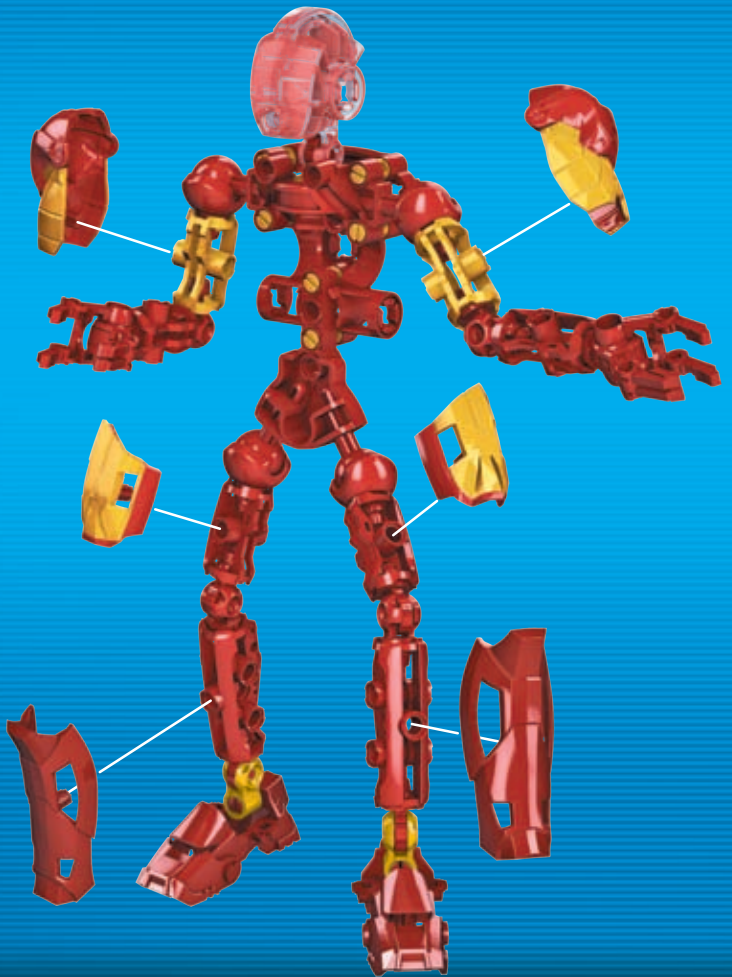

7



1x

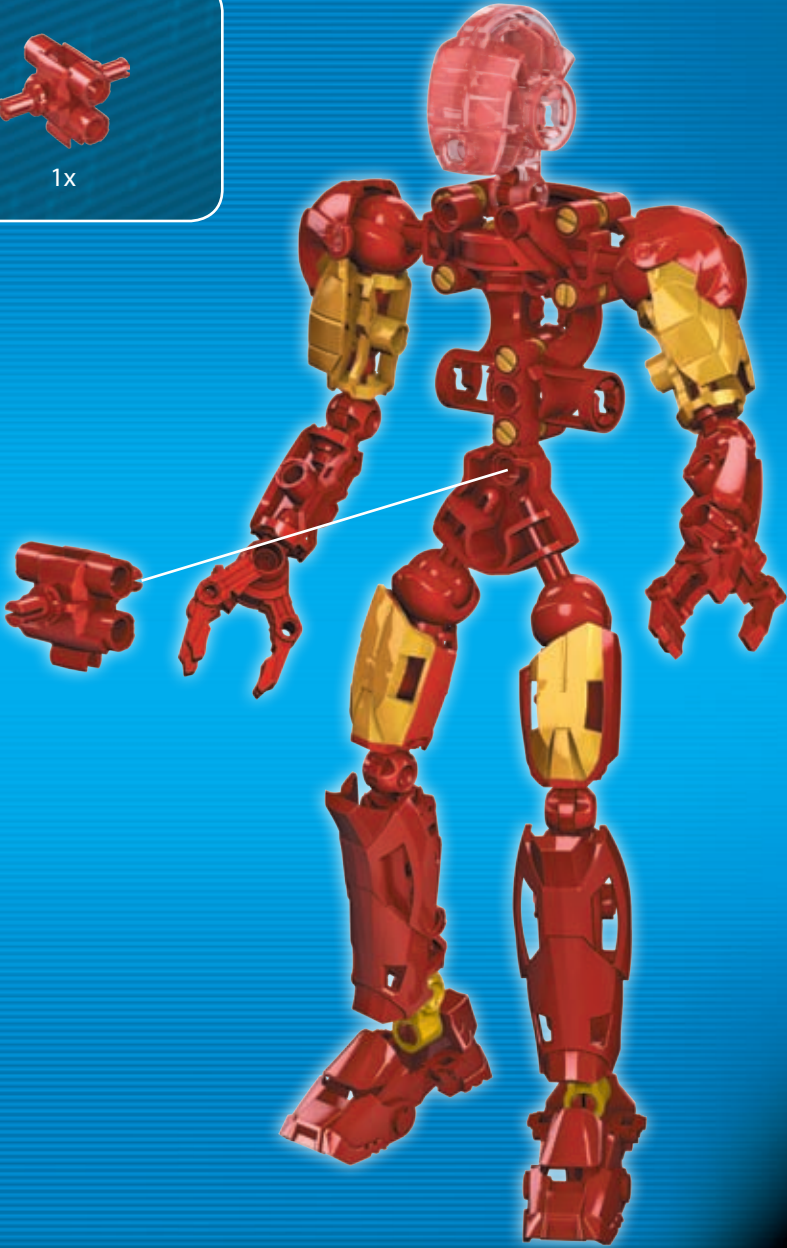

8



1x



1x

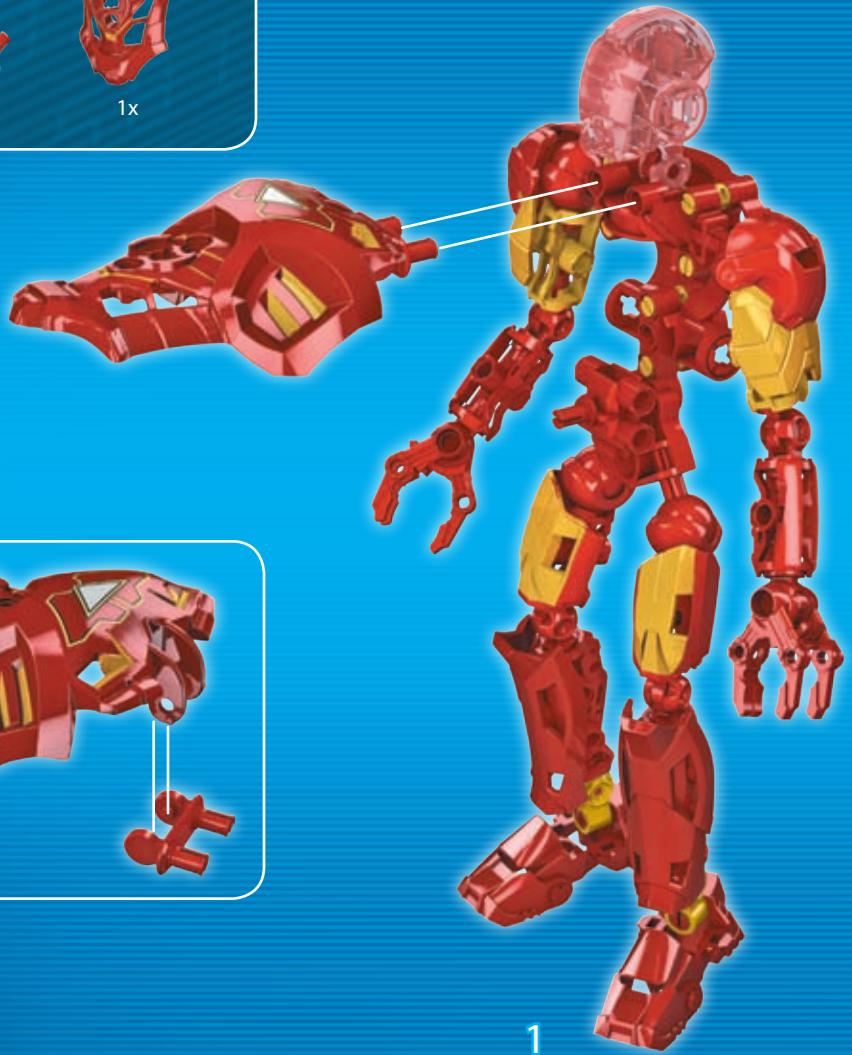



2



1x



10



1x



1x





WORKING LAUNCHER
LANZADOR EN FUNCIONAMIENTO
LANCEUR EN ACTION
FUNKTIONIERENDER STARTER
WERKENDE LANCEERINSTALLATIE
LANZADOR EN FUNCIONAMIENTO
LANCIATORE FUNZIONANTE



- EN** CAUTION! Do not aim at eyes or face.
ES ¡ADVERTENCIA! NO dirigir nunca los proyectiles hacia los ojos o la cara.
FR ATTENTION! Ne pas viser les yeux ou le visage.
DE VORSICHT! Nicht auf das Gesicht oder die Augen richten.
NL LET OP: Niet op ogen of gezicht richten.
DA ADVARSEL! Peg ikke i retning af øjne eller ansigt.
EL ΠΡΟΣΟΧΗ! Να μην σκοπεύετε προς τα μάτια ή το πρόσωπο.
FI VARO! Älä tähtää silmiin tai kasvoihin.
IT Attenzione! Non puntare verso gli occhi o il viso.
NO FØRSIKTIG! Sikt ikke mot øyne eller ansikt.
PT ATENÇÃO: Não apontar para os olhos ou o rosto.
SV VAR FÖRSIKTIG! Rikta inte med ögon eller ansikte.
JA 注意！目や顔に使用しないで下さい。
ZH 警告！不要对准眼睛或脸。
AR تنبيه! لا توجه للعينين أو الوجه

Use only the projectiles included with this toy.
Utilizar solamente los proyectiles incluidos con el juguete.
Utiliser seulement les projectiles fournis avec le jouet.
Nur die mit dem Spielzeug mitgelieferten Projektile verwenden.
Alleen de met het speelgoed bijgeleverde projectielen gebruiken.
Utilizzare soltanto i proiettili forniti con questo giocattolo.
Usar somente os projéteis incluídos com este brinquedo.
استخدم فقط القذيفة المرافقة لهذه اللعبة



OR /
O / OU /
ODER / OF





1x



1x



1x



1x



1x



1x



BUILD, PLAY & DISPLAY
CONSTRUIR, JUGAR Y MOSTRAR
CRÉE, JOUE ET EXPOSE

BAUEN, SPIELEN UND ZUR SCHAU STELLEN
BREIDT UIT, SPEEL EN LAAT ZIEN
COSTRUISCI, GIOCA E MOSTRA
MONTAR, JOGAR E VER



1



2



1x



1x



1x



1x



1x



1x



STAND, FLY OR HOVER
 IDE PIE, VOLAR O
 PLANEAR!
 POSE-TOI, VOLE OU
 FAIS DU SURPLACE!

STA, VLIEG OF ZWEEF!
 STEHEN, FLIEGEN ODER
 SCHWEBEN
 ALZATI, VOLA O RIMANI
 SOSPESO!
 PARAR, VOAR OU
 PAIRAR!



1



2



BUILD, PLAY & DISPLAY
CONSTRUIR, JUGAR Y MOSTRAR
CRÉE, JOUE ET EXPOSE

BAUEN, SPIELEN UND ZUR SCHAU STELLEN
BREIDT UIT, SPEEL EN & LAAT ZIEN
COSTRUISCI, GIOCA E MOSTRA
MONTAR, JOGAR E VER



1



2

IRON MAN

STARK INDUSTRIES



1956



1955



1973



1980



Collect Them All! • Colecciónalos todos! • Collectionne-les tous!
Alle sammeln! • Verzamel ze allemaal • Coleccionail tutti • Colecciona todos!



1980



1974



1973



1955



1956



1974

www.megabrands.com

© 2009, MEGA Brands Inc.
MEGA Brands Inc. and the MEGA Brands Inc. logo are registered trademarks of MEGA Brands Inc.
MEGA Brands Inc. y el logotipo MEGA Brands Inc. son marcas registradas de MEGA Brands Inc.
MEGA Brands Inc. et le logo de MEGA Brands Inc. sont des marques de commerce déposées de MEGA Brands Inc.
MEGA Brands Inc. und das MEGA Brands Inc.-Logo sind eingetragene Warenzeichen von MEGA Brands Inc.
MEGA Brands Inc. en het MEGA Brands Inc. logo zijn gedeponeerde handelsmerken van MEGA Brands Inc.
MEGA Brands Inc. ed il logo di MEGA Brands Inc. sono marchi di fabbrica di MEGA Brands Inc.
MEGA Brands Inc. e o logo MEGA Brands Inc. são marcas registradas de MEGA Brands Inc.



Printed in China

AD019771