

**MEGA  
BLOKS**

# TEENAGE MUTANT NINJA TURTLES

**1411**

**6+** Ages/Edades  
Åges/Leeftijden











**290** Pieces/Piezas  
Pièces/Stuks







COMES WITH  
SE INCLUYE  
**OOZE**  
INCLUS  
INBEGREPEN

**Battle Shell Bridge**









1411 BATTLE SHELL BRIDGE PARTS LIST / LISTA DE PIEZAS / LISTE DE PIÈCES / ONDERDELENLIJST

	<b>5x</b> M1113A
	<b>5x</b> M1113JN
	<b>2x</b> M1140N
	<b>1x</b> S1124F
	<b>2x</b> M0910N
	<b>4x</b> M0910JB
	<b>2x</b> M1086JB
	<b>4x</b> M02250GH
	<b>8x</b> M02250GP
	<b>4x</b> M02250F
	<b>10x</b> M0948JB

	<b>1x</b> M09393N
	<b>4x</b> M09393F
	<b>26x</b> M09393JB
	<b>4x</b> AM01314JB
	<b>1x</b> M09593N
	<b>9x</b> M09593JB
	<b>2x</b> M1389JB
	<b>2x</b> M1390JB
	<b>12x</b> M09493F
	<b>13x</b> M09493JB

	<b>9x</b> M1480F
	<b>6x</b> M1480JB
	<b>6x</b> M09013JB
	<b>8x</b> M09013MM
	<b>4x</b> M1133N
	<b>4x</b> M11101F
	<b>1x</b> M1419JB
	<b>6x</b> M1087JB
	<b>1x</b> AM01313N
	<b>5x</b> AM01313JB

	<b>2x</b> M10233JB
	<b>9x</b> AM01322JB
	<b>2x</b> AM01322N
	<b>4x</b> M1417JB
	<b>10x</b> M1323JB
	<b>2x</b> M1323N
	<b>4x</b> AM02800JB
	<b>4x</b> AM02800N
	<b>4x</b> M10273JB
	<b>6x</b> M10273MM
	<b>5x</b> M09023JB

	<b>19x</b> M09033JB
	<b>8x</b> M09033DO
	<b>3x</b> M1142N
	<b>10x</b> M1141JB
	<b>4x</b> M1367N
	<b>1x</b> S1163N
	<b>2x</b> AM02046DO

1411 BATTLE SHELL BRIDGE PARTS LIST / LISTA DE PIEZAS / LISTE DE PIÈCES / ONDERDELENLIJST

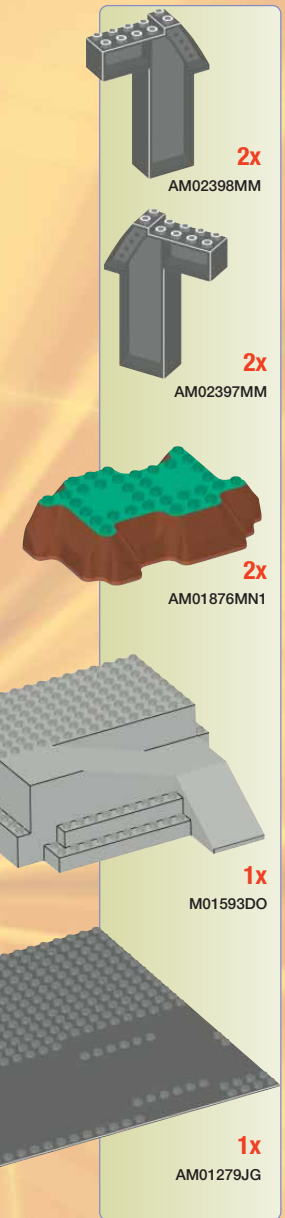
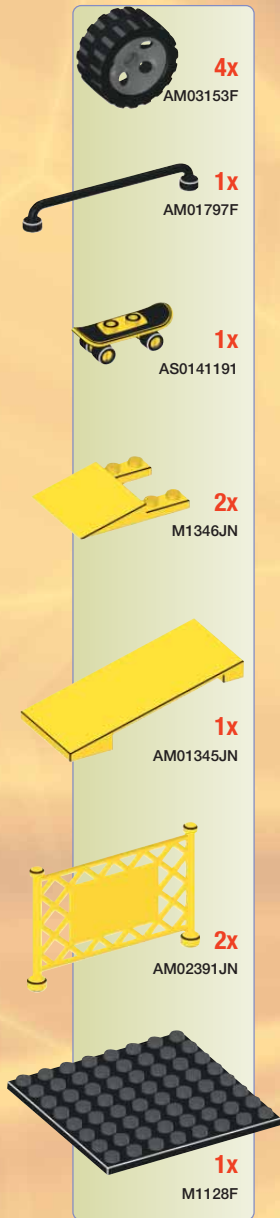

# 1411 BATTLE SHELL BRIDGE

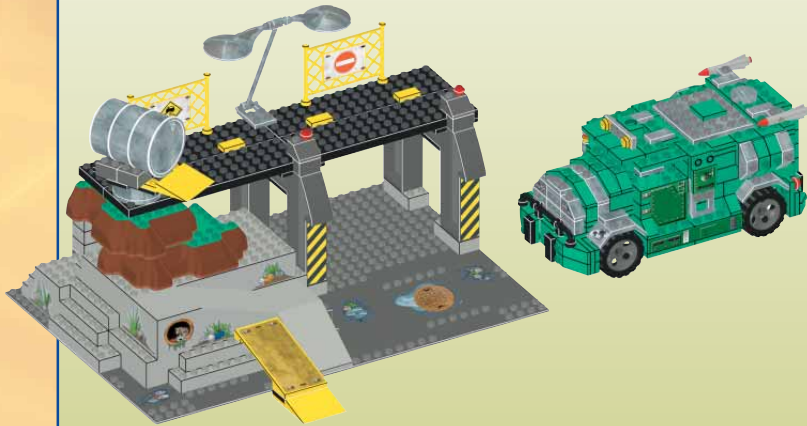

## Color chart. Cuadro cromático

## Charte de couleurs. Färgtabell.

## Kleurenkaart. Quadro cromatico.

## カラーチャート 色彩表

Active step / Etapa activa / Étape active / Aktivt skede  
Active step / Azione attiva / アクティブなステップ / 積極步驟

Previous step / Etapa precedente / Étape précédente  
Föregående skedet / Vorige stap / Azione precedente  
前のステップ / 上一步驟

Active step / Etapa activa / Étape active / Aktivt skede  
Active step / Azione attiva / アクティブなステップ / 積極步驟

Previous step / Etapa precedente / Étape précédente  
Föregående skedet / Vorige stap / Azione precedente  
前のステップ / 上一步驟

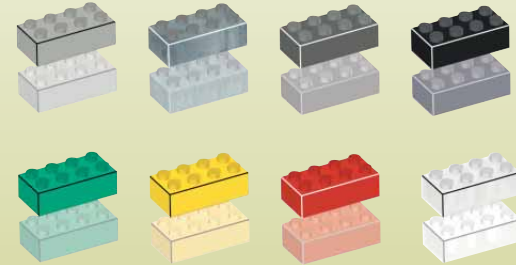

Please read these instructions carefully before first use and keep them for future reference.  
Leer estas instrucciones cuidadosamente antes de la primera utilización y guardarlas para referencia futura.  
Il est recommandé de lire attentivement ce feuillet avant la première utilisation et de le conserver pour référence future.  
Wij raden u aan deze handleiding zorgvuldig te lezen en te bewaren voor eventuele raadpleging op een later tijdstip.

**EN** ⚠ **WARNING:**  
**CHOKING HAZARD.** - Small parts.  
Not for children under 3 years.

**ES** ⚠ **ADVERTENCIA:**  
**PELIGRO DE ASFIXIA.** - Contiene piezas pequeñas.  
No recomendado para niños menores de 3 años.

**FR** ⚠ **AVERTISSEMENT:**  
**RISQUE DE SUFFOCATION.** - Présence de petits éléments.  
Ne convient pas aux enfants de moins de 3 ans.

**NL** ⚠ **WAARSCHUWING:**  
**VERSTIKKINGSGEVAAR.** - Bevat kleine onderdelen.  
Niet geschikt voor kinderen onder de 3 jaar.

**DE** ⚠ **WARNUNG:**  
**ERSTICKUNGSGEFAHR.** - Enthält kleine Teile.  
Nicht für Kinder unter 3 Jahren geeignet.

**DA** ⚠ **ADVARSEL:**  
**KVÆLNINGSFARE.** - Indeholder smådele.  
Ikke til børn under 3 år.

**EL** ⚠ **ΠΡΟΕΙΔΟΠΟΙΗΣΗ:**  
**ΚΙΝΔΥΝΟΣ ΠΝΙΞΙΜΑΤΟΣ.** - Περιέχει μικρά αντικείμενα.  
Όχι για παιδιά κάτω των 3 ετών.

**FI** ⚠ **VAROITUS:**  
**TUKEHTUMISVAARA.** - Sisältää pieniä osia.  
Ei alle 3-vuotiaille lapsille.

**IT** ⚠ **ATTENZIONE:**  
**PERICOLO DI SOFFOCAMENTO.** - Contiene piccole parti.  
Non indicato per bambini sotto i 3 anni.

**NO** ⚠ **ADVARSEL:**  
**KVELNINGSFARE.** - Inneholder små deler.  
Kun for barn over 3 år.

**PT** ⚠ **ATENÇÃO:**  
**PERIGO DE ASFIXIA.** - Contém peças pequenas.  
Não é concebido para crianças de menos de 3 anos.

**SV** ⚠ **WARNING!**  
**KVÄVNINGSRISK.** - Innehåller små delar.  
Inte för barn under 3 år.

**JA** ⚠ **警告:**  
窒息の危険性 小さな部品が含まれています  
3歳以下の子供には与えないで下さい。

**ZH** ⚠ **警告:**  
有窒息危險。包含有小部件  
不适合3岁以下的小孩玩。



1x  
AL014111



Apply stickers  
Aplicar autoadhesivos  
Apposer les autocollants  
Stickers aanbrengen

Figures / Weapons • Figuras / Armas  
Figurines / Armes • Krijgerfiguurtjes /  
Wapens



Section 1 • Sección 1  
Section 1 • Deel 1

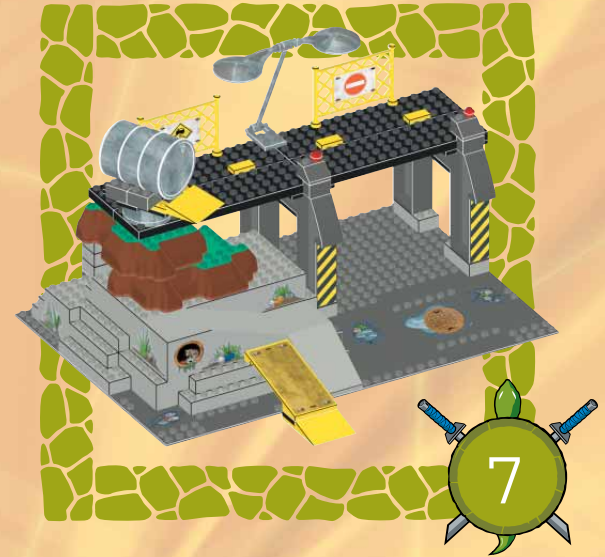

Section 2 • Sección 2  
Section 2 • Deel 2



- Build Battle Shell Bridge in sections
- Construir Battle Shell Bridge en secciones
- Construis Battle Shell Bridge par section
- Bouw Battle Shell Bridge in delen



Page / Página /  
Page / Bladzijde

# TEENAGE MUTANT NINJA TURTLES™

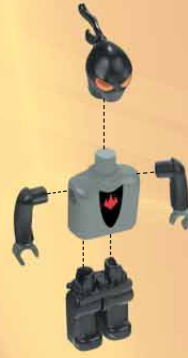

1



2



3



1



2



3



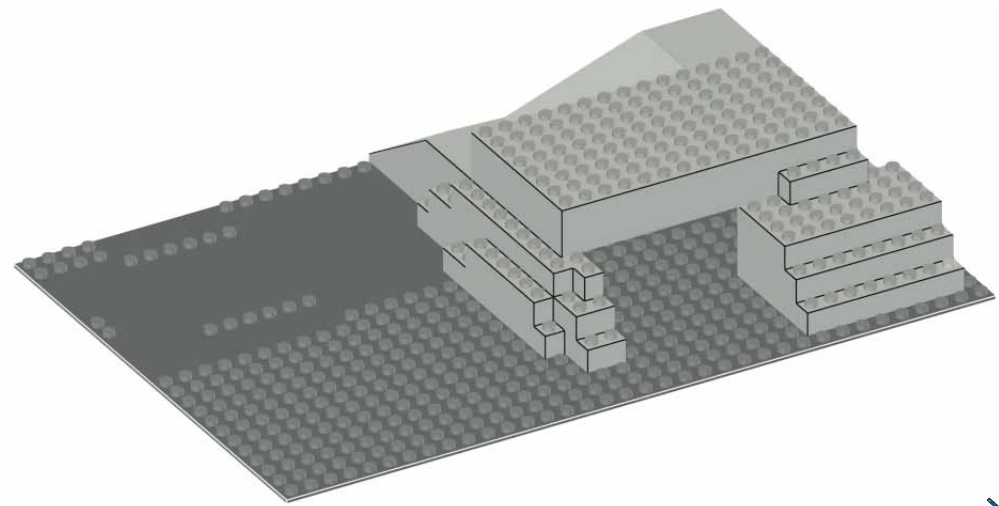
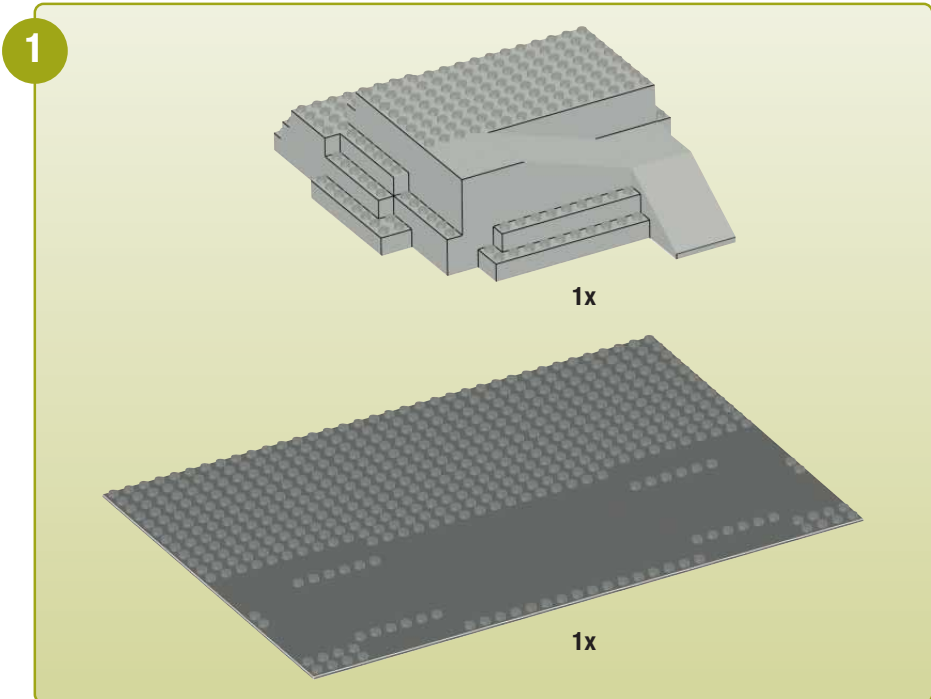
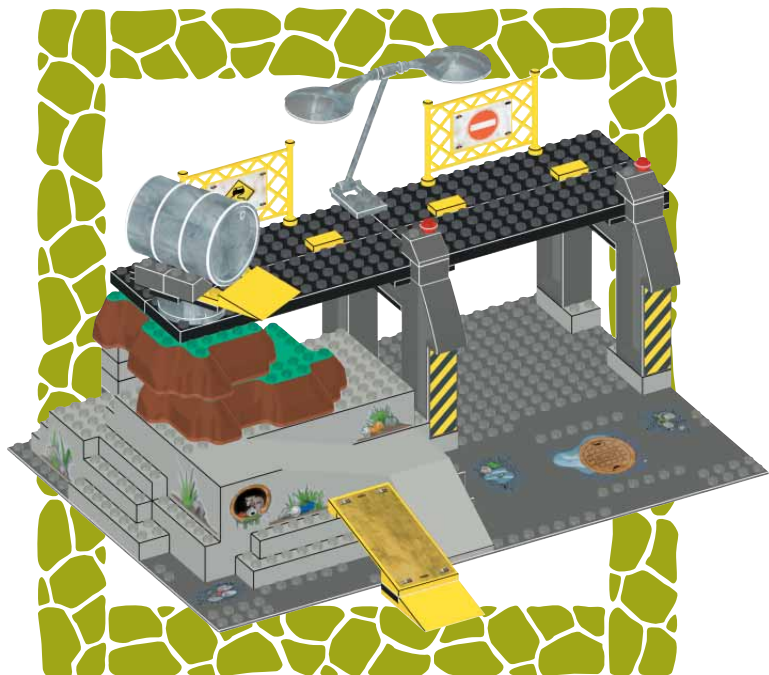

2

4x 4x

1 2

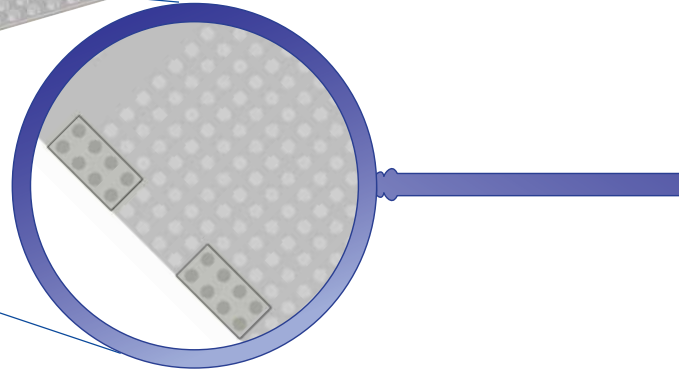
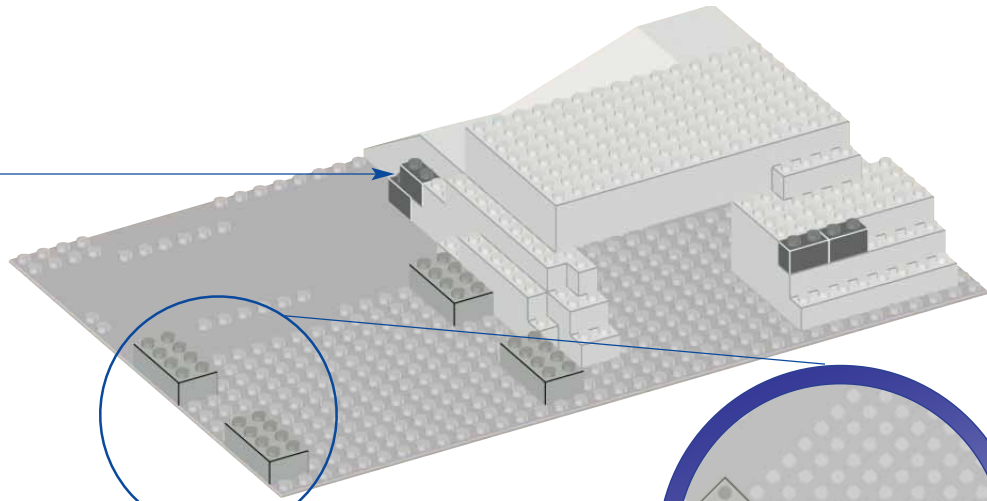

3

4x

1 2

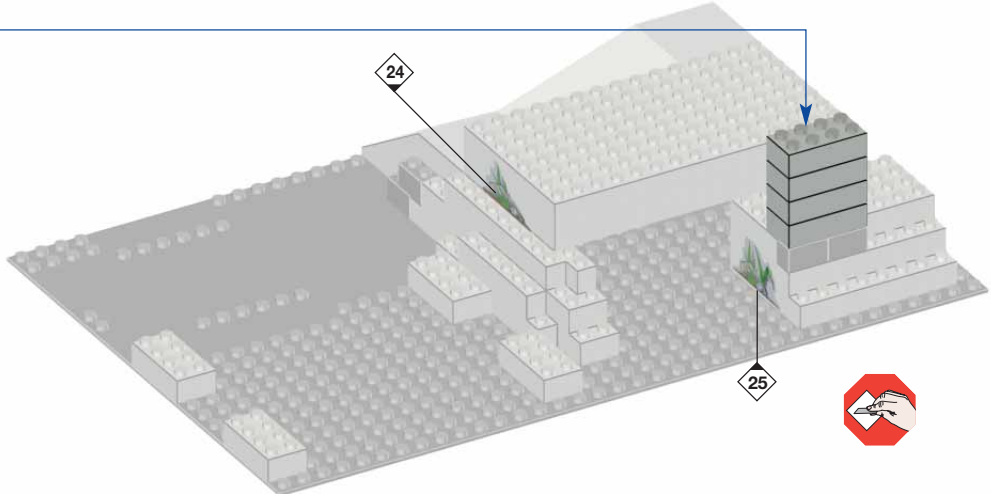



4



6x



2x

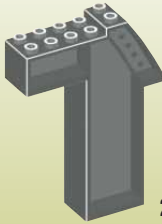

2x



2x

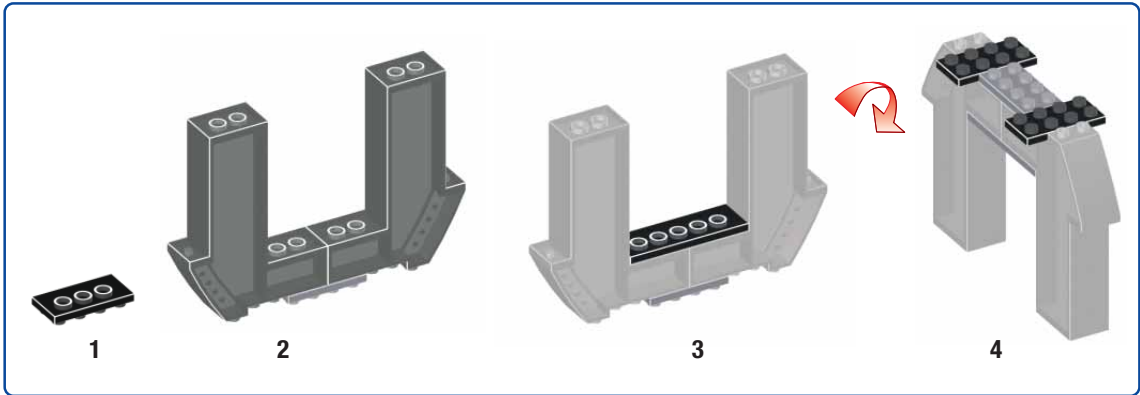

2x

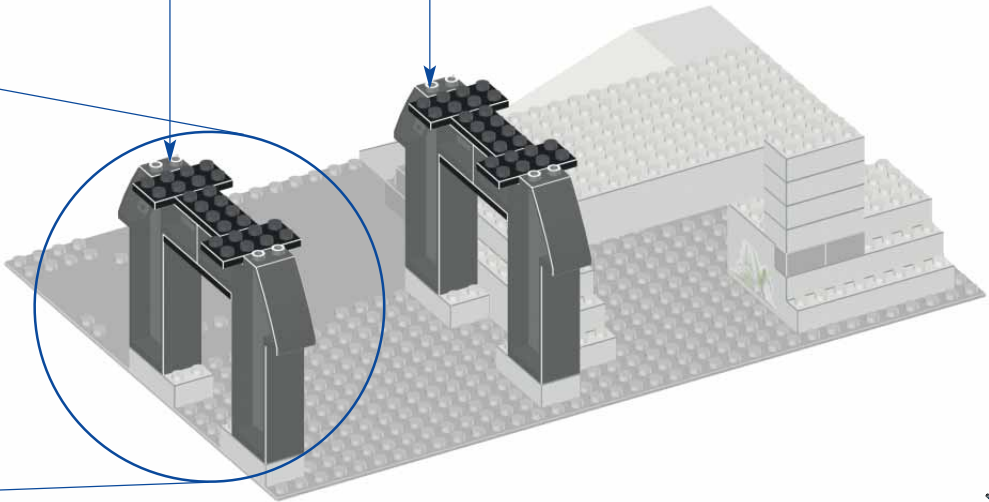
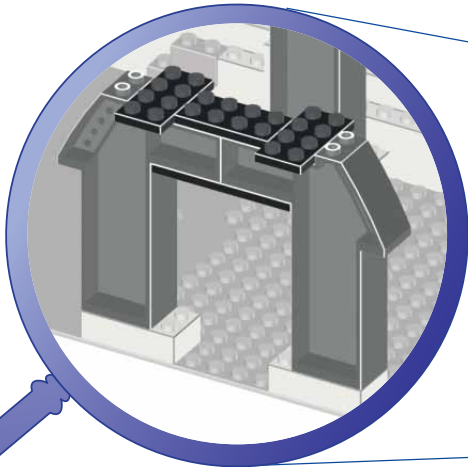

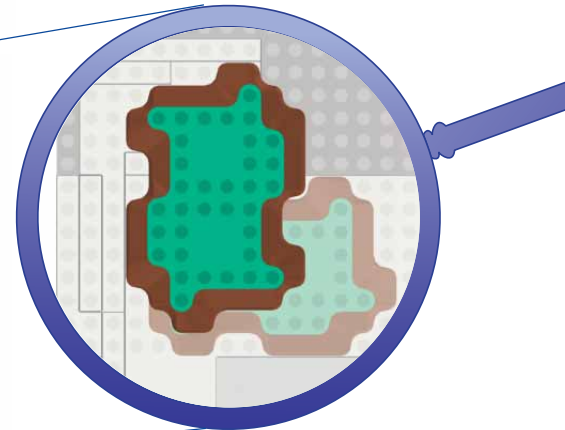
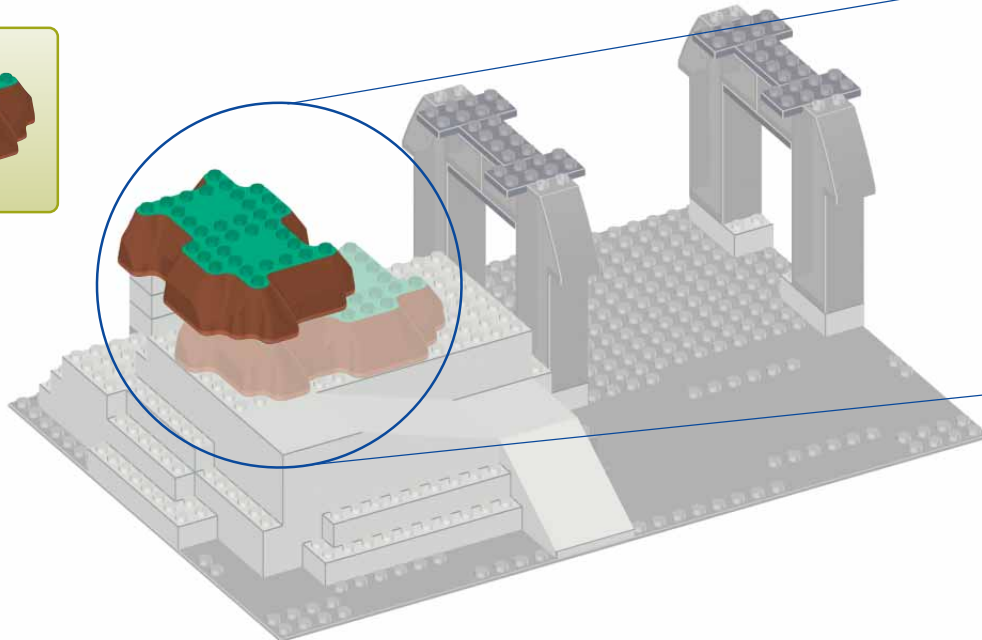
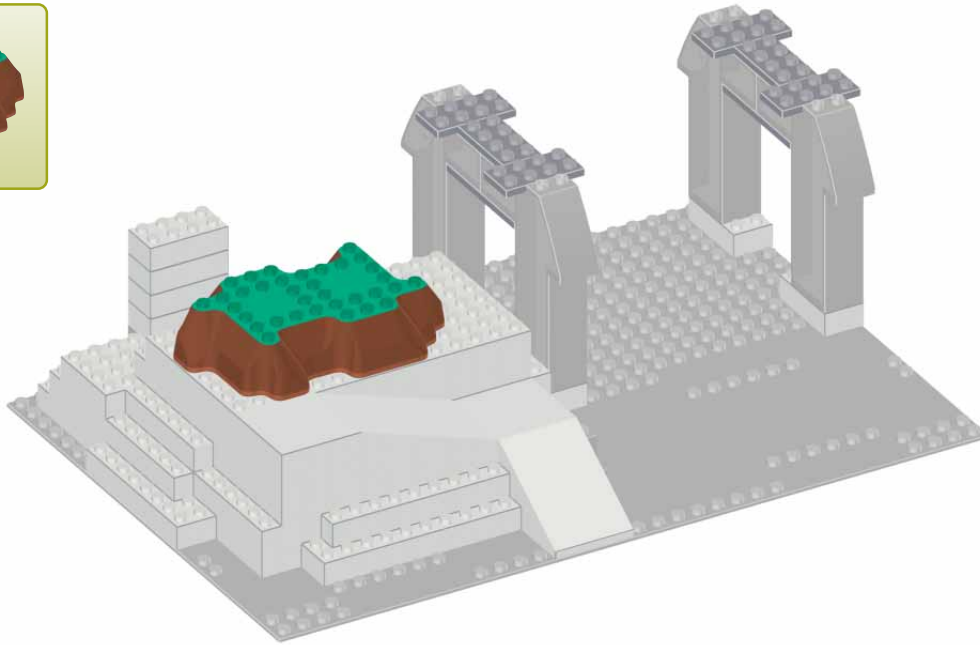
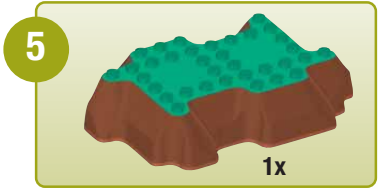

7



4x

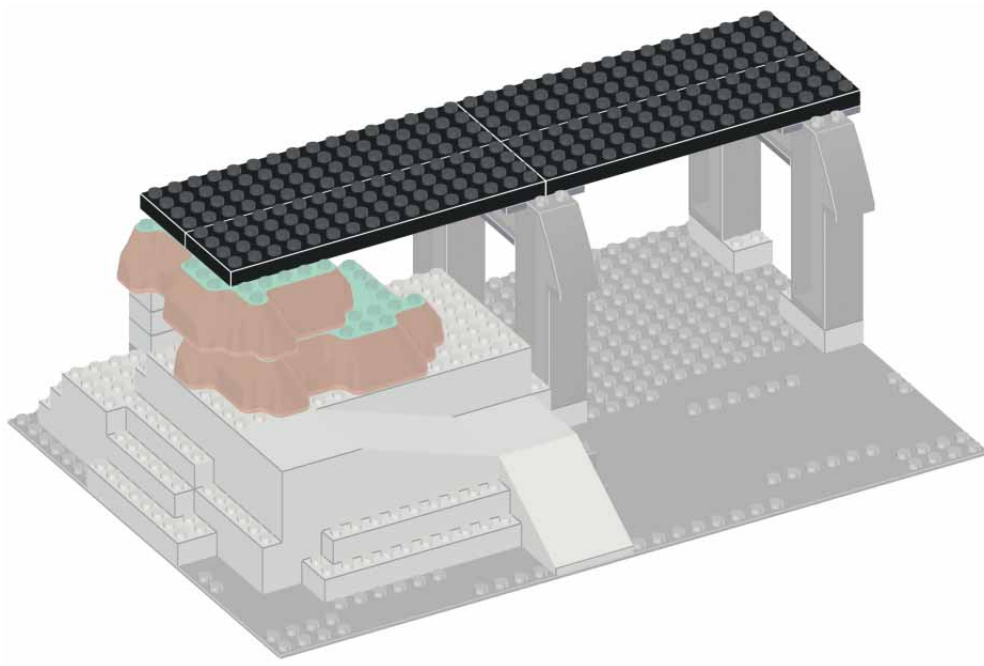

8



2x



4x



1x



1x



1x

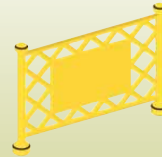

2x



1



2



3

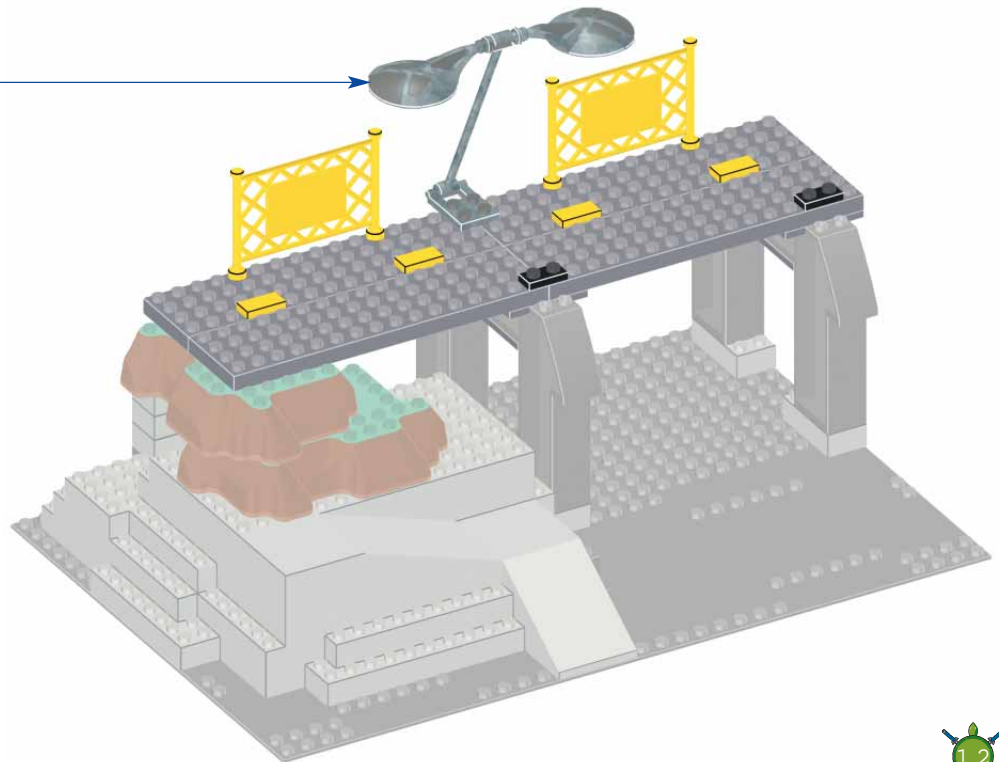

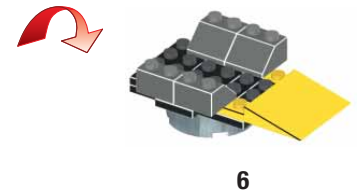
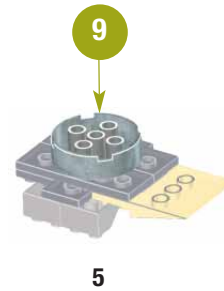
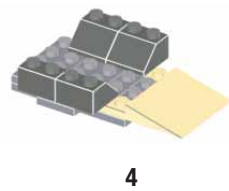
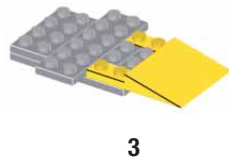
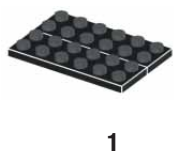
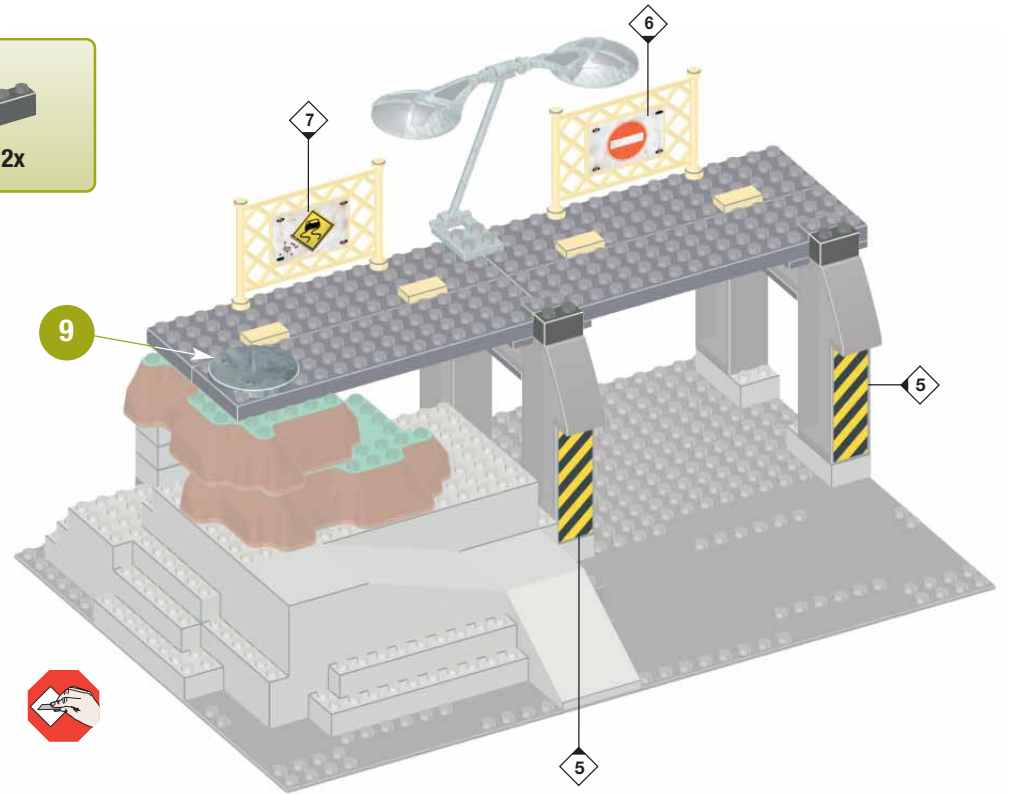
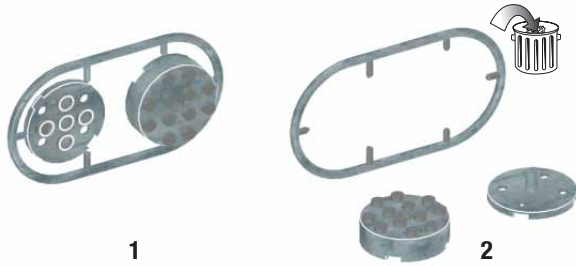
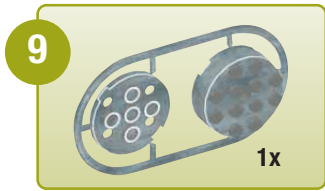

12



2x

11

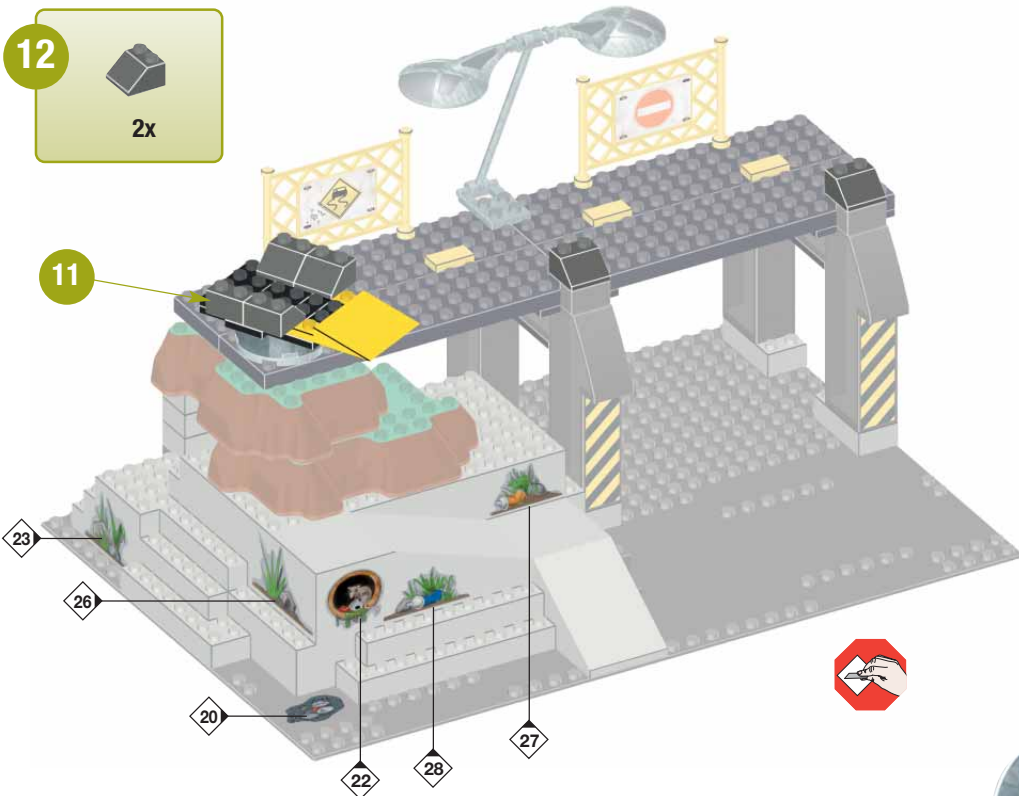

13



2x



1x



1x

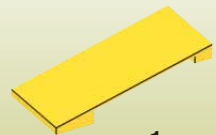

1x



1x

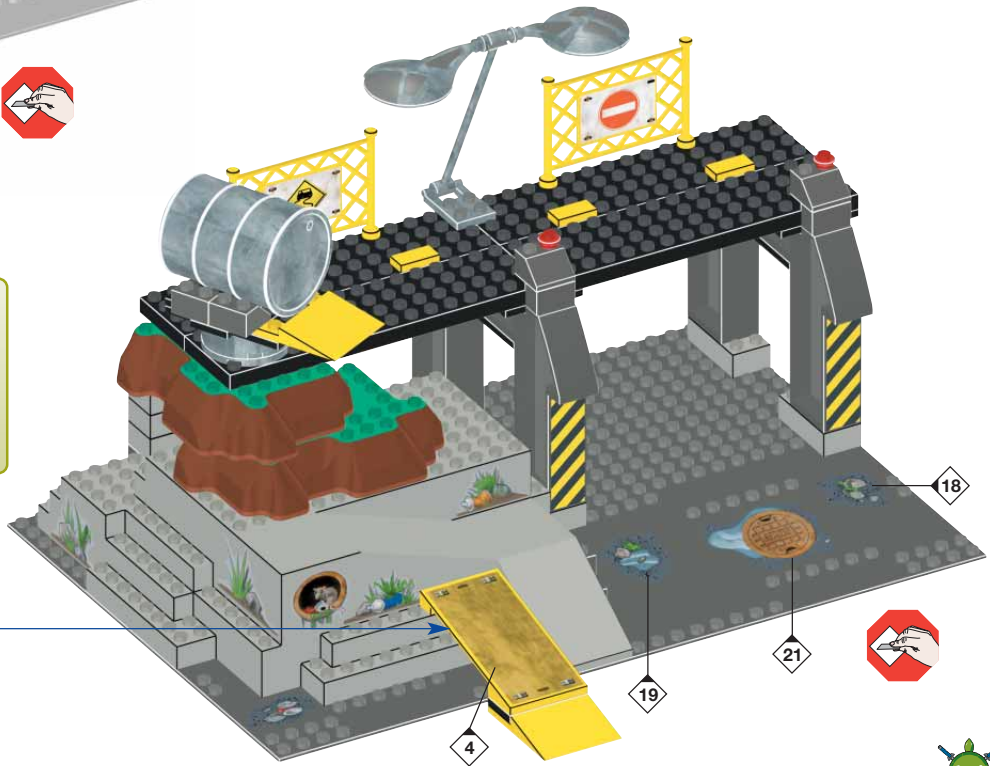
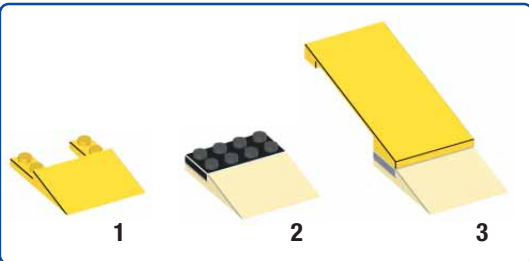

# TEENAGE MUTANT NINJA TURTLES™

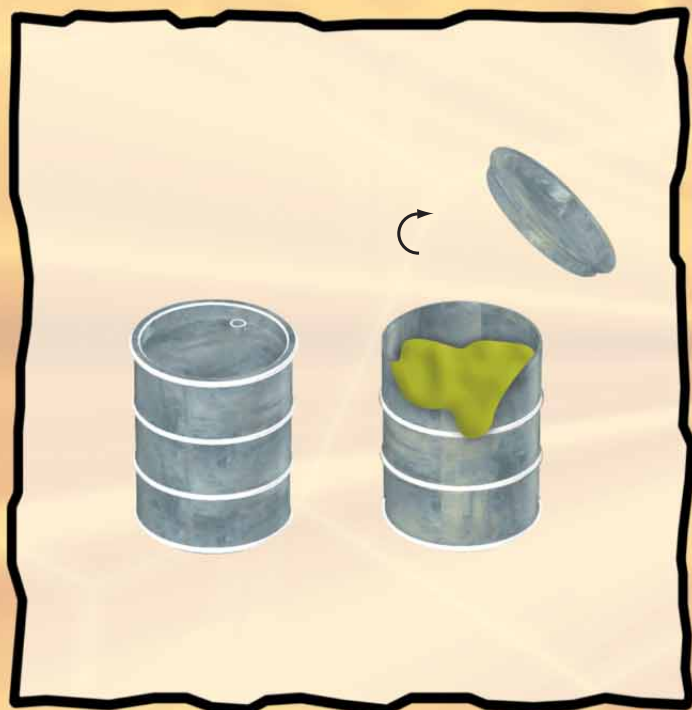

# TEENAGE MUTANT NINJA TURTLES™





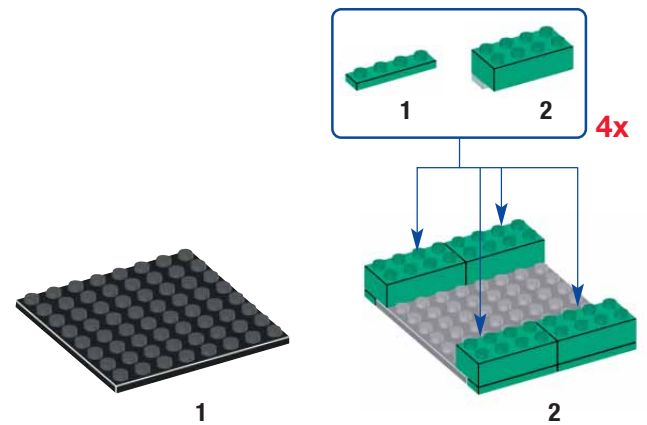
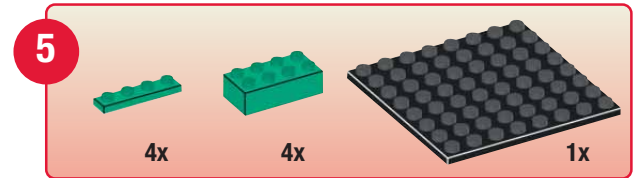
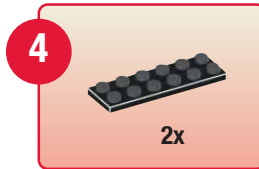
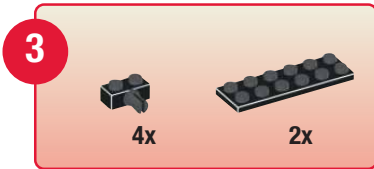
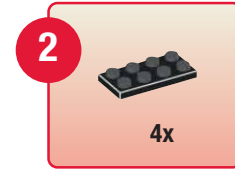
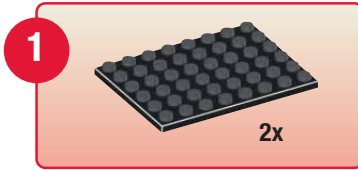

6

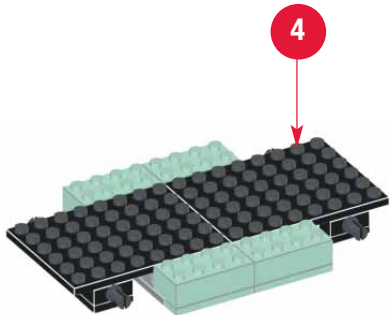

7

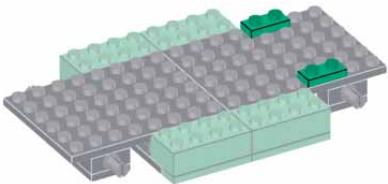
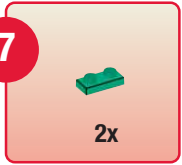

8

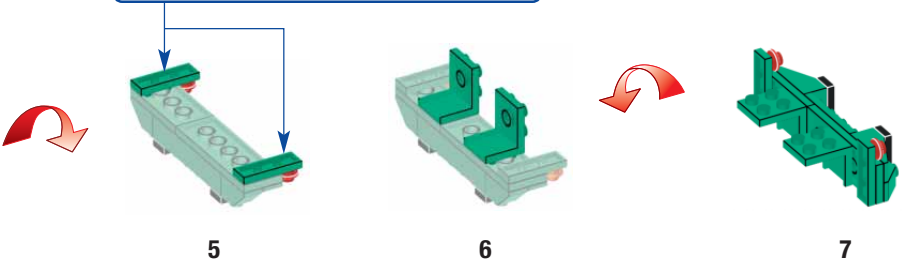
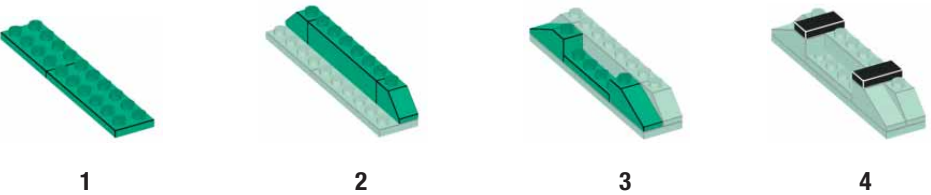
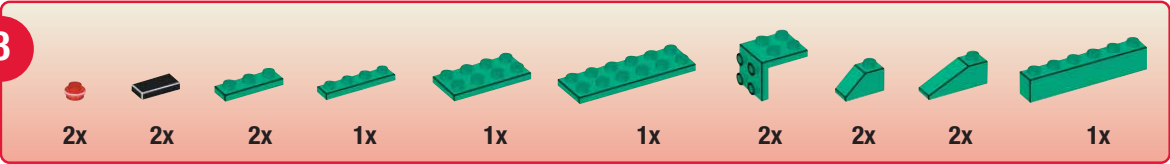

**9**

1x

1

2

**10**

2x 1x 2x 6x 2x 1x 2x 4x

1

2

3

4

5

6

7

8

**11**

10

8

**12**

1x 2x 2x 2x

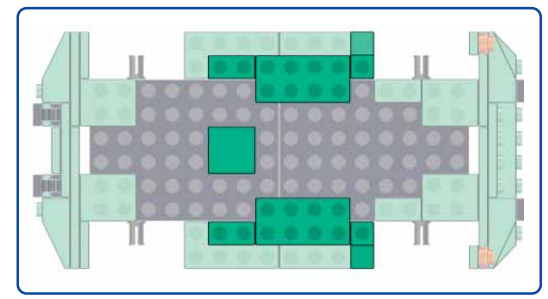

13



4x

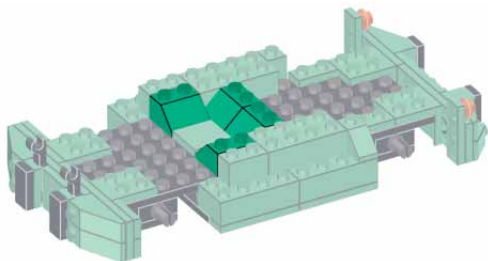

14



1x



1x



2x

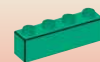

1x

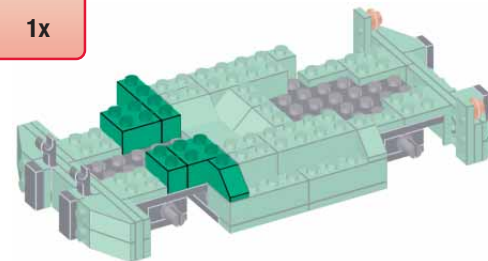

15



3x



1x



1x



1x



1x



1x



1x



1x

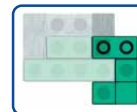
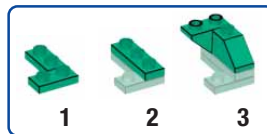

1



2



3

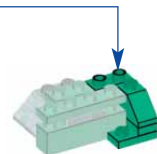

4



5

16



3x



1x



1x



1x



1x



1x

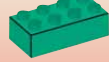

1x



1x

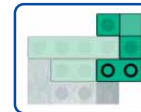
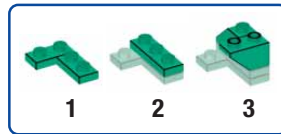

1



2



3



4



5

17

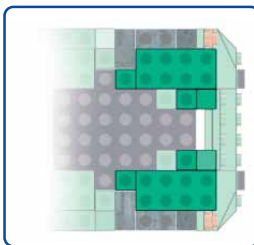
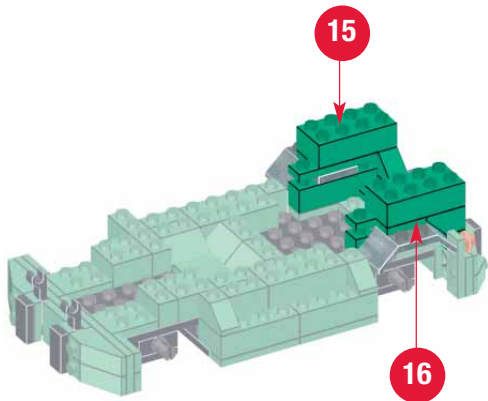

18

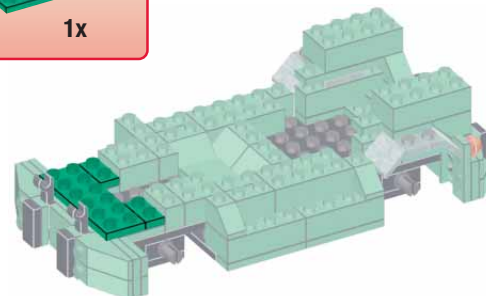
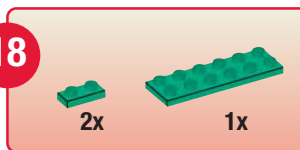

19

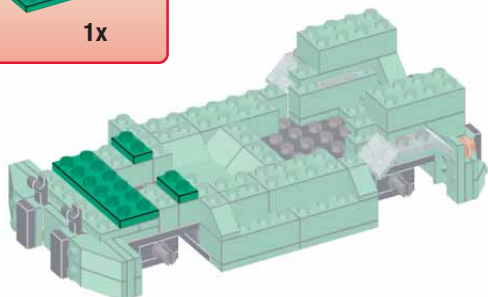
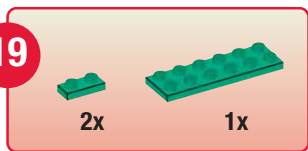

20

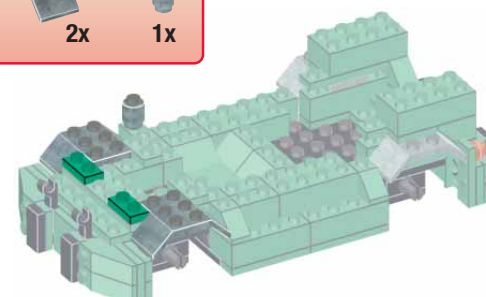

21

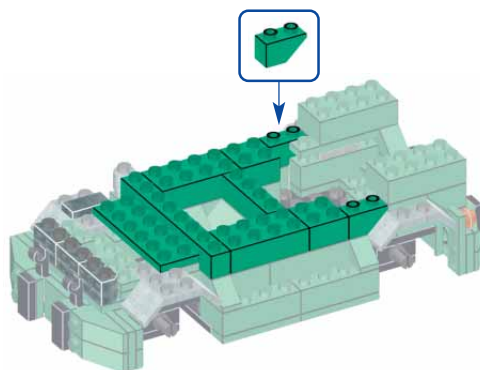
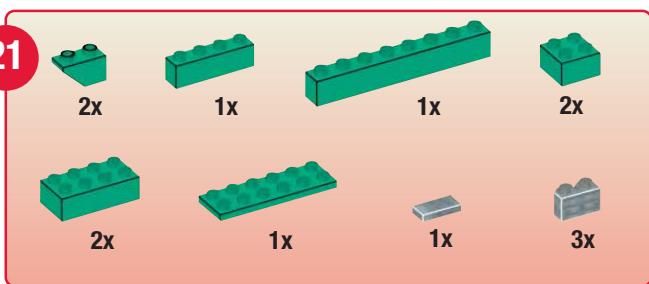

22

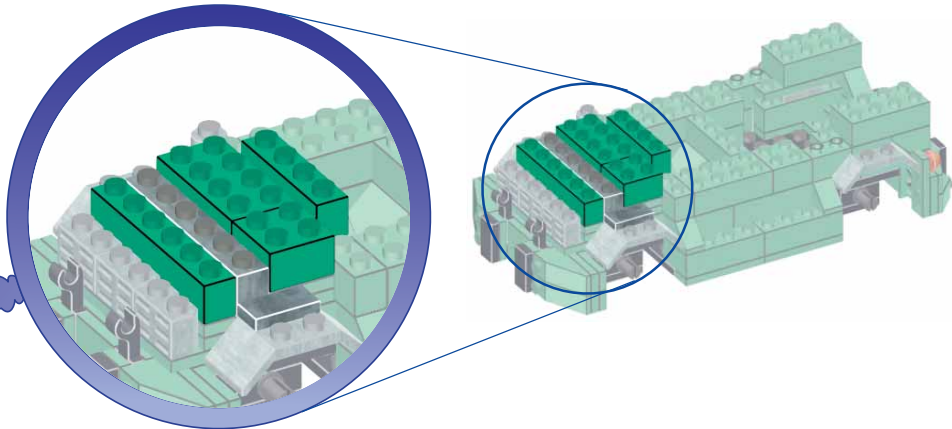

23

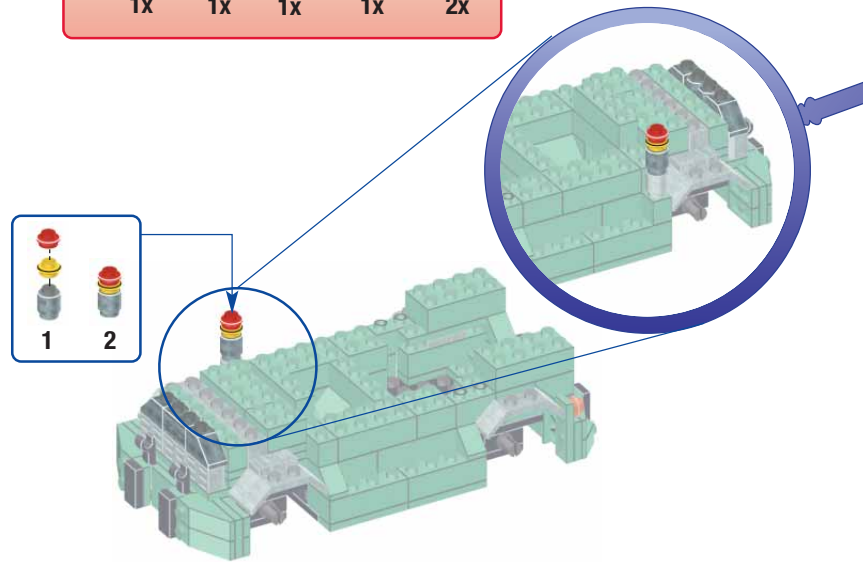

24

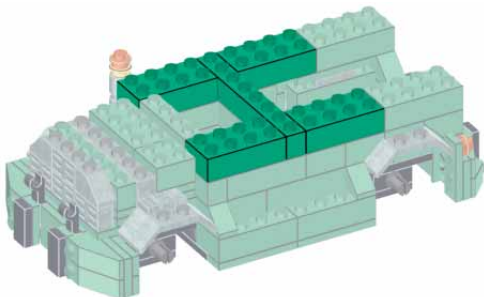
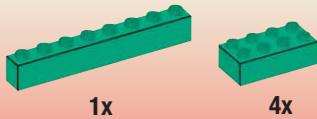

25

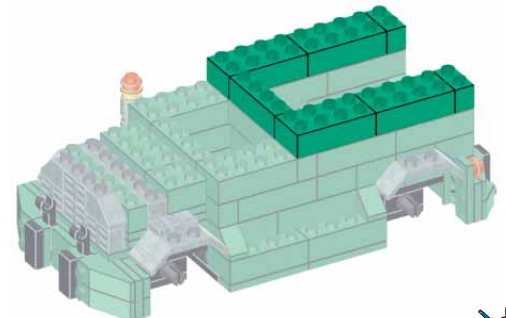
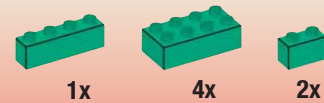

26

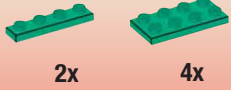

2x

4x

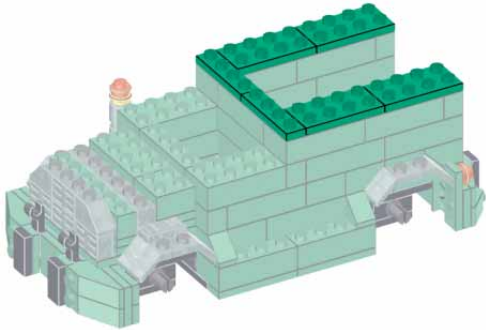

27

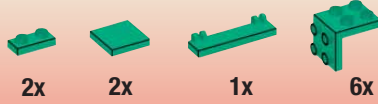

2x

2x

1x

6x

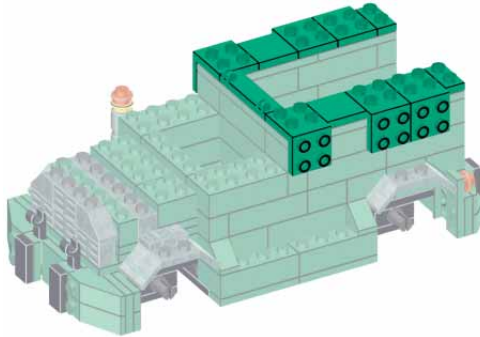

28



2x

2x

2x

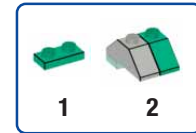

1

2

2x

29



2x

2x

2x

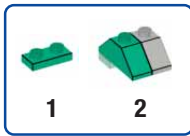

1

2

2x

30

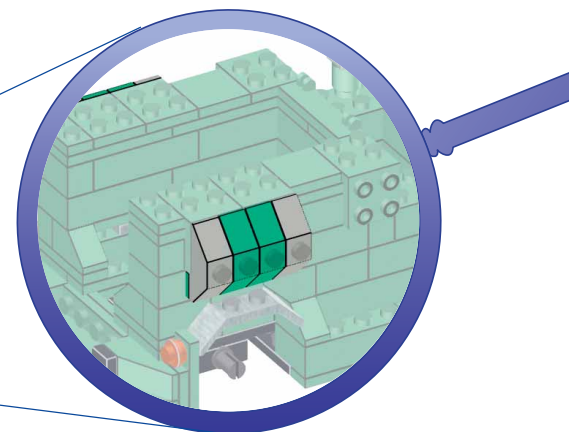
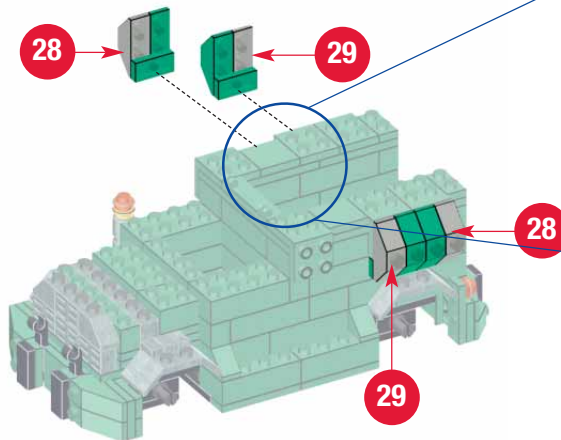

31

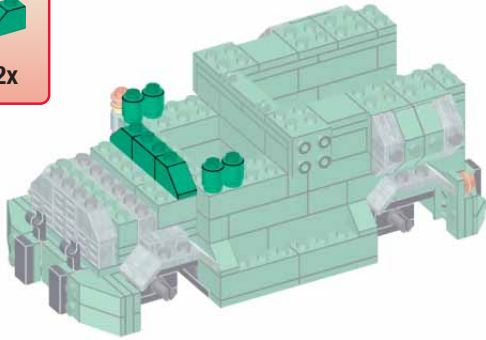

32

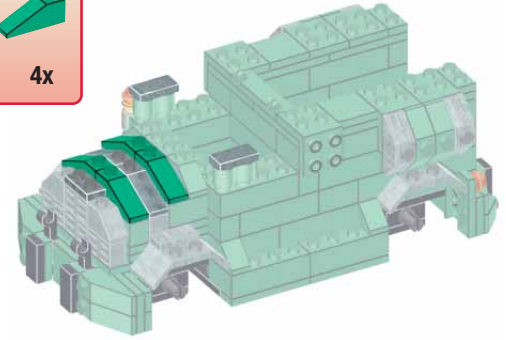

33

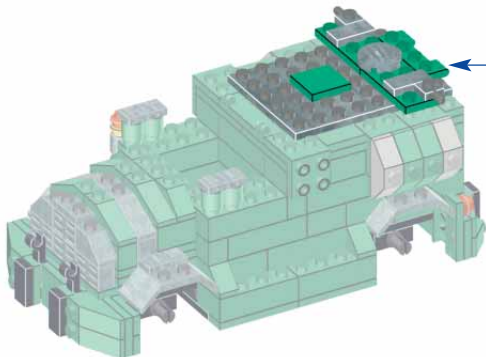
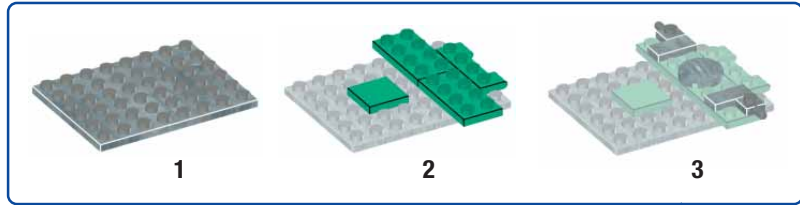
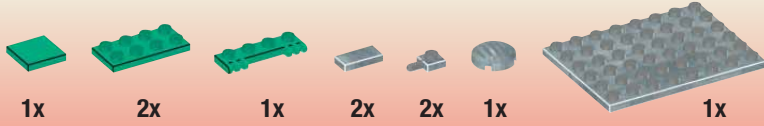

34

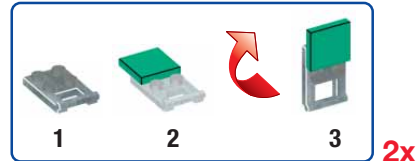

2x

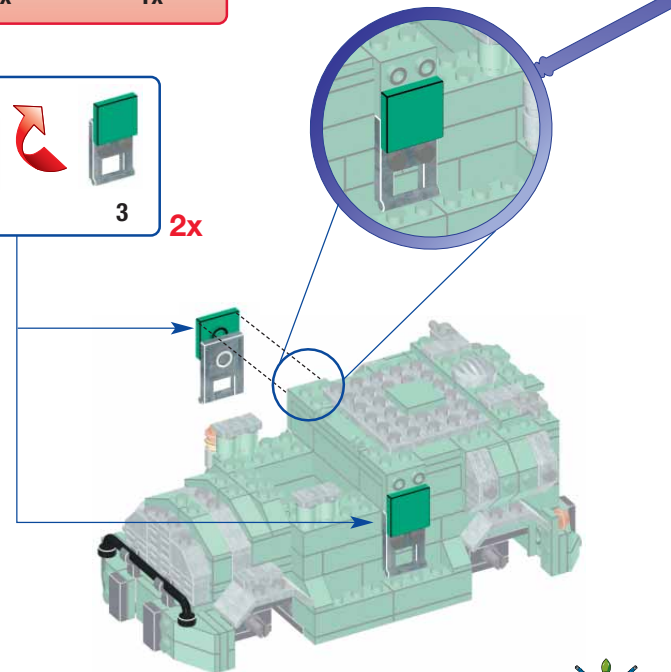



35

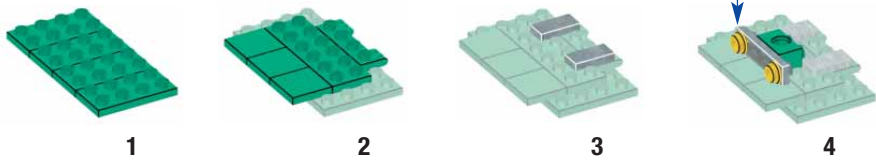
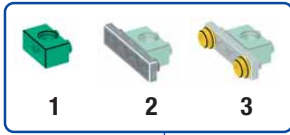
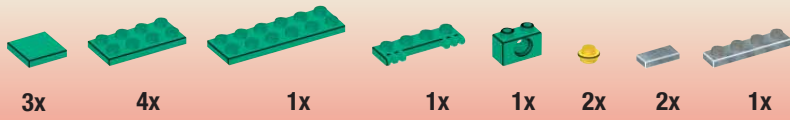

36

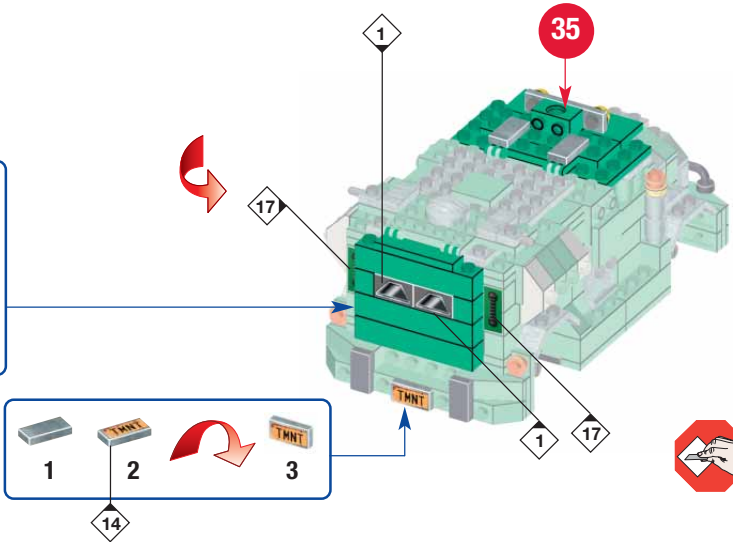
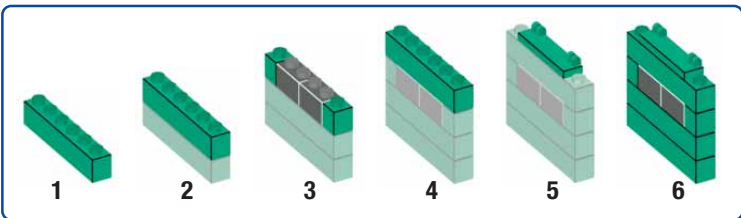
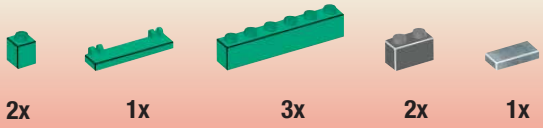

37



2x



4x

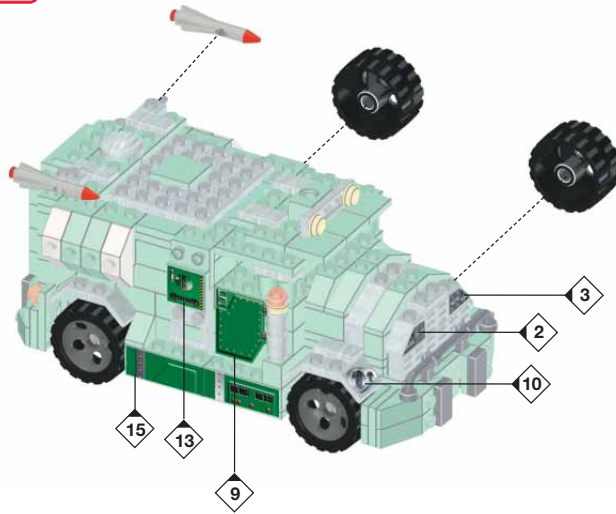

# TEENAGE MUTANT NINJA TURTLES™



# TEENAGE MUTANT NINJA TURTLES™

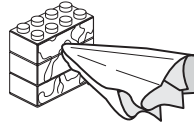

Gel compound washes off plastic parts with water.  
El compuesto de gel sobre las piezas de plástico se quita lavándolo con agua.  
Tout gel sur les pièces de plastique se lave à l'eau.  
Gelsamenstelling kan met water van plastic delen worden afgespoeld.

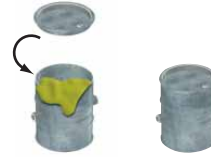

Replace cap of gel compound can firmly after use.  
Después de usar el compuesto de gel, cerrar el envase herméticamente.  
Remplacer fermement le capuchon du tube de gel après usage.  
Deksel van blik gelverbinding na gebruik goed sluiten.



Do not eat gel compound.  
No ingerir el compuesto de gel.  
Gel non comestibile.  
Gelverbinding niet eten.



**CAUTION / PRECAUCIÓN / ATTENTION / WAARSCHUWING**

Gel compound may stain fabric, clothing and carpet.  
Play on an easily cleanable surface.

El compuesto de gel puede manchar tejidos, ropa o alfombras. Jugar en una superficie fácil de limpiar.

Le gel peut tacher les tissus, vêtements et tapis.  
Jouer sur une surface facile à nettoyer.

Gelverbinding kan vlekken op textiel, kleding en tapijt achterlaten. Speel op een makkelijk te reinigen oppervlak.



©2003 Mirage Studios, Inc. Teenage Mutant Ninja Turtles™ is a trademark of Mirage Studios, Inc. All rights reserved. ©2003 Mirage Studios, Inc. Teenage Mutant Ninja Turtles™ es marca registrada de Mirage Studios, Inc. Todos los derechos reservados. ©2003 Mirage Studios, Inc. Teenage Mutant Ninja Turtles™ est une marque de commerce de Mirage Studios, Inc. Tous droits réservés. ©2003 Mirage Studios, Inc. Teenage Mutant Ninja Turtles™ is een handelsmerk van Mirage Studios, Inc. Alle rechten voorbehouden.



© 2003, Mega Bloks Inc.  
MEGA BLOKS and the MEGA BLOKS logo are registered trademarks of Mega Bloks Inc.  
MEGA BLOKS y el logotipo MEGA BLOKS son marcas registradas de Mega Bloks Inc.  
MEGA BLOKS et le logo de MEGA BLOKS sont des marques de commerce déposées de Mega Bloks Inc.  
MEGA BLOKS en het MEGA BLOKS logo zijn gedeponeerde handelsmerken van Mega Bloks Inc.