

A

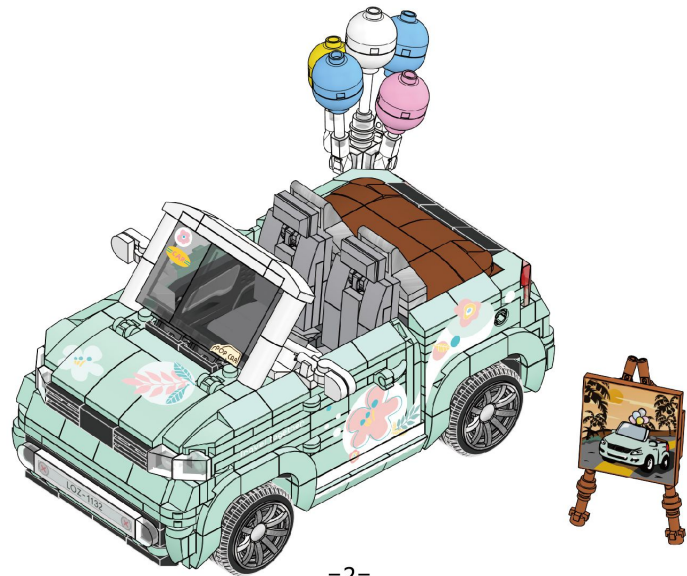

=2=

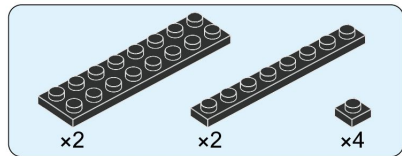

A1

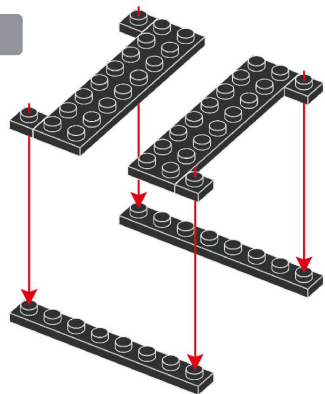

=3=

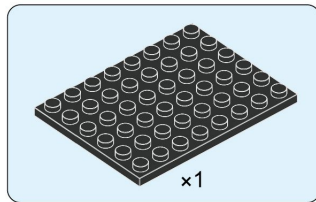

A2

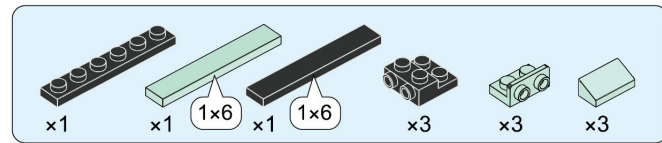
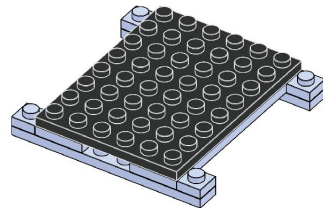

A3

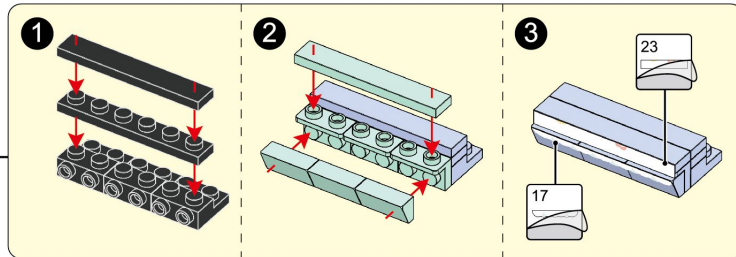
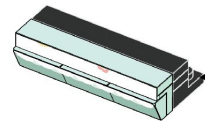

=4=

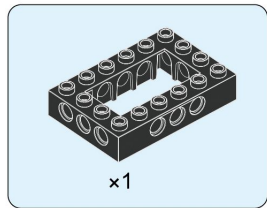

x1

A4

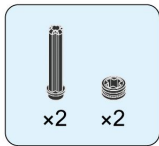
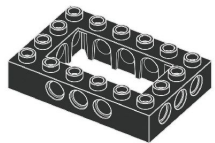

x2

x2

A5

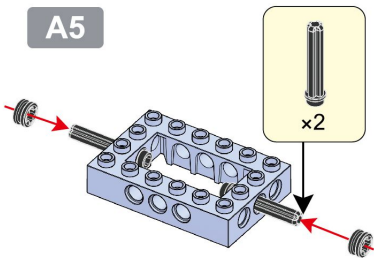

=5=

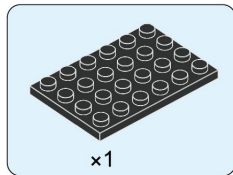

x1

A6

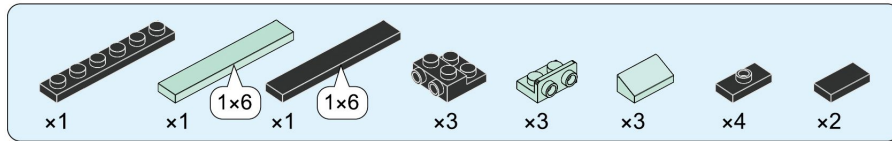
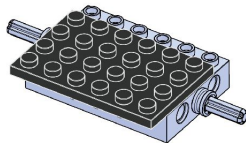

A7

A3

A6

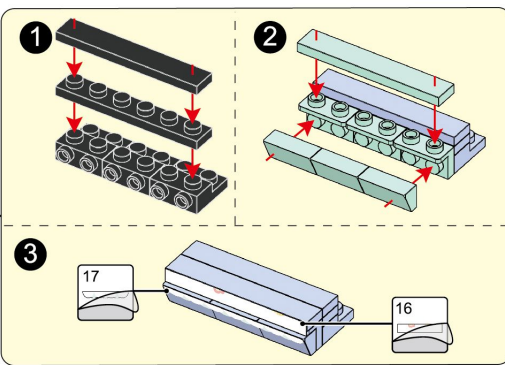
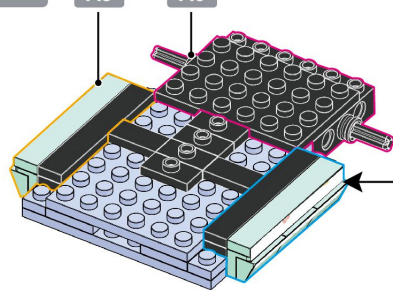

=6=

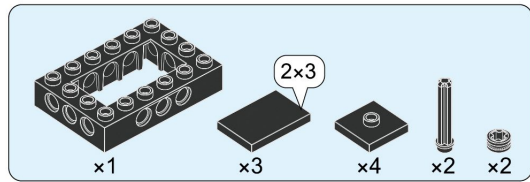

A8

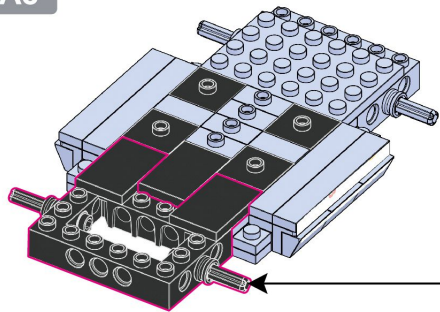

=7=

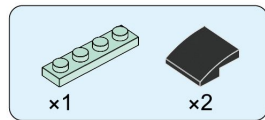
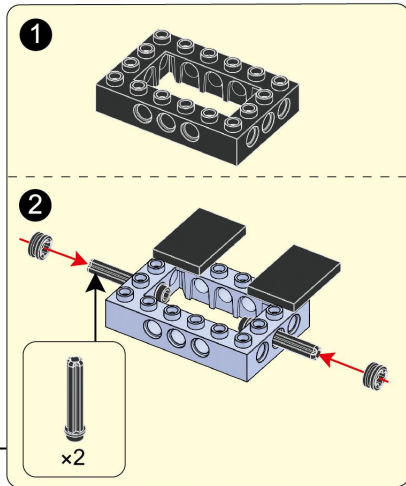

A9

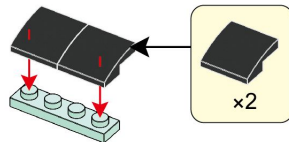

=8=

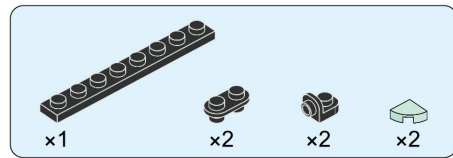

A10

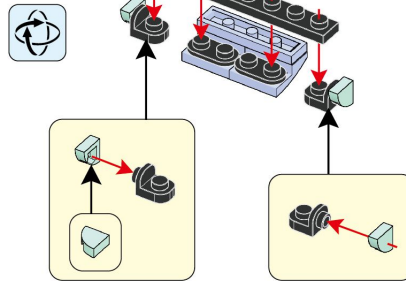

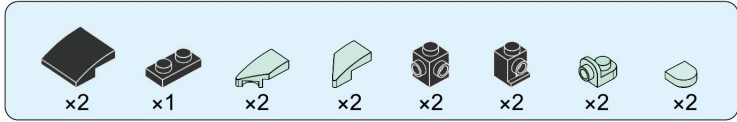

A11

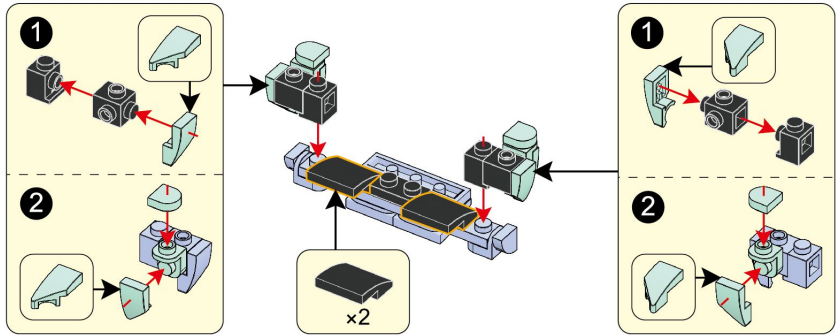

=9=

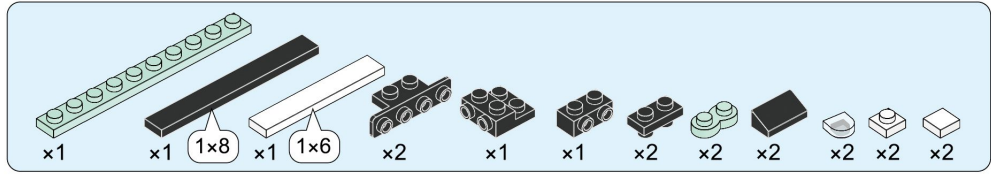

A12

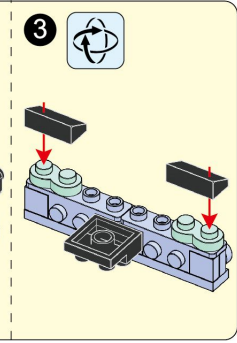
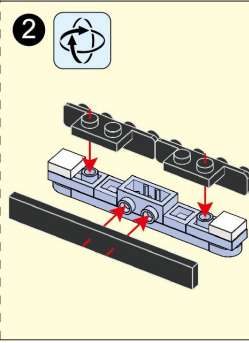
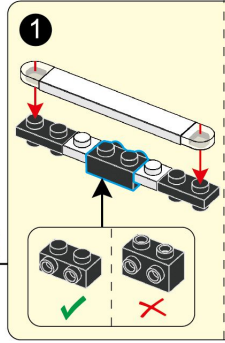
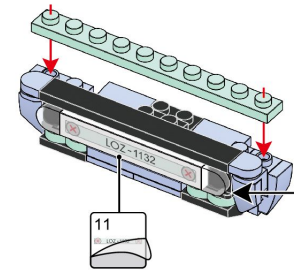

=10=

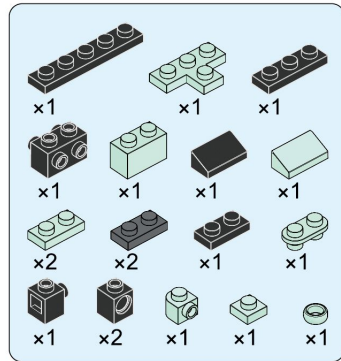

A15

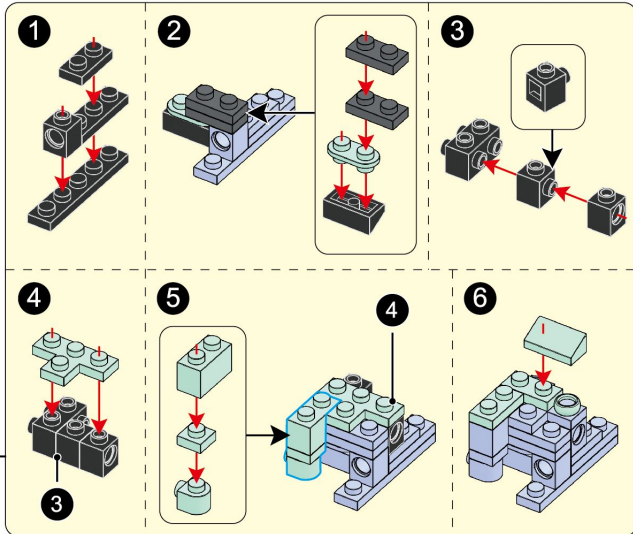
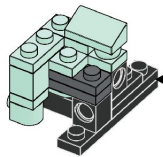

=13=

A16

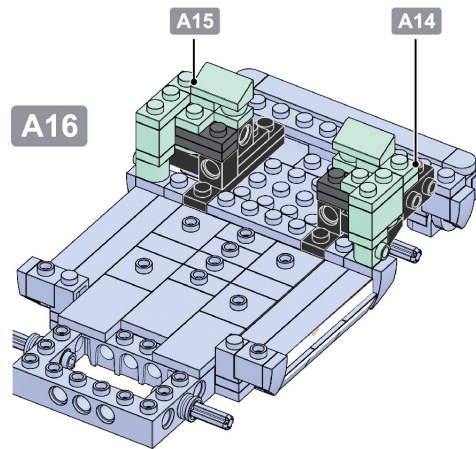

A17

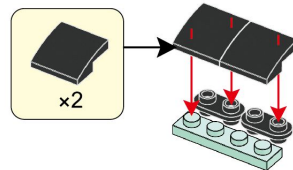
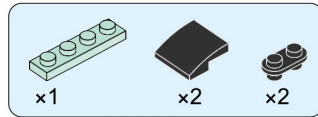

=14=

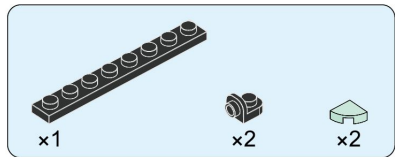

A18

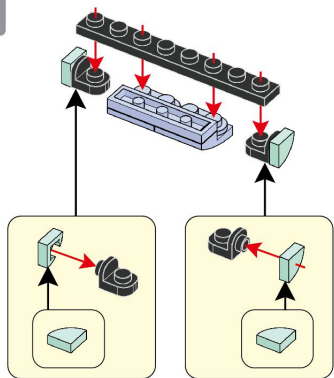

=15=

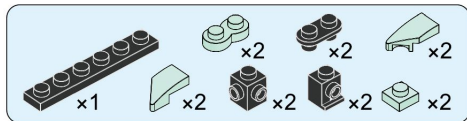

A19

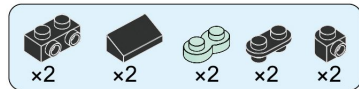
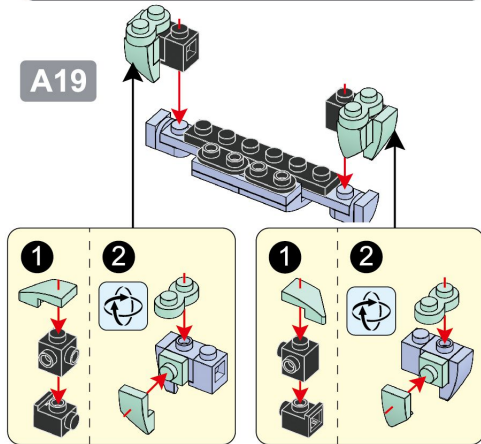

A20

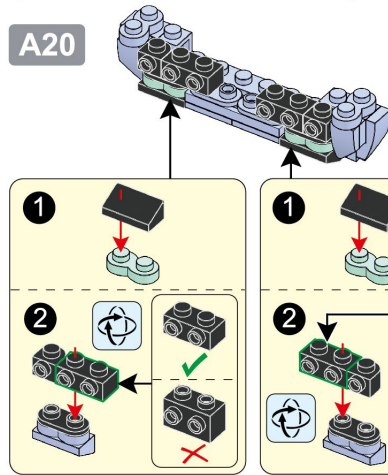

=16=

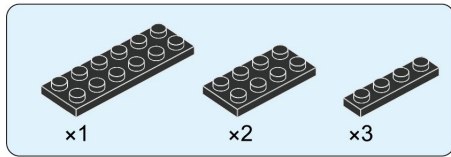

A21

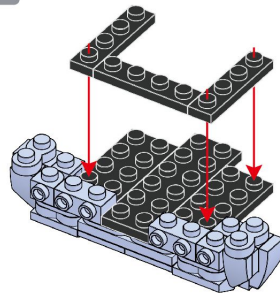

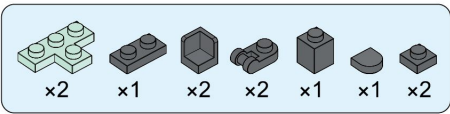

A26

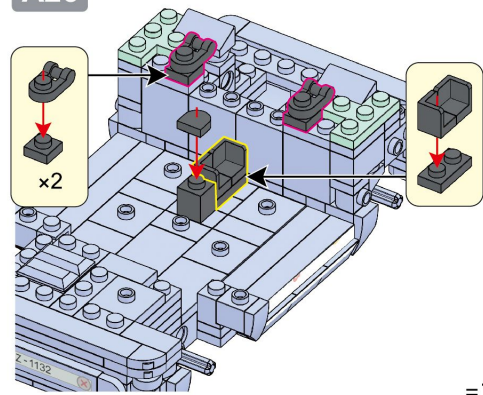

=19=

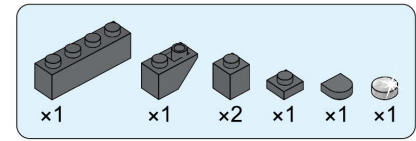

A27

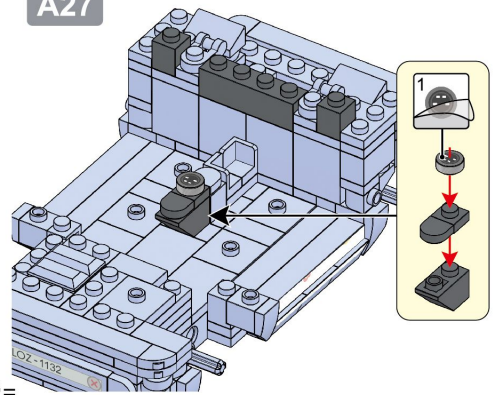

=20=

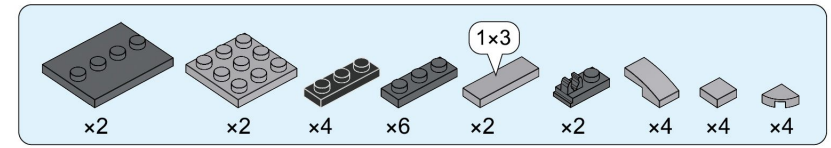

A28

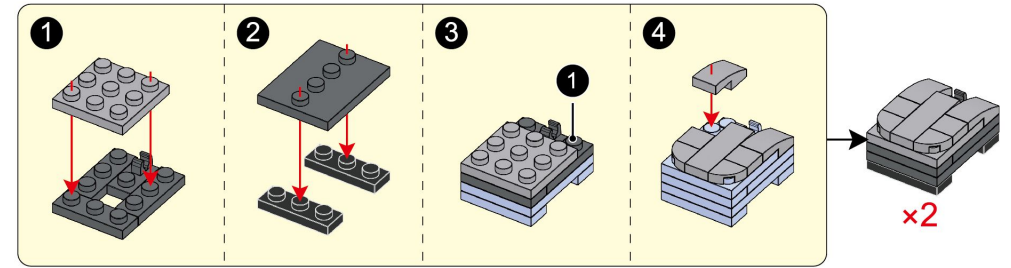

=20=

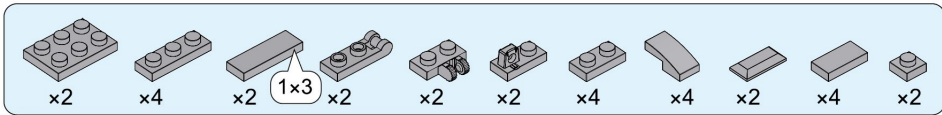

A29

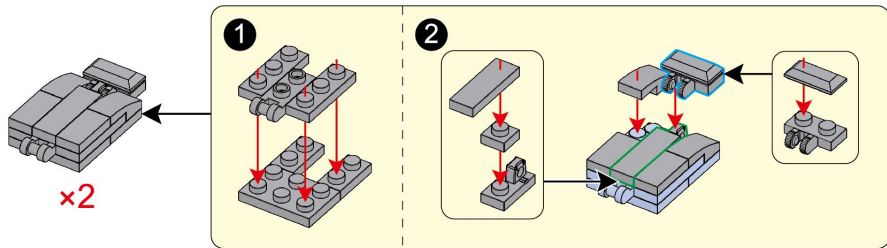

=21=

A30

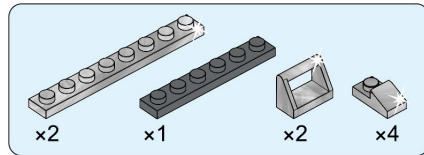
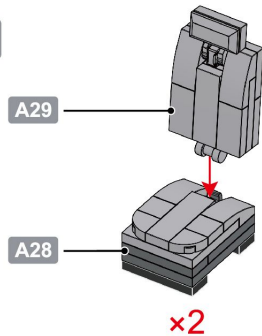

A31

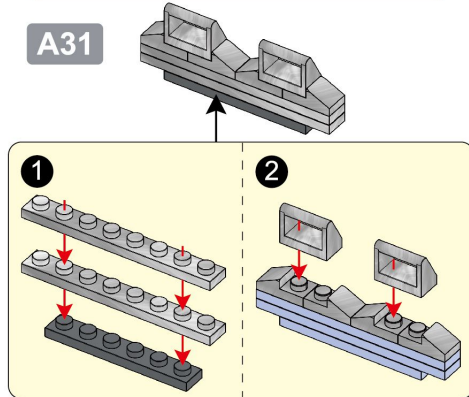

=22=

A32

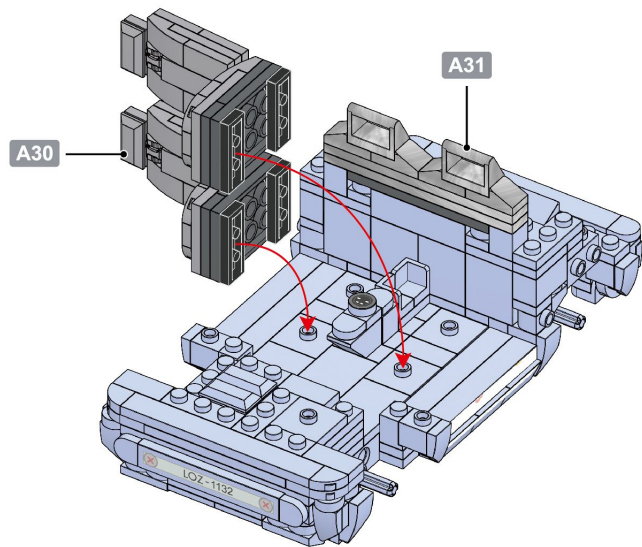

=23=

x1

x1

x1

x1

x1

x1

x1

x1

x2

x1

x1

x1

A33

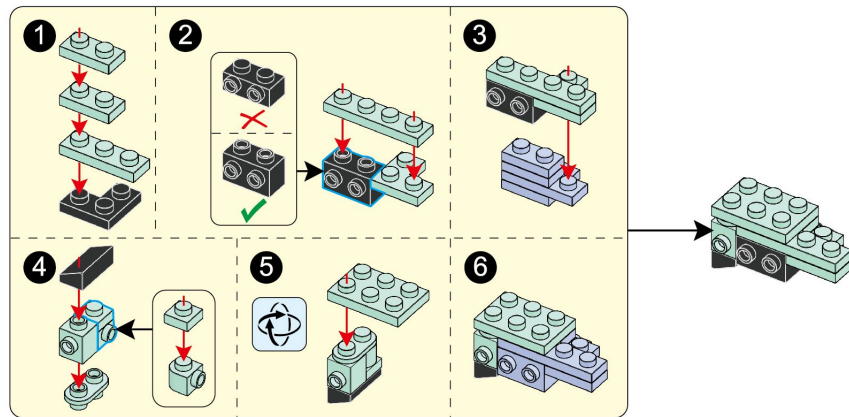

=24=

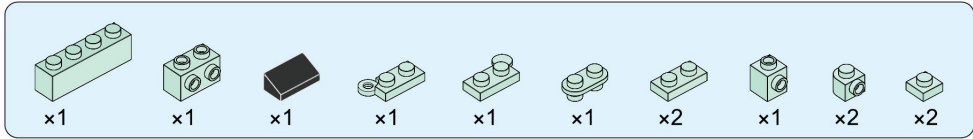

A34

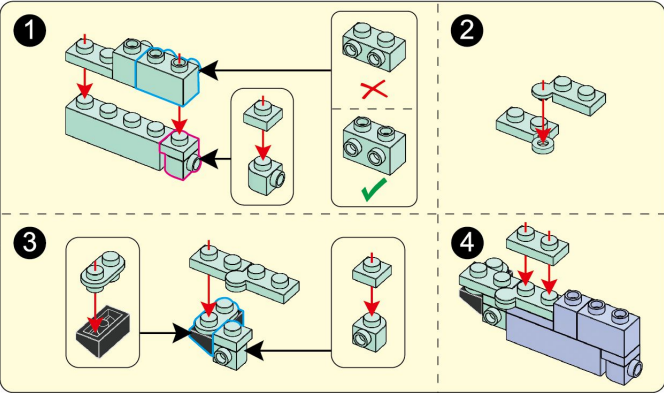
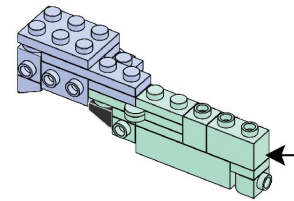

=25=

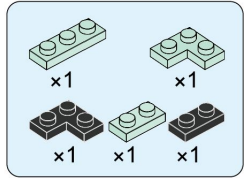

A35

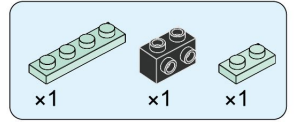
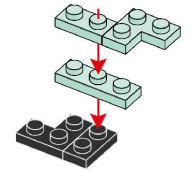

A36

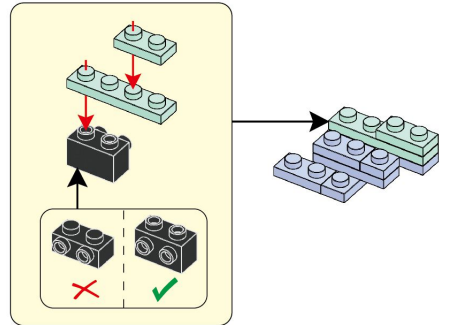

=26=

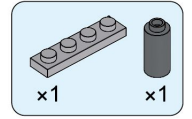

A37

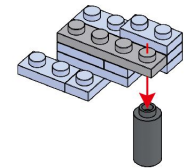



A38

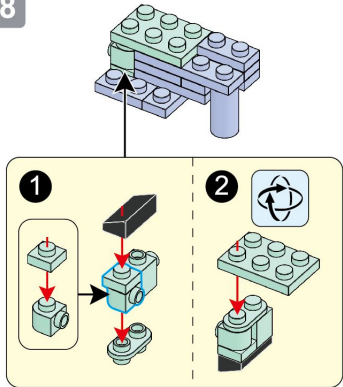

=27=

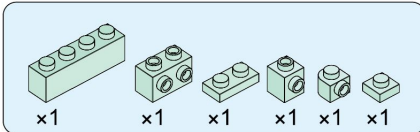

A39

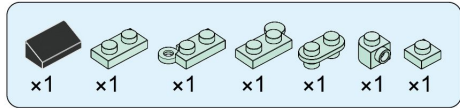
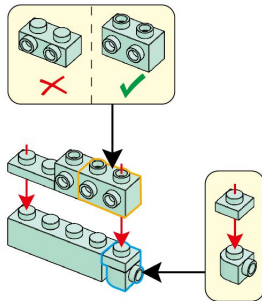

A40

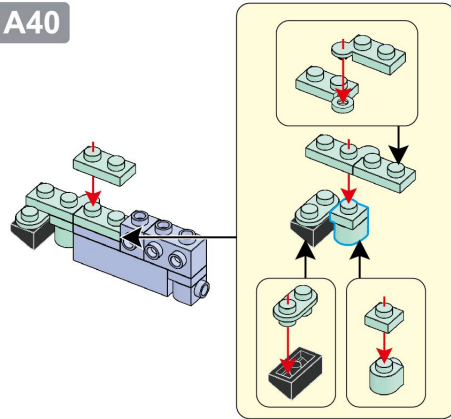

=28=

A41

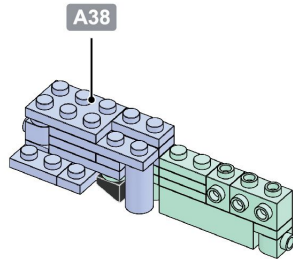

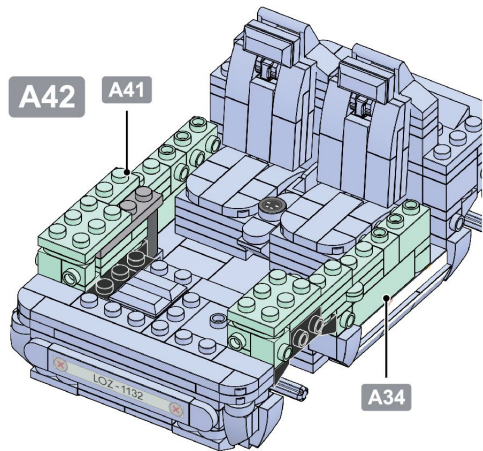

A42

A41

A34

=29=

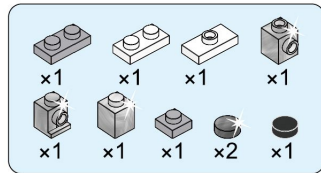

A43

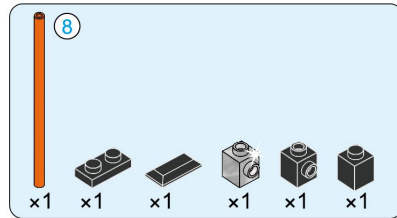
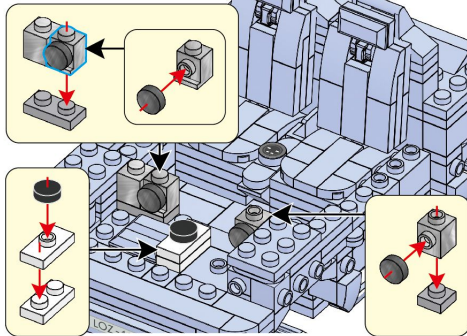

A44

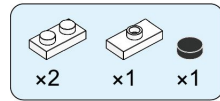
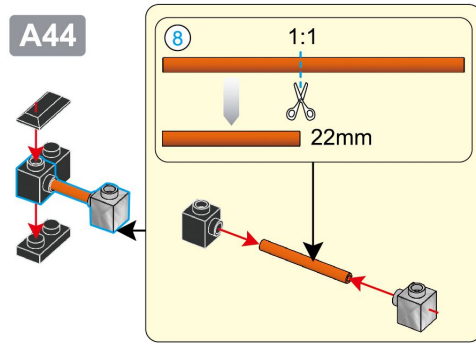

A45

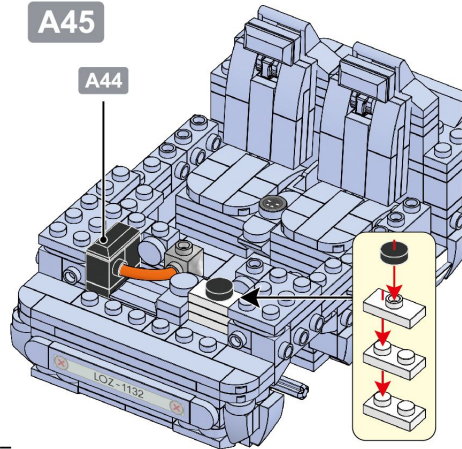

=30=

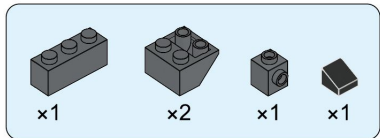

A46

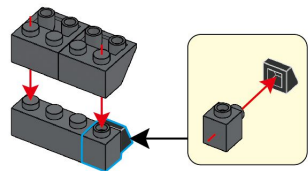

=31=

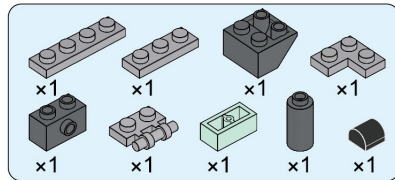

A47

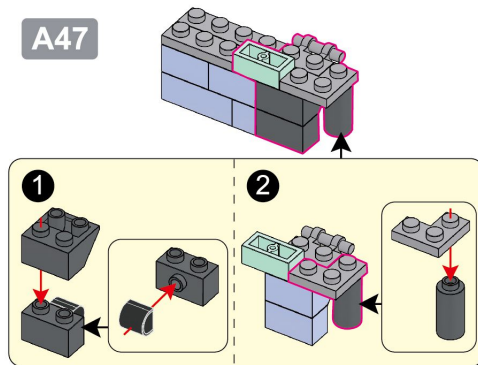

=32=

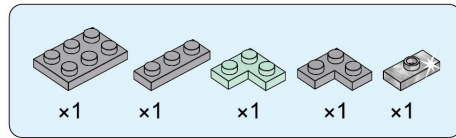

A48

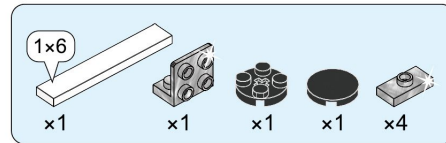
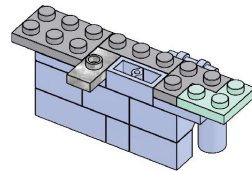

A49

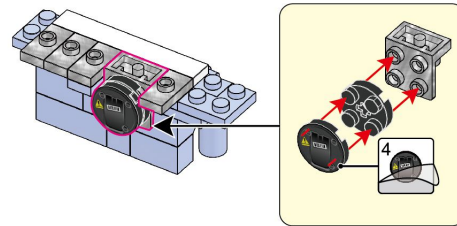

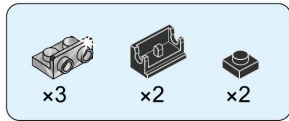

A50

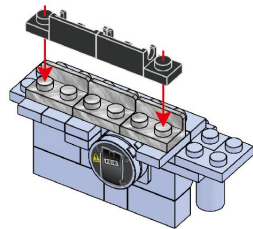

=33=

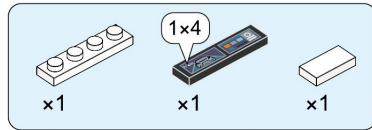

A51

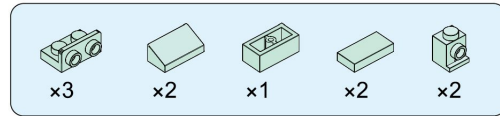
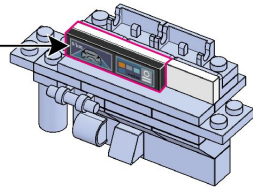
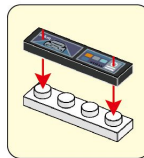

A52

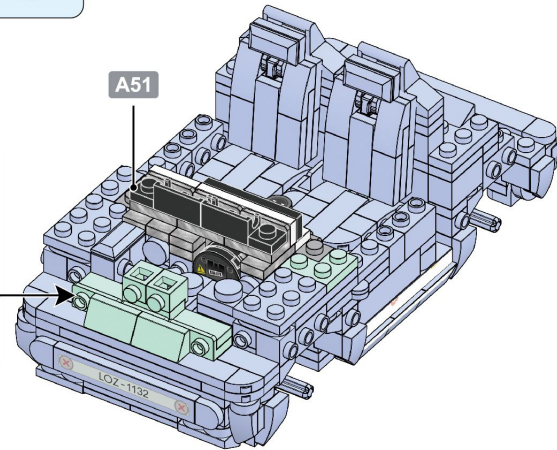
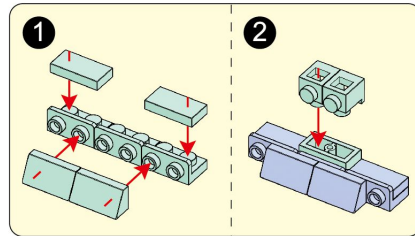

=34=

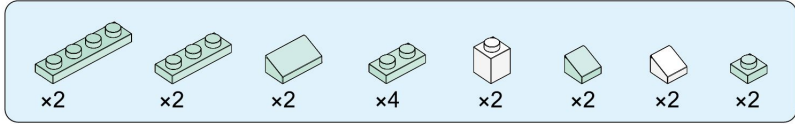

A53

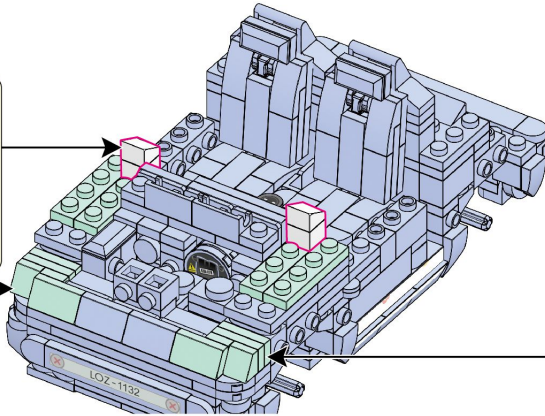
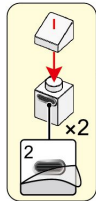
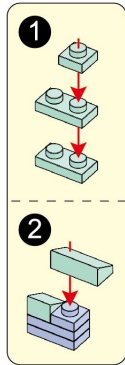

=35=

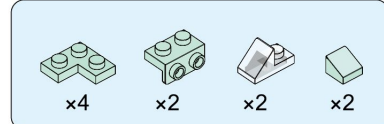
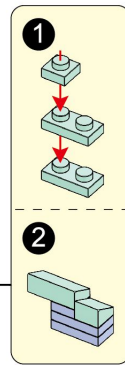

A54

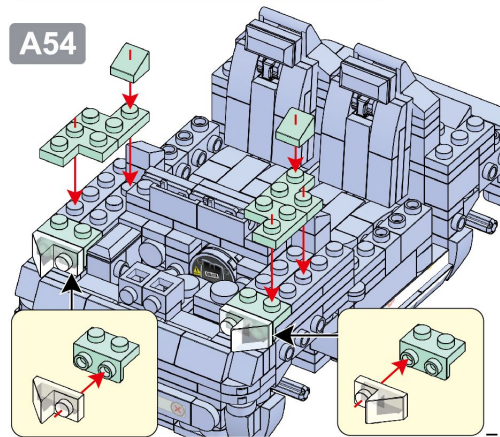

=36=

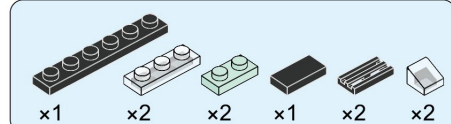

A55

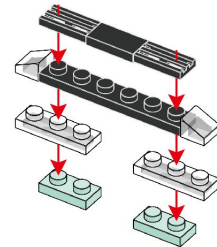

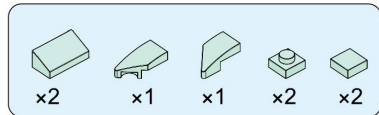

A56

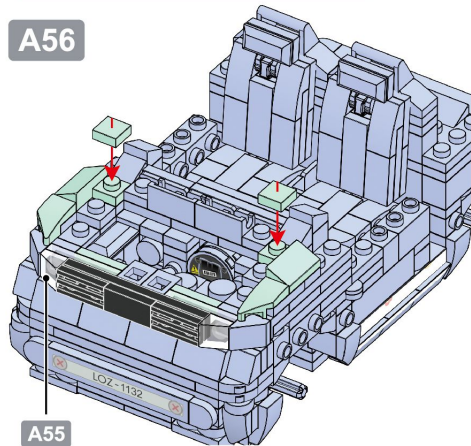

A55

=37=

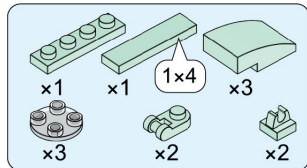

A57

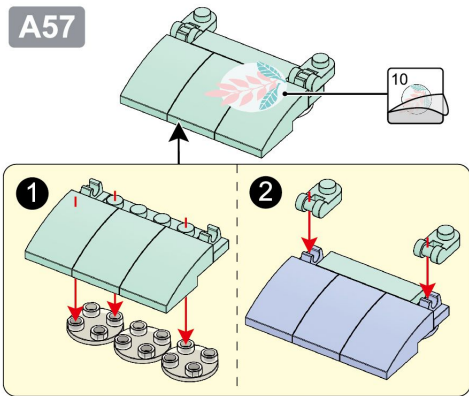

1

2

10

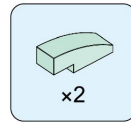

A58

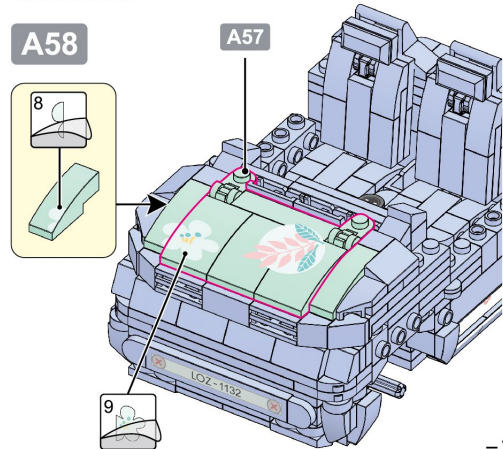

8

9

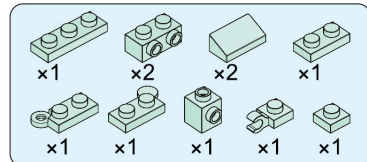

A59

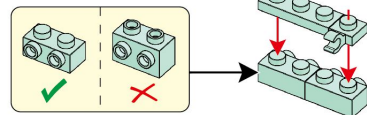

A60

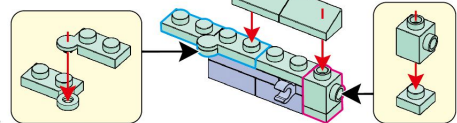

=38=

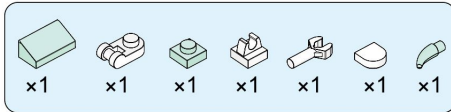

A61

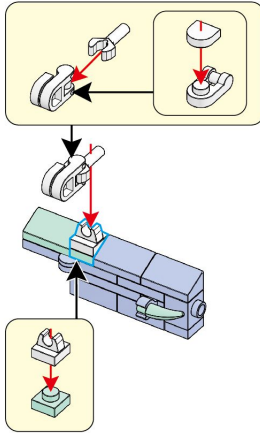

=39=

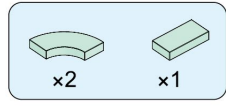

A62

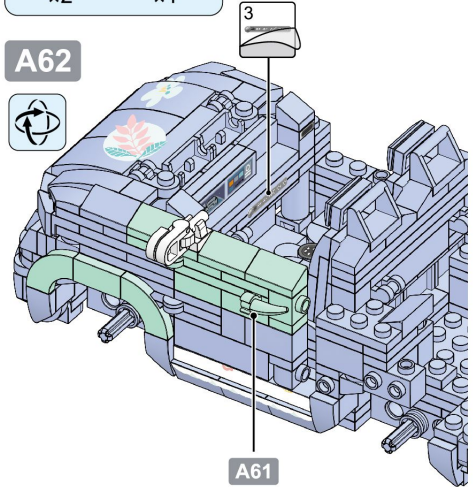

A61

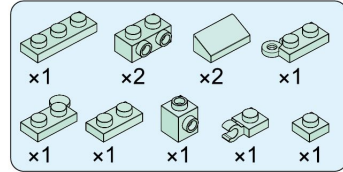

A63

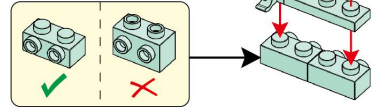

A64

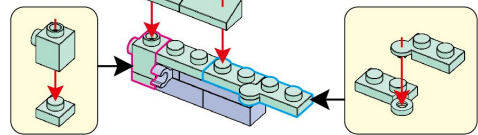

=40=

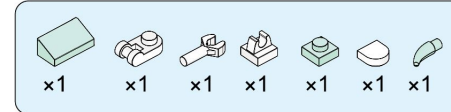

A65

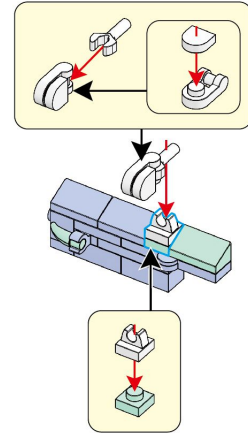

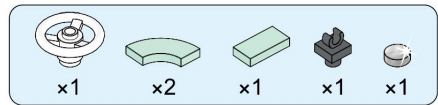

A66 

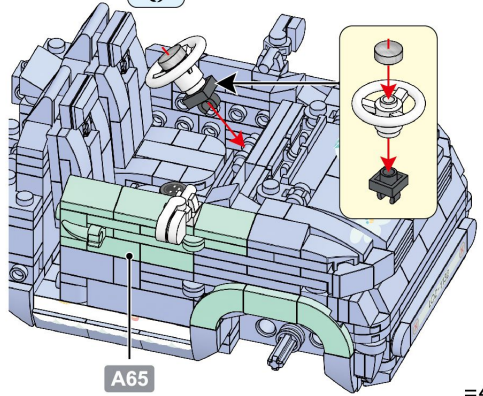

=41=

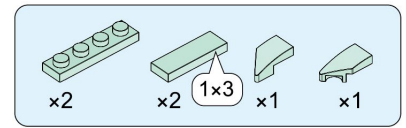

A67

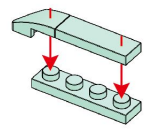

A68

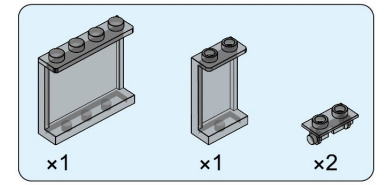
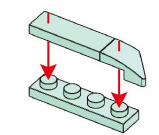

A69

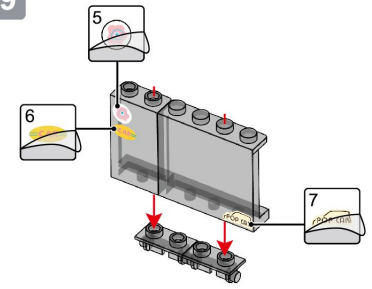

=42=

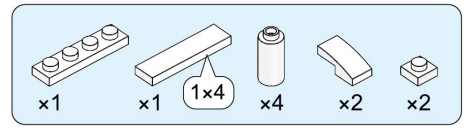

A70

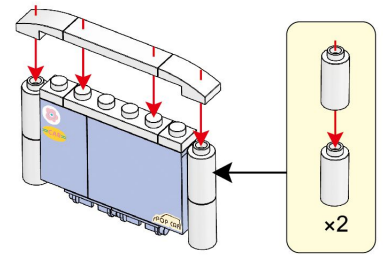

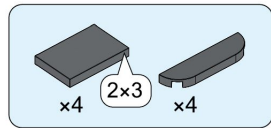

A71



A68

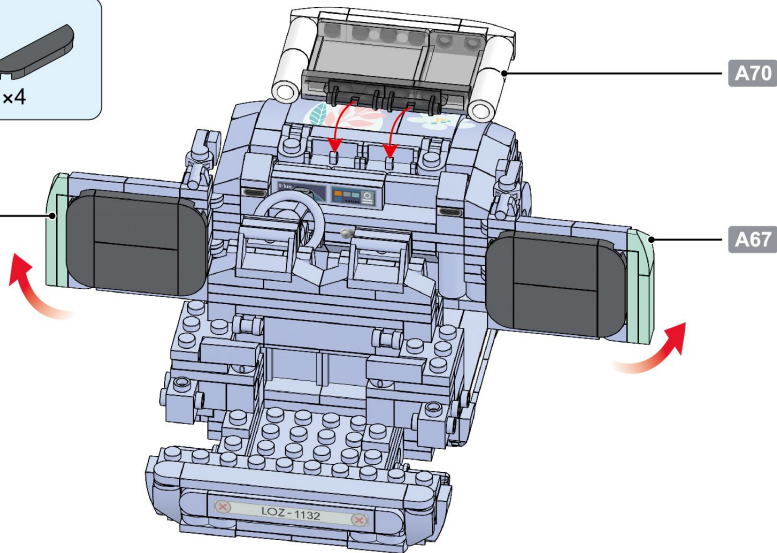

A70

A67

=43=

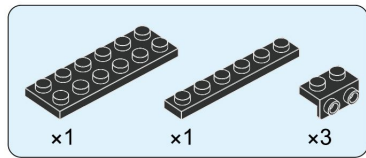

A72

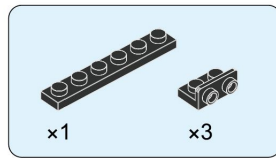
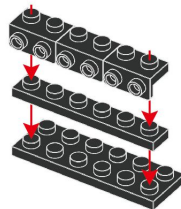

A73

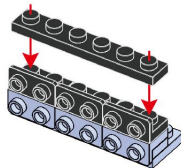

=44=

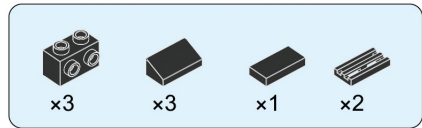

A74

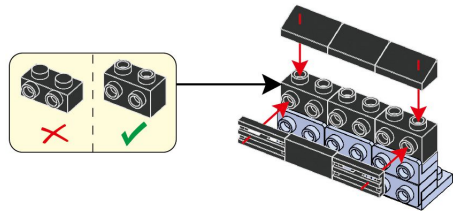

=45=

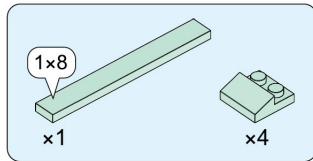

A75

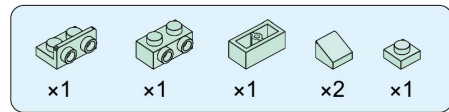
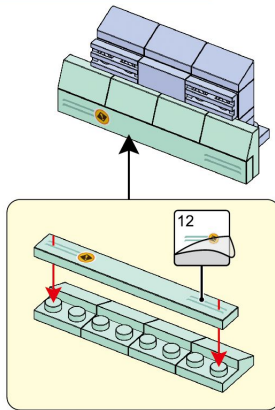

A76

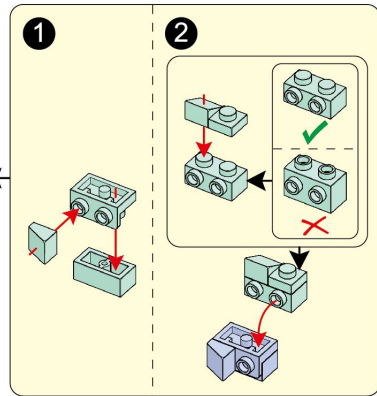

=46=

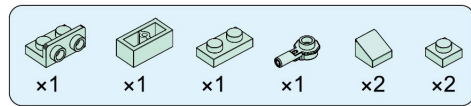

A77

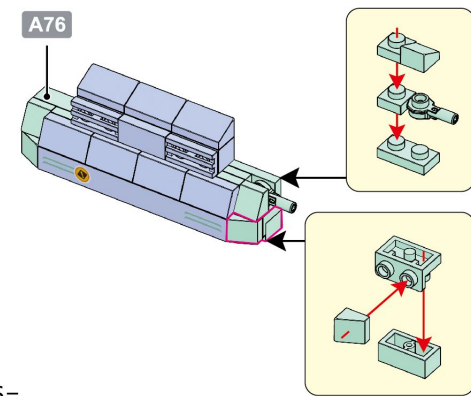

A78

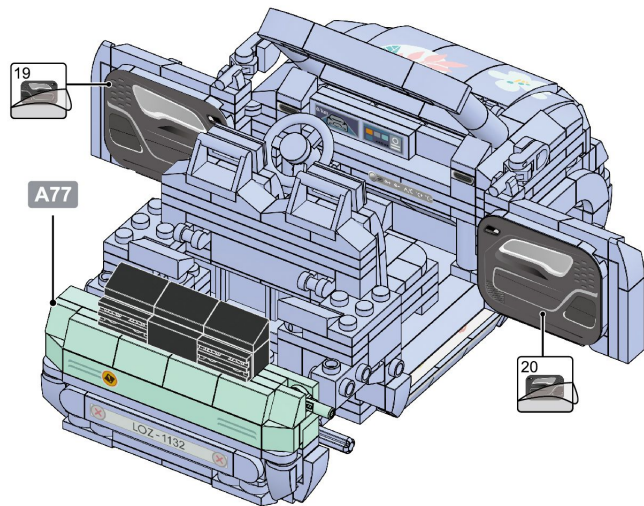

=47=

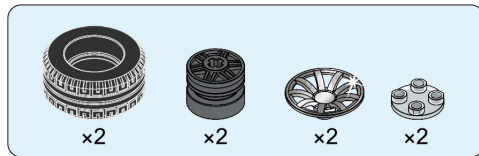

A79

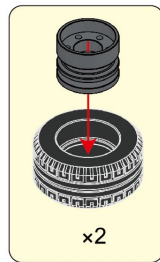

x2

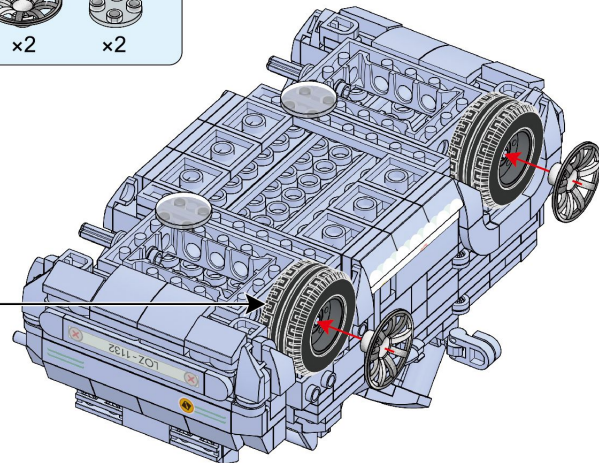

=48=

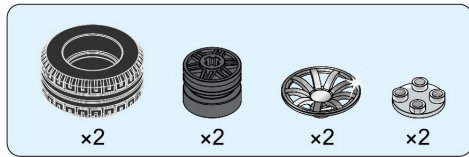

A80

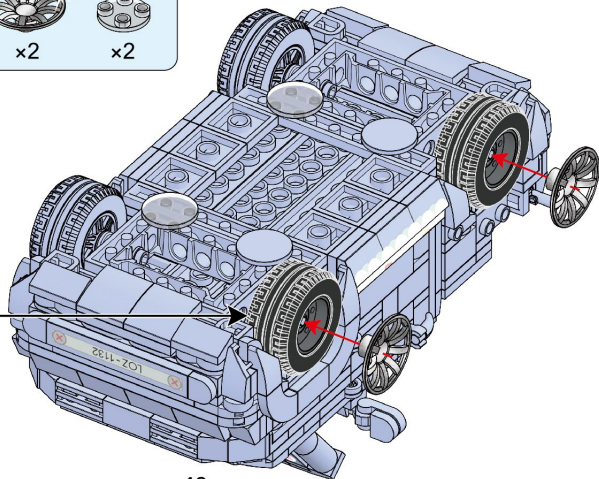
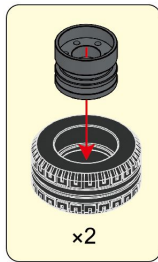

=49=

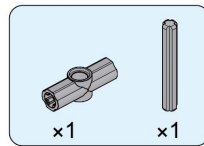

A81

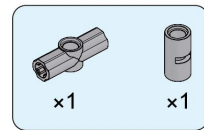
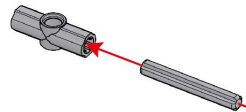

A82

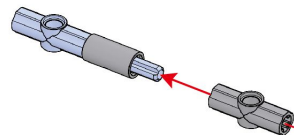

=50=

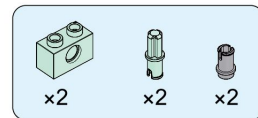

A83

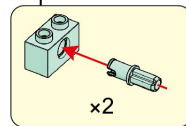
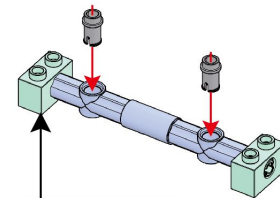

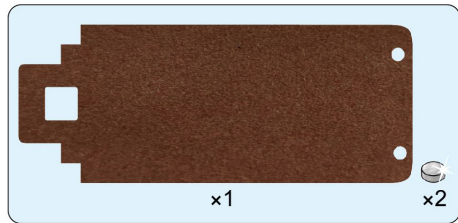

A84

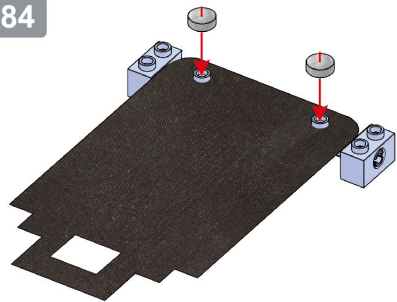

=51=

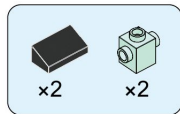

A85

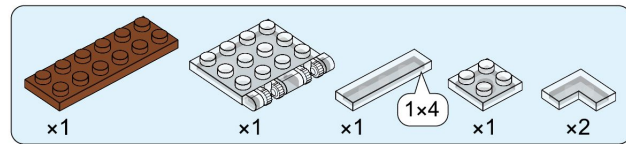
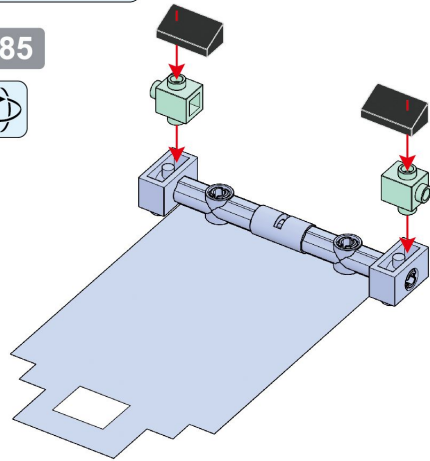

A86

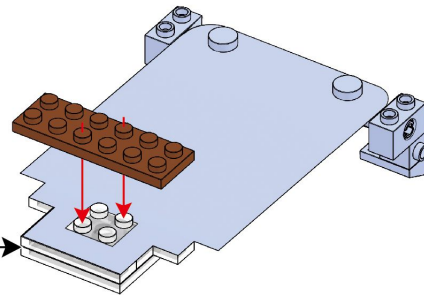
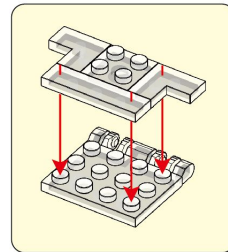

=52=

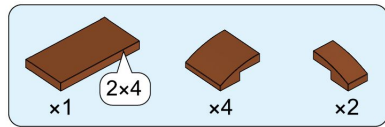

A87

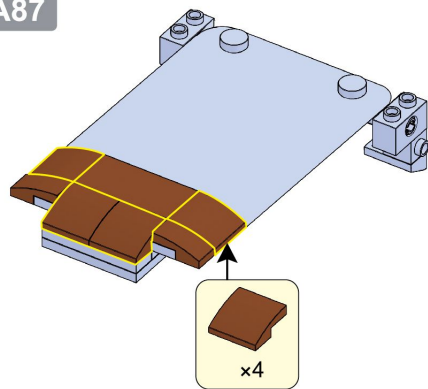

=53=

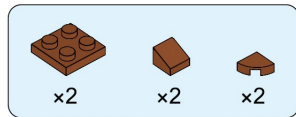

A88

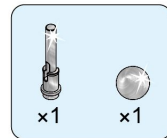
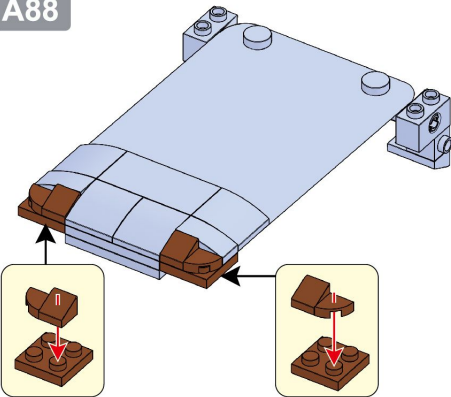

A89

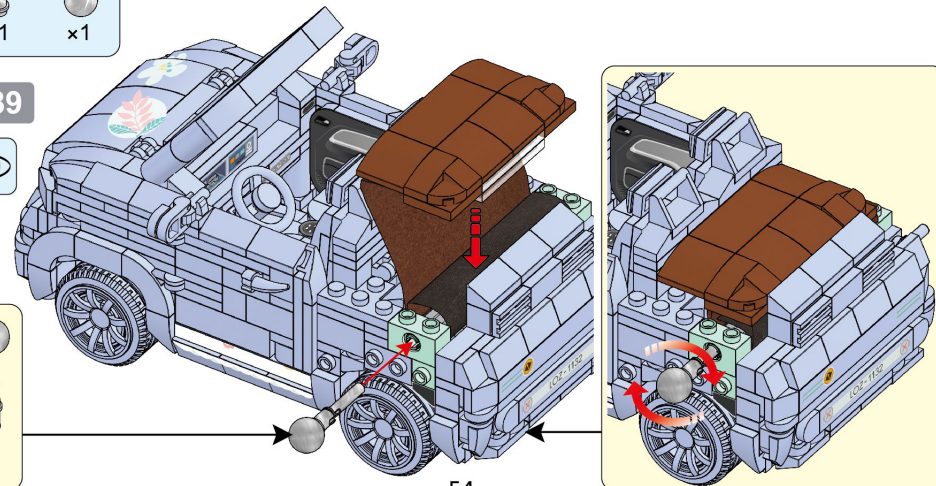
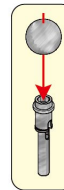

=54=

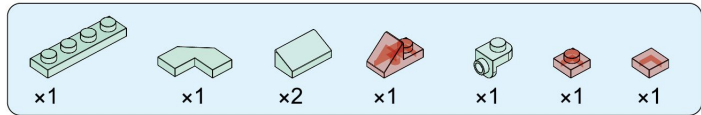

A90

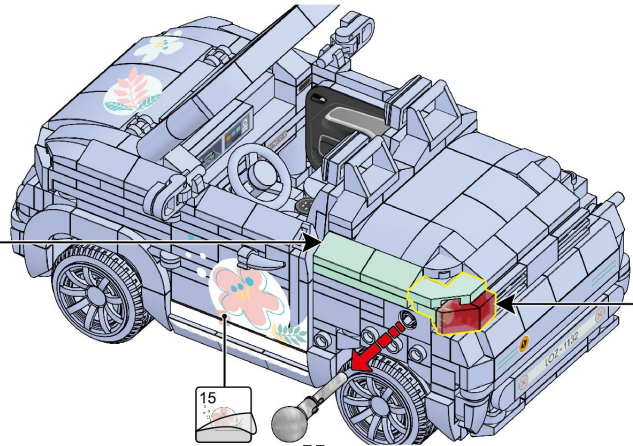
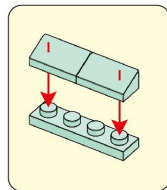

=55=

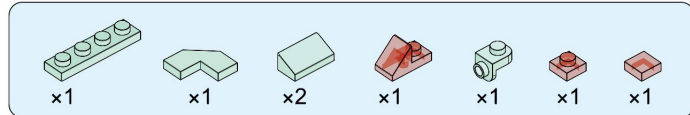
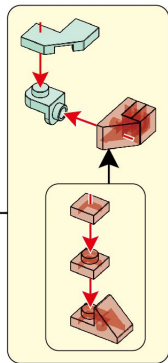

A91

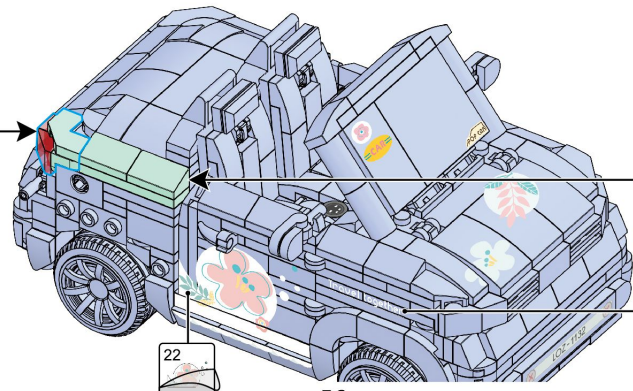
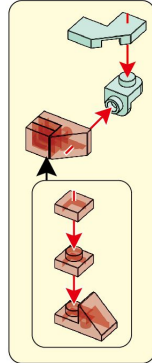

=56=

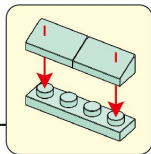

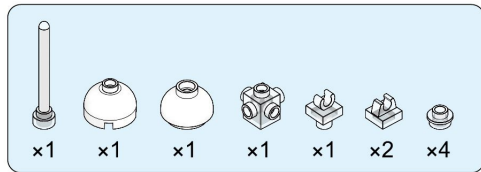

A92

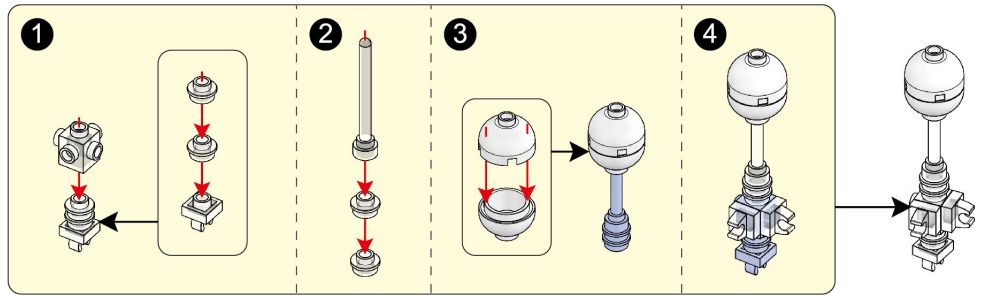

=57=

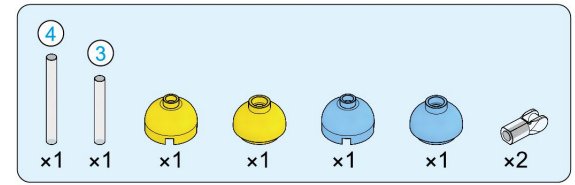

A93

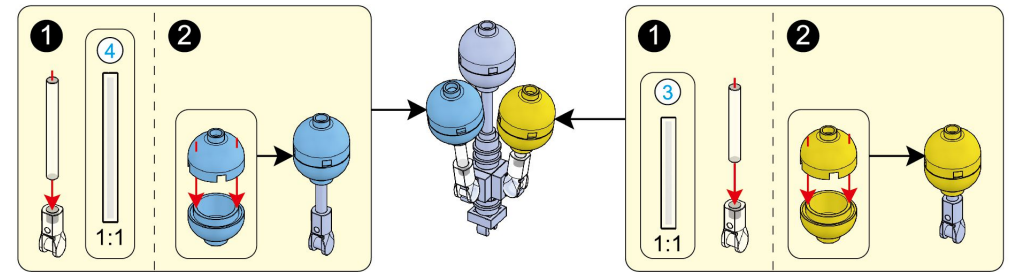

=58=

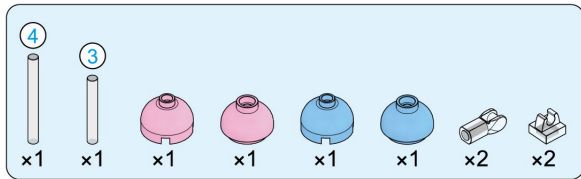

A94 

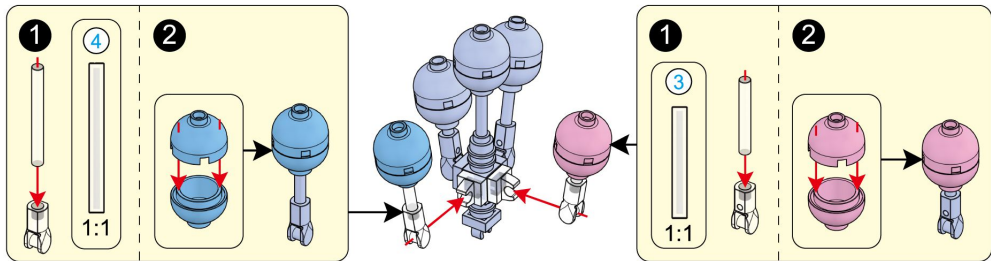

=59=

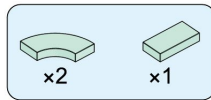

A95 

A94

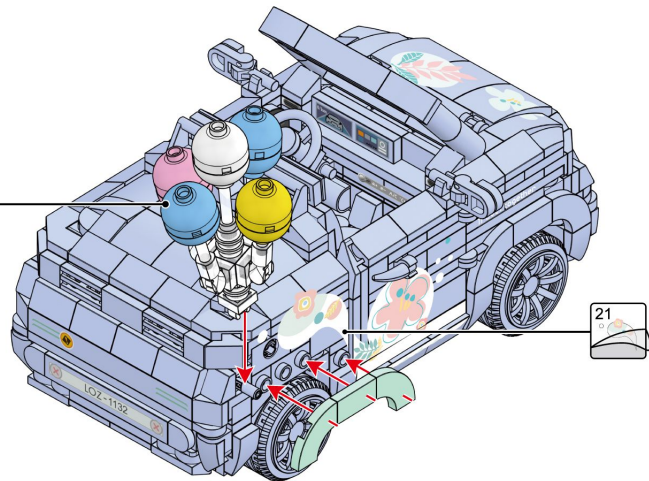

=60=

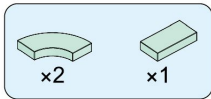

A96

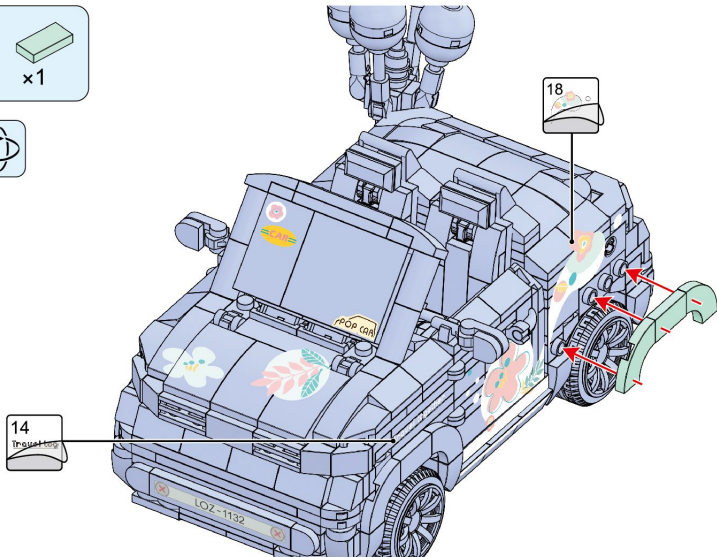

=61=

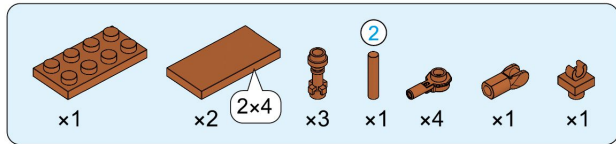

A97

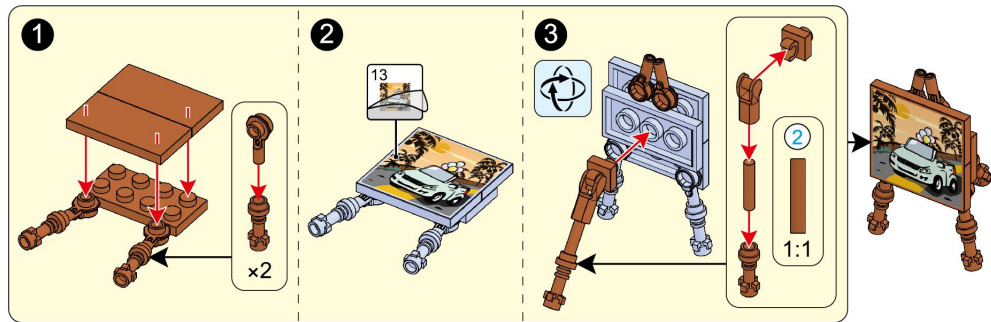

=62=

B

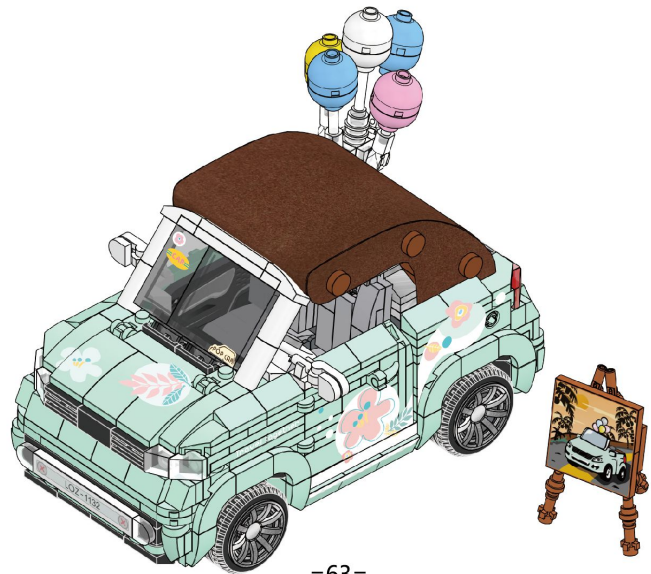

=63=

B1

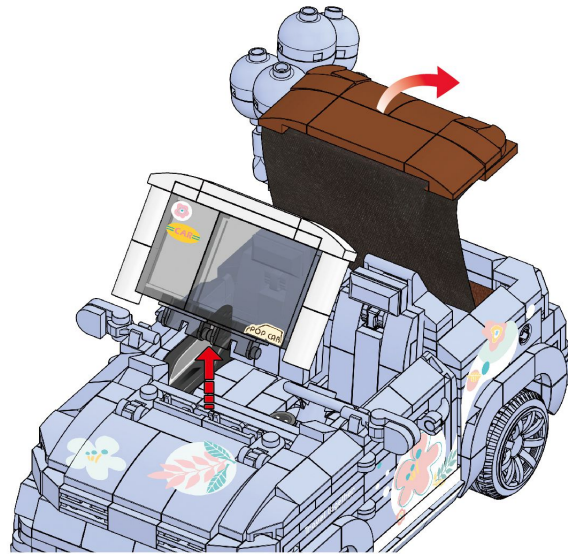

=64=

B2

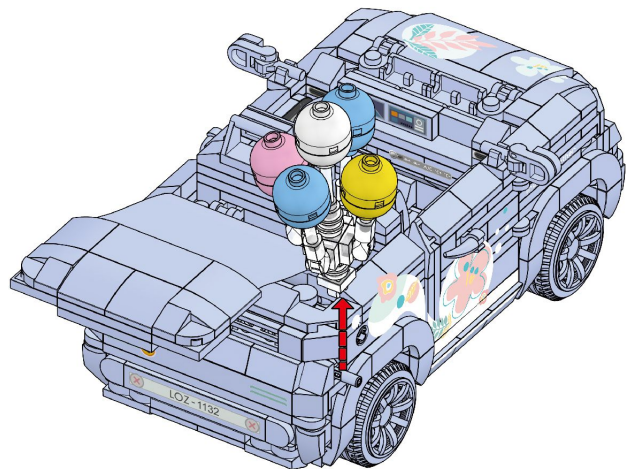

=65=

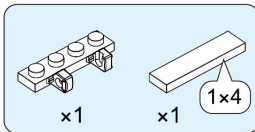

B3

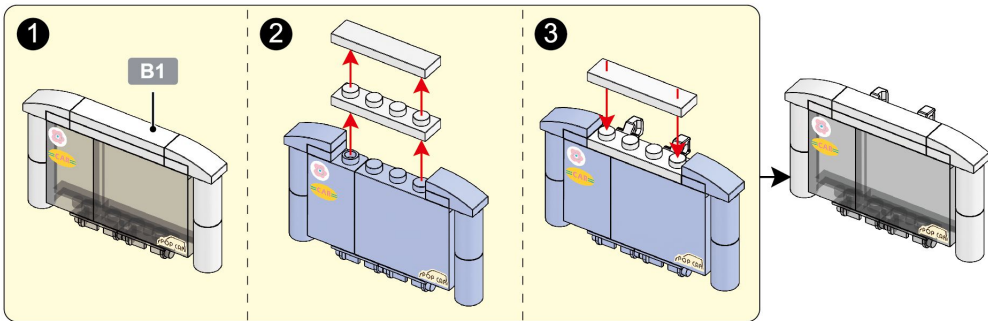

=66=

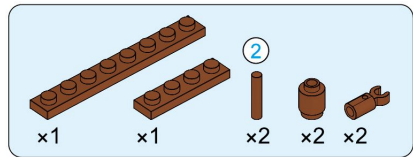

B4

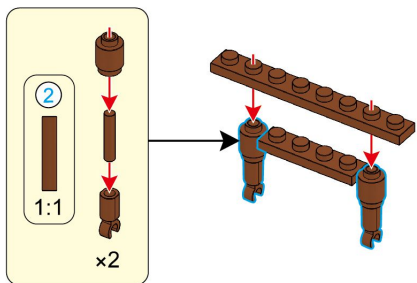

=67=

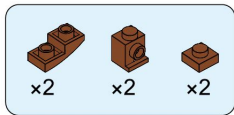

B5

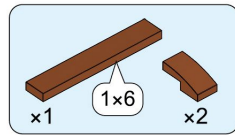
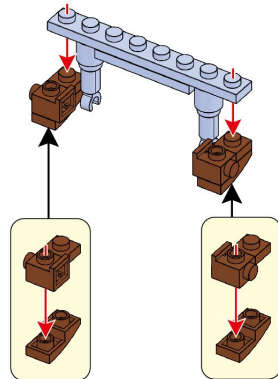

B6

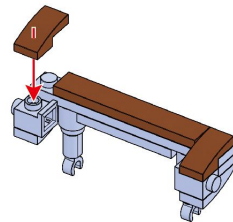

B7

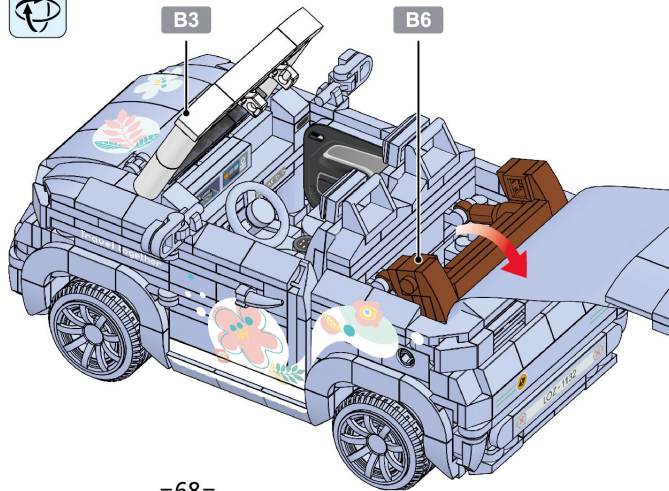

=68=

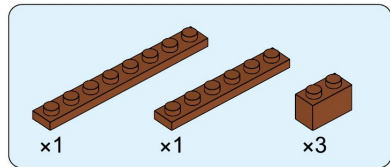

B8

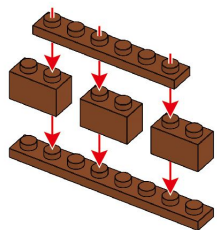

=69=

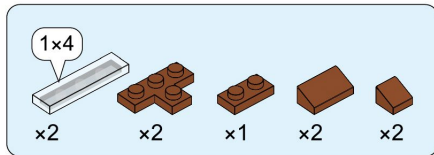

B9

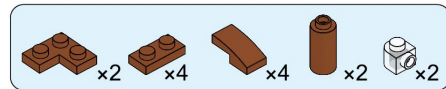
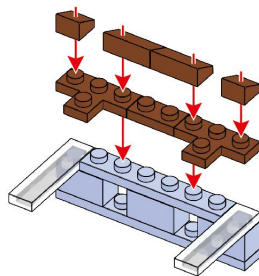

B10

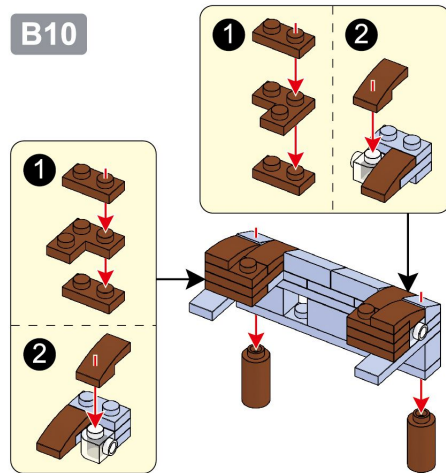

=70=

B11

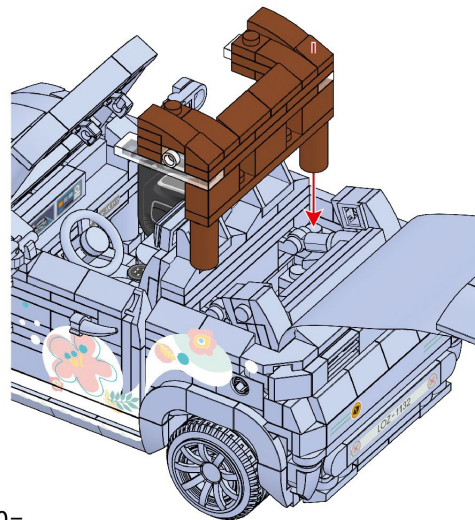

B12

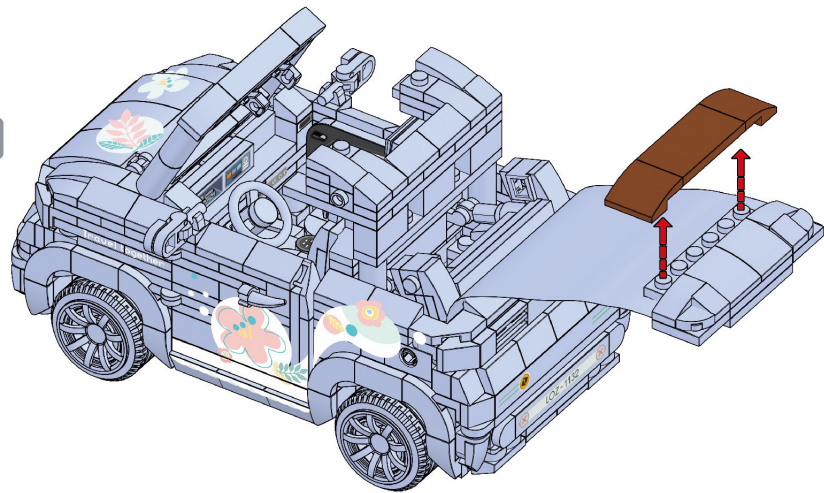

=71=

B13

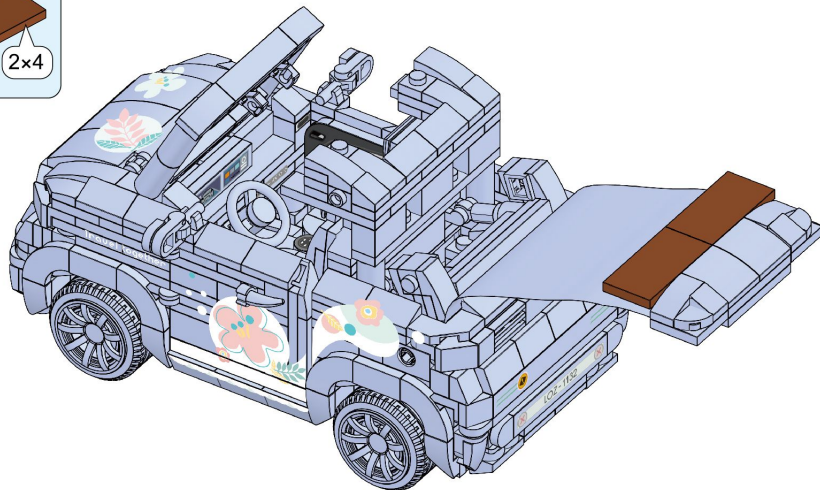
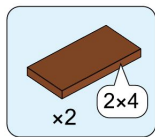

=72=

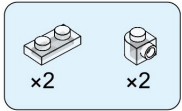

B14

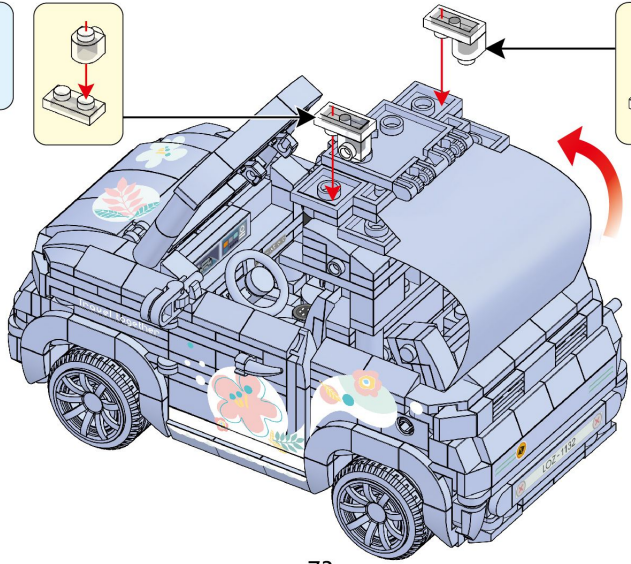
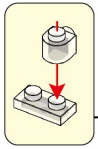

=73=

B15

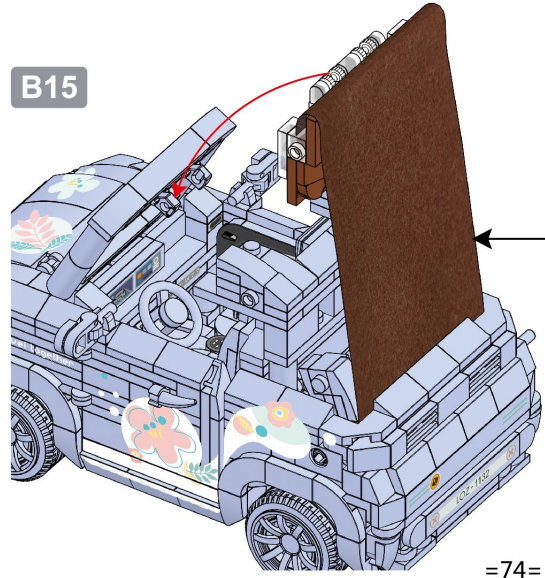

=74=

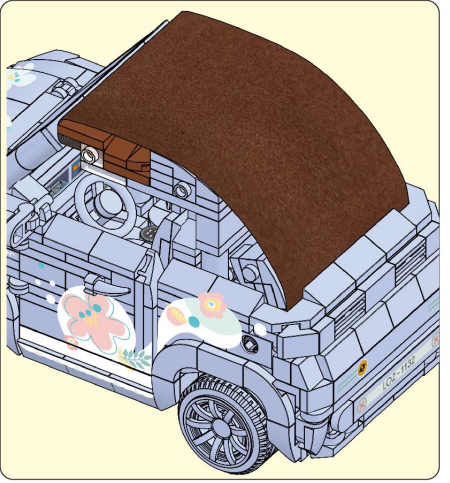



B16

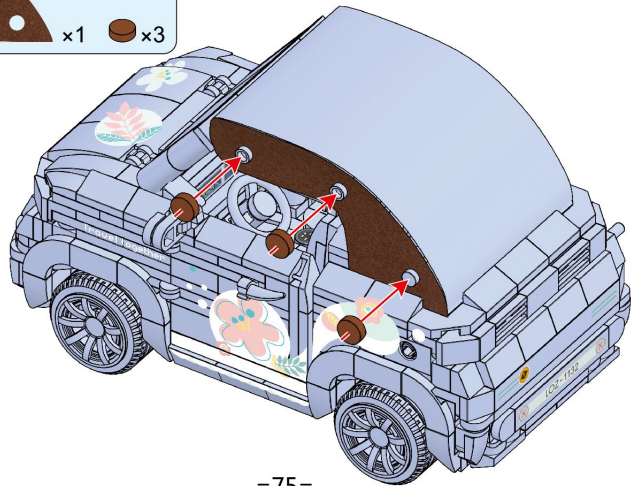

=75=

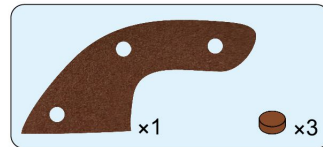

B17

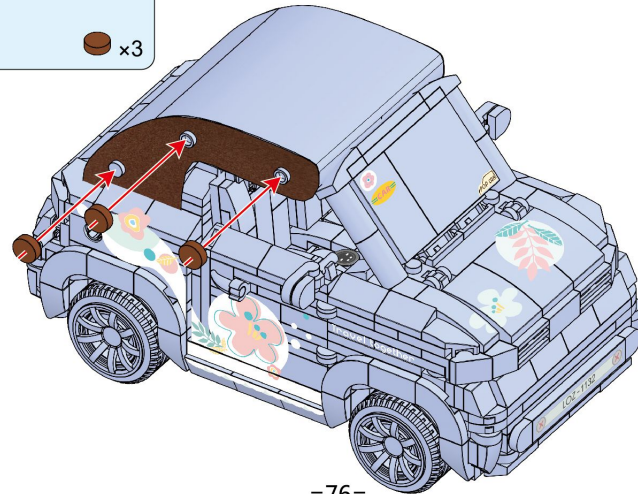

=76=

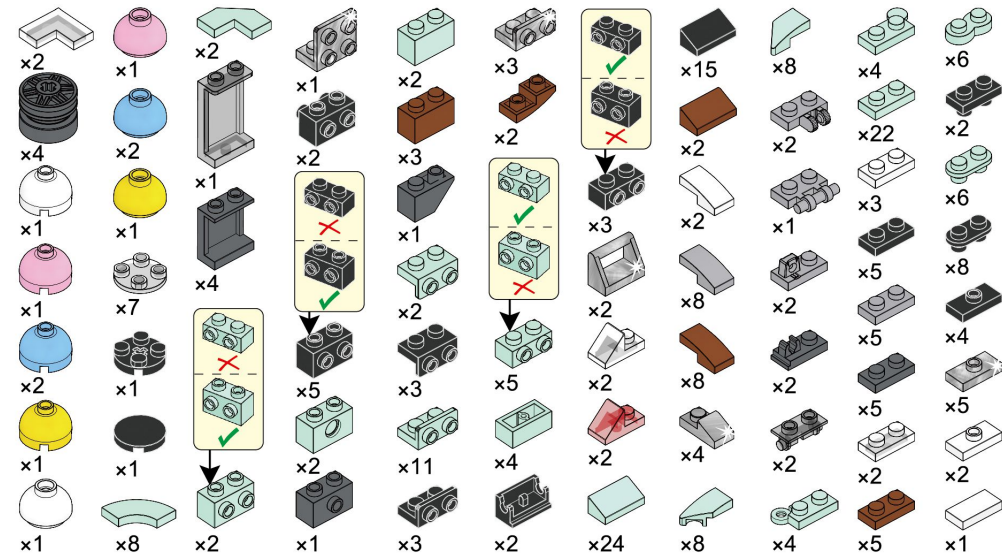
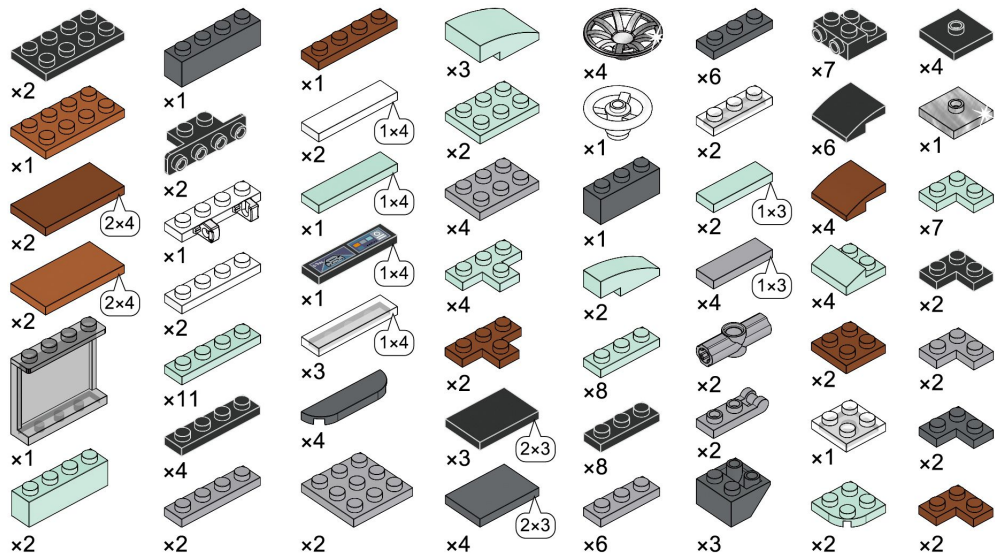

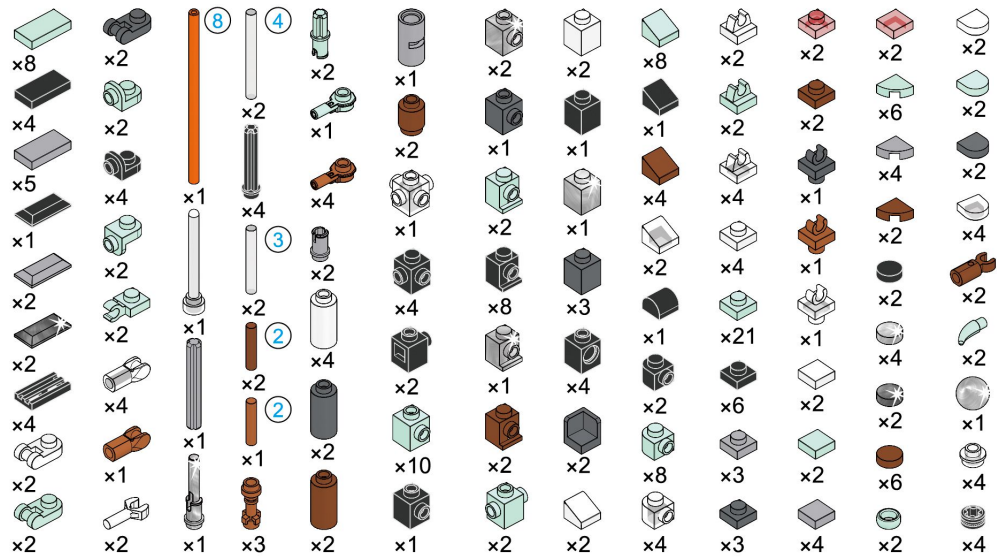

=81=

