



# MONSTER FIGHTERS

9464



1

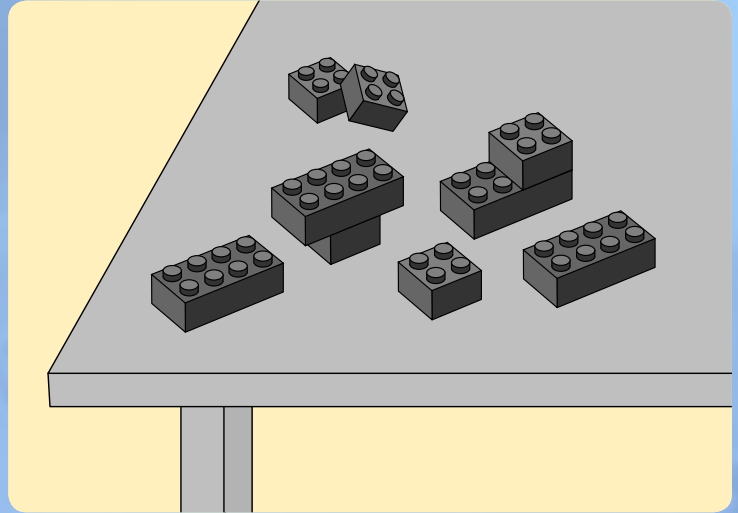
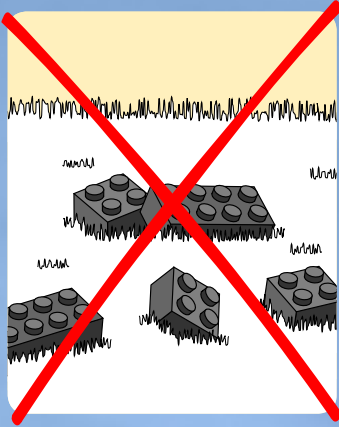

2



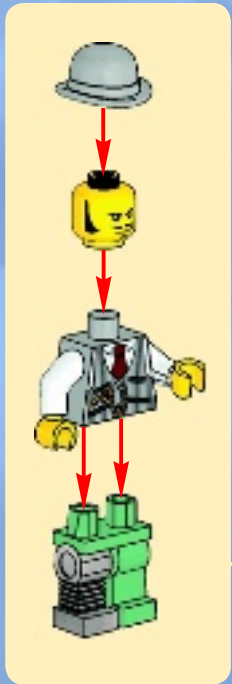
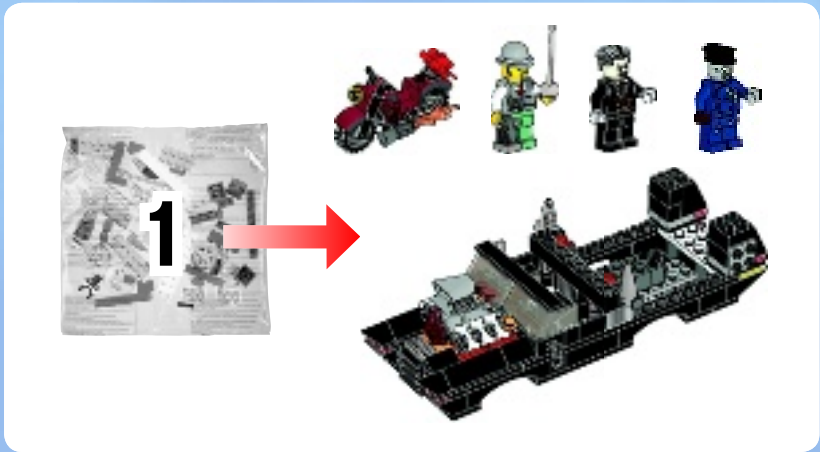



1x

1



1x

2



4



2x



2x

3



1x



1x



1x

4

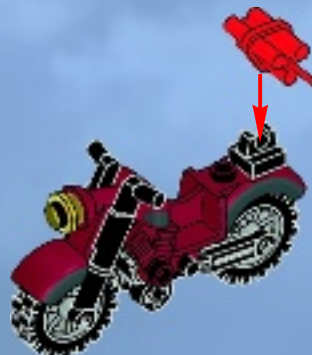



2x



2x

5

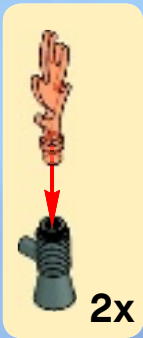

6



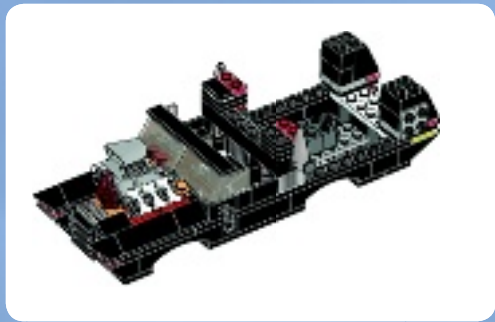

1x

1



2x

2

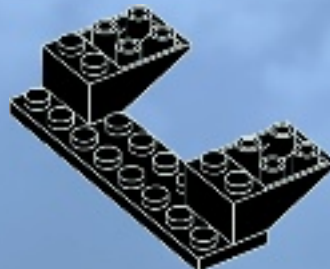

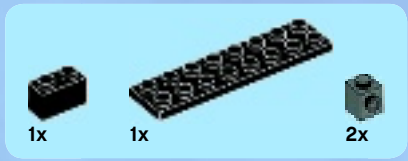

3

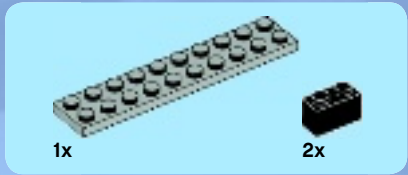
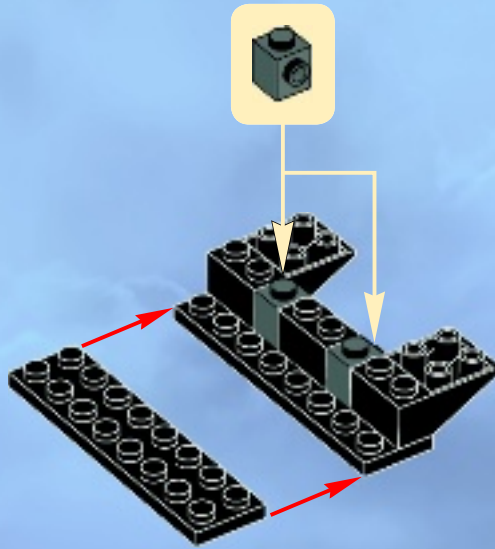

4

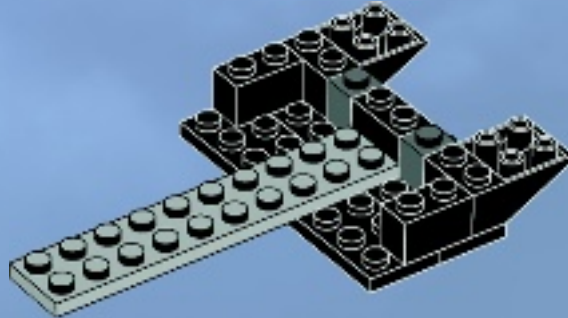

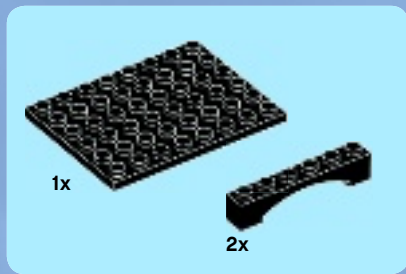

5

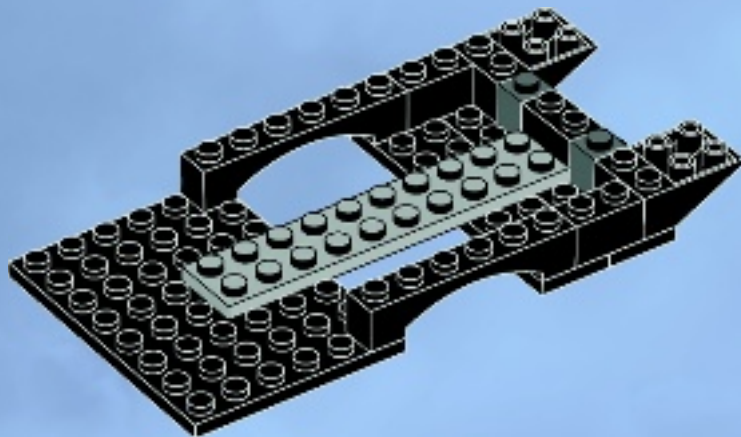

6

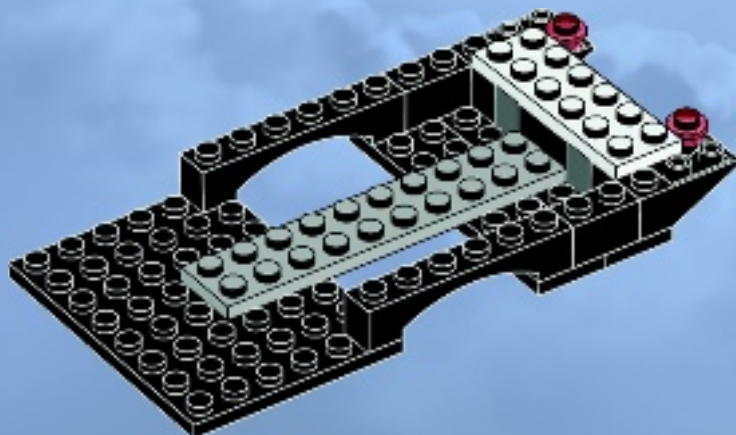





7

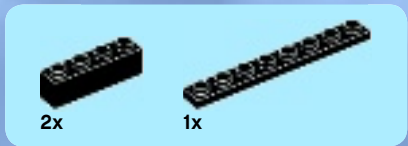
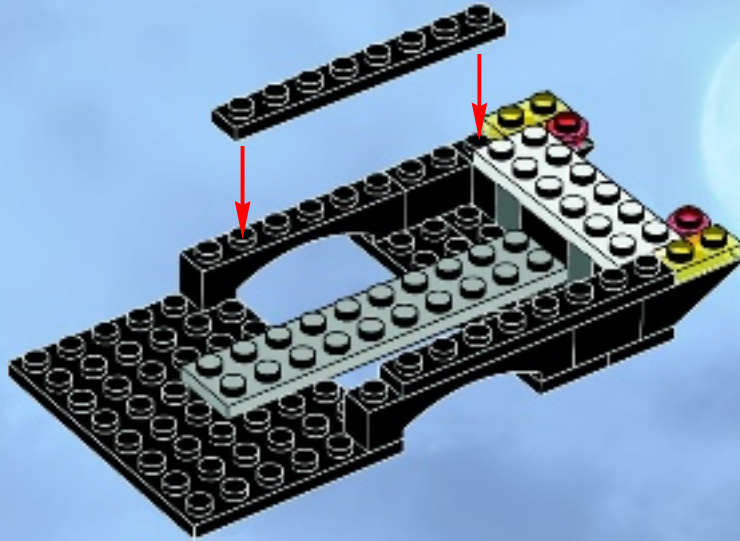

8

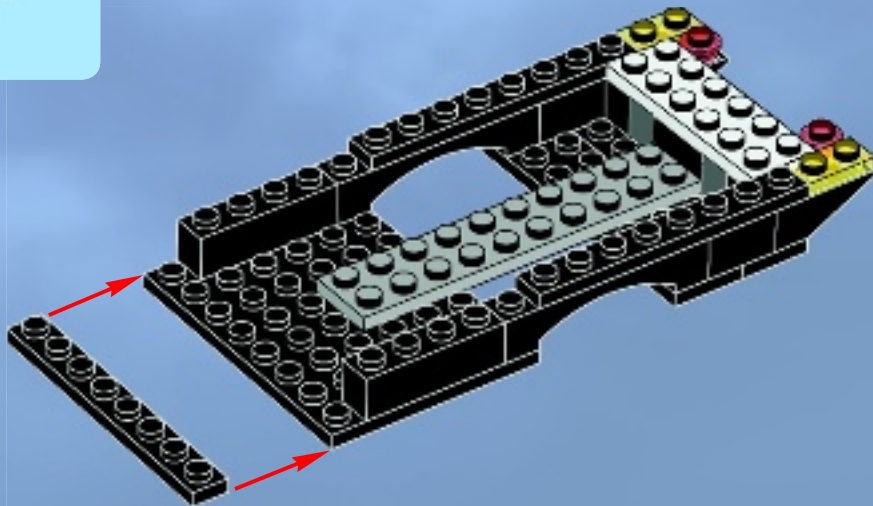



2x

# 9

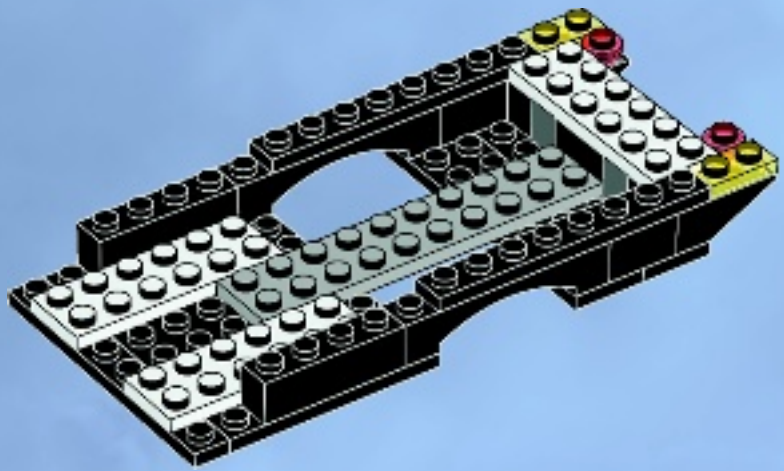

2x



1x

# 10

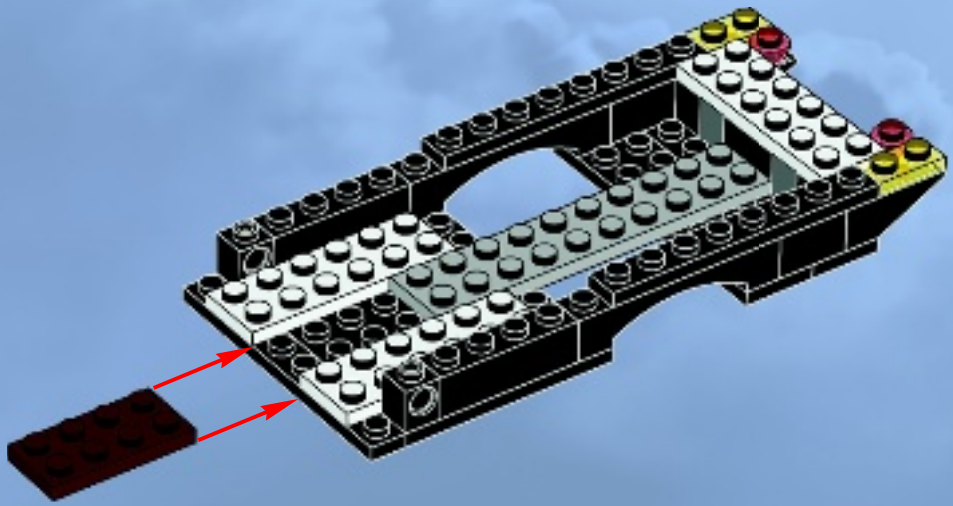

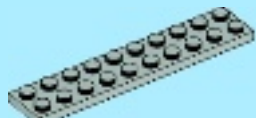

1x

# 11

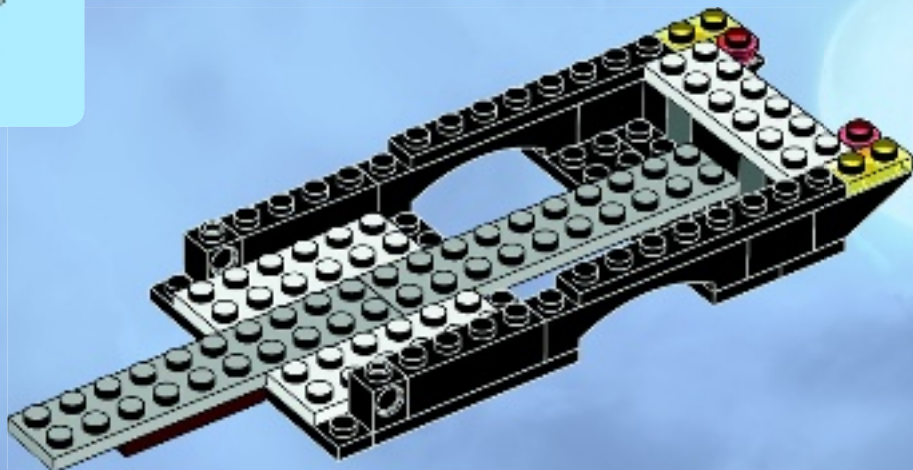

1x

# 12

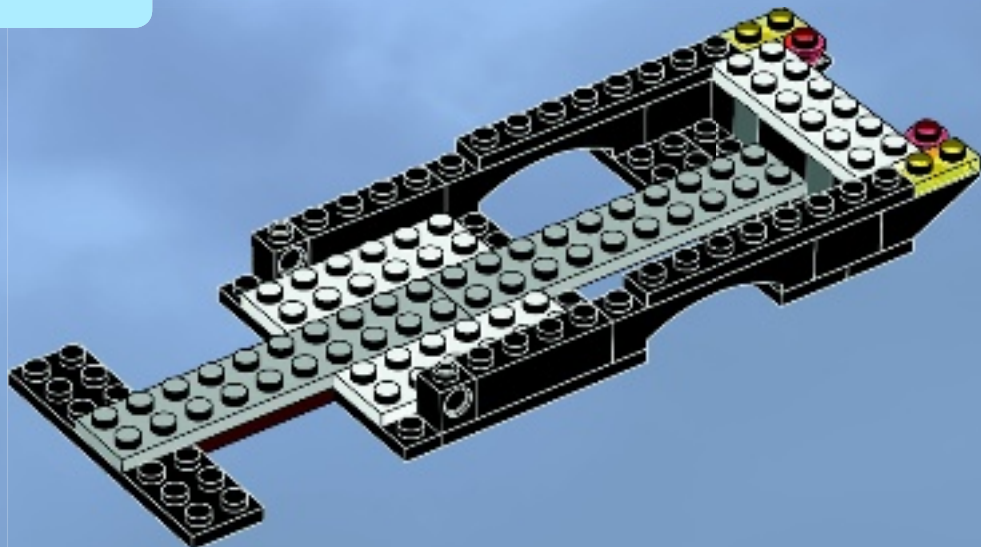



2x

13

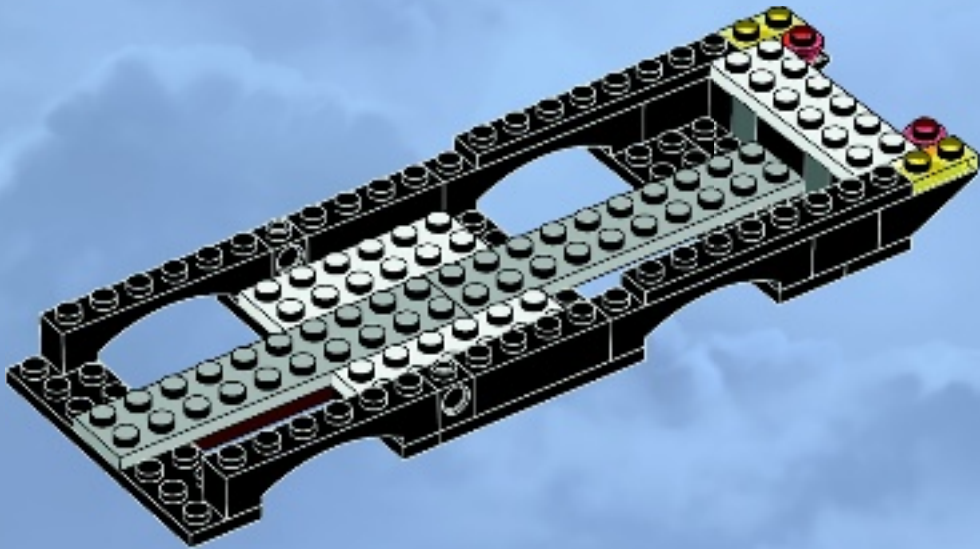



2x

14

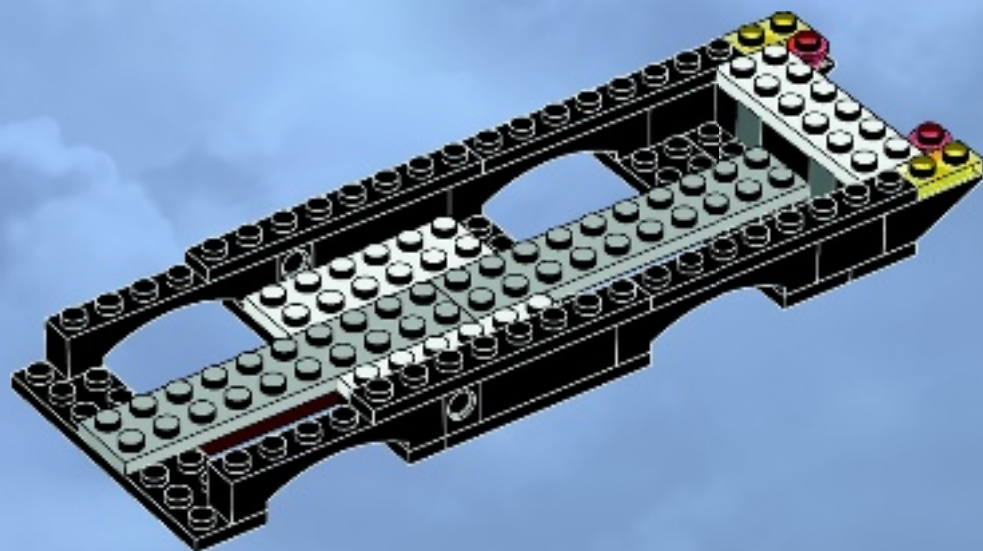



2x



2x



1x

# 15

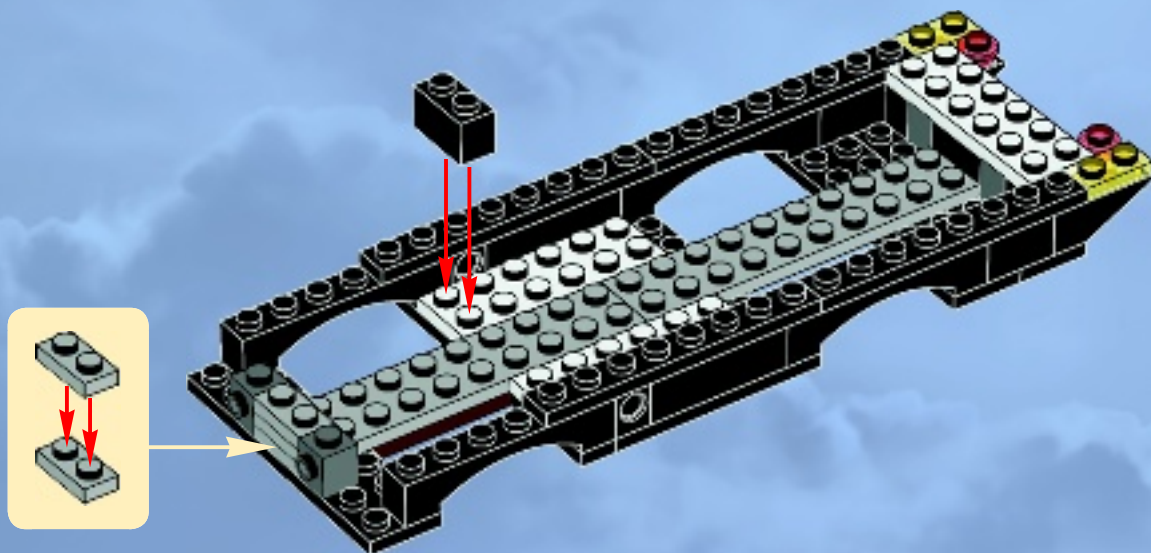



2x

16

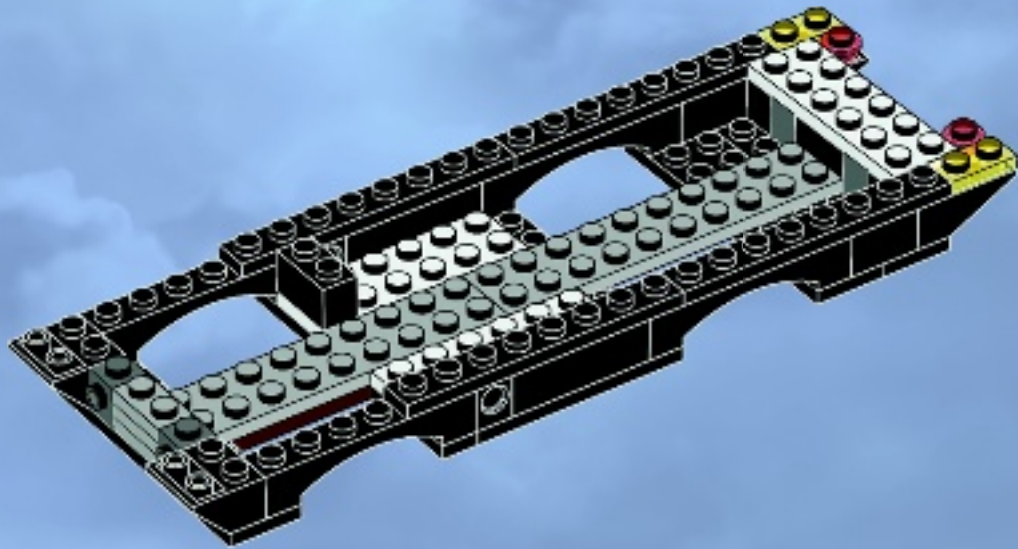



17

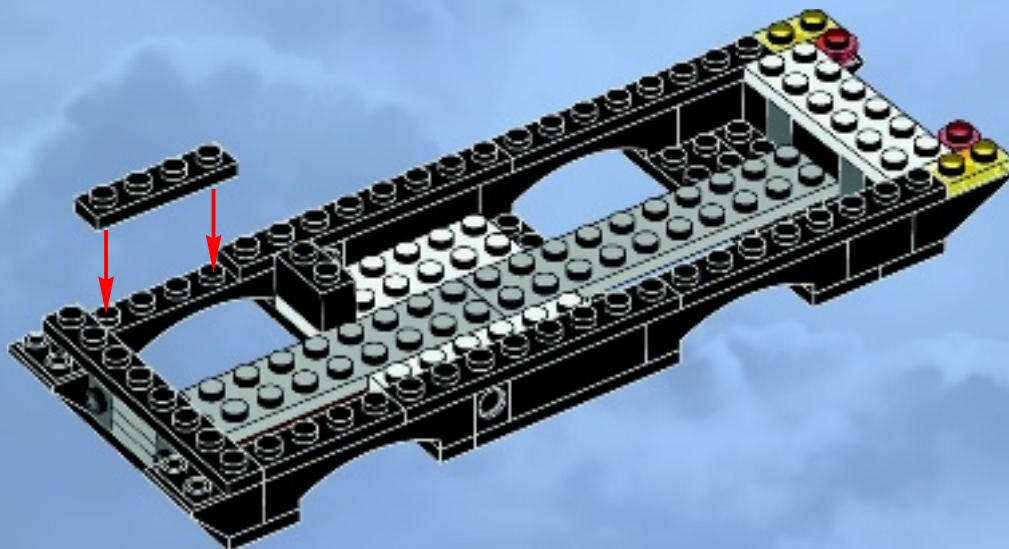





4x

18

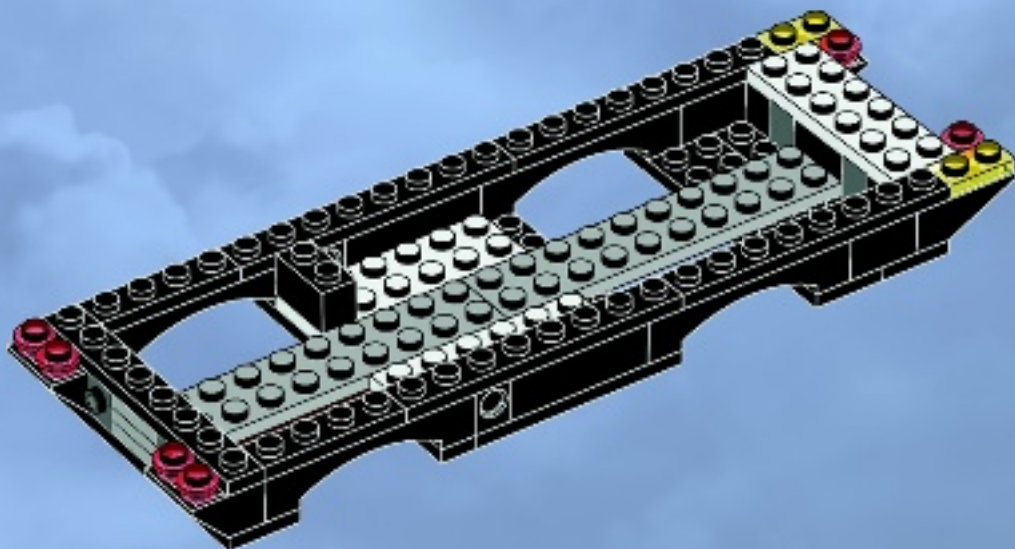



19

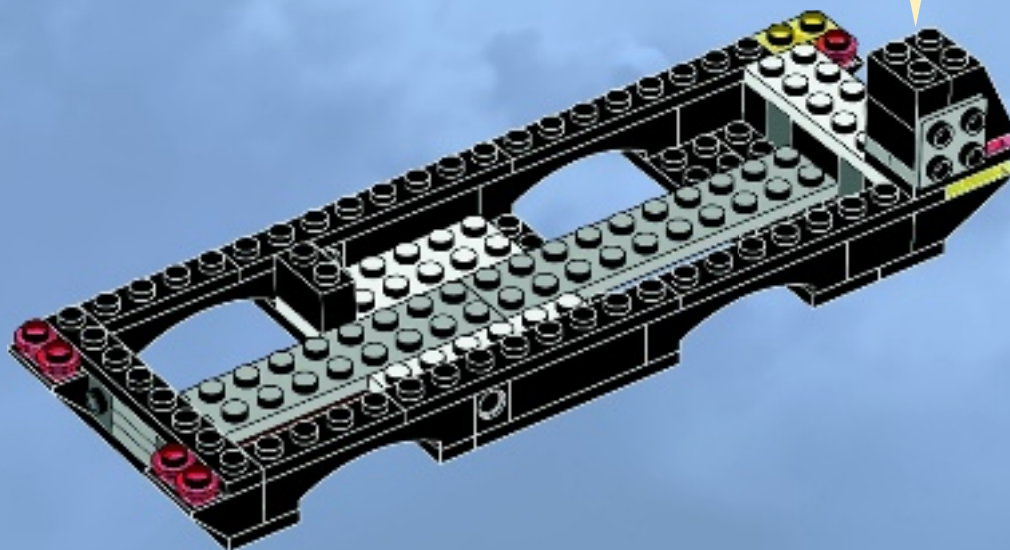



# 20

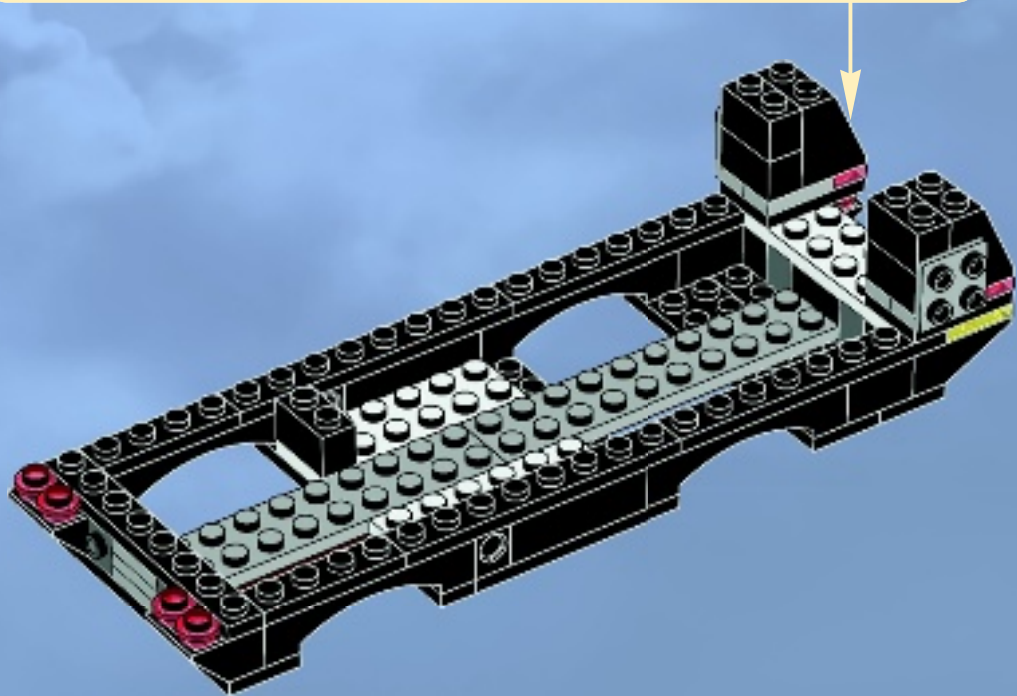
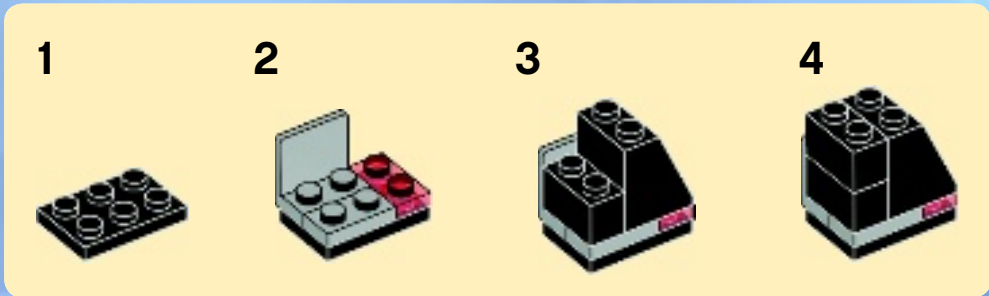



1x



1x



1x

# 21

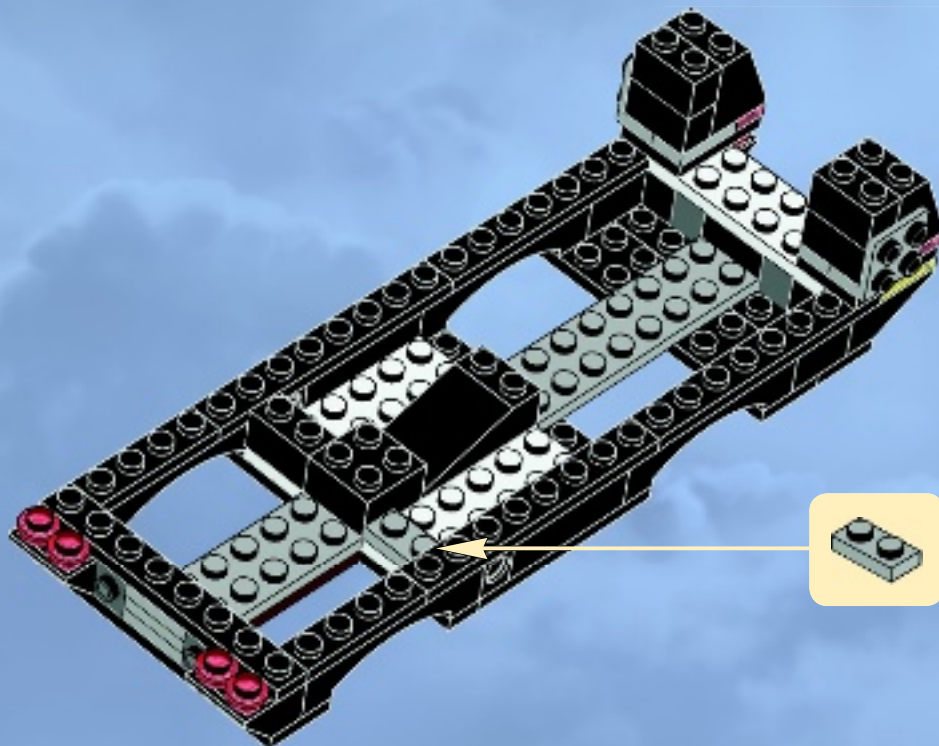



1x



1x



1x

# 22

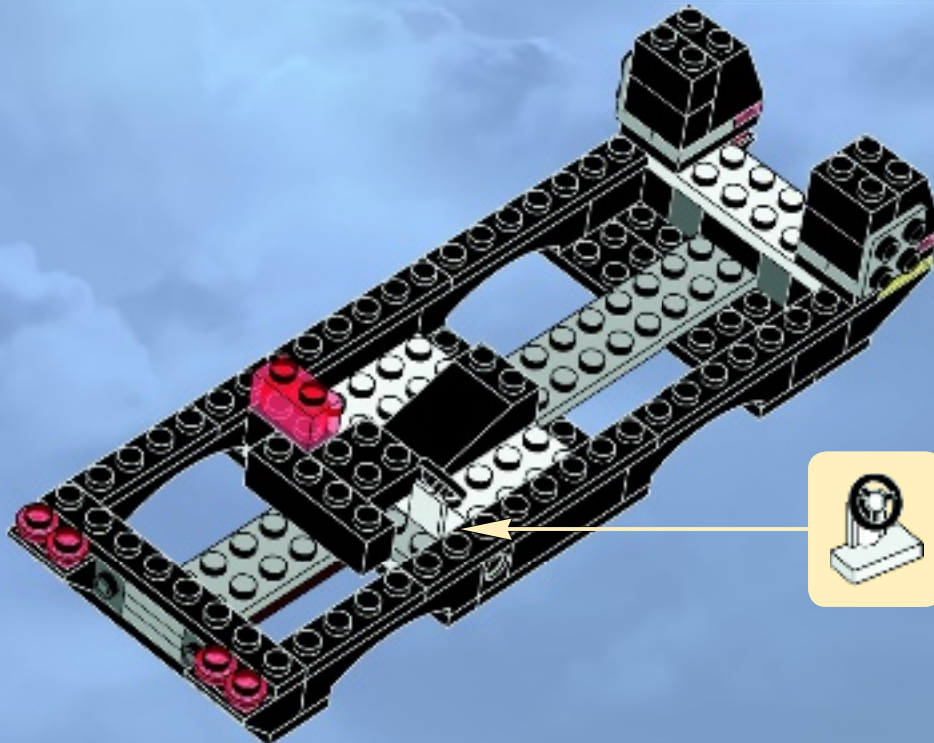



2x



2x



2x

# 23

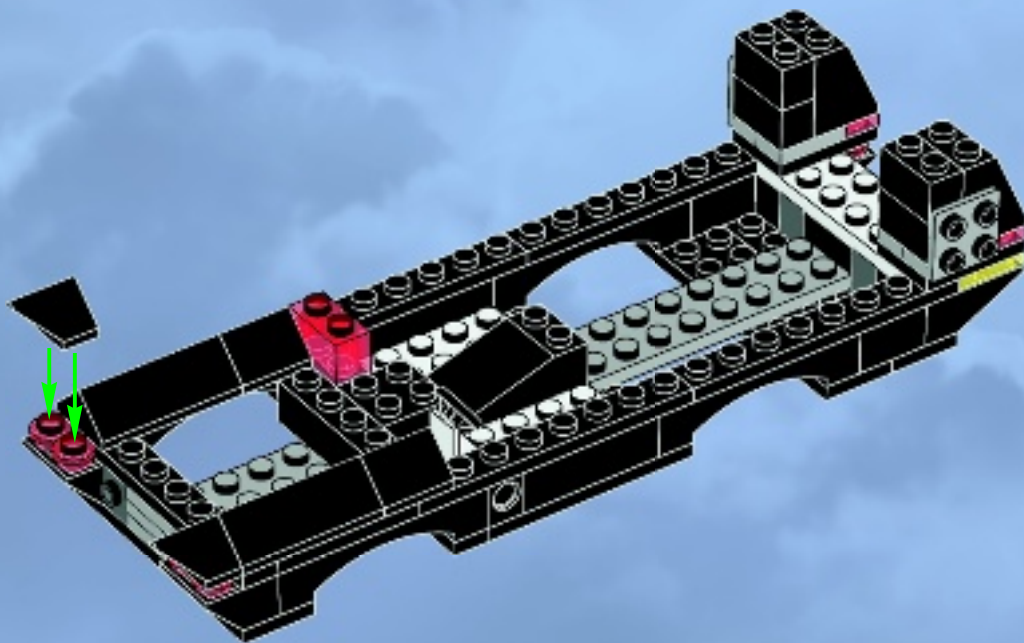



2x



2x



1x



1x

# 24

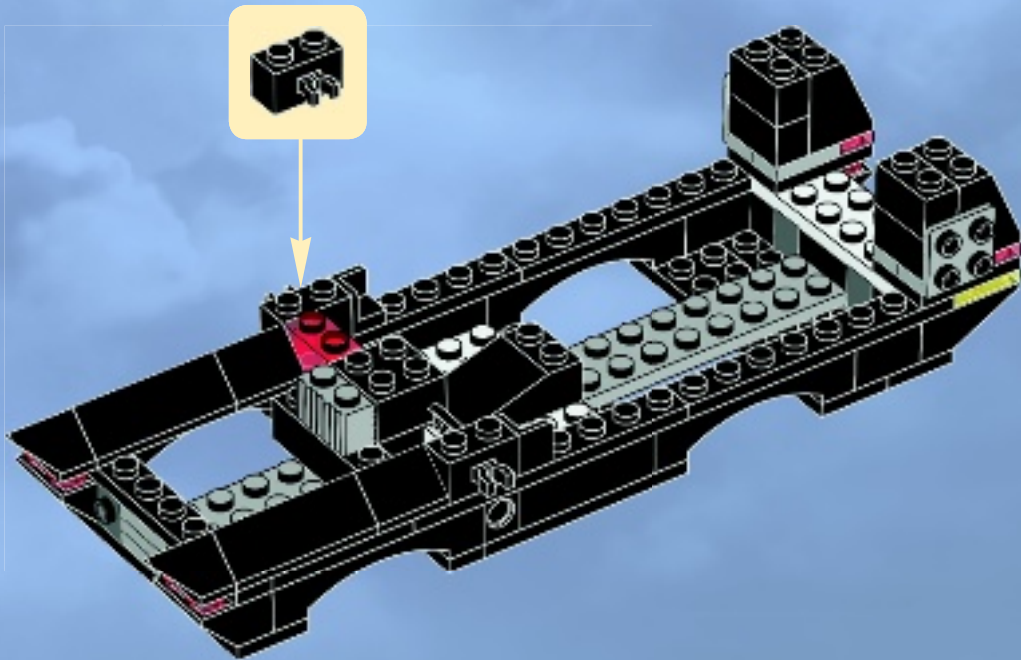



2x



3x

# 25

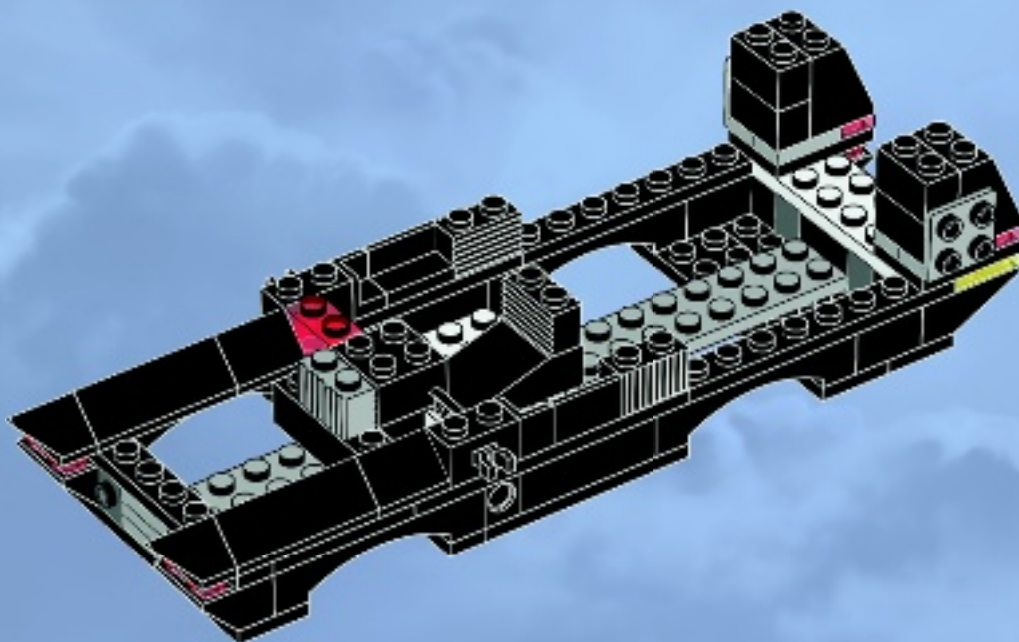





1

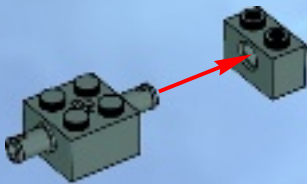

2

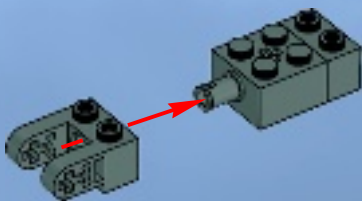

3

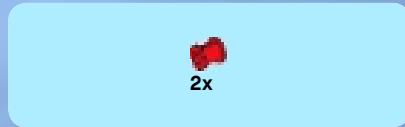

4

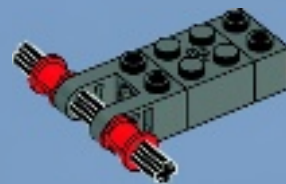



2x

5

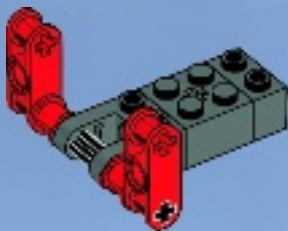

2x



2x



2x

6

1

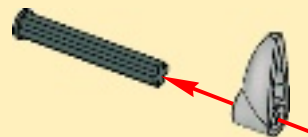

2



2x

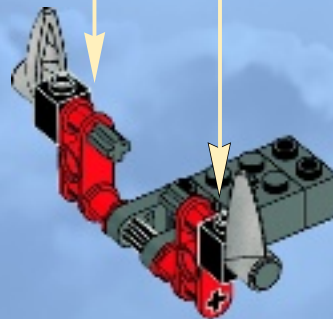

26

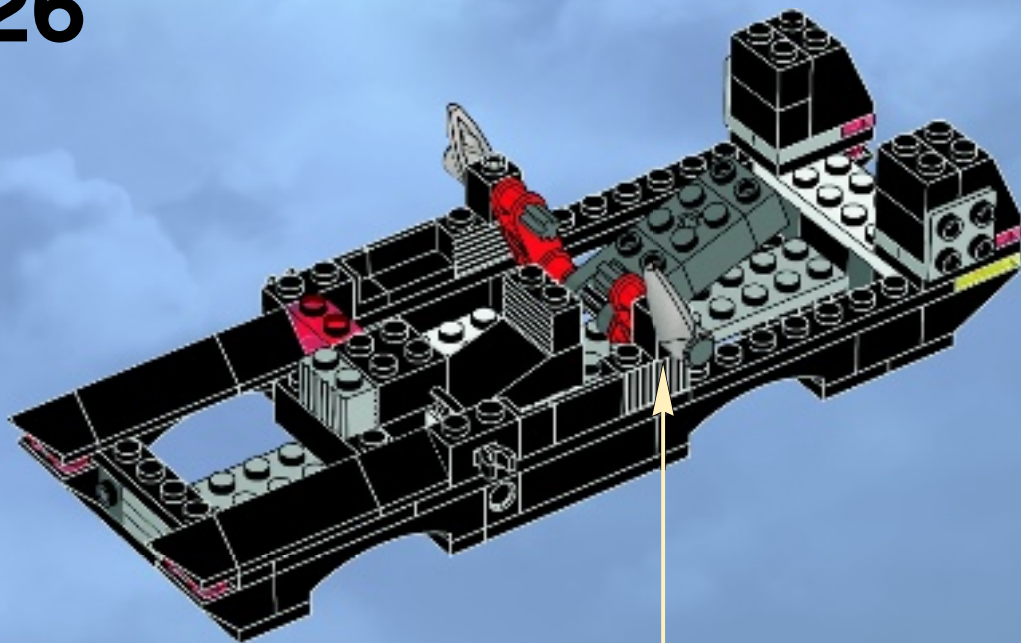

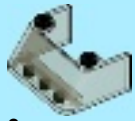

2x

27

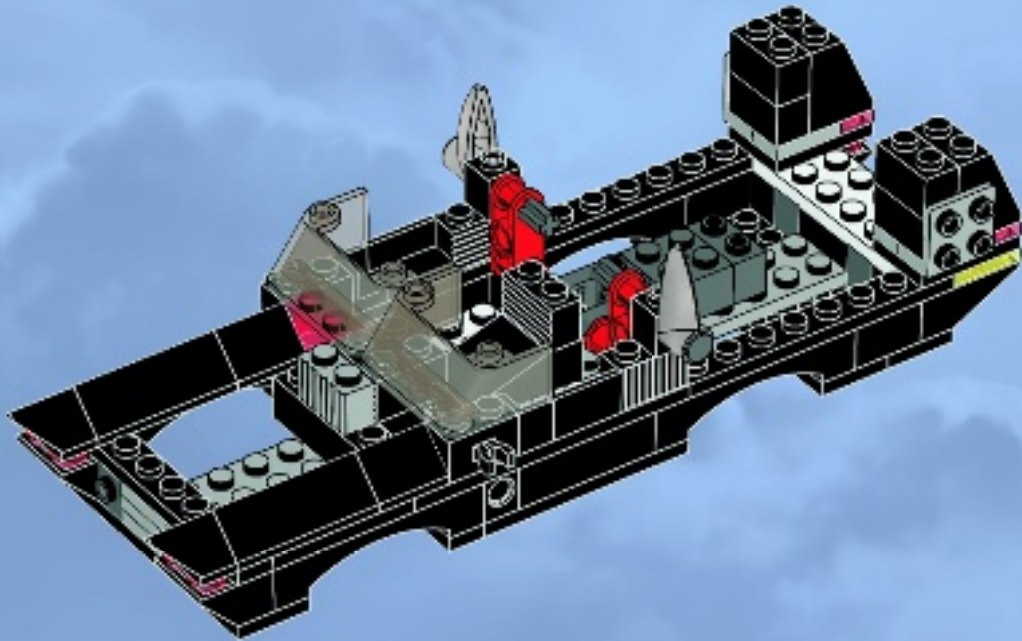

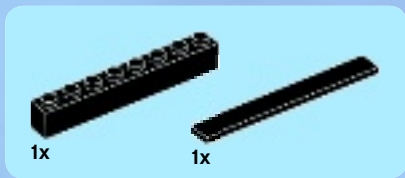

28

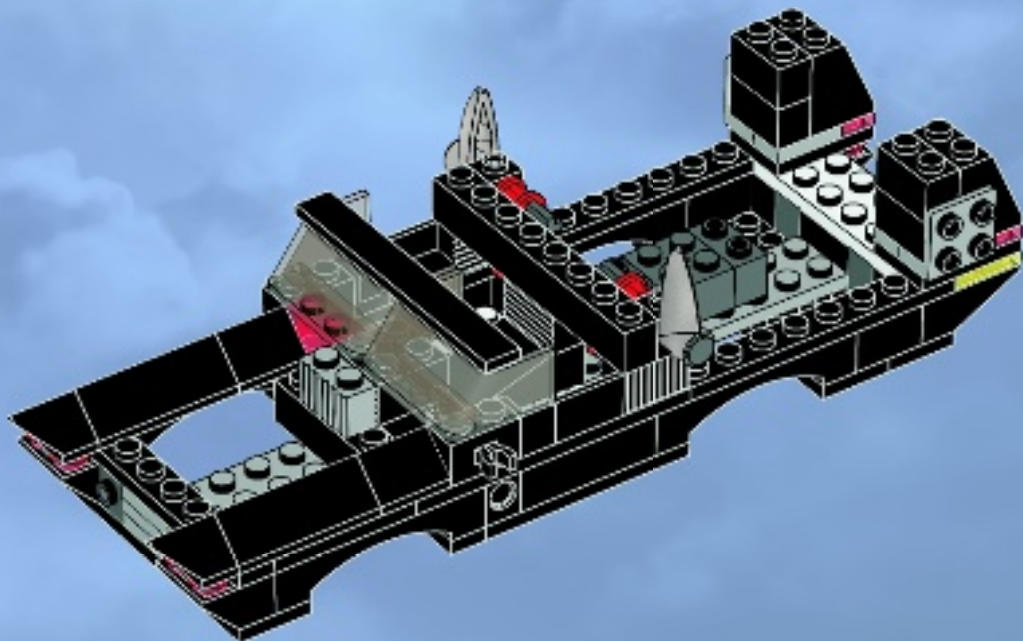

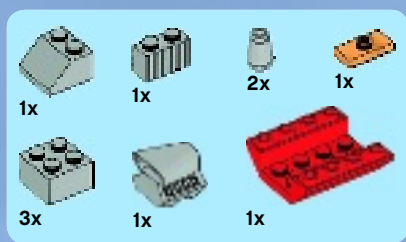

29

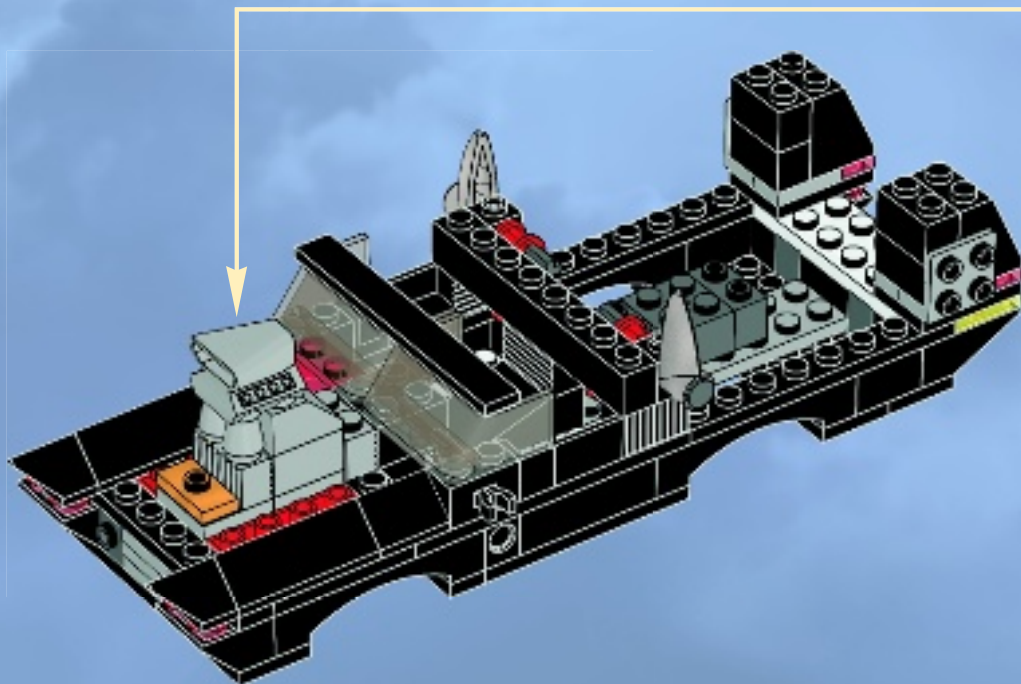
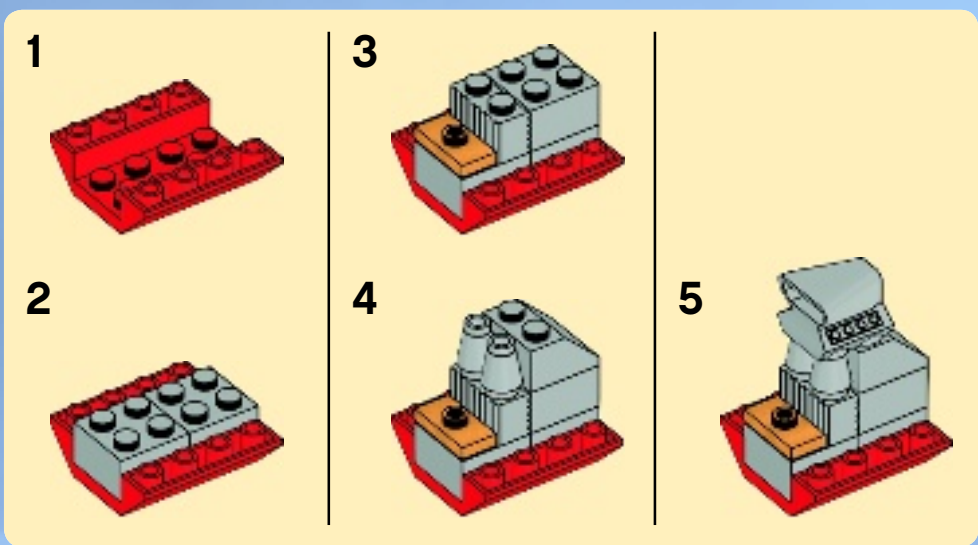

- 1x 
- 1x 
- 1x 
- 1x 
- 1x 

# 30

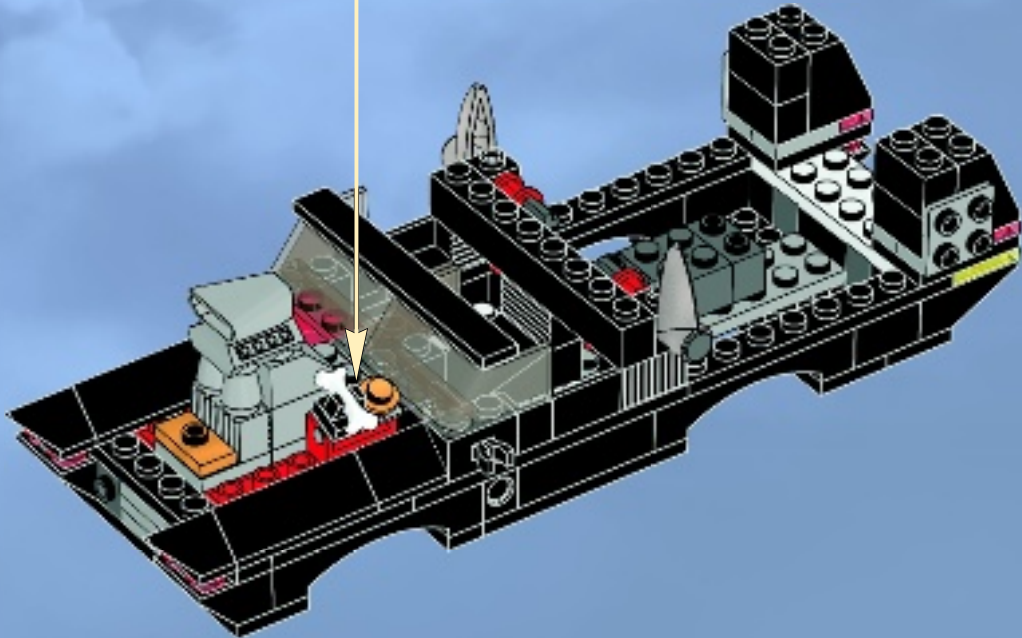



# 31

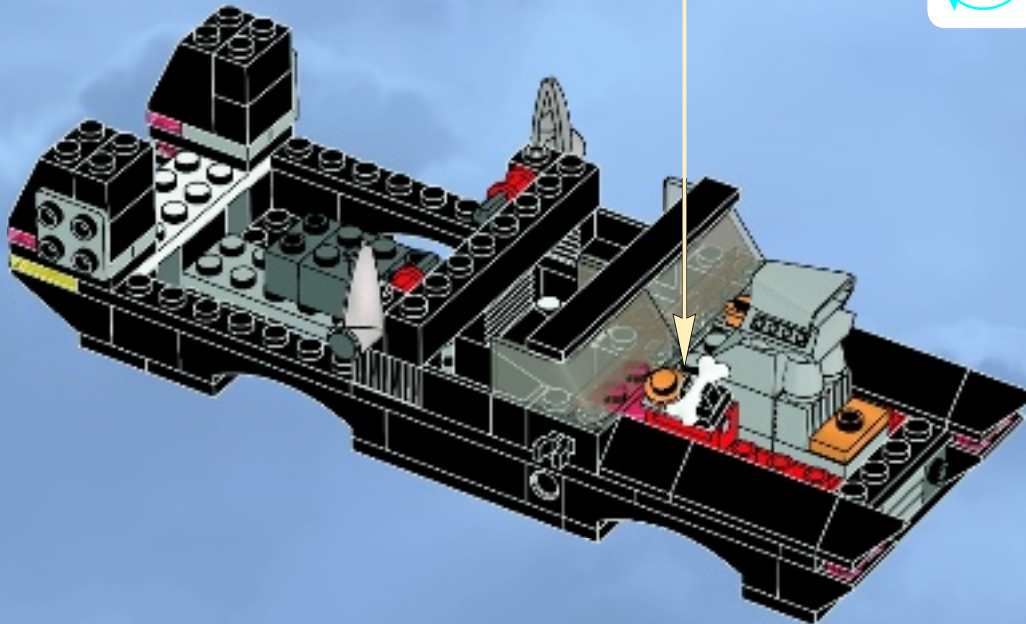





# 32

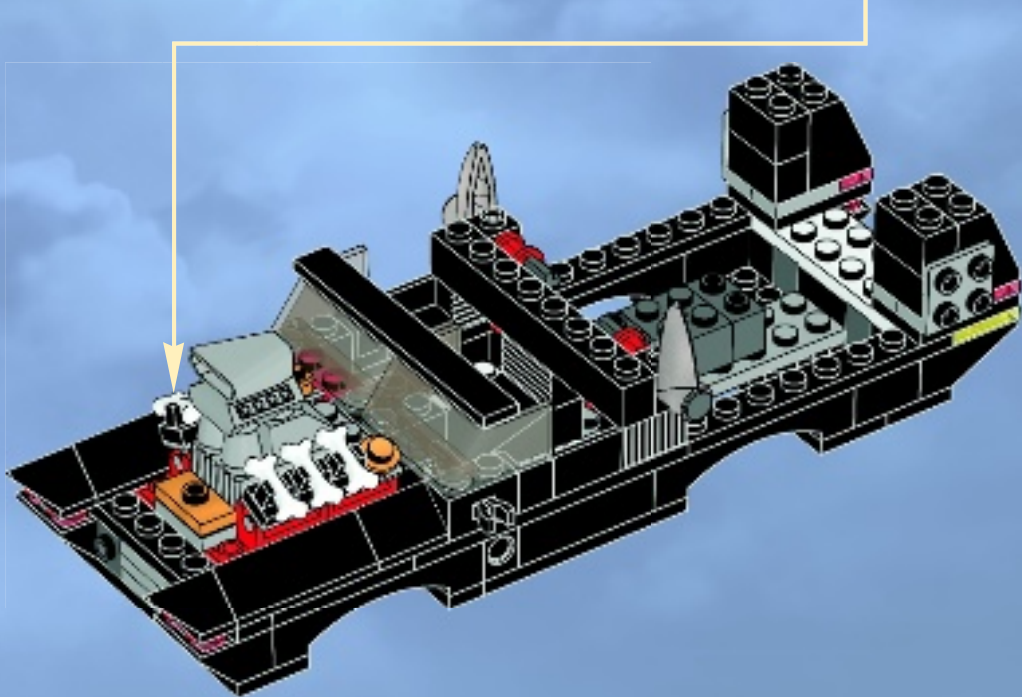
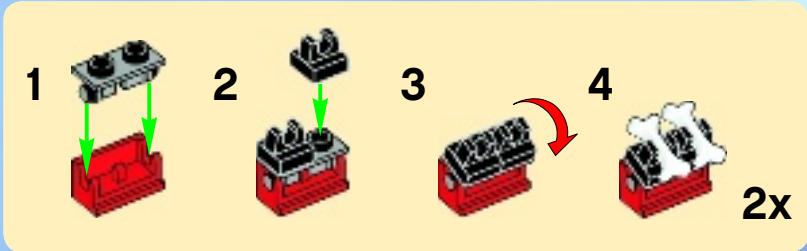



2x



1x

# 33

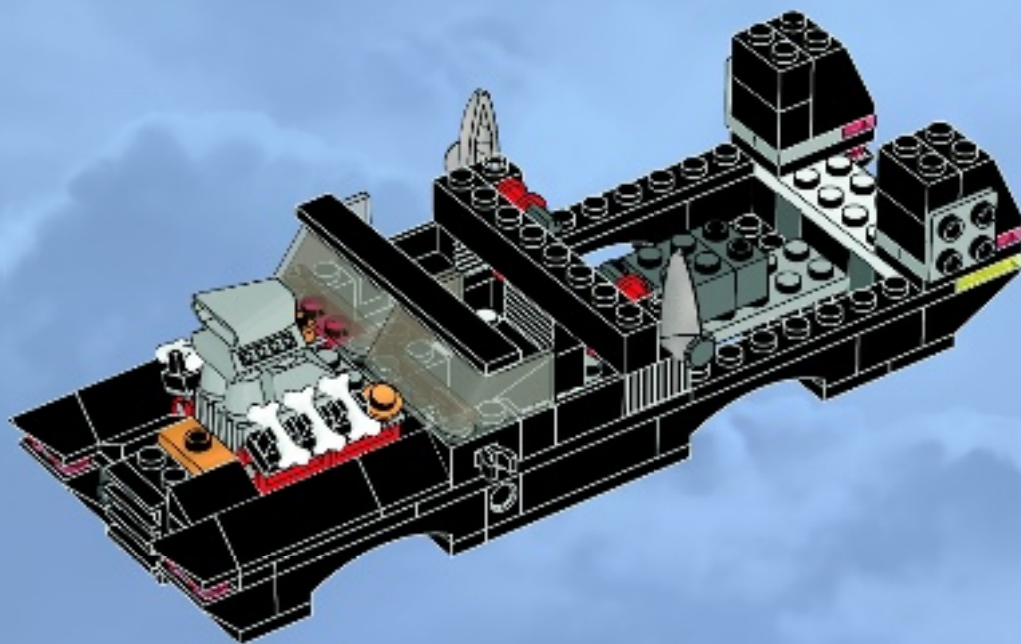



1x



1x

# 34

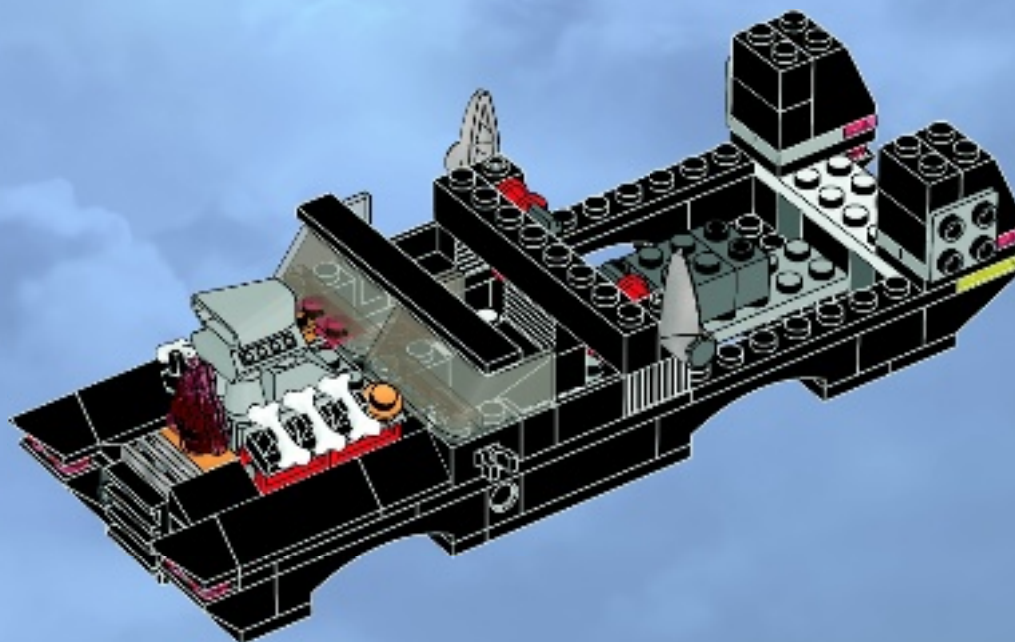

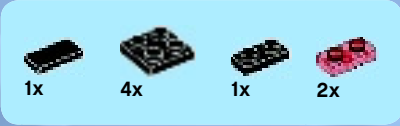
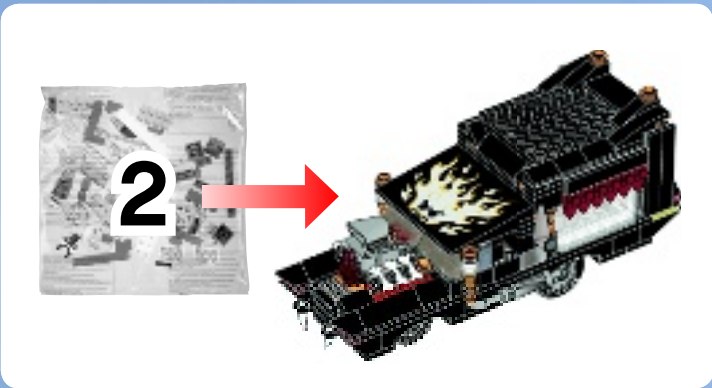

35

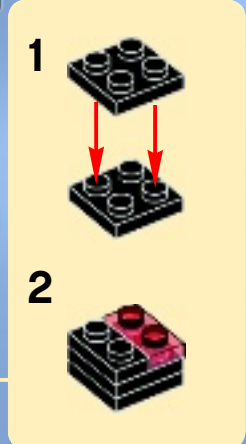
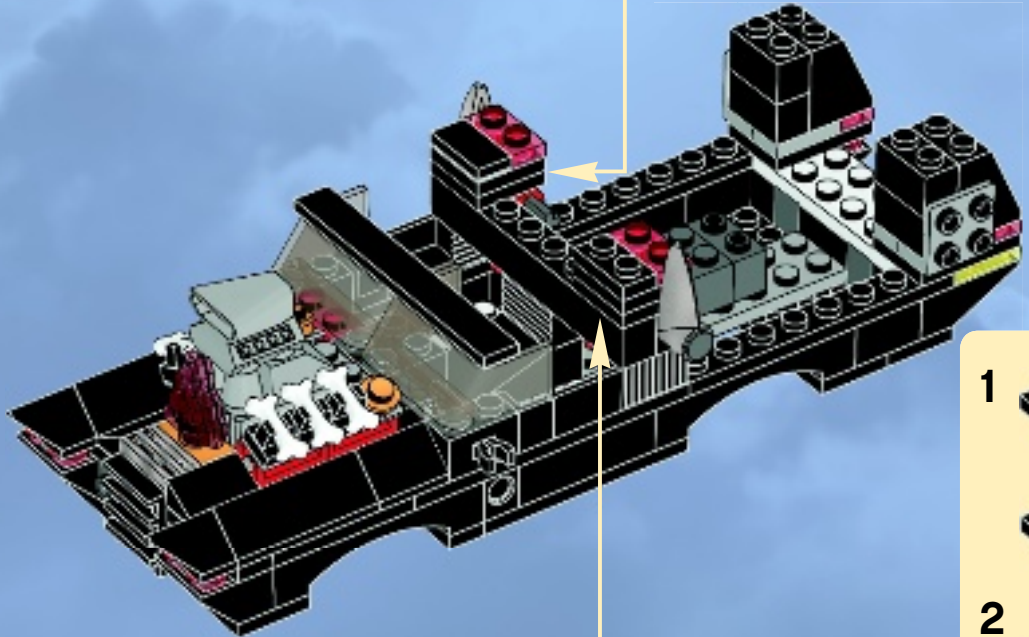



1x



1x

# 36

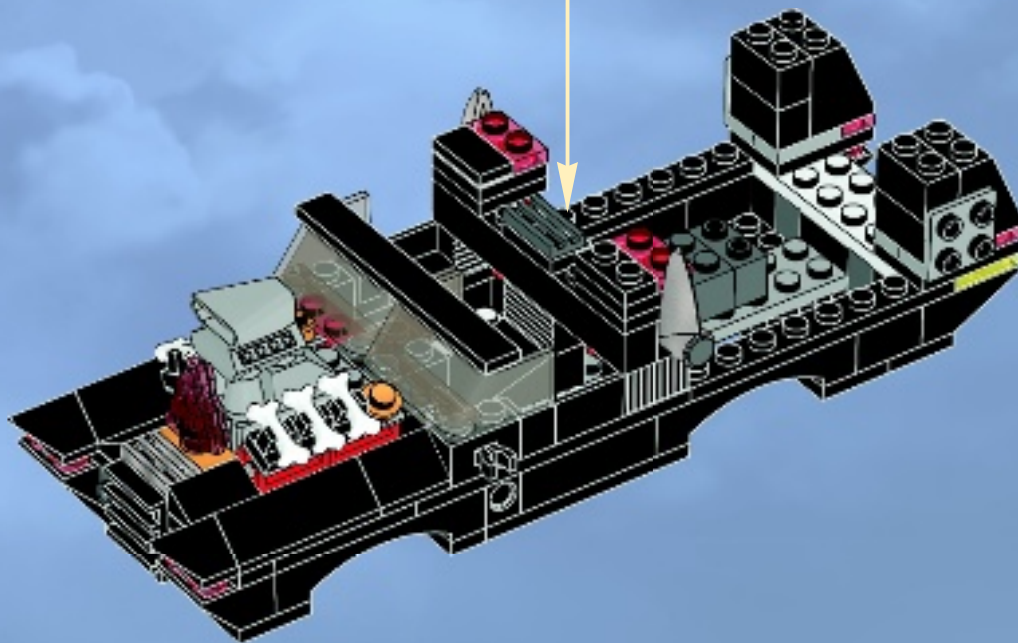
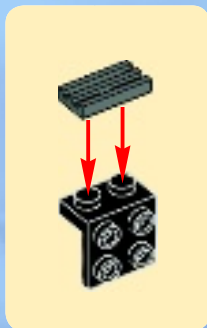



1

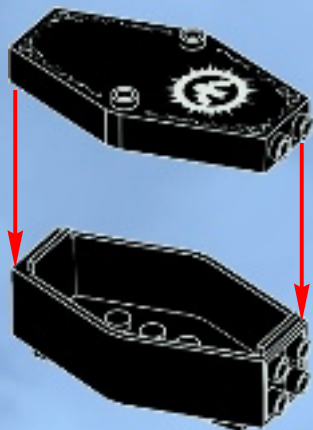

2



3

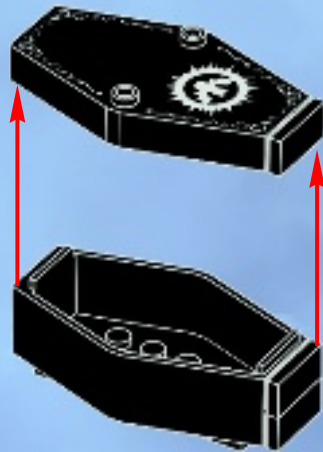

4

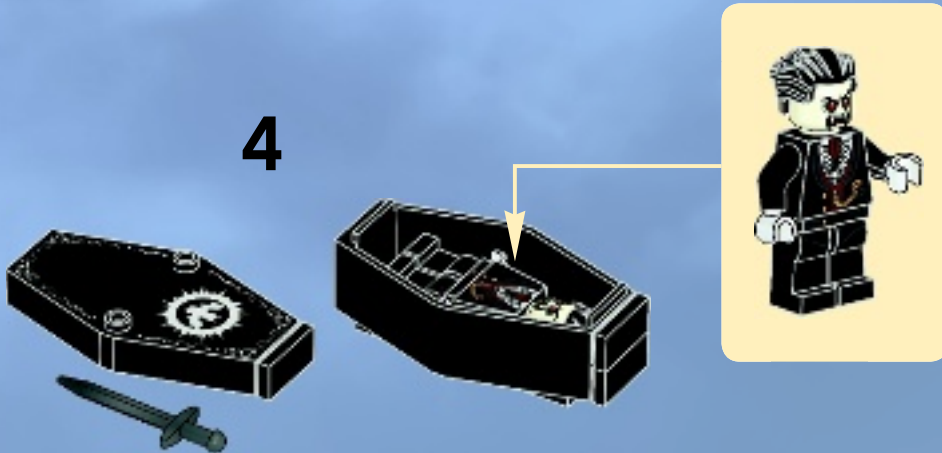



37

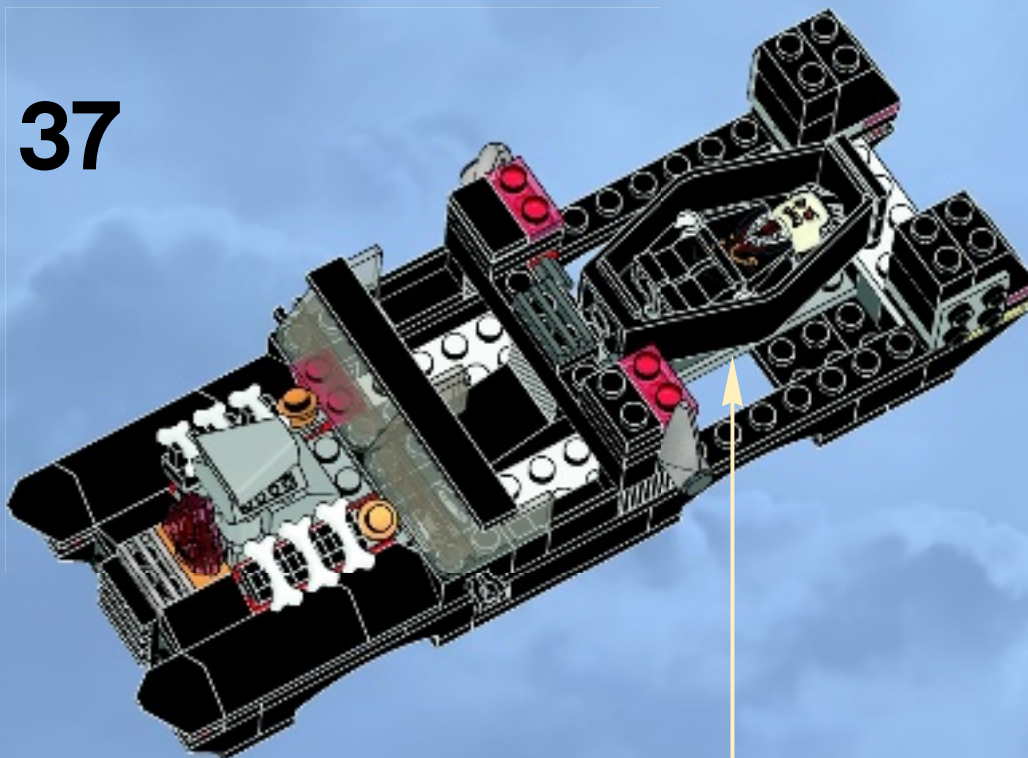





2x



2x

# 38

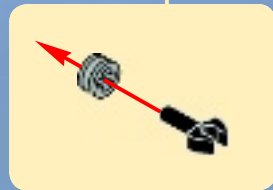
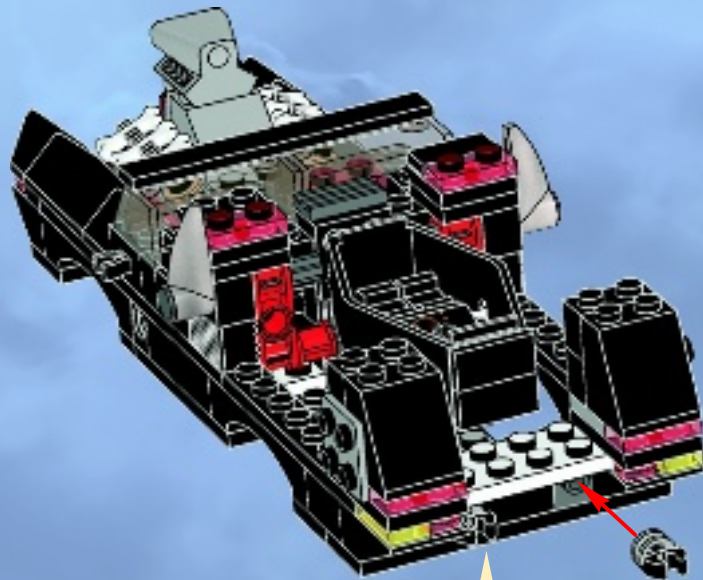



1x



4x



2x

# 39

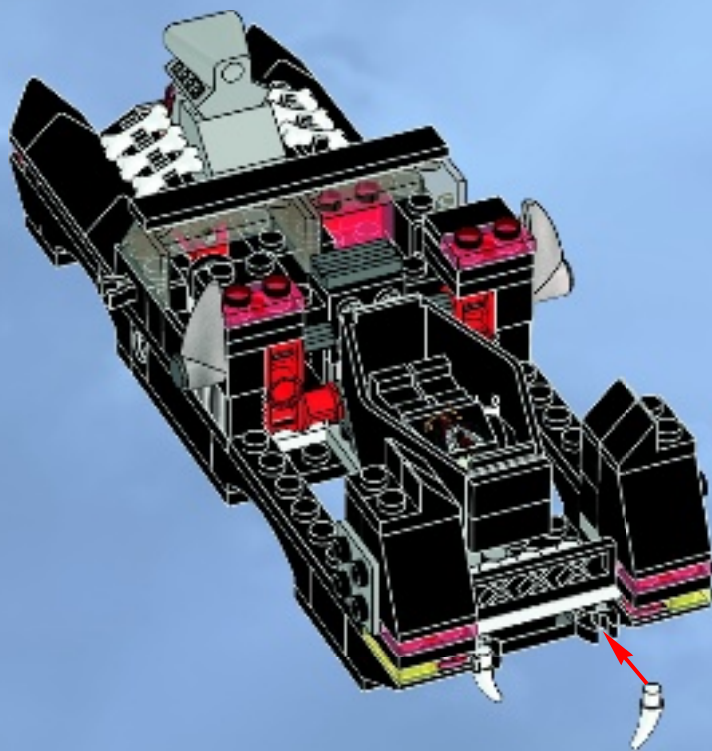



2x



2x



2x

# 40

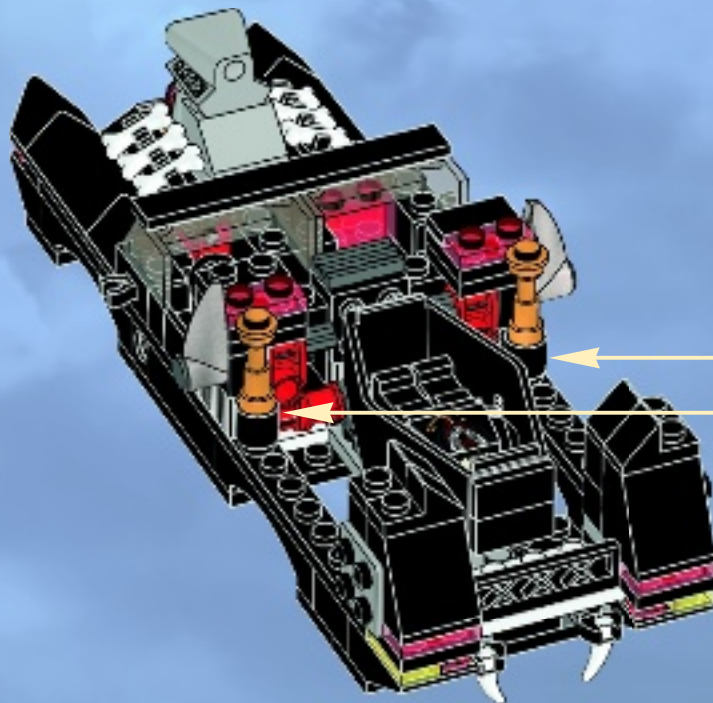

2x



2x

# 41

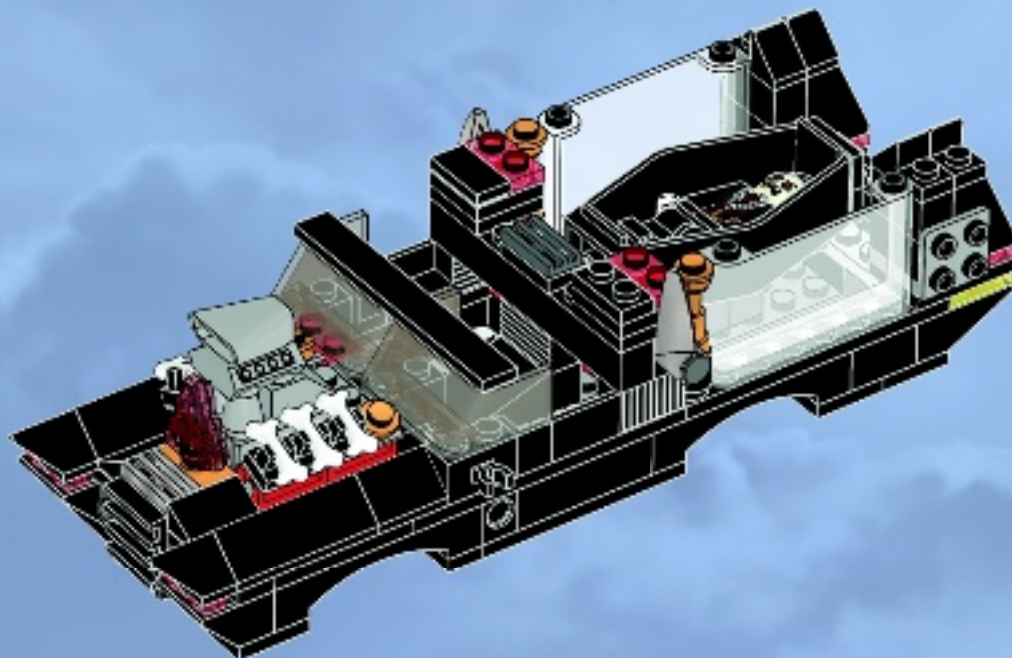



2x



2x

# 42

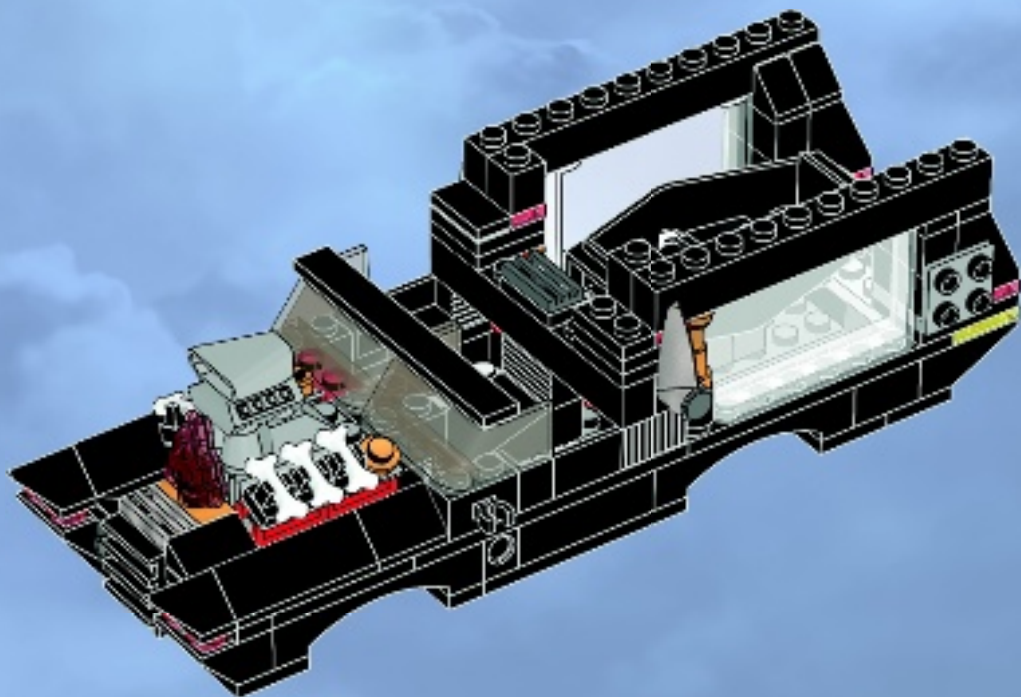



# 43

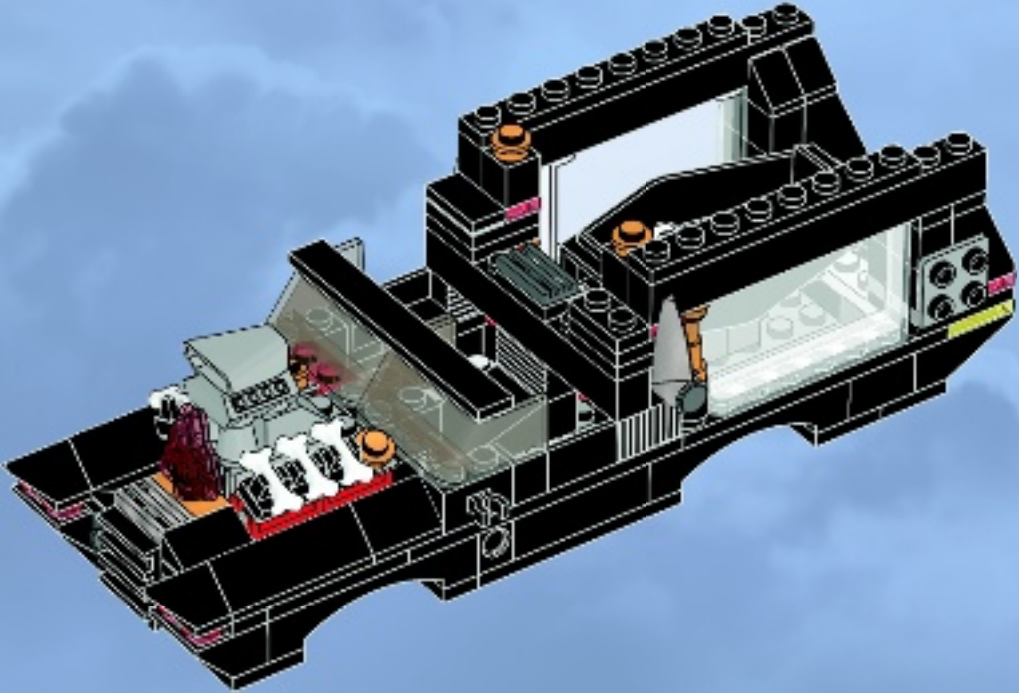



2x



2x

# 44

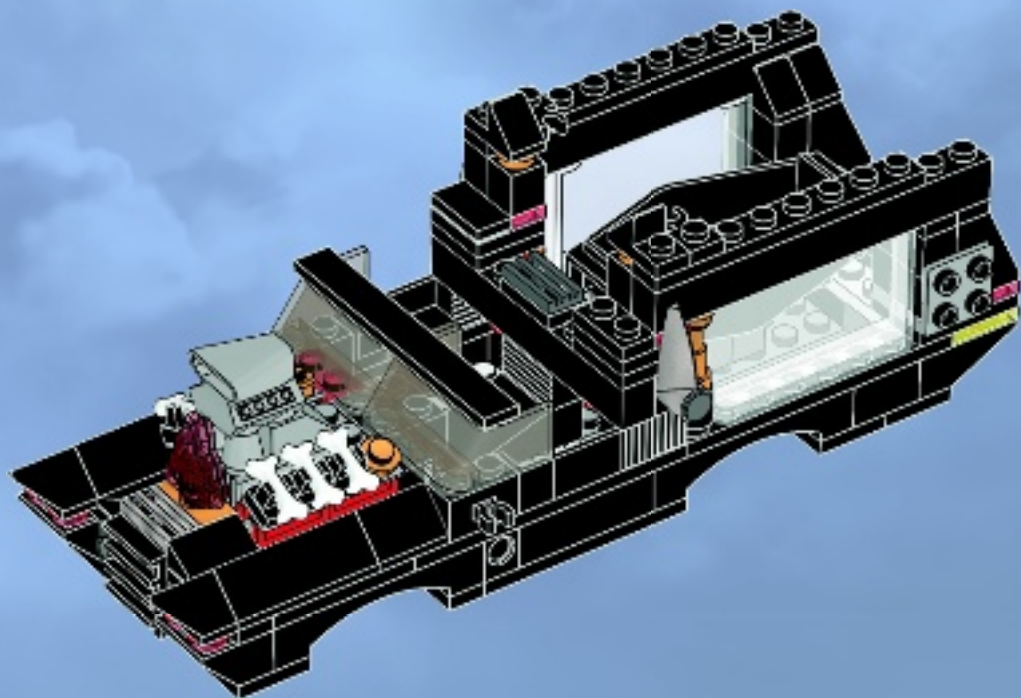



6x

45



3x

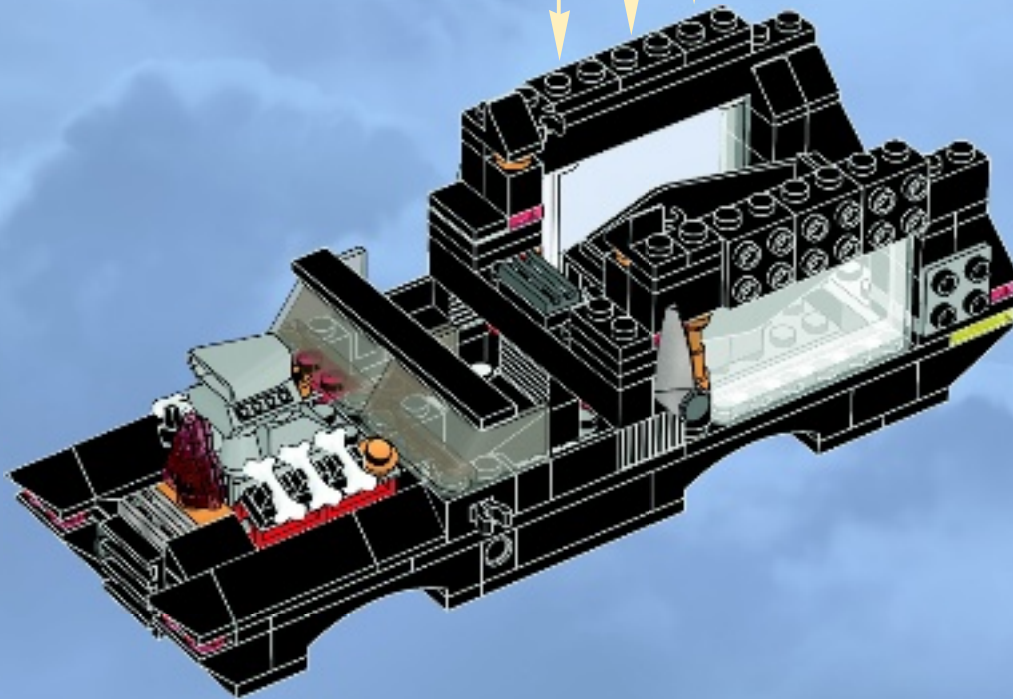





2x



6x

# 46

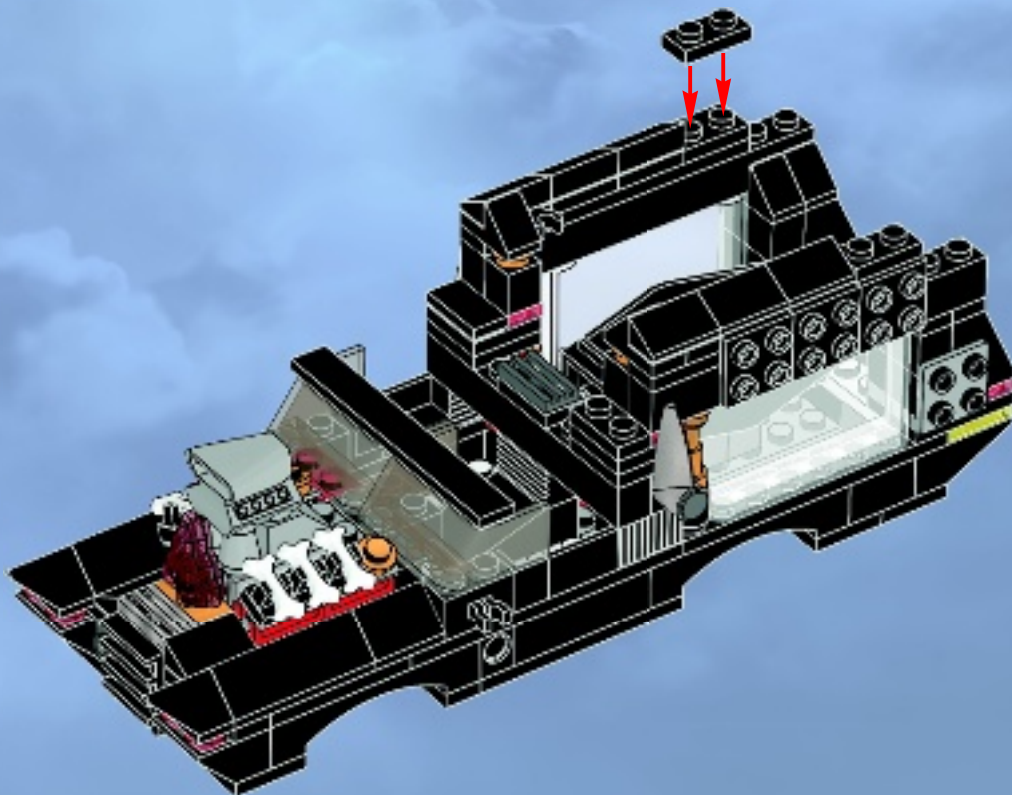

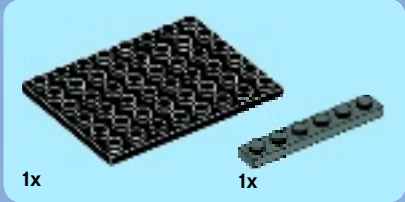

1

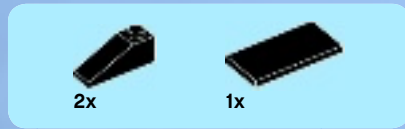
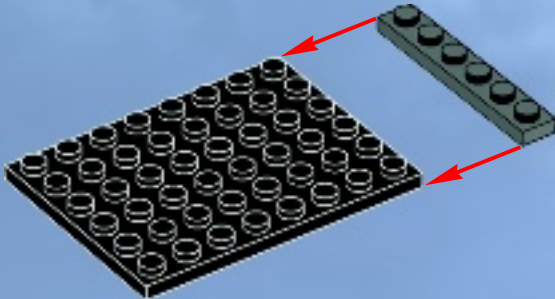

2

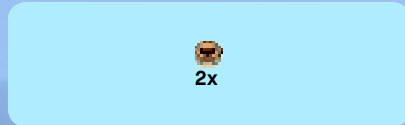

3

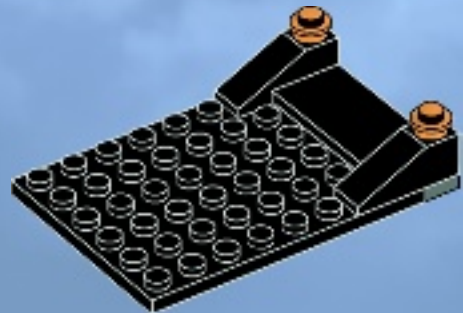



4

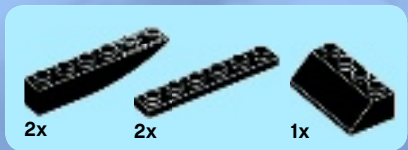
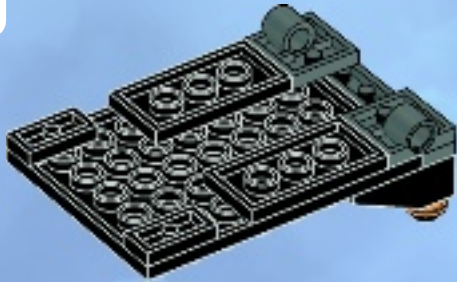

5

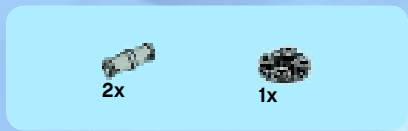
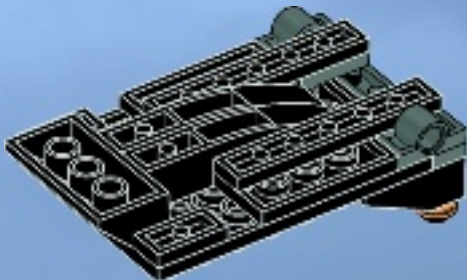

6

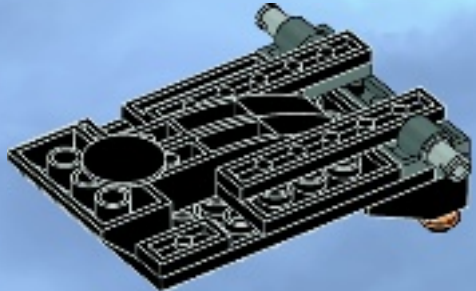

7

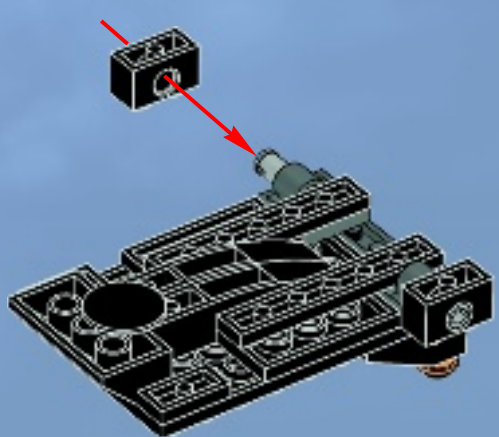



2x

8

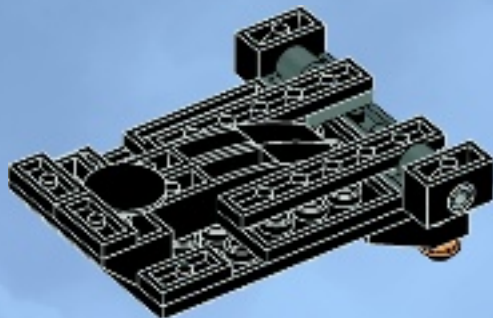

9

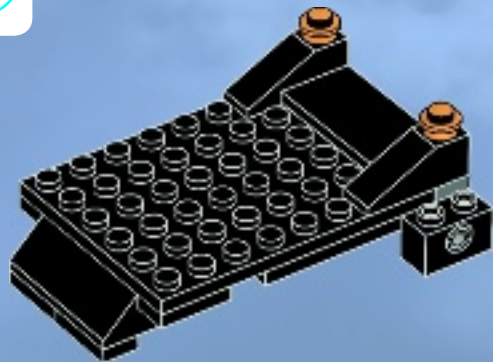

47

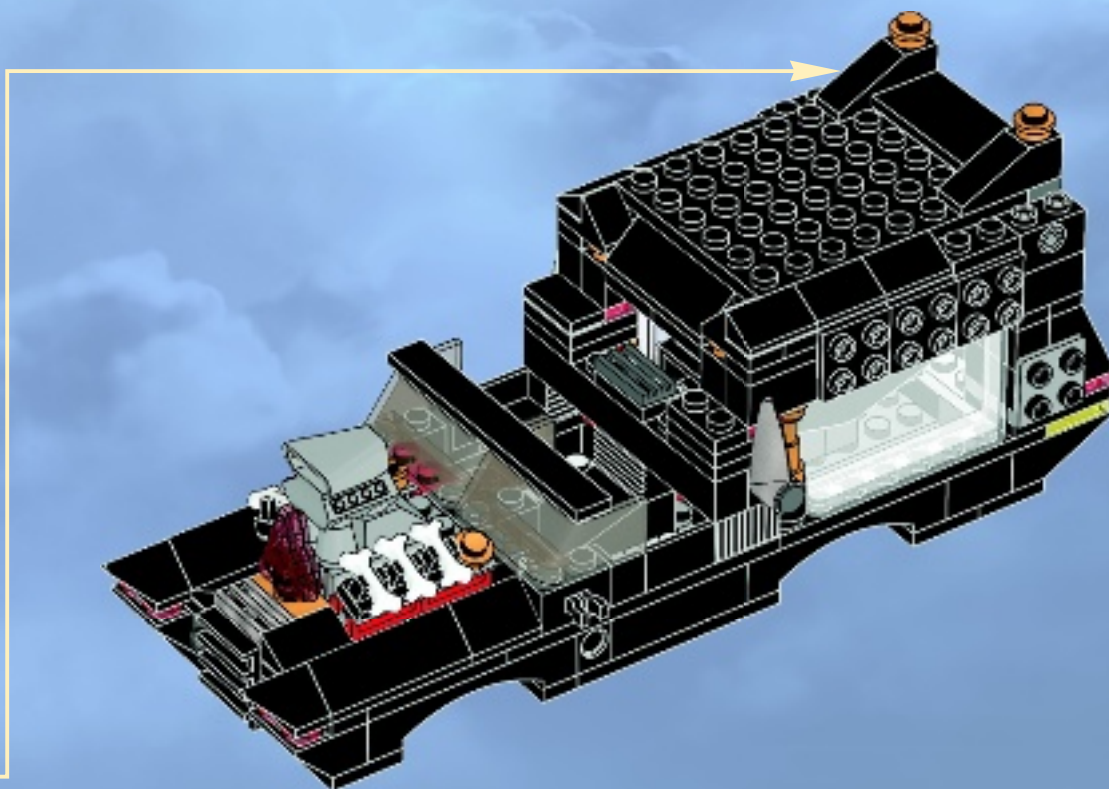

48

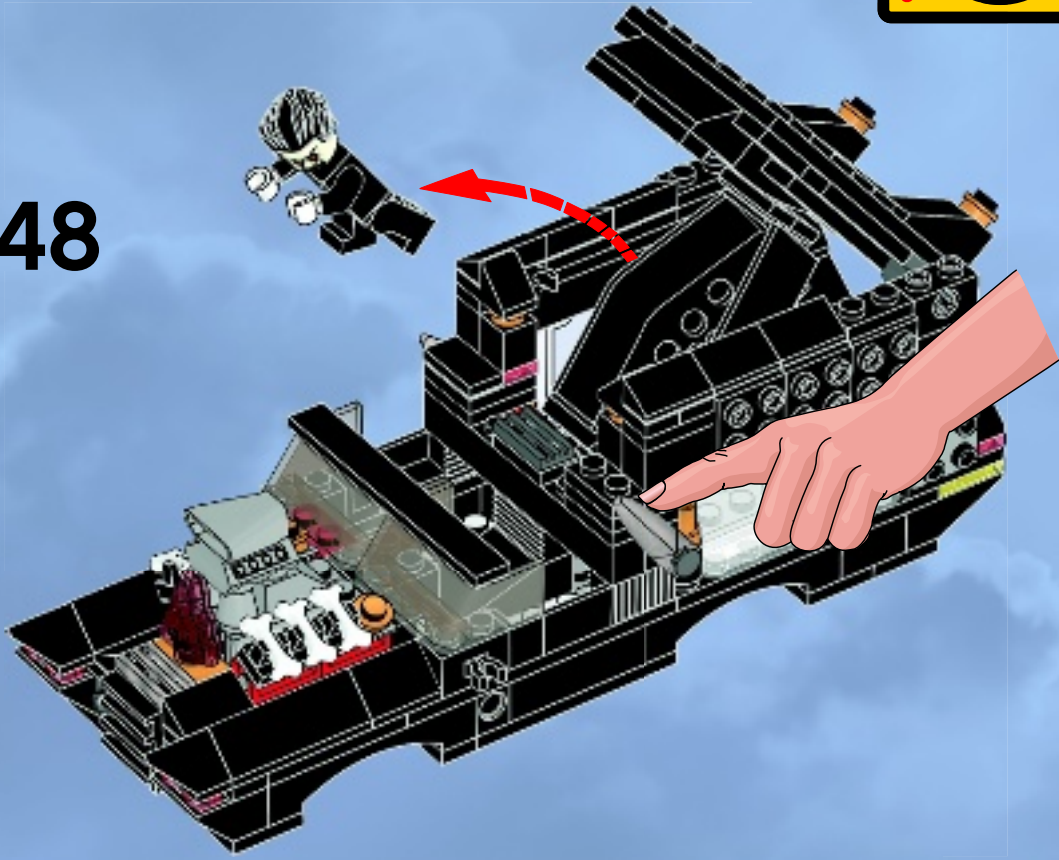



2x

# 49

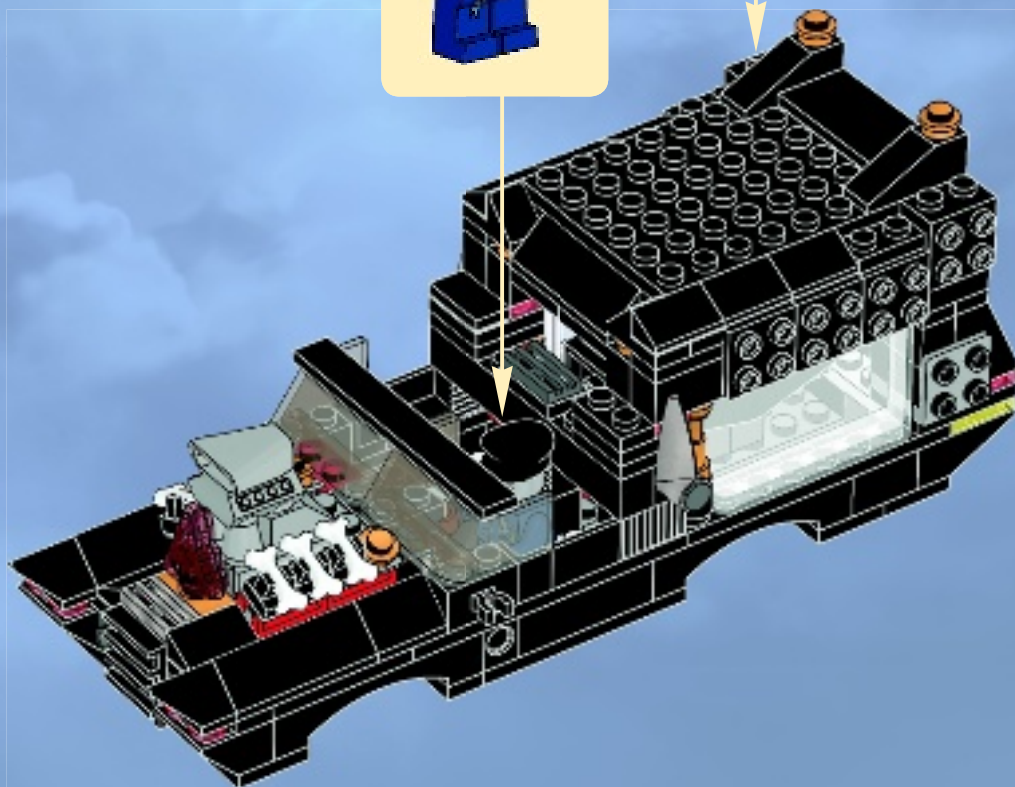



3x



6x

# 50

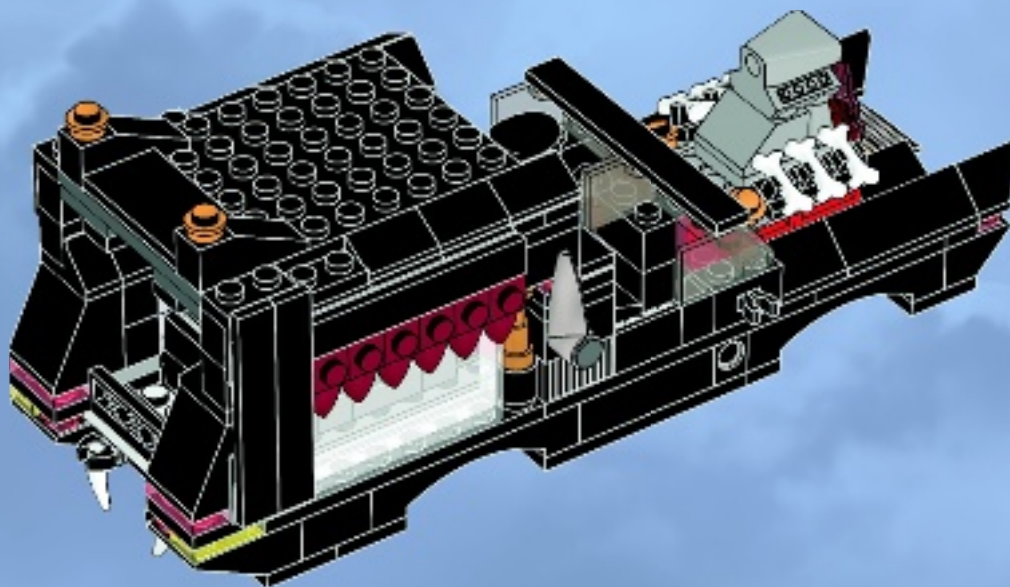





51

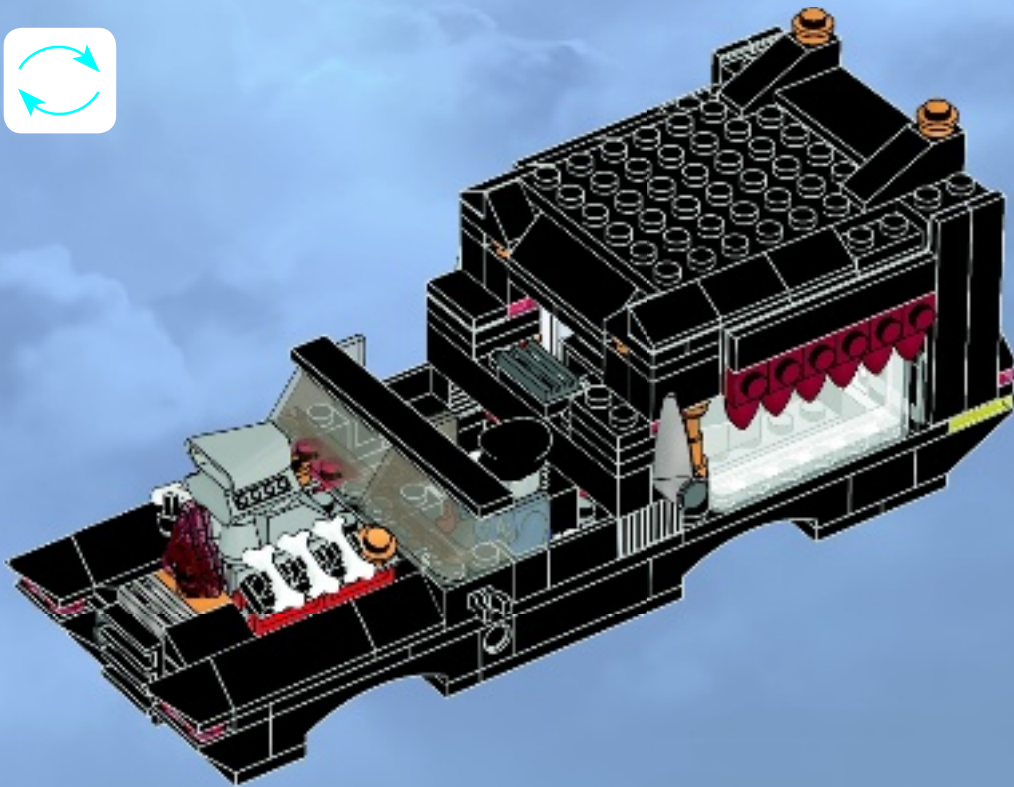



52

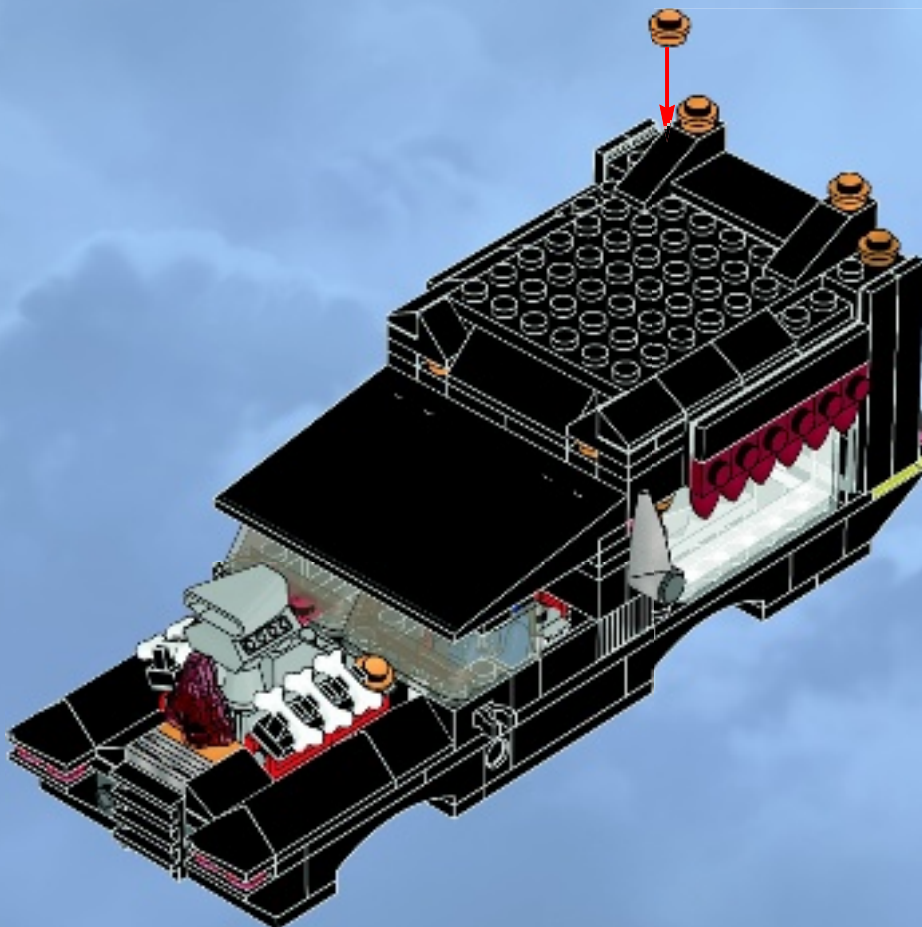



2x

53

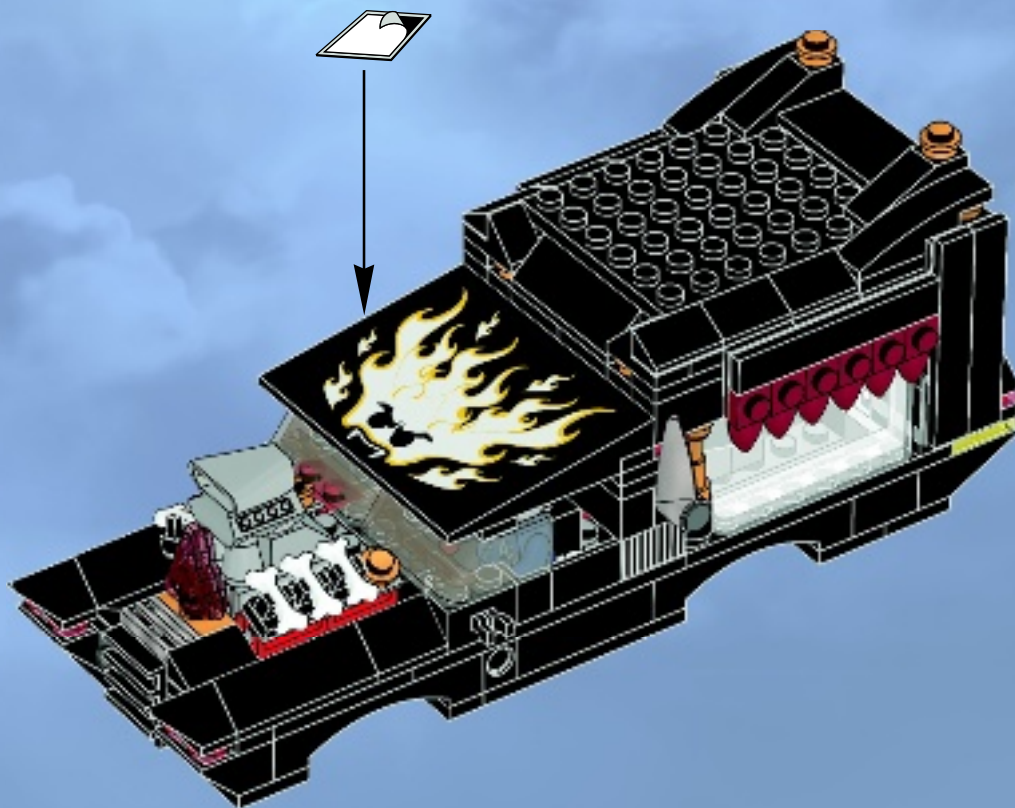



2x



1x



2x

# 54

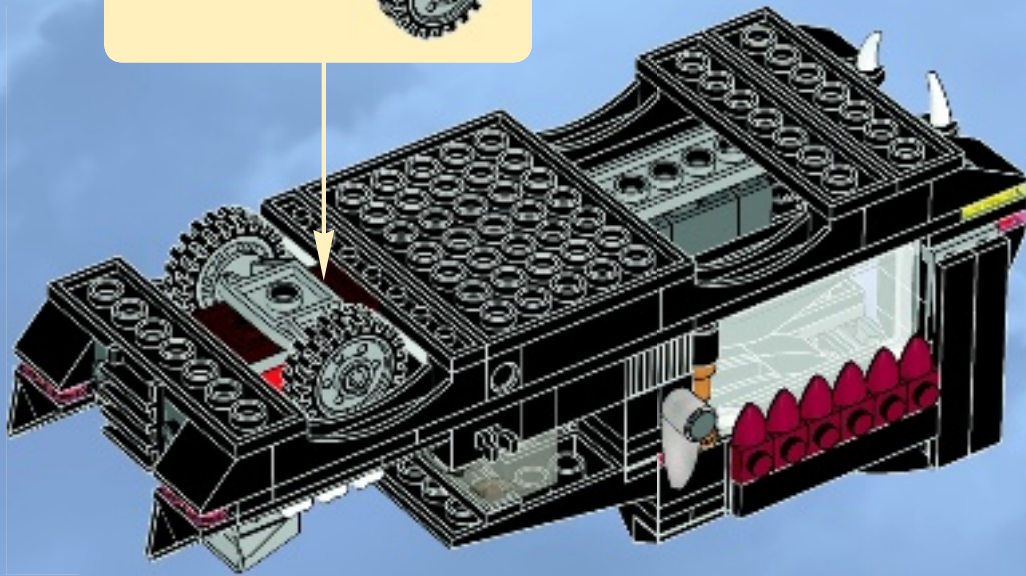
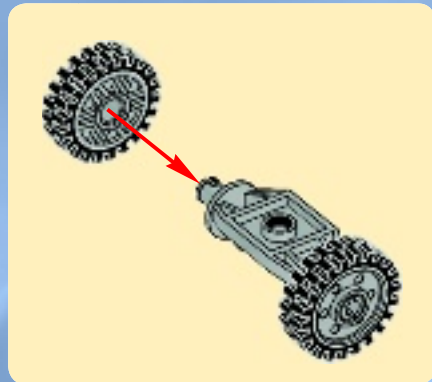



1x

1



1x

2



2x

3



1x

4

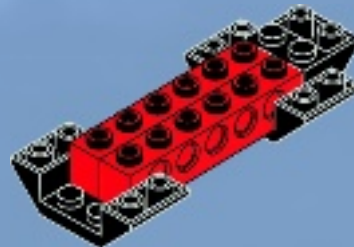



1x

5



6x

6

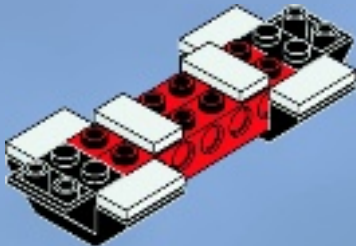

2x



2x



2x

7

1

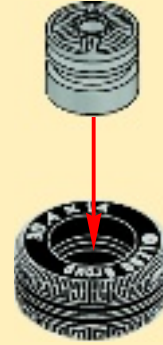

2

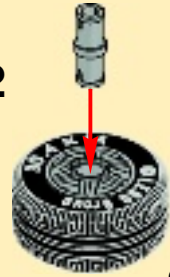

2x

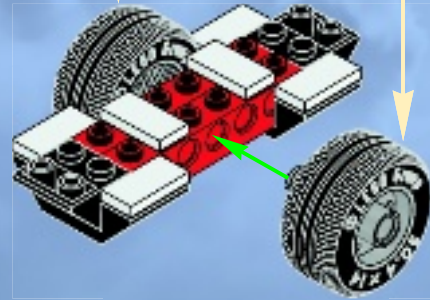

8



55

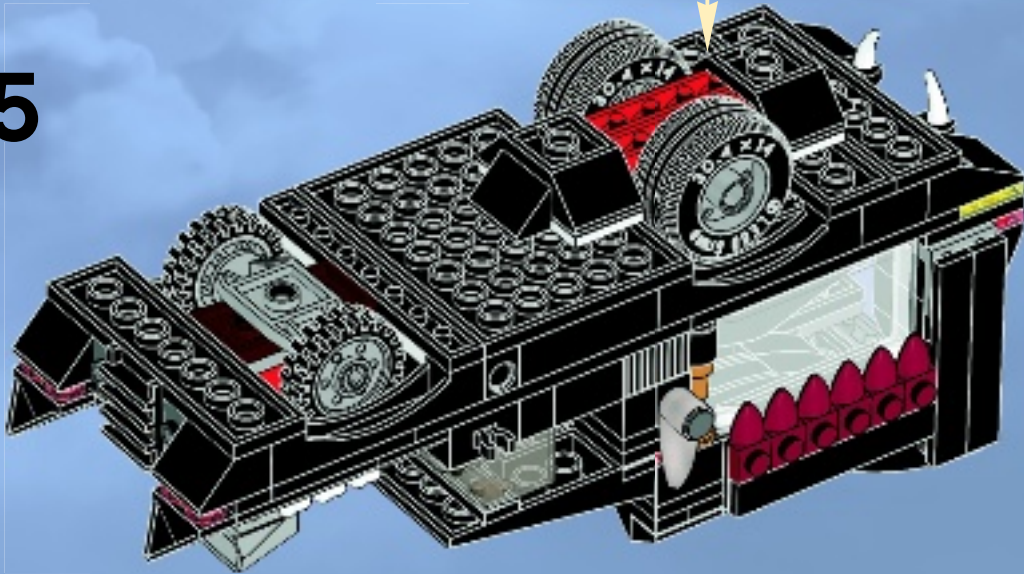



2x

# 56

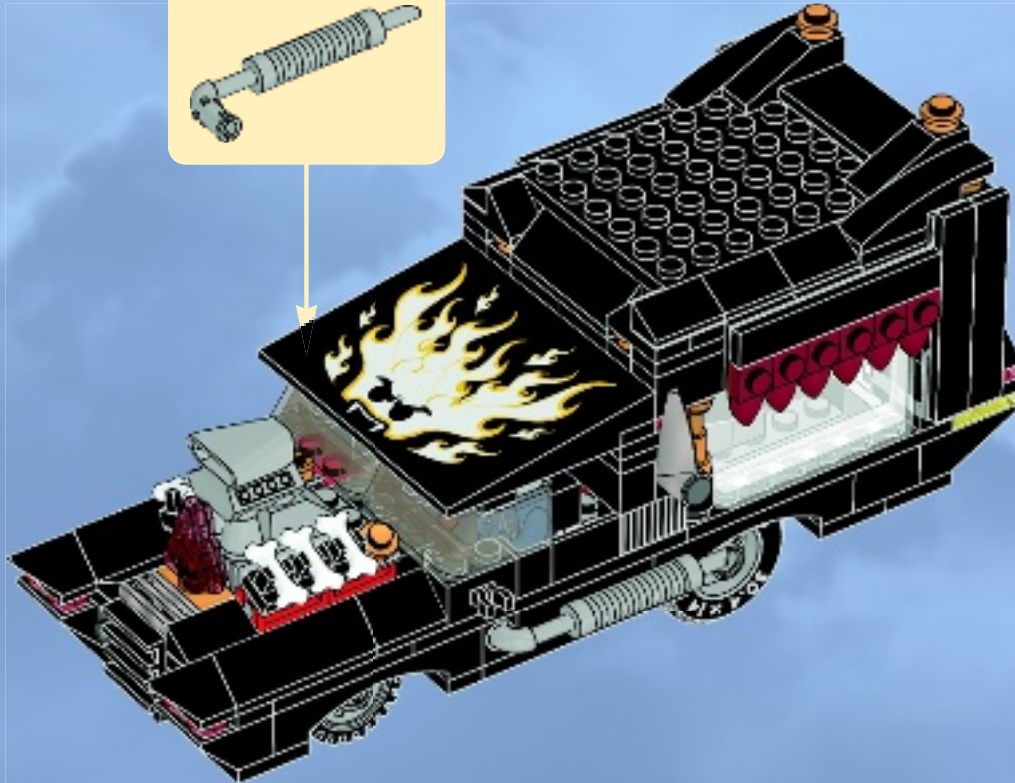
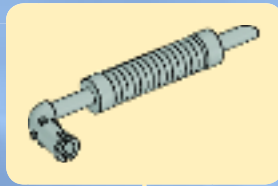





2x



2x



2x

# 57

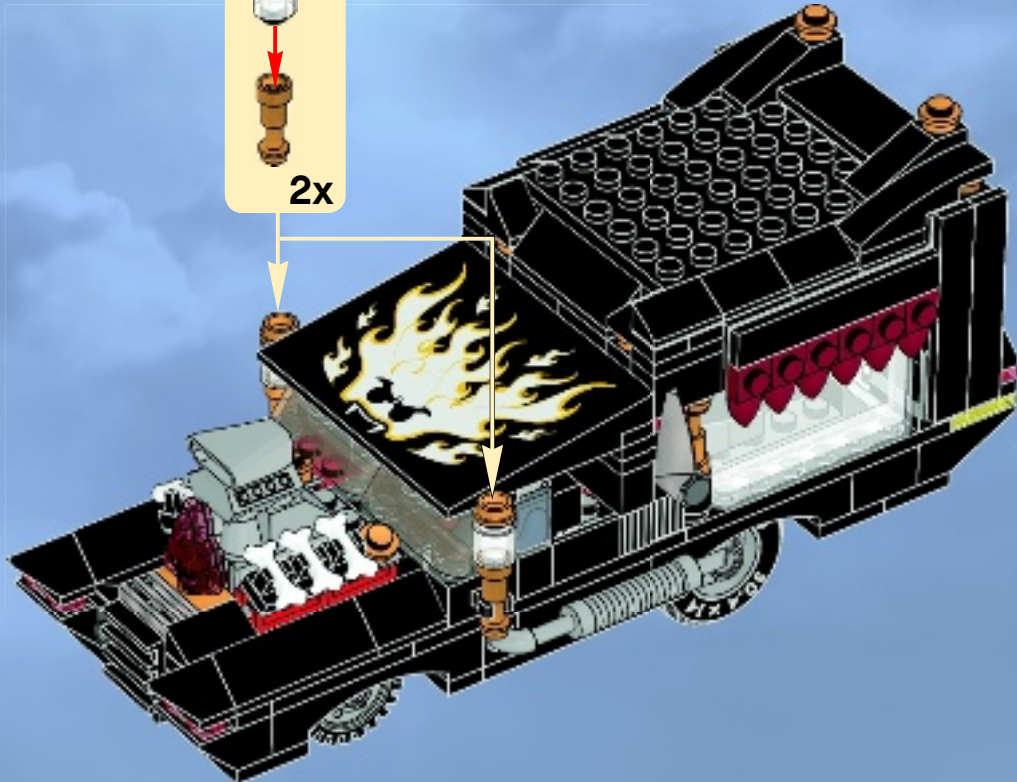
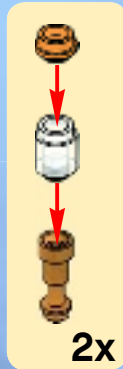



2x



2x

# 58

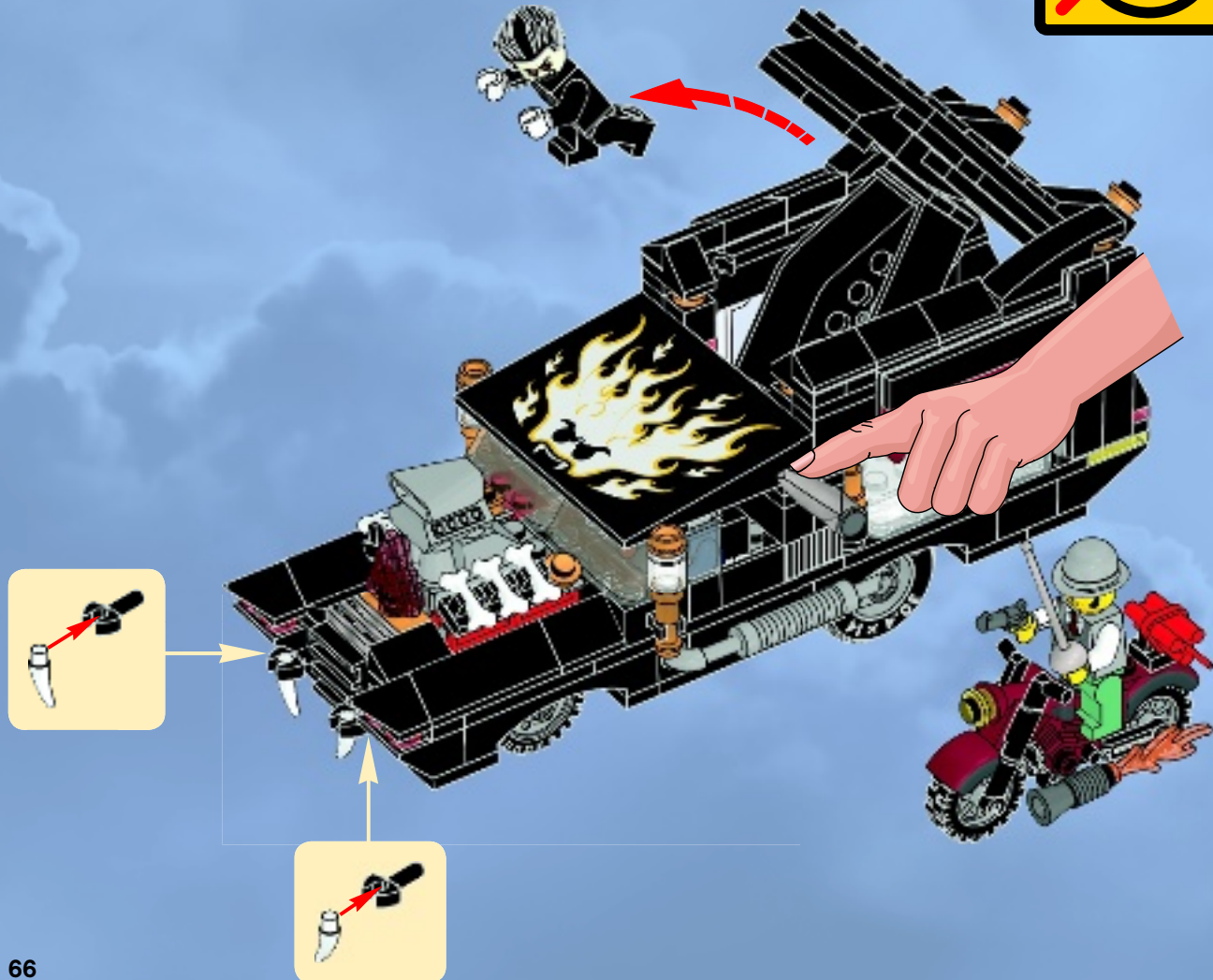









- 1x 4210631
- 4x 4558955
- 1x 4211024
- 1x 4211111
- 1x 4547958
- 2x 4560177
- 1x 4211056
- 2x 4196768
- 2x 4210698
- 1x 4211029
- 1x 6000177
- 1x 6006656
- 2x 4124083
- 1x 6006290
- 1x 6006293
- 1x 4613117
- 12x 4275573
- 2x 3006840
- 2x 4546690
- 2x 612647
- 2x 4227155
- 1x 6006302
- 1x 6006272
- 2x 4211383
- 2x 4529241
- 4x 4211807
- 2x 4654580
- 5x 4211398
- 1x 4211410
- 1x 4653057
- 4x 4211470
- 2x 4211573
- 2x 4590443
- 3x 4211387
- 2x 4499259
- 2x 4299119
- 1x 4259422
- 1x 4529120
- 2x 4263192
- 2x 4211462
- 3x 379501
- 6x 306901
- 6x 4600294
- 4x 4568387
- 1x 9551
- 1x 306541
- 4x 4201019
- 6x 3005741
- 1x 6006294
- 1x 6009159
- 1x 6009885
- 4x 4538126
- 1x 4523157
- 12x 4523159
- 2x 4194746
- 1x 3005744
- 1x 4249040
- 1x 4618270
- 2x 4612765
- 2x 300526
- 8x 300426
- 8x 4548180
- 2x 4220539
- 2x 4163373
- 4x 366026
- 7x 302326
- 4x 302226
- 2x 302126
- 2x 371026
- 9x 4277932
- 1x 4603502
- 2x 300326
- 3x 287726
- 1x 4560182
- 2x 4522034
- 2x 304126
- 1x 303726
- 1x 4185583
- 2x 4160409
- 3x 301026
- 2x 302026
- 2x 374726
- 2x 428626
- 1x 6006265
- 1x 4654943
- 1x 6006266
- 2x 370026
- 1x 370626
- 2x 366626
- 6x 366326
- 1x 416226
- 8x 346026
- 3x 303426
- 2x 303626
- 2x 303626
- 1x 300826
- 2x 611126
- 1x 4161067
- 2x 486526
- 1x 362426
- 2x 4118624
- 2x 306226
- 4x 654126
- 6x 4653087
- 1x 4278359
- 2x 4106347
- 7x 255526
- 2x 4550017
- 4x 306926
- 4x 4289538
- 2x 4541455
- 2x 4244953
- 2x 4550937
- 2x 4273703
- 4x 4620763
- 1x 6008340
- 1x 6005578
- 1x 4530673
- 1x 4187209
- 2x 4188534
- 1x 4211186
- 2x 389421
- 1x 4658975
- 1x 4538780
- 4x 393721
- 2x 4128598



**Customer Service**  
**Kundenservice**  
**Service Consommateurs**  
**Servicio Al Consumidor**  
**LEGO.com/service or dial**

00800 5346 5555 :     

1-800-422-5346 :  



[www.LEGOclub.com/Max](http://www.LEGOclub.com/Max)



**club**™

**FREE\*! GRATIS! GRATUIT!**



\*Paid subscription in Australia and New Zealand.  
\*Abonnement payant en Australie et Nouvelle-Zélande.



# MONSTER FIGHTERS



9461



9462



9463



9464



9466



9467



9468



# MONSTER FIGHTERS



Use this code in the online game to unlock scary content. If you dare ...  
Schalte mit diesem Code den geheimen Inhalt frei. Traust du dich?  
Utilise ce code dans le jeu en ligne pour débloquer des contenus effrayants. Si tu oses ...  
Usa este código en el juego en línea para desbloquear una terrorífica sorpresa. Si te atreves ...  
Usa este código no jogo online para abrires um conteúdo assustador. Se tiveres coragem ...  
Ezzel a kóddal nyisd meg az online játékban az ijesztés témát. Ha mered ...



monsterfighters.LEGO.com



# WIN!

Go to [www.LEGOsurvey.com/product](http://www.LEGOsurvey.com/product) to fill out a survey for a chance to win a cool LEGO® Product.

No purchase necessary.

Open to all residents where not prohibited.



LEGO.com



## [www.LEGOsurvey.com/product](http://www.LEGOsurvey.com/product)

### GEWINNE! WIN!

Nimm an der Umfrage auf [www.LEGOsurvey.com/product](http://www.LEGOsurvey.com/product) teil und hab die Chance ein cooles LEGO® Produkt zu gewinnen!

Die Teilnahme am Gewinnspiel führt zu keinerlei Kaufverpflichtungen. Teilnahme in allen nicht ausgeschlossenen Ländern möglich.

Ga naar [www.LEGOsurvey.com/product](http://www.LEGOsurvey.com/product), vul een enquêteformulier in en maak kans op een cool LEGO® product.

Geen aankoopverplichting, iedereen mag deelnemen, uitgezonderd ingezetenden van landen waar een enquêteverbod geldt.

### GAGNE! 当てよう!

Visite [www.LEGOsurvey.com/product](http://www.LEGOsurvey.com/product) pour répondre à un questionnaire et avoir une chance de gagner un produit LEGO® très cool!

Aucune obligation d'achat. Ouvert à tous les résidents des pays autorisés.

[www.LEGOsurvey.com/product](http://www.LEGOsurvey.com/product) にアクセスしアンケートにご記入ください。当選者には1製品を差し上げます。

お買い上げの必要はありません。

禁止されていない限り、すべての皆様にご利用いただけます。