



NINJAGO

Mas



9446



CONVERTS

1

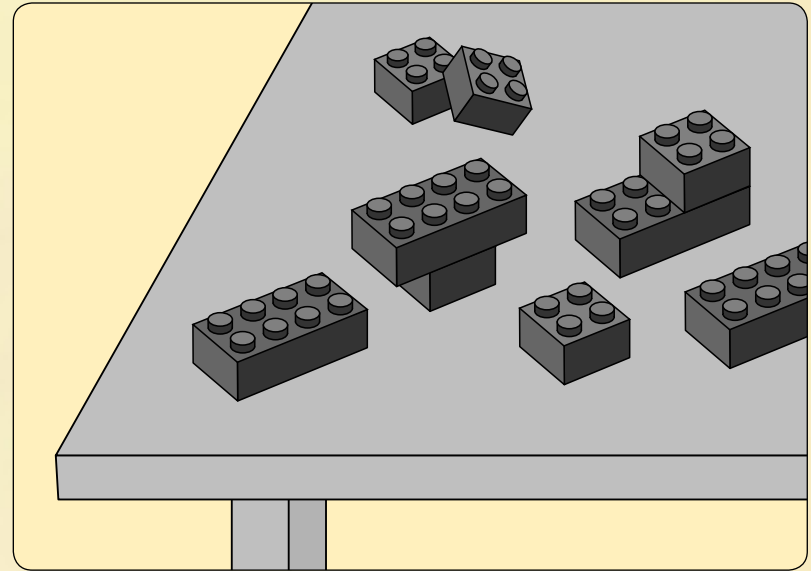
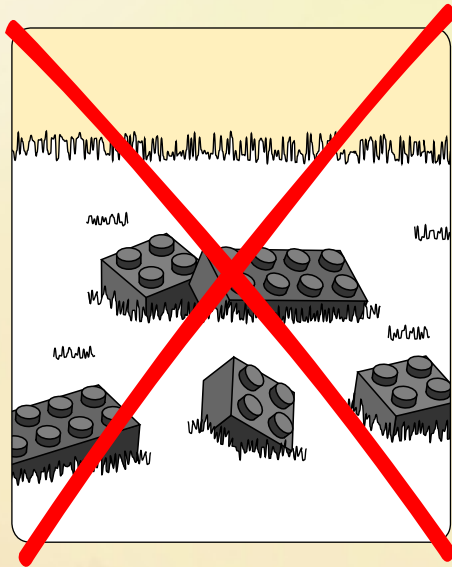

2

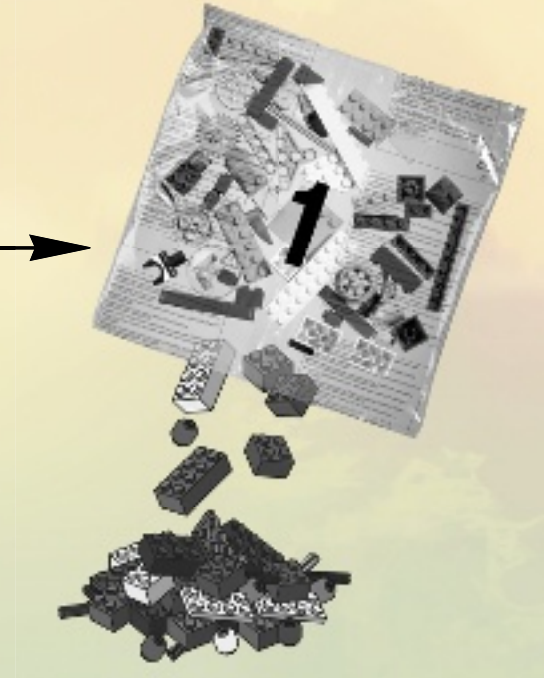

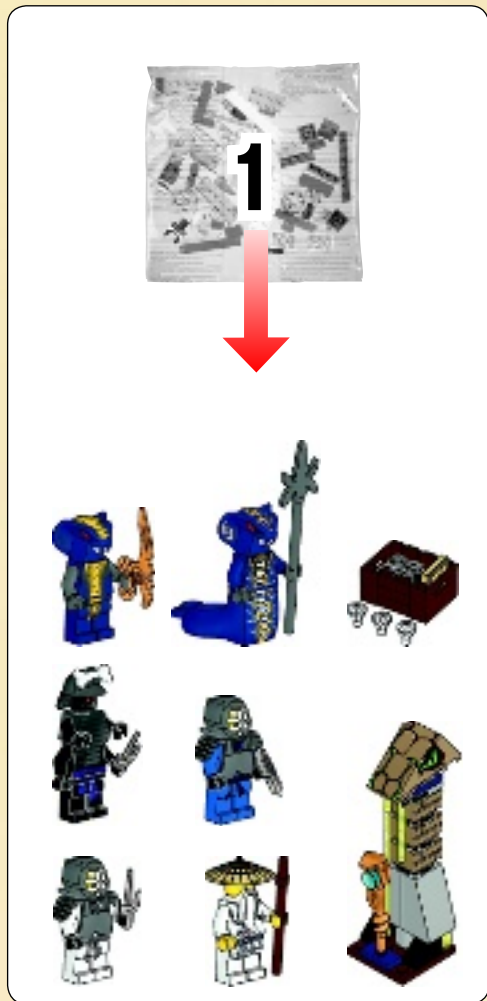

**CONVERTS
SE TRANSFORME
SE CONVIERTE**

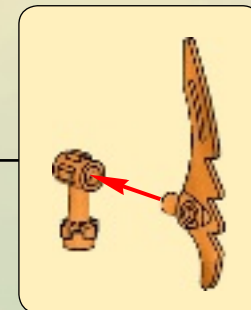
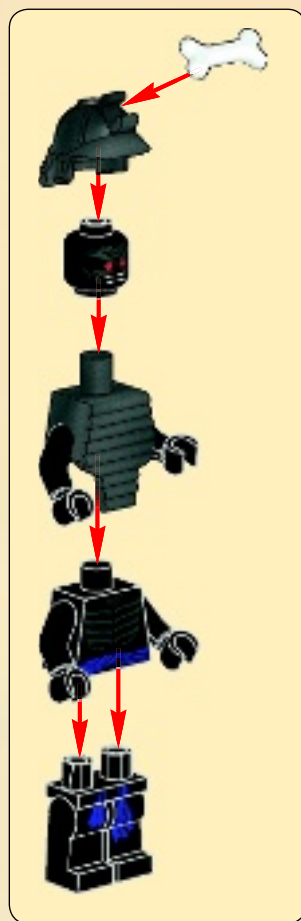

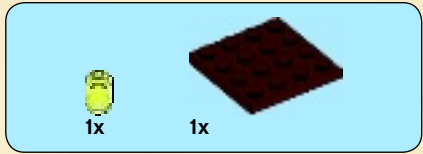

1



2



3

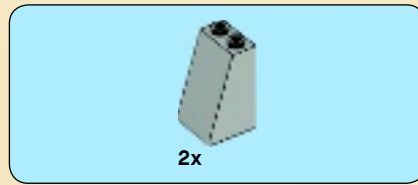

4

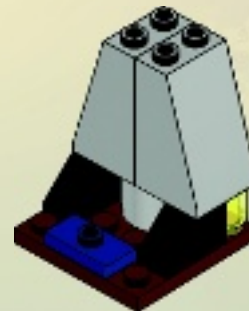

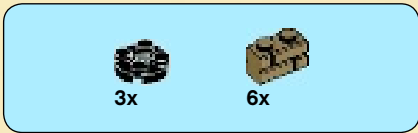

5

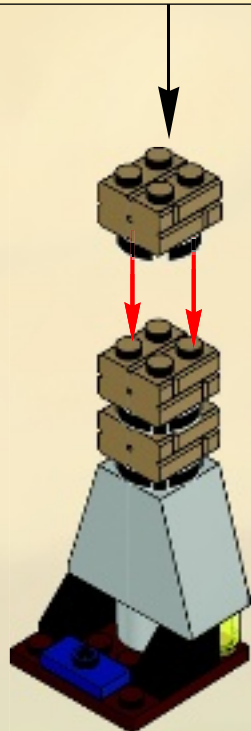
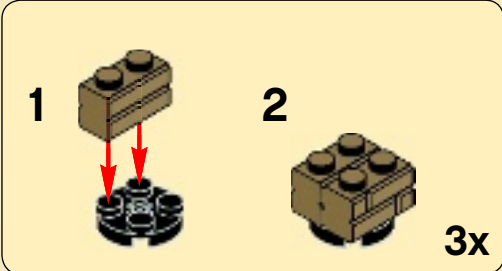

6

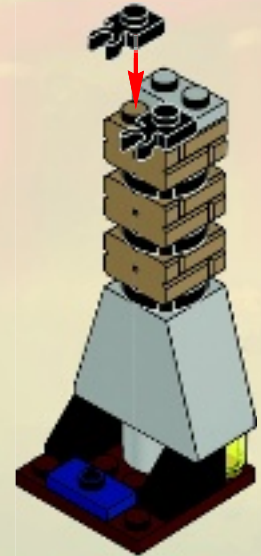



2x

7

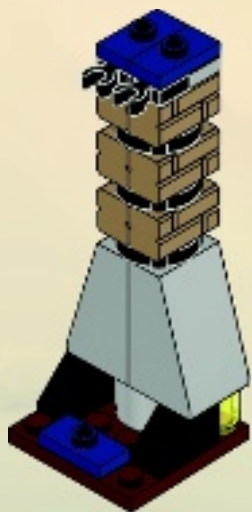

1x



1x

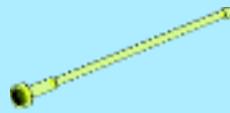

1x

8

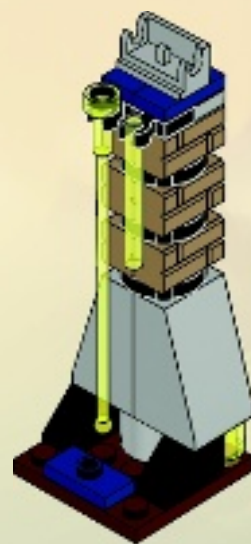

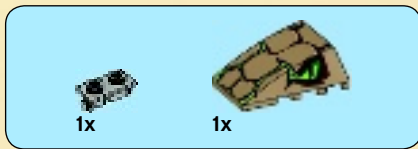

9

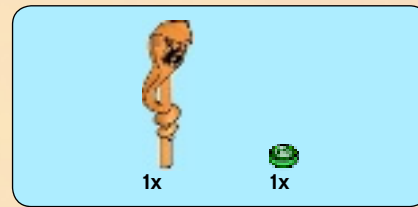

10

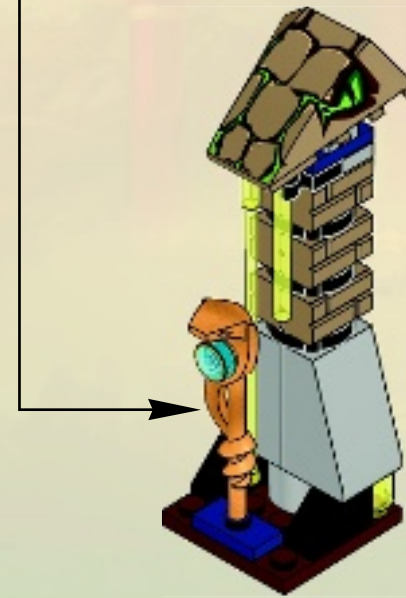
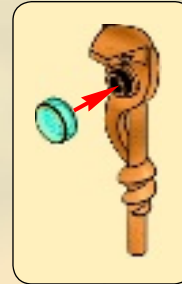

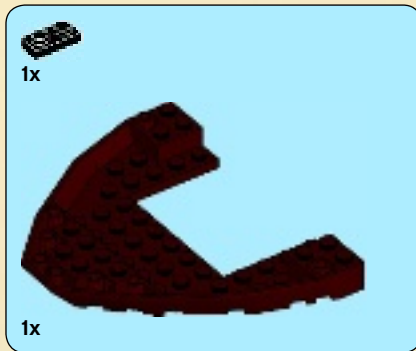
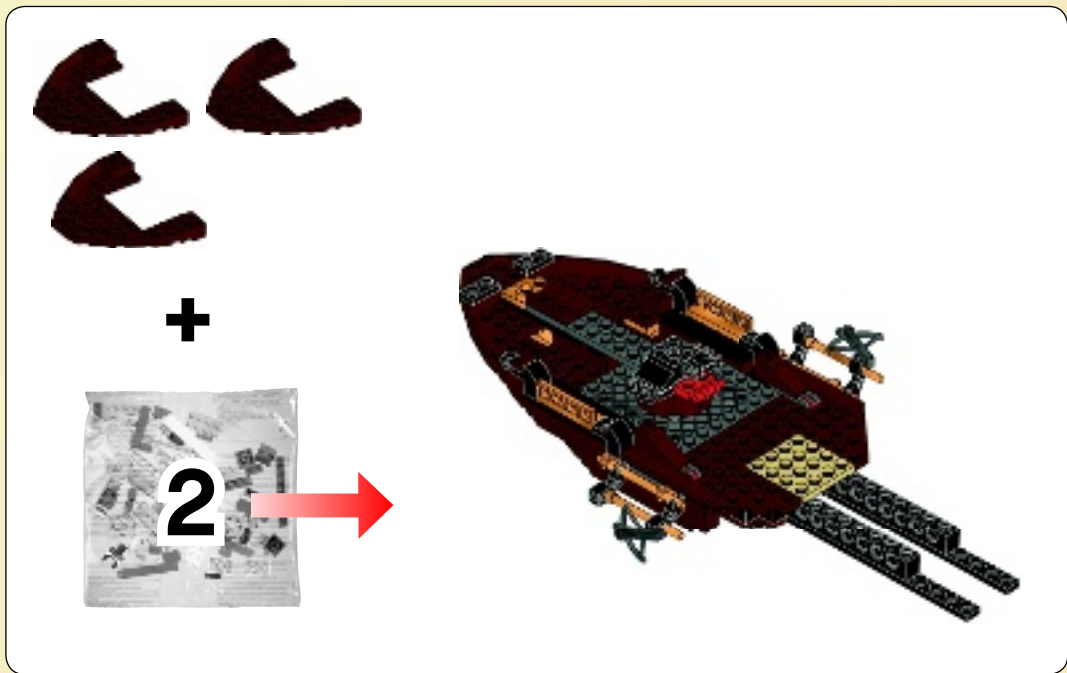
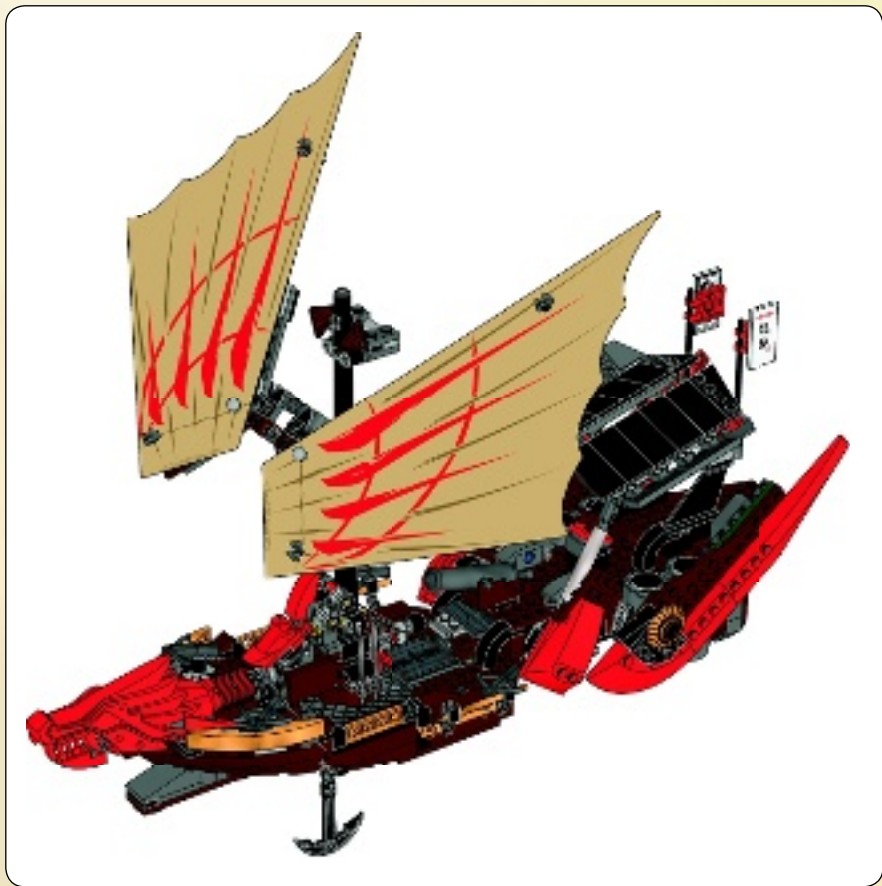

1

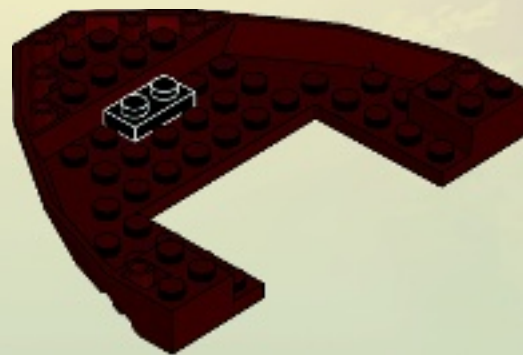

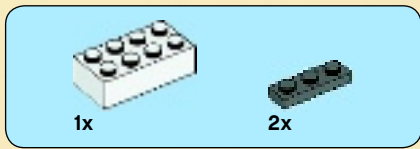

2

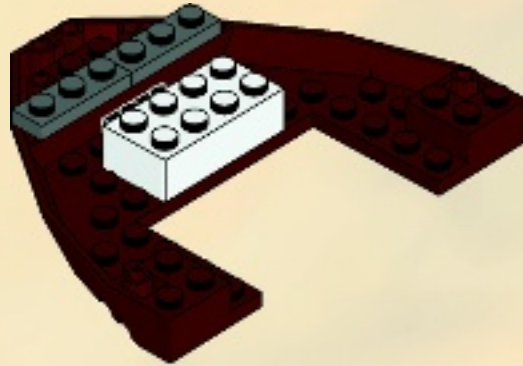

3

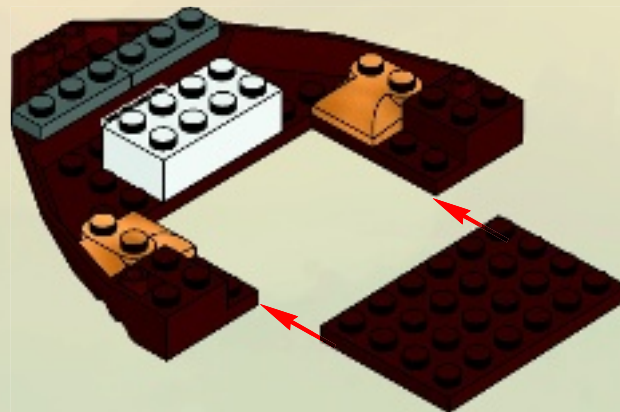

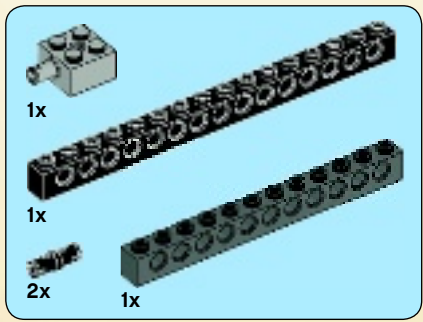

4

1



2



3

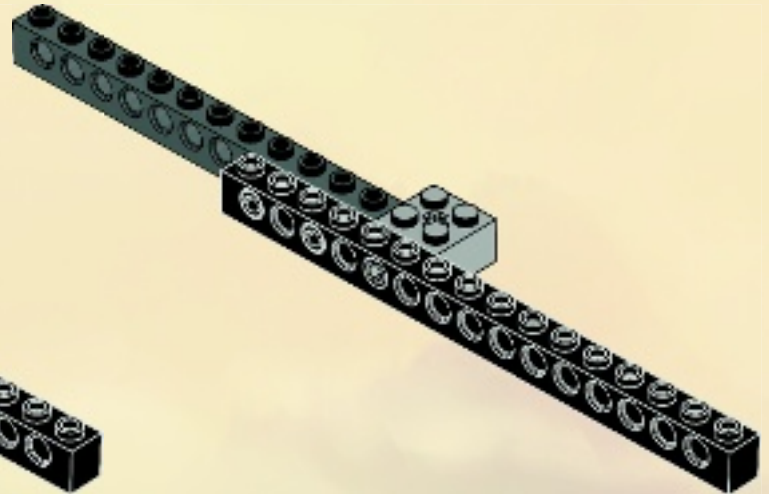

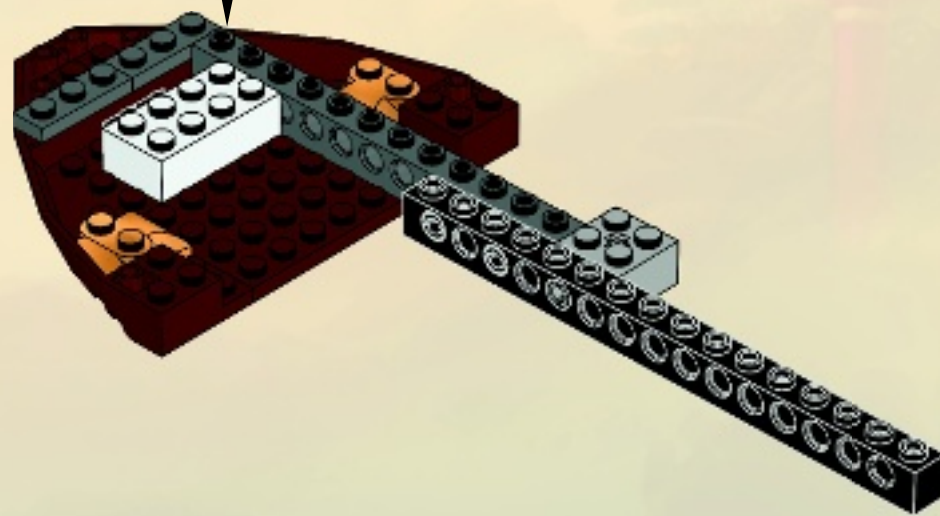

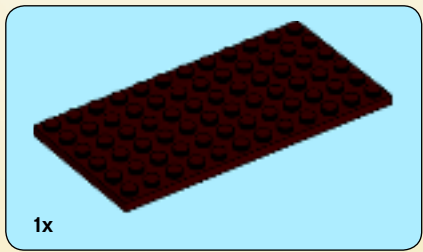

5

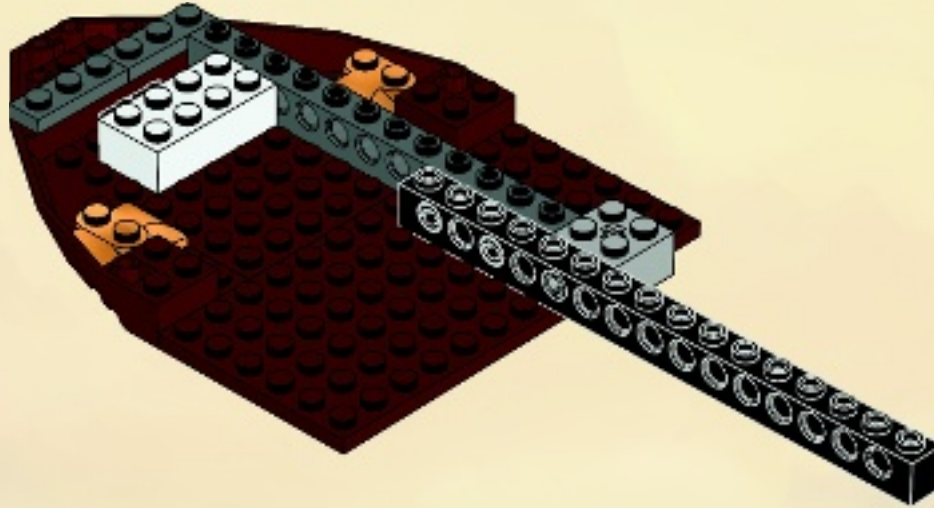

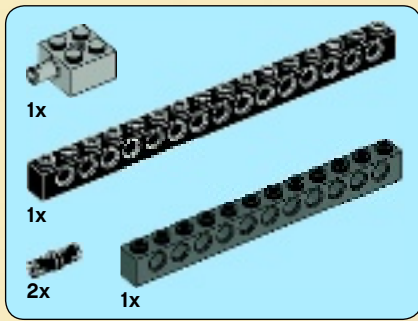

6

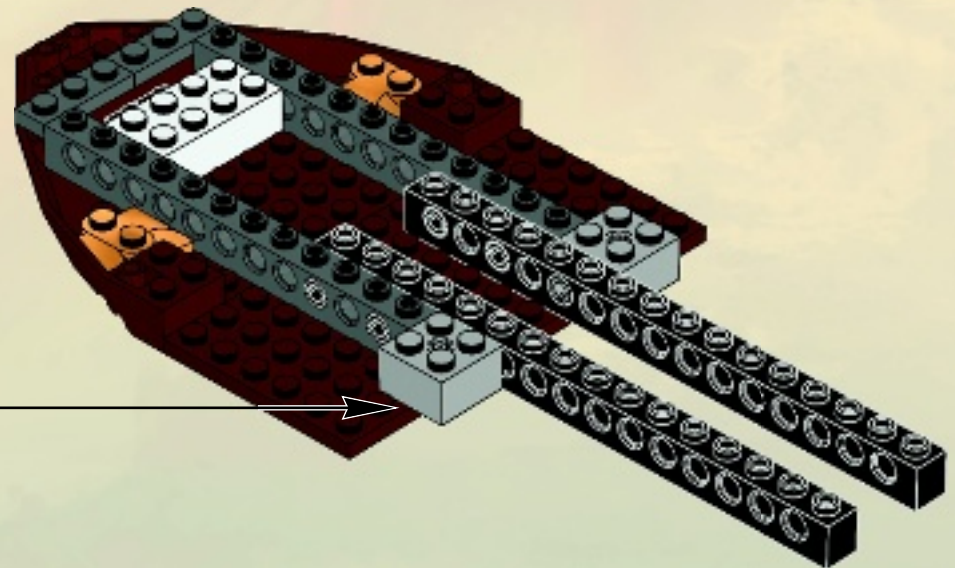
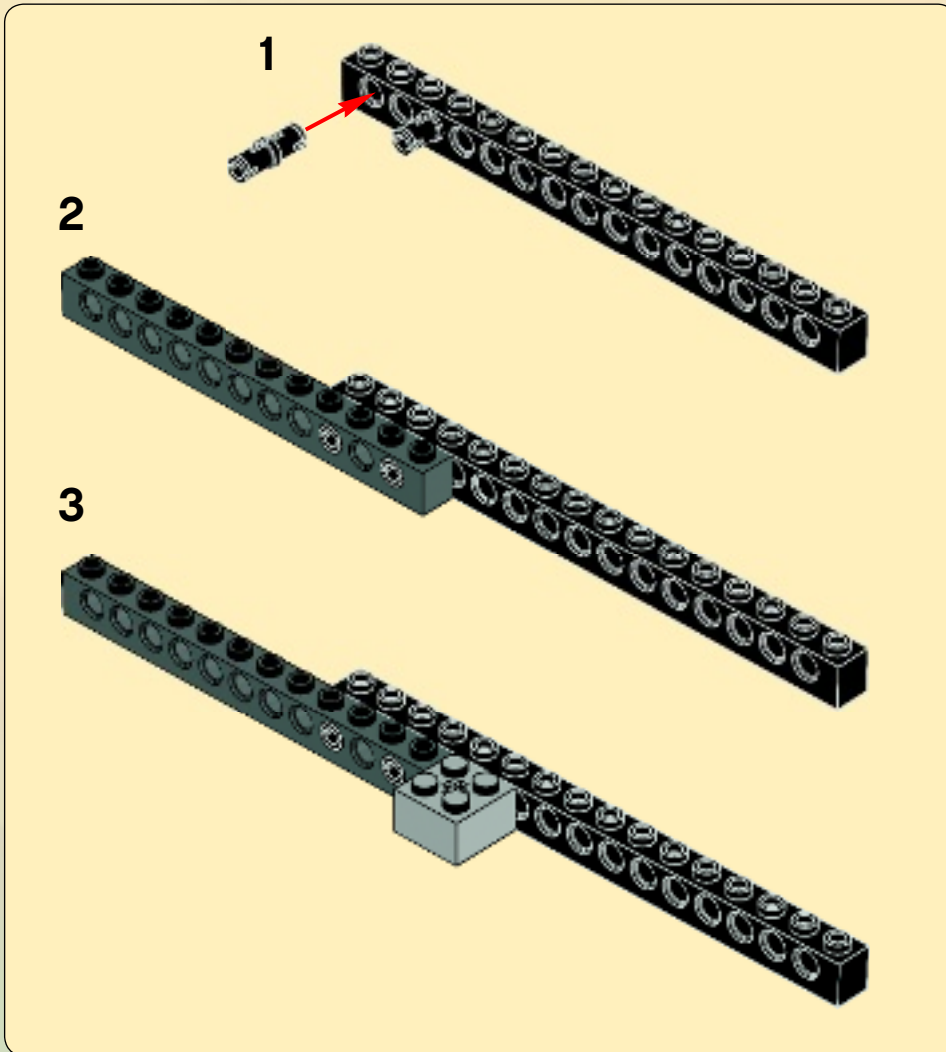



7

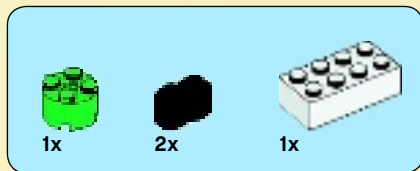
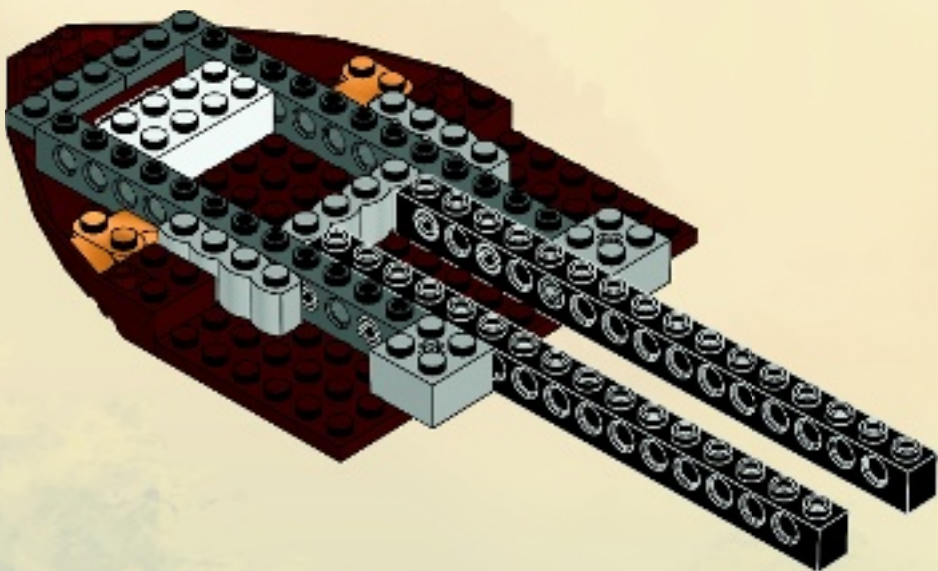

8

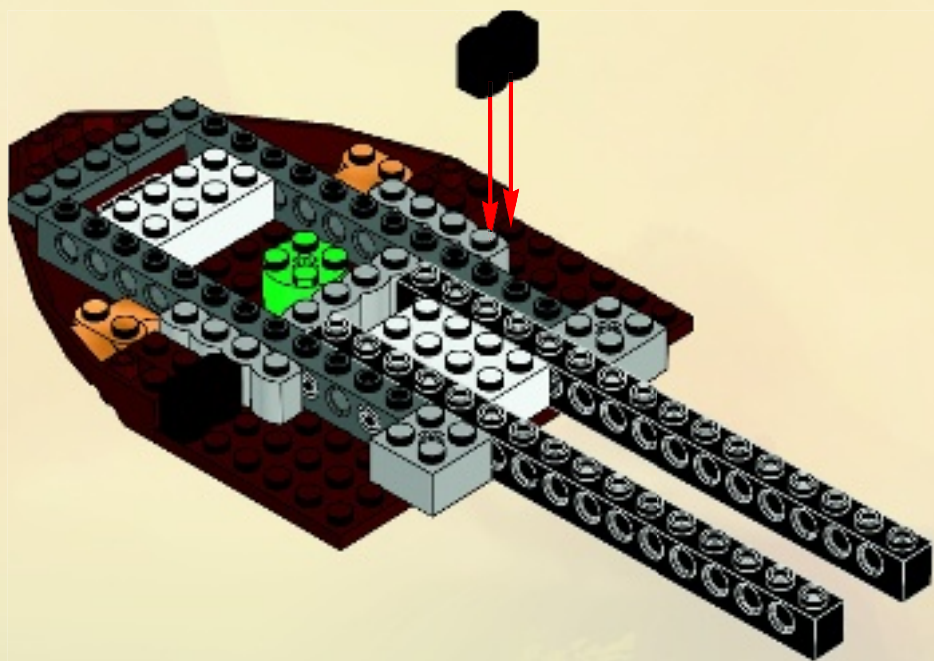

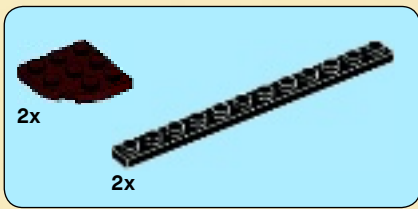

9

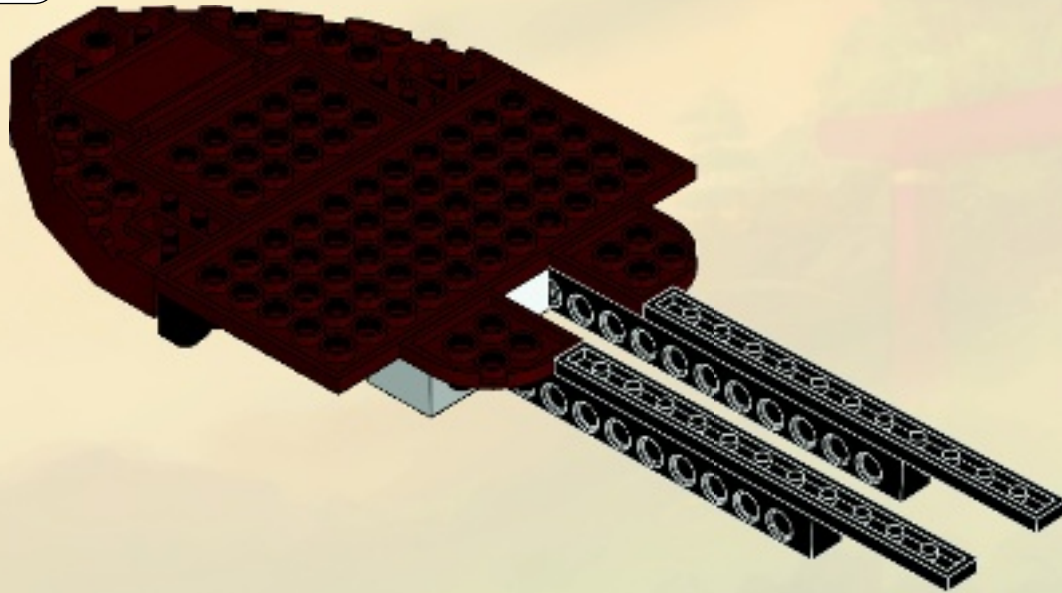
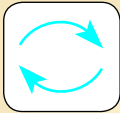

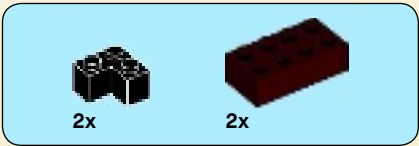

10

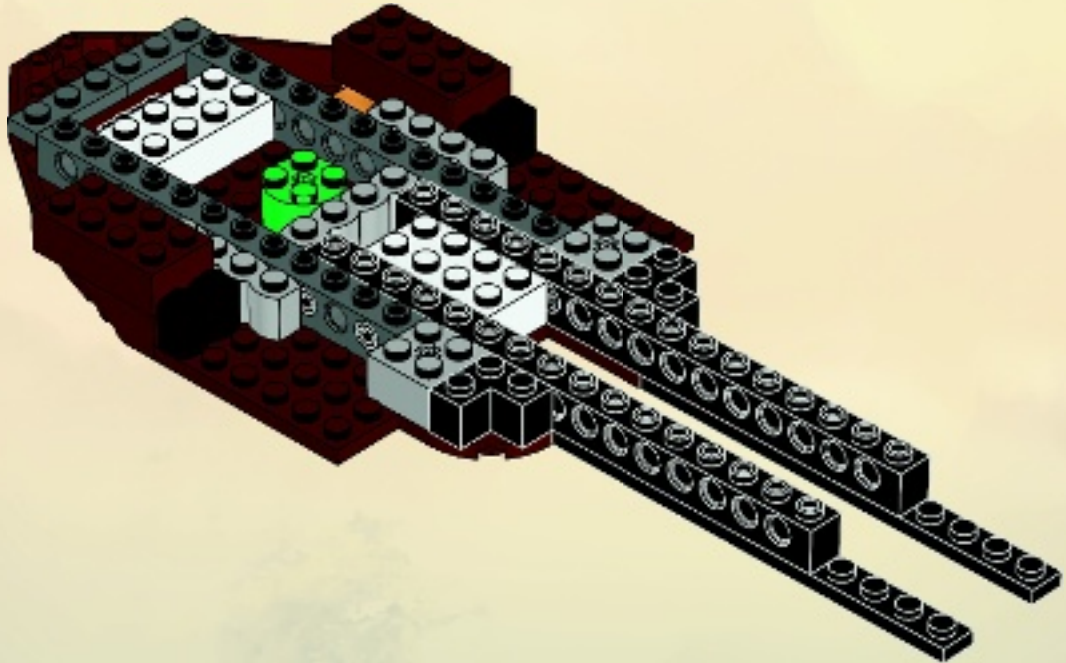



11

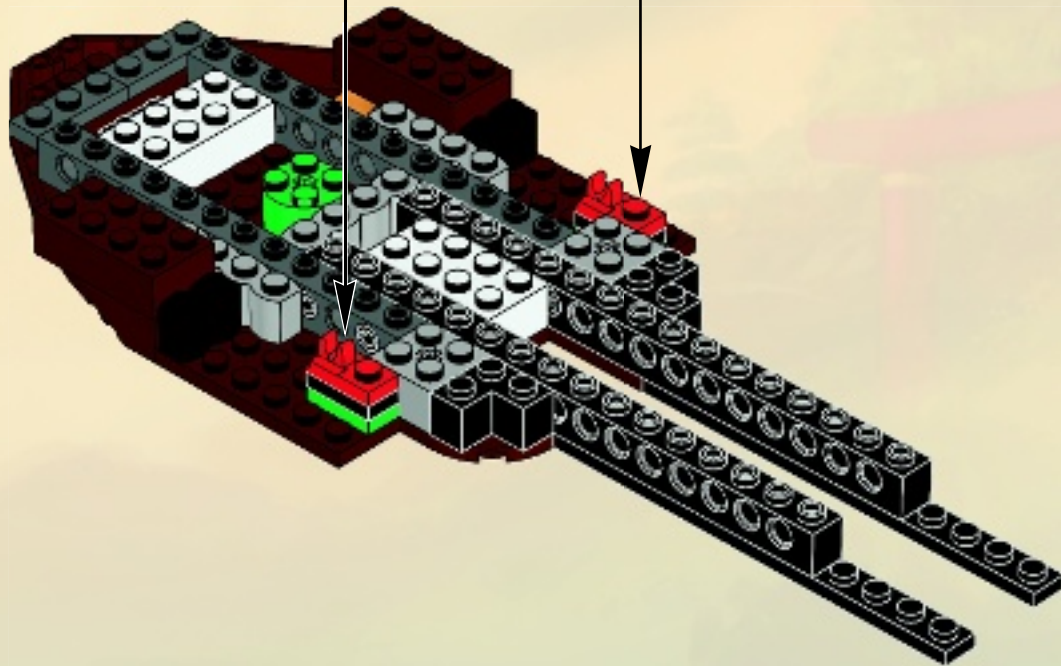
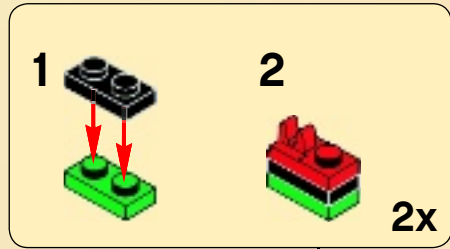

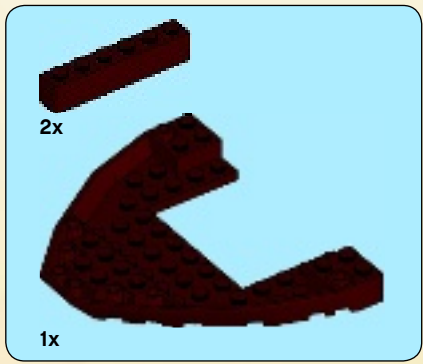

12

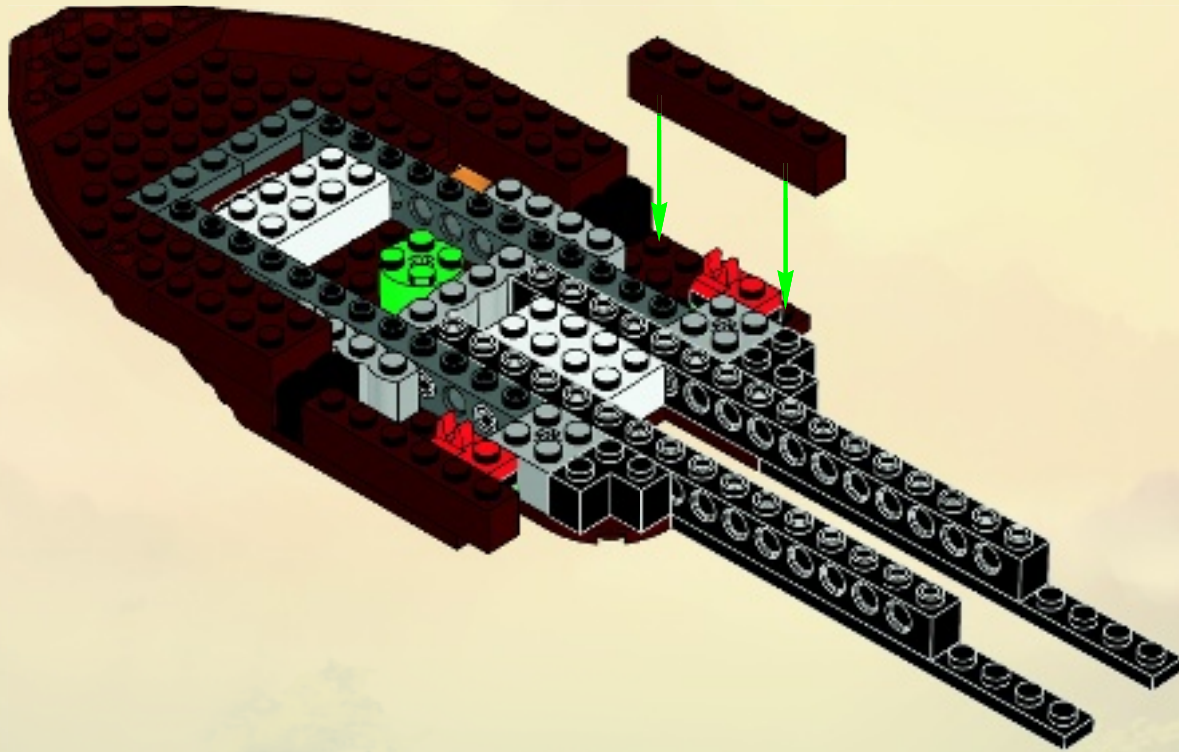

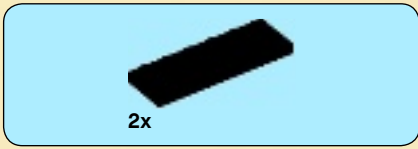

13





3x

14

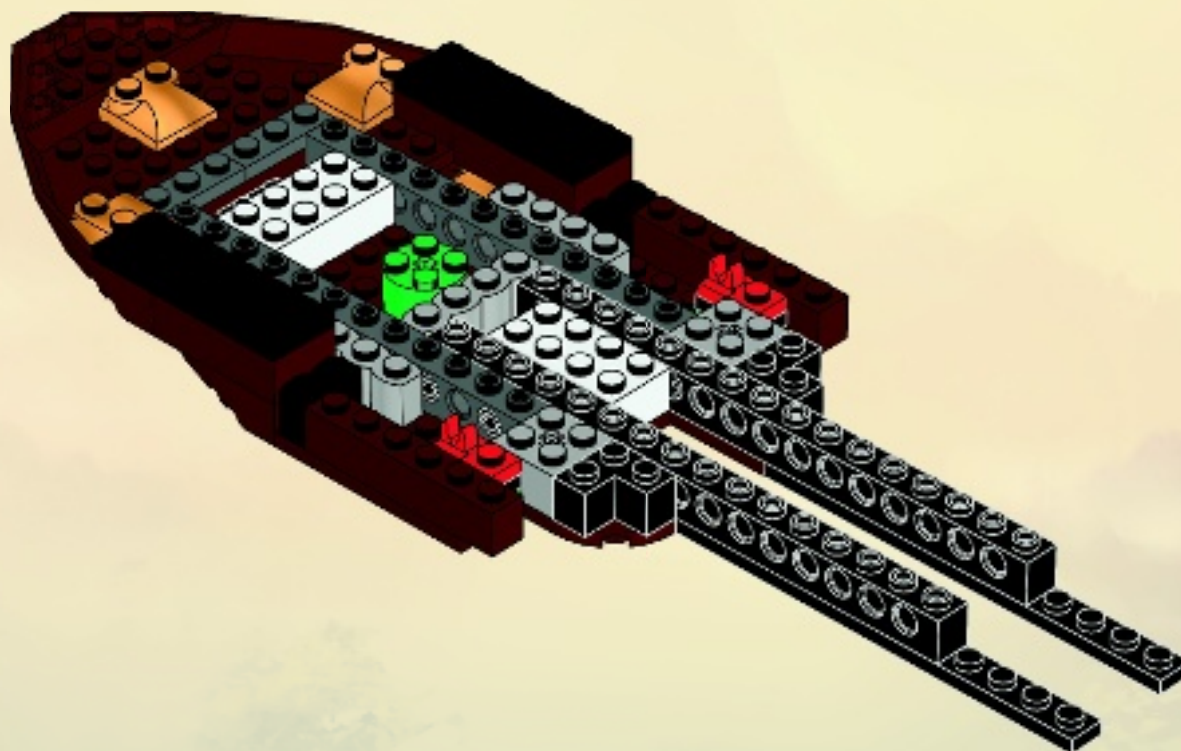

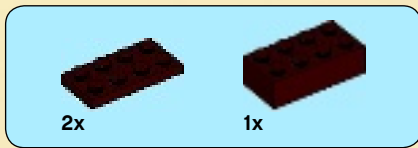

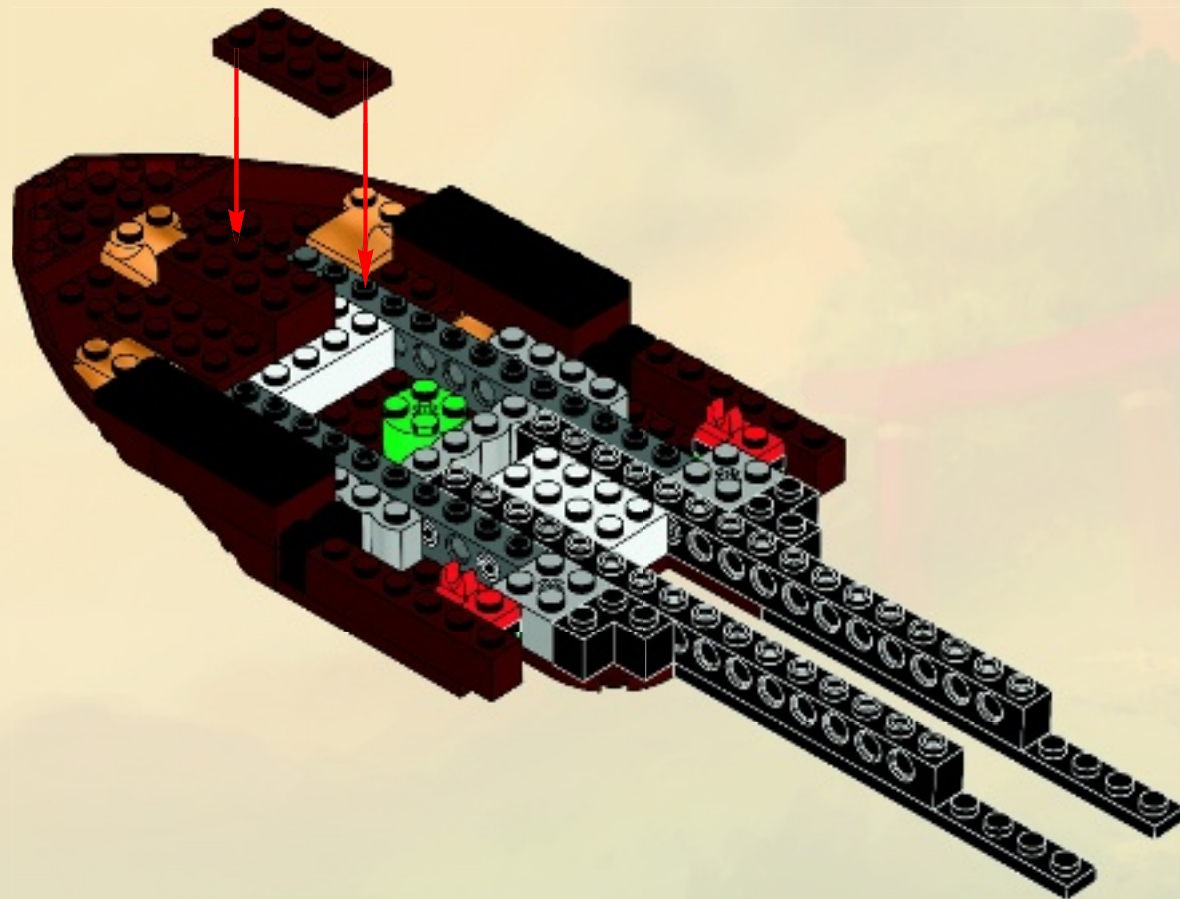

15

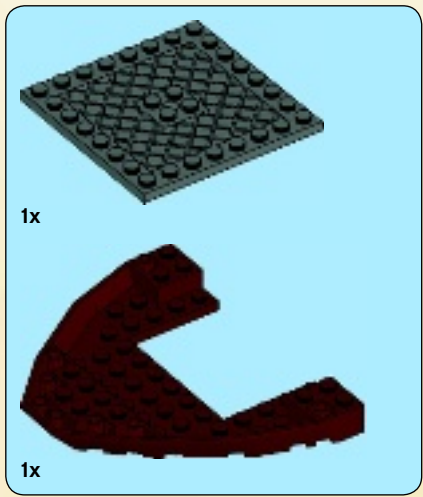

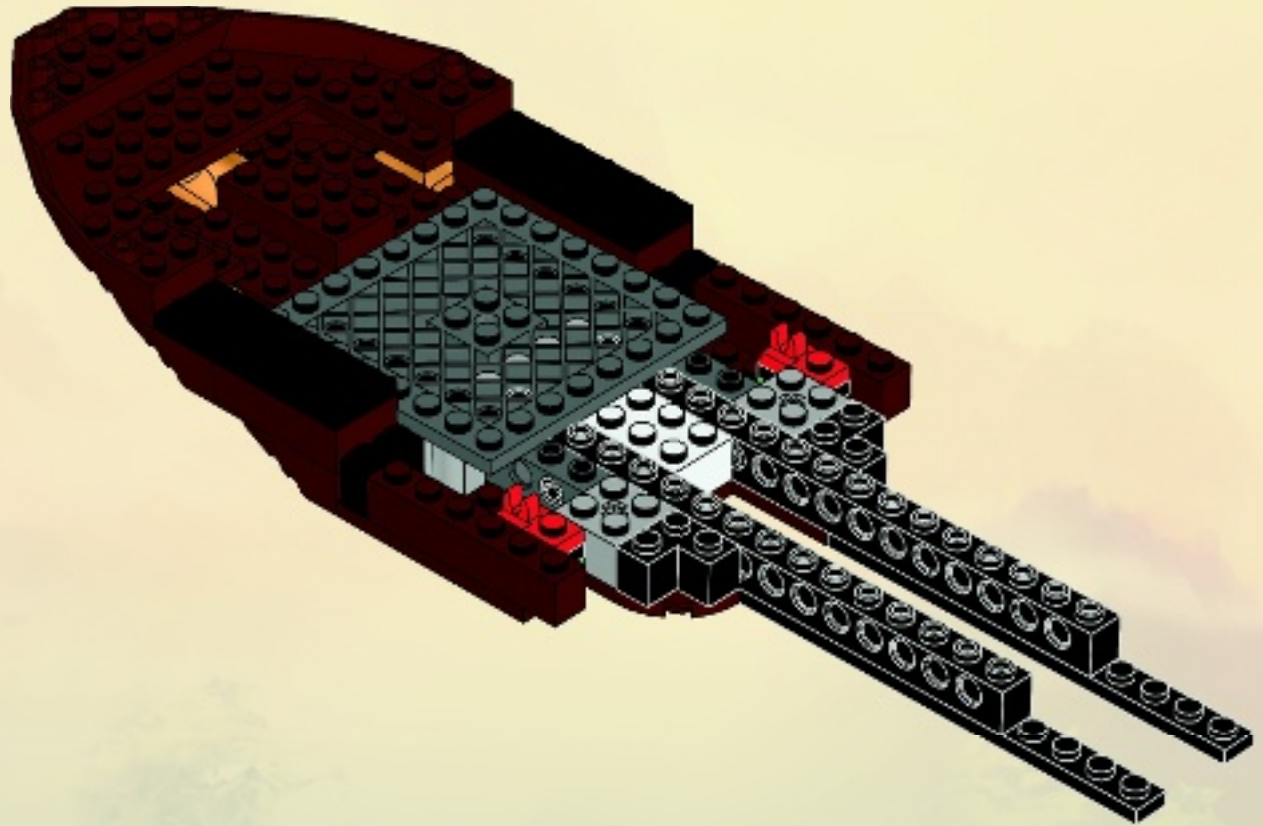

16



2x  4x 

17

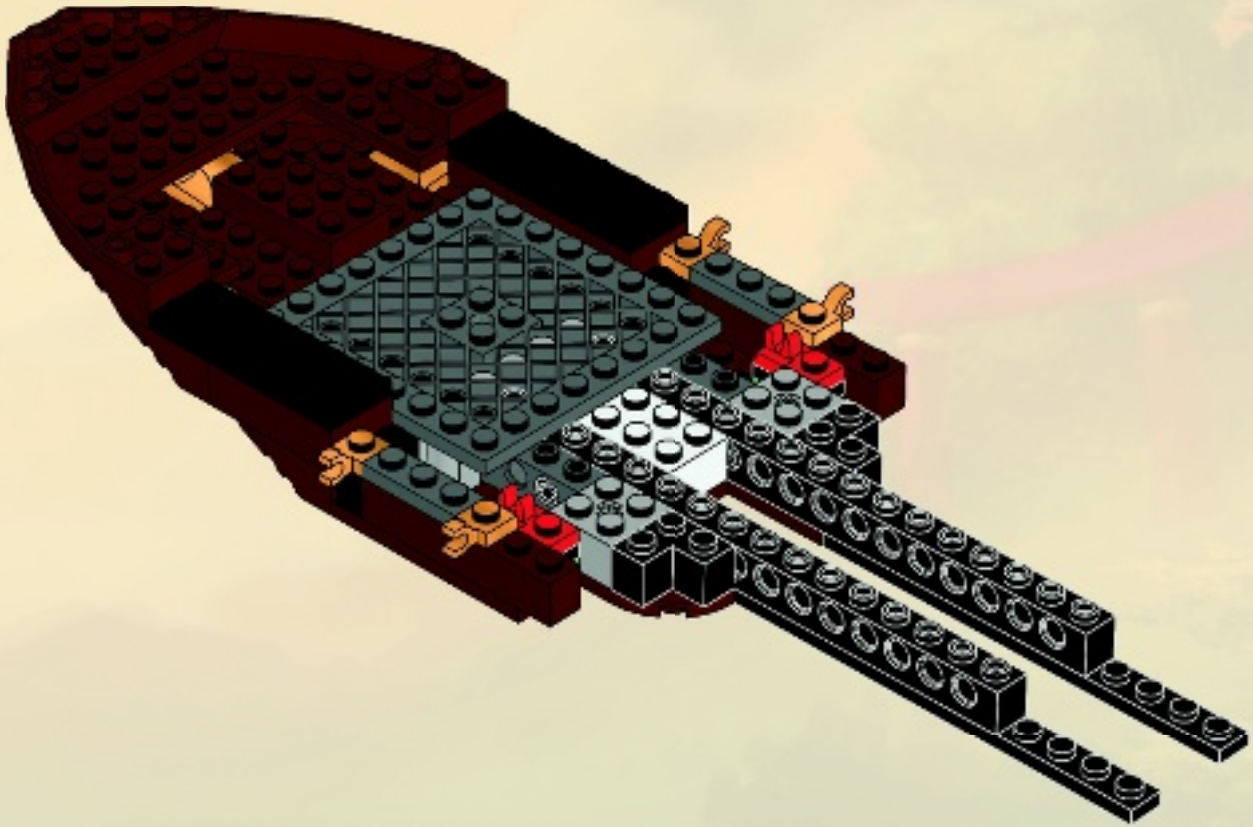

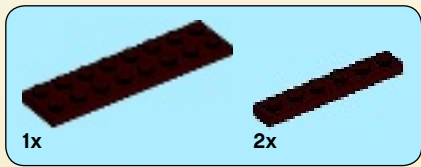

18

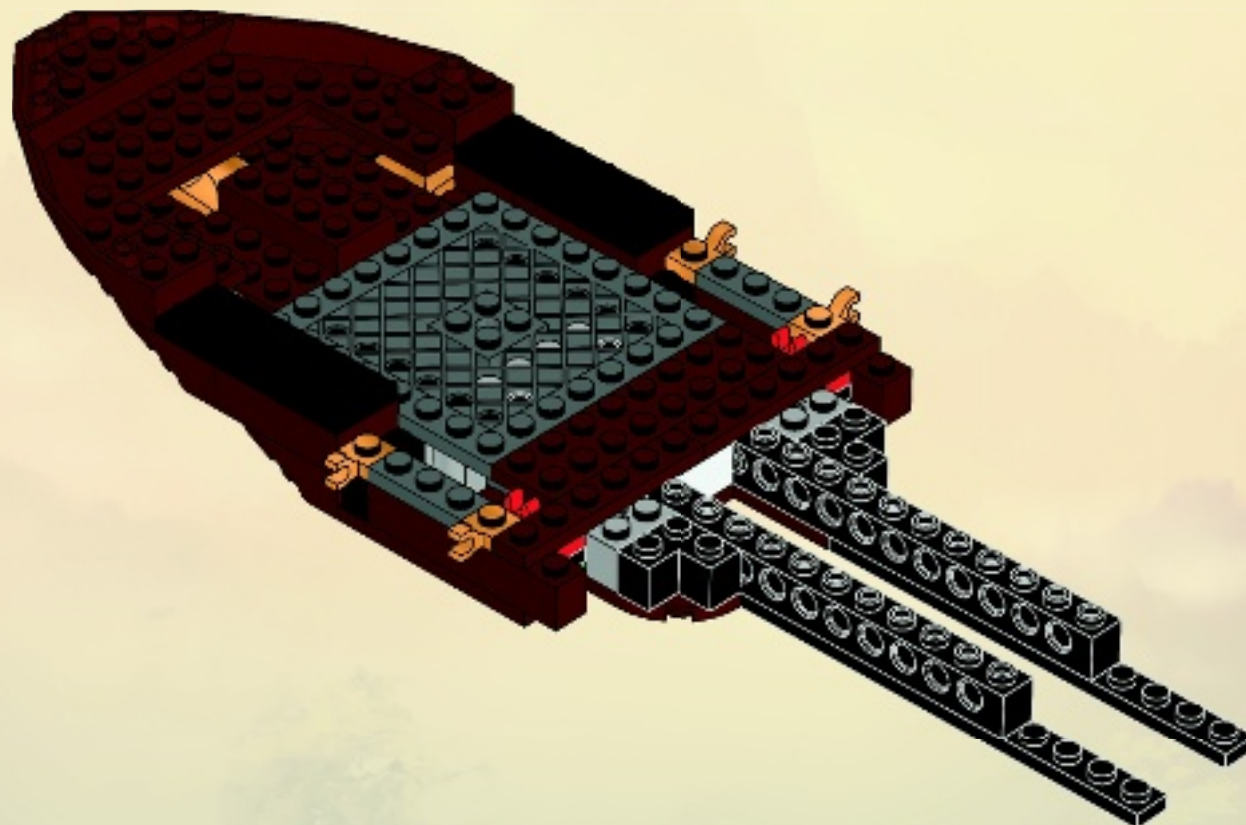



19

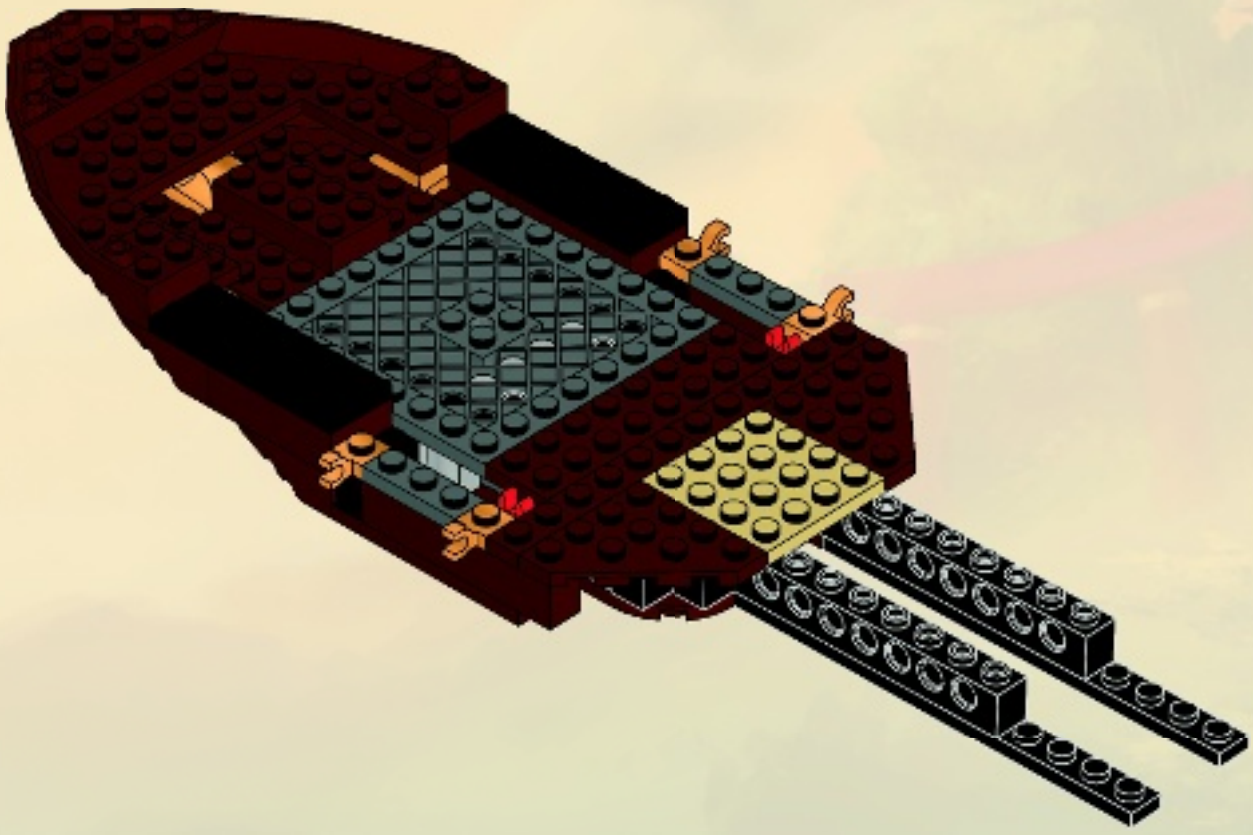

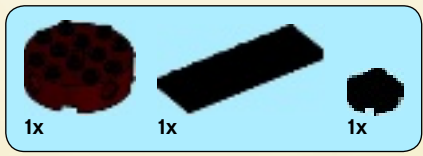

20

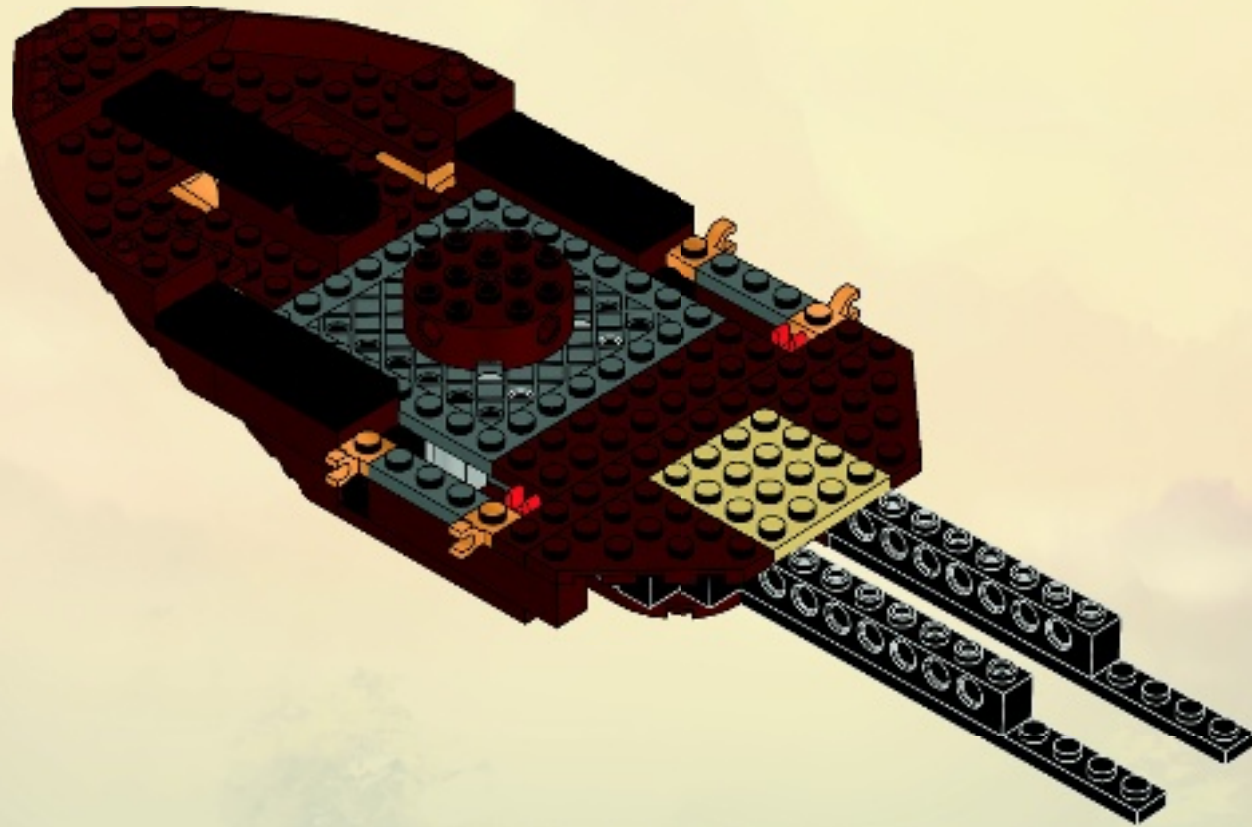

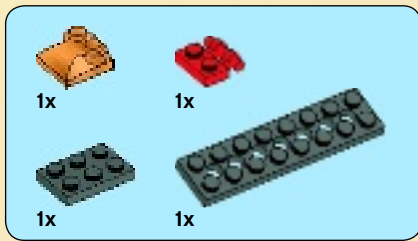

21

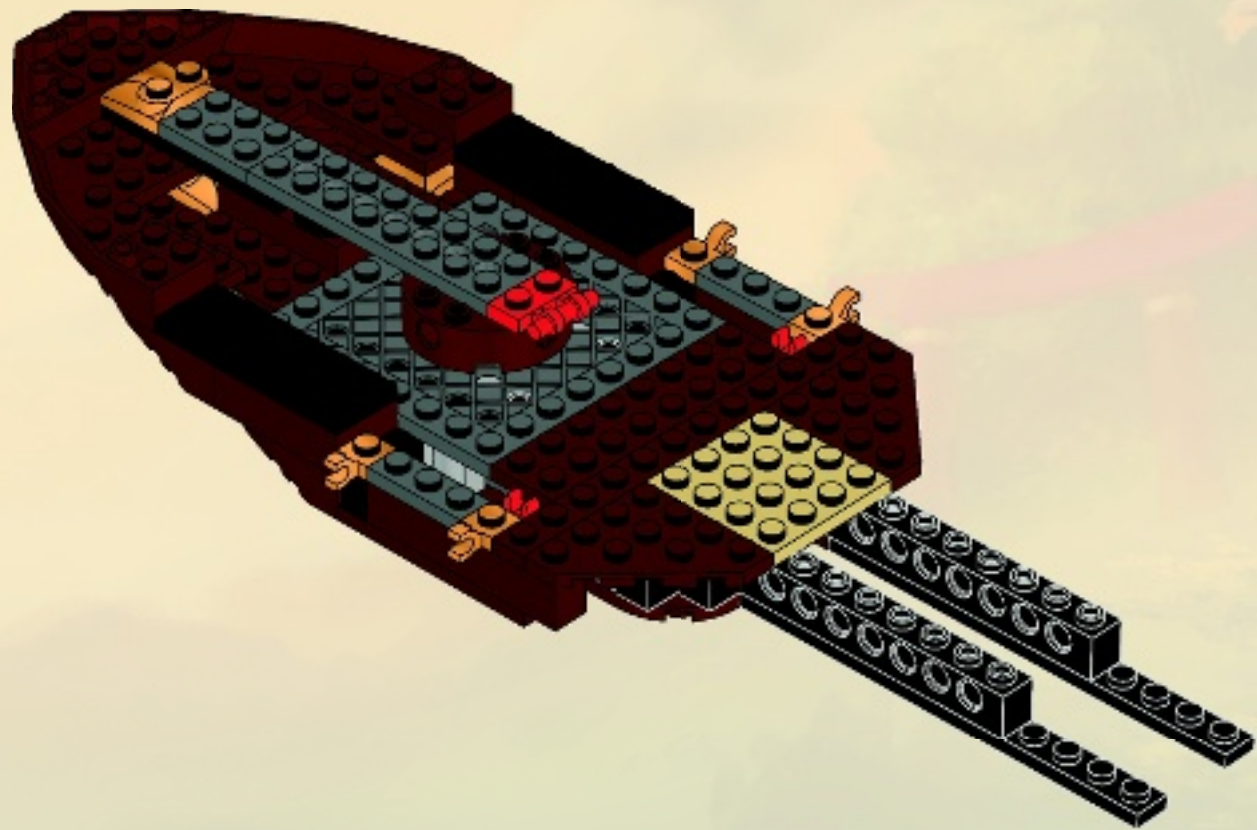



6x



4x

22

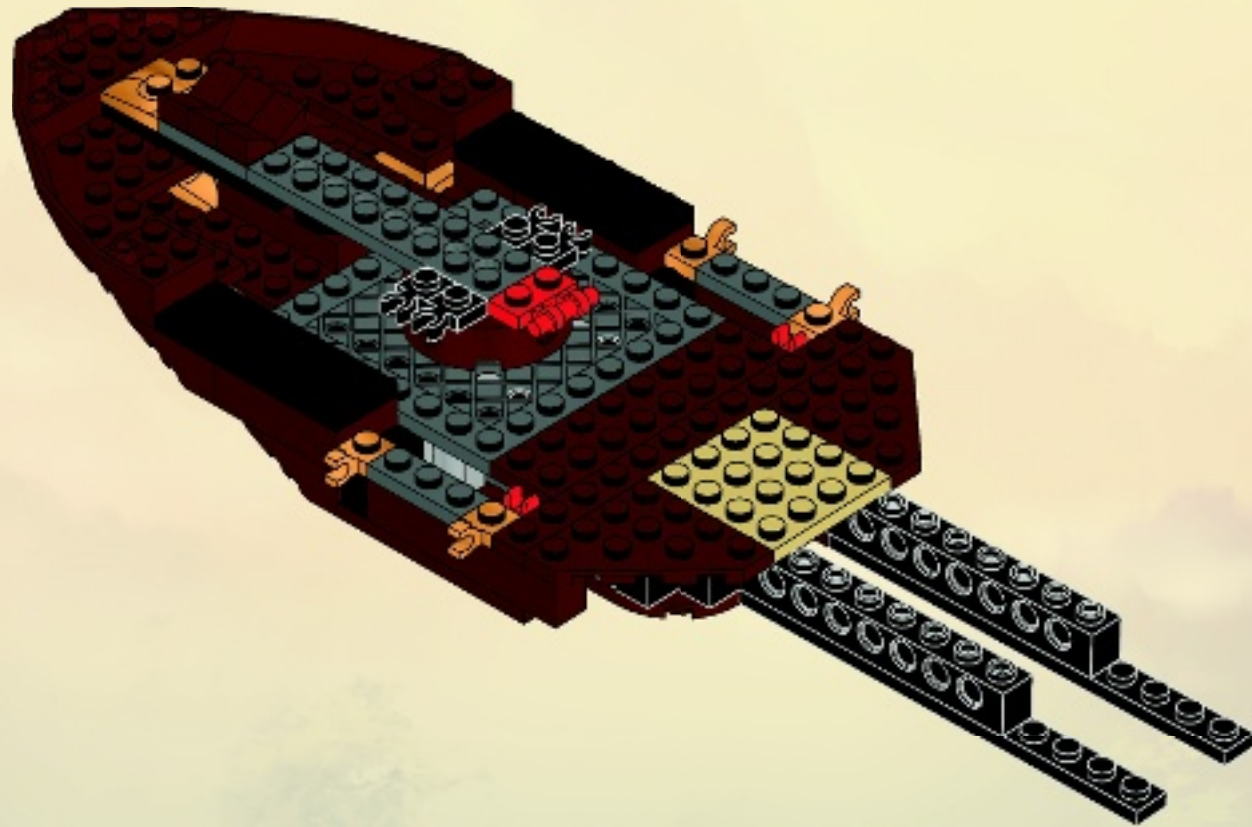



2x



2x

23

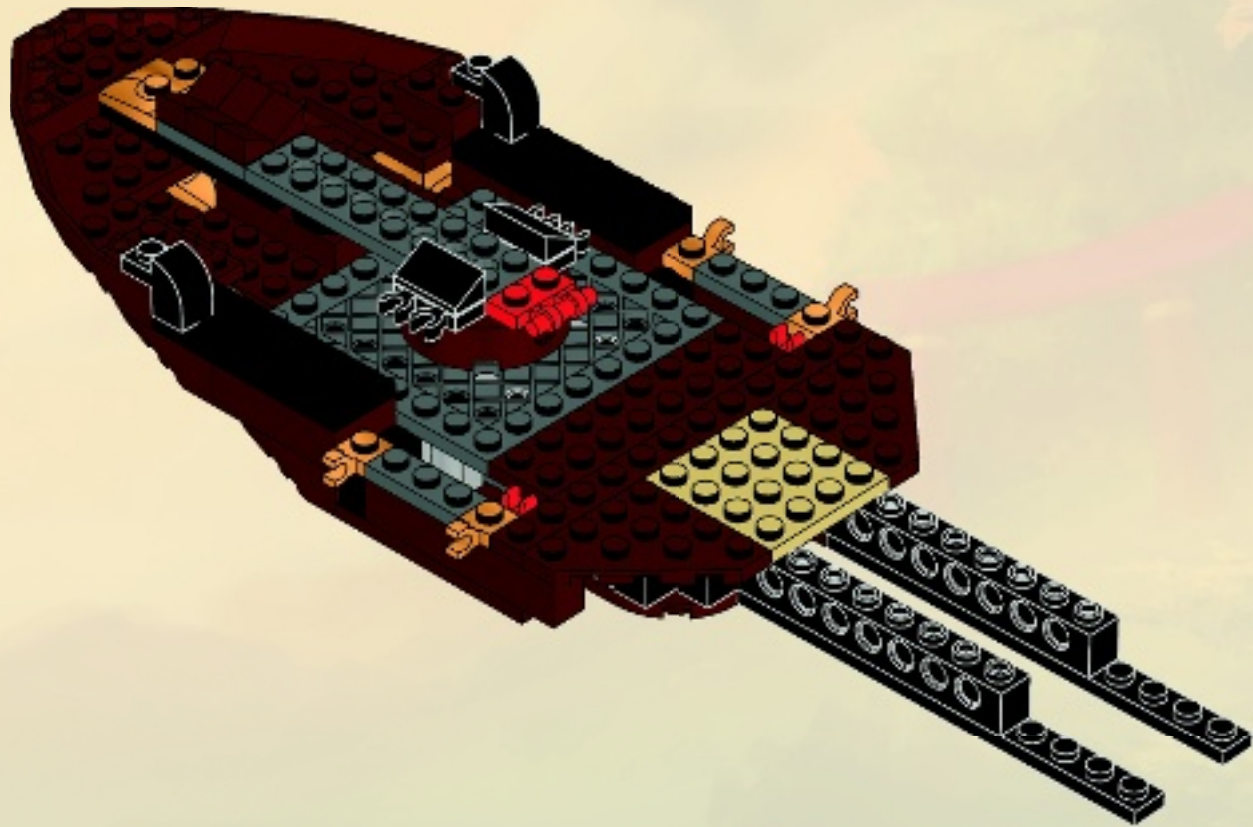

2x 2x 1x

24

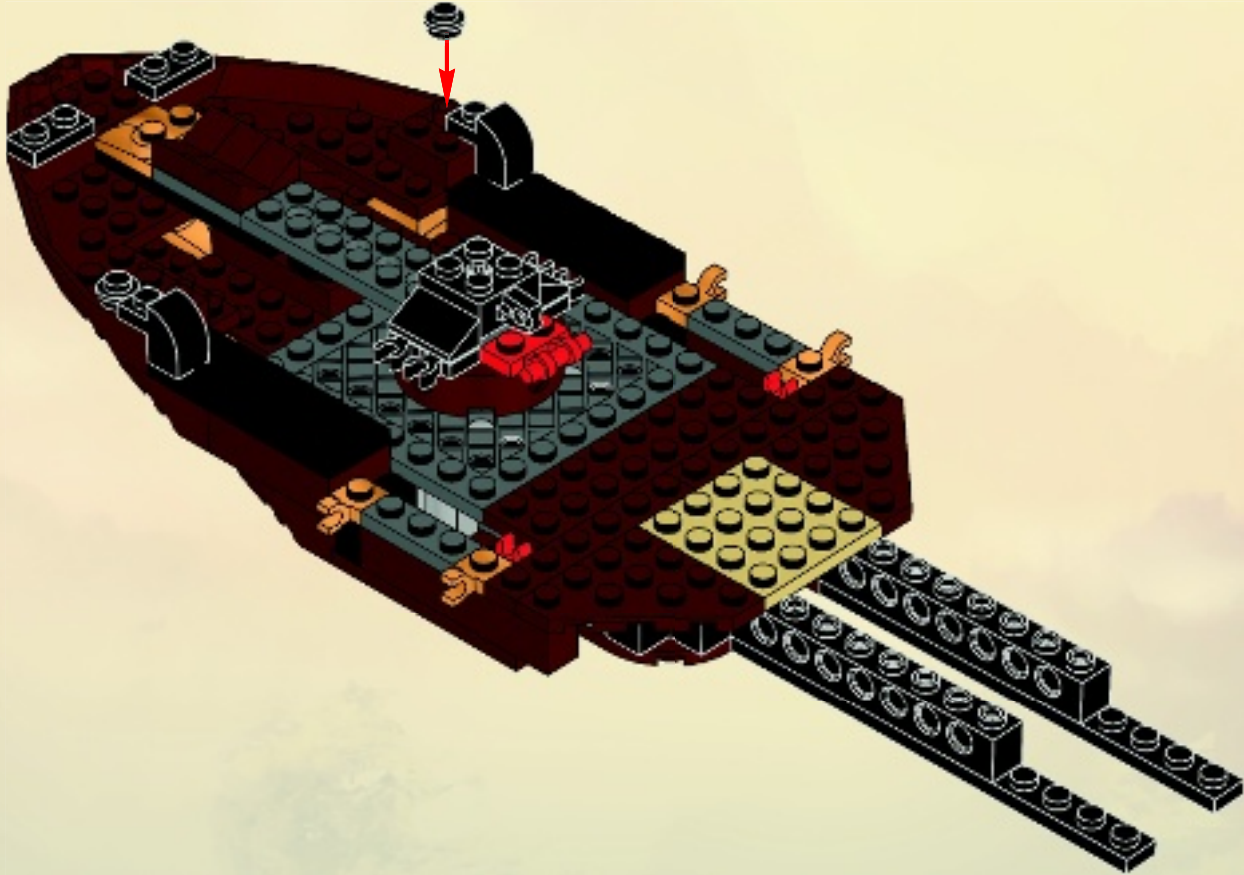

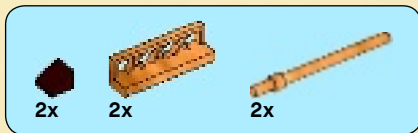

25

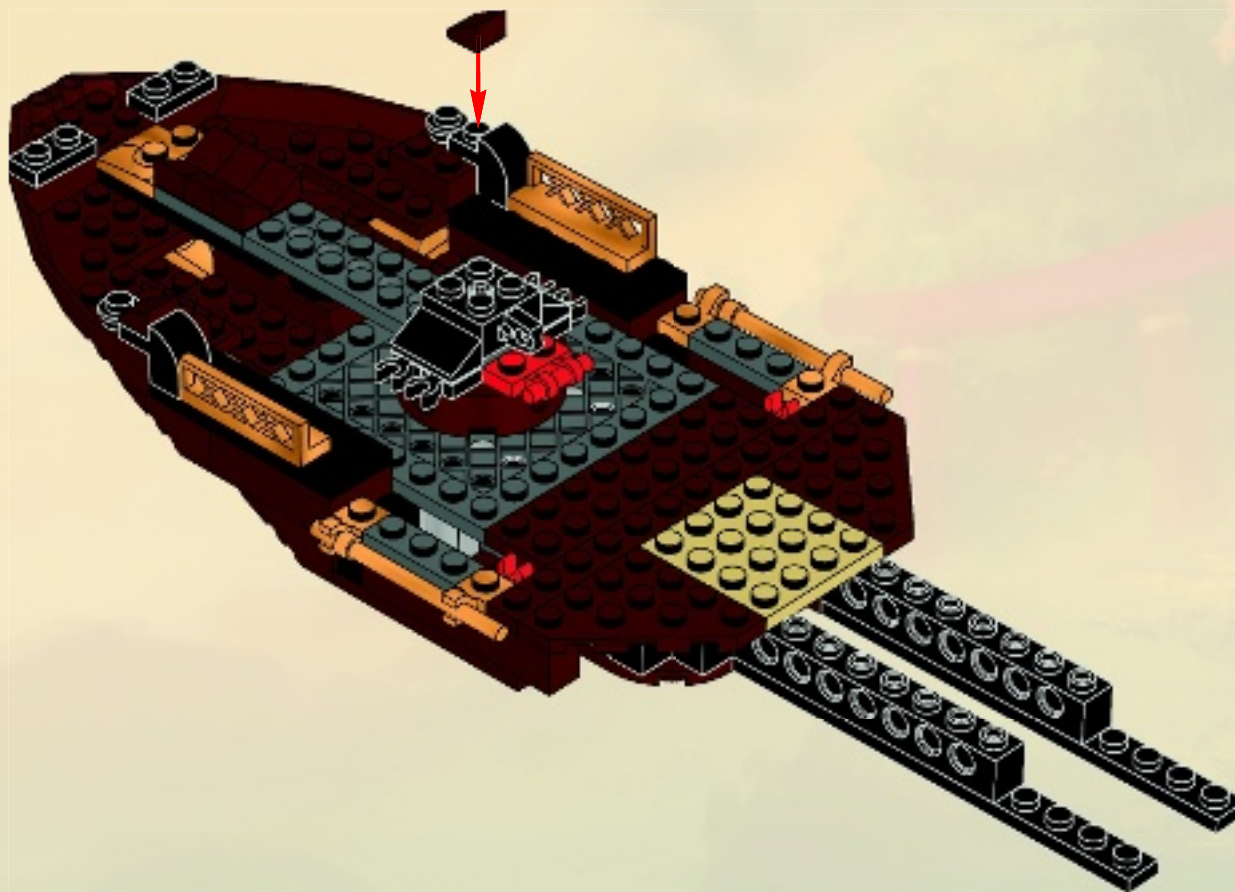

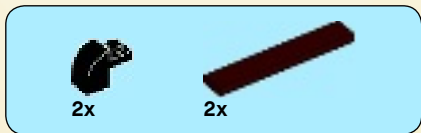

26

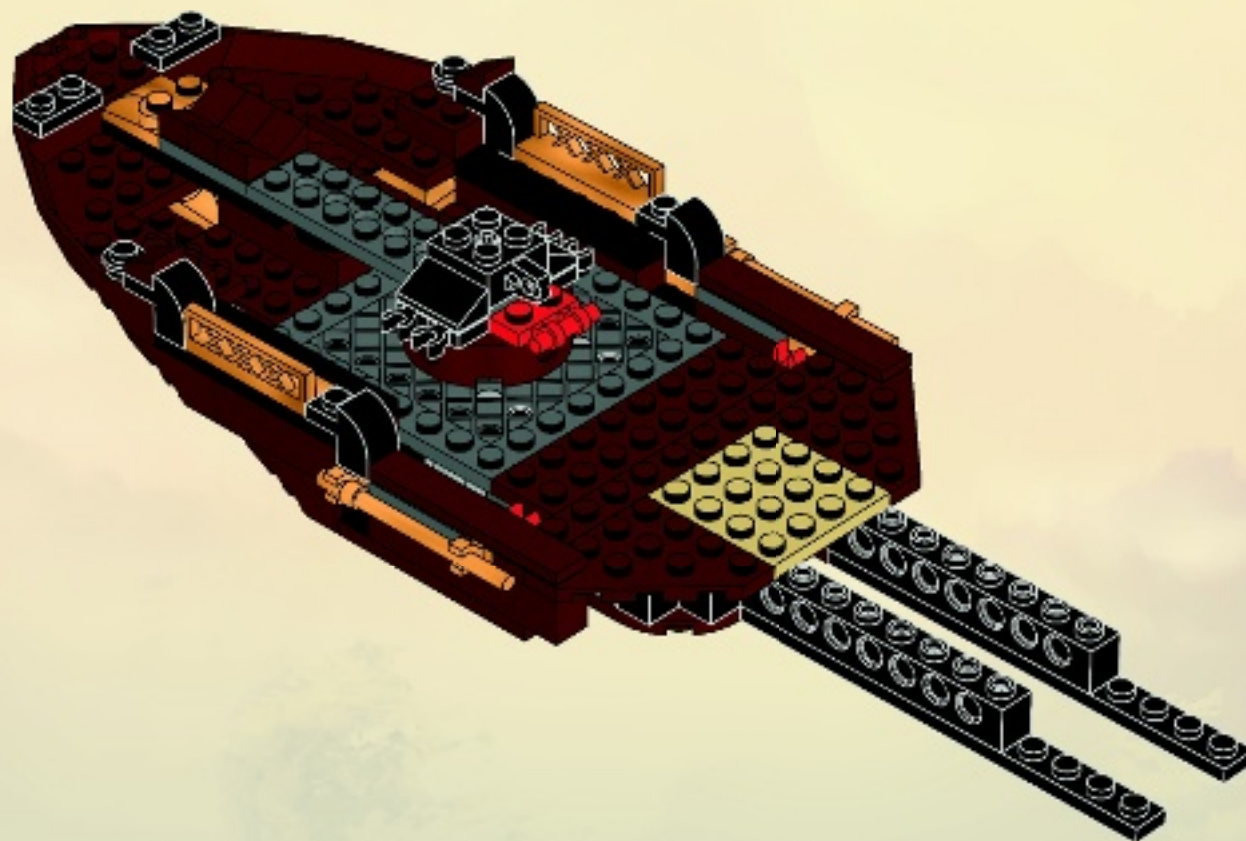

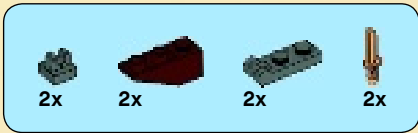

27

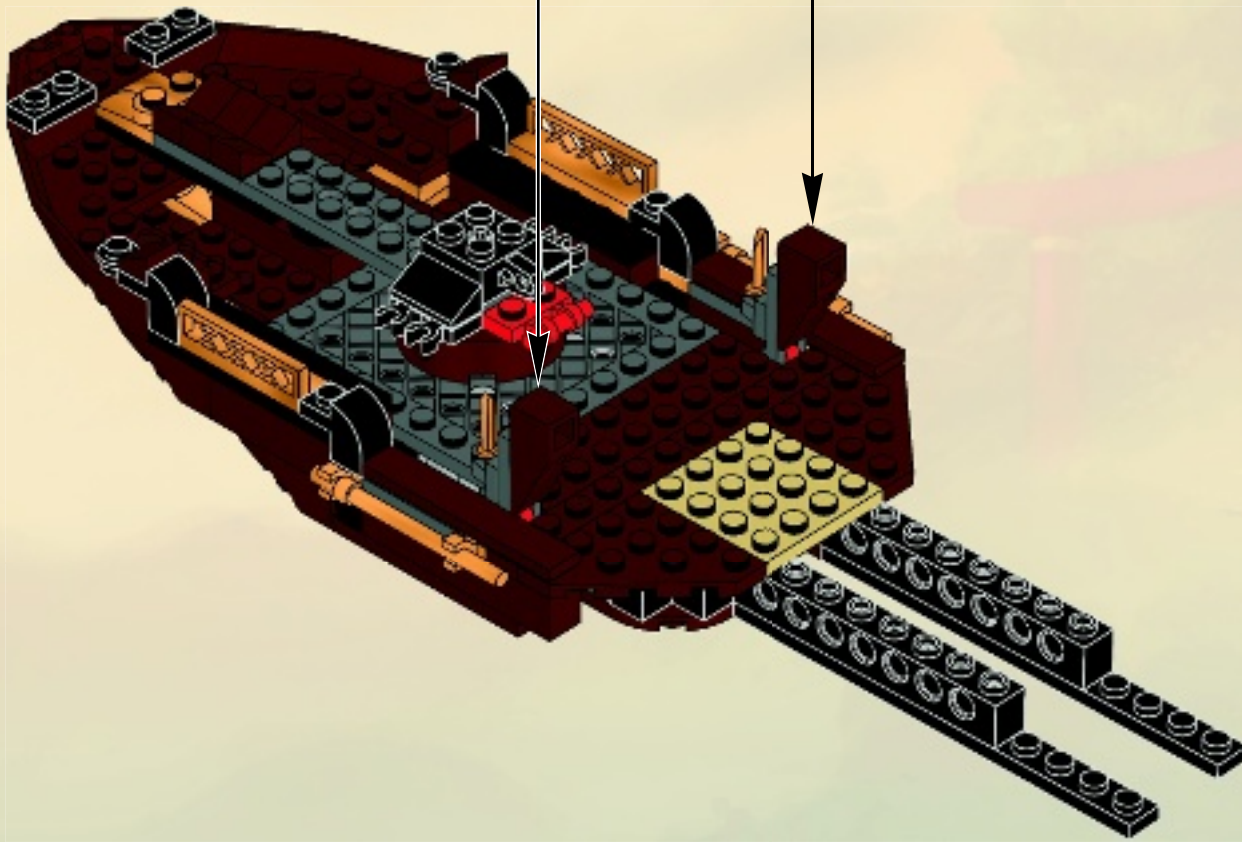
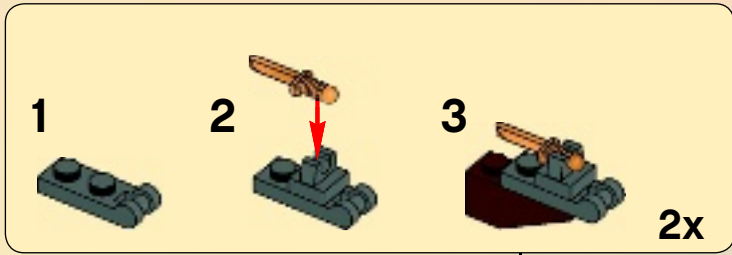

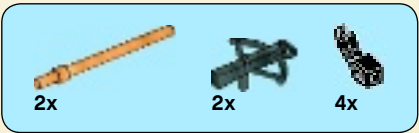

28

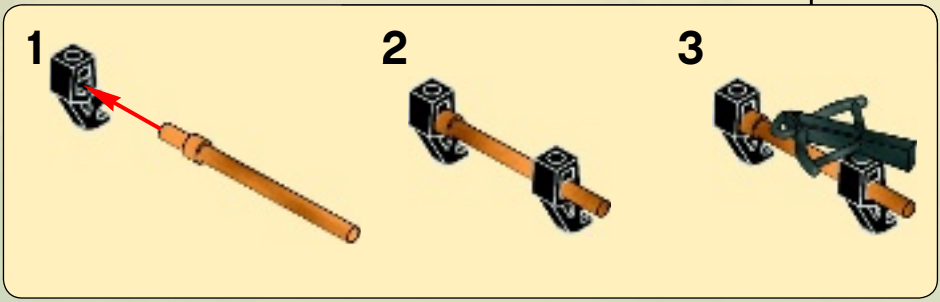
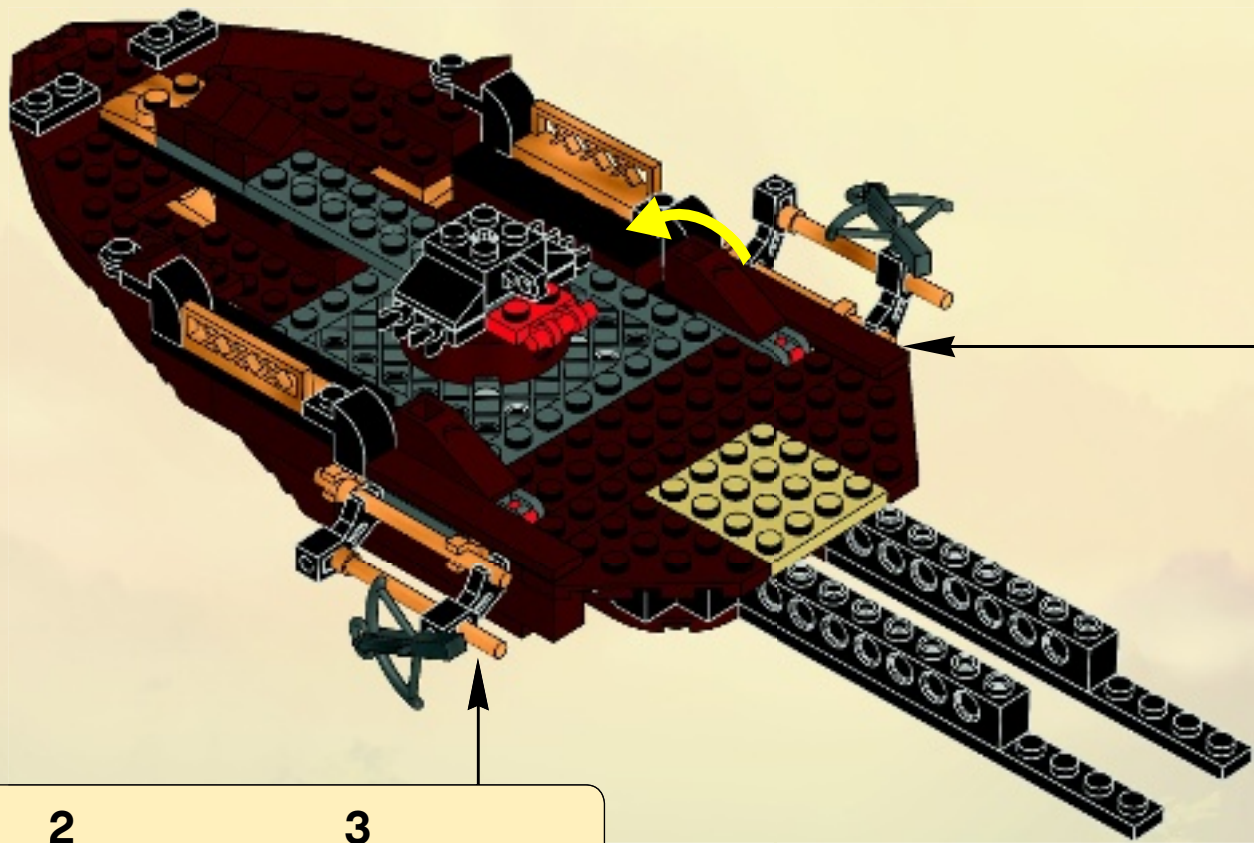
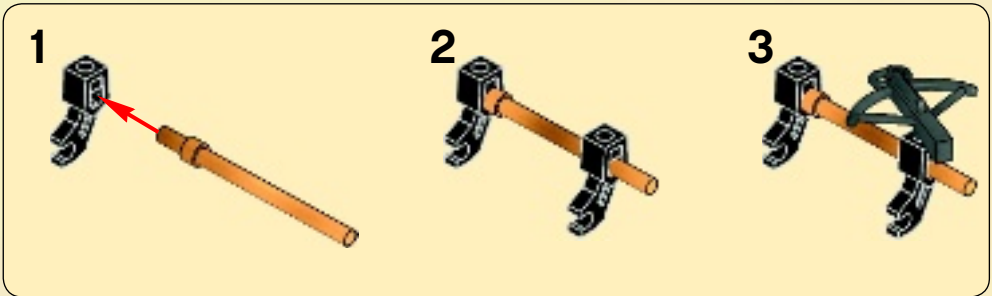



NINJAGO

Masters of Spinjitzu



NINJAGO.COM



NINJAGO

Masters of Spinjitzu



9445



9442



9443



9446



9567
9552



9564



9553



9561



9552



9566



9566



9441
9558
9579



9444



9441
9558



9441
9444
9446



9579



9562
9440



9444
9558
9566



9551



9440 9445
9446 9553
9558



9562



9558



9558
9563
9567



9564



9551



9443



9446



9446



9443



9446



9552



9444
9579



9561
9553



9442
9558



9579
9558



9562



9564



9443



9442
9445



9446



9446
9551
9558
9561



9579



9579



9567



9563



9440



9445
9563



NINJAGO

Masters of Spinjitzu



9446



9445



9443

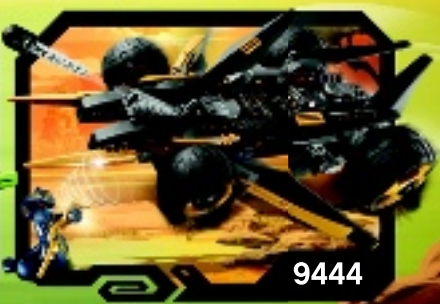

9444



9446



9445



9444



9443



9442



9441



9440

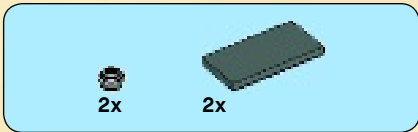
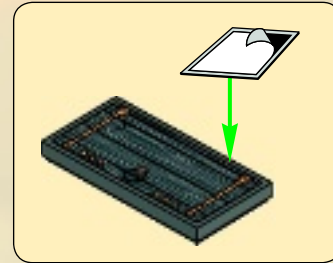
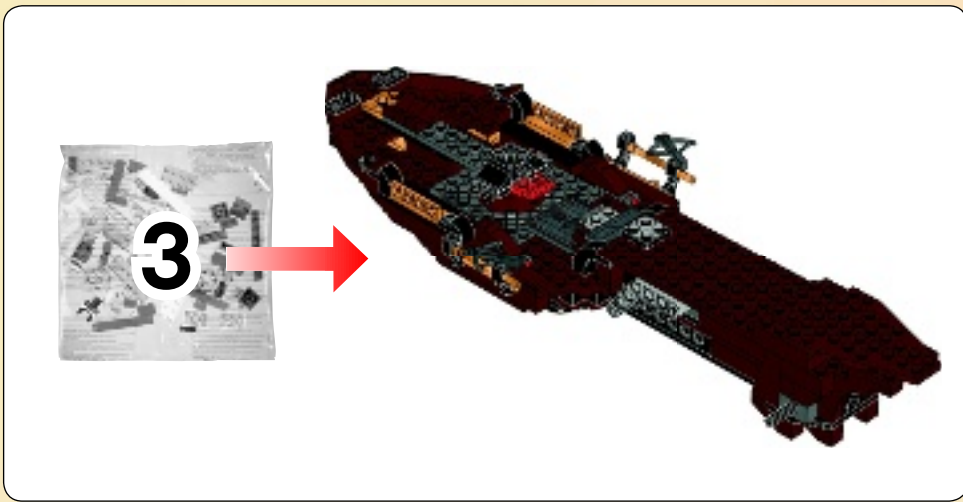

29

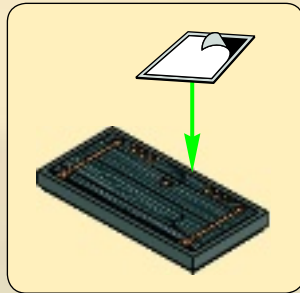



1x



2x

30

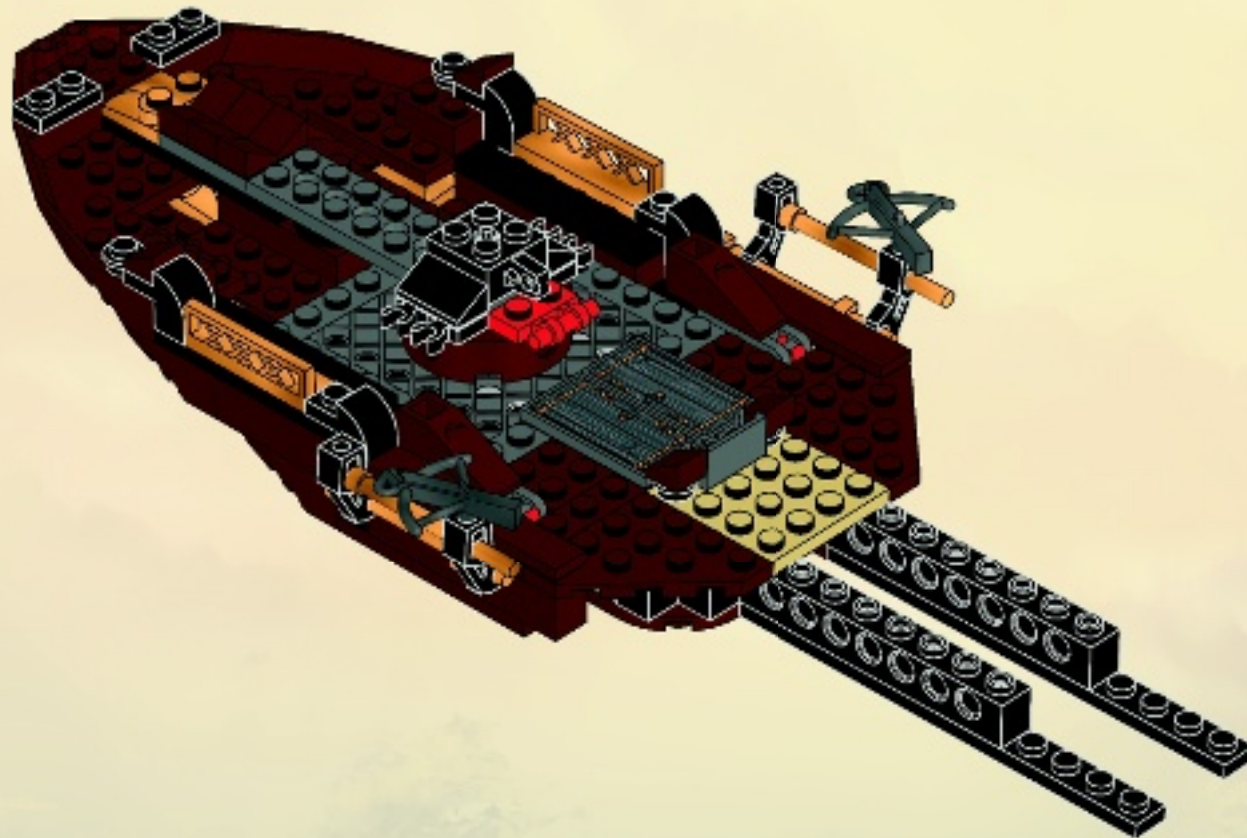



31

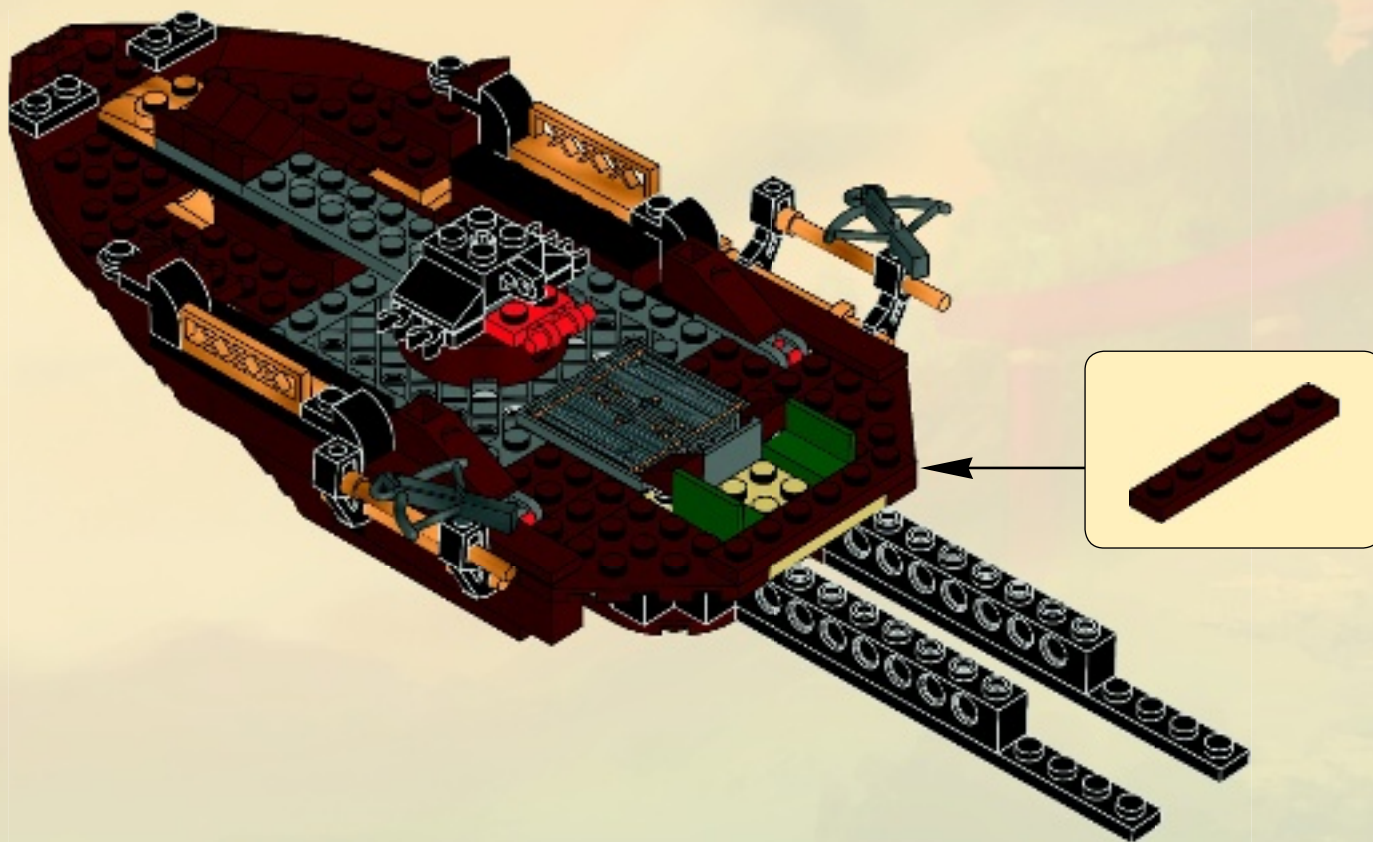

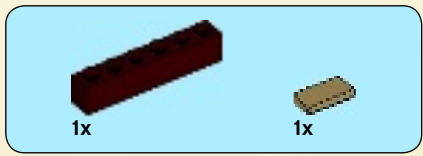

32

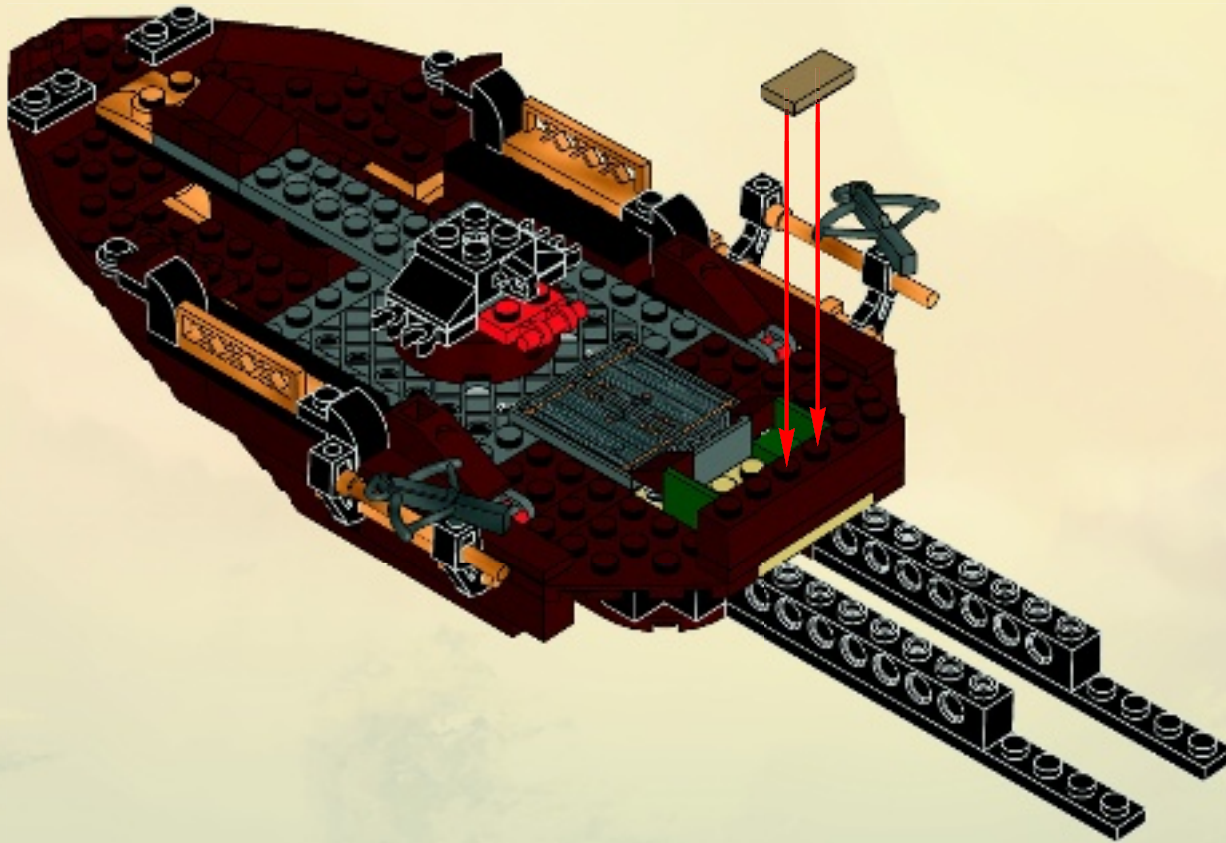

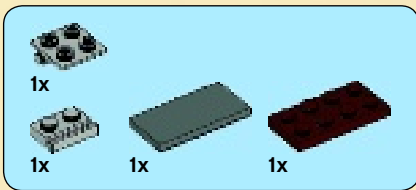

33

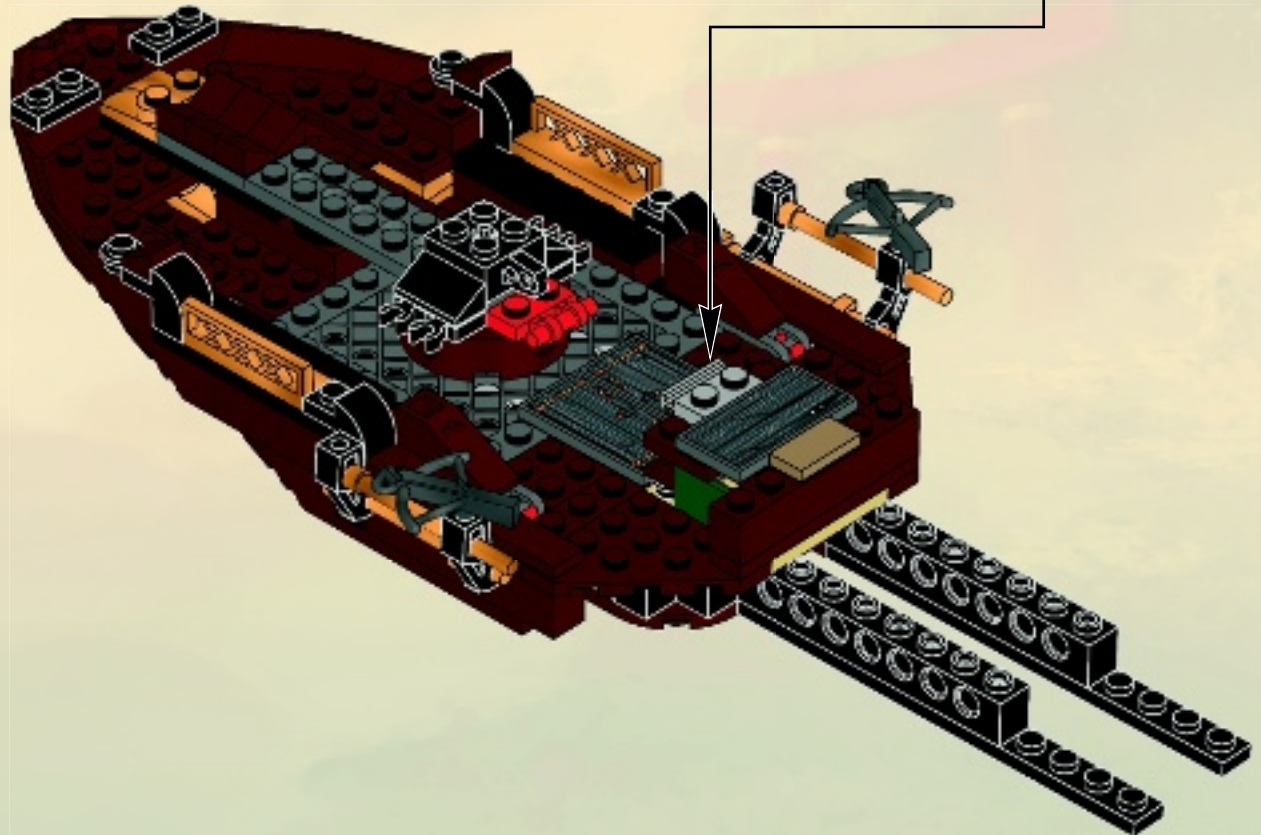
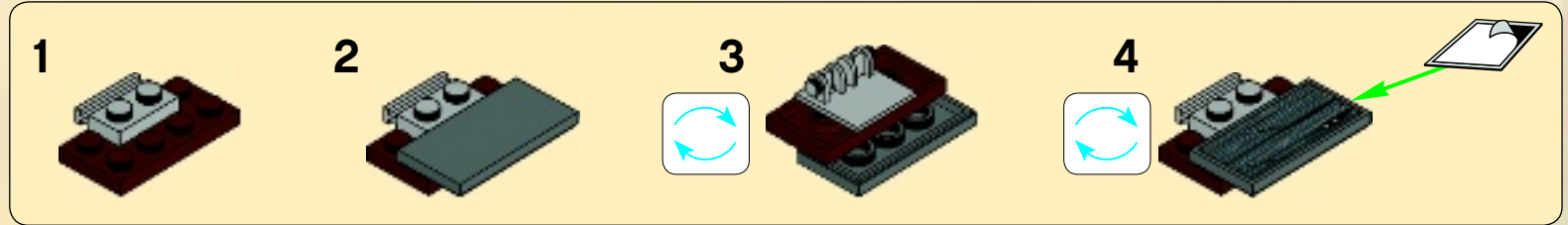

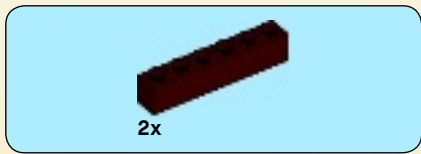

34

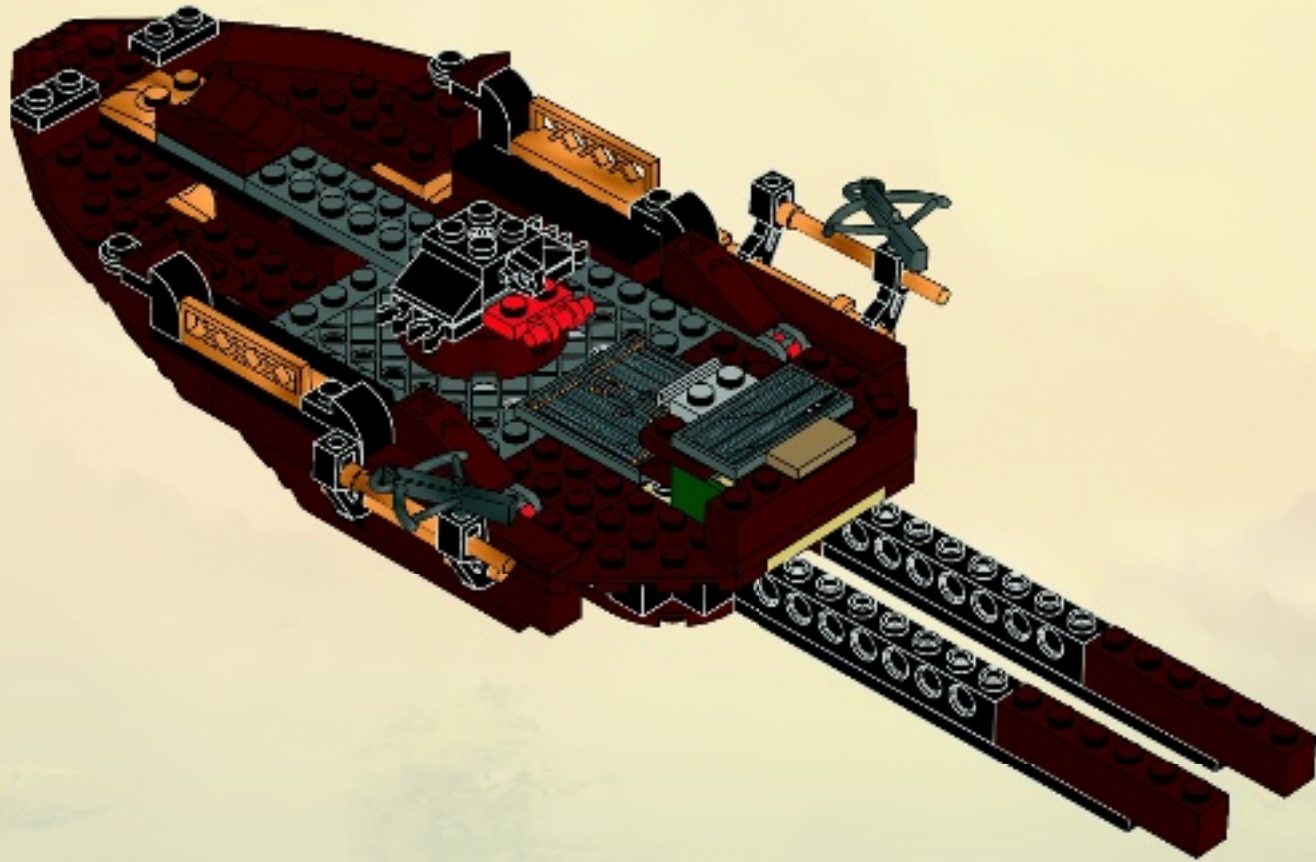

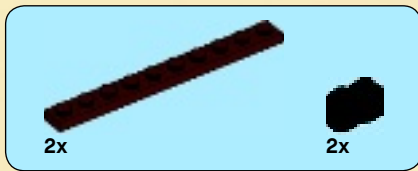

35



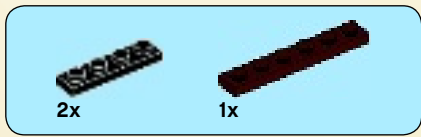

36

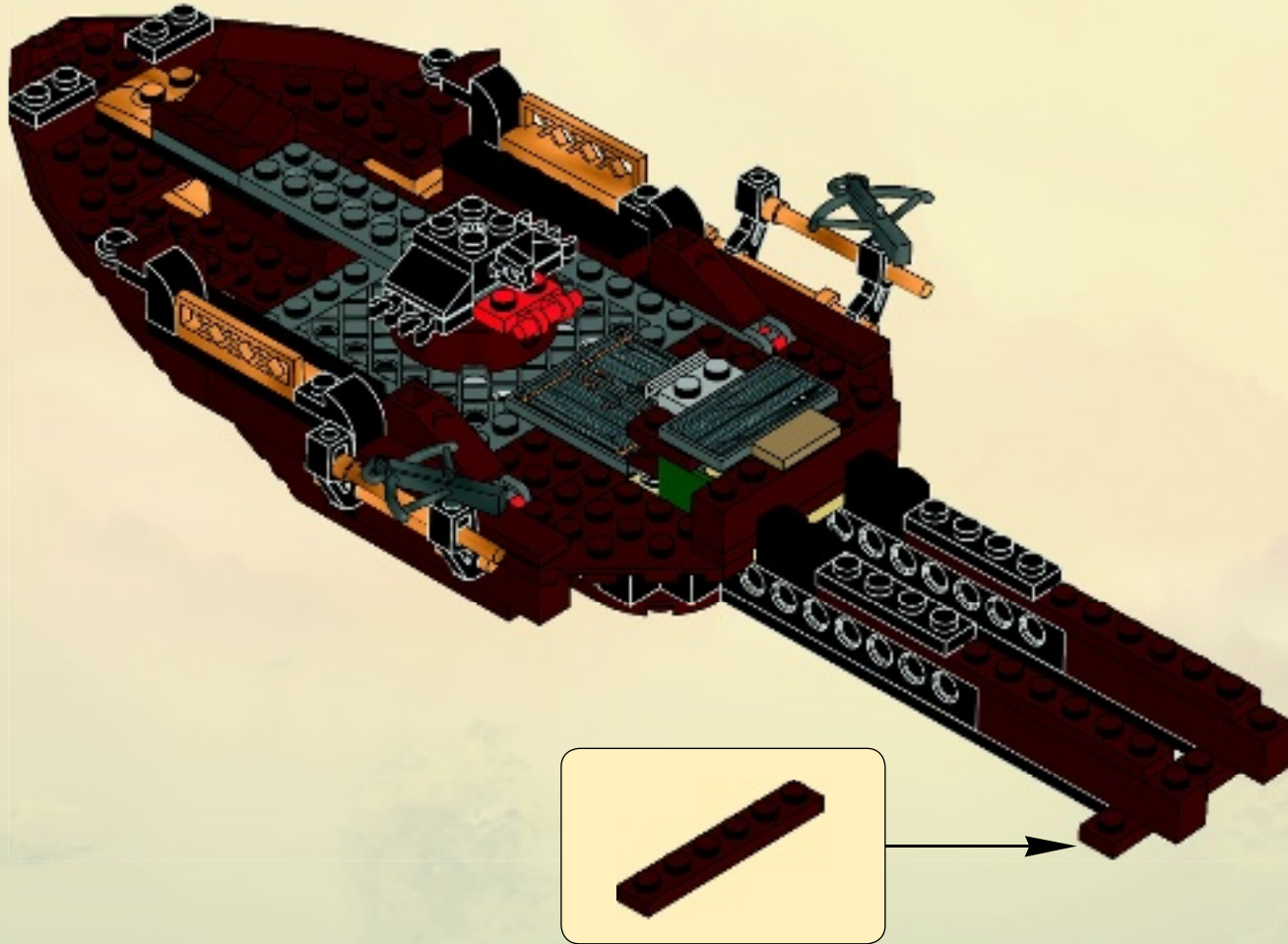



37

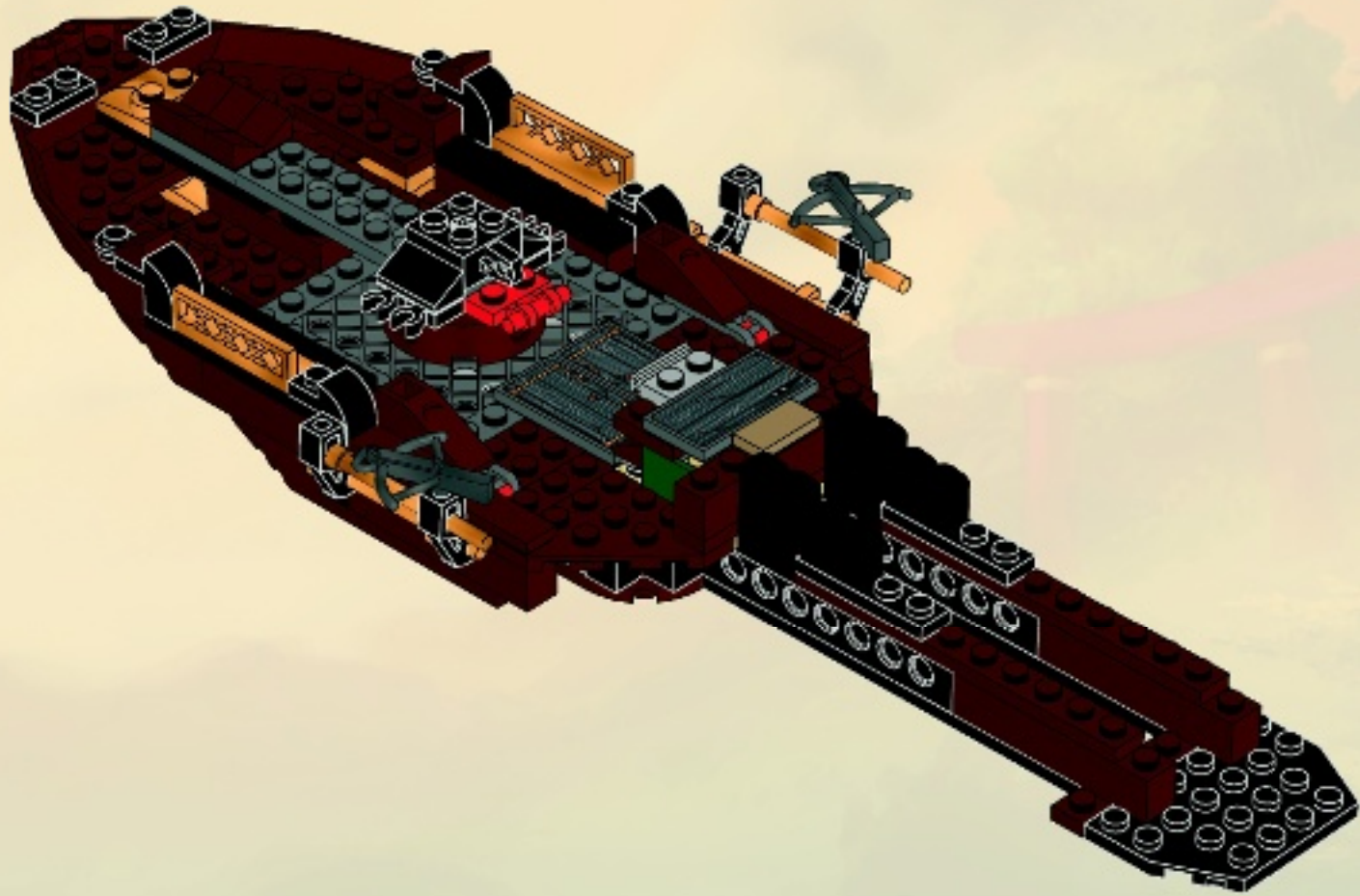

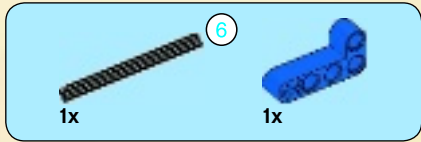
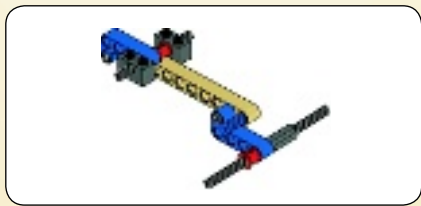

1

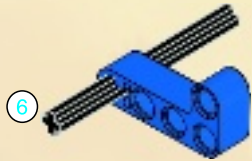

2

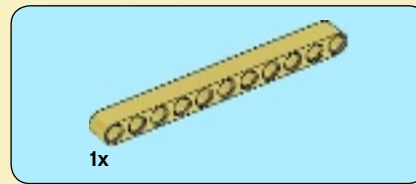
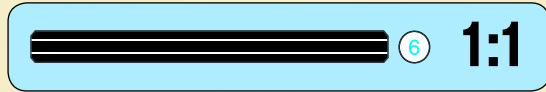
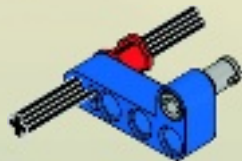

3

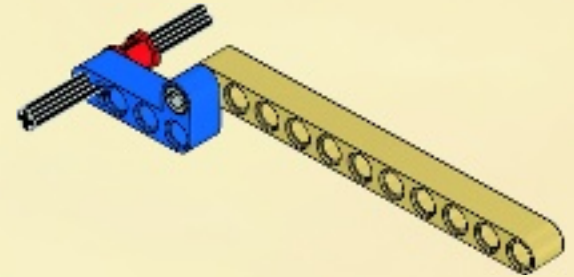

4

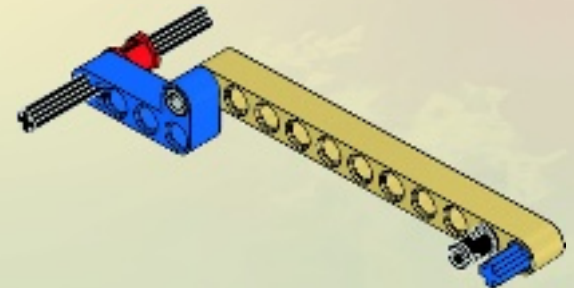



5

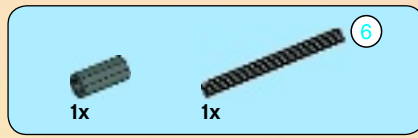
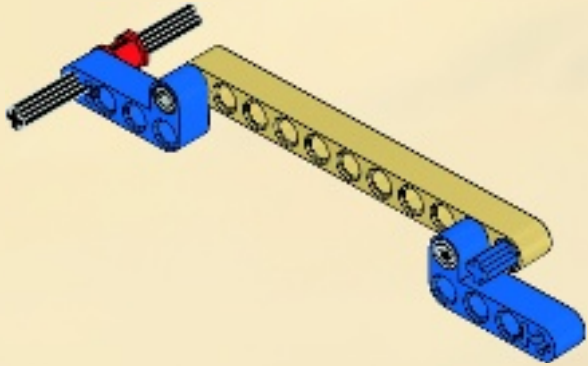

6

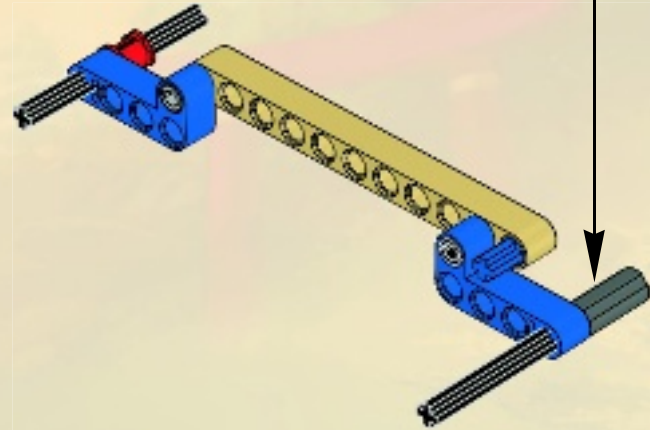
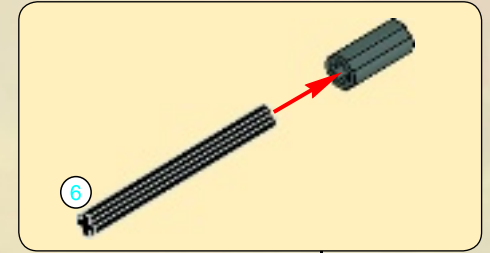

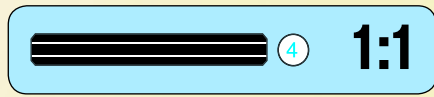

7

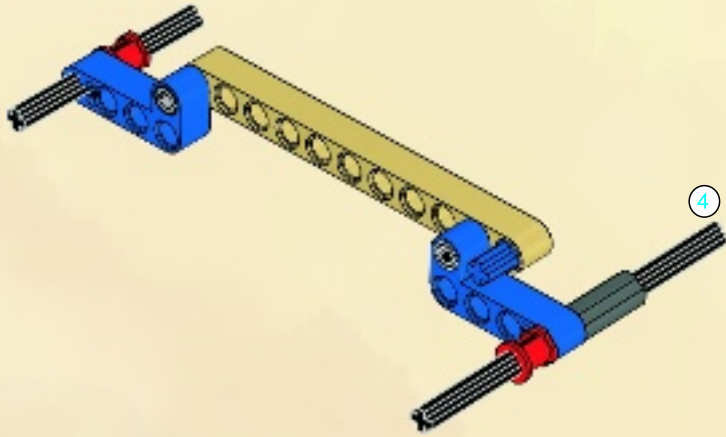

8

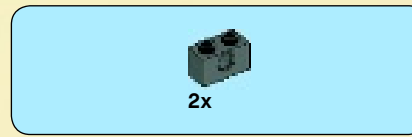
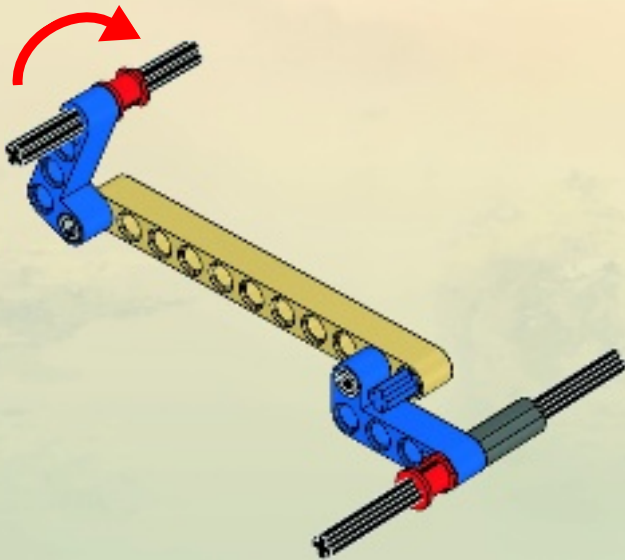

9

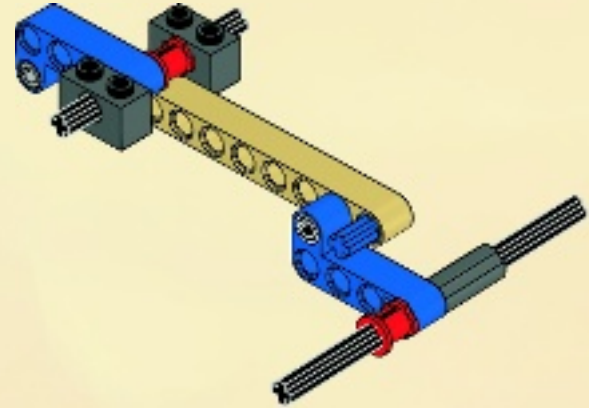

38

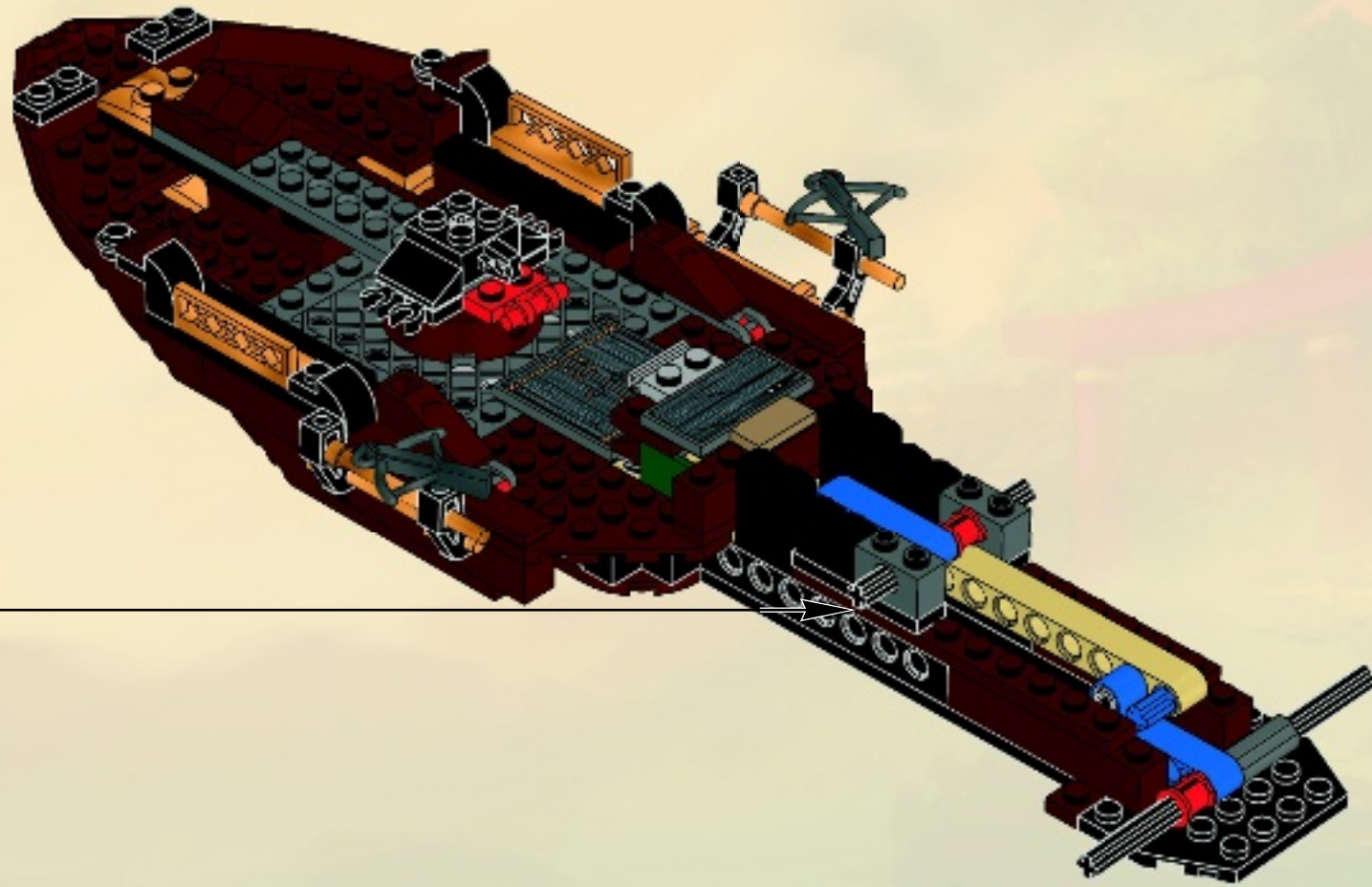



2x

39

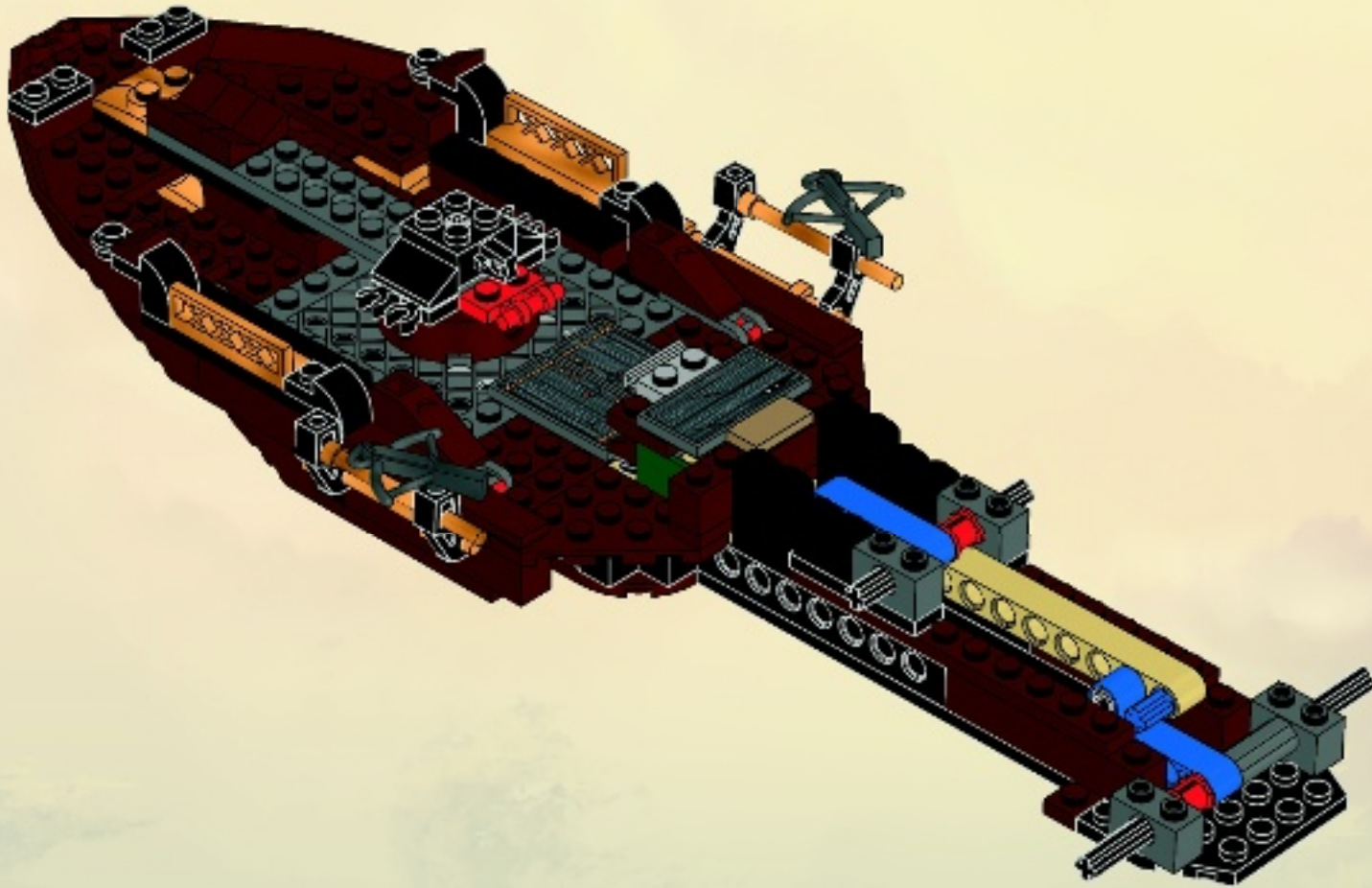



40







2x

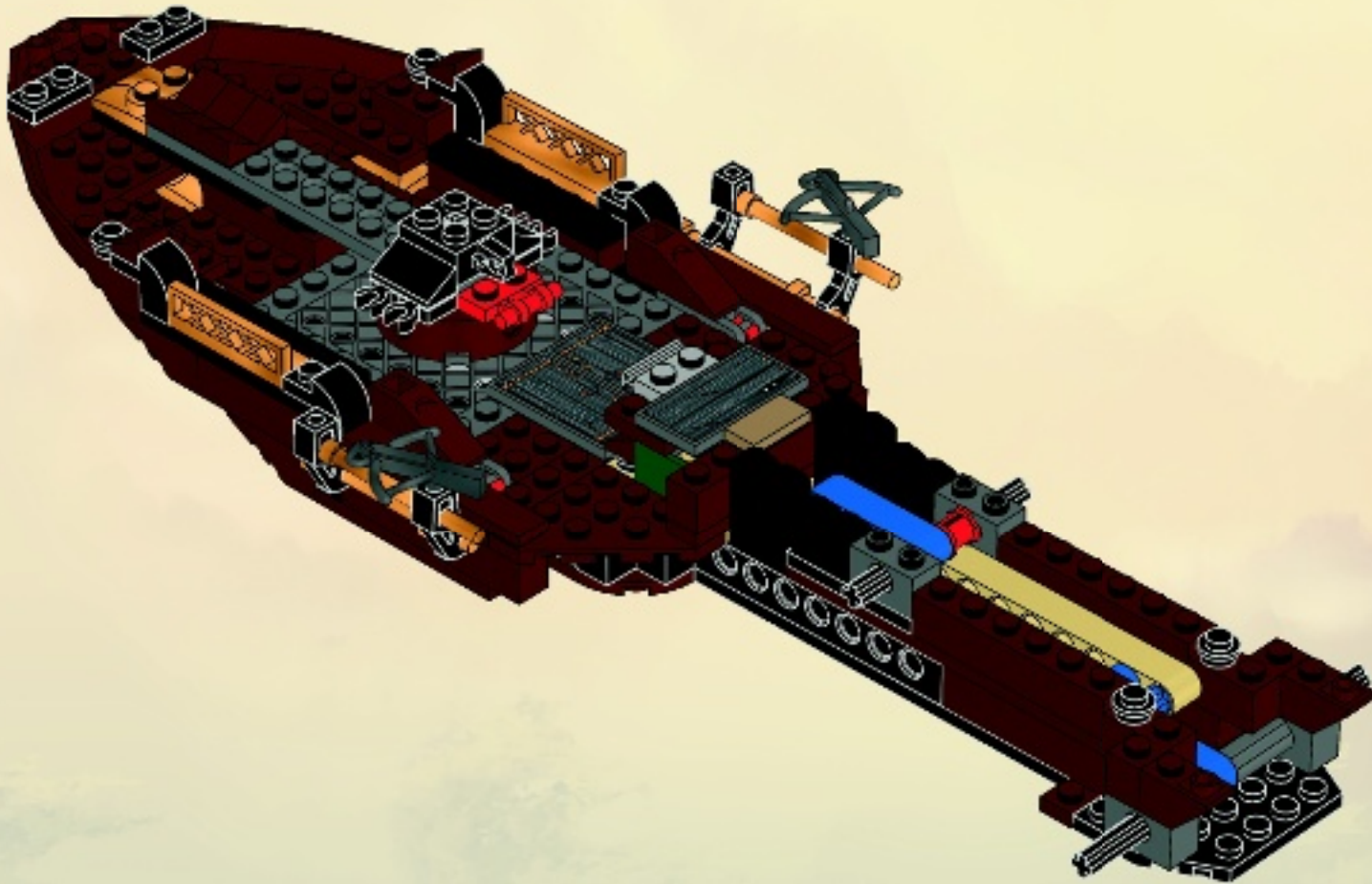

2x

41



2x  2x 

42

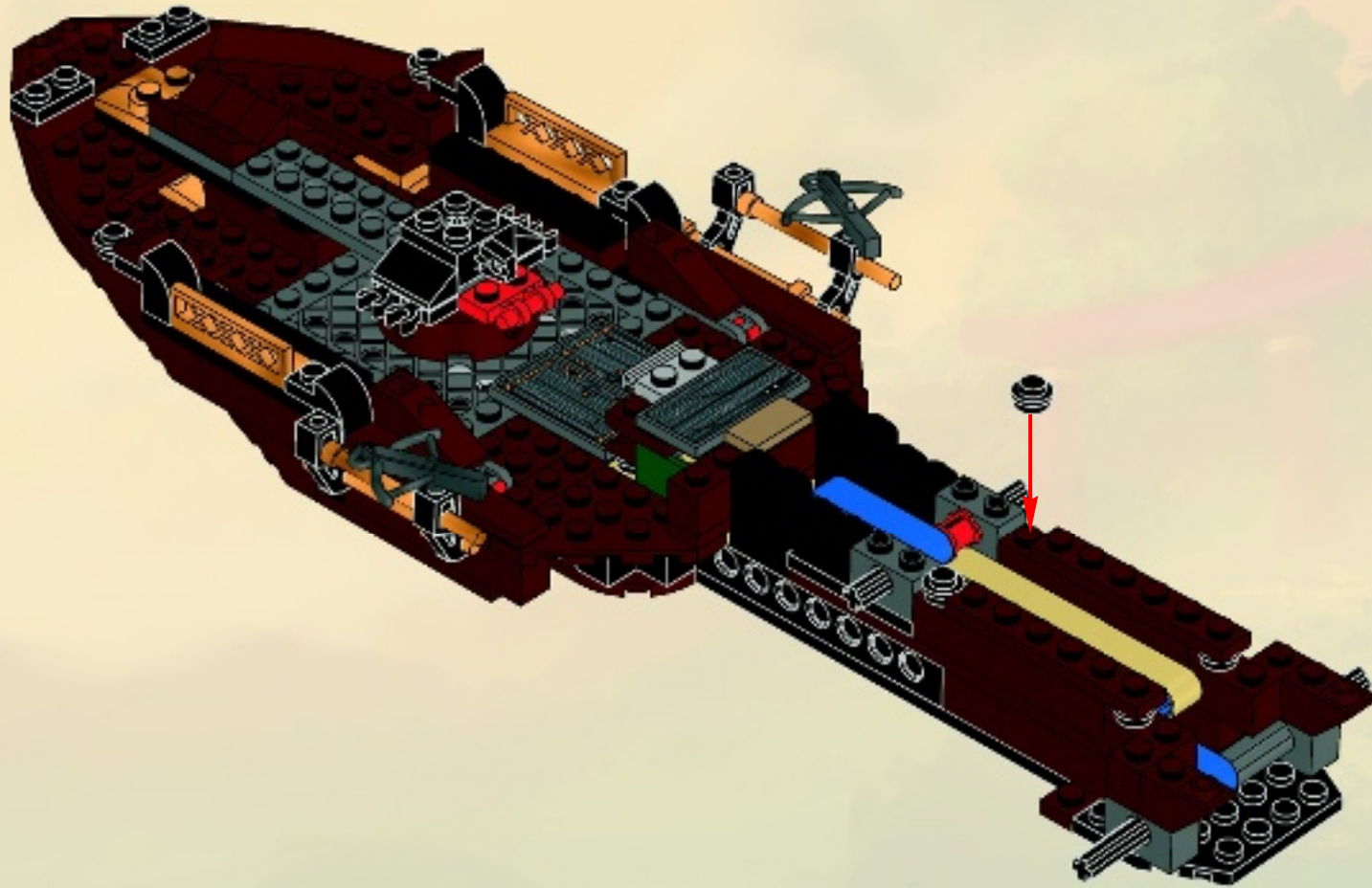

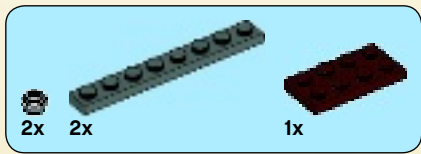

43

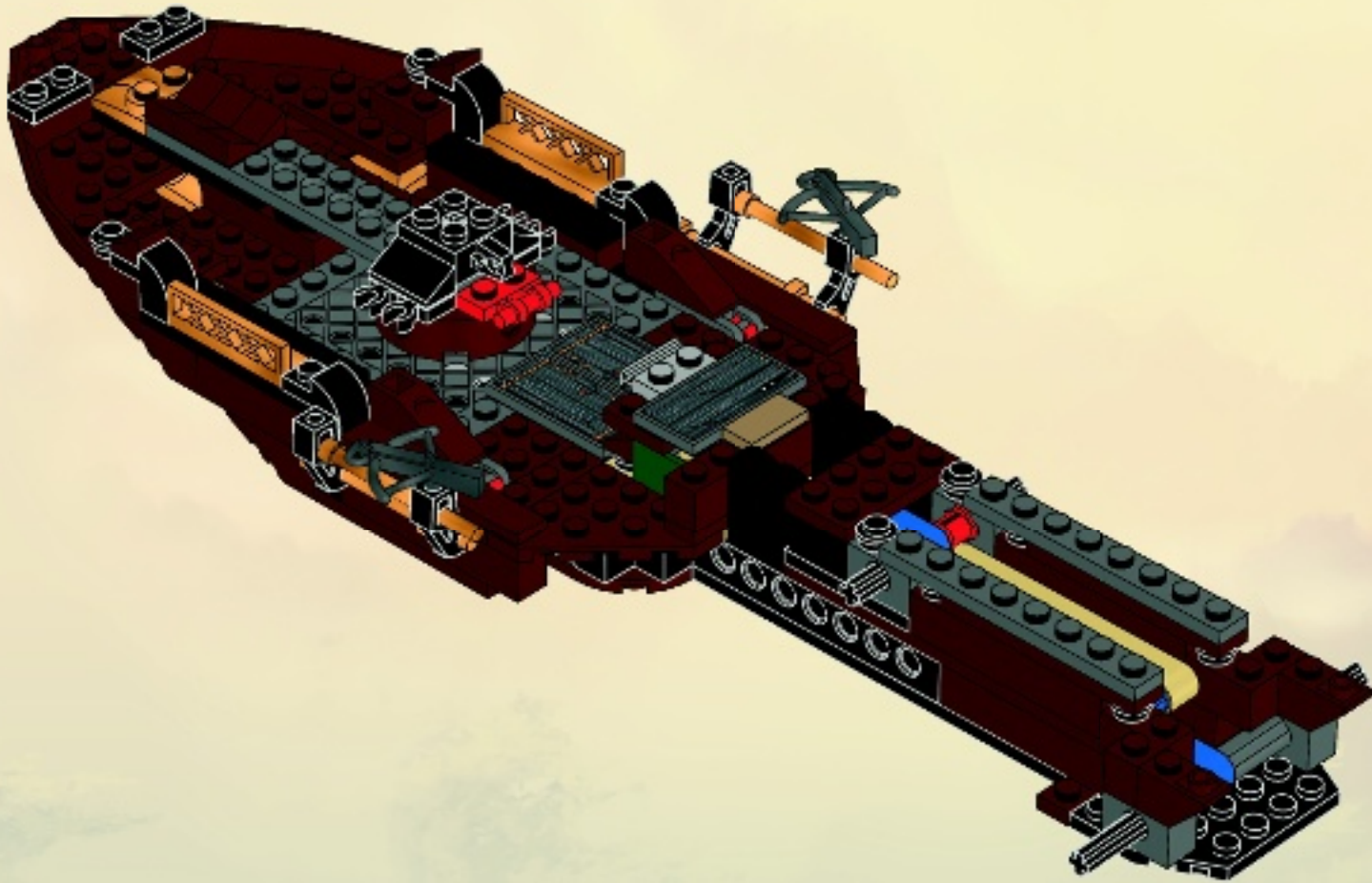

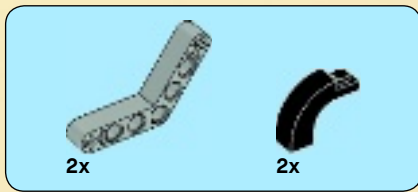

44

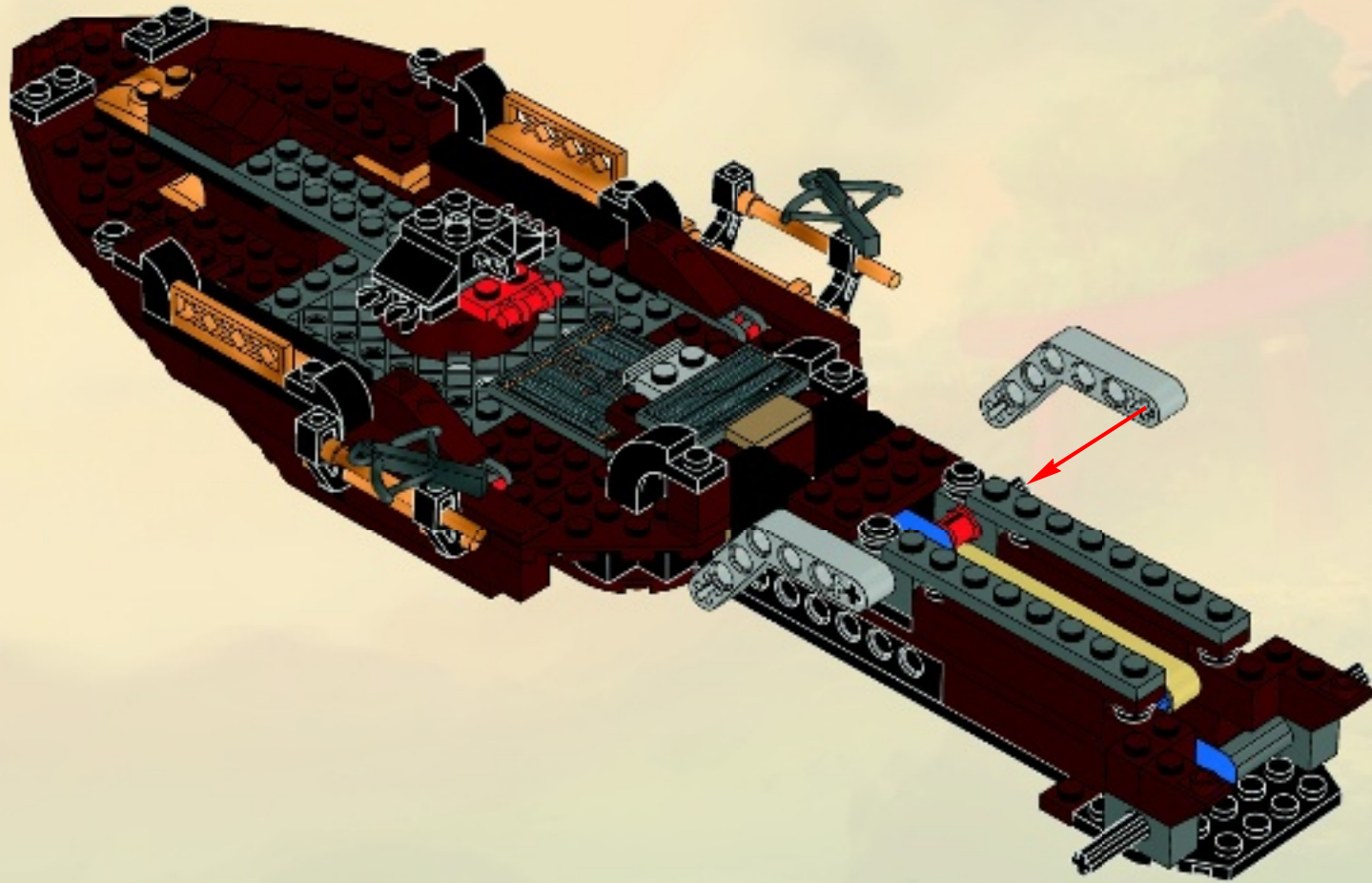

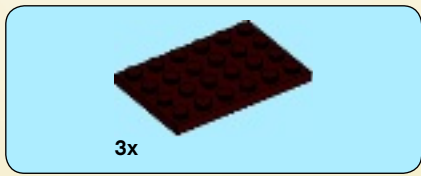

45

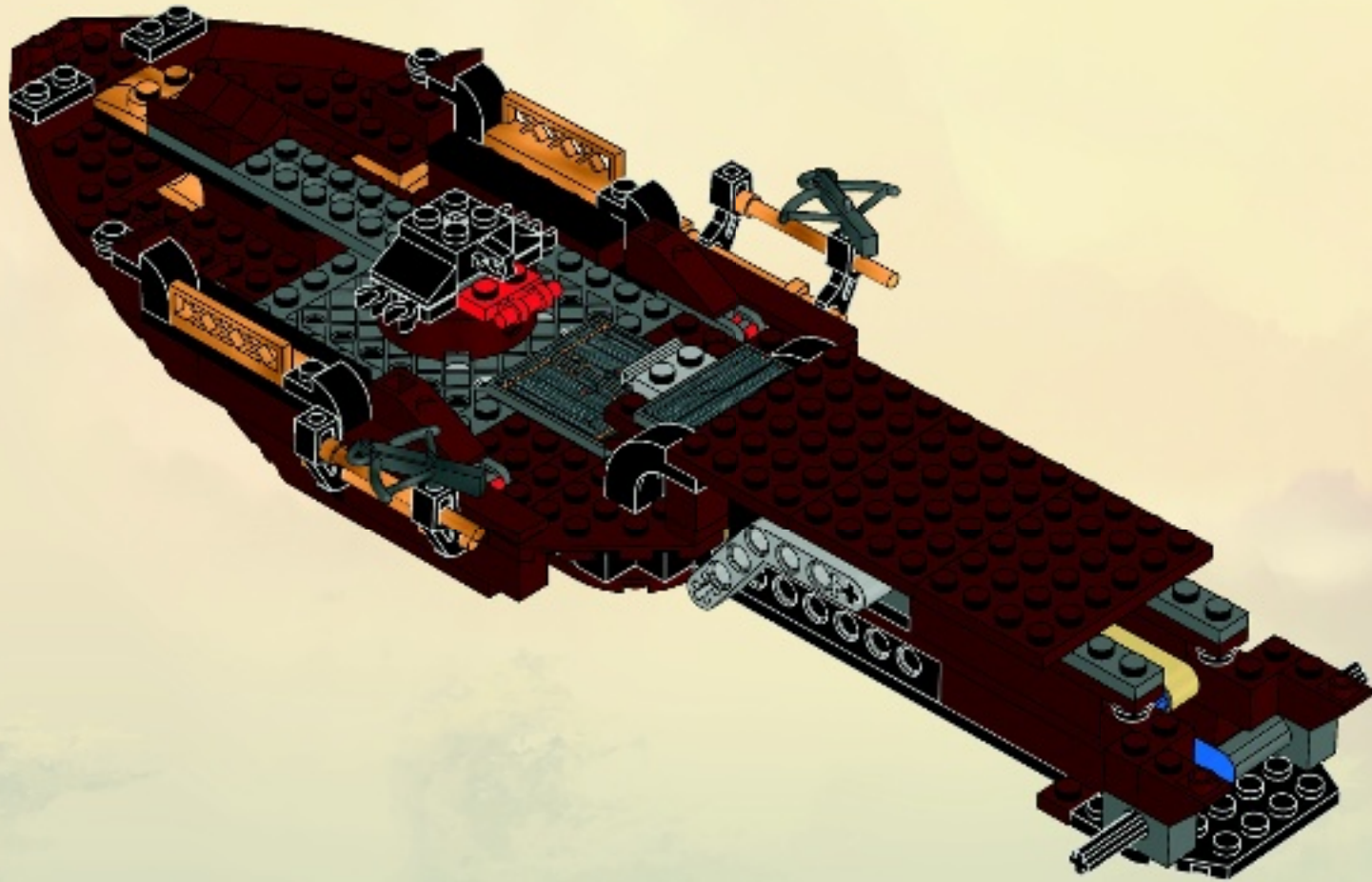

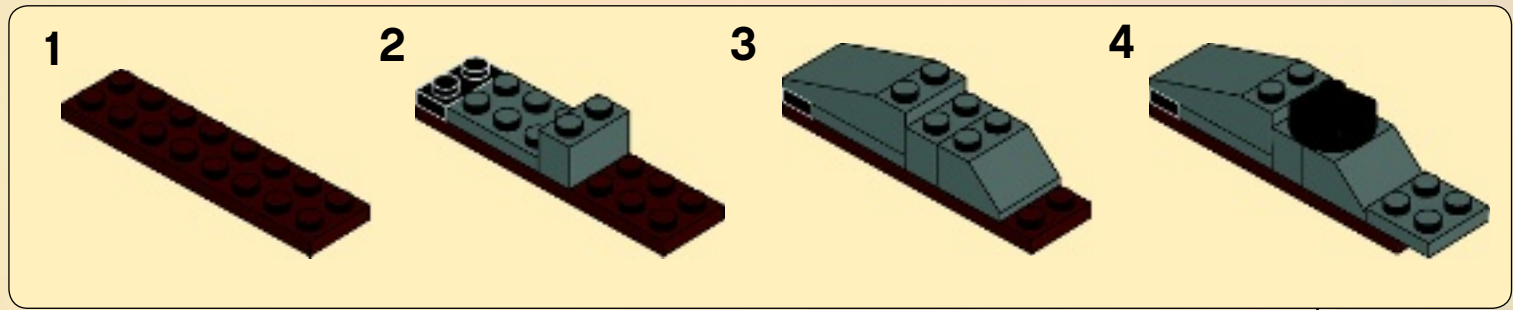
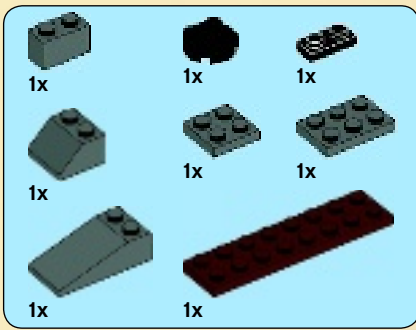

46

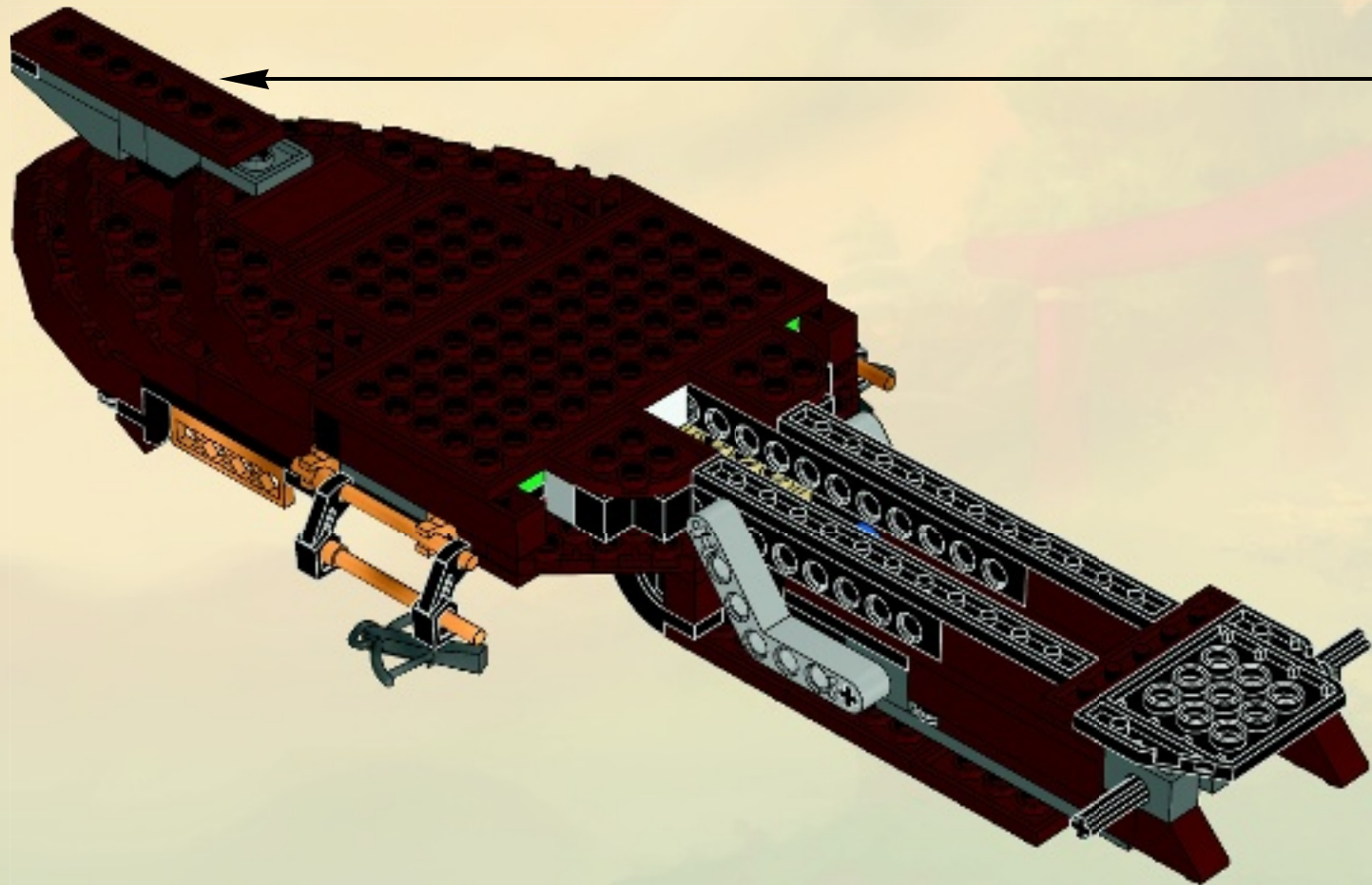
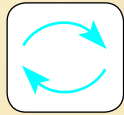

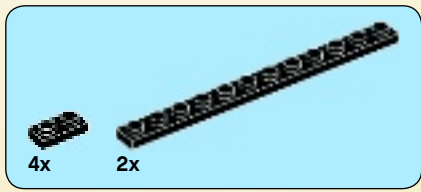

47

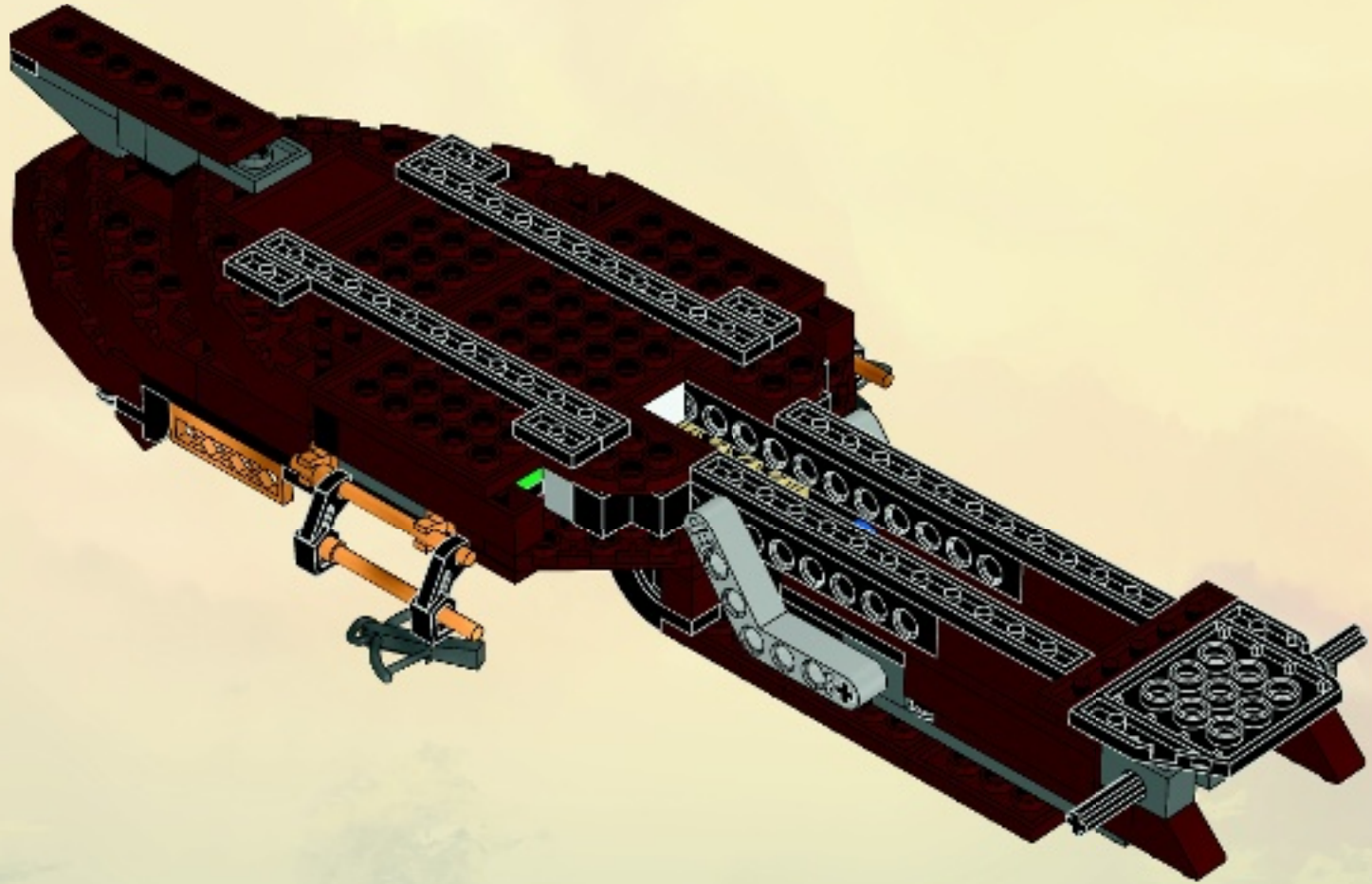



4x

48

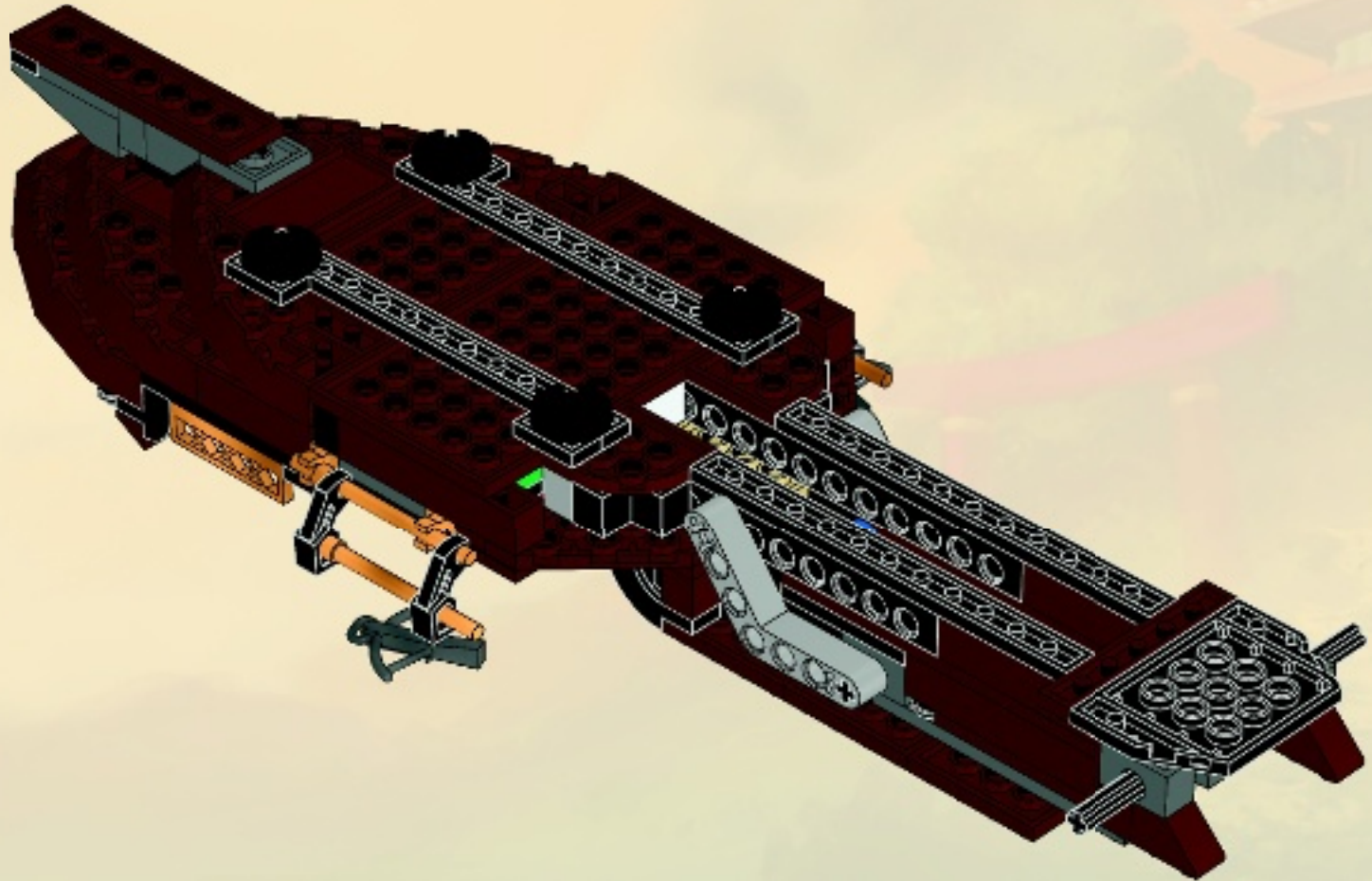



6x

49

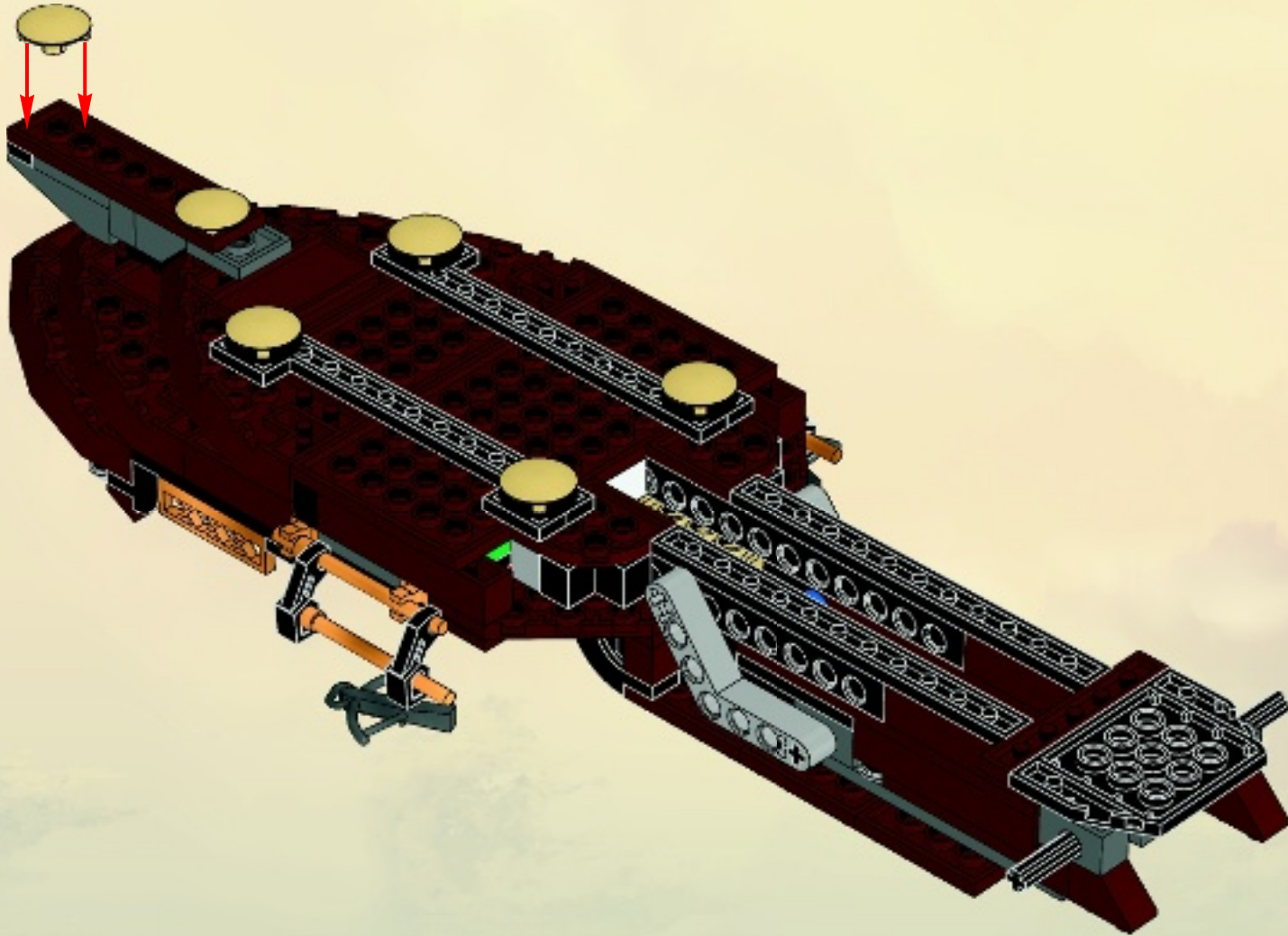

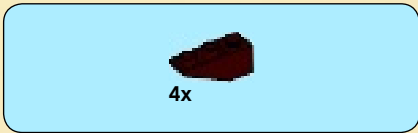

50

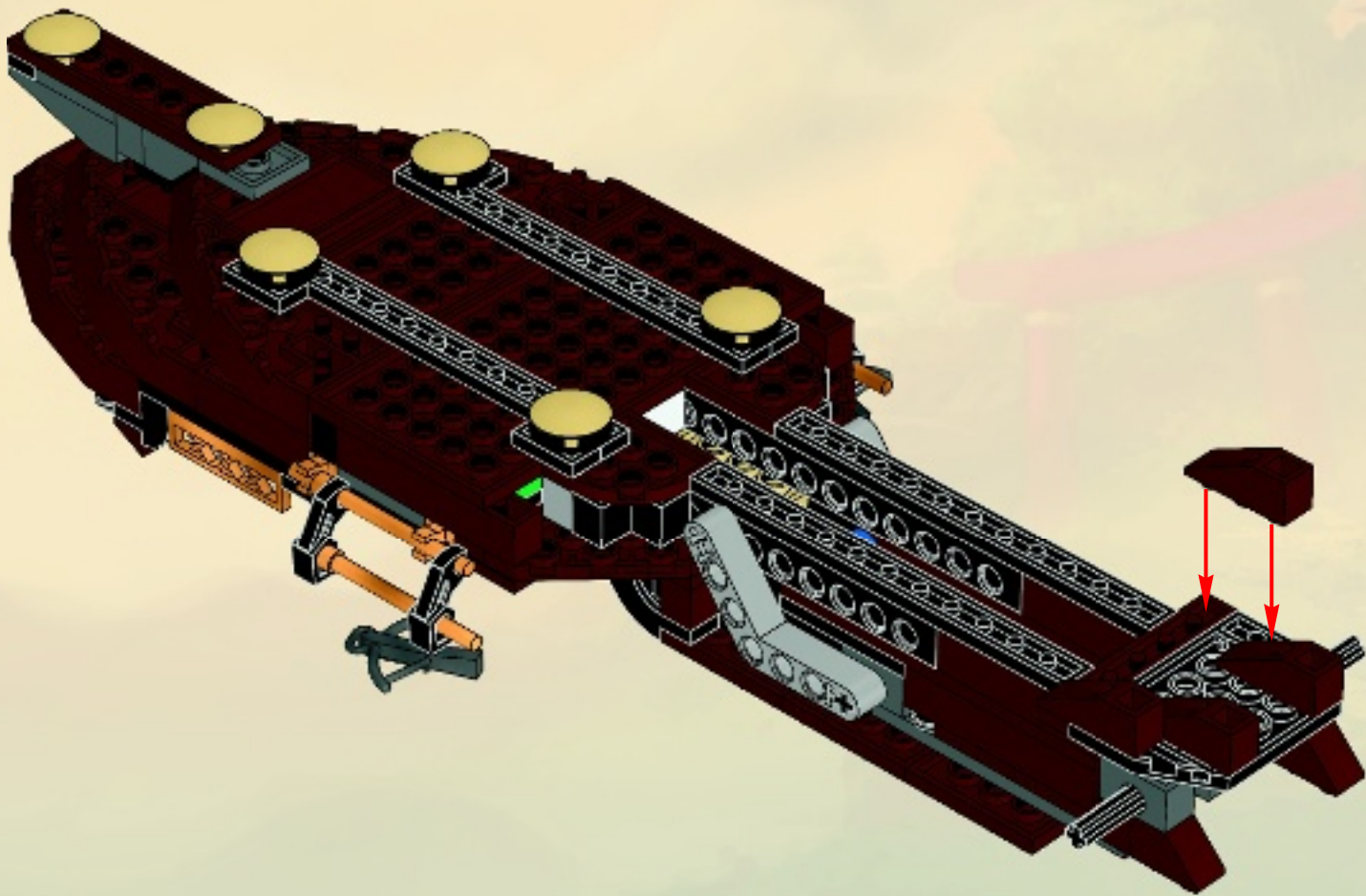

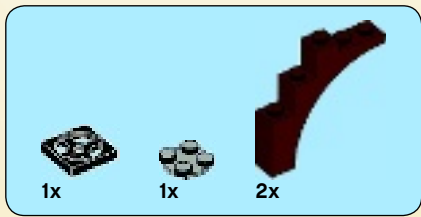

51

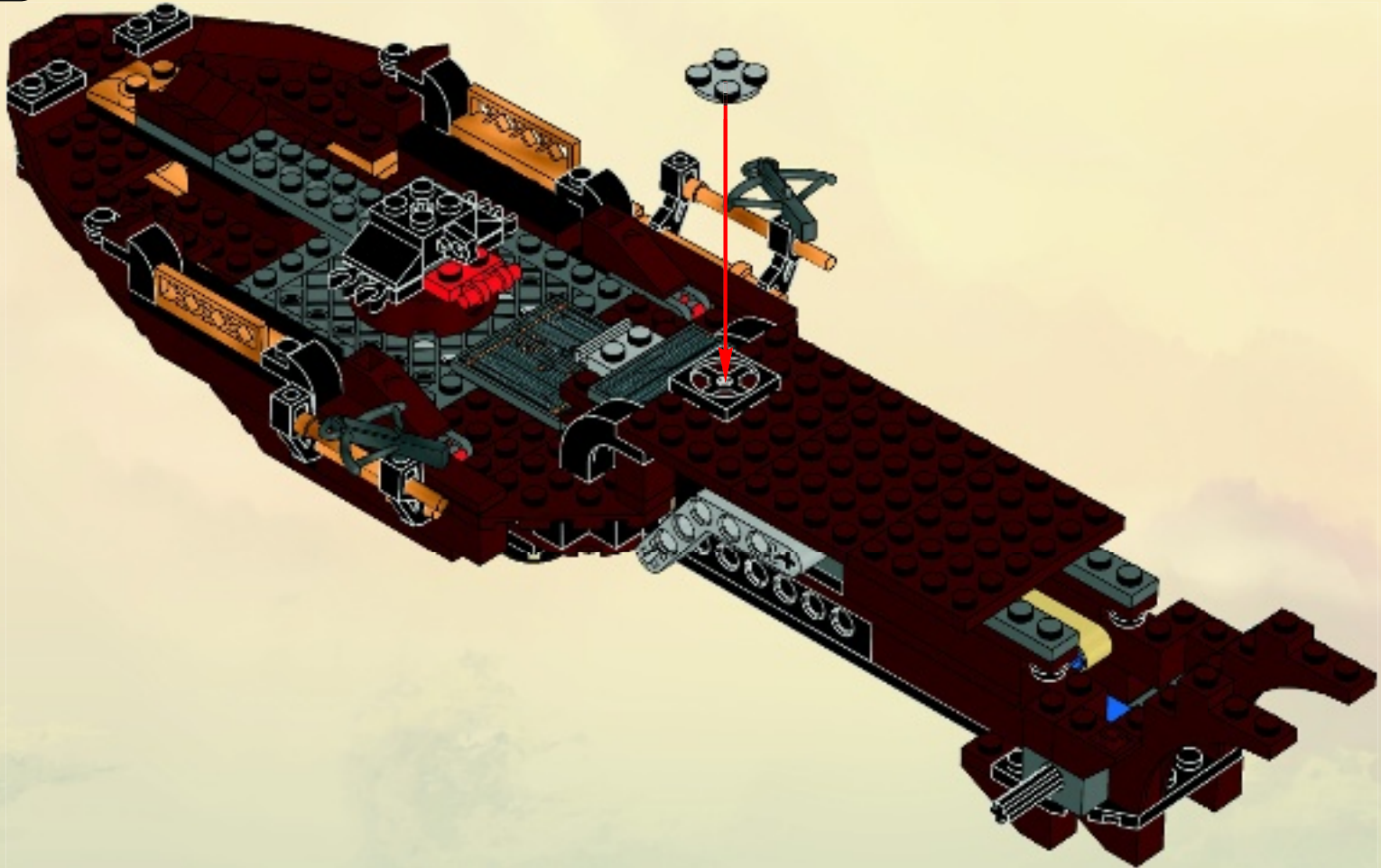

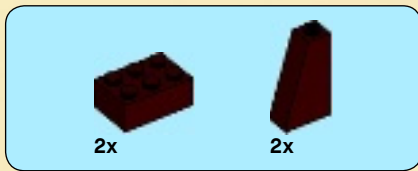

52



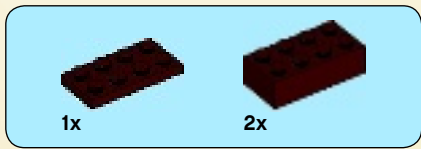

53

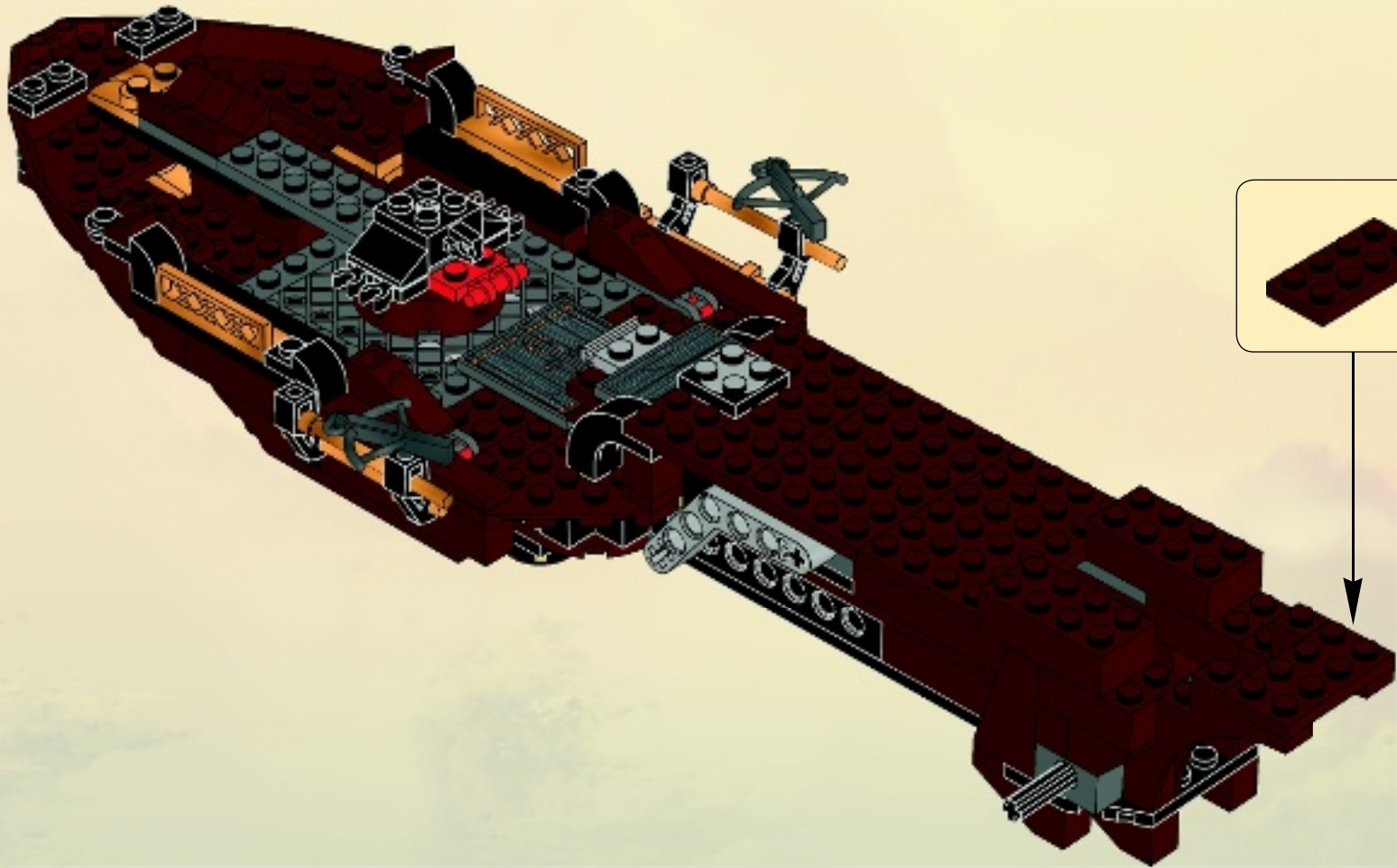

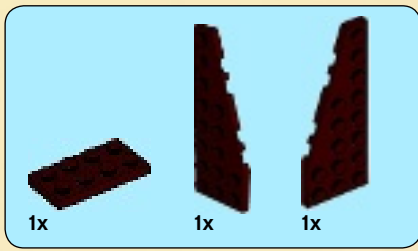

54

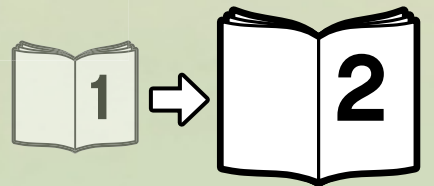
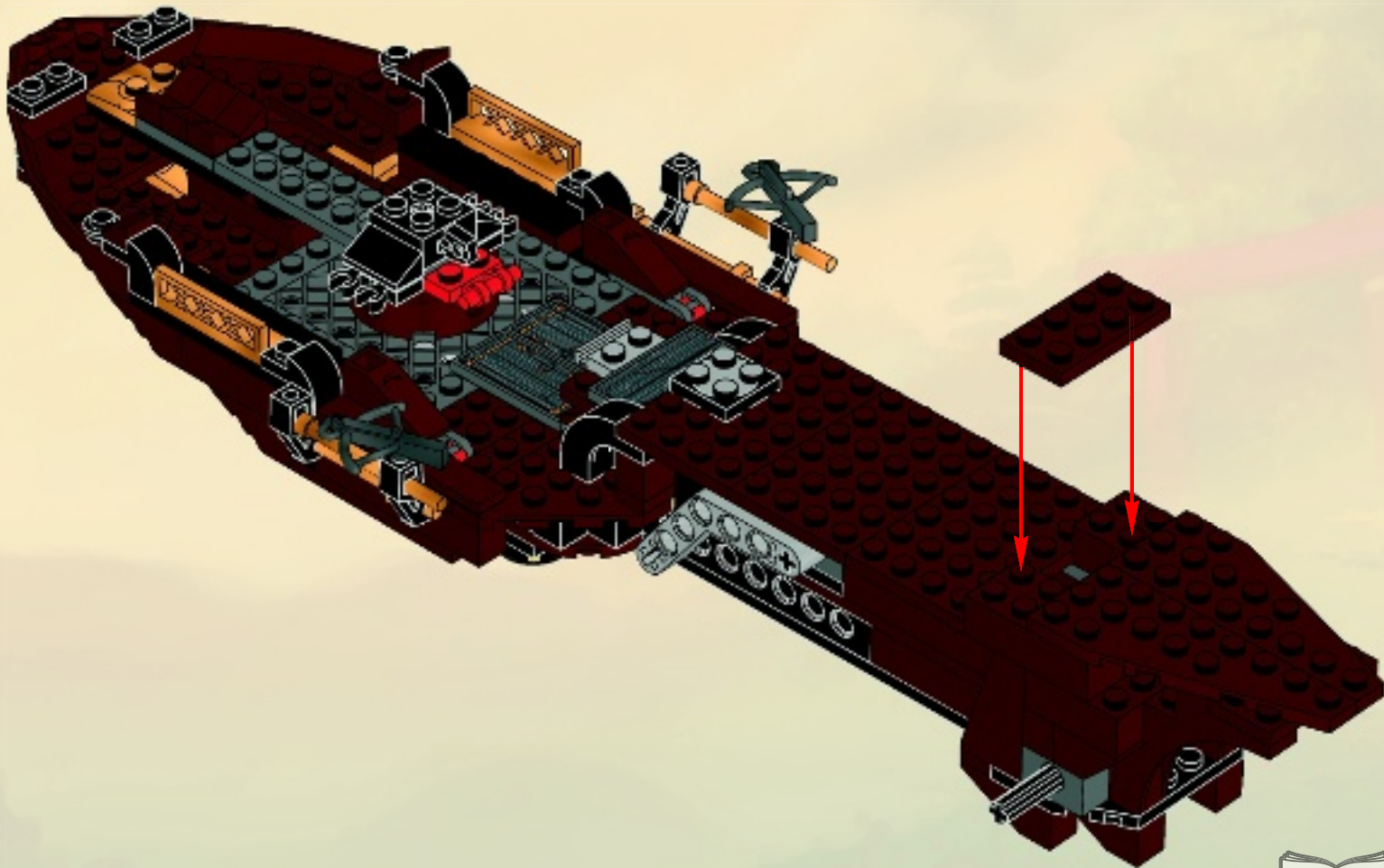

**CUSTOMIZE YOUR SPINNERS
PERSONNALISE TES TOUPIES
PERSONALIZA TUS SPINNERS**

RATTLA

COLE ZX

9579



**ARENA INCLUDED
ARÈNE INCLUSE
ARENA INCLUIDA**



**CUSTOMIZE WITH BOOSTER PACKS
PERSONNALISE GRÂCE AUX
BOOSTERS
PERSONALÍZALO CON PACKS DE
REFUERZO**

NINJAGO.COM

COLE ZX VS RATTLA

LASHA

KENDO ZANE

SNAPPA

SAMURAI X

KAI ZX

FANG-SUEI



9579



9562



9563



9564



9566



9561



9567



NINJAGO

Masters of Spinjitzu



KENDO ZANE
9563 - 9446



KENDO KAI
9558



KENDO COLE
9551



COLE ZX
9579 - 9444



ZANE ZX
9440
9445



JAY ZX
9553
9442
9445



SAMURAI X
9566



LLOYD GARMADON
9552 - 9443



FANG-SUEI
9567 - 9443



FANGDAM
9445



LASHA
9562



RATTLA
9579 - 9441



SNAPPA
9564 - 9442





NINJAGO.COM



NINJAGO

Masters of Spinjitzu



NINJAGO.COM



FREE! GRATIS! GRATUIT!



LEGO® Club Magazine



LEGO® Club Email

VISIT THE WORLD'S
BIGGEST LEGO® SHOP!
www.LEGOshop.com
8076
www.LEGOclub.com

00800 5346 5555
1-866-534-6258 • 1-877-518-5346

* Freephone. Mobile charges may apply. * Numéro sans frais. Des frais peuvent s'appliquer avec les téléphones cellulaires. * Gebührenfrei, Kosten für Anrufe aus Mobilfunknetzen können abweichen. * Gratis telefonnummer vanaf vaste lijn. * Det er et gratis nummer, når du ringer fra fasttelefon. * Det är gratis, när du ringer från en fast telefon. * Numéro sans frais. Des frais peuvent s'appliquer avec les téléphones portables.

YES! I want to join the LEGO® Club FREE! **OUI!** Je veux m'abonner au LEGO® Club GRATUITMENT !

Ja! Ich möchte Mitglied im kostenlosen LEGO® Club werden. **Ja!** Ik wil graag GRATIS lid worden van de LEGO® Club.

Ja! Jeg ønsker å melde meg inn i LEGO® Club gratis! **Ja!** Jag vill gå med i LEGO® Club GRATIS!

First name • Prénom
Vorname • Voornaam
Fornavn • Fornamn

Last name • Nom de famille
Name • Achternaam
Etternavn • Efternavn

Date of Birth • Date de naissance
Geburtsdag • Geboortedatum
Fødselsdato • Fødselsedatum

Street • Adresse
Straße, Hausnr.
Straat, huisnr. •
Adress

City • Ville
Ort • Woonplaats
Poststed • Postort

Zip/Postcode • Code
Postal • PLZ • Postcode •
Postnummer

Email • Courriel •
E-Mail • E-post

Boy • Garçon • Junge •
Jongen Gutt • Pojke

Girl • Fille Mädchen •
Meisje Jente • Flicka

State
Prov.
County

Country
Pays
Land

Fill in your email address and we will send you a membership confirmation and monthly email newsletters. If you do not wish to receive the newsletters please tick here. Remplis ton adresse e-mail et nous t'enversons une confirmation d'adhésion ainsi que le bulletin e-mail mensuel. Si tu ne désires pas recevoir le bulletin, coche cette case. Vul je e-mailadres in en we sturen je een bevestiging van je lidmaatschap en maandelijks e-mail nieuwsbrieven. Als je geen e-mail wilt ontvangen, kruis dan dit vakje aan.

Ich möchte per E-Mail den monatlichen LEGO Club Newsletter erhalten. Ønsker du at vi skal sende en liten hilsen til barnet ditt for å bekrefte medlemskapet, ber vi deg krysse av i feltet, samt oppgi e-postadressen som hilsenen skal sendes til. Om du vill att vi ska skicka en bekräftelse på ditt barns medlemskap, ber vi dig sätta ett kryss i rutan och skriva den e-post adress som bekräftelsen ska skickas till.

If you do not wish to receive additional mailings from the LEGO Club please tick here. Si tu ne désires pas recevoir de courrier supplémentaire du Club LEGO, coche cette case. Als je geen verdere post van de LEGO Club wilt ontvangen, kruis dan dit vakje aan.

Dersom du ønsker å motta annen informasjon fra LEGO Gruppen, setter du et kryss her.

Mail to: / Poster à: **LEGO® Club**
P.O. Box 1157
Enfield, CT USA
06083-1157

Per Post aan: **LEGO® Club**
Postfach 14 15
D-36243 Niederaula

Send til: **LEGO® Club Norge**
Postboks 58
1314 Vøyenenga

Mail to: **LEGO® Club**
33 Bath Road
Slough SL1 3UF
United Kingdom

Stuur op naar: **LEGO® Club**
Postbus 40250
3504 AB Utrecht

Skickas till: **LEGO® Club Sverige**
Ubox 841
202 29 Malmö

Poster à: **LEGO® Club**
21 rue de la banque
75 002 PARIS
FRANCE

The English language version of the magazine can only be mailed to addresses in the US, Canada, the UK, and Republic of Ireland. Club membership is valid for two years and includes free copies of the LEGO Club Magazine and e-mail newsletters. In the US and Canada please allow up to 6 weeks for delivery of your first magazine. In the UK and Republic of Ireland please allow six to 14 weeks for delivery of your first magazine. By signing this form you consent the LEGO Club to use your child's data for LEGO mailings. The data will only be used for LEGO mailings and will not be sold, rented or otherwise disclosed to any company outside the LEGO Company except for disclosure to companies acting as our agents to help us provide services requested by the child. This coupon is valid for one free membership per person, group or organization. Photocopied coupons are accepted. La version française du magazine peut être postée uniquement au Canada. L'abonnement est valide pour 2 ans et inclut des exemplaires gratuits du Magazine LEGO, Aux É-U, et au Canada, alouer 6 semaines pour la livraison initiale. En remplissant ce formulaire, vous consentez à ce que LEGO utilise les informations de votre enfant pour des envois postaux de LEGO. L'information sera utilisée uniquement pour des envois postaux par LEGO et ne sera en aucun cas, vendue, louée, échangée ou divulguée à d'autres compagnies autres que la compagnie LEGO, à l'exception des compagnies affiliées qui nous procurent des services auxquels l'enfant en a fait la demande. Formulaires photocopiés acceptés. Mit der folgenden Unterschrift erkläre ich, für mein Kind den Beitritt als Mitglied zum kostenlosen LEGO Club, der von der LEGO GmbH, D-85627 Grasbrunn, betrieben wird. Die Mitgliedschaft beinhaltet die Zusendung des LEGO Club Magazins und kann beiderseits jederzeit beendet werden. Mit der Mitgliedschaft in LEGO Club sind keinerlei Verpflichtungen verbunden. Das deutschsprachige LEGO Club Magazin wird nur an Adressen in Deutschland, Österreich und der Schweiz versendet. Eine Anmeldebestätigung kann nur per E-Mail geschickt werden. Das Magazin erscheint fünfmal jährlich. Daher kann die Zustellung des ersten Heftes bis zu drei Monate dauern. Die Mitgliedschaft ist beiderseitig jederzeit kündbar, ohne dass Ihnen Kosten entstehen. Sie können der werblichen Nutzung Ihrer Daten jederzeit widersprechen, Kündigung und Widerspruch können Sie telefonisch erklären (00800 / 5346 5555, Anruf gebührenfrei, Kosten für Anrufe aus dem Mobilfunknetz können abweichen) oder an die LEGO GmbH senden. Het Nederlandse LEGO Club Magazine kan alleen worden gestuurd naar adressen in Nederland. Het lidmaatschap is 2 jaar geldig en geeft recht op toezending van het gratis LEGO Club Magazine en LEGO Club e-mails. Het eerste magazine zal binnen 12 tot 14 weken toegestuurd worden. Het lidmaatschap kan op ieder moment opgezegd worden en kan na 2 jaar gratis worden verlengd, tenzij LEGO met deze activiteit stopt. Uw gegevens worden uitsluitend gebruikt voor mailings van LEGO en zullen niet worden verkocht, verhuurd of op welke wijze dan ook verstrekt aan derden buiten de LEGO Groep, uitgezonderd de organisaties die namens ons optreden om de informatie te sturen waarvoor toestemming is verleend. Den norske utgaven av magasinet sendes kun til adresser i Norge. Medlemskap i klubben gjelder i 2 år og inkluderer gratisutgaver av LEGO Club Magazine. Pæren minimum opp til seks uker leveringstid for første magasin. Ved å undertegne dette skjemaet, gir du ditt samtykke til at LEGO Club kan bruke opplysningene om barnet ditt i LEGO forsendelser. Dataene vil utelukkende bli brukt i LEGO forsendelser og vil ikke bli solgt, utleied eller på annen måte gjøres tilgjengelig for selskaper utenfor LEGO gruppen, unntatt selskaper som er våre agenter og som hjelper oss å tilby tjenestene barnet etter spør. Dette skjemaet gjelder for ett gratis medlemskap per person, gruppe eller organisasjon. Den svenska versionen av tidningen kan endast skickas till adresser i Sverige. Club-medlemskapet är giltigt i 2 år och innefattar gratis exemplar av LEGO Club Magazine. Vänligen räkna med minimum 6 veckor för leverans av din första tidning. Genom att skicka in det här formuläret godkänner du att LEGO Club använder barnets uppgifter för LEGO utskick. Uppgifterna kommer bara att användas för LEGO utskick och kommer inte att säljas, hyras ut vidarebefordras till något företag som inte tillhör LEGO Gruppen, med undantag av företag som agerar som våra ombud för att tillhandahålla tjänster som barnet har begärt. Den här kupongen gäller för ett gratis medlemskap per person, grupp eller organisation. En français, le magazine LEGO Club Magazine est envoyé gratuitement par courrier. Ces données seront uniquement utilisées pour l'envoi d'information concernant LEGO et ne seront ni vendues, ni louées, ni utilisées par d'autres sociétés que le groupe LEGO, à l'exception des sociétés agissant pour le compte de LEGO en tant que sous-traitant de services divers. L'abonnement au LEGO Club est valable pour une période de 2 ans. Il inclut l'envoi par courrier du magazine LEGO Club et par email des newsletters. Un délai de 6 à 14 semaines est à prévoir pour la réception de votre premier magazine. Ce bulletin d'adhésion est valable pour l'inscription d'une seule personne. Les photocopies sont acceptées. ATTENTION! Le bulletin d'adhésion doit être rempli et signé par un parent ou un tuteur.

Parent's signature • Signature d'un parent ou d'un tuteur
• Unterschrift / **Eziehungsberechtigte/r • Handtekening ouders**
• Foreldres/foresattes underskrift • Förälders /förmyndares underskrift

Date
Datum
Dato