



STAR WARS



7930



1

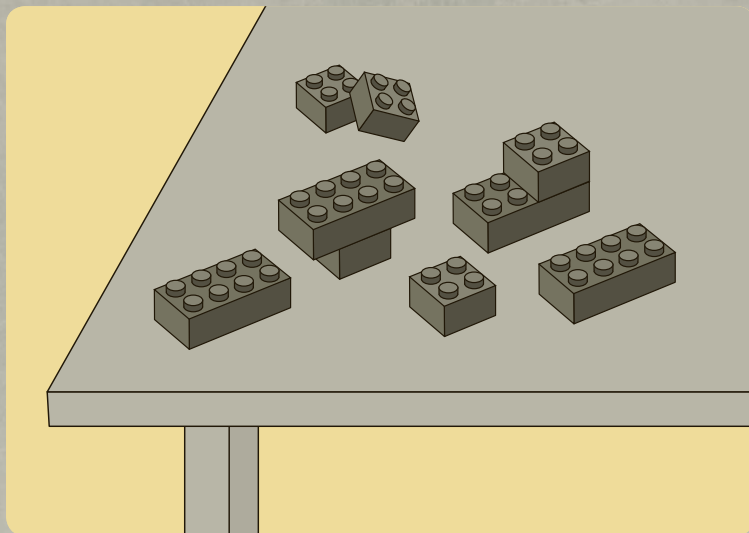
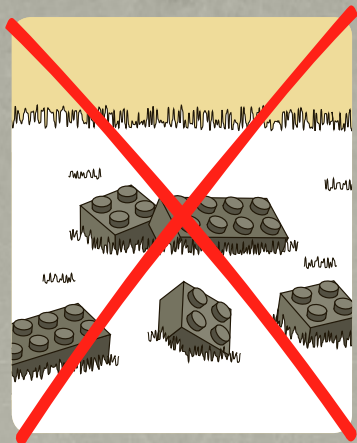

2





1



2

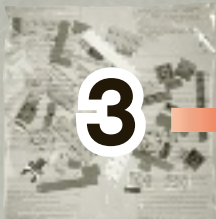
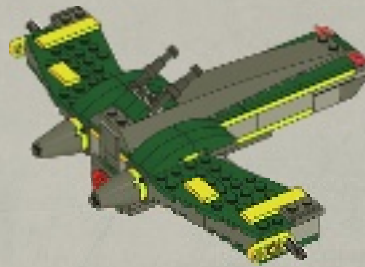
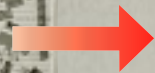

3

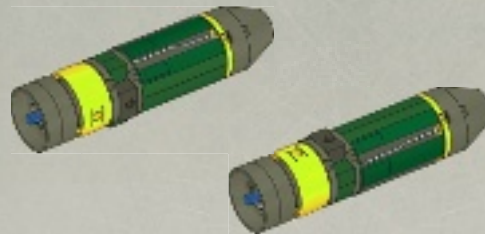
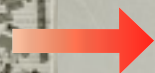

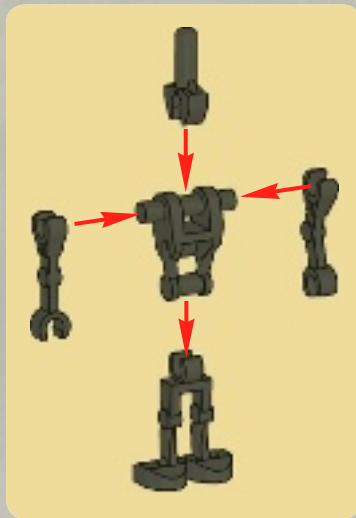



1

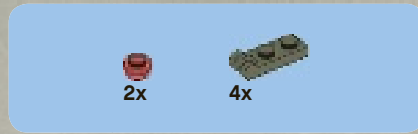
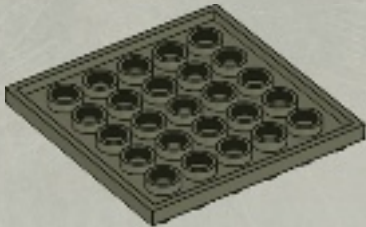

2



3

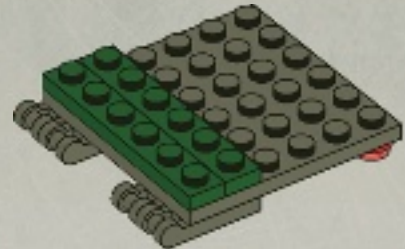



2x

4

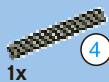
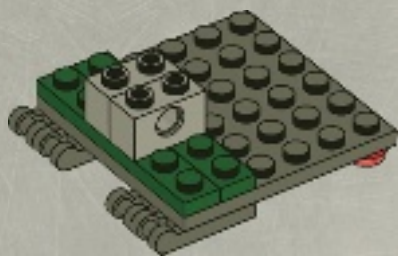

1x

4



2x

5

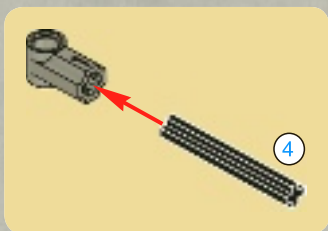

4

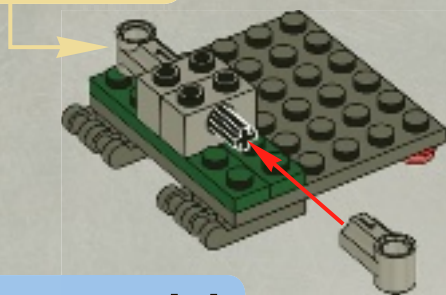

4

1:1

6



1x



2x

6

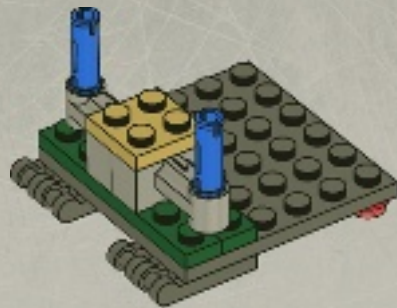

2x



1x



1x

7

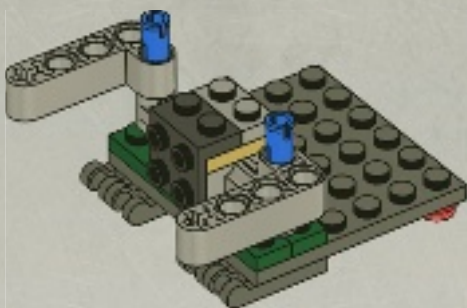

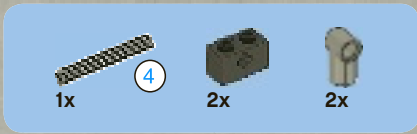

8

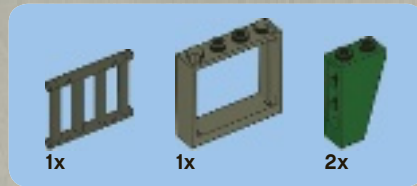
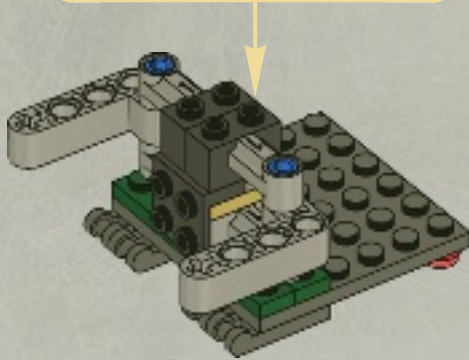
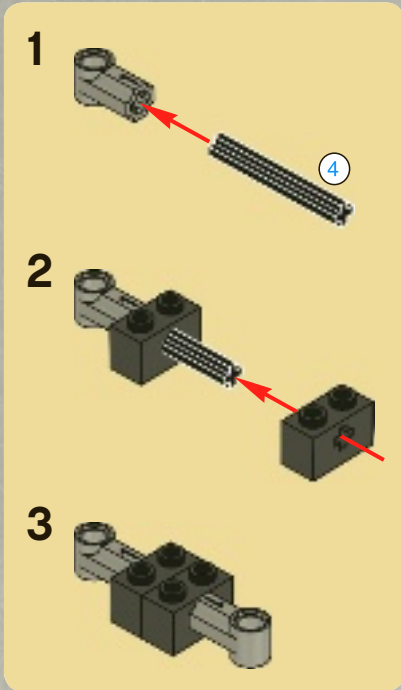

9

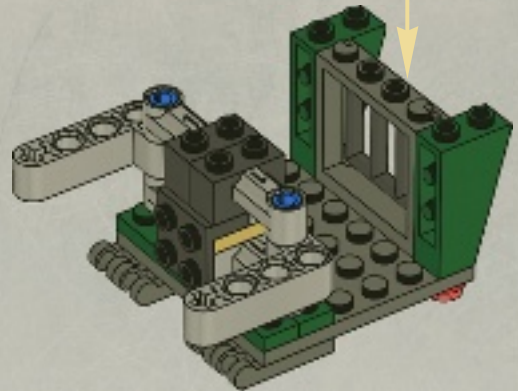
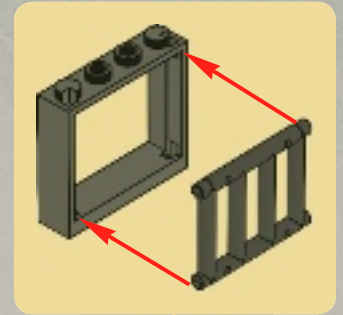

1:1

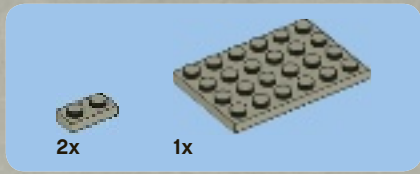

10

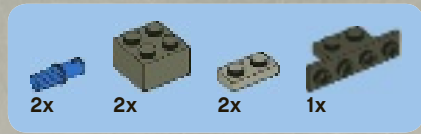
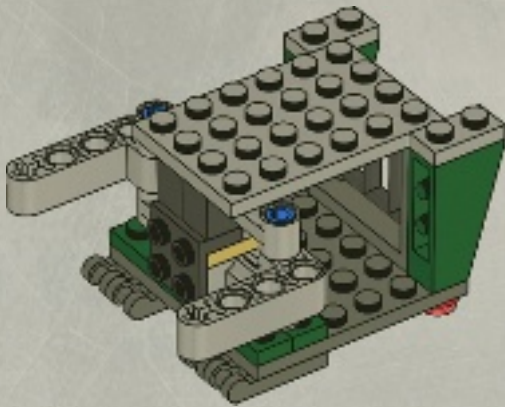

11

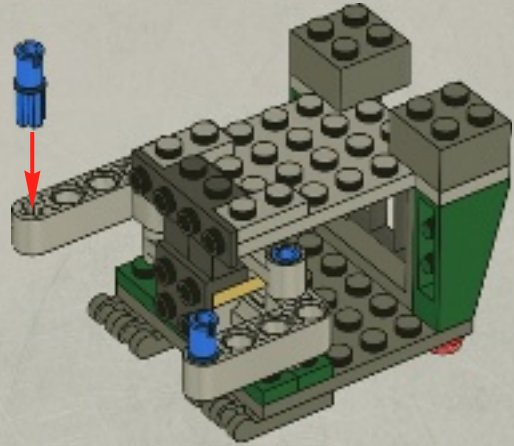



2x



2x

12

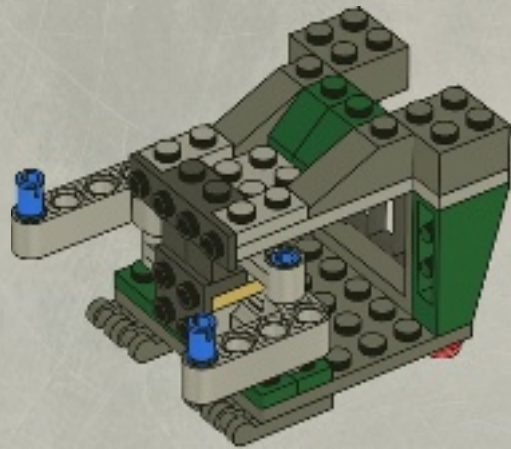

1x

13

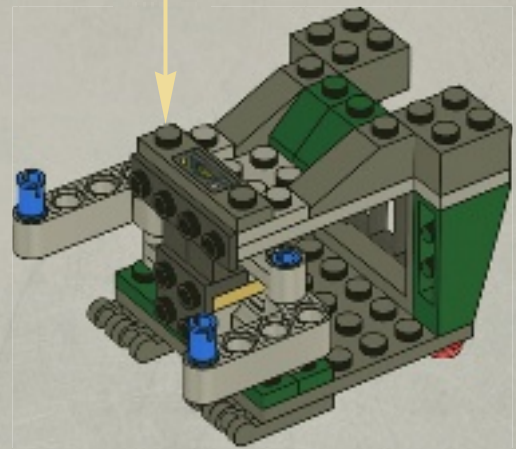
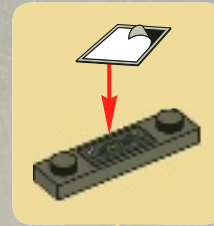



14

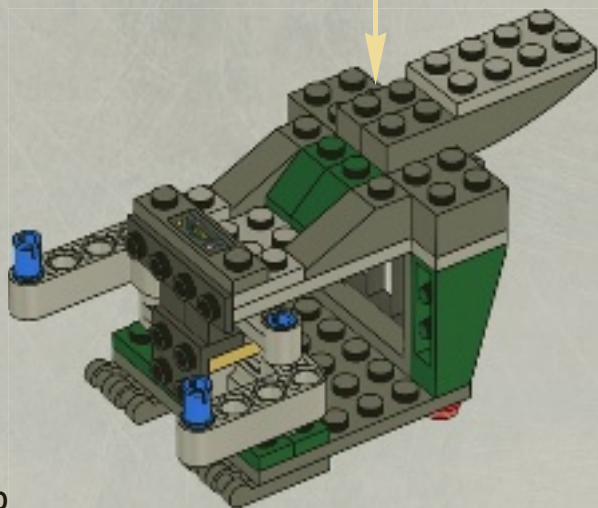
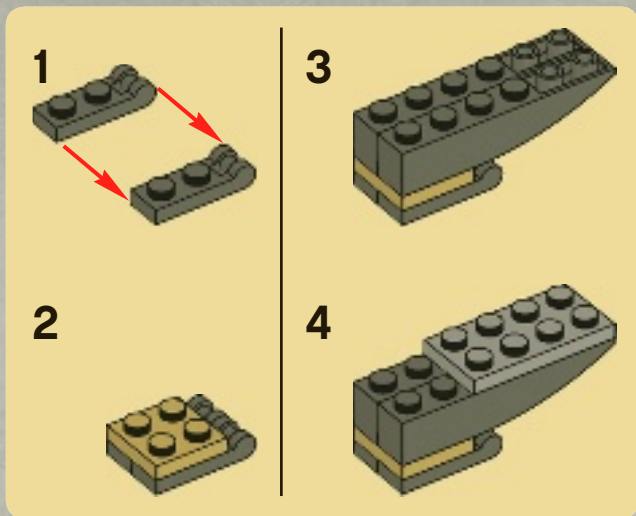

15

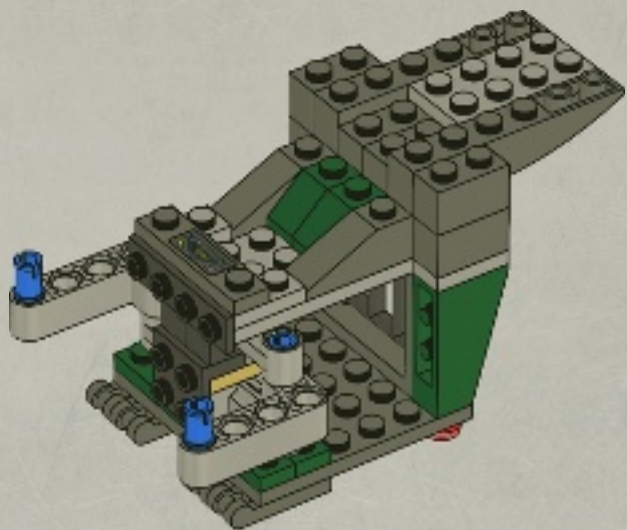



2x

2x

16

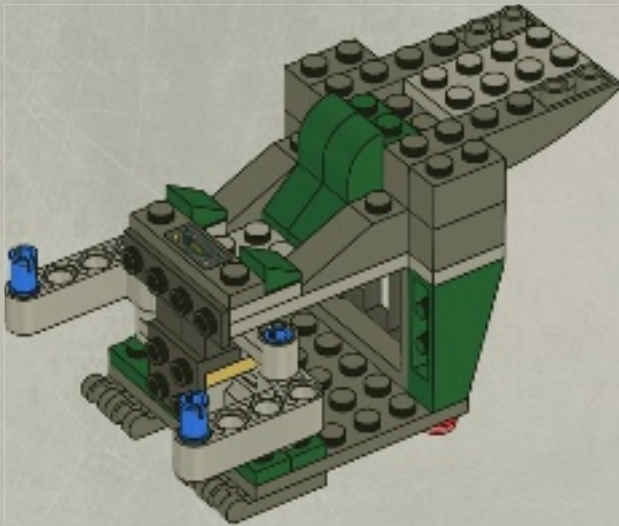

2x



4x



1x

17

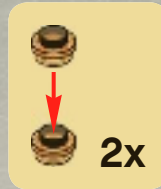

2x

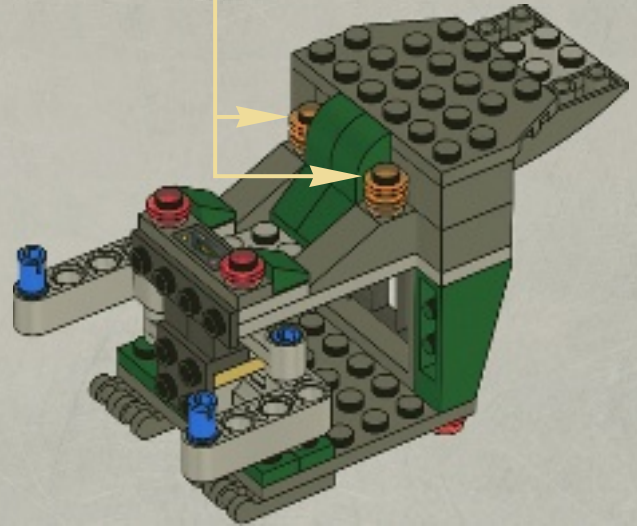

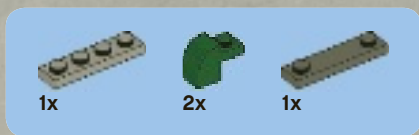

18

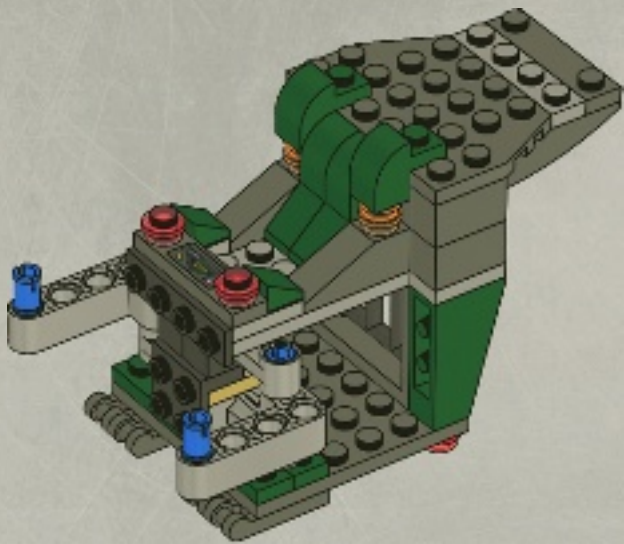

19

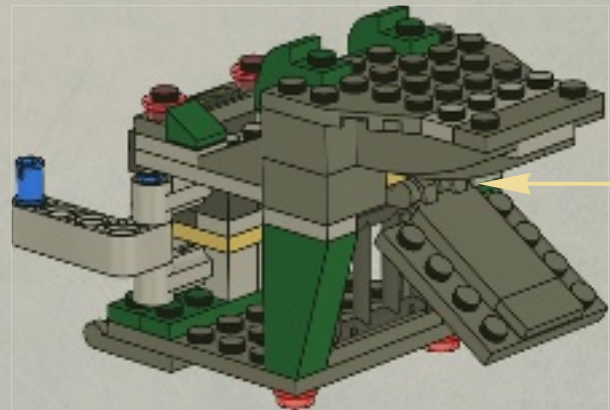
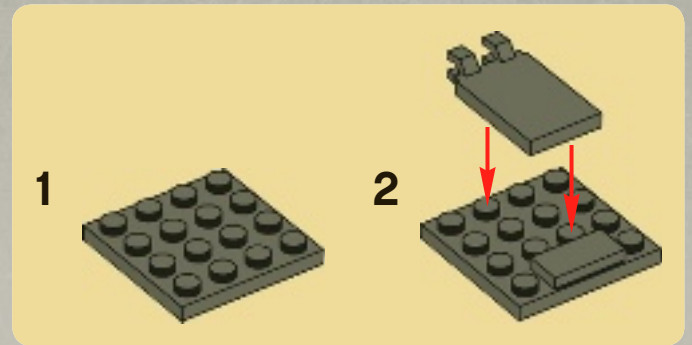



2x



2x



2x

20

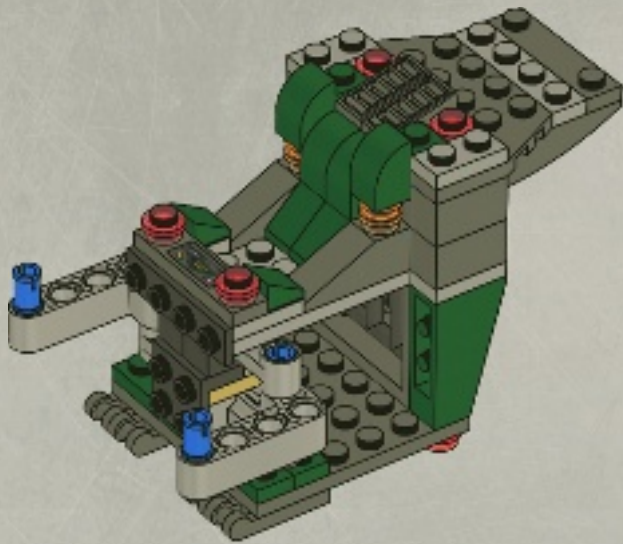

1x



2x



1x

21

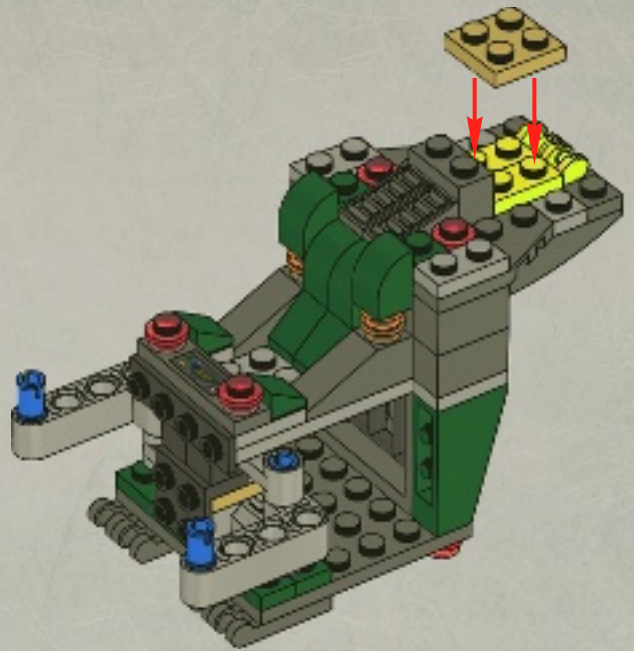



22

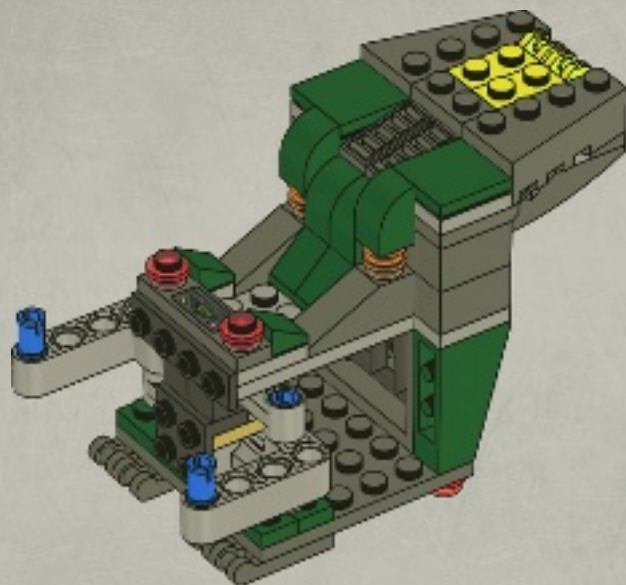



23

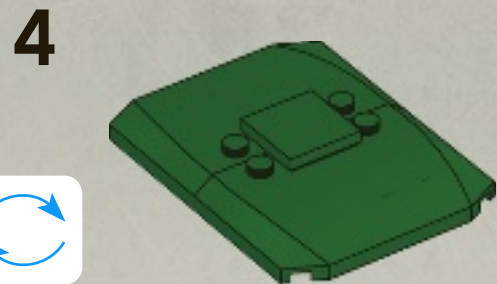
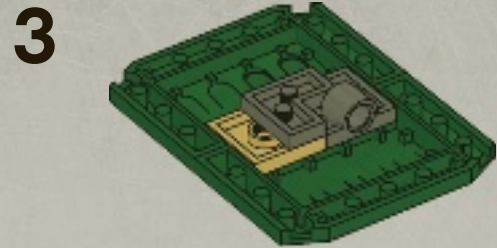
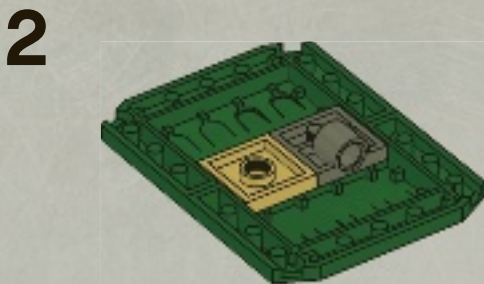
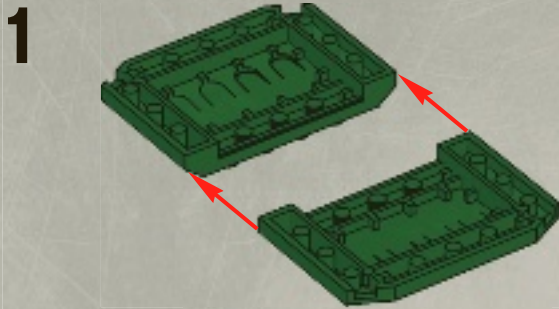

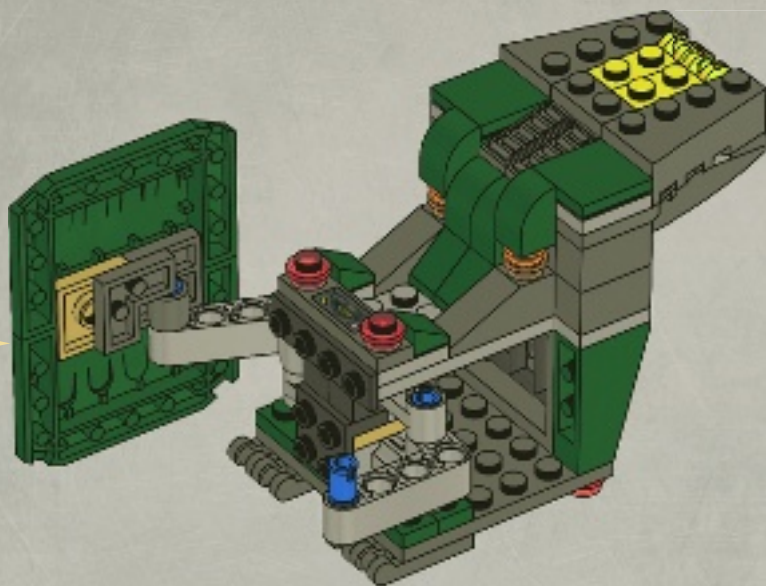



24

1

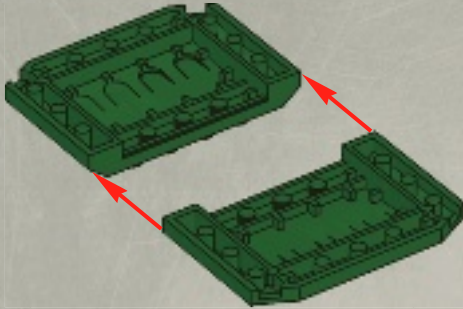

2



3

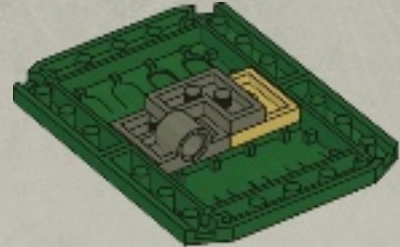

4

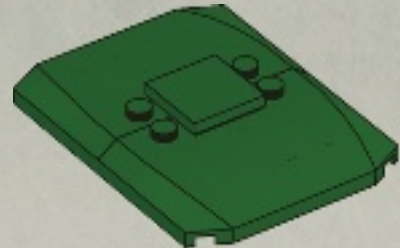

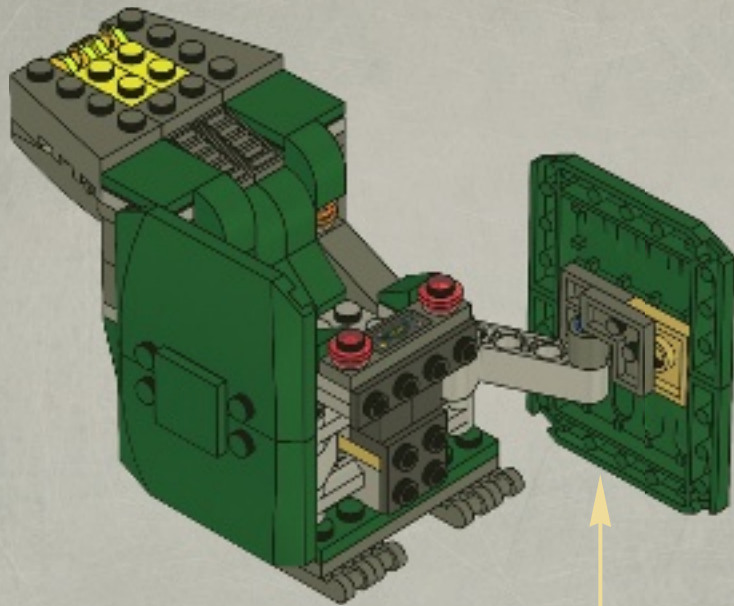



2x

1

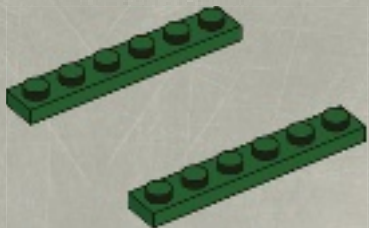

1x

2

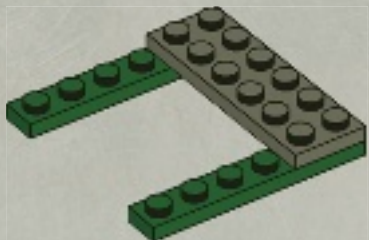

1x



2x

3

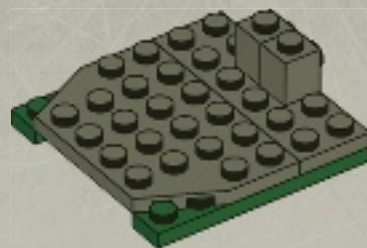

1x



1x

4

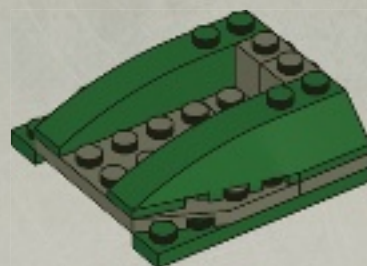



5

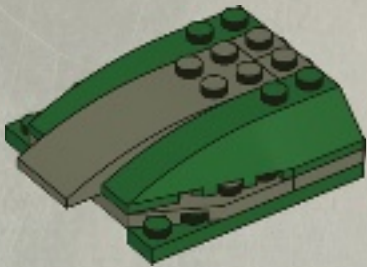

25

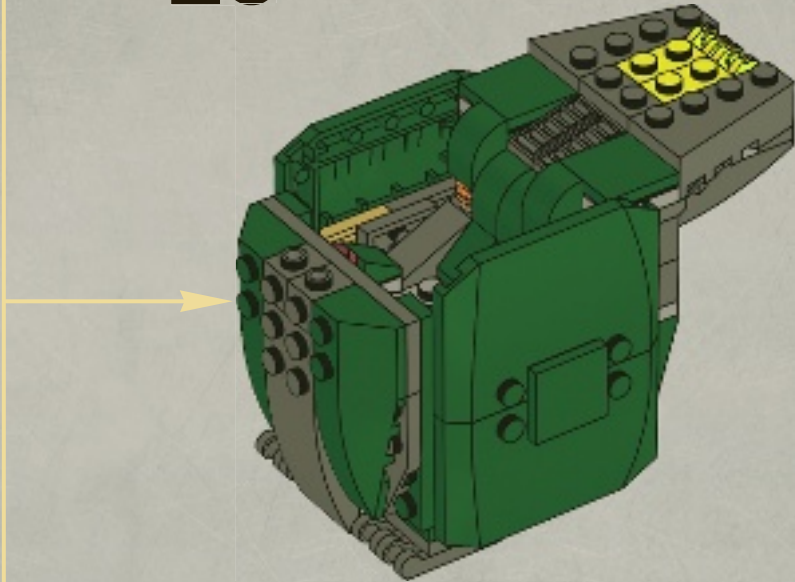

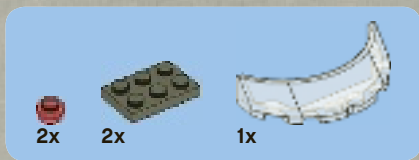

26

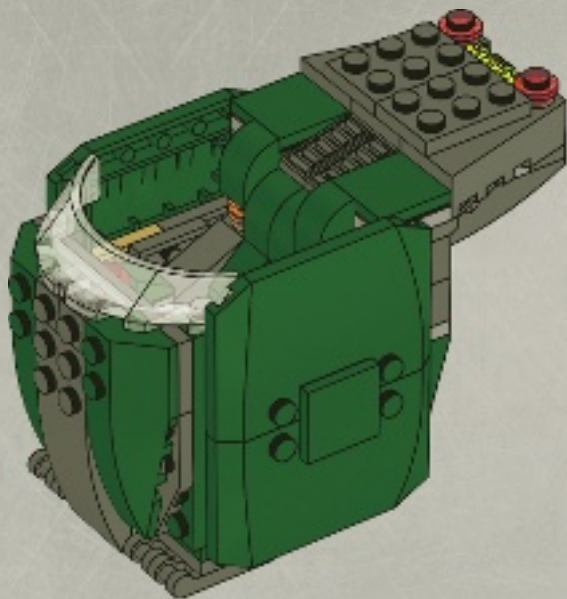

27

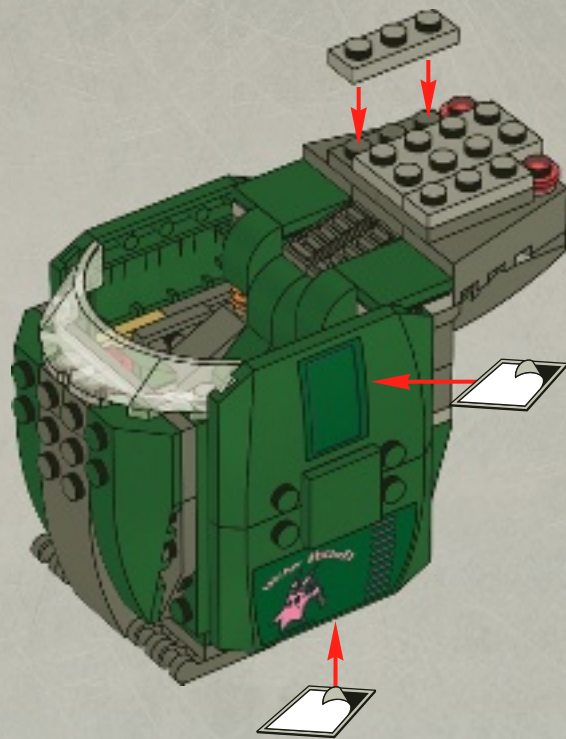



1x



1x

28

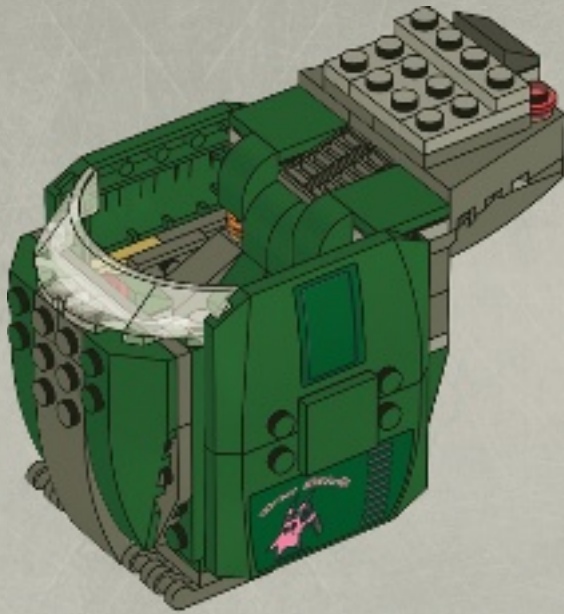

1x



1x



2x

29

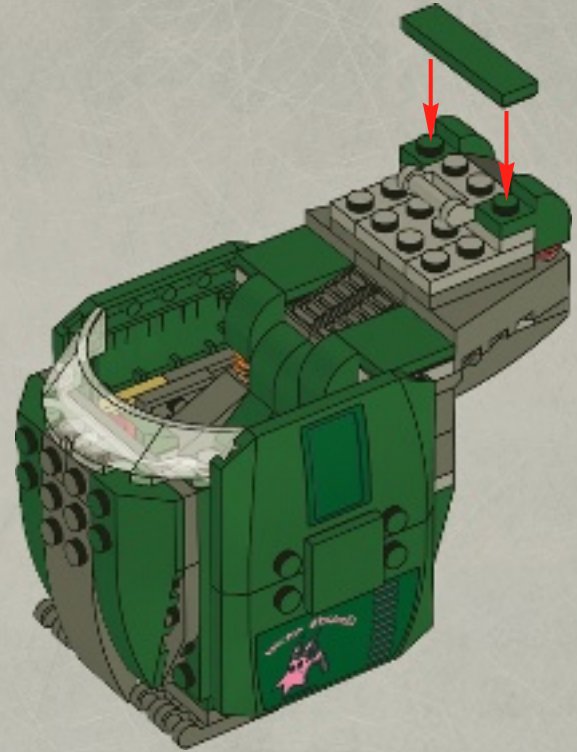



2x



4x



4x

30

1



2

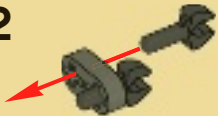

3



2x

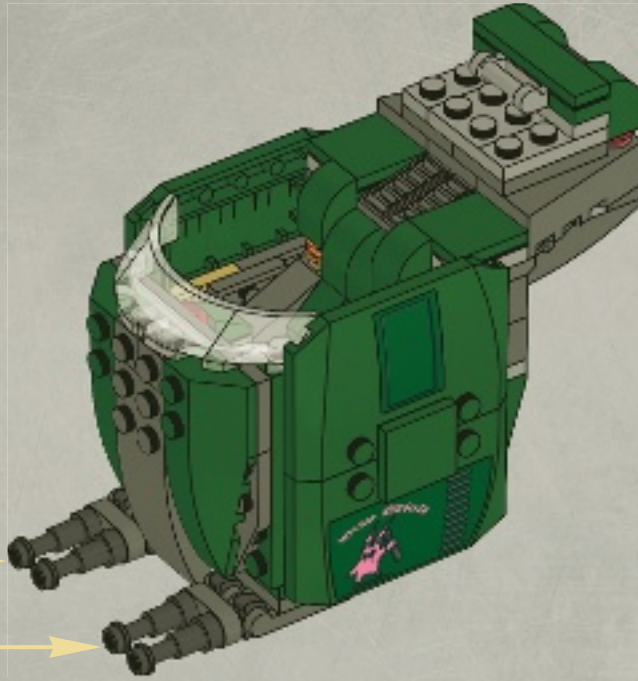

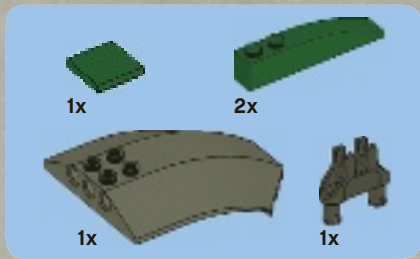

31

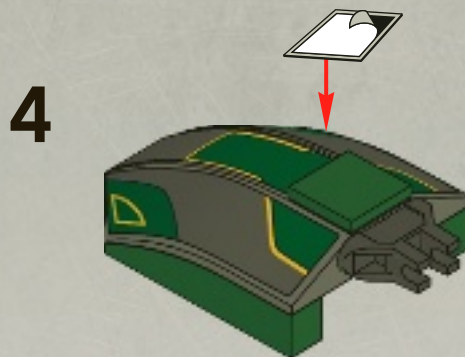
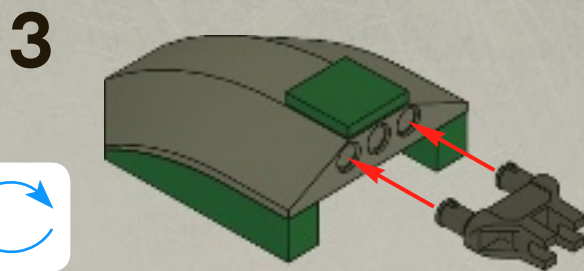
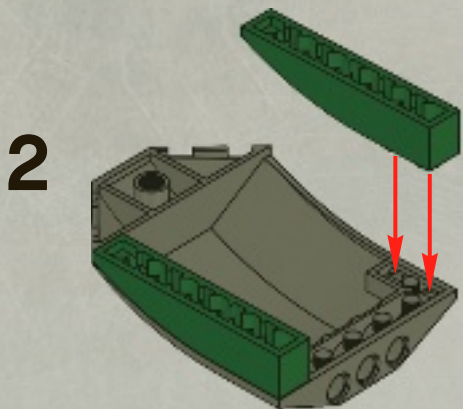

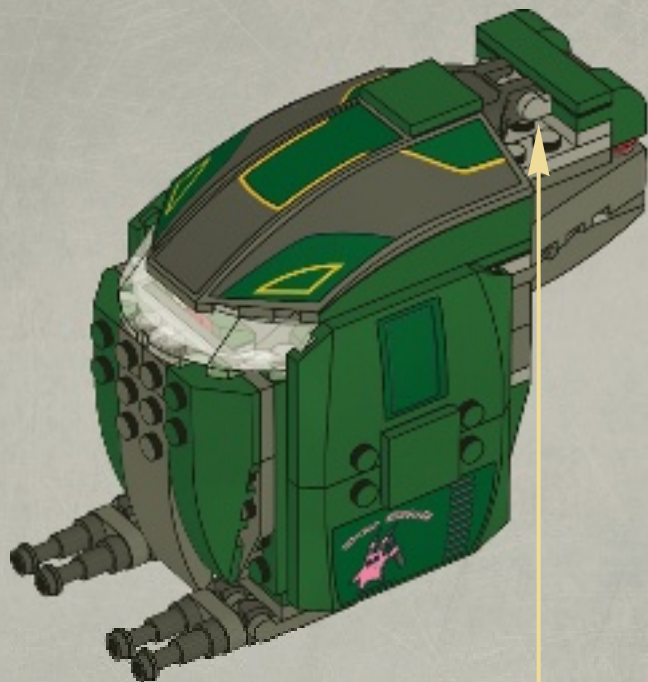

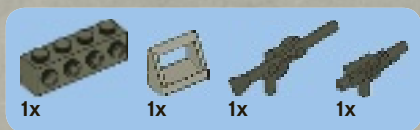

32

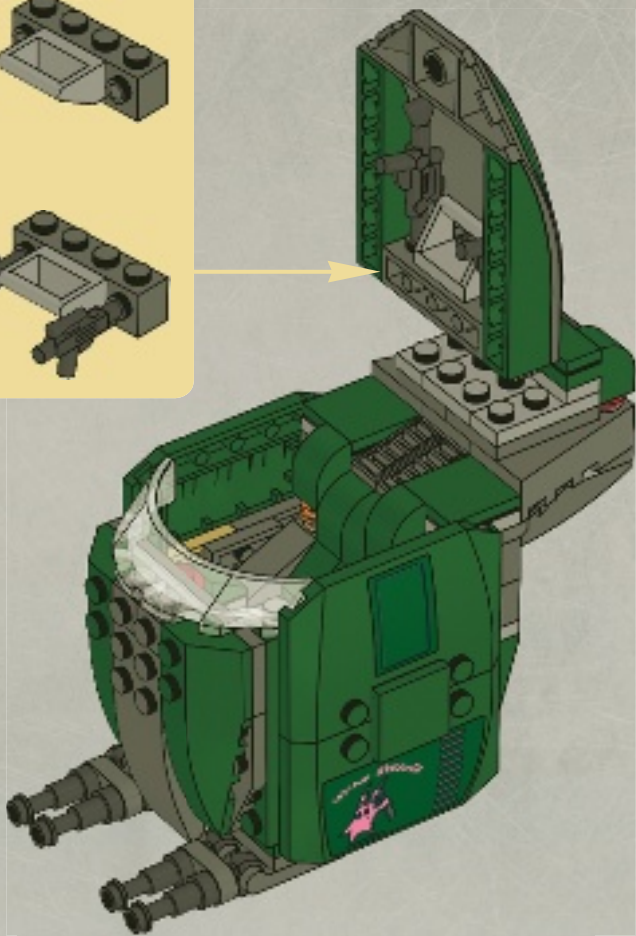
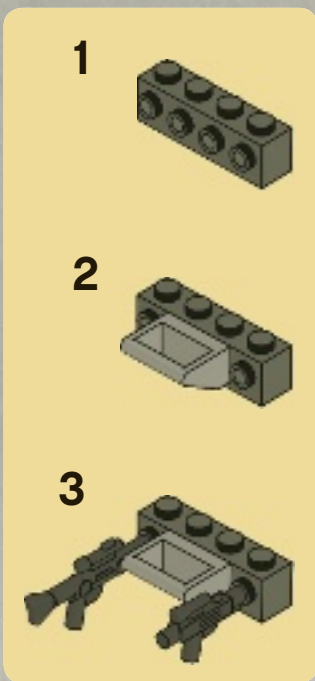

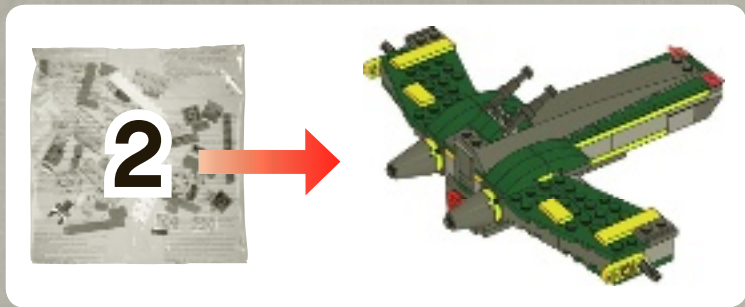

1

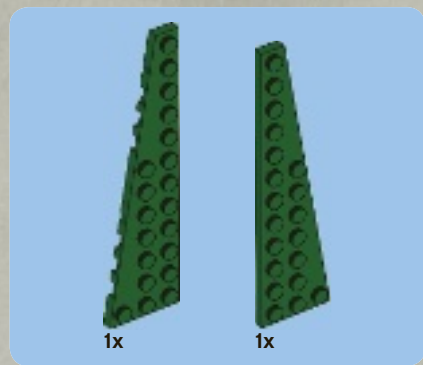

2

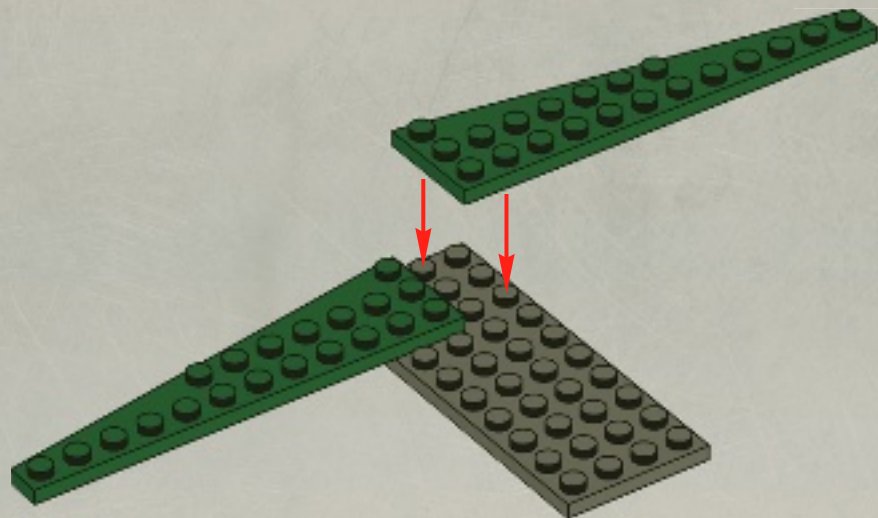

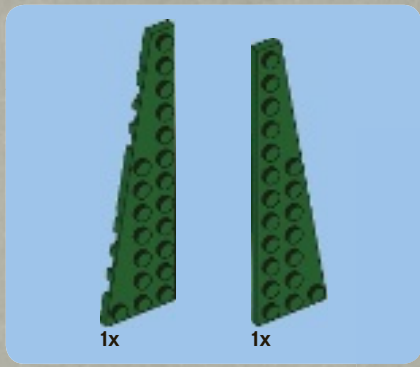

3

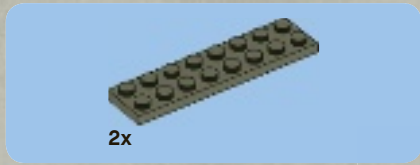
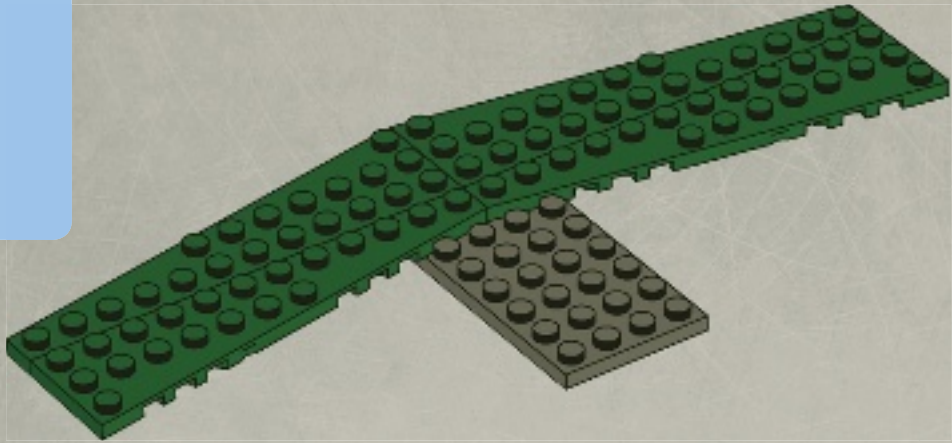

4

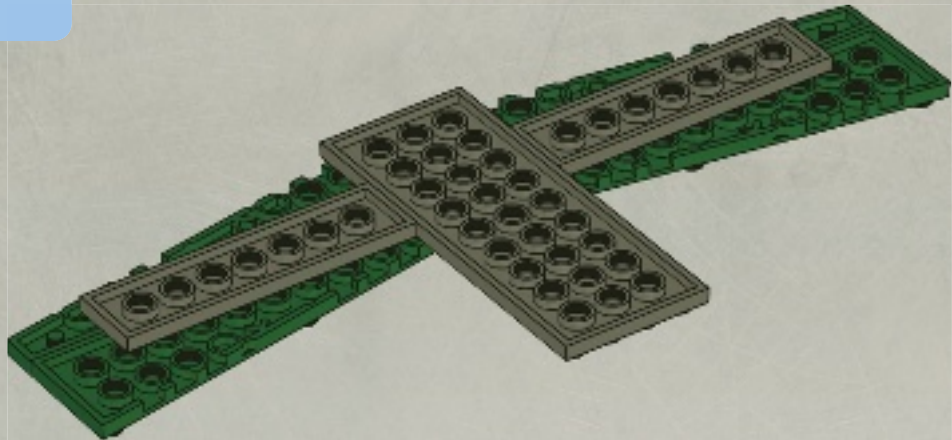



2x



1x



1x

5

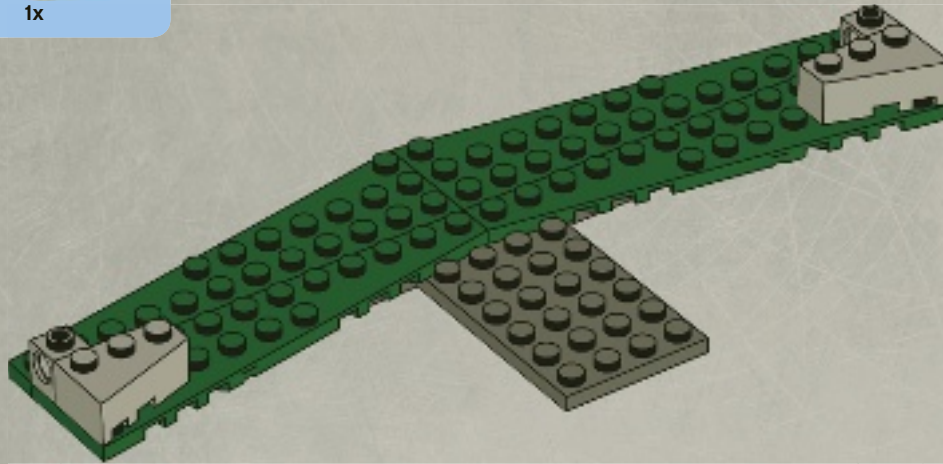

2x



2x



2x

6

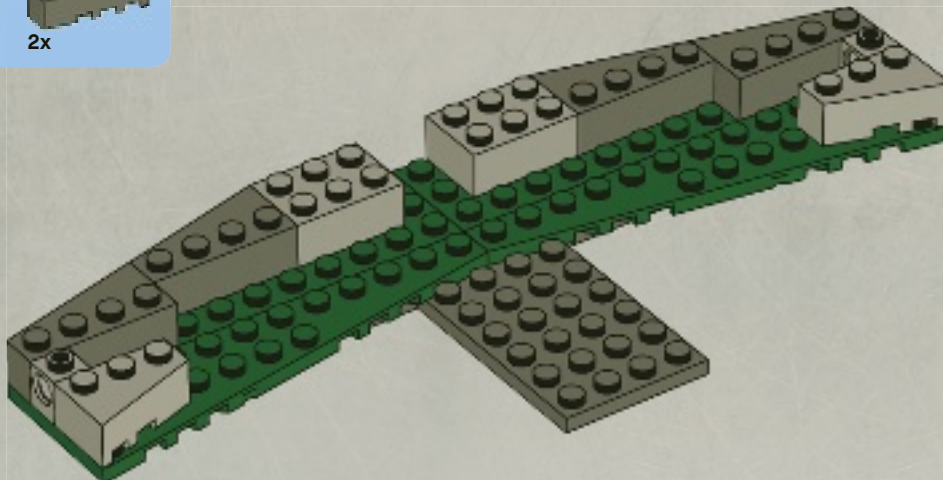



2x



1x

7

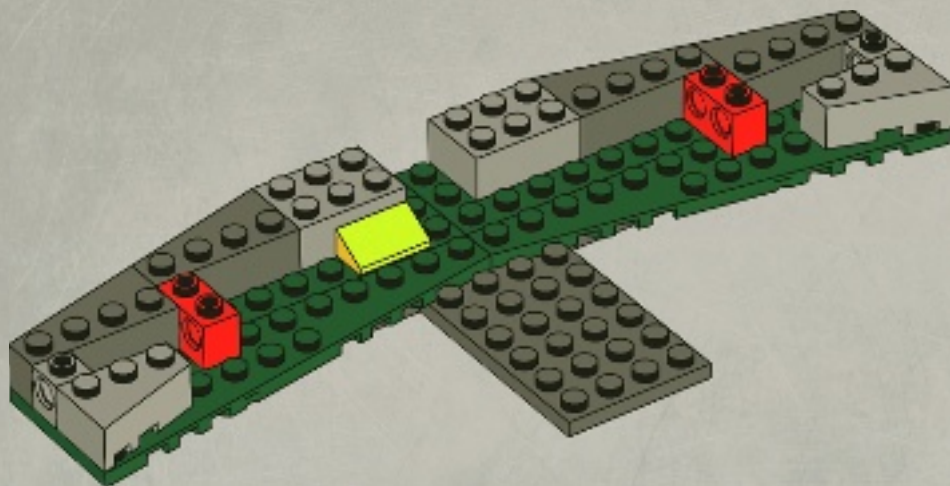

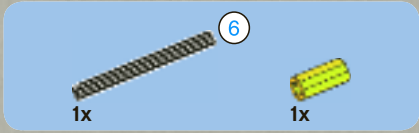

1

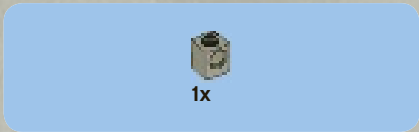
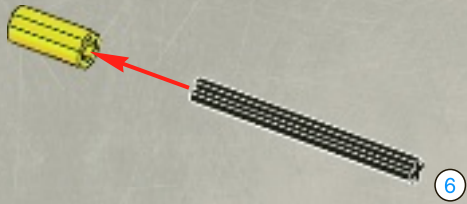

2

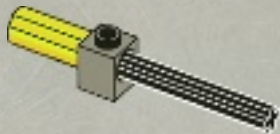

3

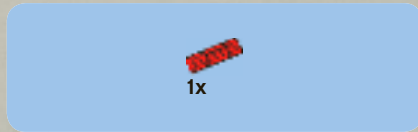
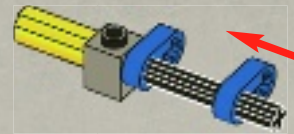

4

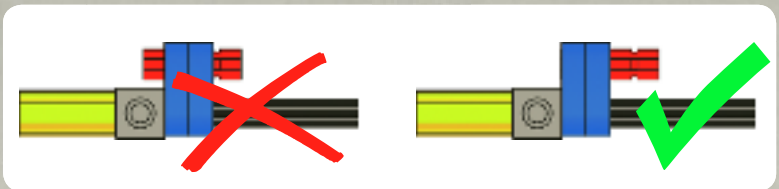
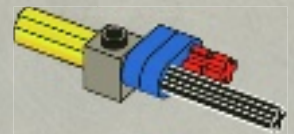



1x

5



1x



1x

6

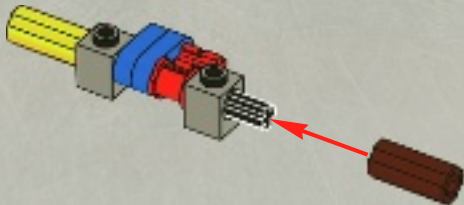

2x

3



3

1:1

7

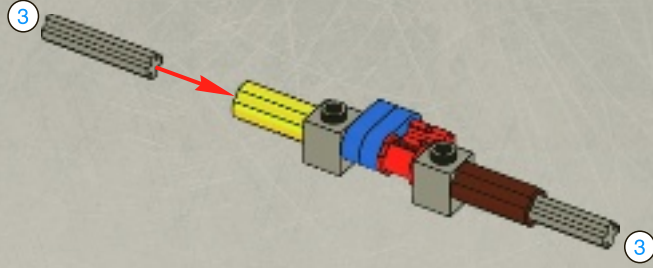

2x

8

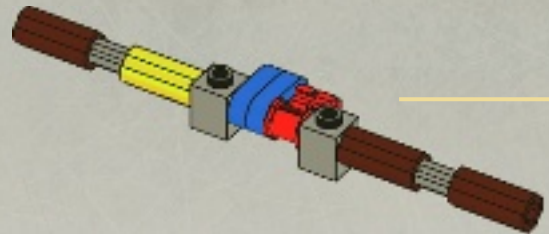



8

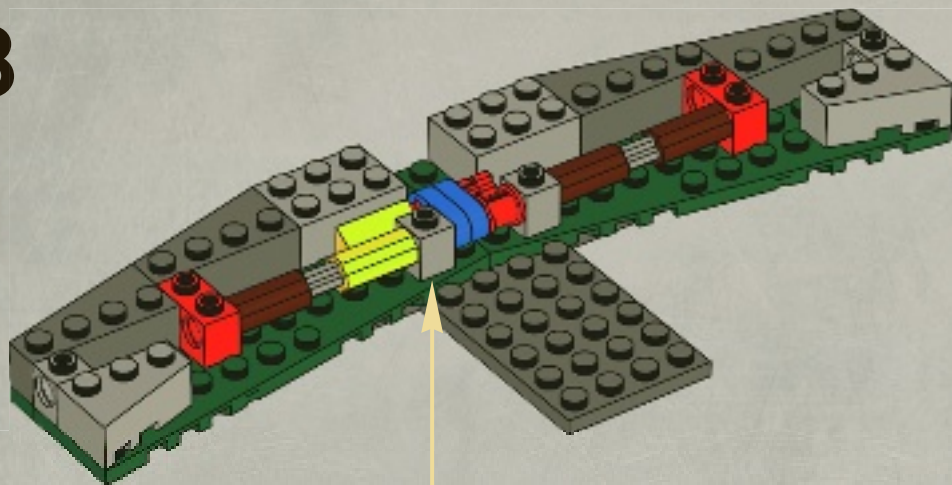

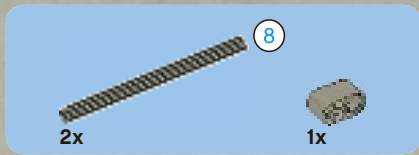

9

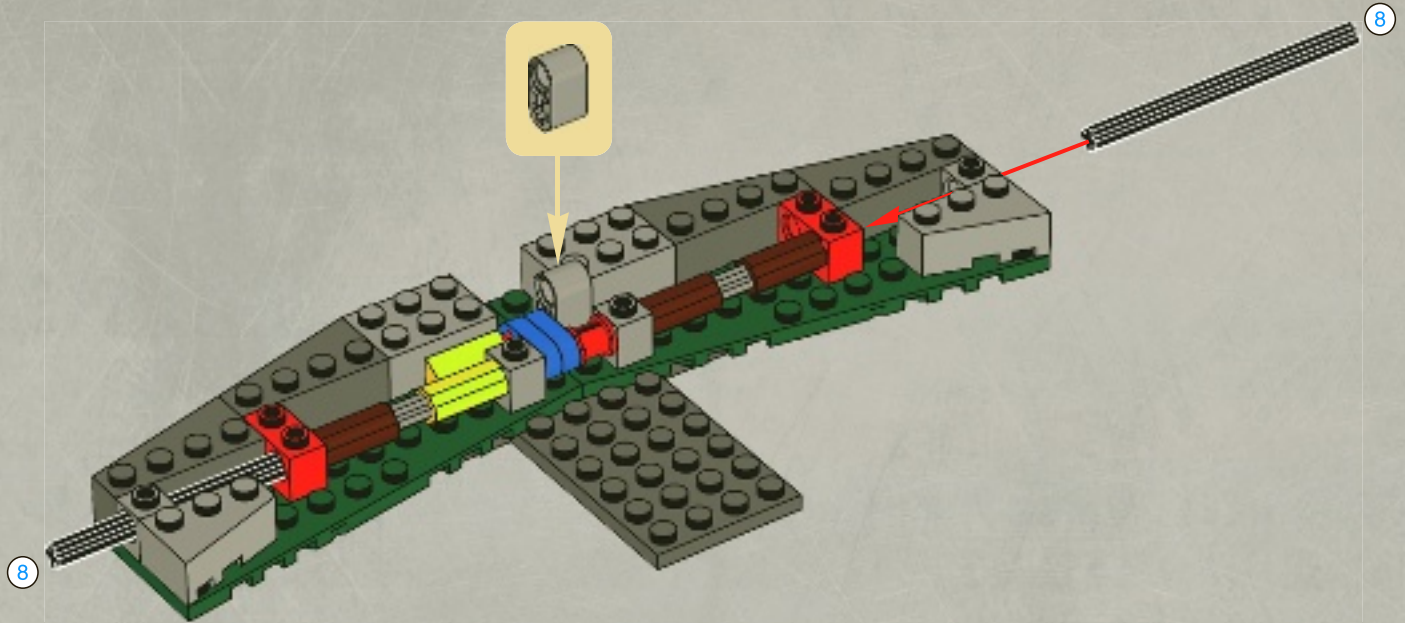



2x

10

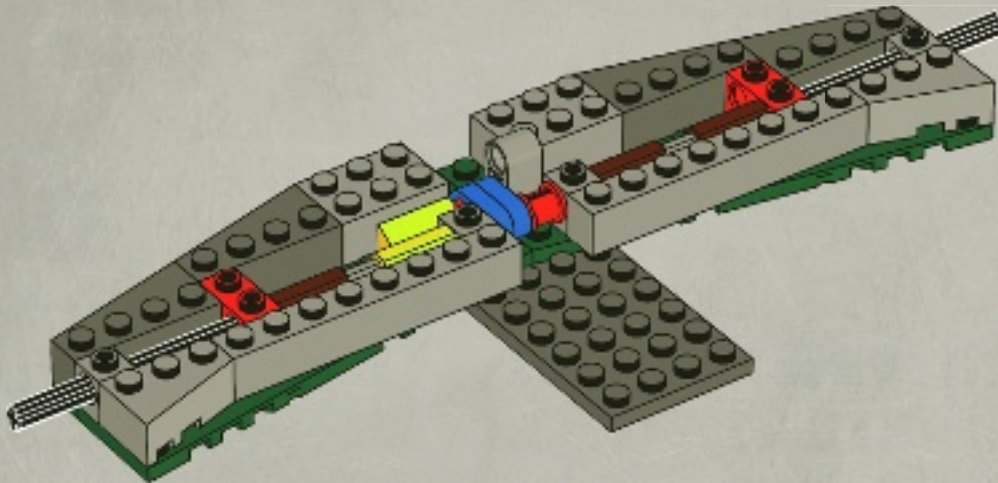

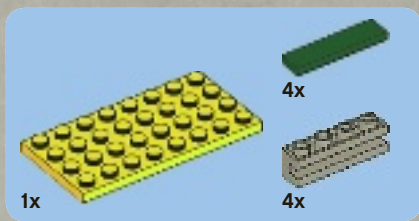

11

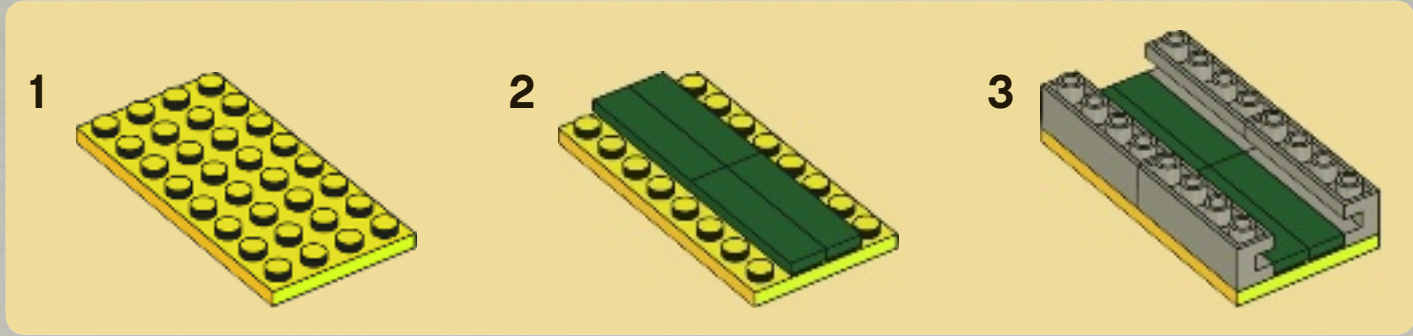
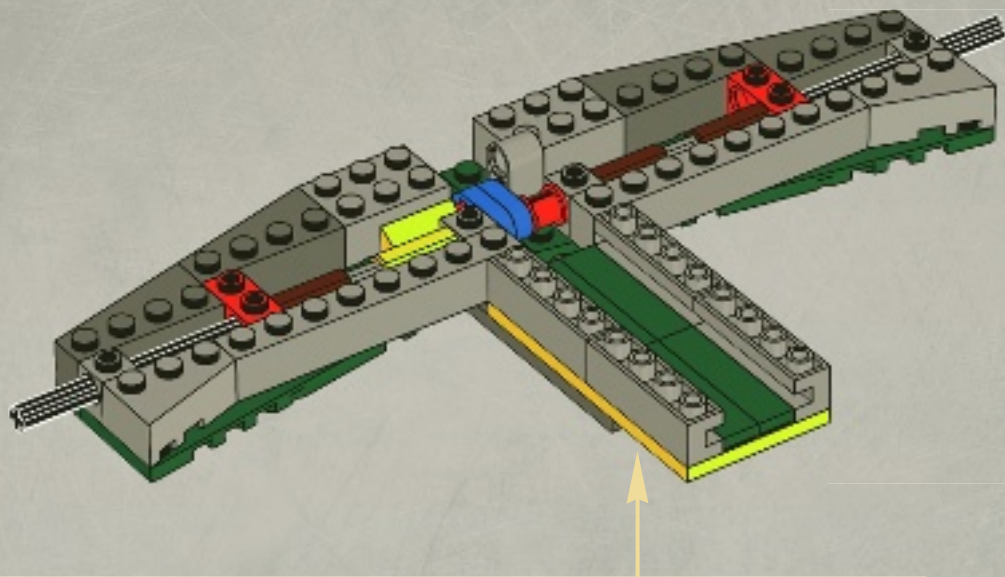



1x

1

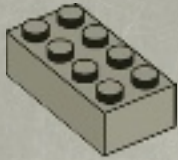

2x

2

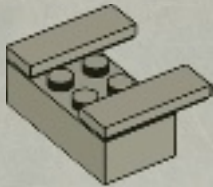

2x

3

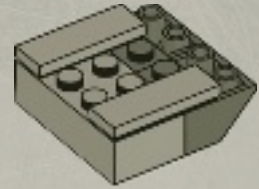

1x



1x

4

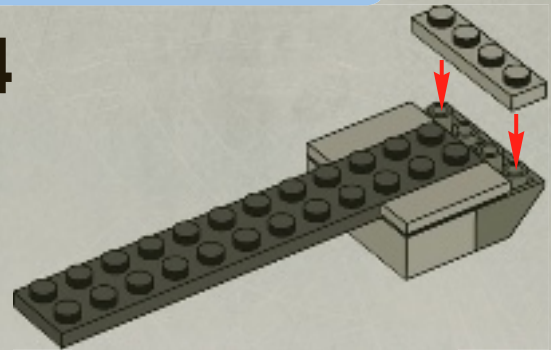



2x

5

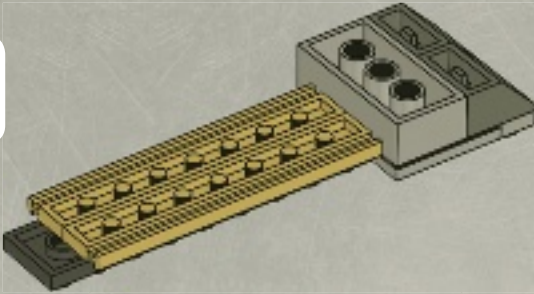

2x



1x

6

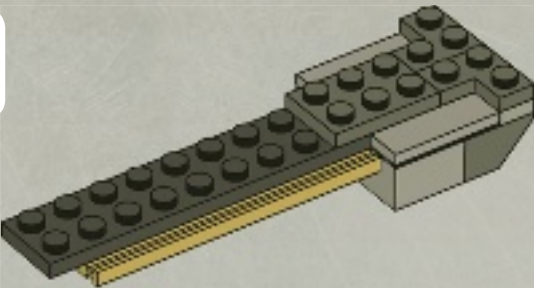

2x



2x



2x

7

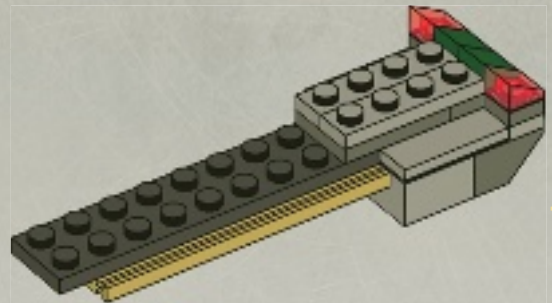

12

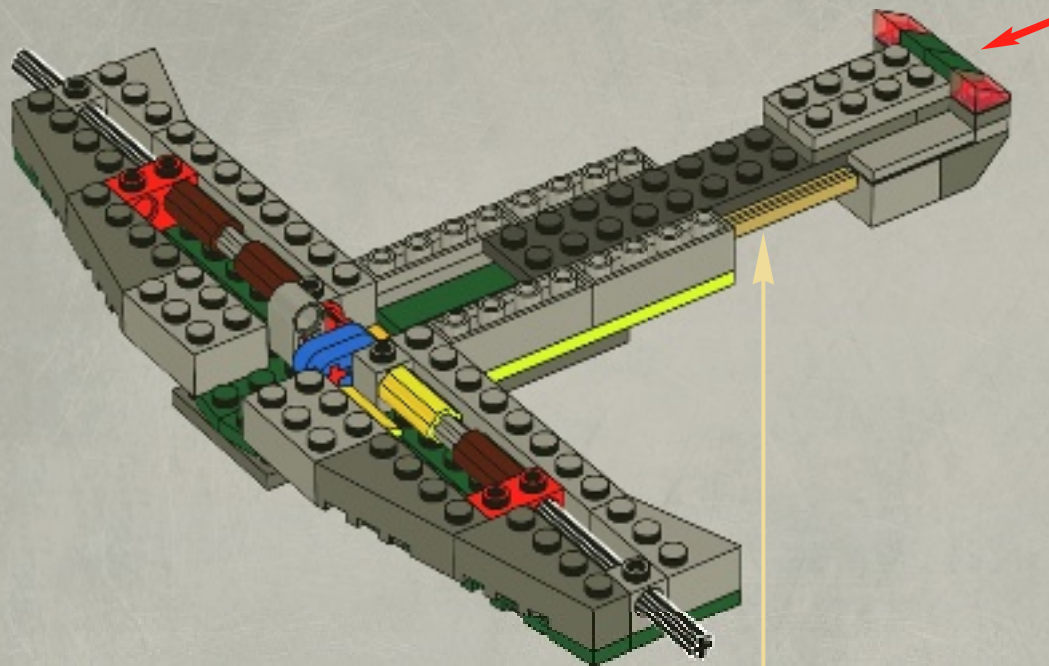



13

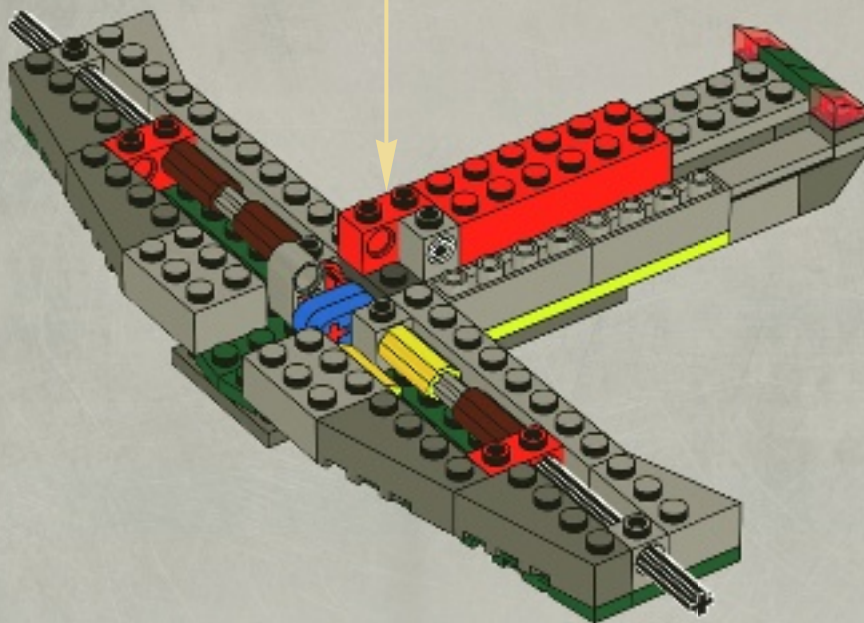

2x



1x

14

1



2

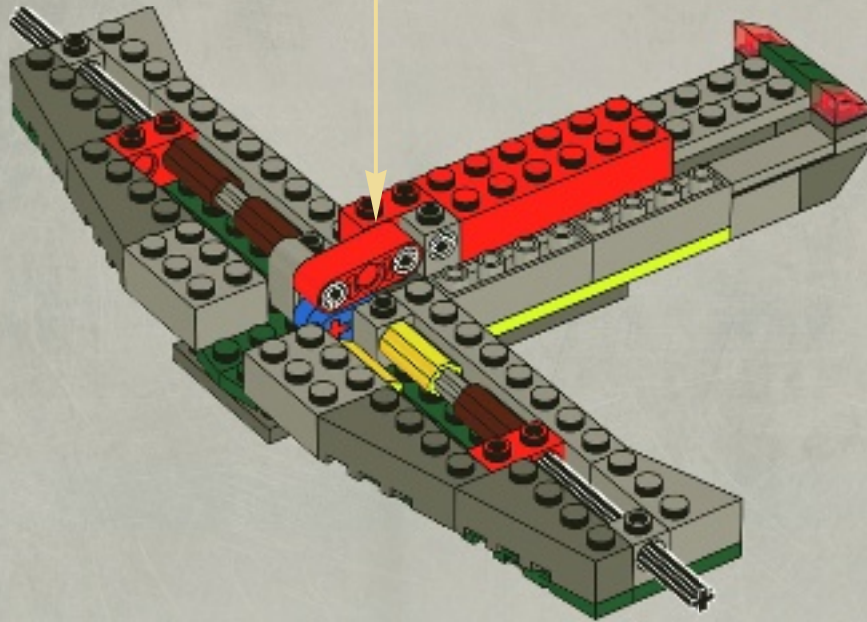



15

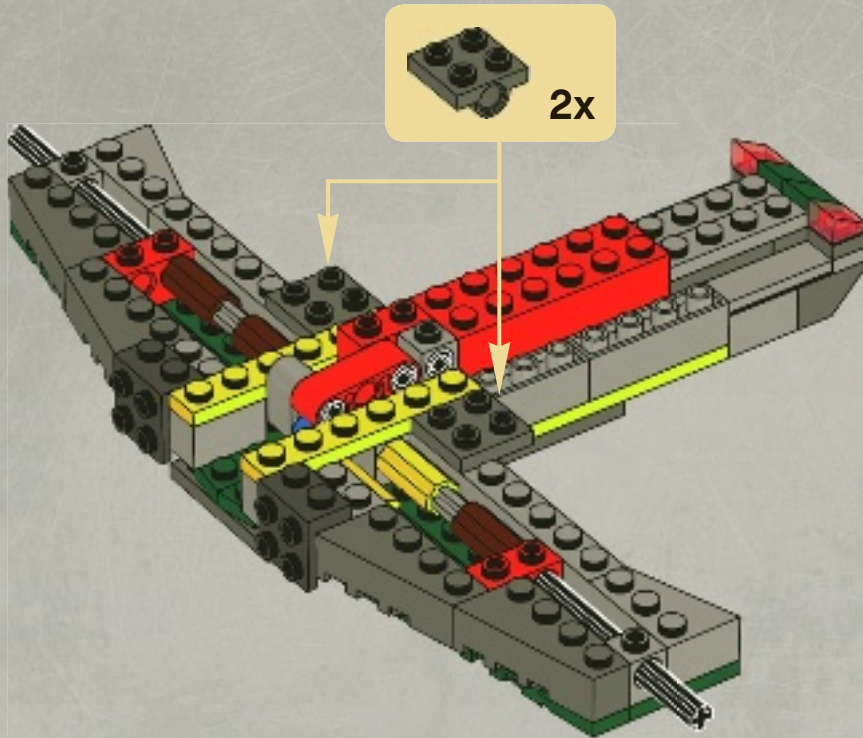

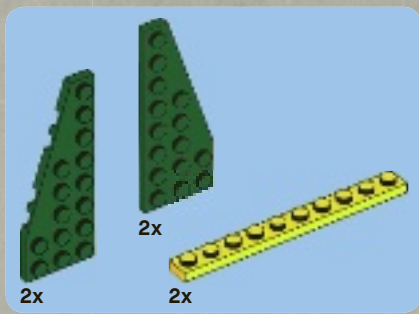

16

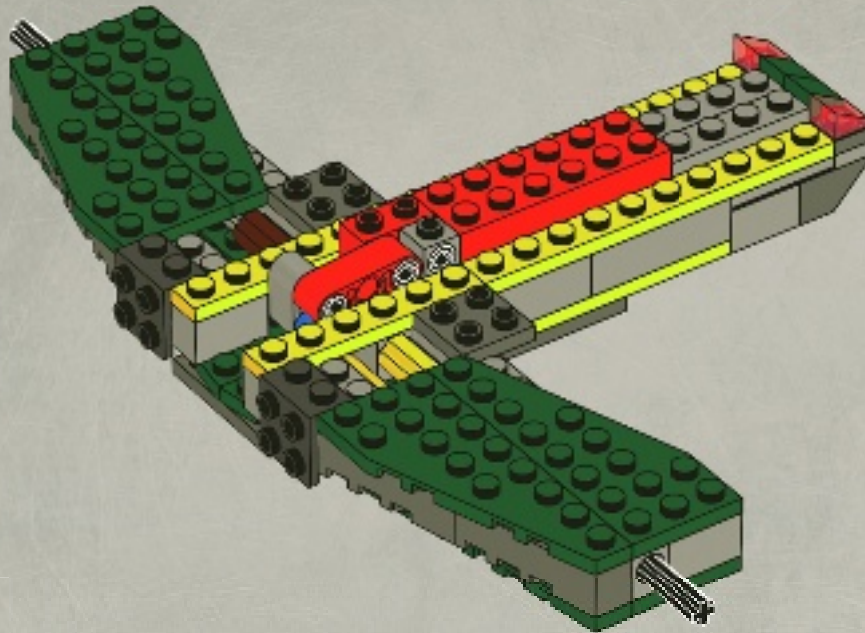



2x

17

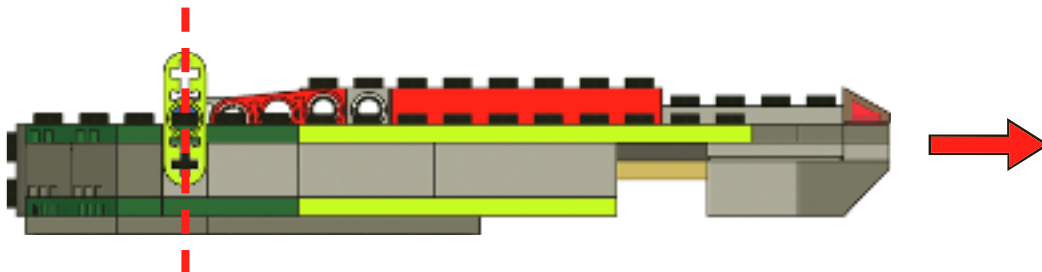
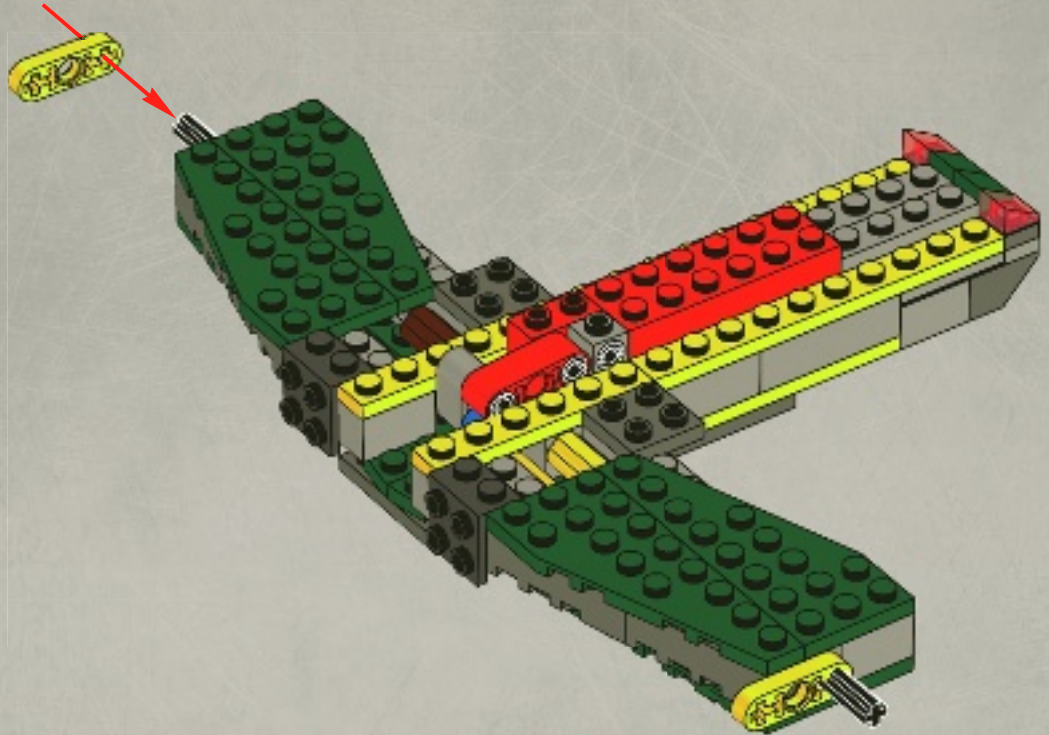

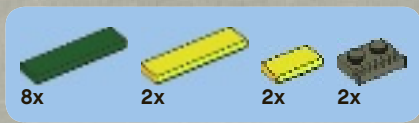

18

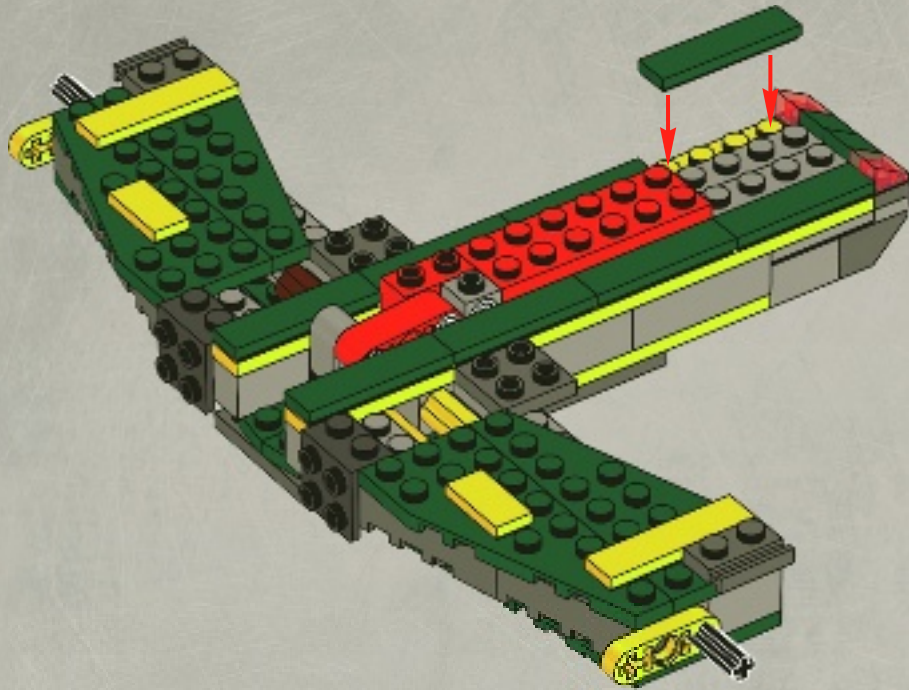

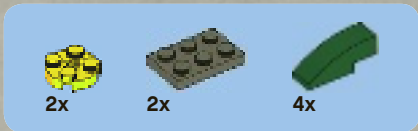

19

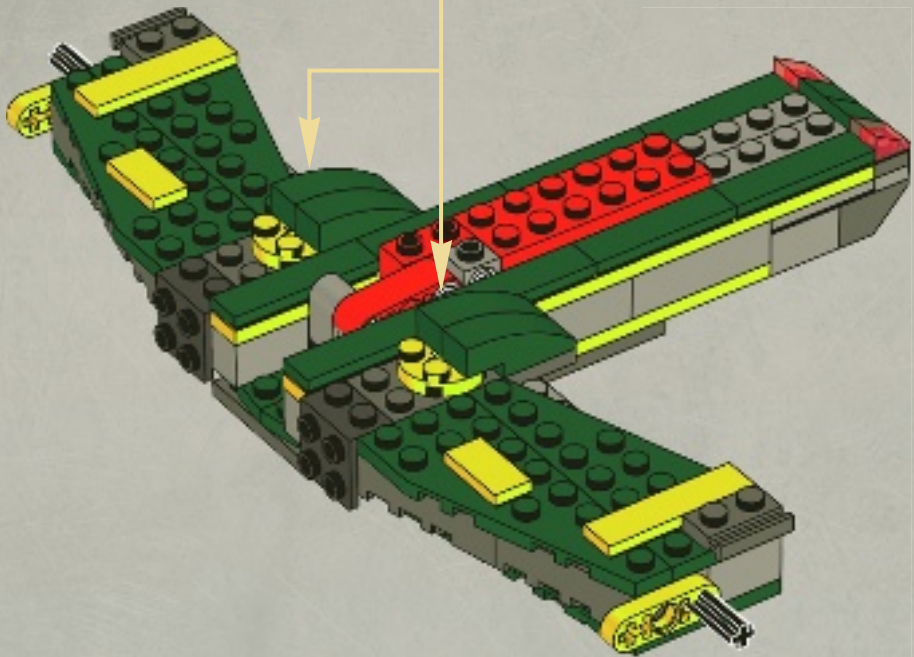

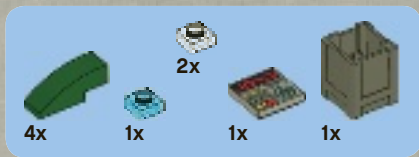

20

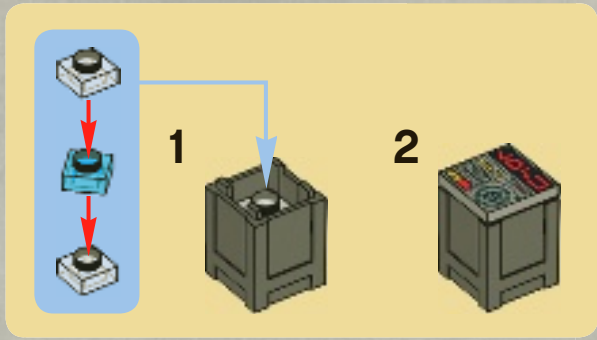
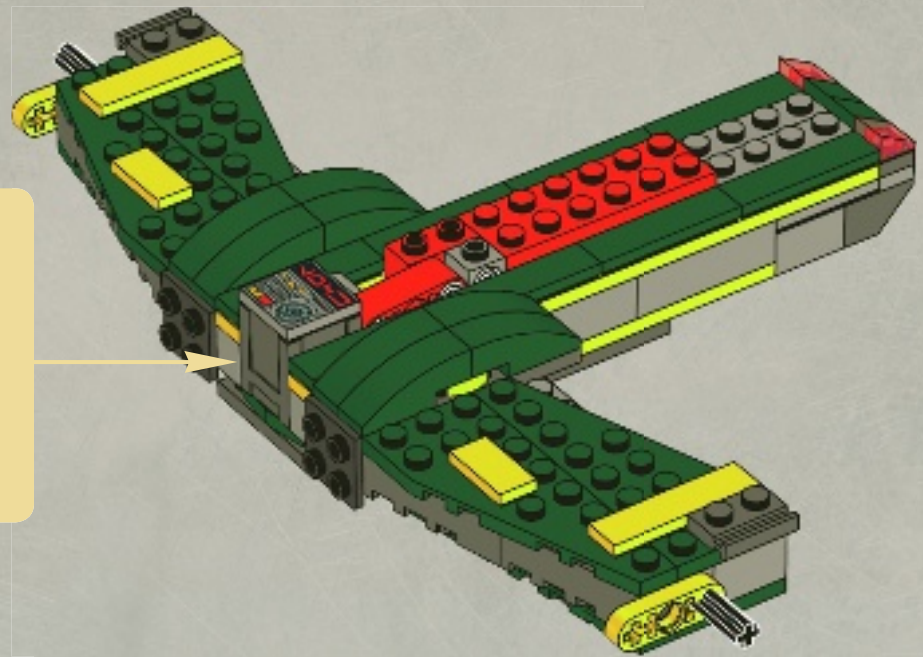



2x

21

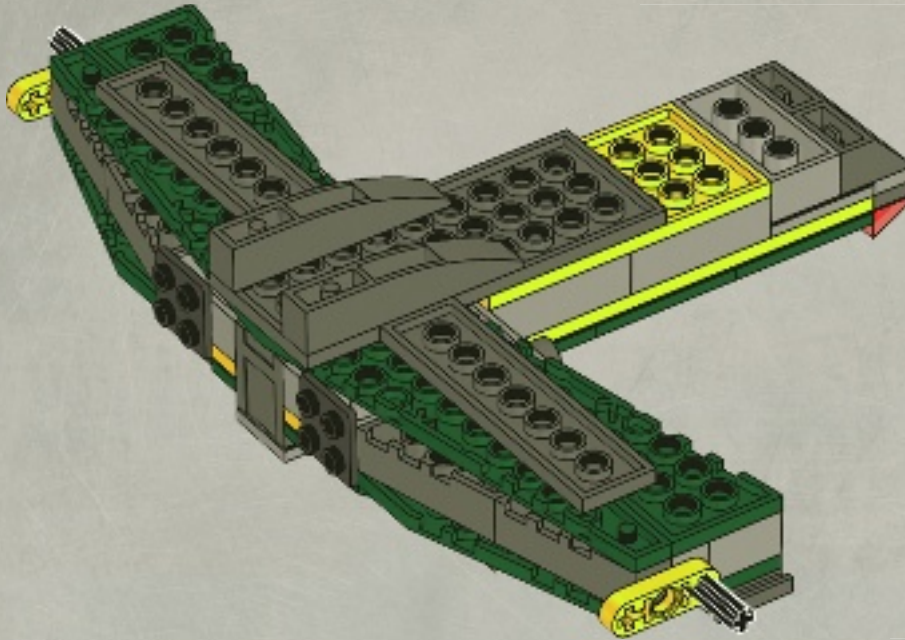



22

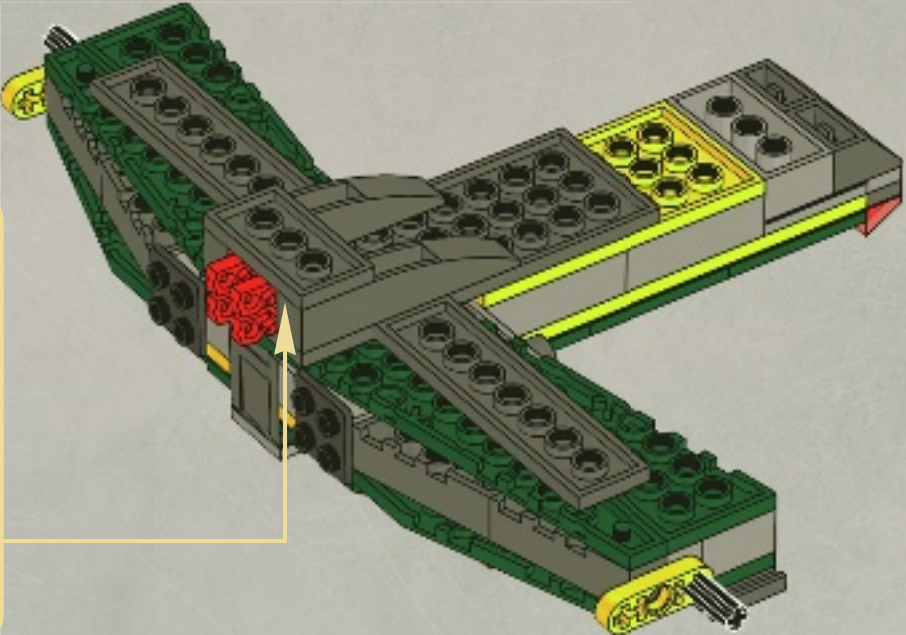
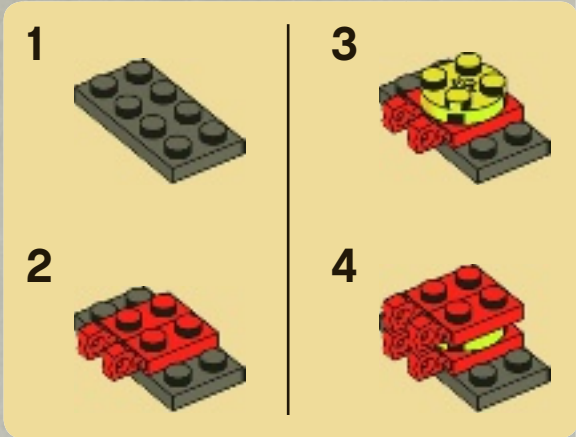



23

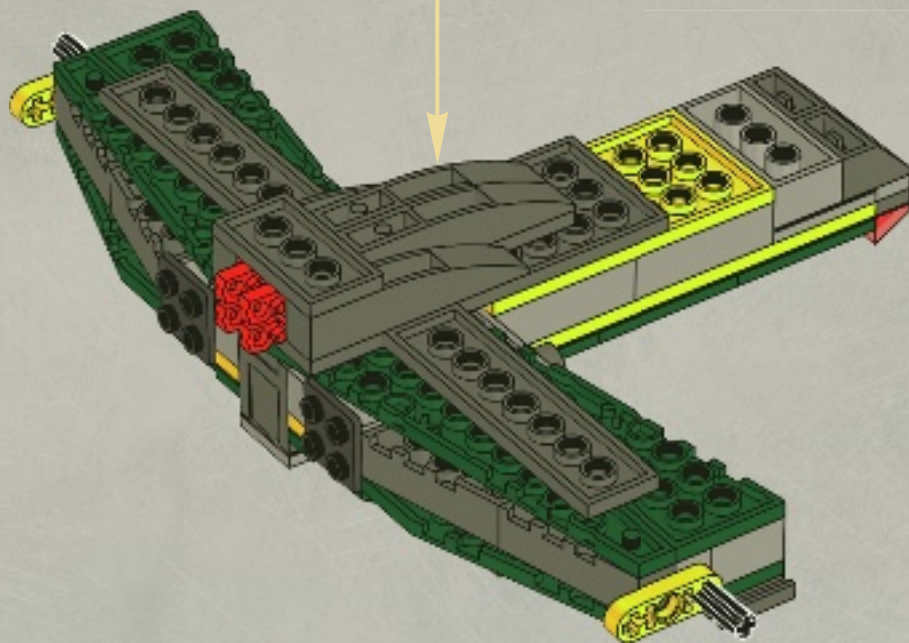
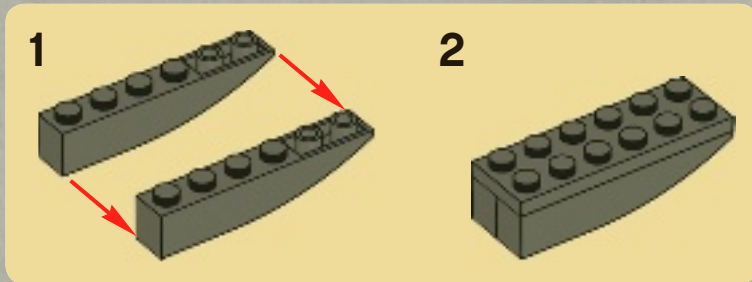



1x

24

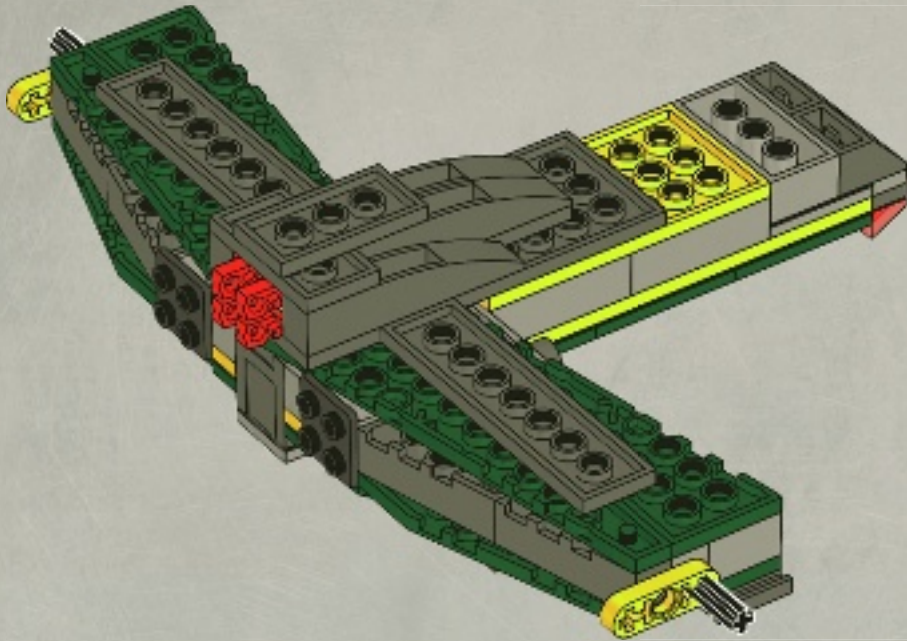



2x



2x



1x

25

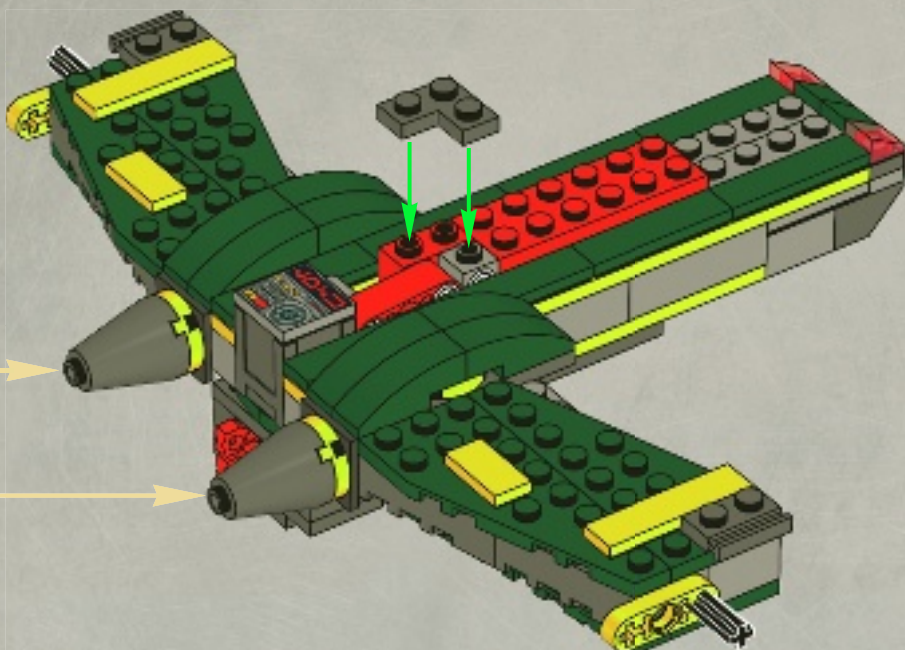

2x

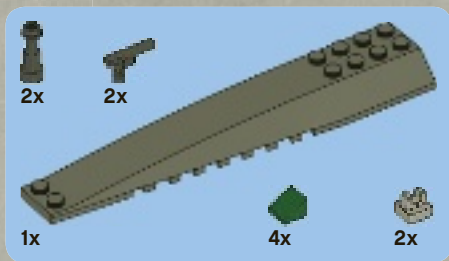

26

1

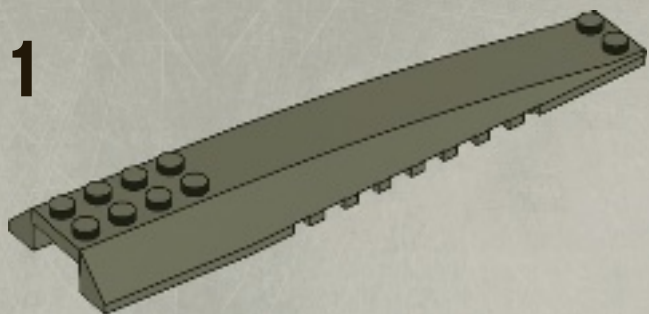

2

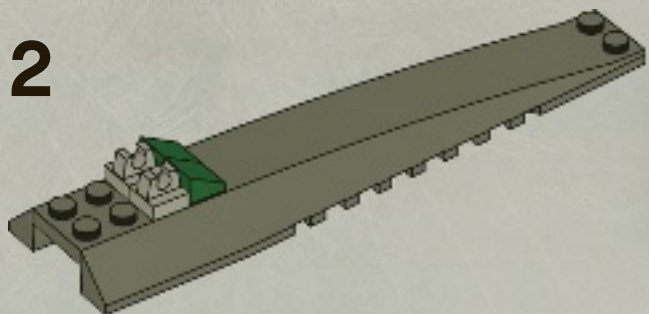

3

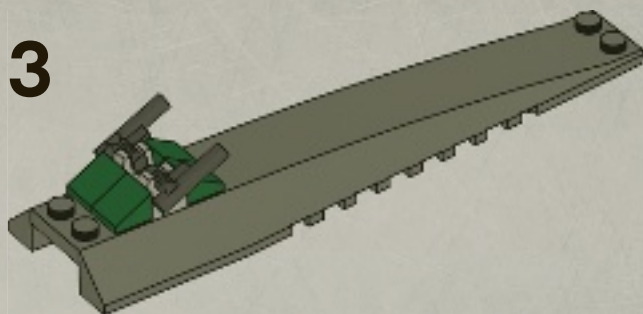

4

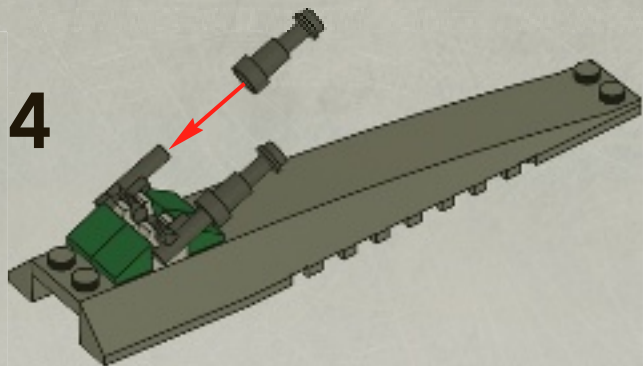

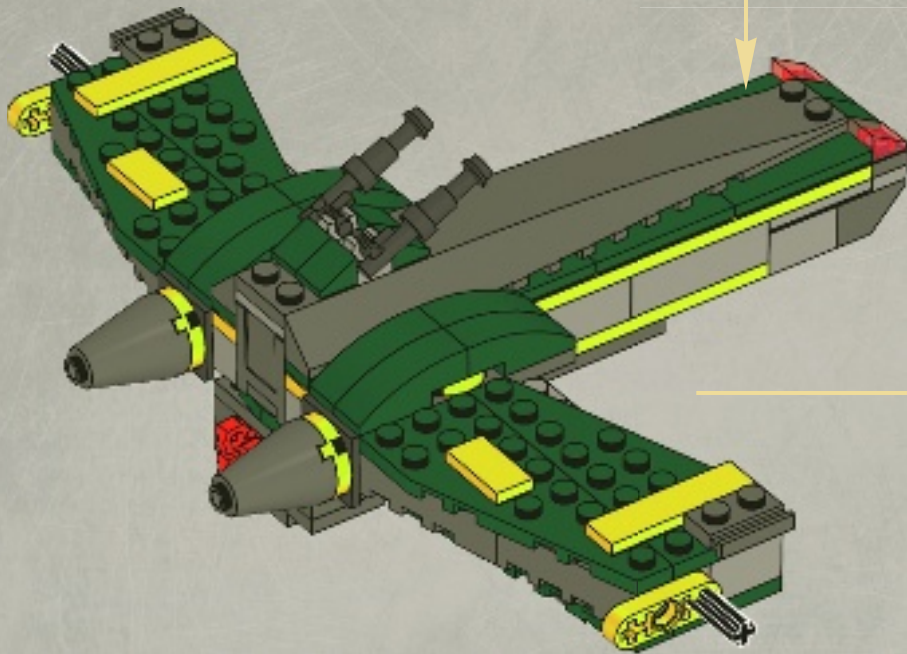

27

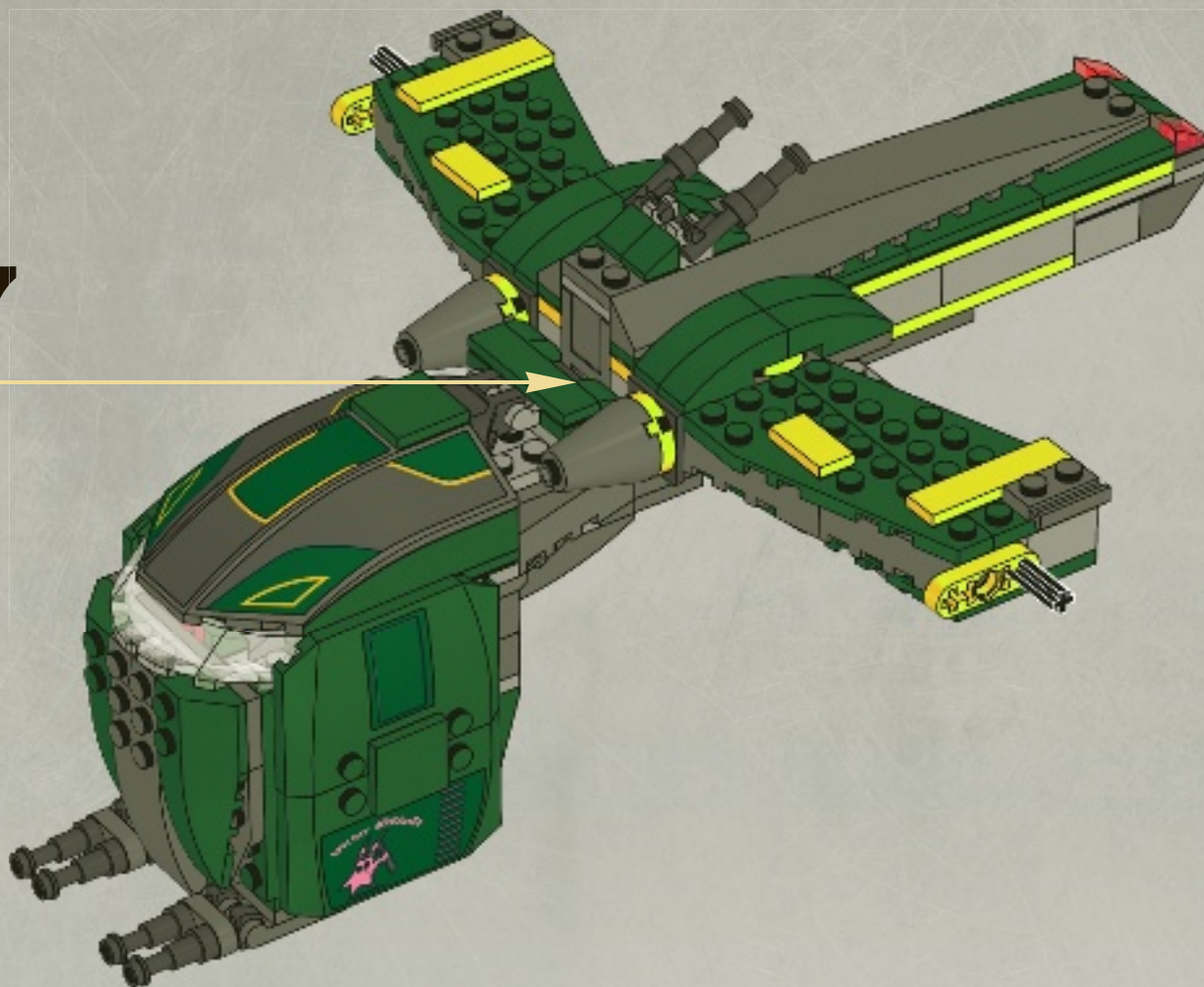

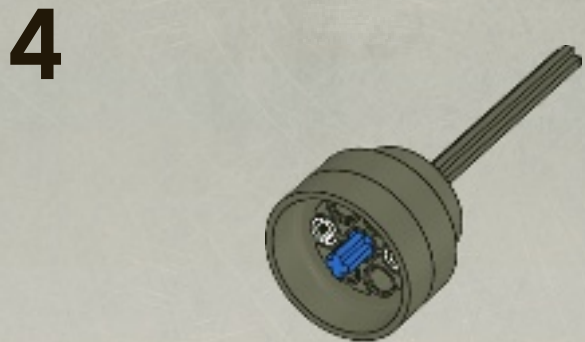
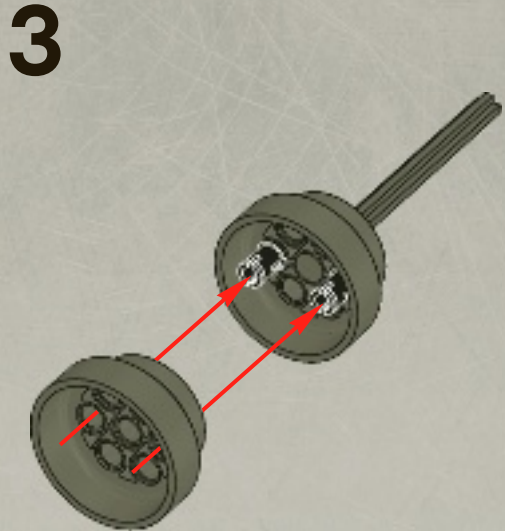
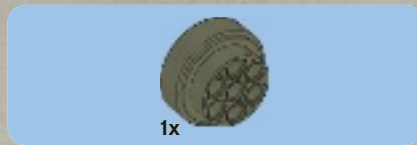
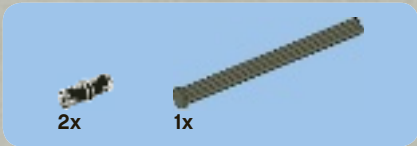
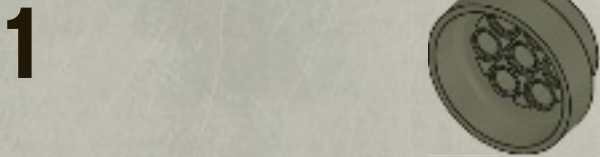
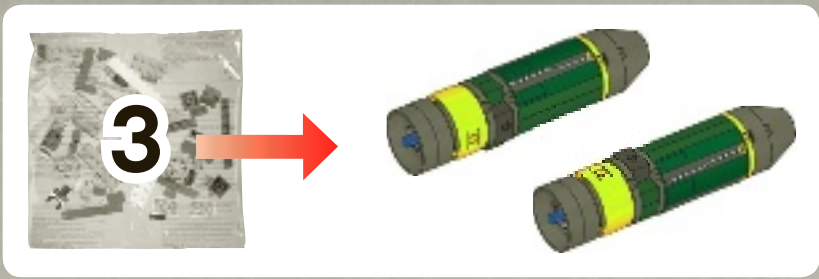



1x

5

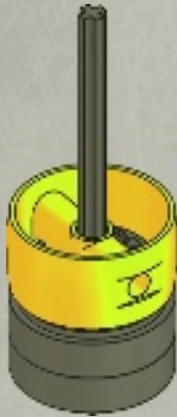

1x



2x



2x

6

1



2

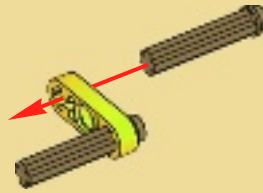

3

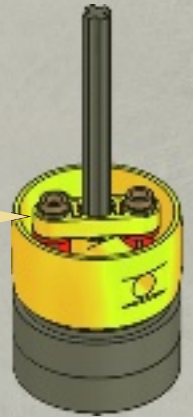
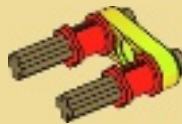

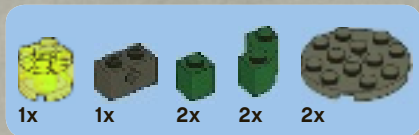

7

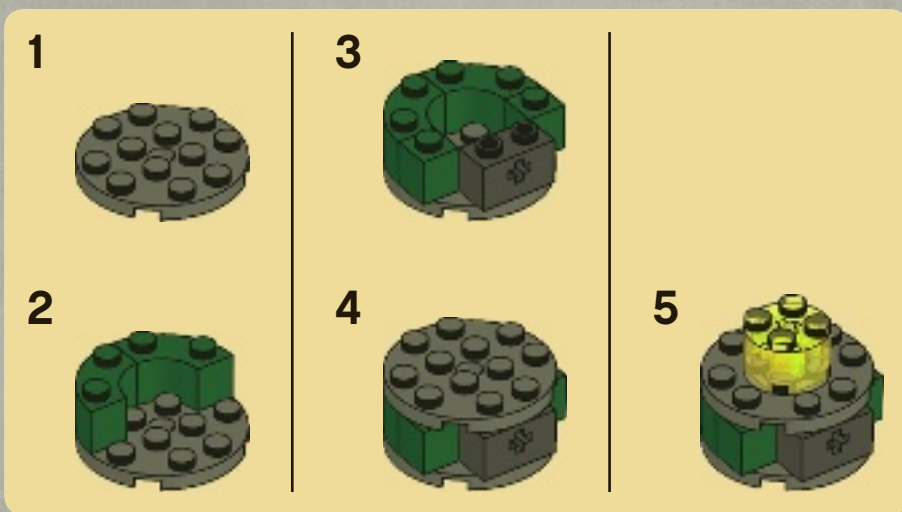

CLICK!





1x

8



1x

9



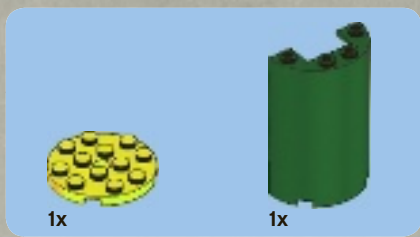

10



11





1x

12



1x



1x



1x

13

1



2



2x

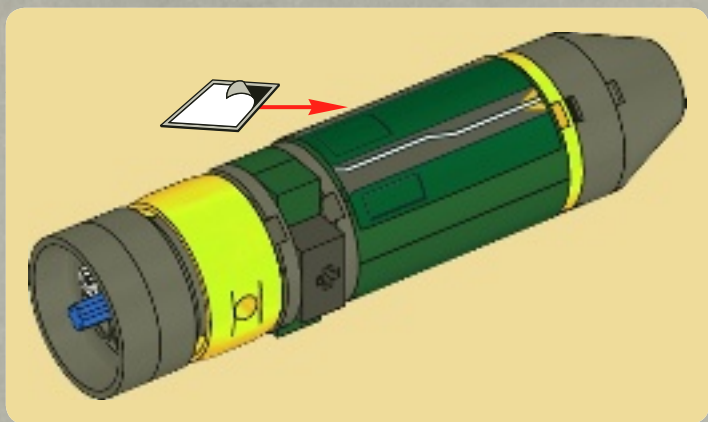

14

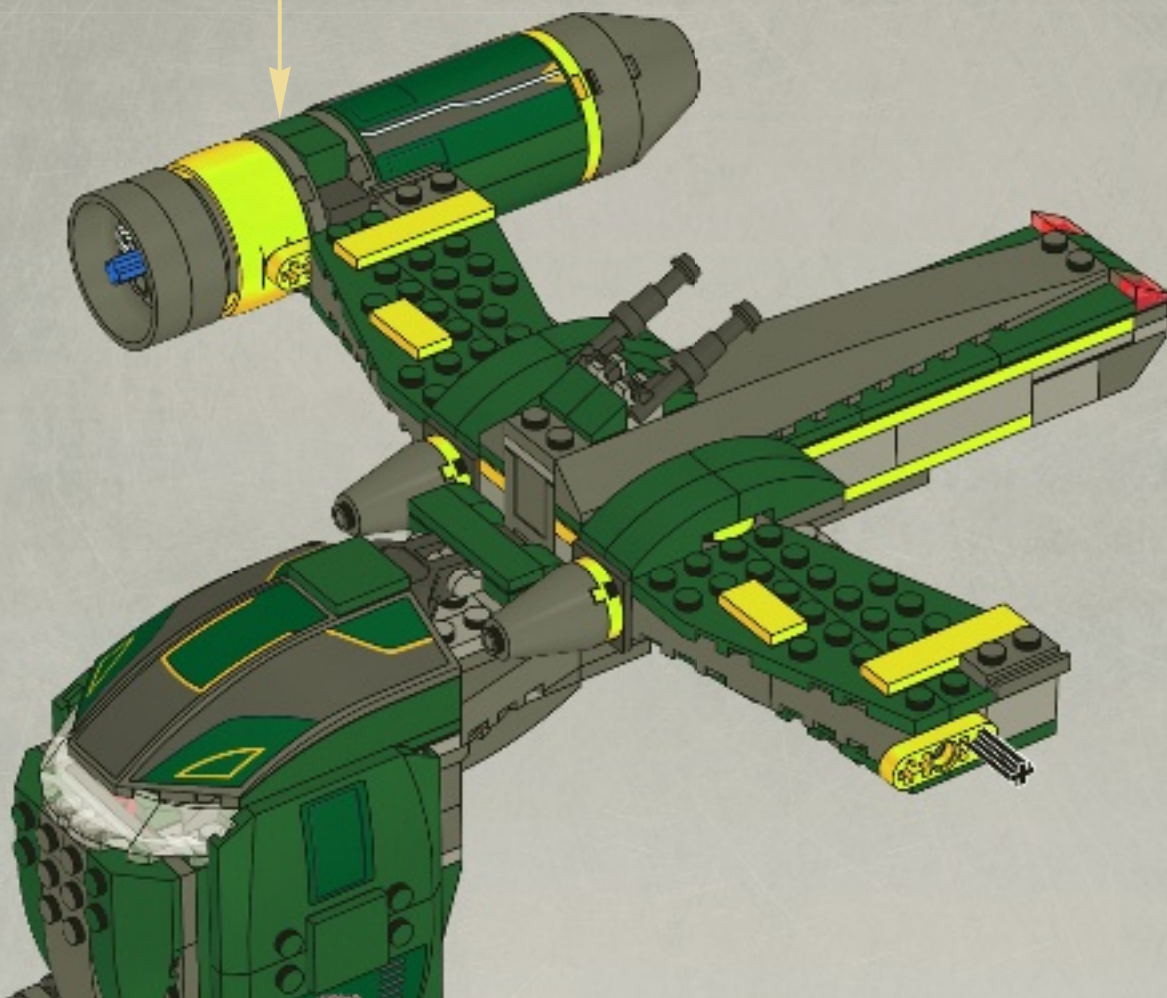

15

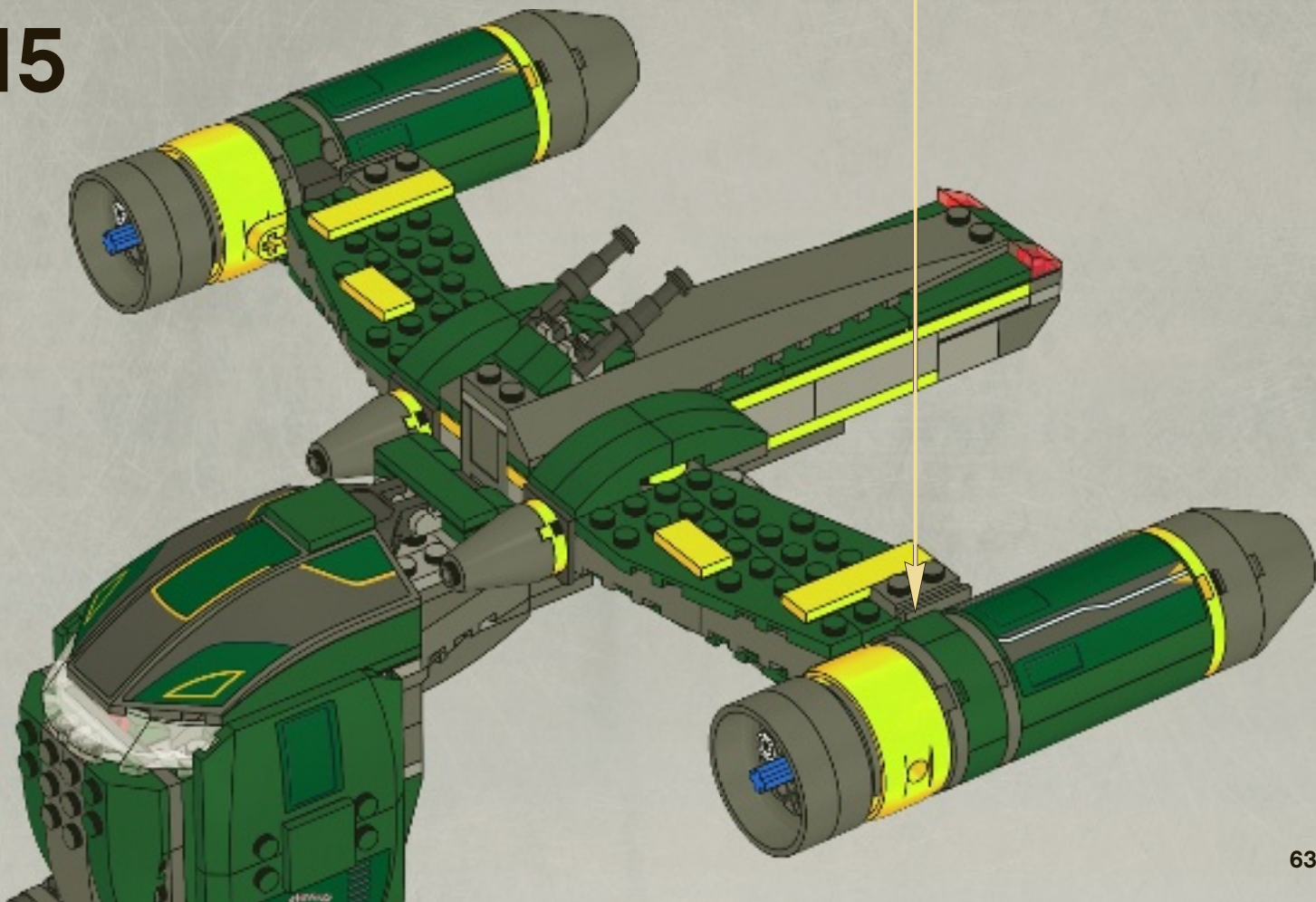
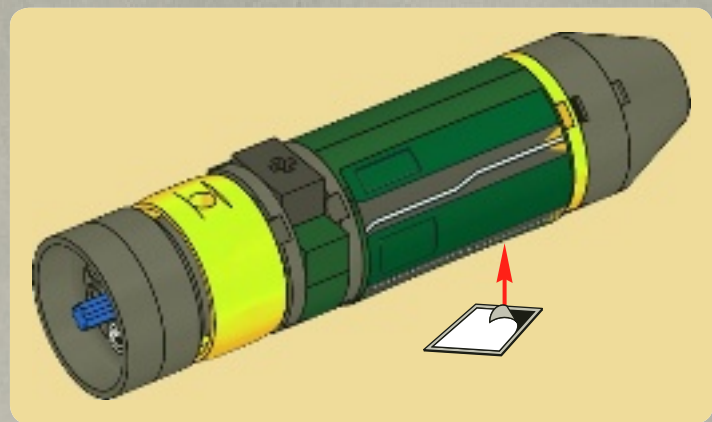

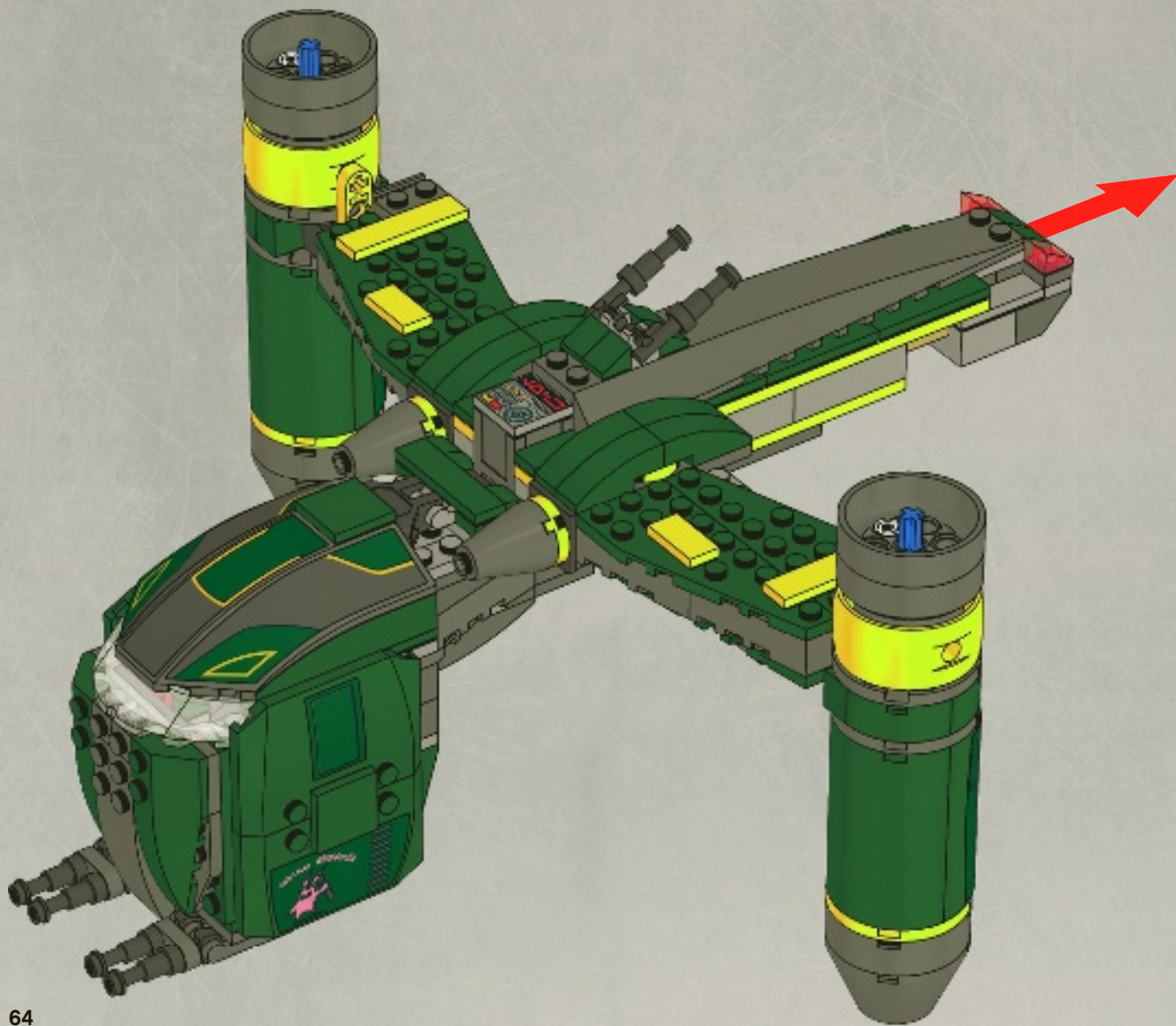



2x

17

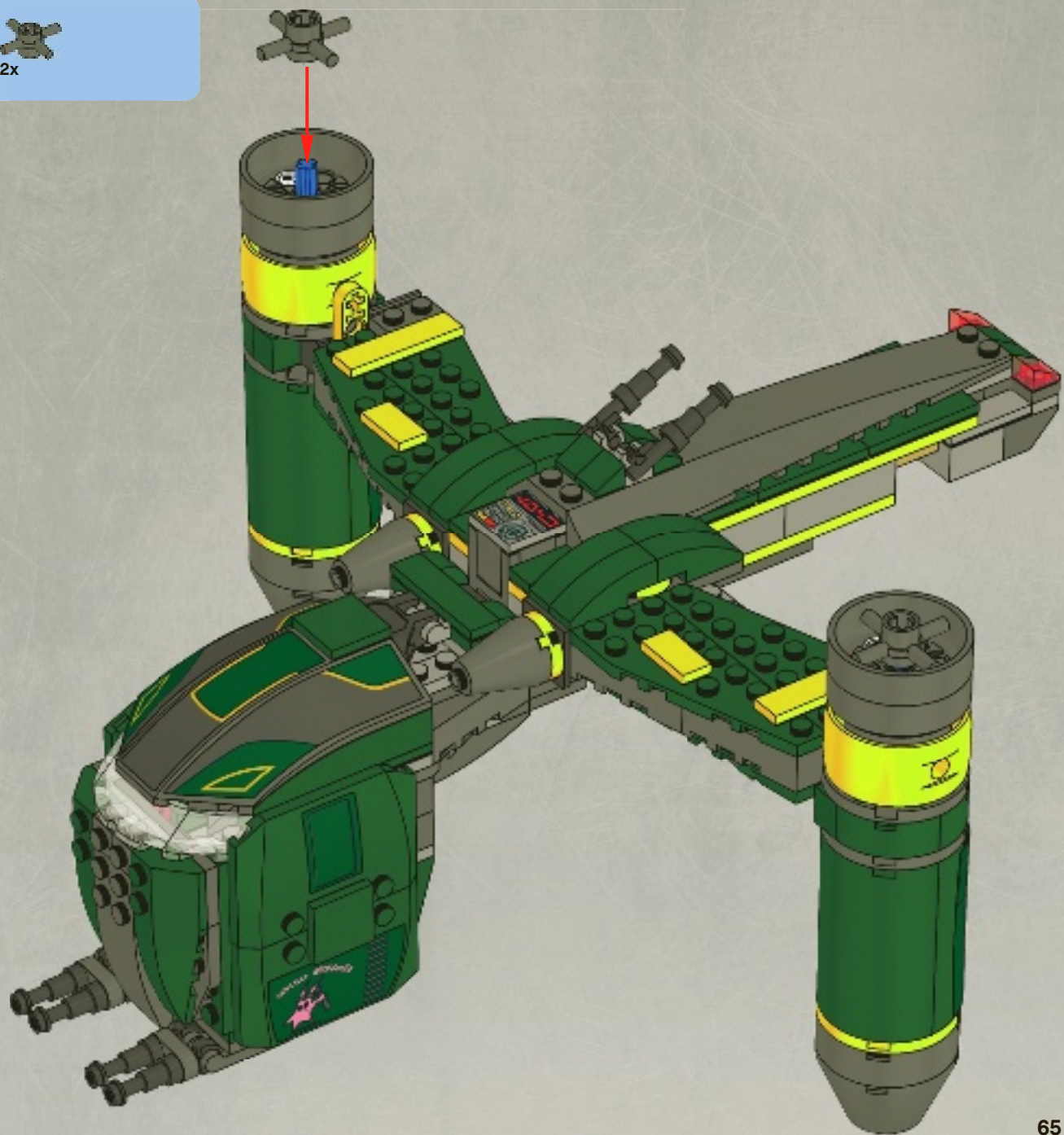



18

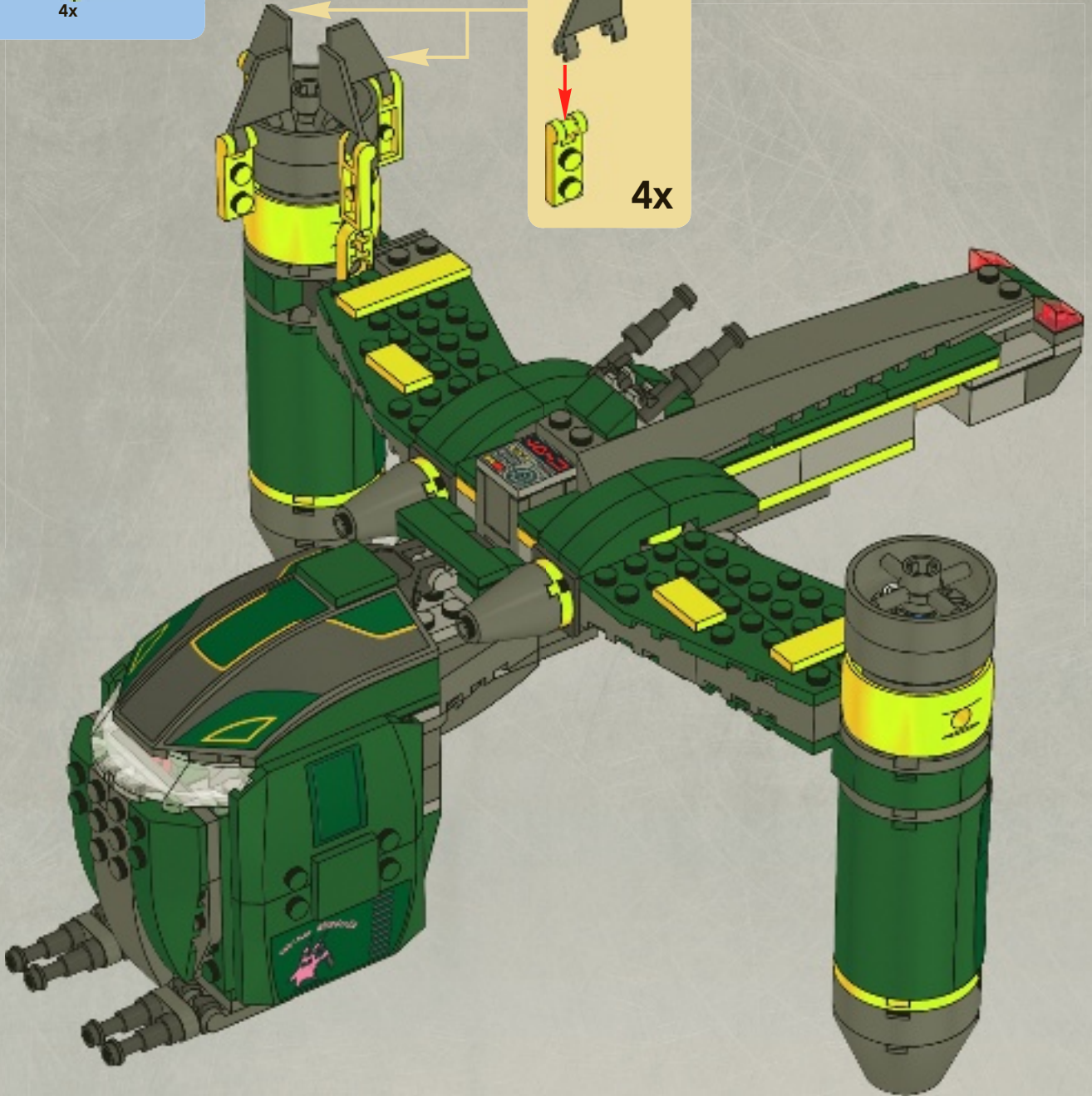



4x



4x

19

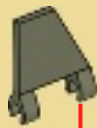

4x

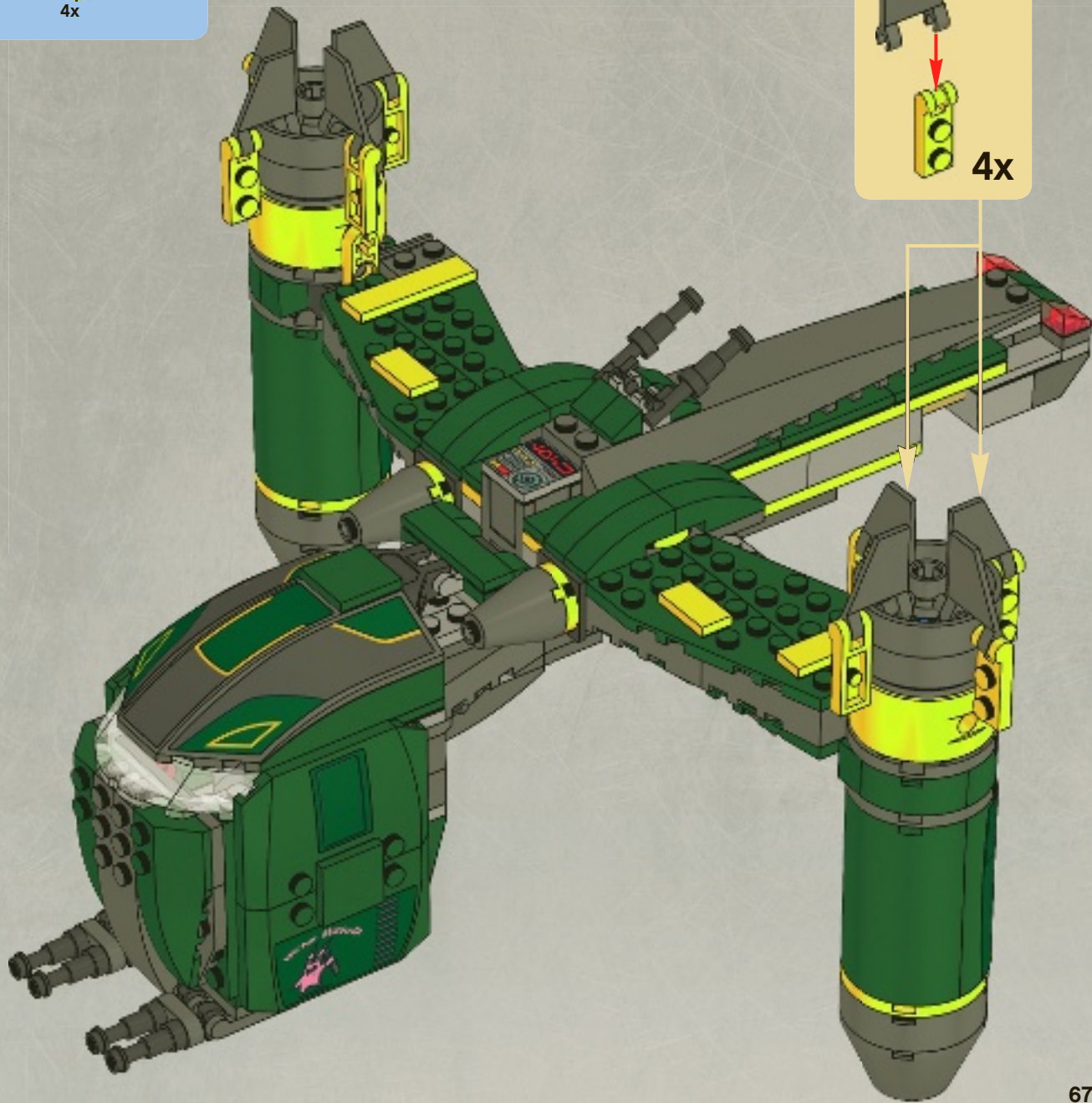

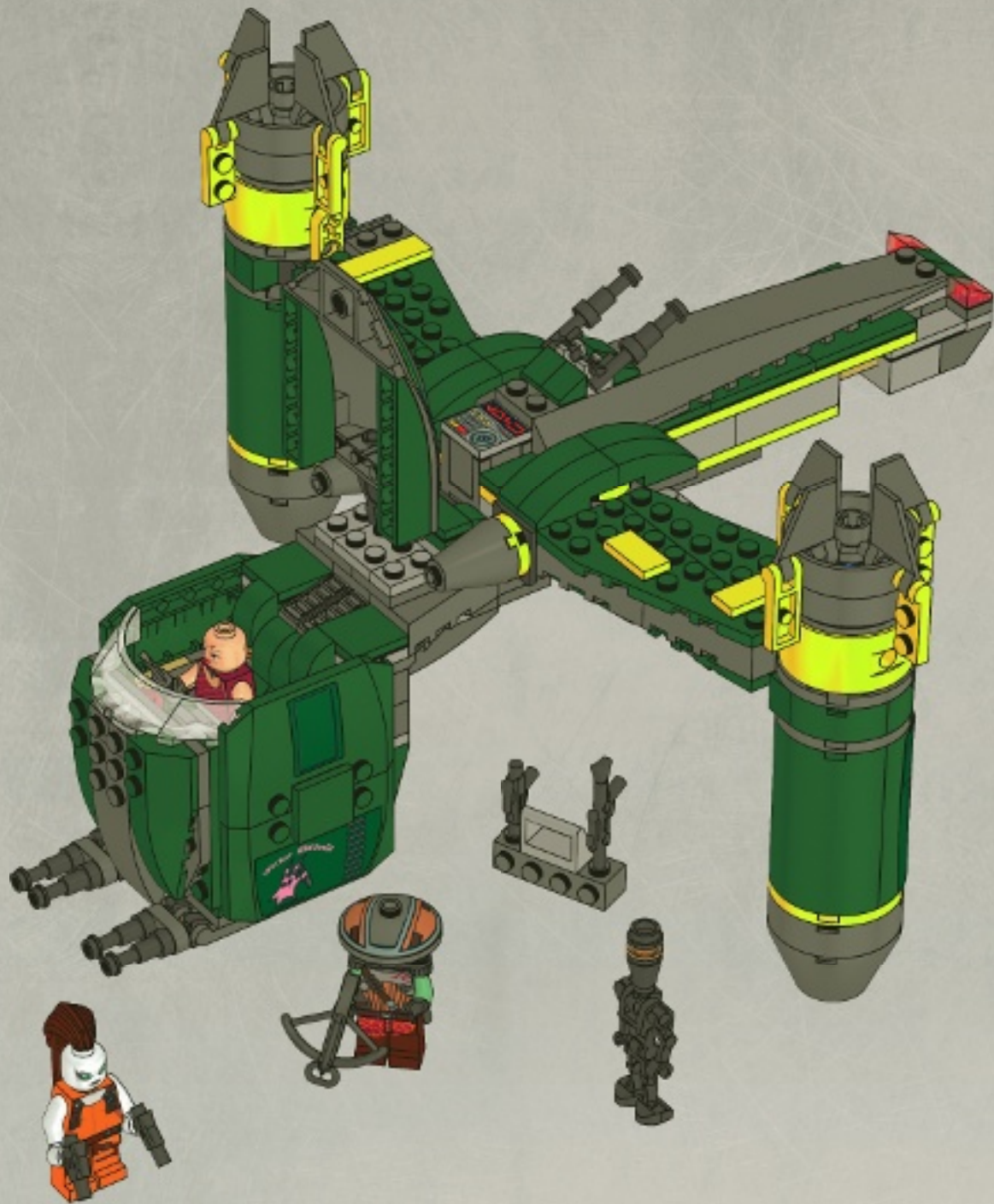

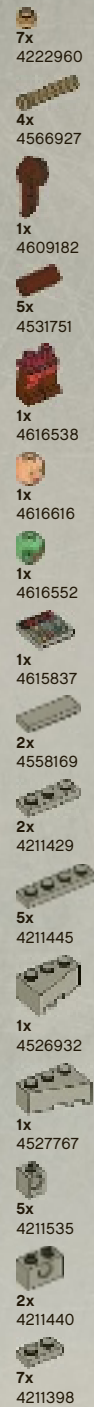
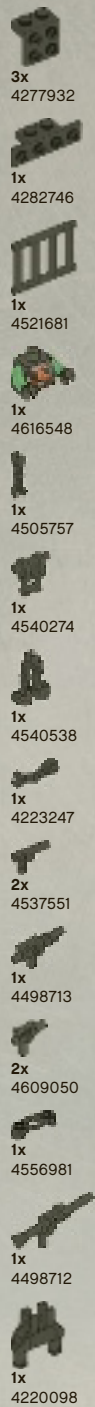



1x
4617248



4x
4613919



4x
4245566



2x
4255624



2x
4583836



6x
4588024



8x
4267850



2x
4612957



1x
4276003

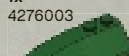

1x
4276005



5x
4528778



4x
4521915



8x
4504375



13x
4543949



4x
4583839



4x
4615164



2x
4250117



2x
4616171



2x
4293614



2x
4293615



2x
4211060



1x
4210725



2x
4211108



2x
4222113



3x
4211088



2x
4543086



4x
4196768



6x
4521187



1x
4227517



1x
4616513



4x
4528323



1x
4520307



8x
4215387



1x
4235863



2x
4542586



1x
4551044



2x
4558959



3x
4287972



3x
4287973



2x
4540386



2x
4211000



2x
4211045



8x
4210779



1x
4210873



2x
4521572



2x
4222192



2x
4210980



1x
4211052



4x
4549886



2x
4558955



5x
4210635



5x
4211043



2x
4598769

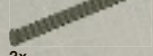

2x
4499858



2x
4211065



1x
4243831

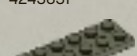

2x
4211002

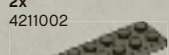

2x
4210997

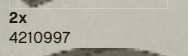

1x
4161239



1x
4211134



1x
4211122



1x
4260406



Customer Service

Kundenservice

Service Consommateurs

Servicio Al Consumidor

www.lego.com/service or dial



00800 5346 5555 :



1-800-422-5346 :





Sugj™



Assassin Droid™



Embo™



Aurra Sing™

LEGO

**STAR
WARS**™





7913



7914



7915



7968



7969



7929



7930



7931



NINJAGO

Masters of Spinjitzu



NINJAGO.COM



www.LEGOclub.com



LEGO® Club Email

LEGO club™

FREE! GRATIS! GRATUIT!



LEGO® Club Magazine

SIGN UP ONLINE!

www.LEGOclub.com



00800 5346 5555*



1-866-534-6258 • 1-877-518-5346

US & Canada only

Canada seulement

* Freephone. Mobile charges may apply.
* Numéro sans frais. Des frais peuvent s'appliquer avec les téléphones cellulaires.
* Gebührenfrei, Kosten für Anrufe aus Mobilfunknetzen können abweichen.
* Gratis telefonnummer vanaf vaste lijn.
* Det är et gratis nummer, når du ringer fra fasttelefon.
* Det är gratis, när du ringer från en fast telefon.
* Numéro sans frais. Des frais peuvent s'appliquer avec les téléphones portables.



WIN!

Go to www.LEGOsurvey.com/product to fill out a survey for a chance to win a cool LEGO® Product.

No purchase necessary.

Open to all residents where not prohibited.



www.LEGO.com



www.LEGOsurvey.com/product

GEWINNE! WIN!

Nimm an der Umfrage auf www.LEGOsurvey.com/product teil und hab die Chance ein cooles LEGO® Produkt zu gewinnen!

Die Teilnahme am Gewinnspiel führt zu keinerlei Kaufverpflichtungen. Teilnahme in allen nicht ausgeschlossenen Ländern möglich.

Ga naar www.LEGOsurvey.com/product, vul een enquêteformulier in en maak kans op een cool LEGO® product.

Geen aankoopverplichting. Iedereen mag deelnemen, uitgezonderd ingezetenden van landen waar een enquêteverbod geldt.

GAGNE! 当てよう!

Visite www.LEGOsurvey.com/product pour répondre à un questionnaire et avoir une chance de gagner un produit LEGO® très cool!

Aucune obligation d'achat. Ouvert à tous les résidents des pays autorisés.

www.LEGOsurvey.com/product にアクセスして、アンケートにご記入ください。当選者にはレゴ®製品を差し上げます。

お買い上げの必要はありません。

禁止されていない限り、すべての皆様にご利用いただけます。

LEGO and the LEGO logo are trademarks of the/son marcas registradas de LEGO Group. ©2011 The LEGO Group.

© 2011 LucasFilm Ltd. & TM. All rights reserved/Tous droits réservés./Todos los derechos reservados.