



CITY

5-12
7899



2+3



WARNING: CHOKING HAZARD.
Small parts. Not for children under 3 years.

1



2



3



Attention: This set contains small parts. Not suitable for children under 3 years of age.

 Attention: Este juego contiene piezas pequeñas. No es adecuado para niños menores de 3 años.

 Attention: This set contains small parts. Not suitable for children under 3 years of age.

 Attention: Este juego contiene piezas pequeñas. No es adecuado para niños menores de 3 años.

2

 09493 Use 1207 Group

2

 09493 Use 1207 Group

⚠ **AVERTISSEMENT : RISQUE D'ÉTOUFFEMENT.**
 Contient des petites pièces. Ne convient pas aux enfants de moins de 3 ans.

⚠ **ADVERTENCIA: PELIGRO DE ASFIXIA.**
 No recomendado para niños menores de 3 años. Contiene piezas pequeñas.



1

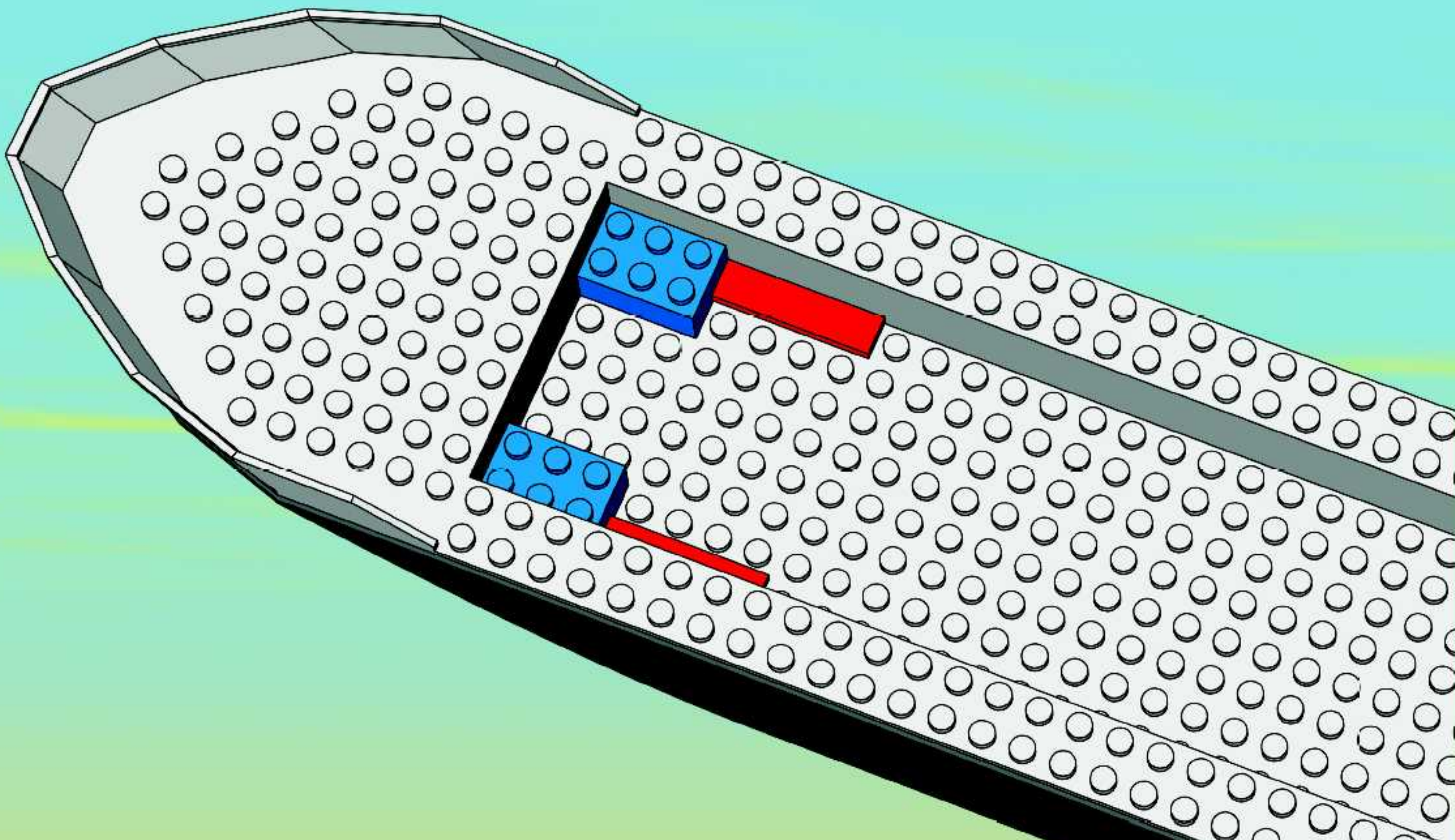

2

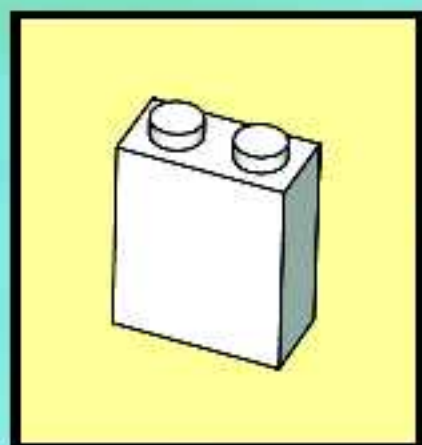
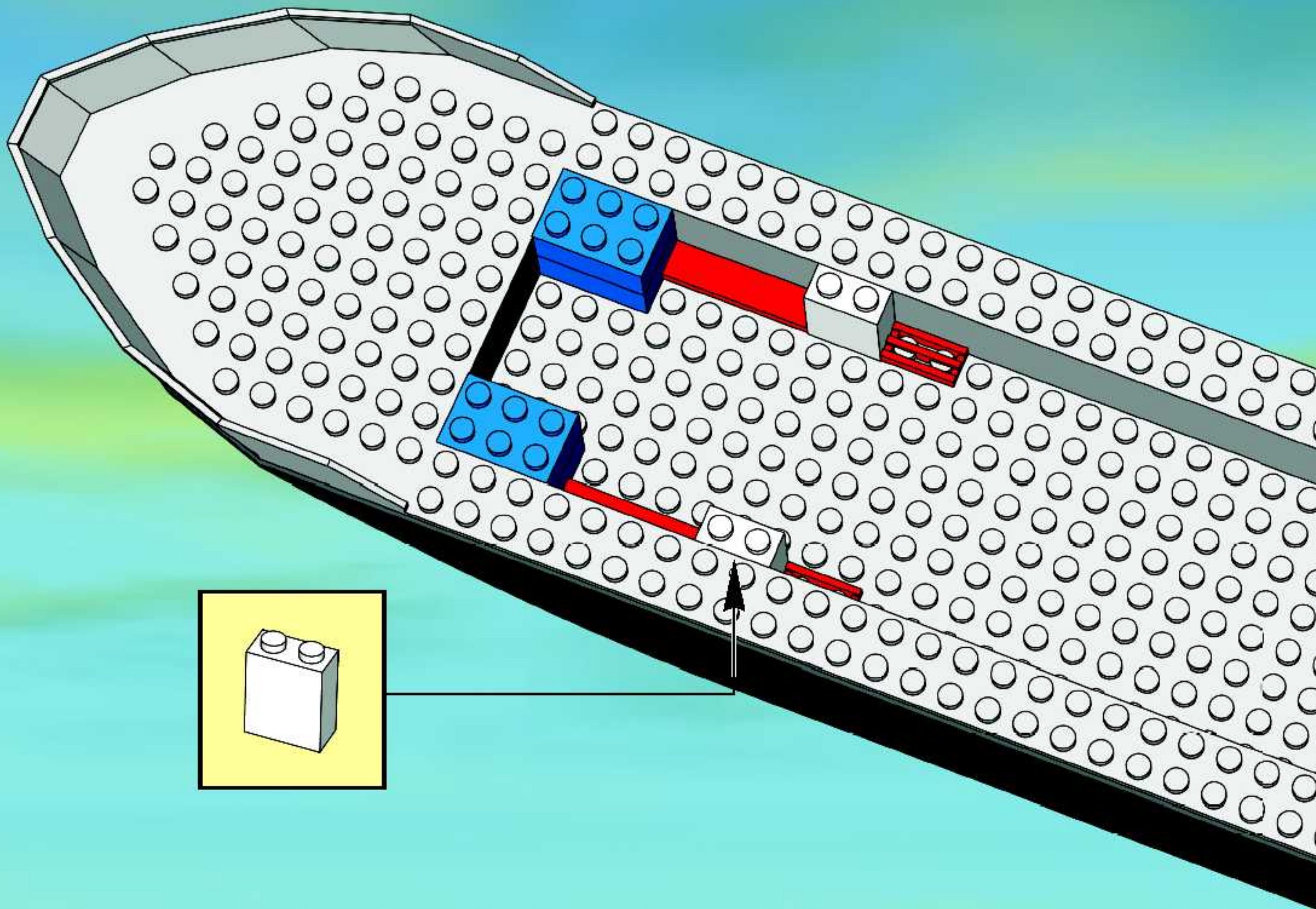

3

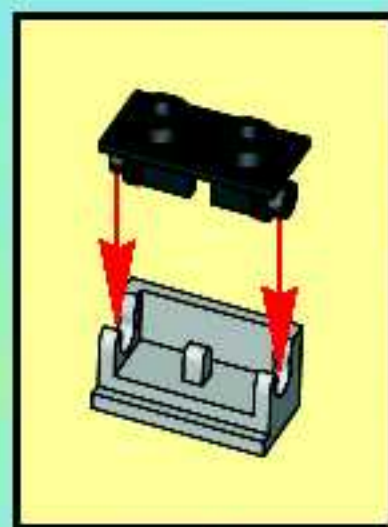
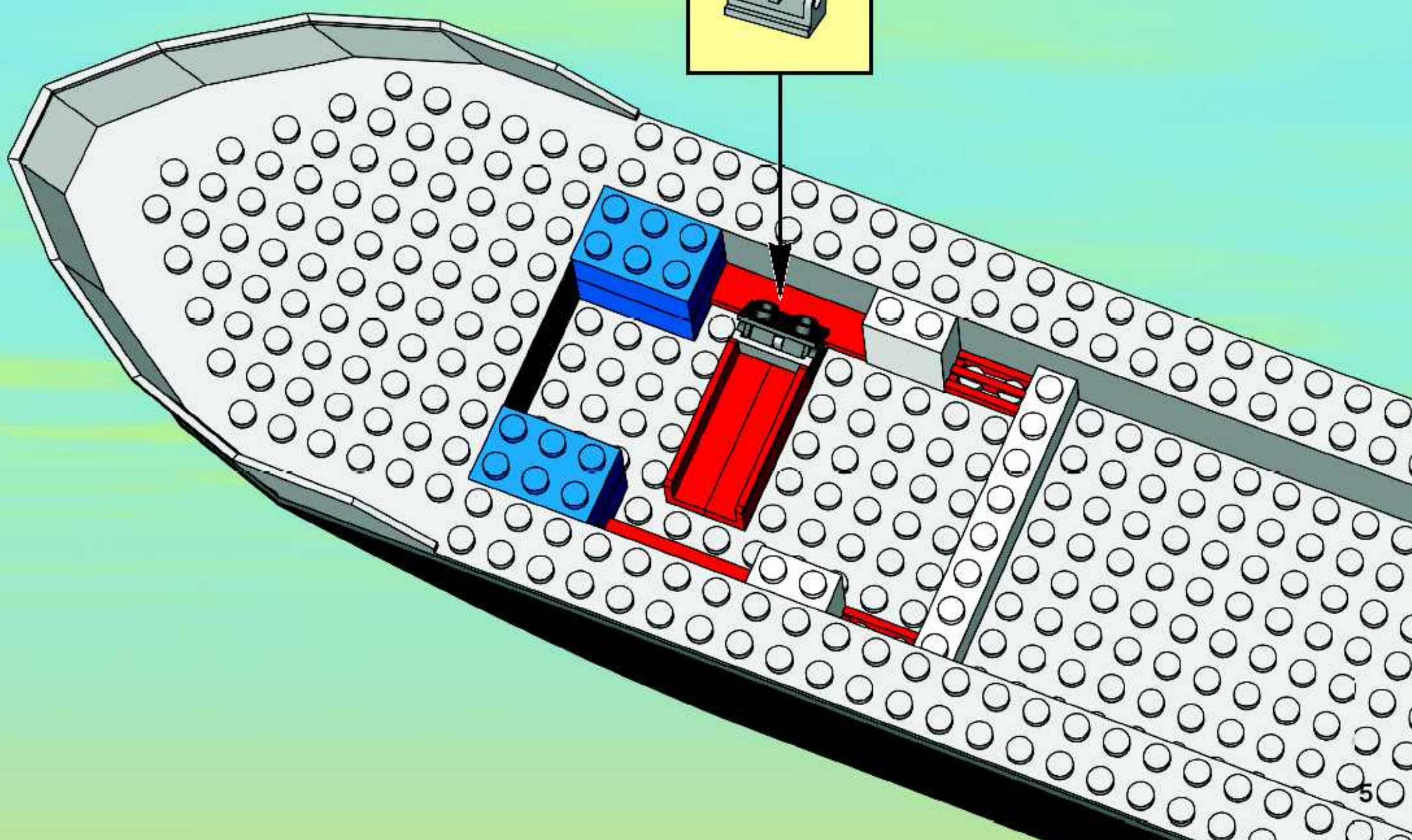

4

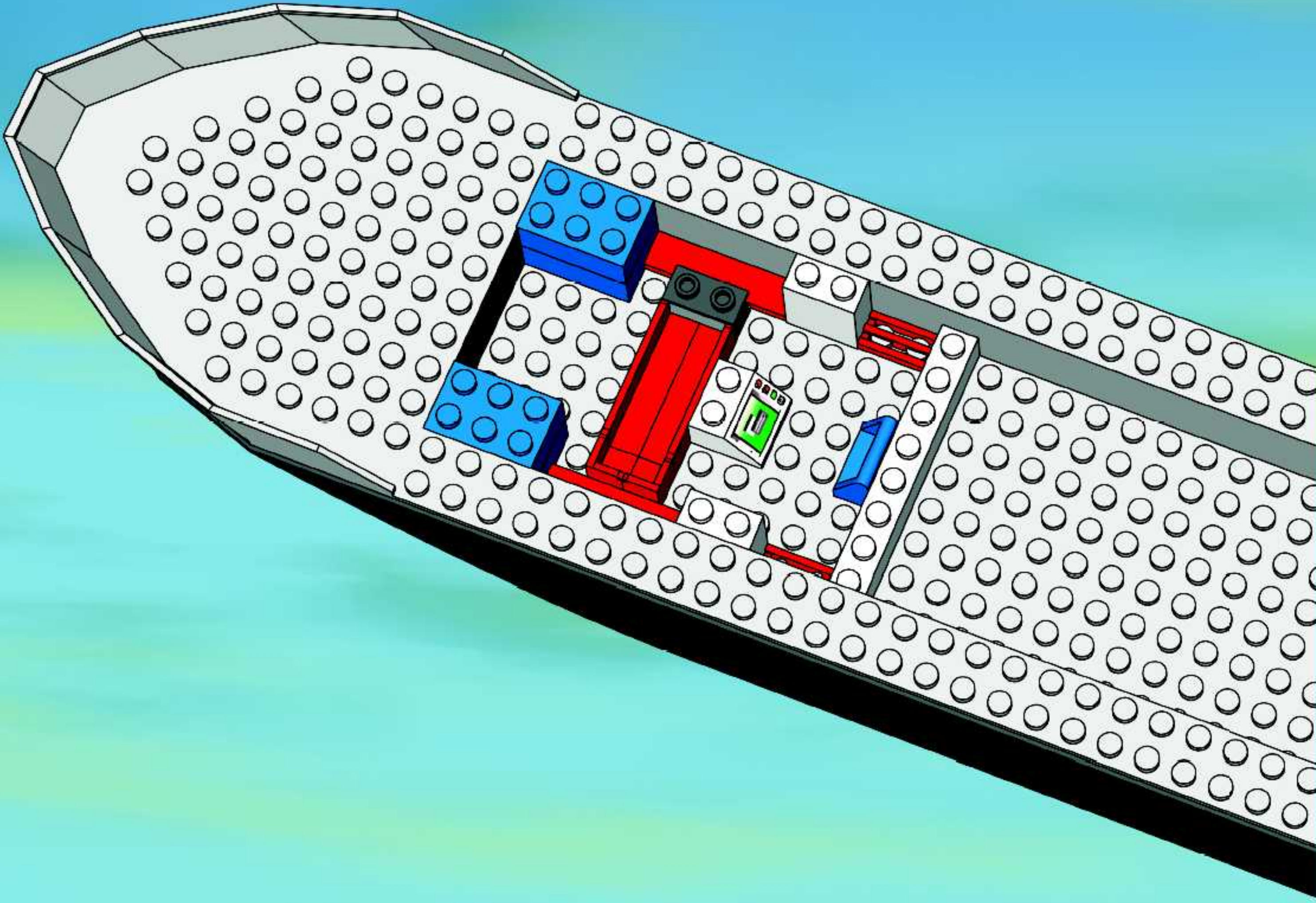

5

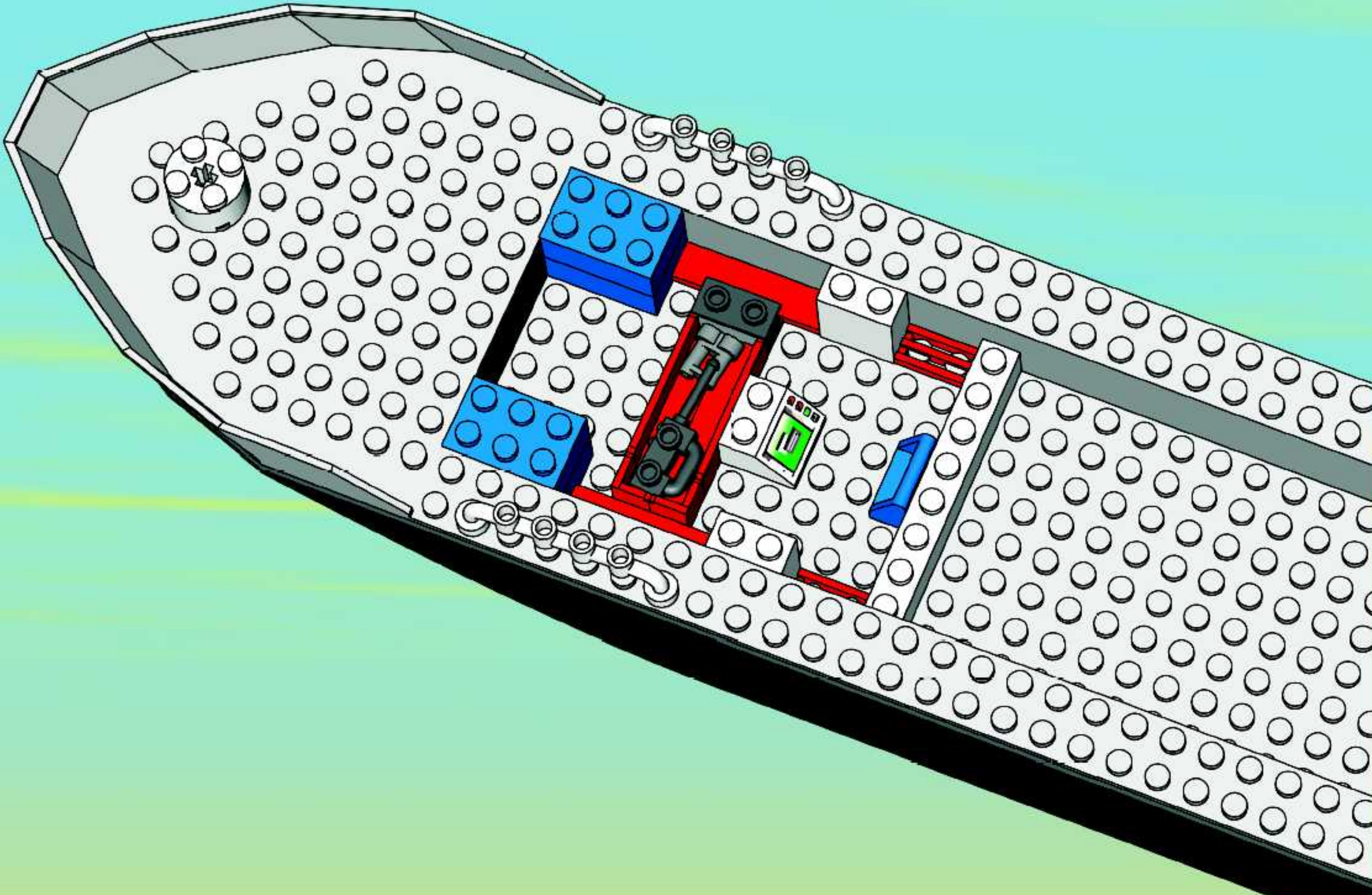

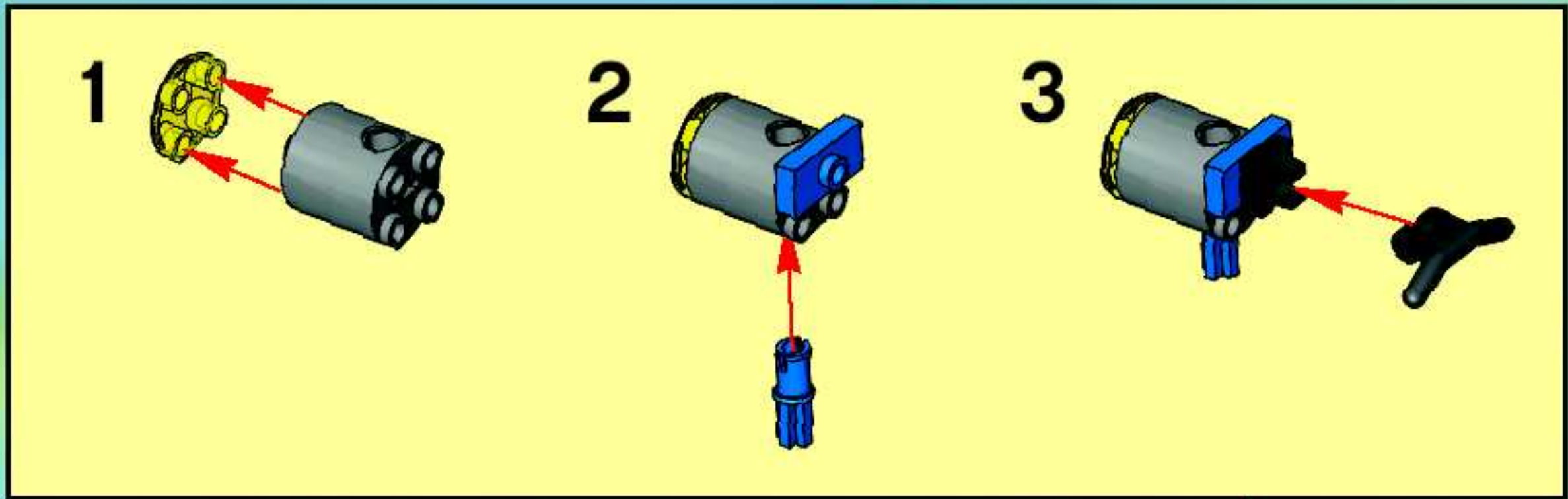

6

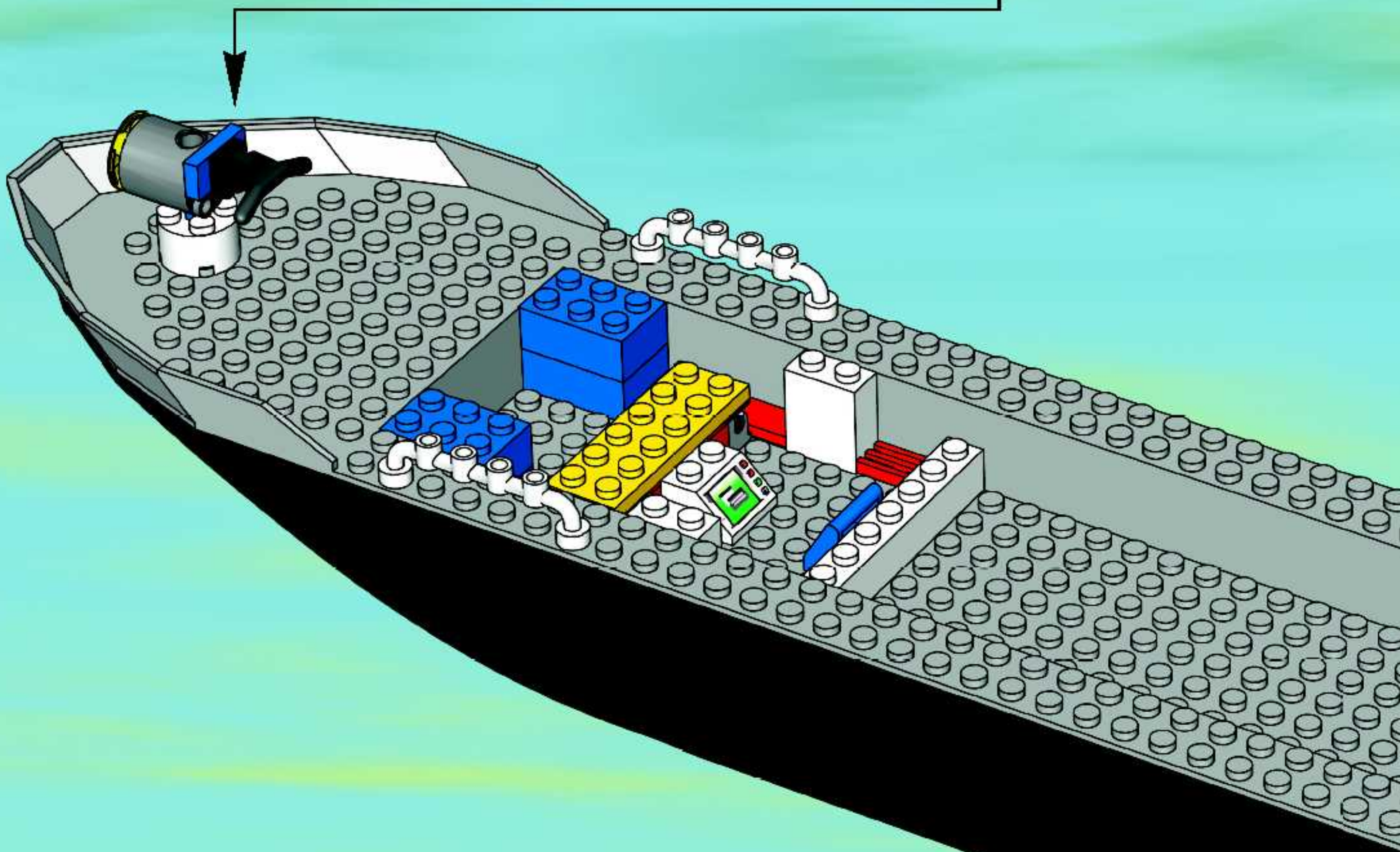

7

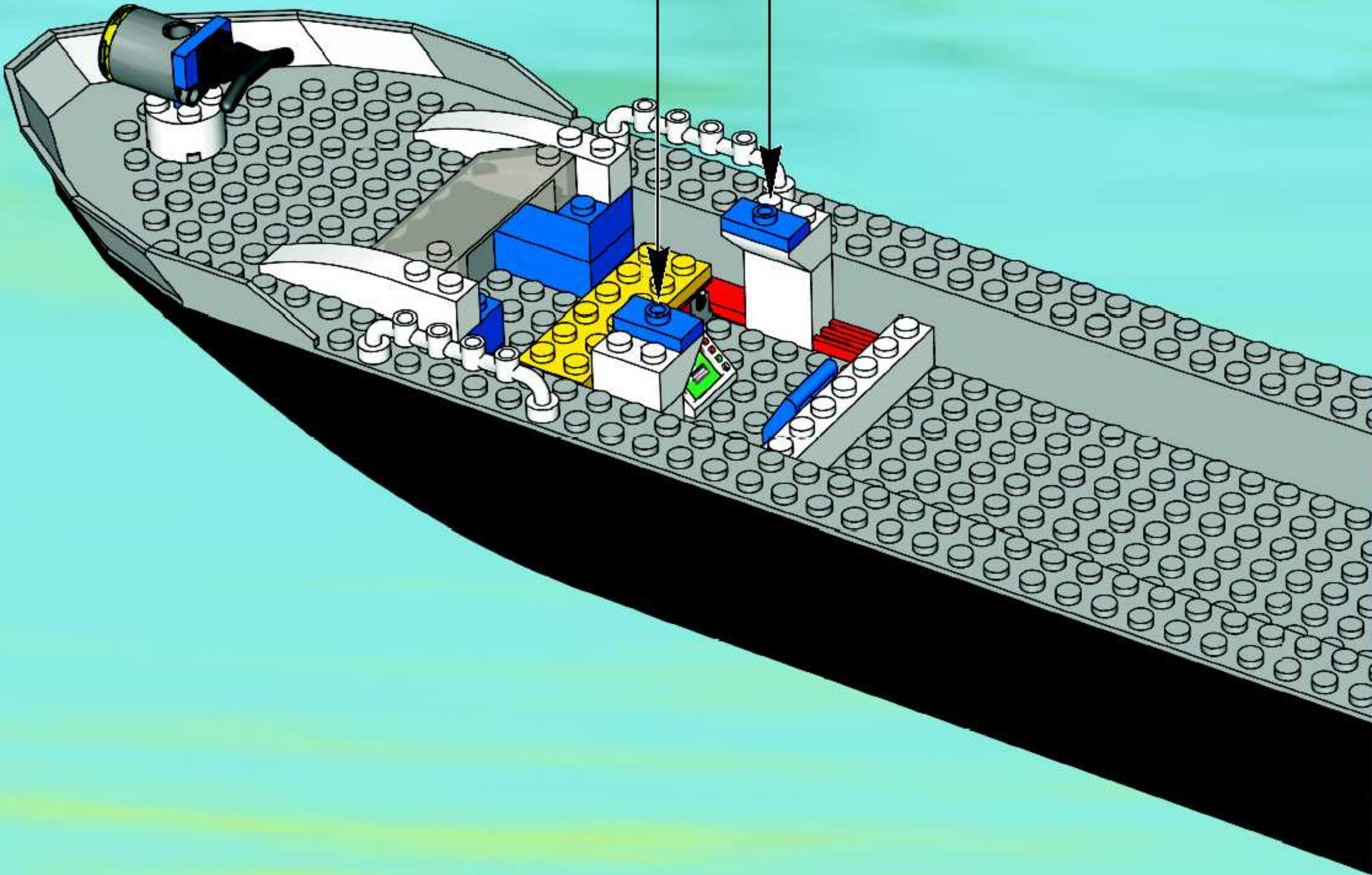
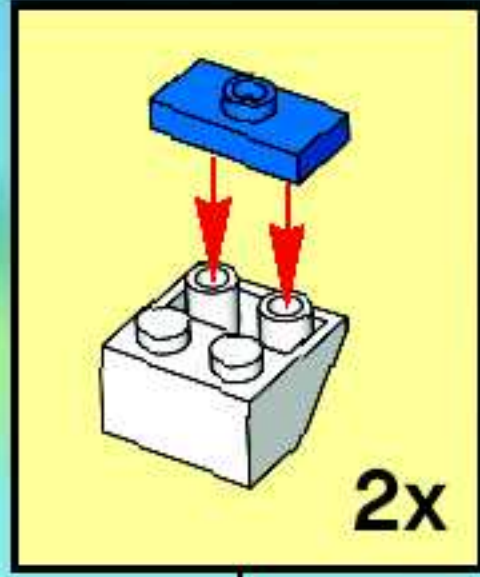

8

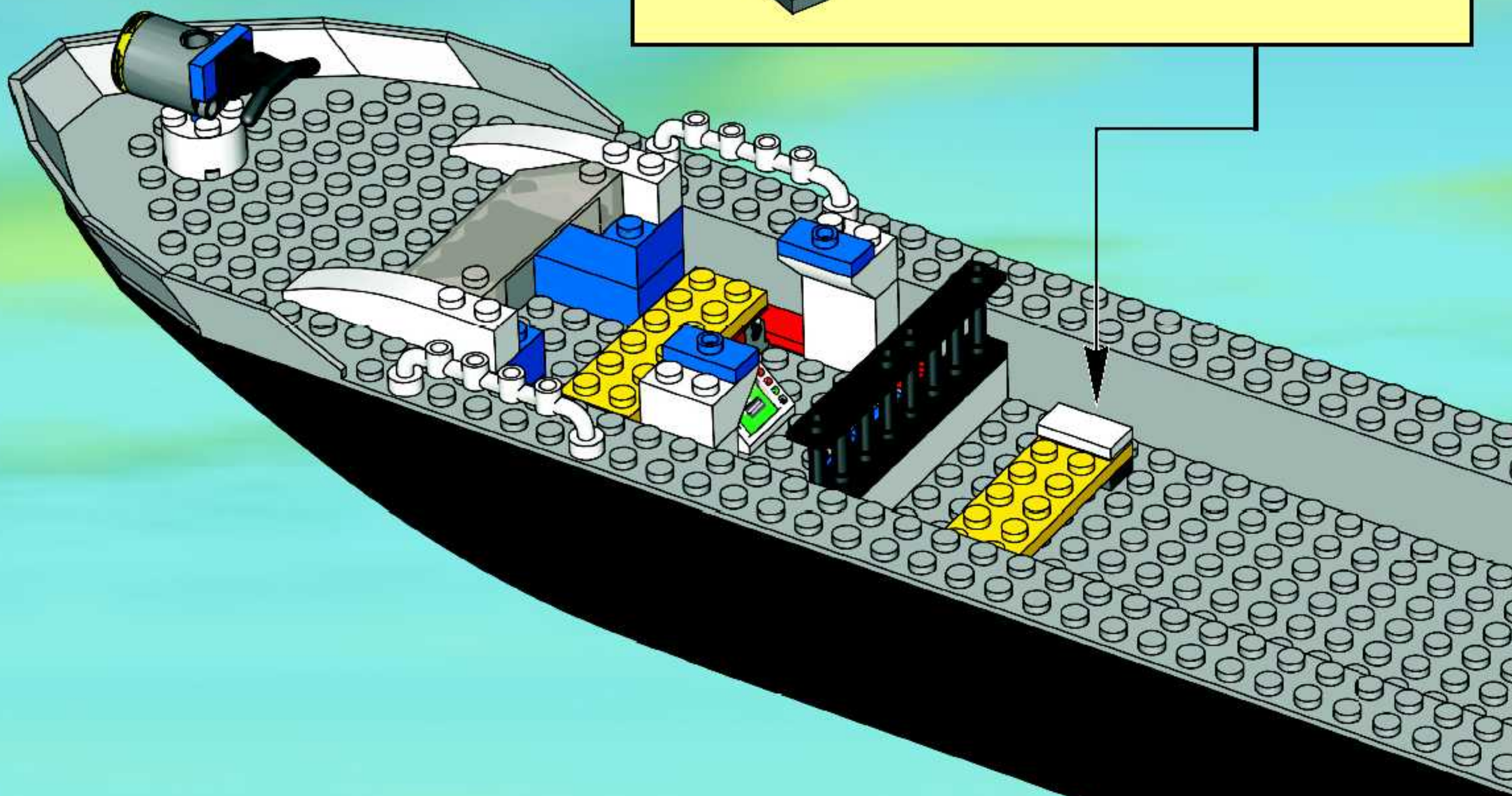
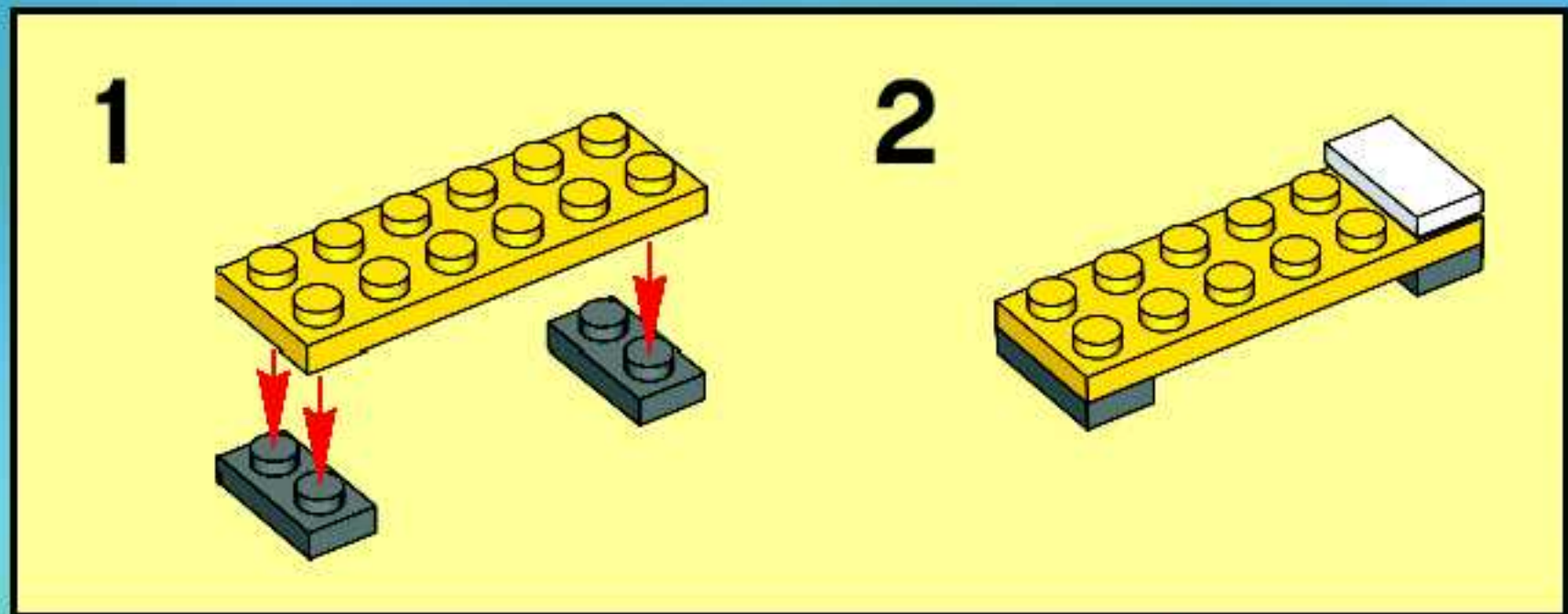

9

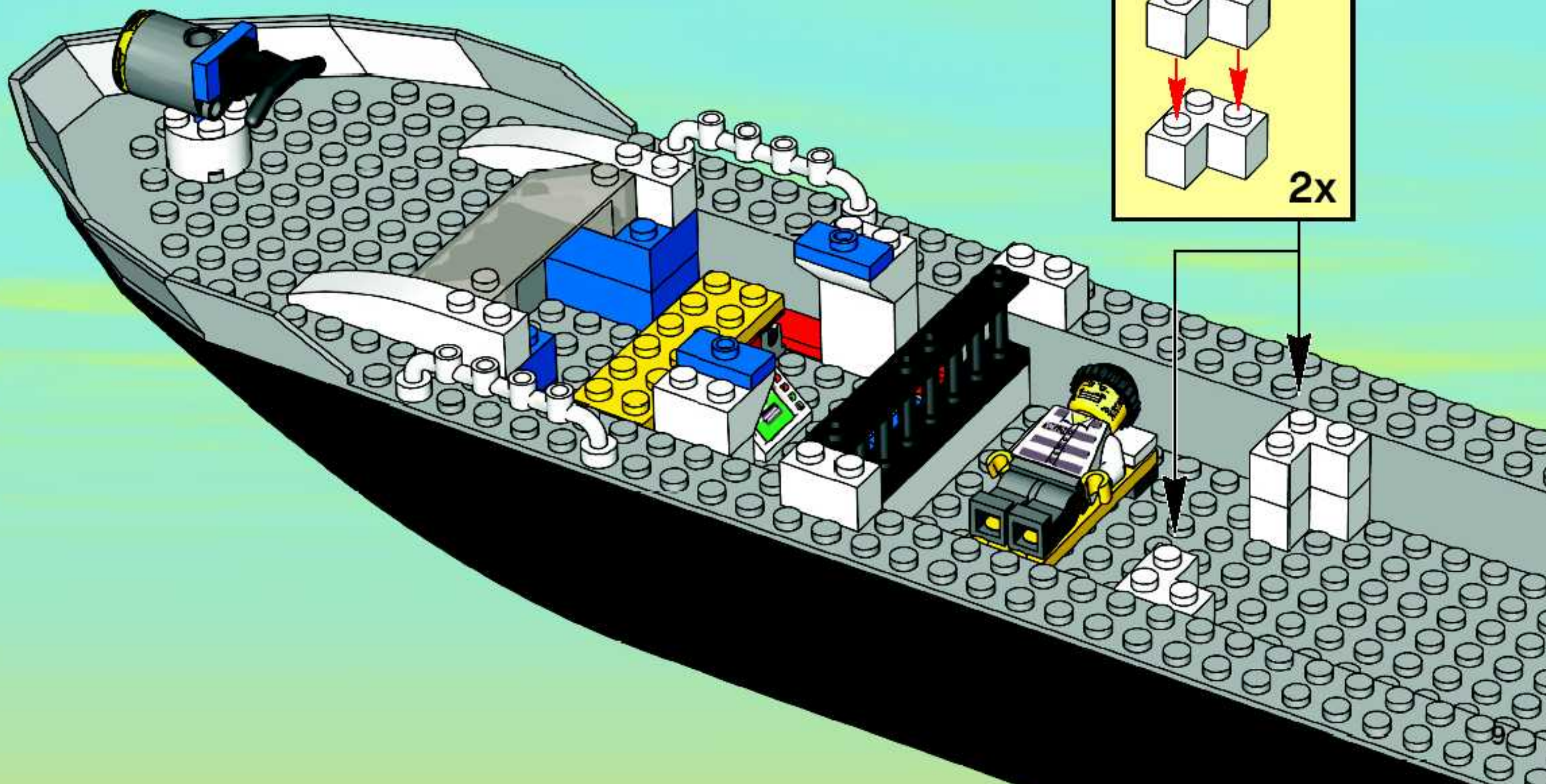
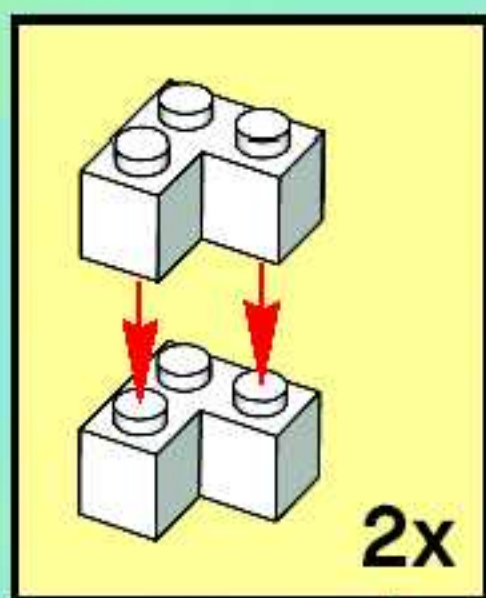

10

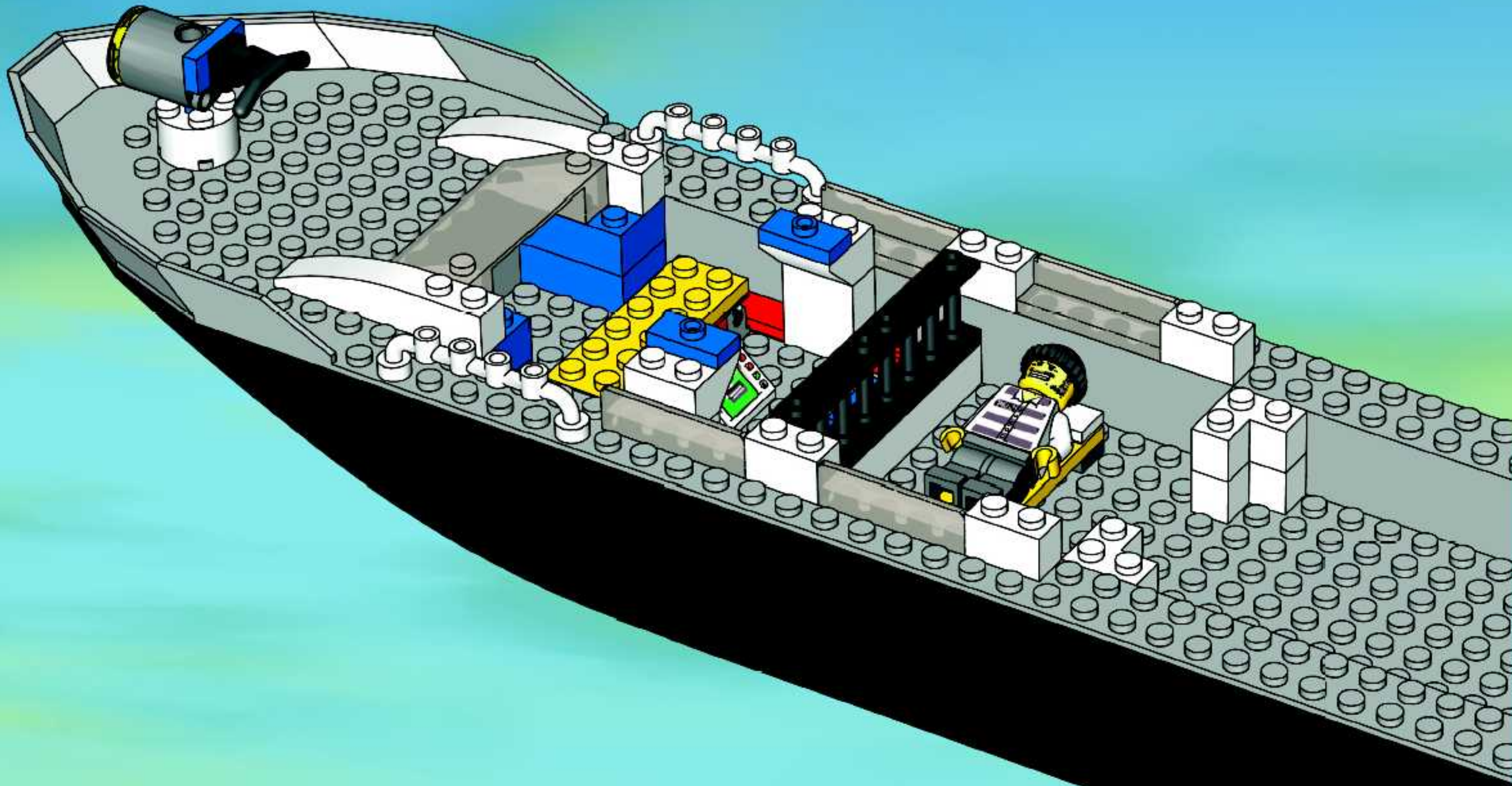

11

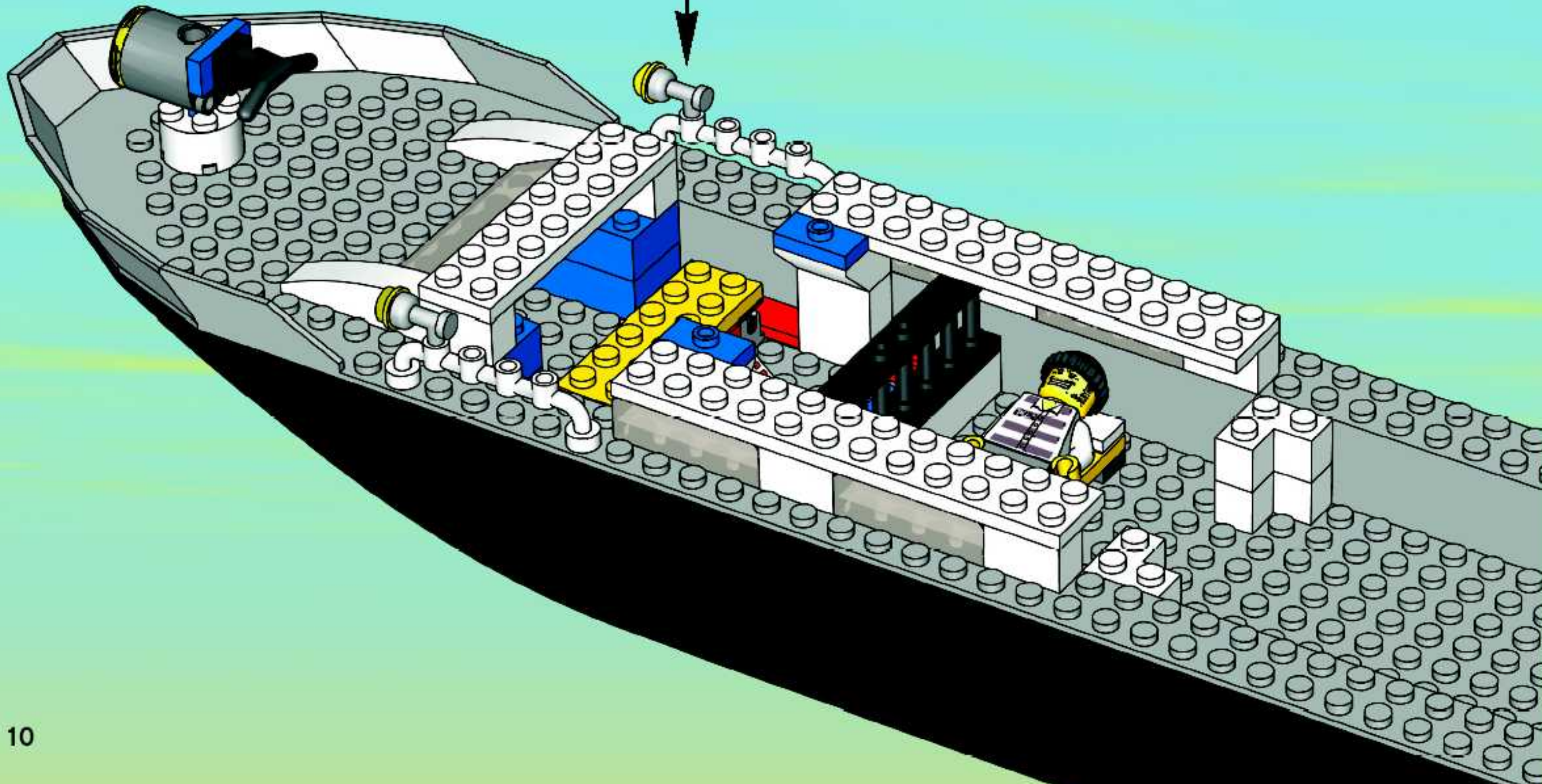
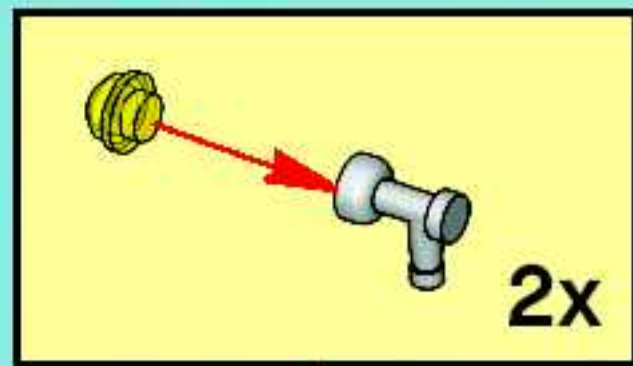

12

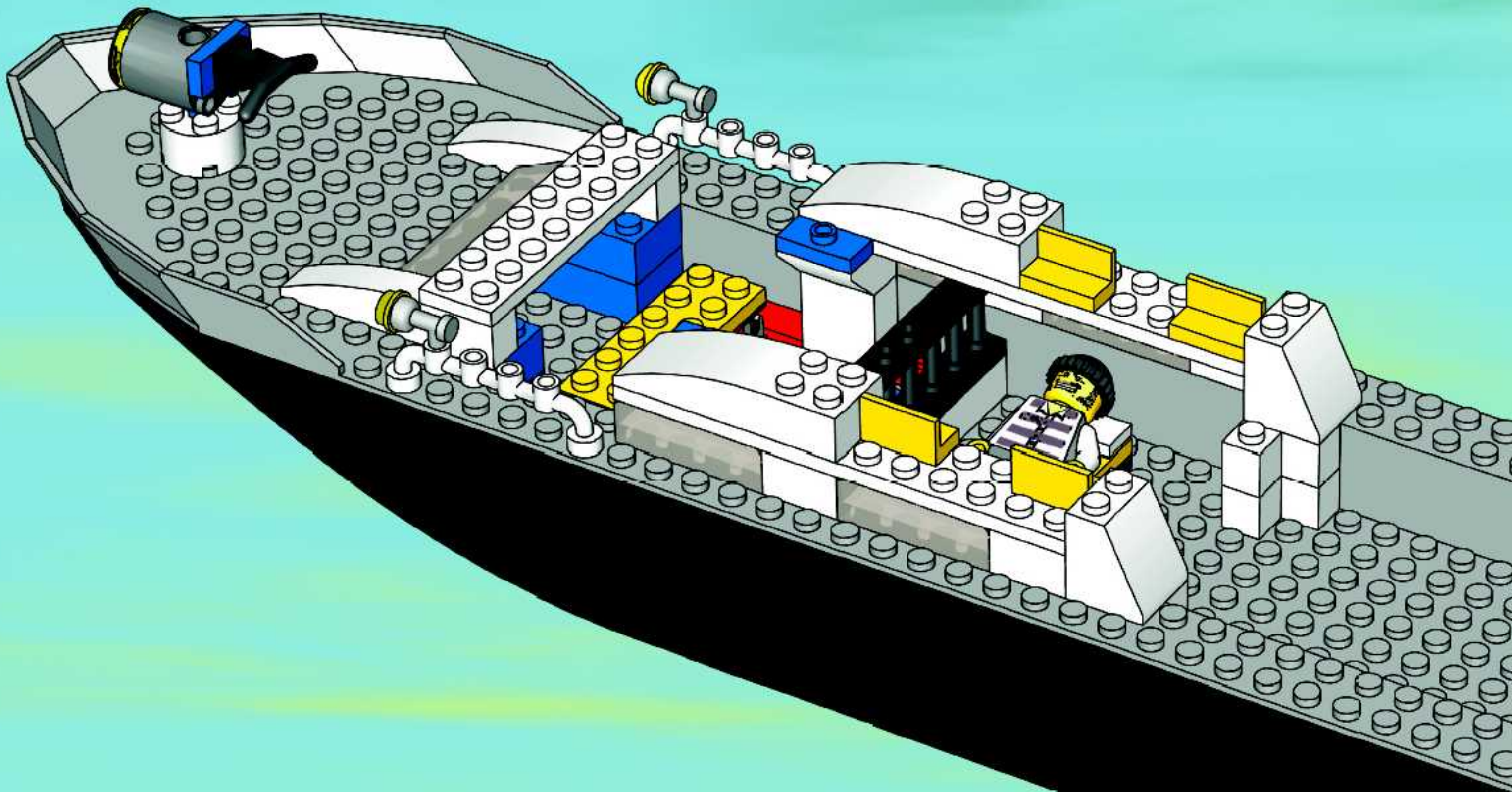

13

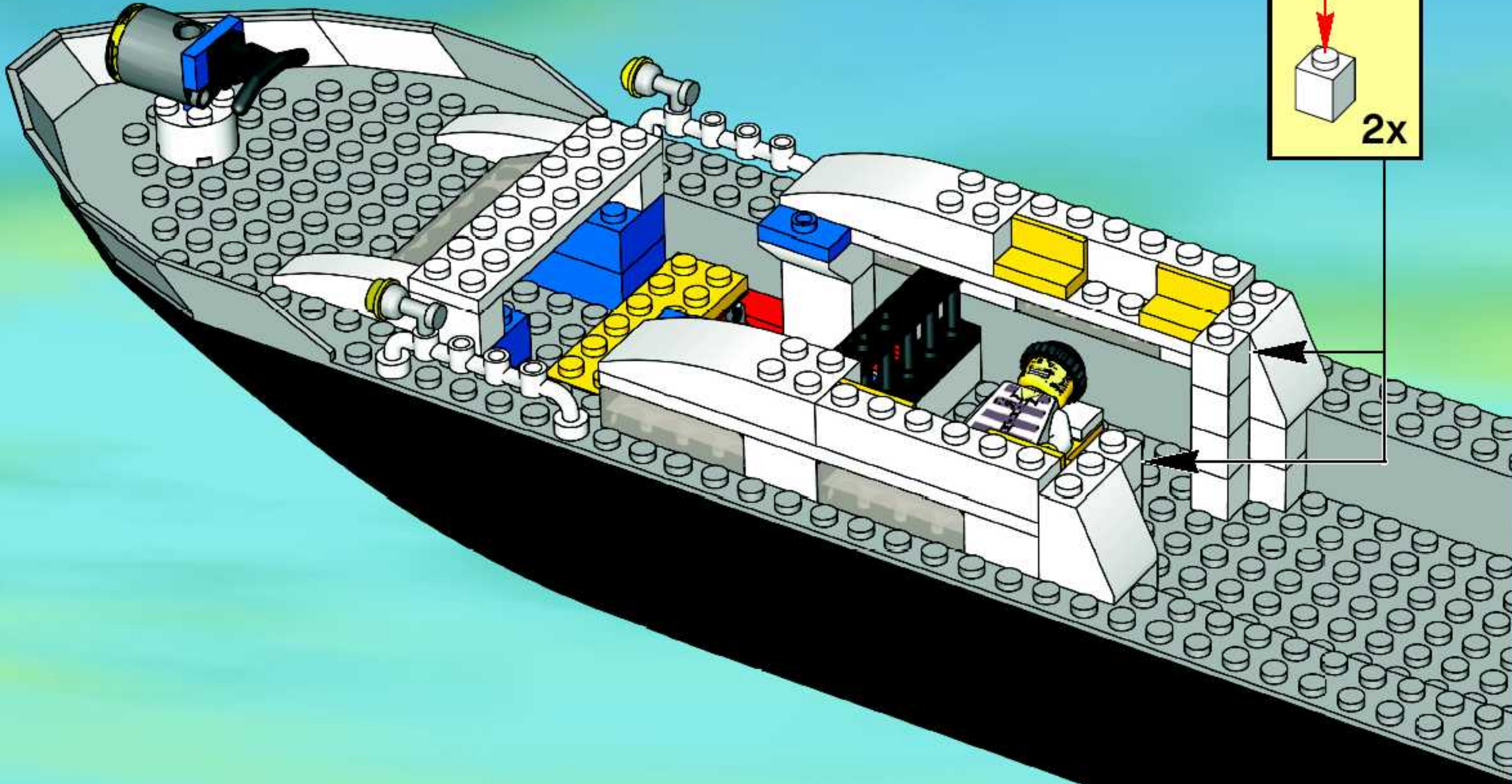

14

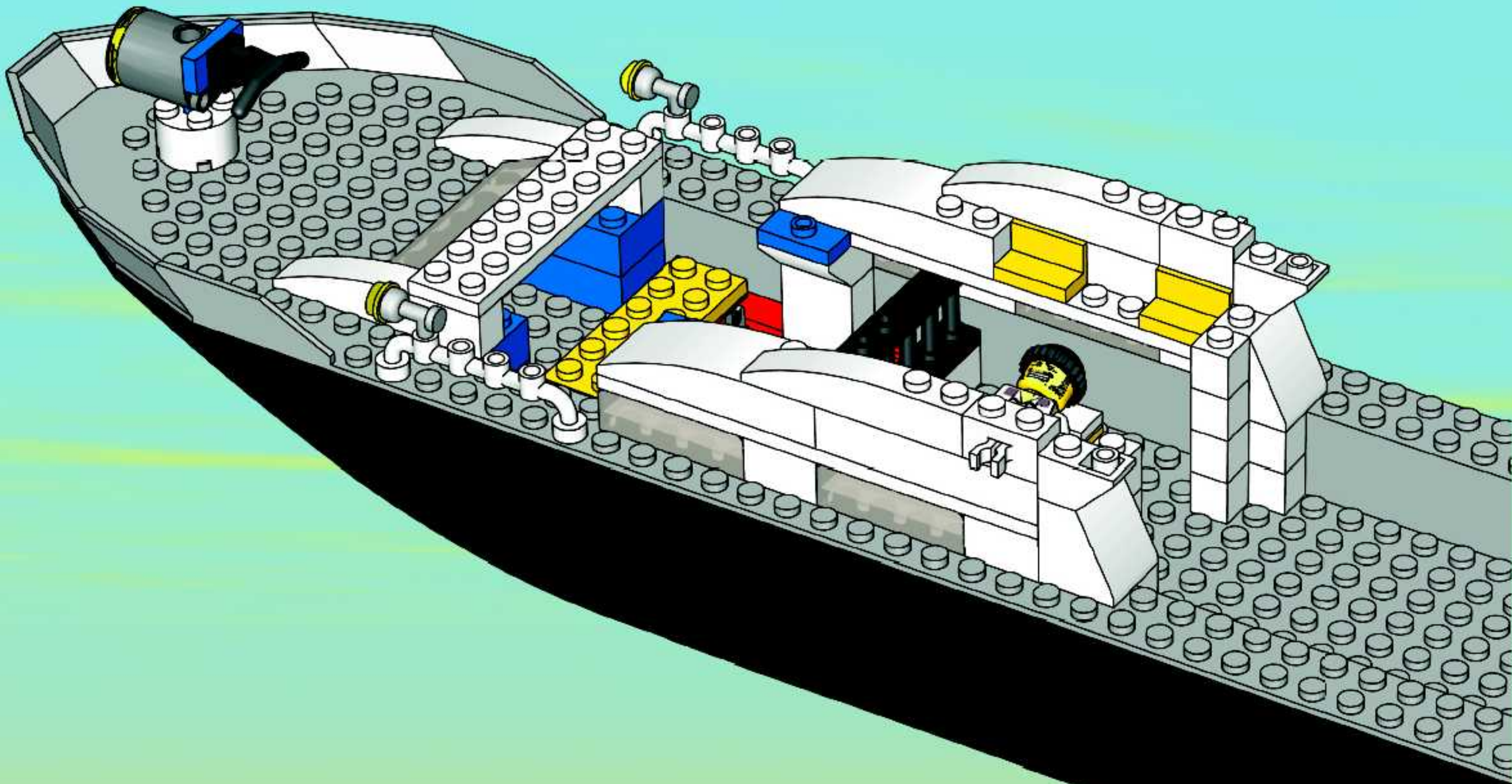

1

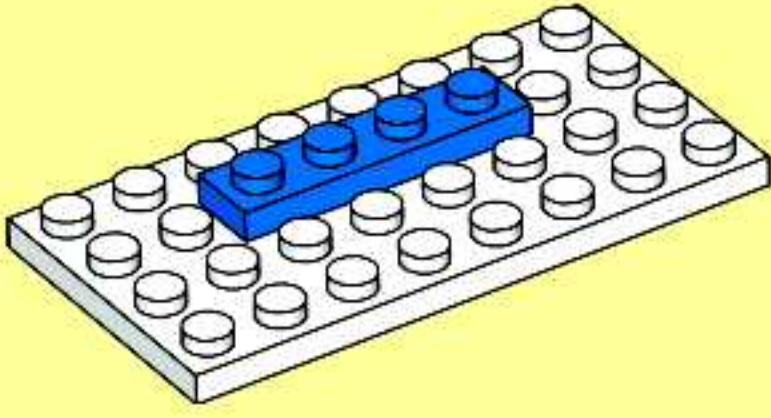

2

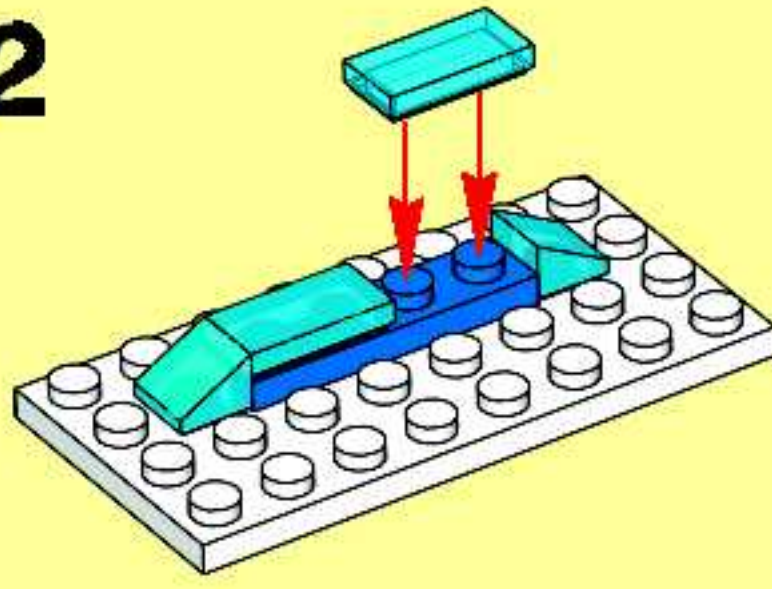

3

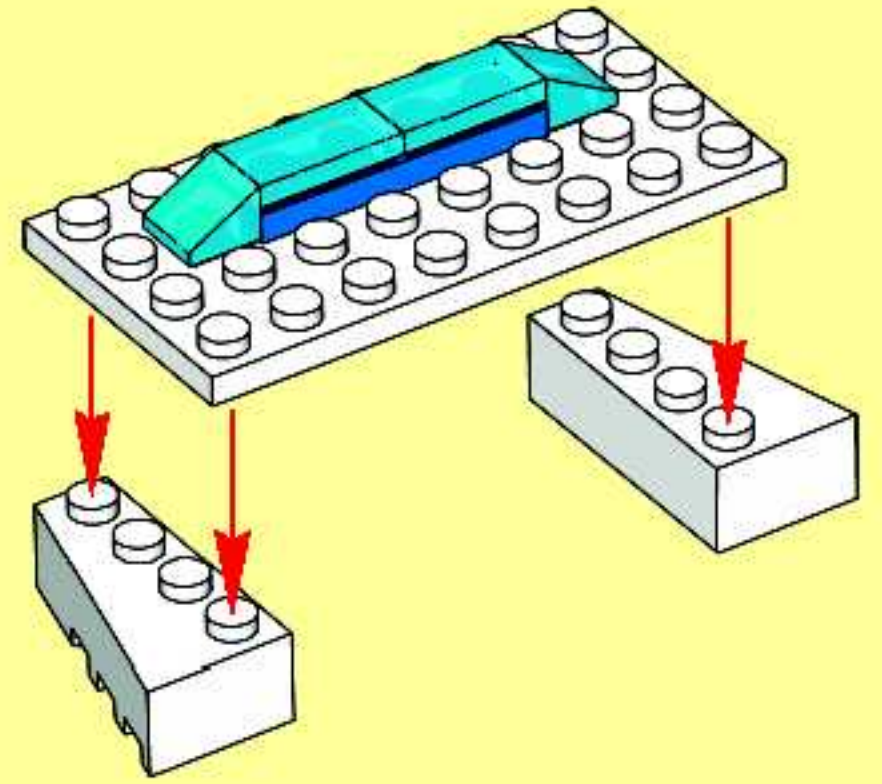

15

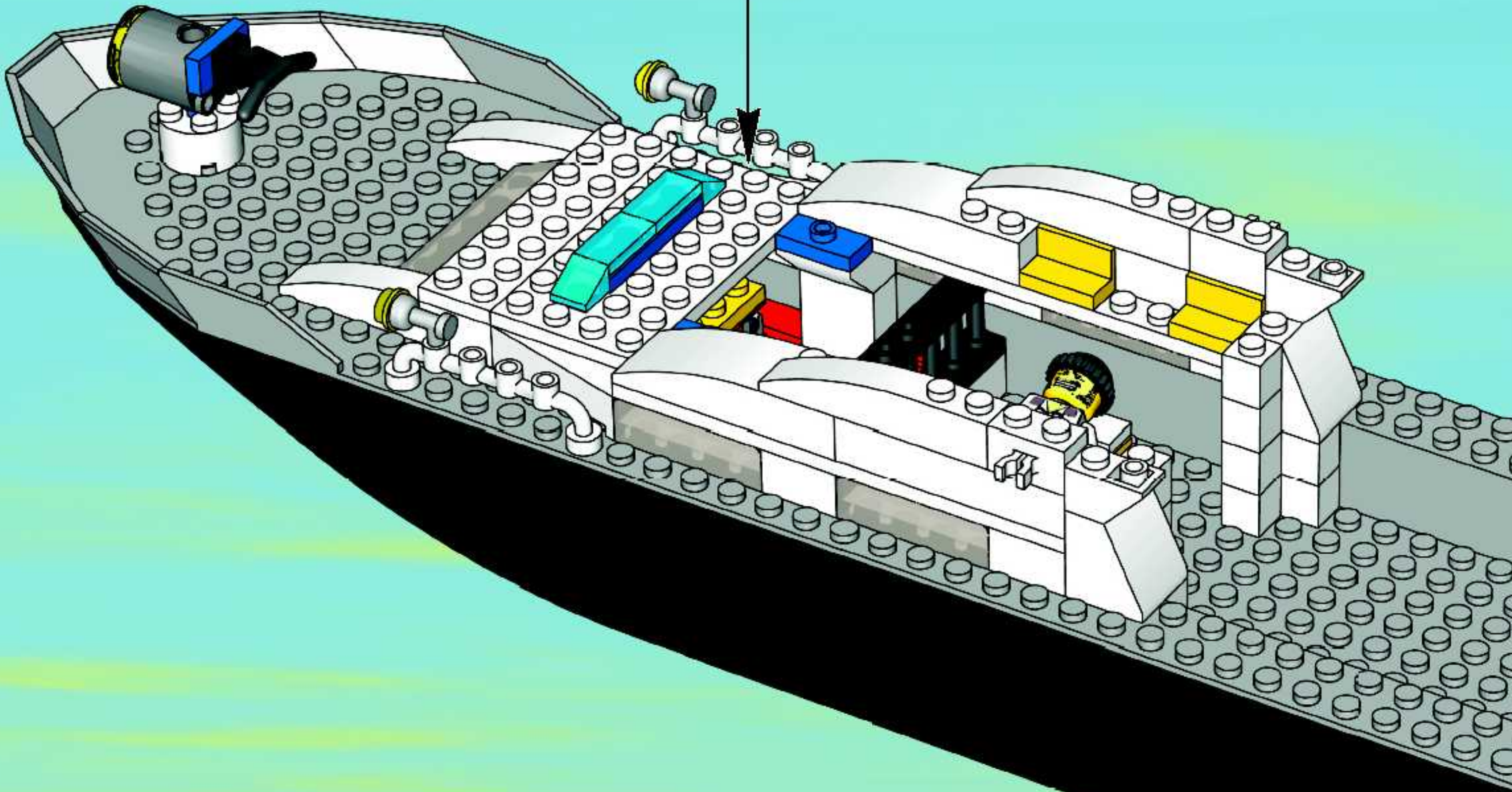

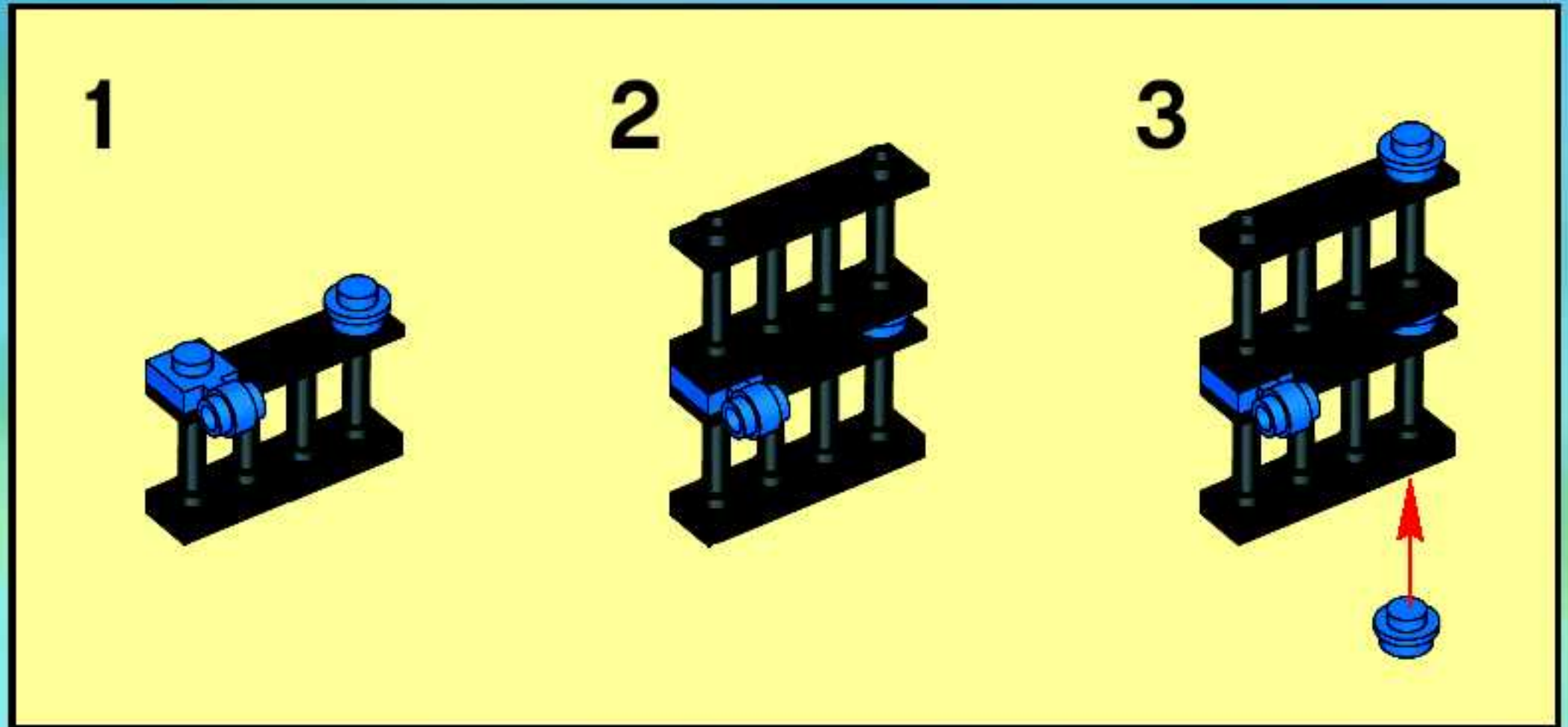

16

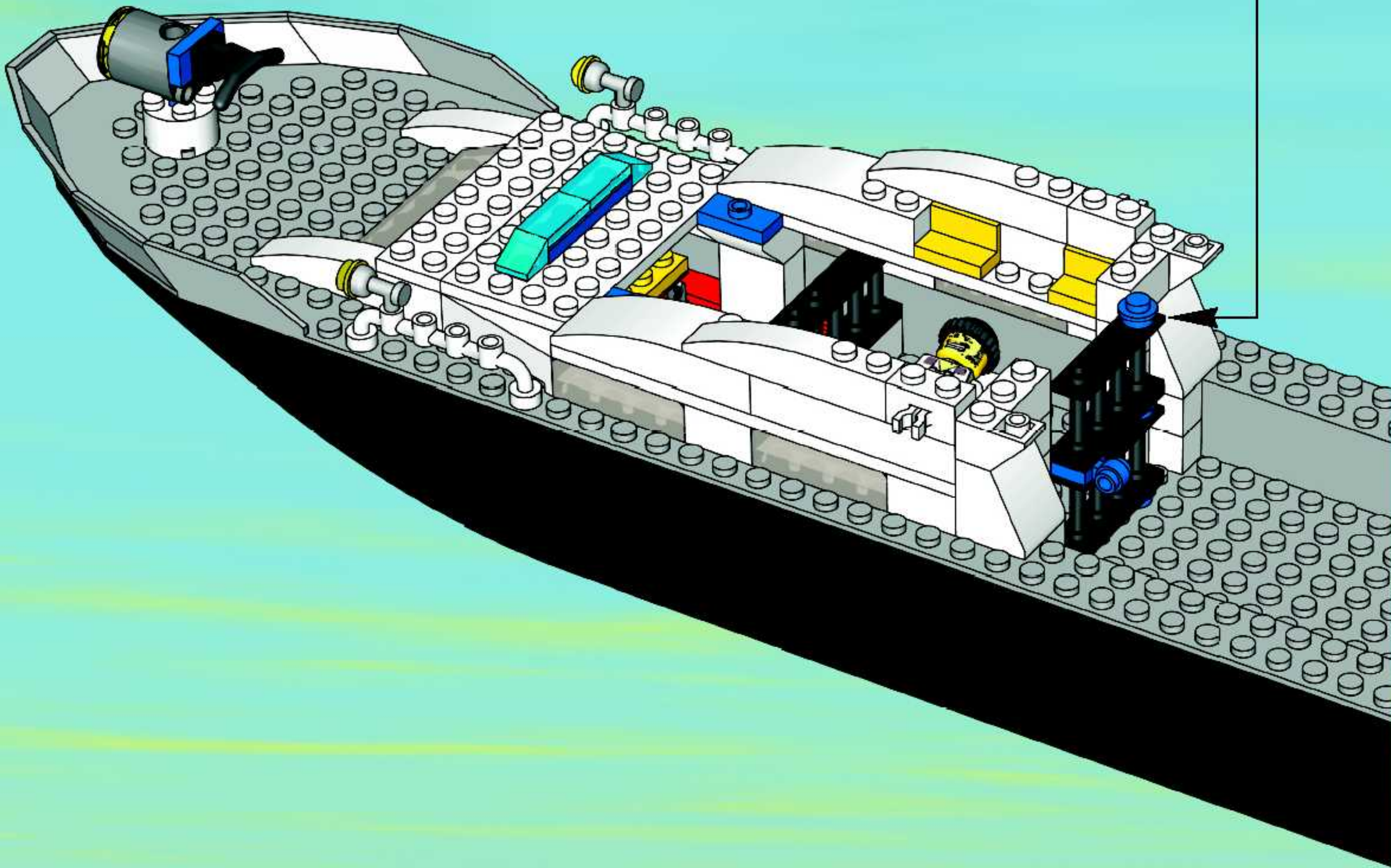

17

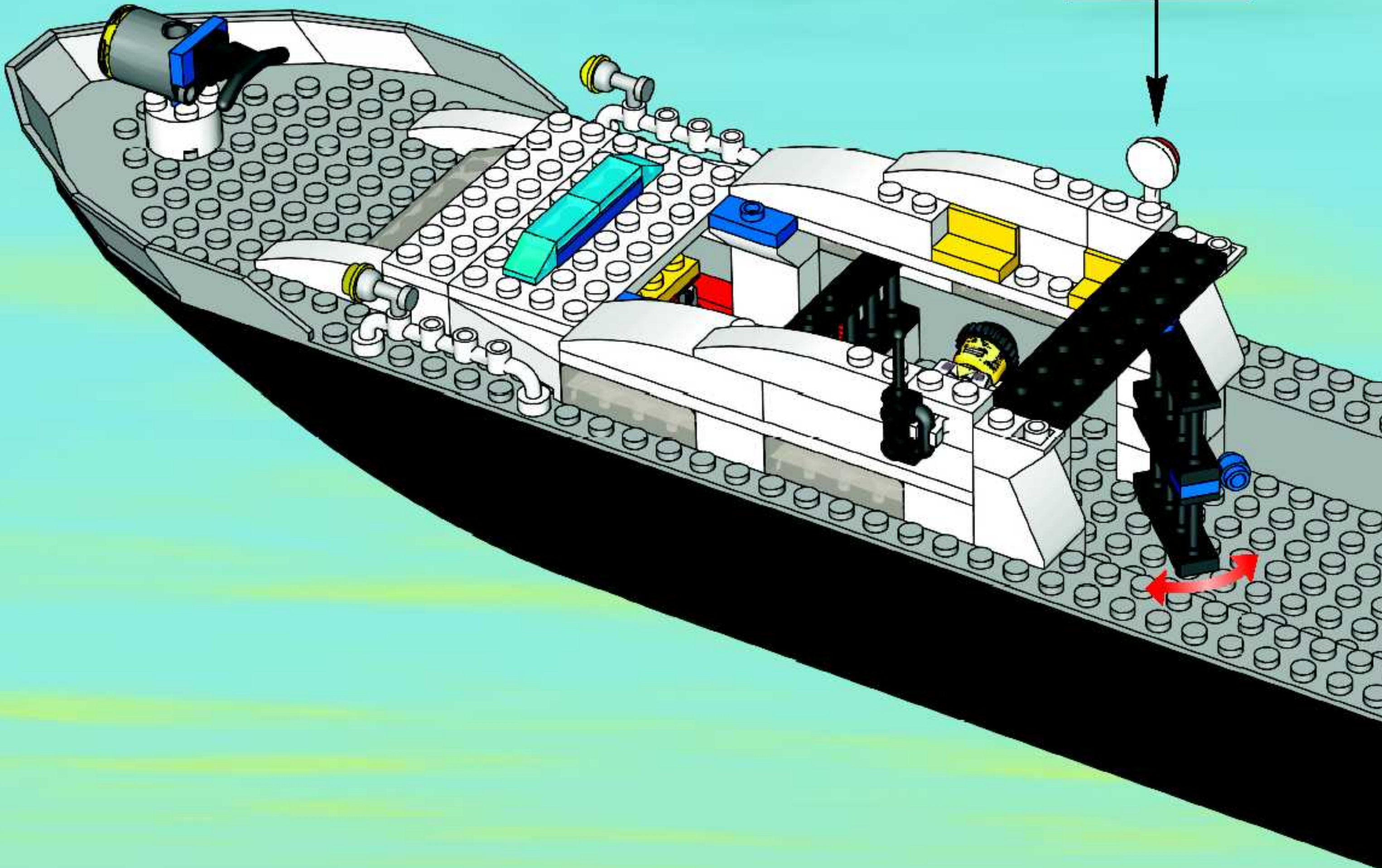
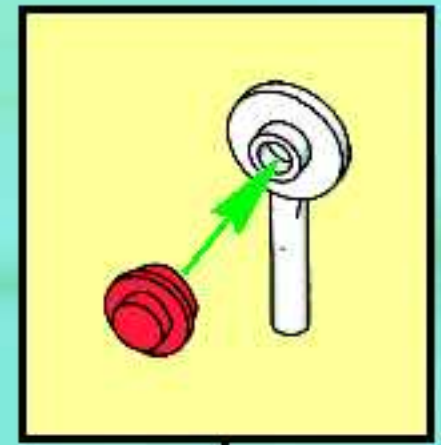

3

ATTENTION: To avoid damage to your eyes, keep the bag away from babies, children and pets.

ATTENZIONE: Per evitare danni agli occhi, tenere lontano i bambini e gli animali domestici dalla borsa.

© 2010 The LEGO Group

3

ATTENTION: To avoid damage to your eyes, keep the bag away from babies, children and pets.

ATTENZIONE: Per evitare danni agli occhi, tenere lontano i bambini e gli animali domestici dalla borsa.

© 2010 The LEGO Group

18

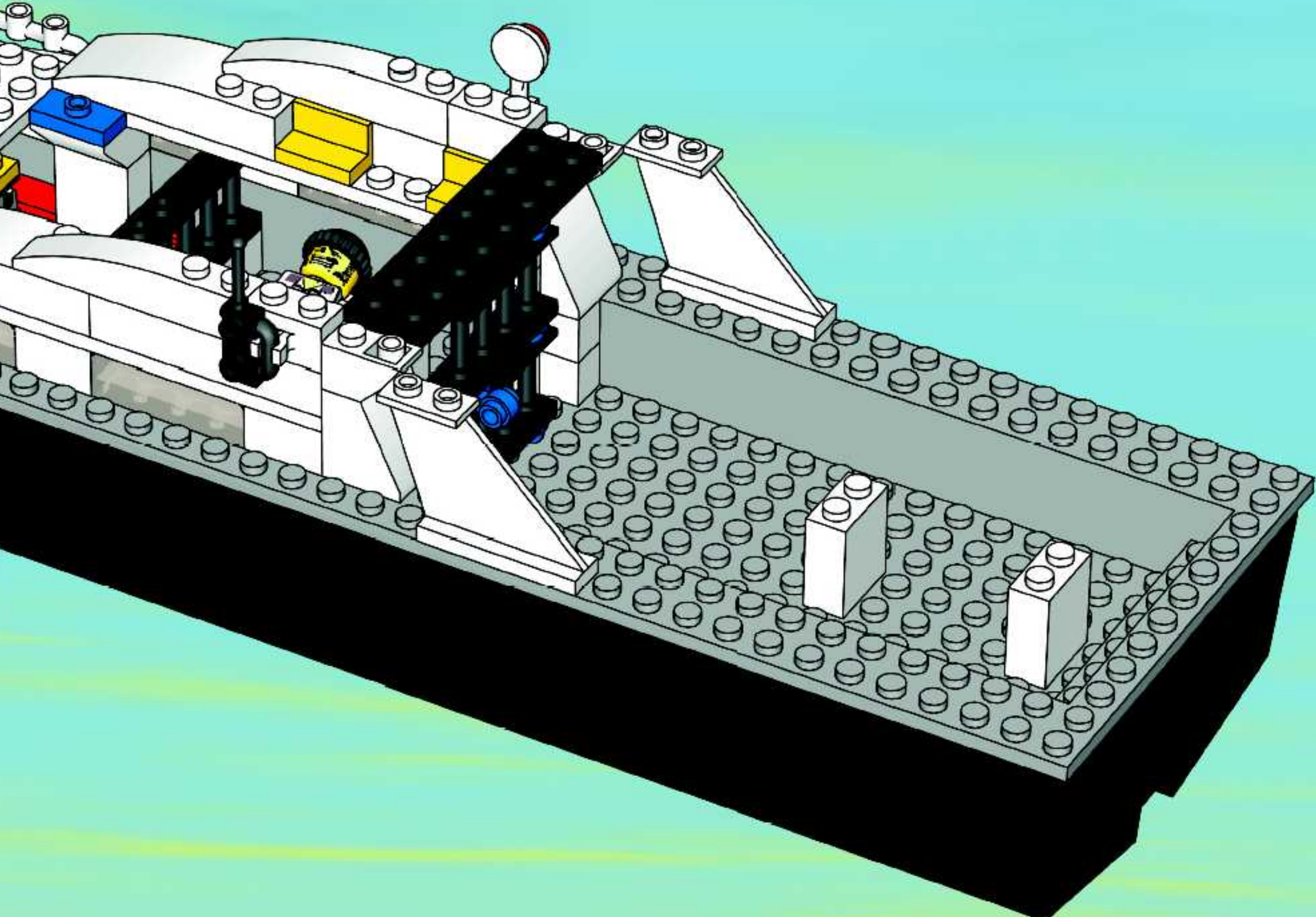

19

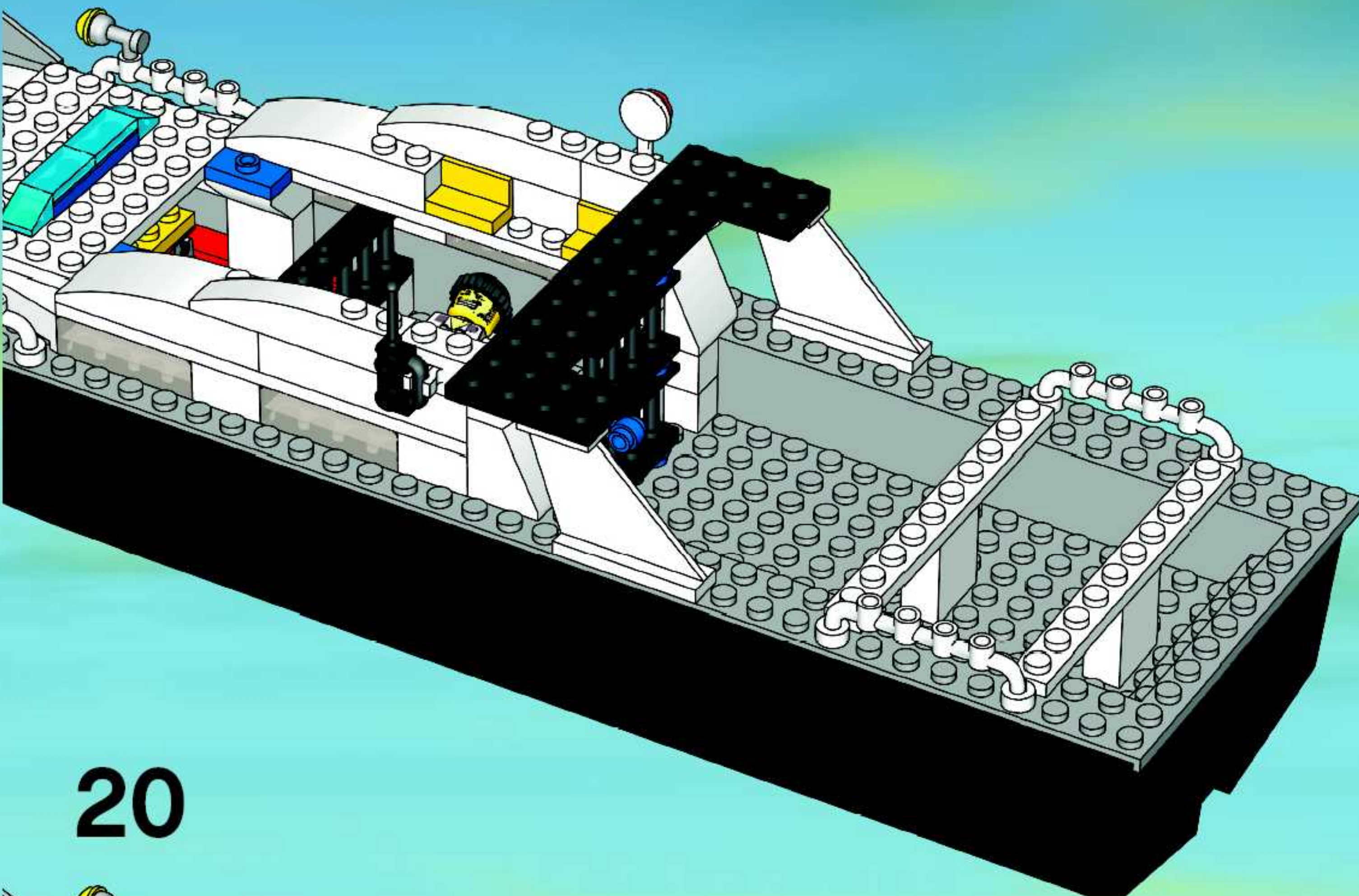

20

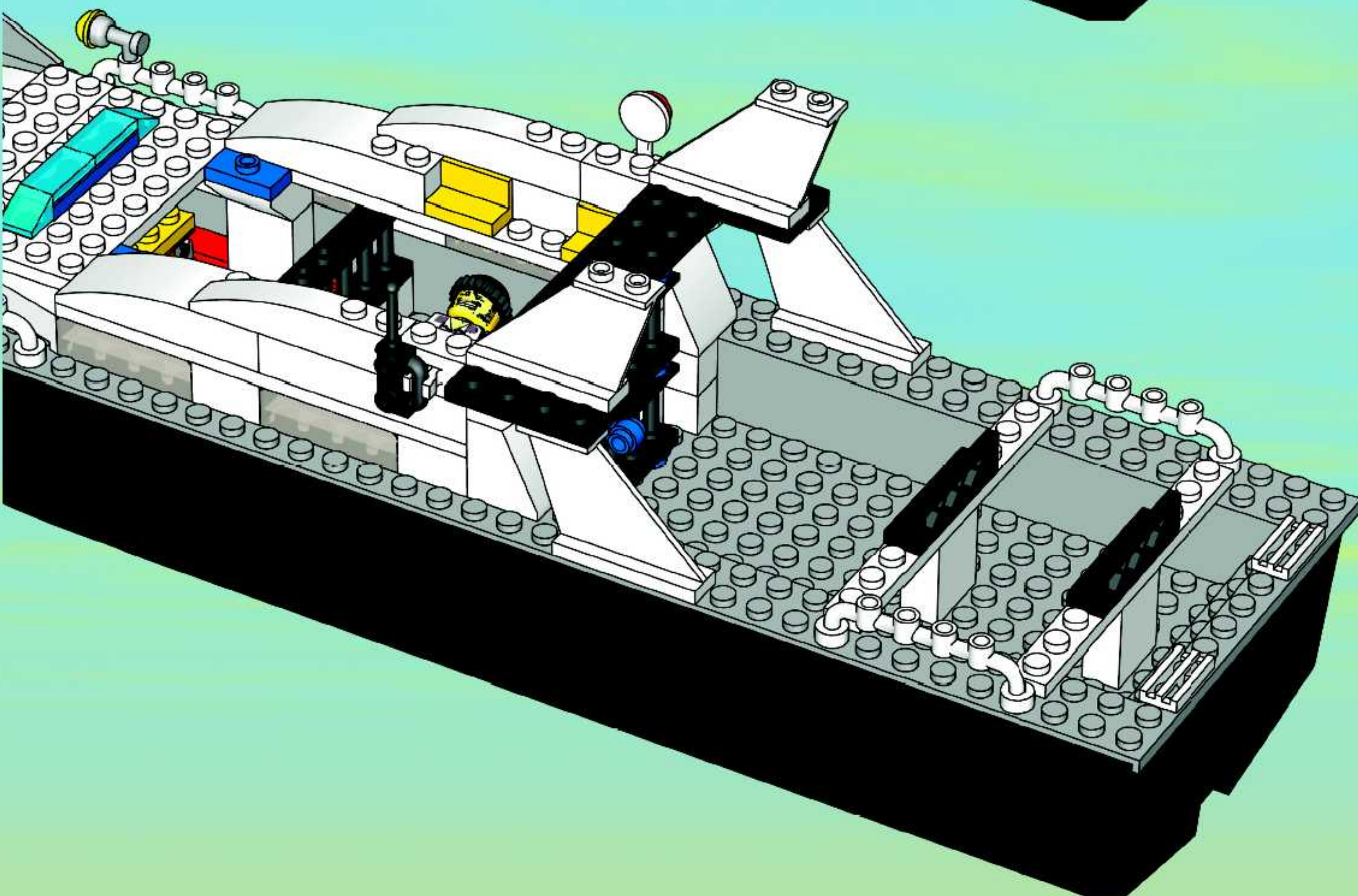

1

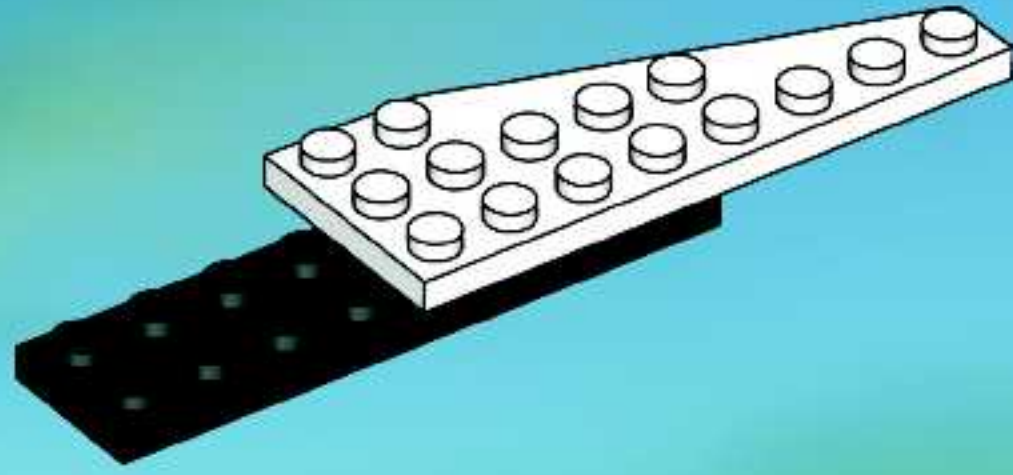

2

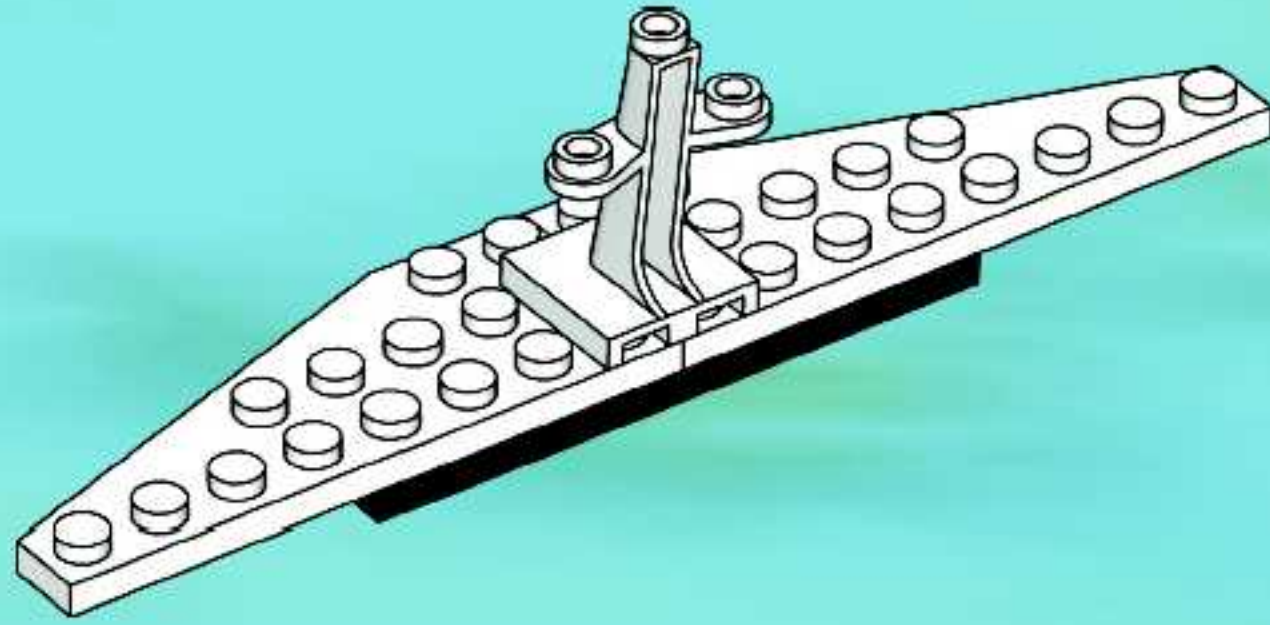

3

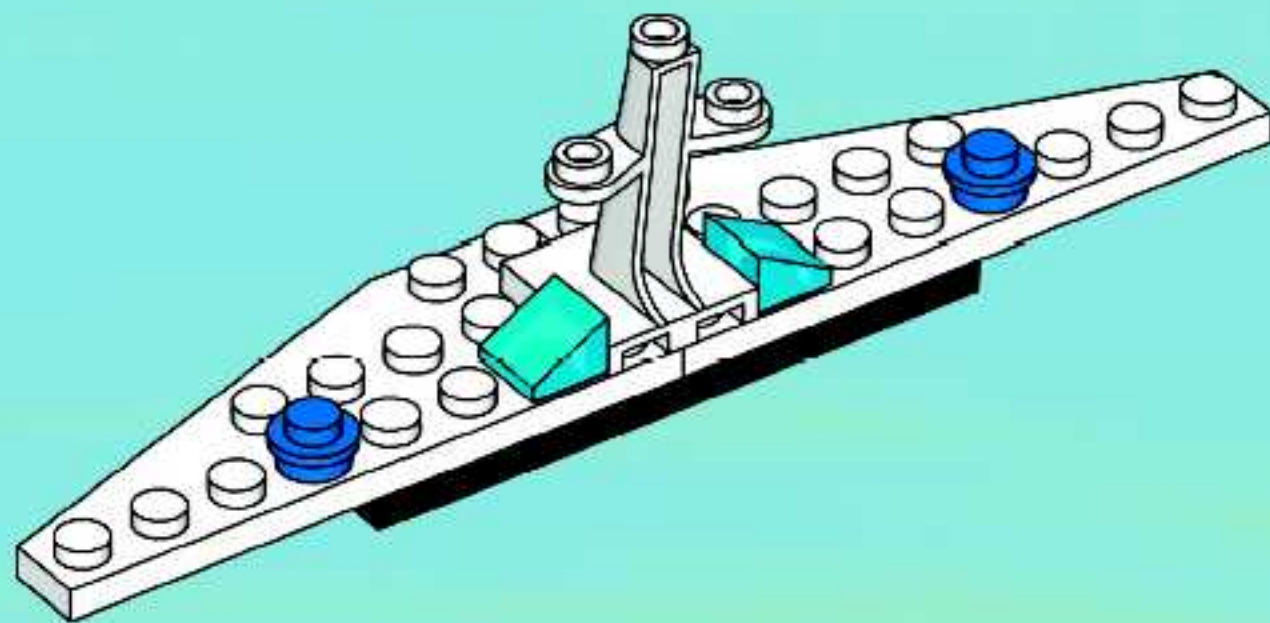

4

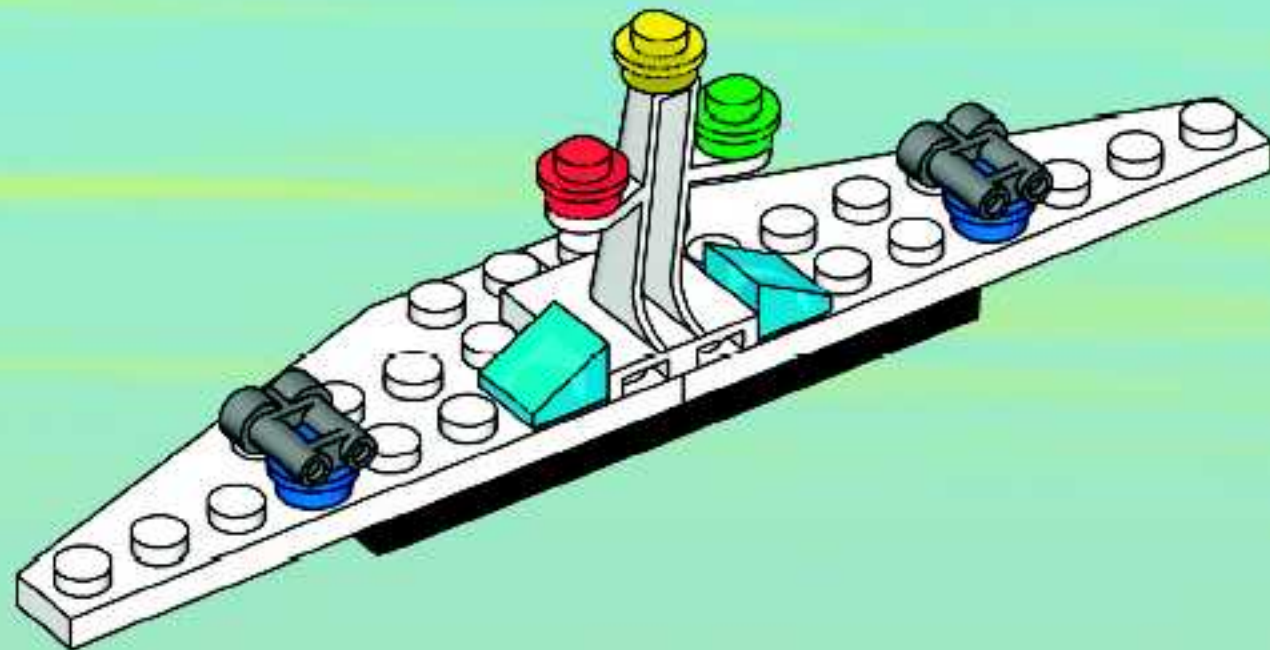

21

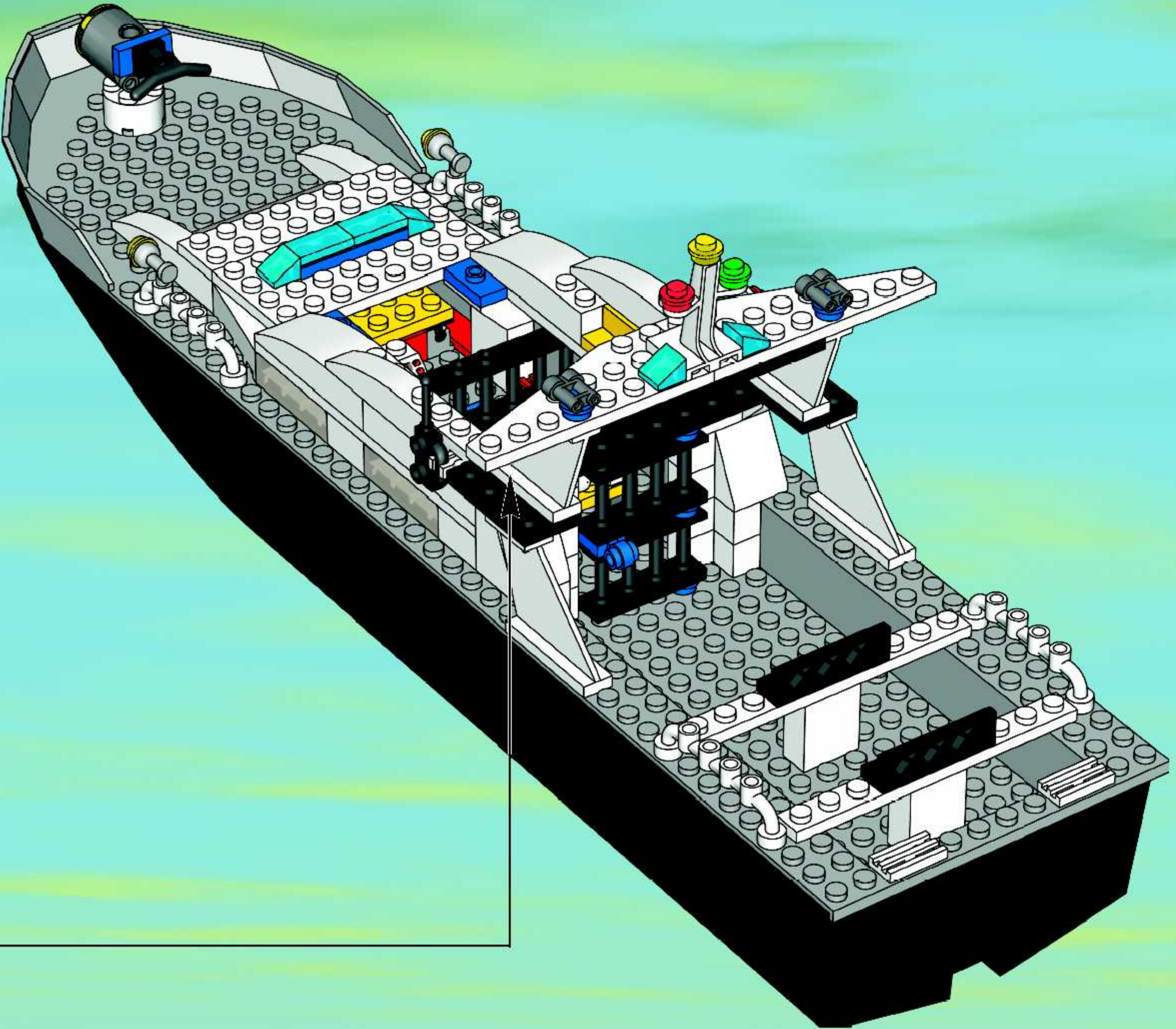

1

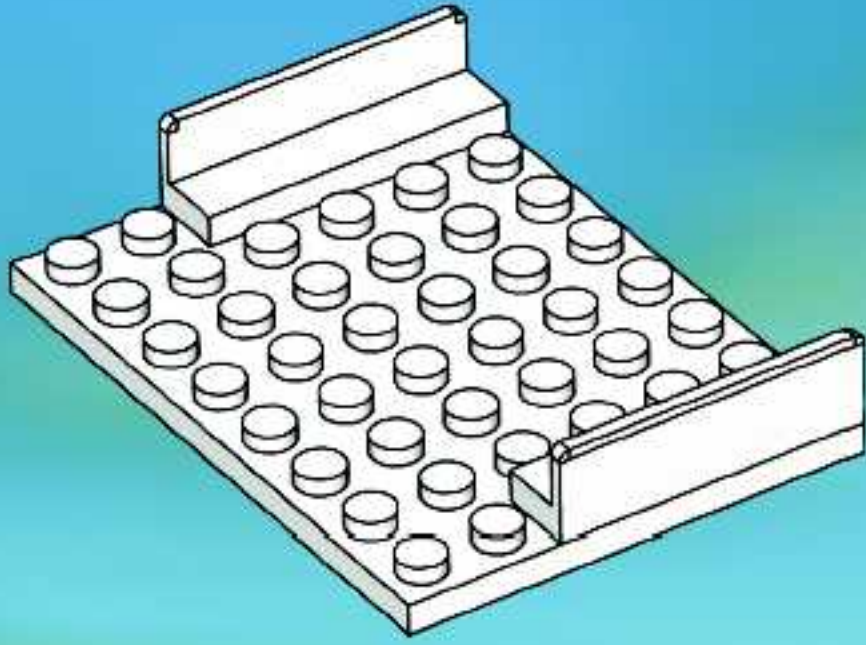

2

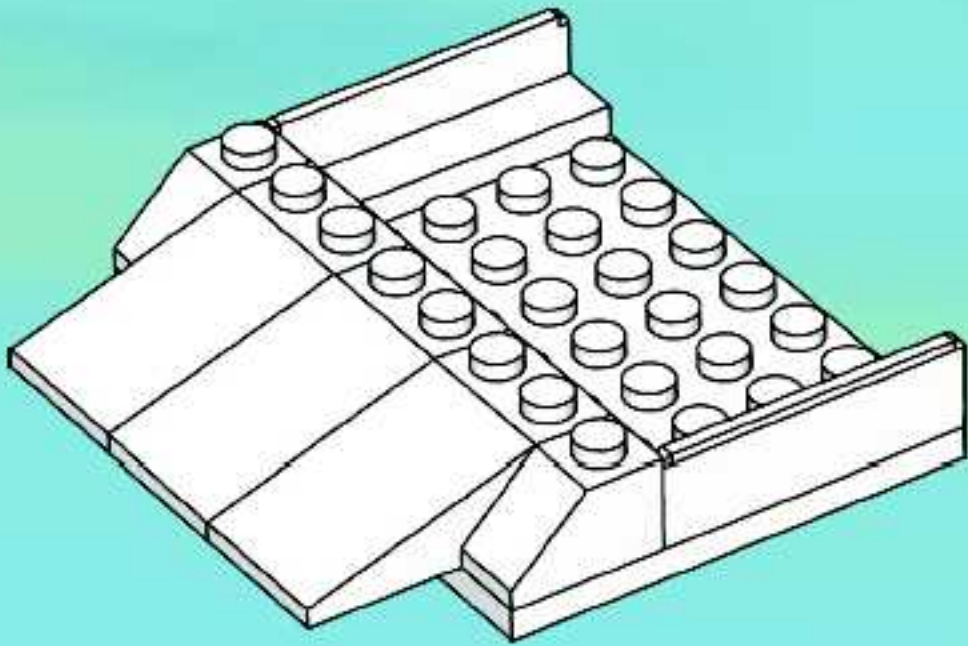

3

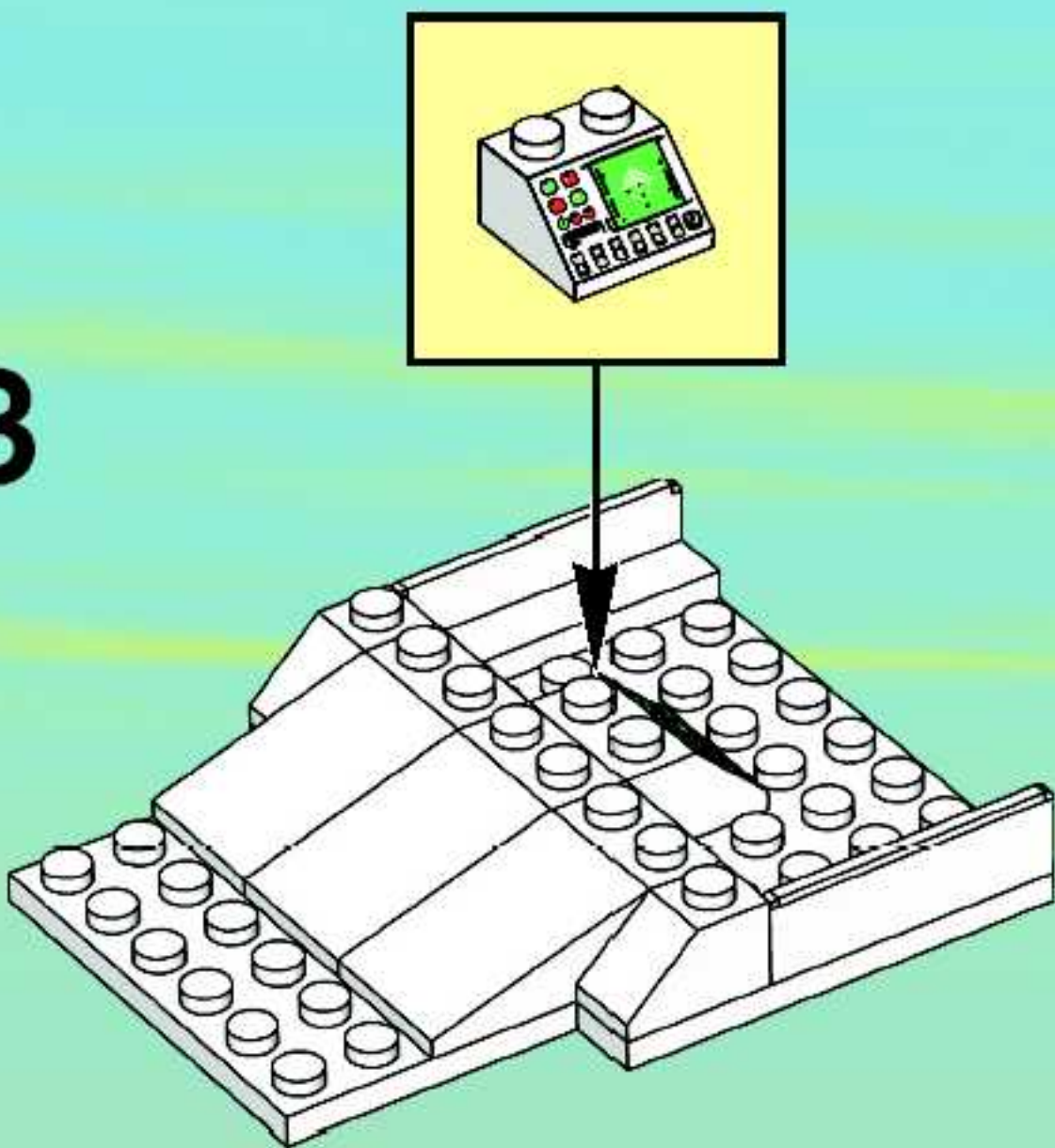

4

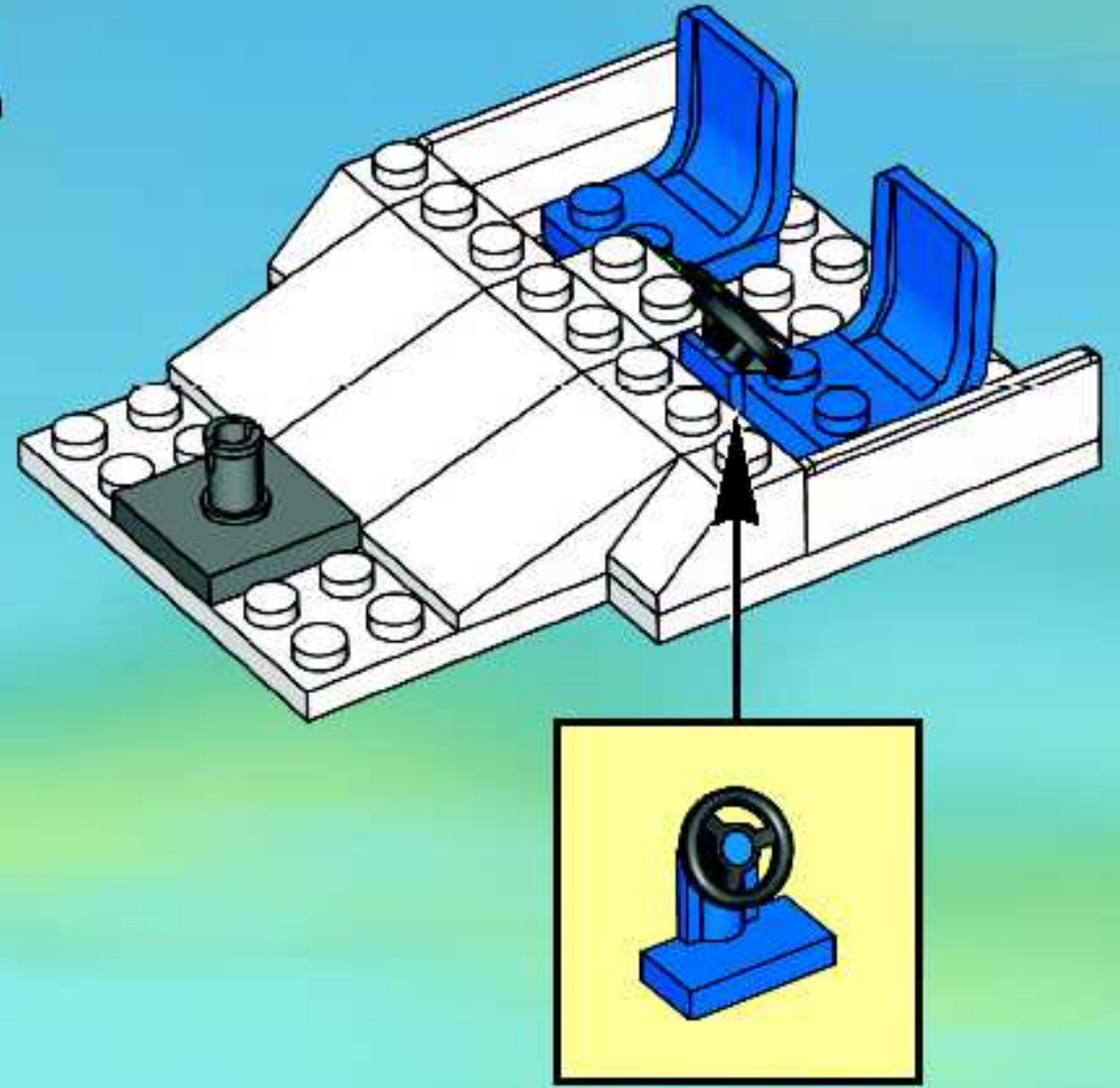

5

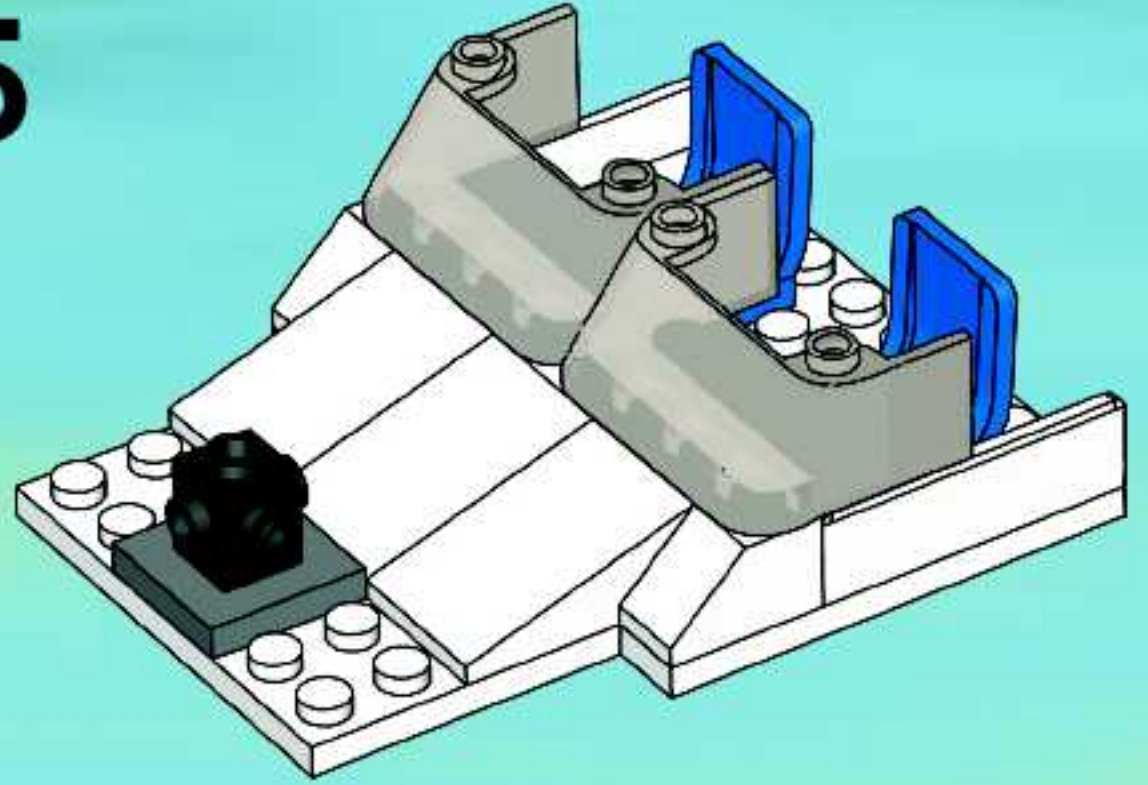

6

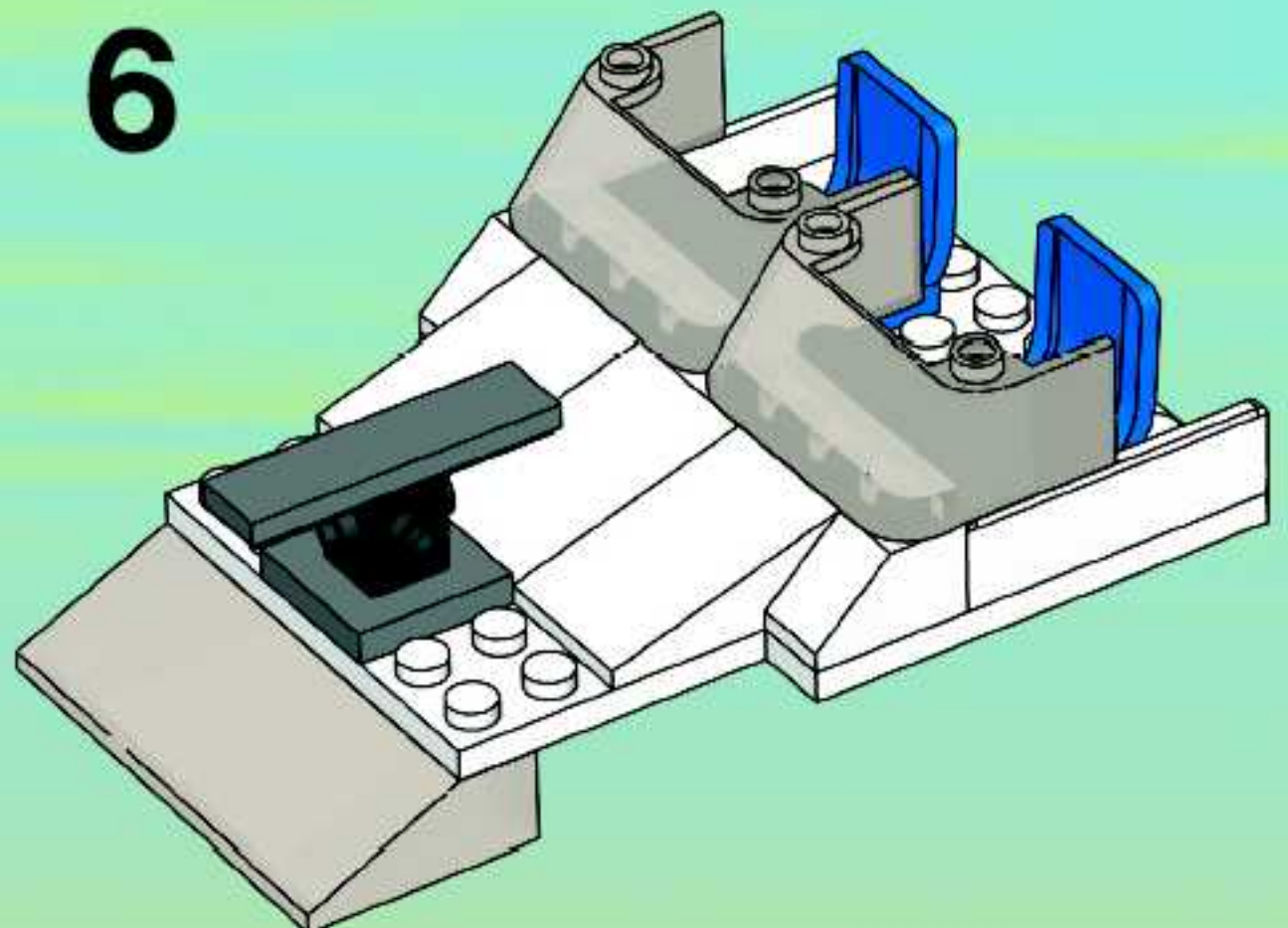

22

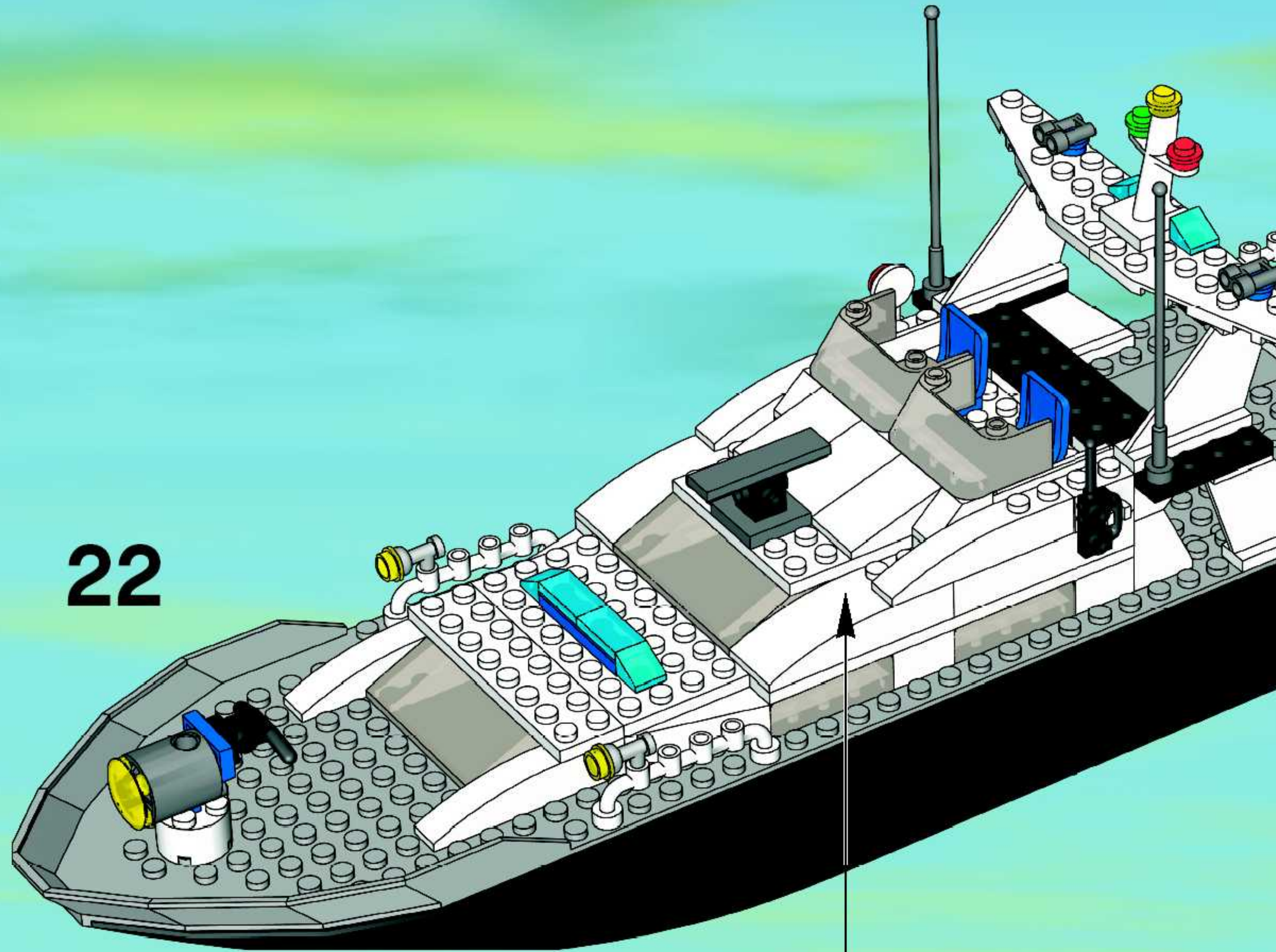

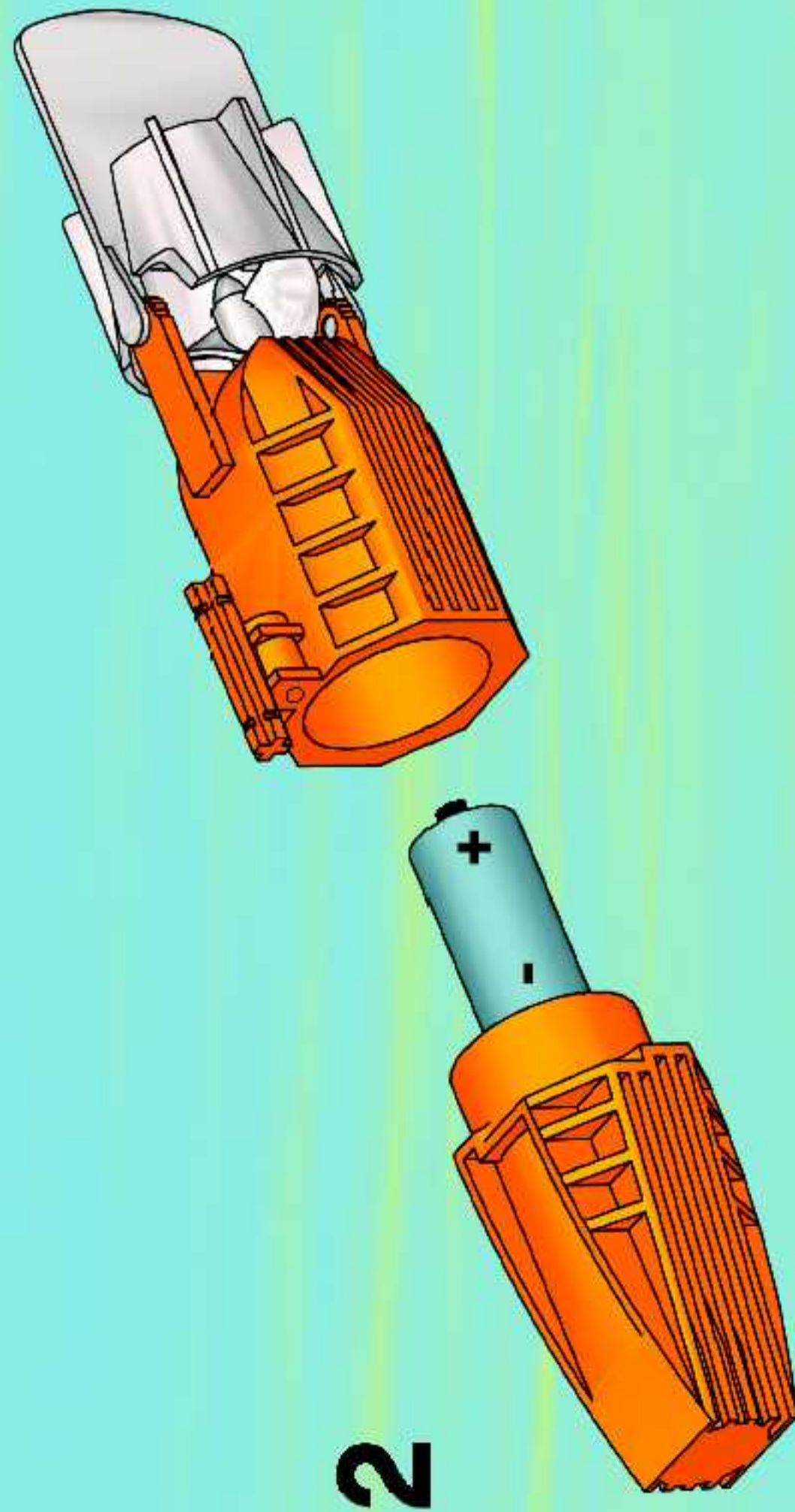
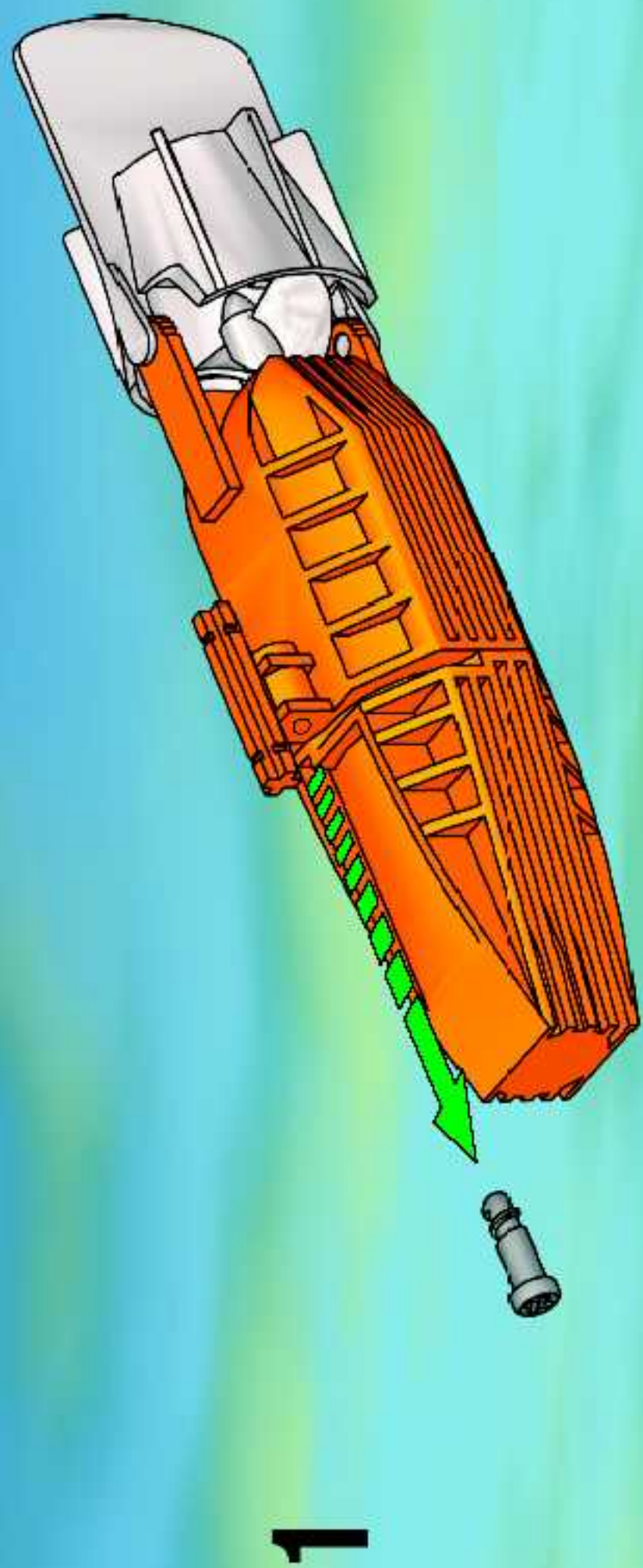
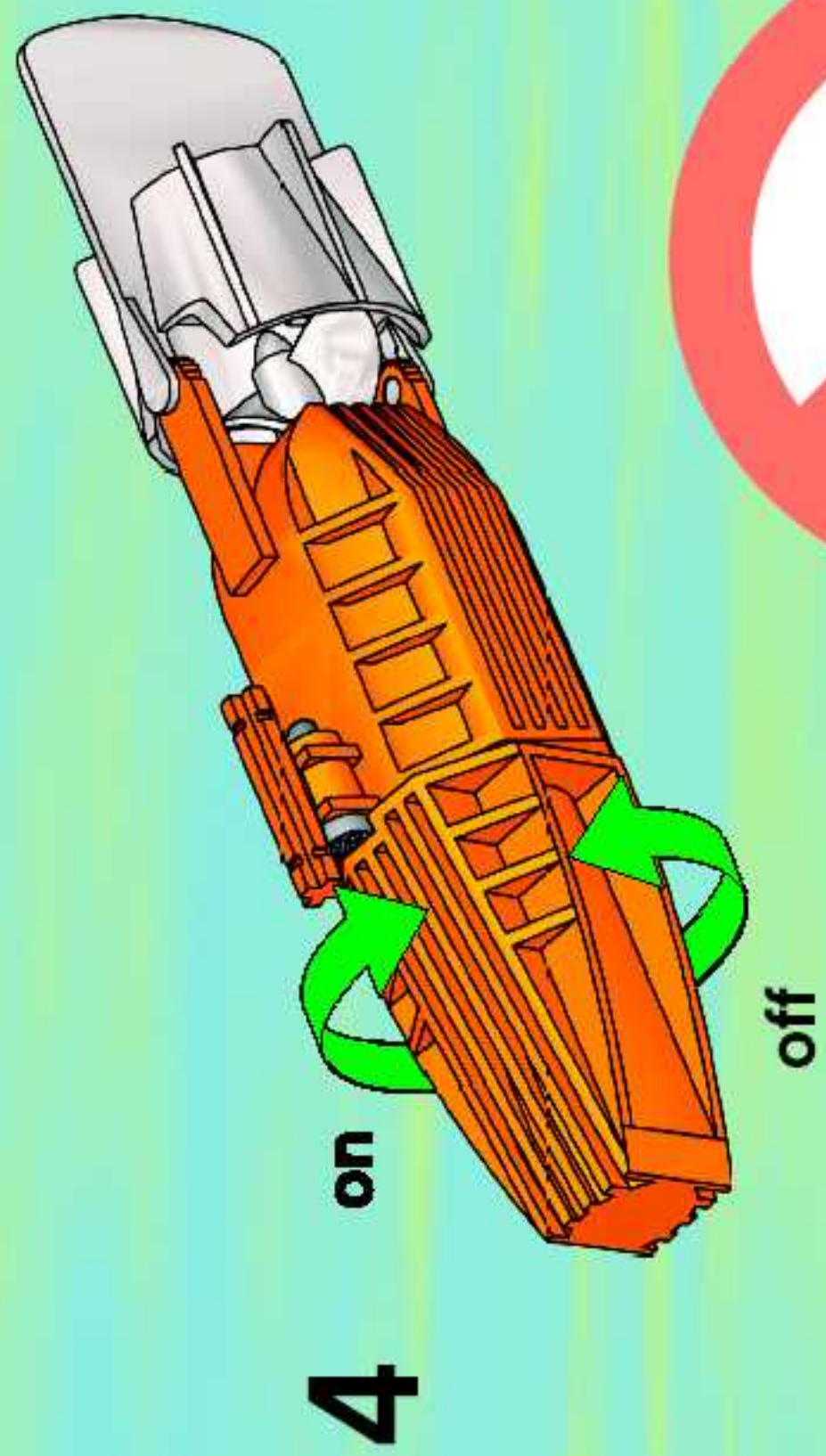
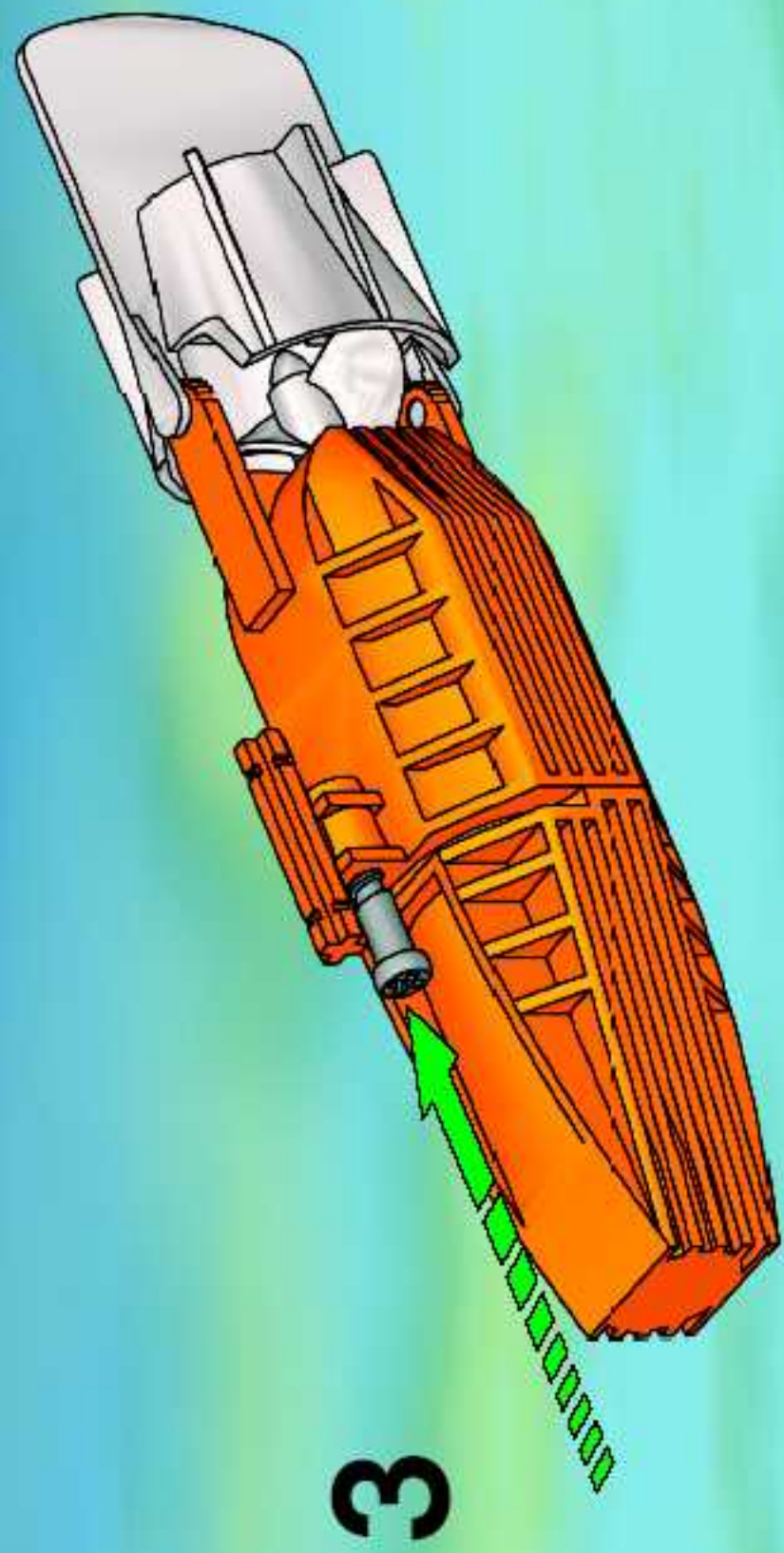

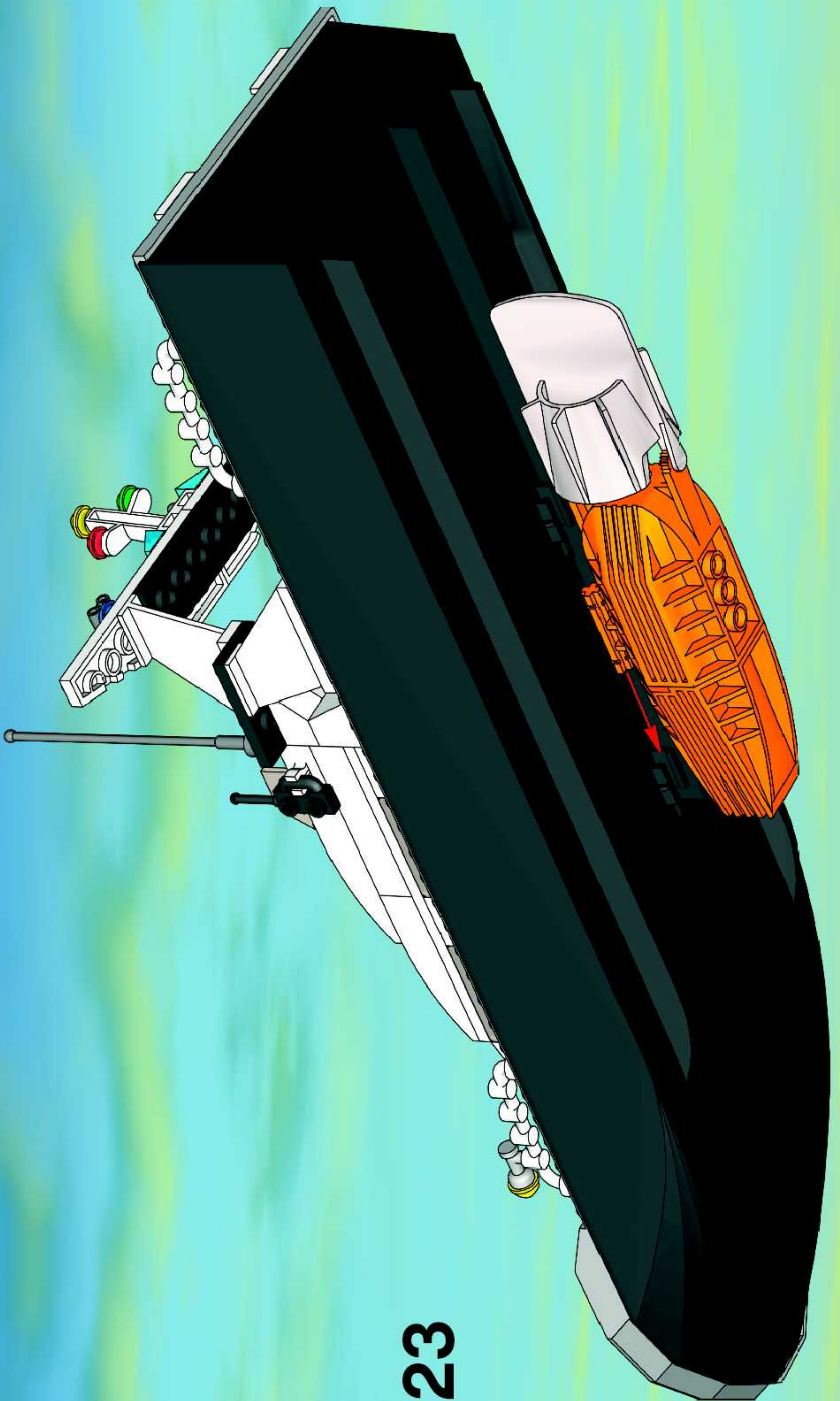

23

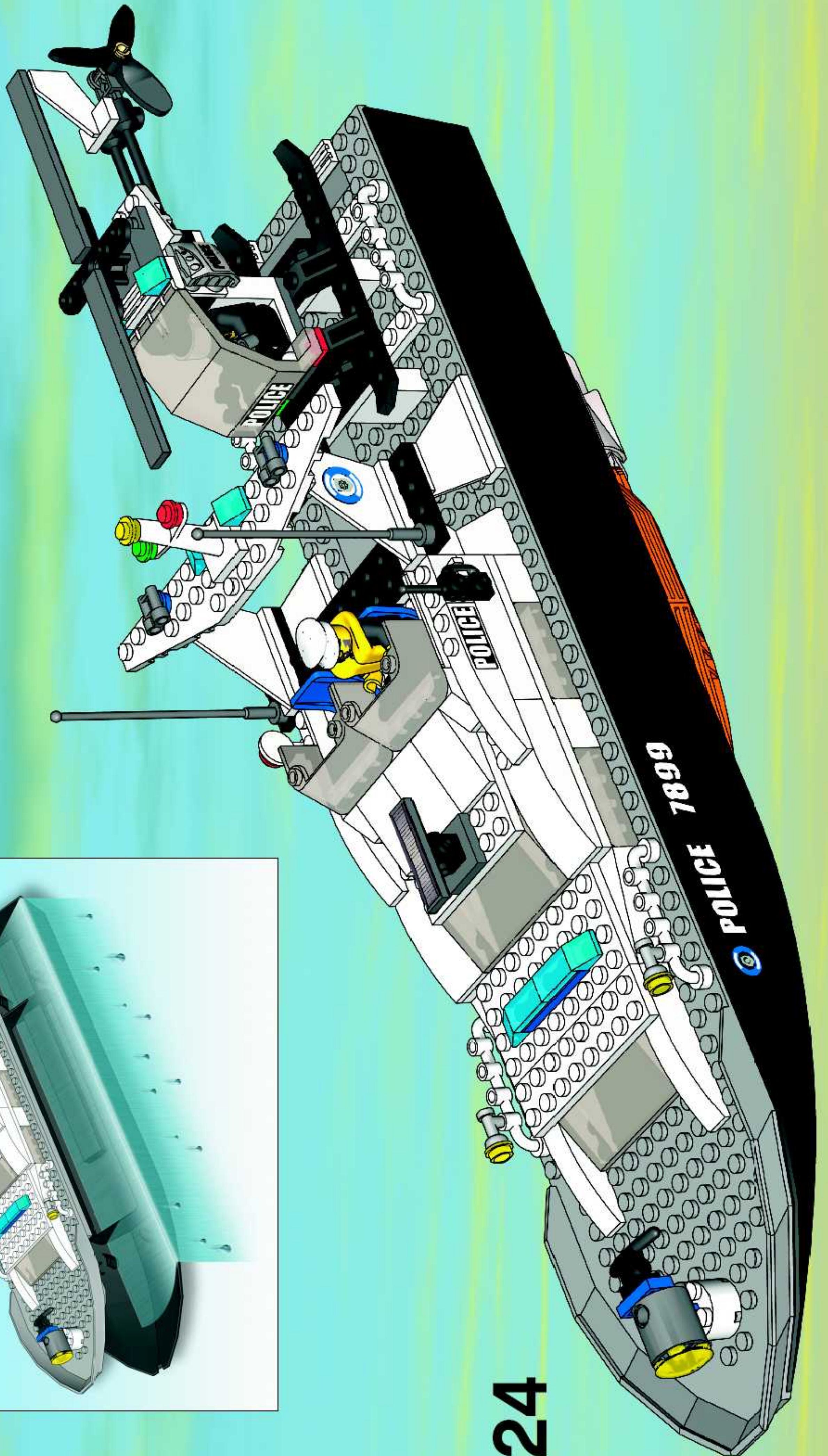
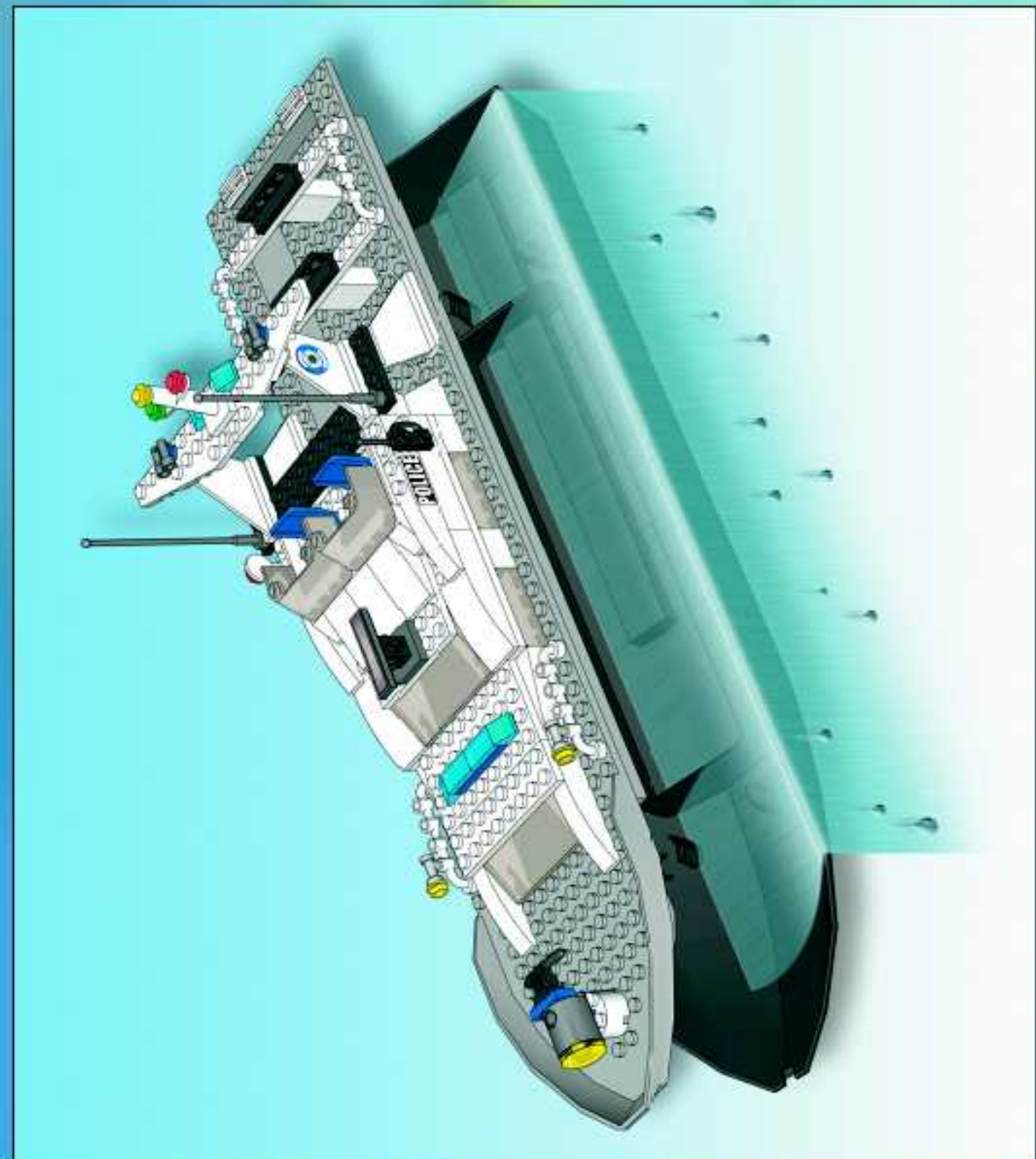





1x
4214079



2x
4277926



2x
73737

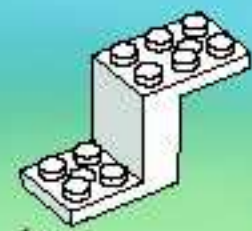

1x
4288959



4x
300501



6x
300401



2x
4117061



4x
4113261

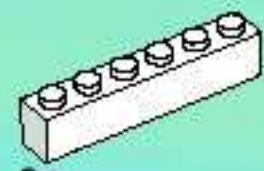

2x
300901

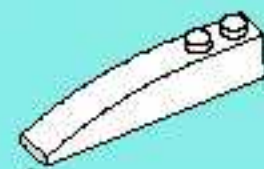

4x
4160387

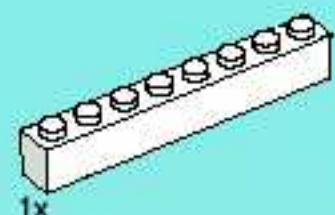

1x
300801

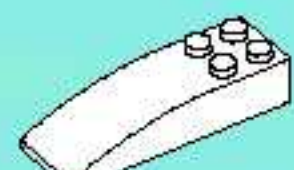

2x
4179870

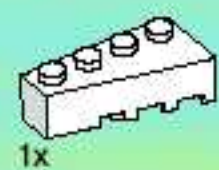

1x
4160343

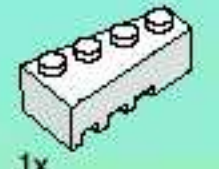

1x
4160325



4x
235701



1x
614301



1x
306901



4x
4288961



1x
4253859

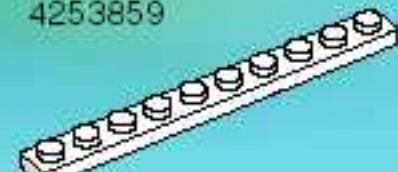

2x
447701

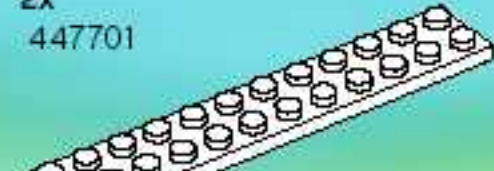

2x
244501



1x
4179875

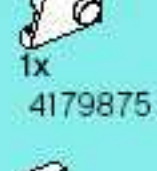

1x
4179874



1x
4179874

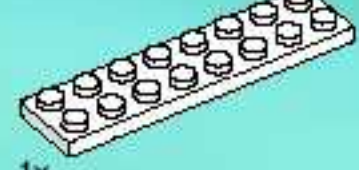

1x
303401



1x
4256097



1x
4256095

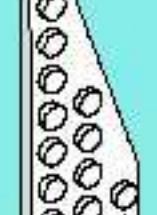

1x
4256095



3x
241201

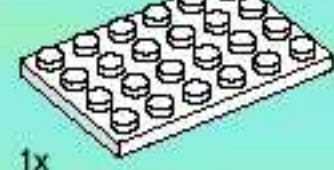

1x
303201



1x
303501



1x
303601

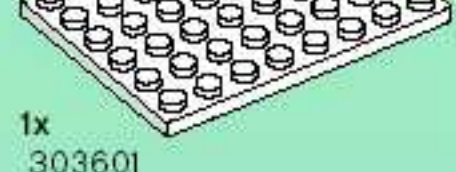

1x
303601



2x
366501

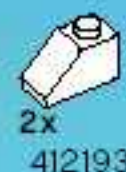

2x
4121932



1x
4195657



1x
4195659



2x
366001



2x
4234525



3x
4143000



4x
234001



1x
4288960



1x
390001

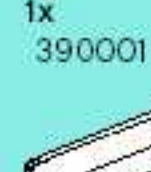

2x
4173477

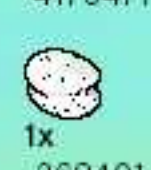

1x
362401

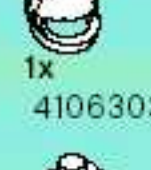

1x
4106303



1x
4275585



1x
4288958



1x
4163306



4x
4201201

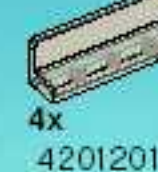

2x
4124083



2x
4173056



2x
4173056



2x
243121



2x
241221



2x
4190219



2x
4171662



1x
3003941



2x
3005741

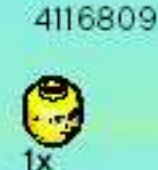

1x
4260843



1x
4116809



1x
4194017



1x
4259915



2x
379524

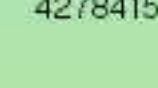

4x
486524

3x
3005744

1x
4278415



4x
300223



1x
243223



1x
4206482



1x
408123



3x
379423



1x
371023



5x
614123



2x
407923



1x
9566



2x
4113854



6x
4244366



1x
4216384



1x
3005748



1x
4186017



1x
473326



1x
300426



2x
4164067

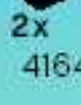

1x
461726



2x
4187209

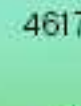

4x
4185652

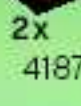

1x
3003126



1x
4157108



2x
396226

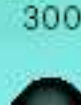

1x
255526



1x
393826



2x
302026



2x
303426



1x
247926



1x
4116839



1x
4275401



1x
4275397



1x
4222693



2x
9339



1x
4211469



2x
4211503

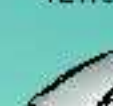

2x
4213383



1x
4210665

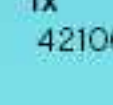

1x
4211053



2x
4211008

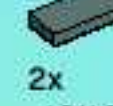

2x
4211063



1x
4211129



1x
4211065



1x
4239373

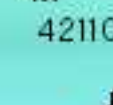

3x
4211051

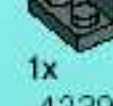

1x
4161673



2x
4210642

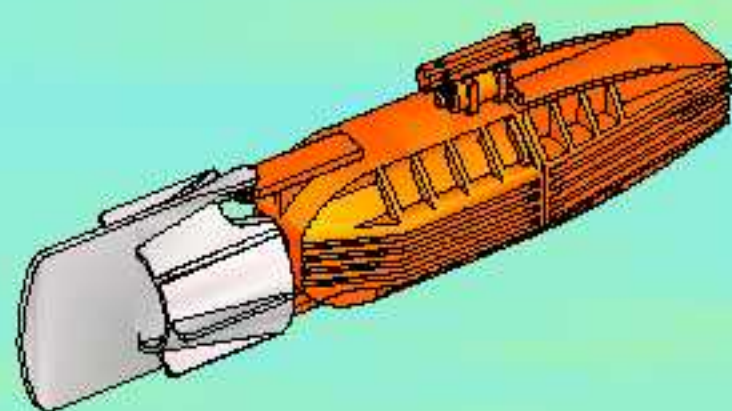

1x
4285432

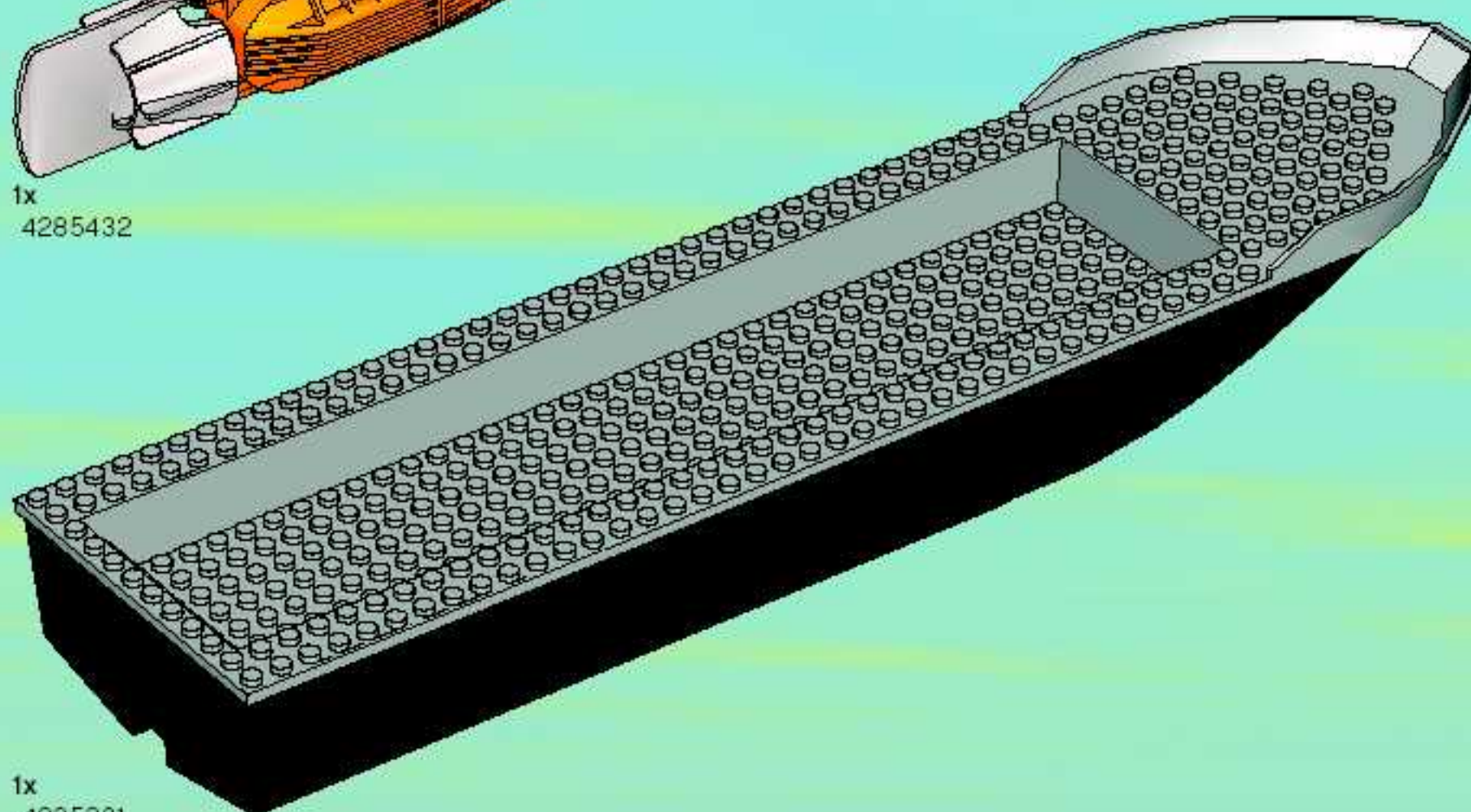

1x
4285331



club

Win! Gagne!



FREE!

- Each LEGO Magazine Features...
- Awesome creations by Kids like you!
 - Cool Comics & Stories
 - Building Tips & Ideas
 - Special Offers & Contests to WIN Prizes!

GRATUIT!

- Chaque Magazine LEGO offre...
- Des créations épatantes par des jeunes comme toi!
 - Des bandes dessinées et des récits super cool
 - Des idées de construction
 - Des offres spéciales et des concours pour gagner des prix!

Join Today!

Abonne-toi dès aujourd'hui!

1-866-534-6258

www.LEGOclub.com



WIN LEGO® PRODUCTS

Log on to www.acnielsen.aim.dk/LEGO for further instructions.

GAGNE DES PRODUITS LEGO®

Visite www.acnielsen.aim.dk/LEGO pour plus d'informations.

ESTIMADO USARIO LEGO®

Al contestar algunas preguntas en Ingles, frances, aleman o japones en el sitio www.acnielsen.aim.dk/LEGO, podras participar en el sorteo de algunas valiosos premios LEGO®.

www.acnielsen.aim.dk/LEGO



LEGO, the LEGO logo are trademarks of/sont des marques de commerce de/The LEGO Group. ©2005 The LEGO Group.

YES! I WANT TO JOIN THE LEGO® CLUB!

This coupon is good for 1 **FREE** 2-year Club membership. Additional kids may sign up for \$7.95 in the US and in Canada 10.70 (including taxes).

PLEASE PRINT IN ALL CAPITAL LETTERS

OUI! JOIGNEZ-MOI AU CLUB LEGO®!

Ce coupon est valide pour 1 abonnement **GRATUIT** de 2 ans. Enfants additionnels peuvent s'inscrire pour 10,70 \$ (taxes incluses).

S.V.P. IMPRIMER EN LETTRES MAJUSCULES.

BIC26

Name/Nom _____ Age _____ Français English

Address/Adresse _____ Girl/Fille Boy/Garçon

City/Ville _____ State/Prov. _____ Postal Code Code Postal _____

E-mail Address/Courriel _____ Date of Birth Date de Naissance ____/____/____
M / D / Y/A

Parent's Signature/Signature d'un parent _____



Offer limited to residents of US and Canada. No photocopies will be accepted. Offer limited to two free memberships per family, group or organization. Please allow 4-6 weeks for delivery of your first mailing. Offre limitée pour résidents du US et Canada. Photocopies ne seront pas acceptées. Offrir limitée à deux abonnements gratuits par famille, groupe, ou organisation. Allouez 4-6 semaines pour la première livraison.

**FREE
LEGO Magazine
with this coupon!
Magazines LEGO
GRATUITS
avec ce coupon!**

Mail to/Poster à:
**LEGO Club
P. O. Box 1157
Enfield, CT
06083-1157**



SHOP at HOME

The World's Biggest LEGO® Shop!



For a Free Catalog
in the U.S. and Canada,
call toll-free:
1-866-534-6737
Or go online:
www.LEGOshop.com/catalog

Pour obtenir un Catalogue
GRATUIT aux États-Unis
et au Canada,
téléphonez sans frais au :
1-866-534-6737
Ou venez en ligne sur :
www.LEGOshop.com/catalog

Any questions
regarding your new
LEGO product, please
contact:
Customer
Service | Service
Consommateurs |
Servicio :



1-800-422-5346

or

www.lego.com/service

LEGO, the LEGO logo are trademarks of the LEGO Group. ©2005 The LEGO Group.

FREE LEGO® Catalog!

Please print with a pen in capital letters.

First Name / Prénom _____

Last Name / Nom _____

Address / Adresse _____

City / Ville _____ State / Prov _____ Zip Code / Code Postal _____

Phone (optional) / No de téléphone (optionnel) _____

Email (optional) / Courriel (optionnel) _____

Check Below / Indiquer ci-bas

I speak English

Je parle Français

Boy/Garçon

Girl/Fille



U.S. and Canada only
É.-U. et Canada seulement

Please allow 2-4 weeks for delivery.
Veuillez s.v.p. allouer 2 à 4 semaines pour l'expédition.

Mail to/Poster à:



P. O. Box 1221
Enfield, CT 06083-1221



CITY





CITY



7238



7239



7241



7242



7240



7243

7248

7246

7249

