



BATMAN

7885



1

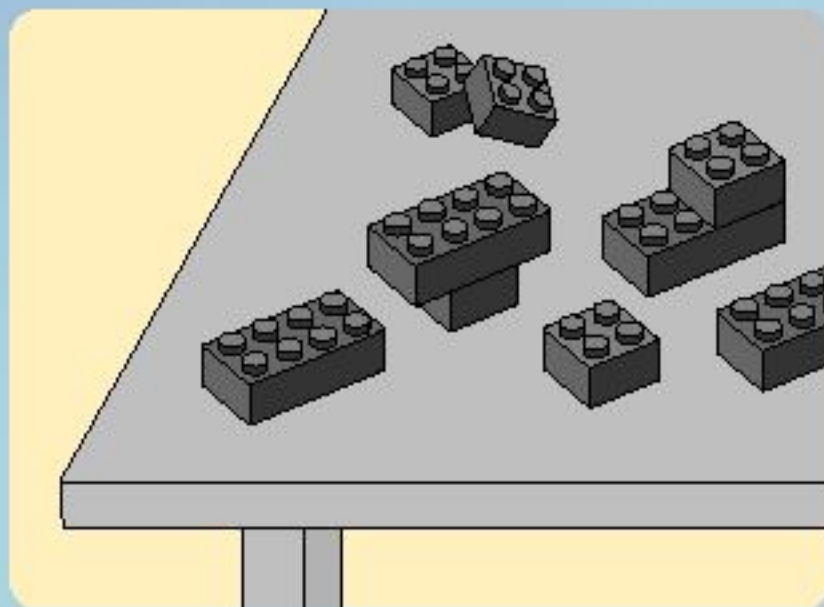

2



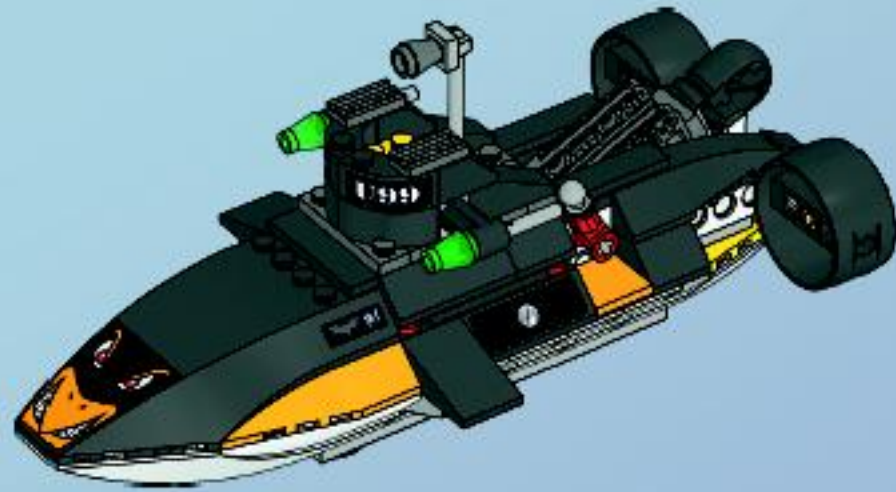



3



4

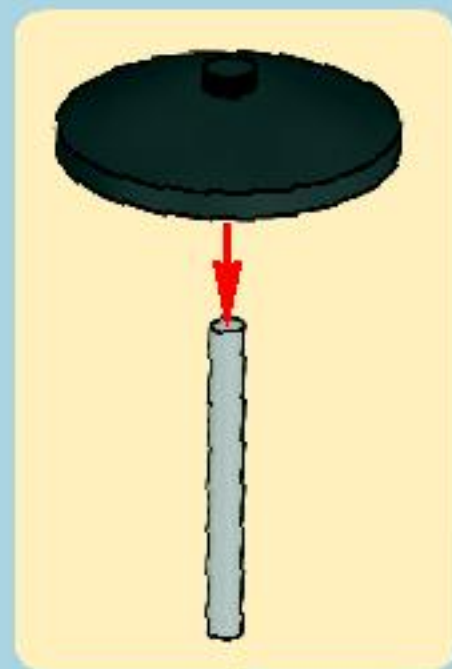
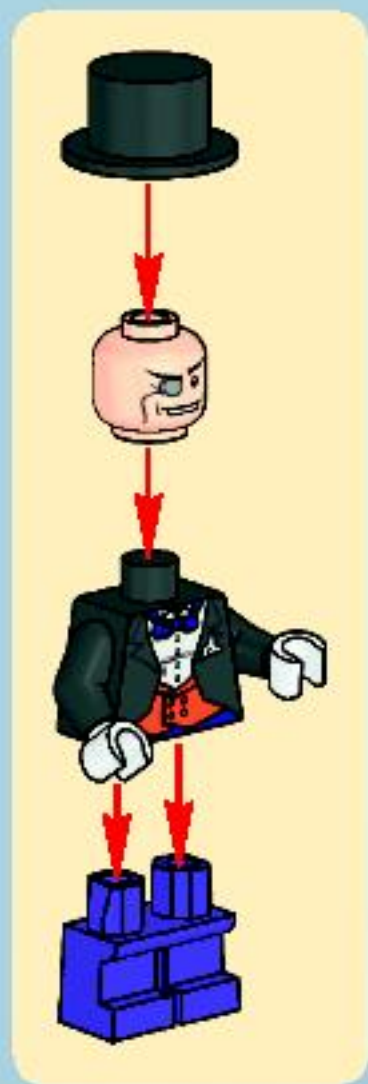

1

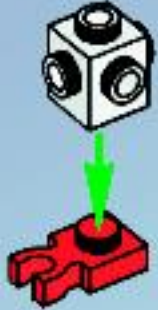

3



2

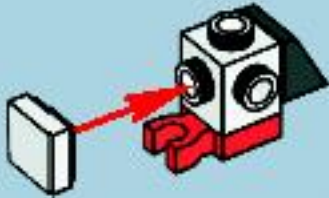

4



5



2x

6



1

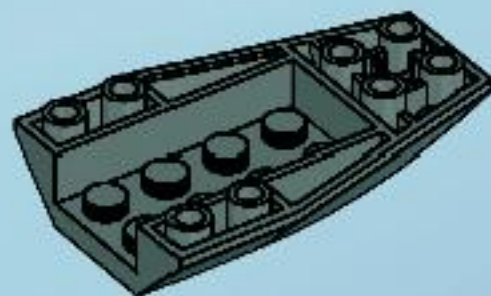

2

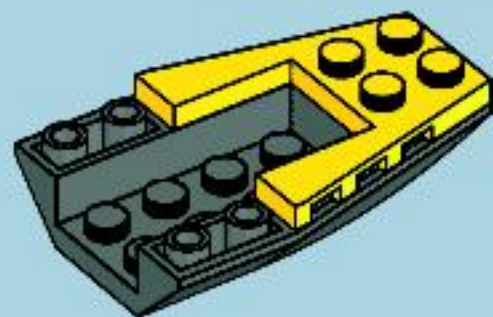



3

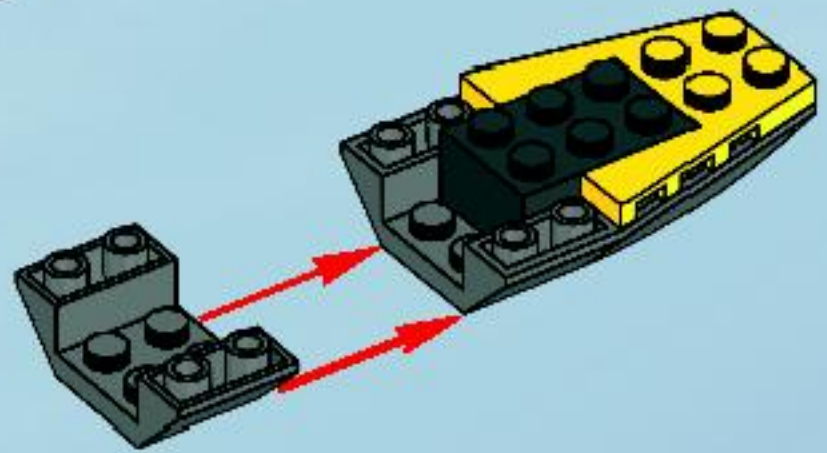

4

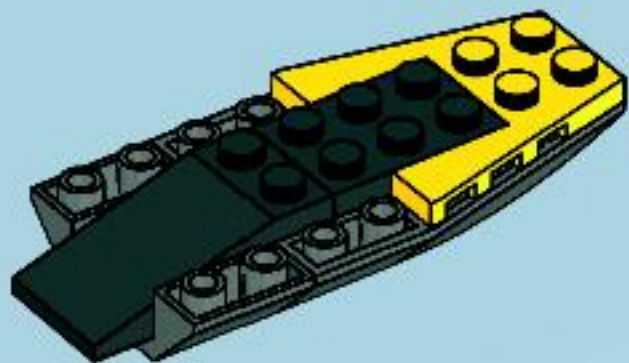

5

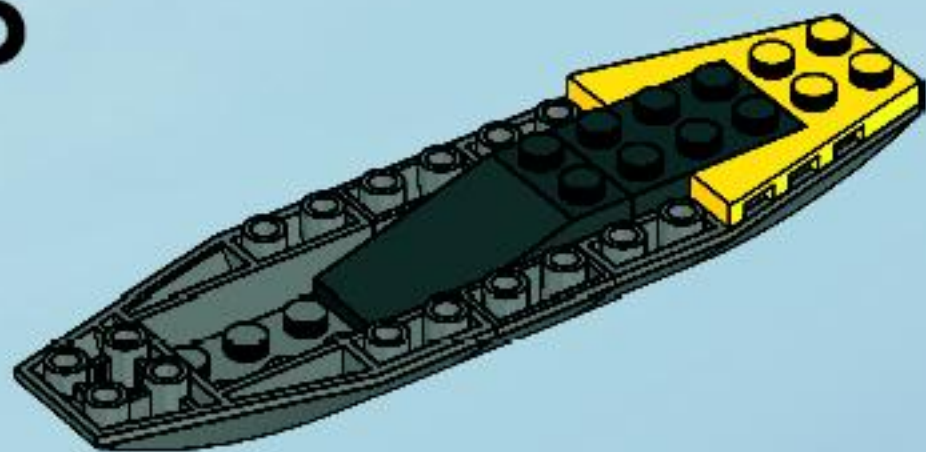

6

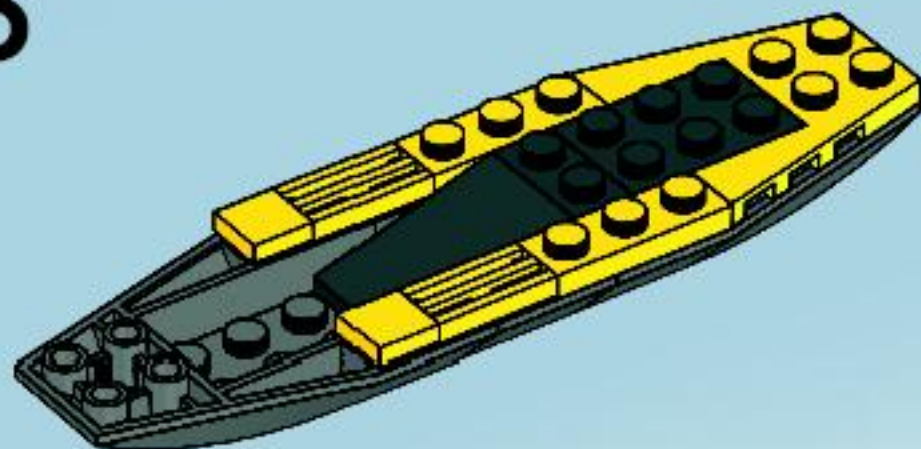

7

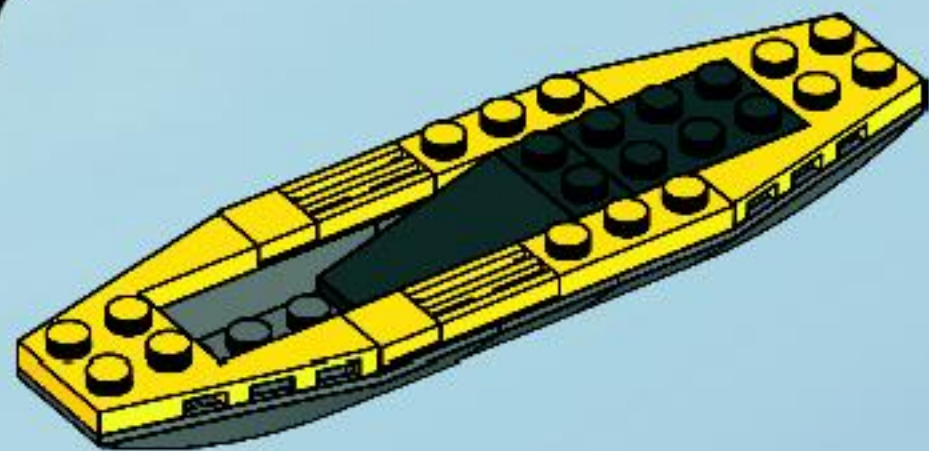

8

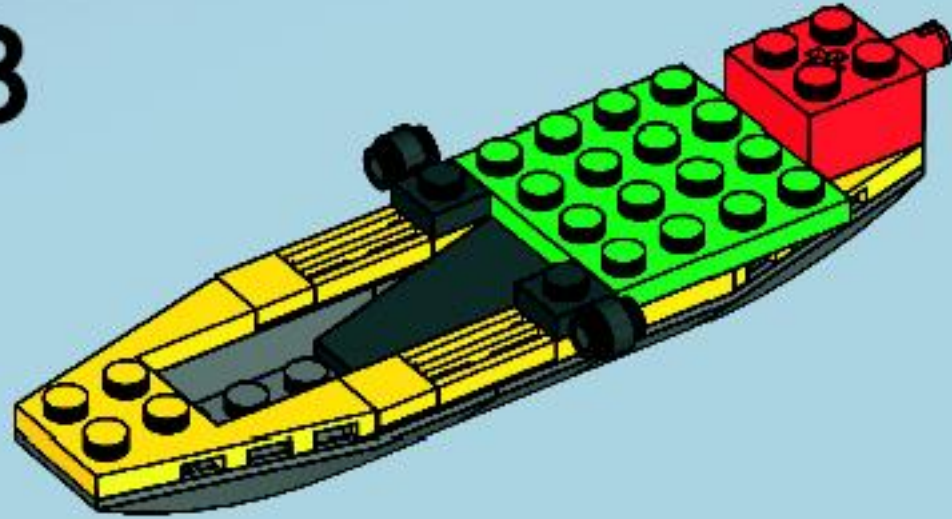

9

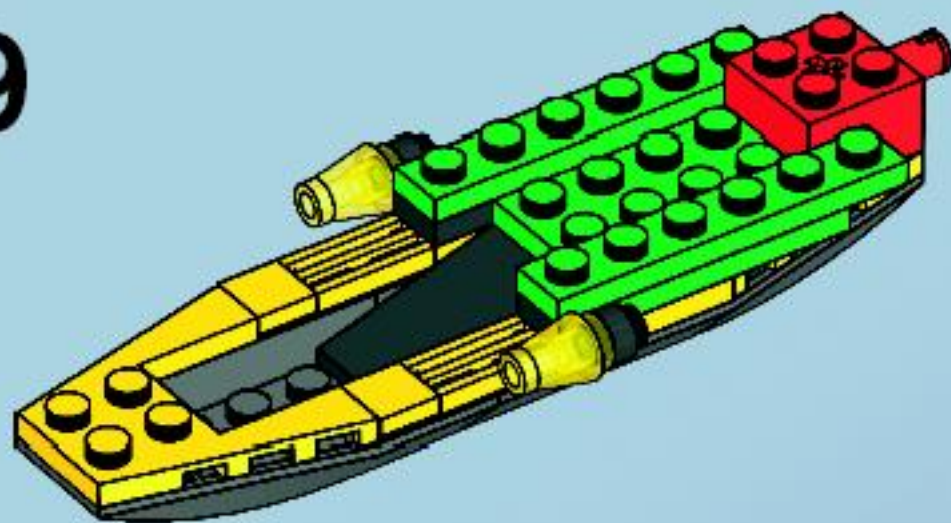

10

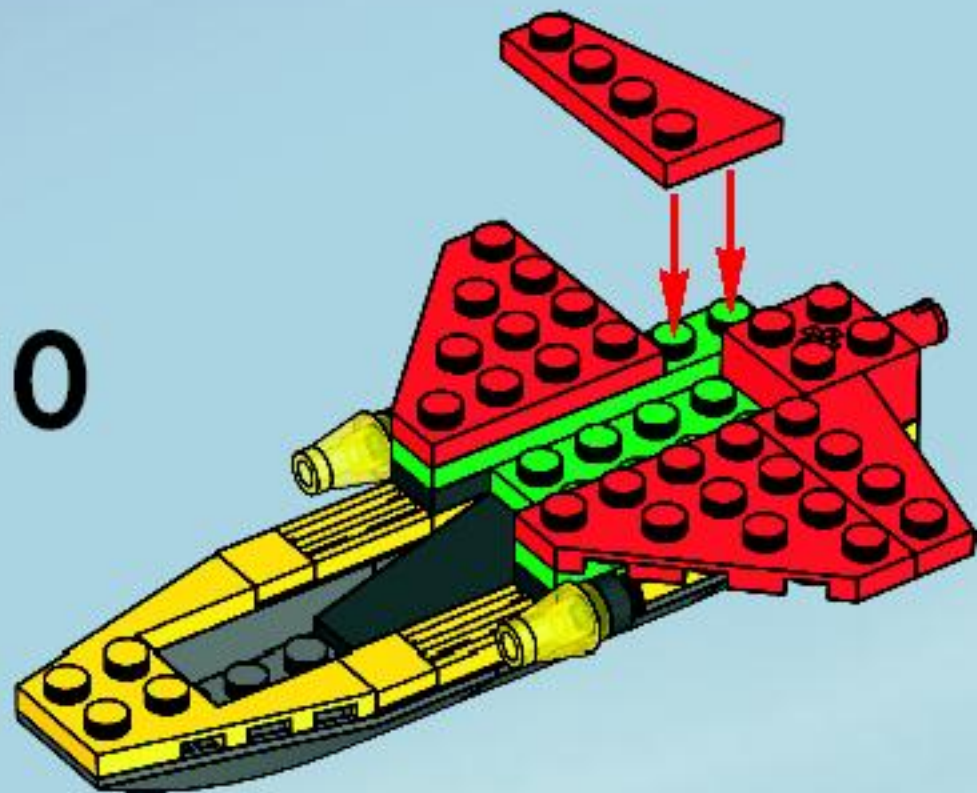

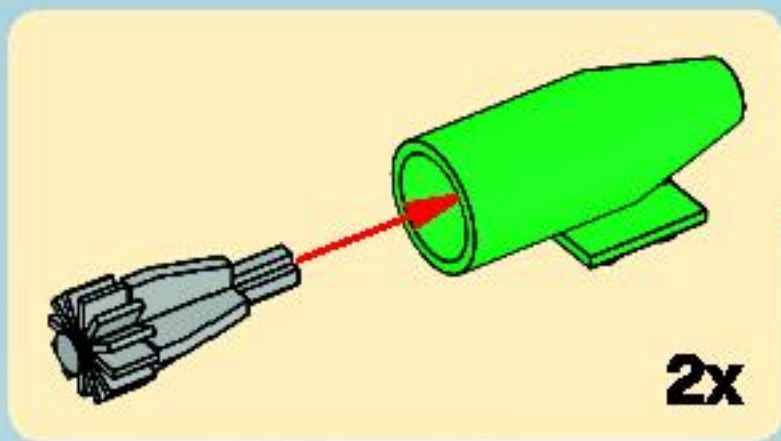

11

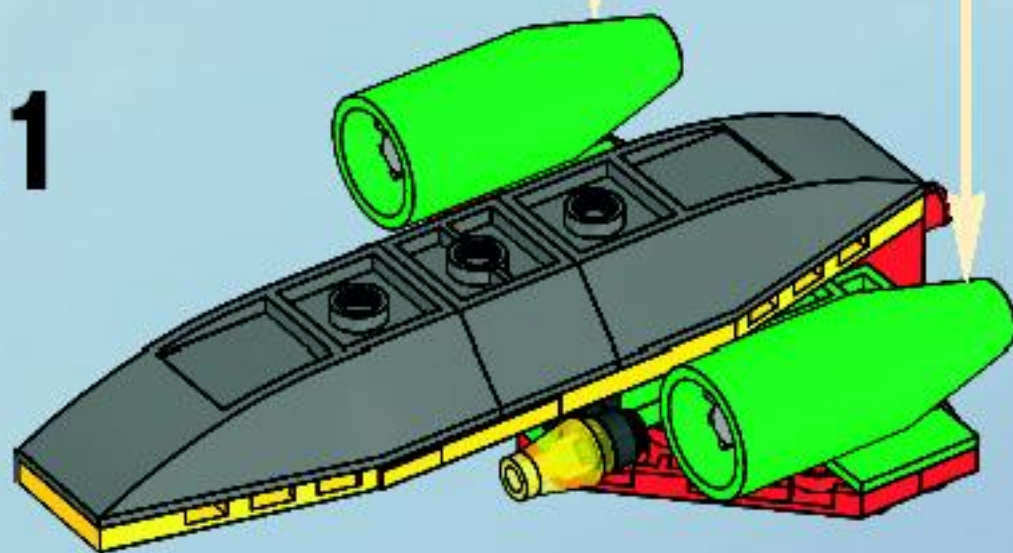

12

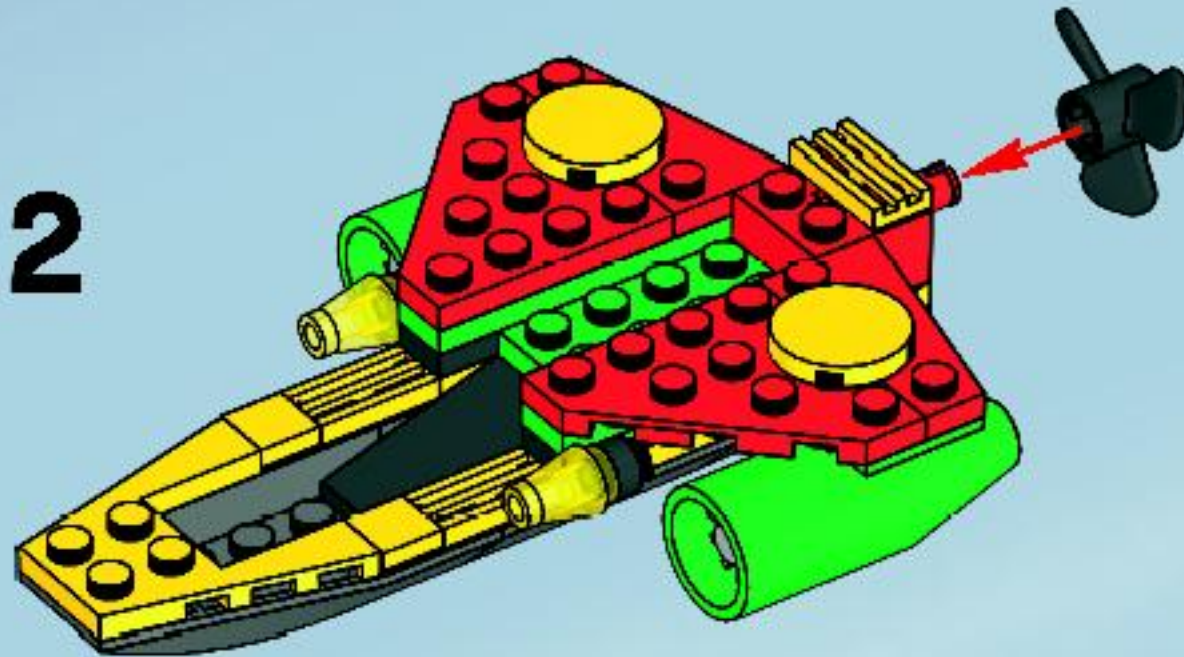

13



14

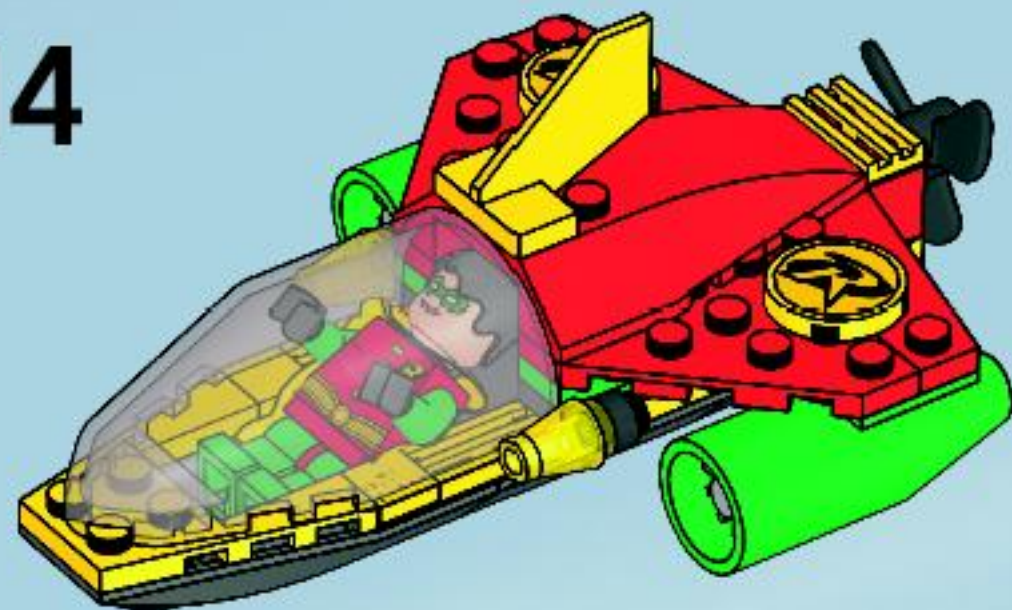



2

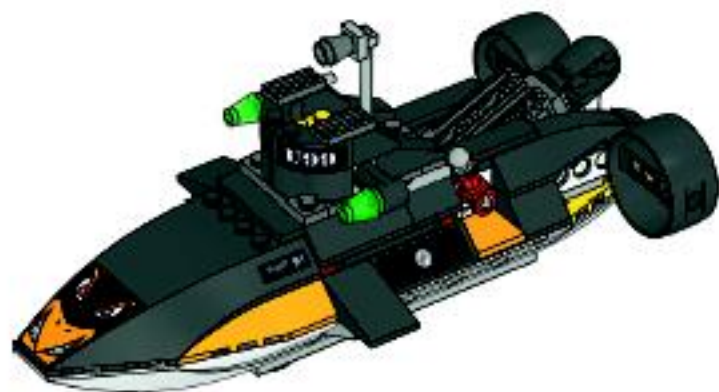

1

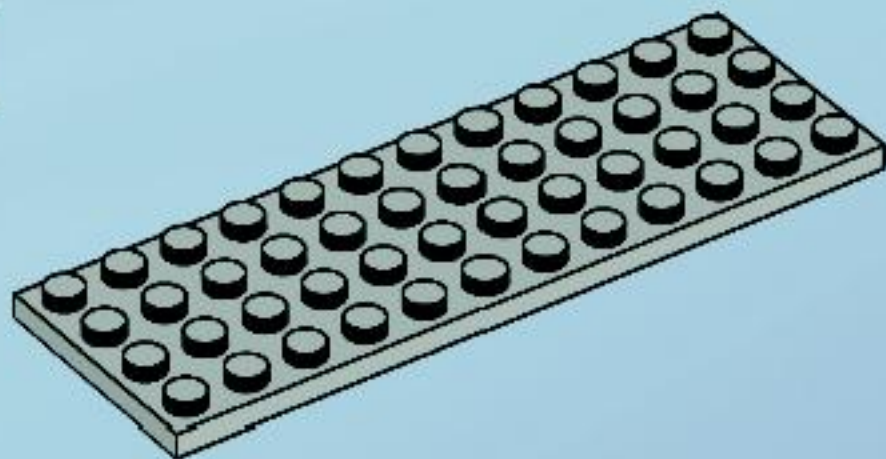

2

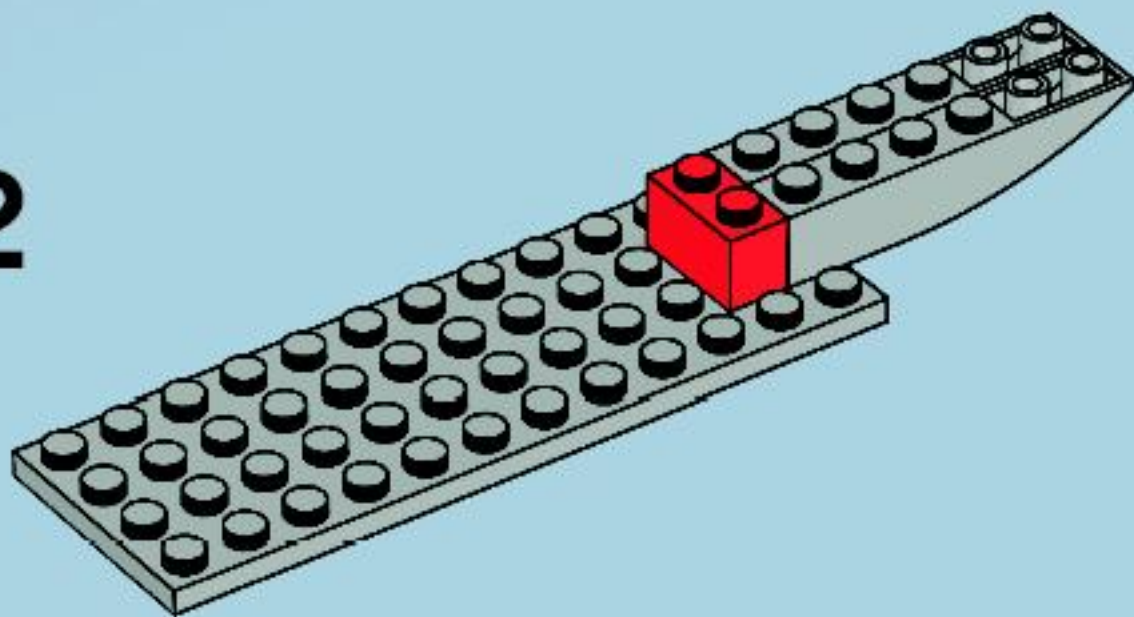

3

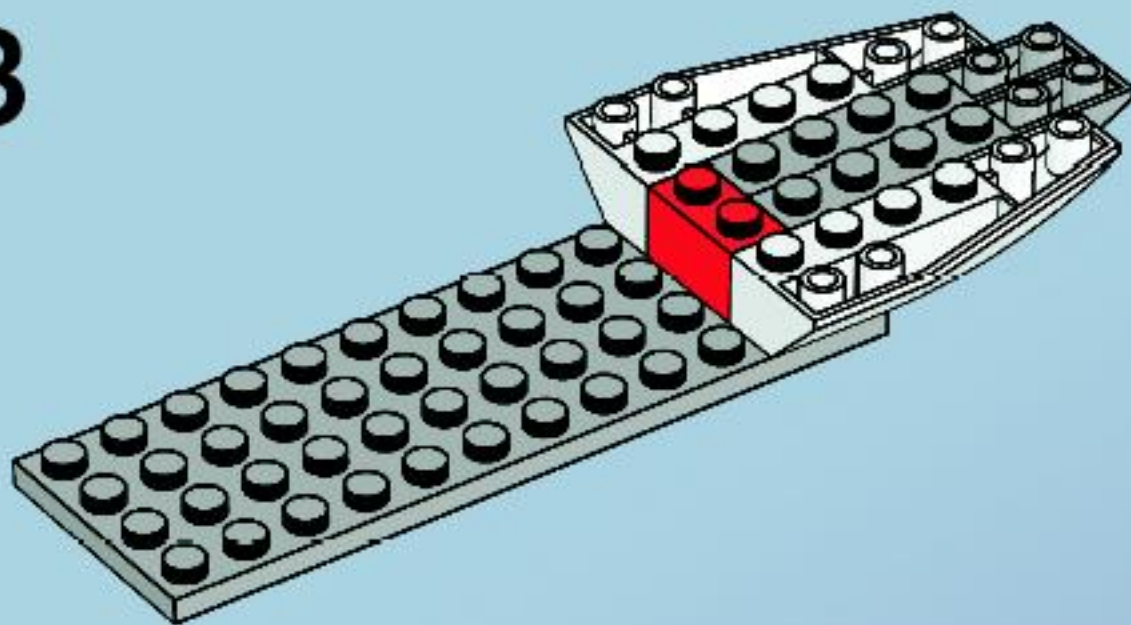

4

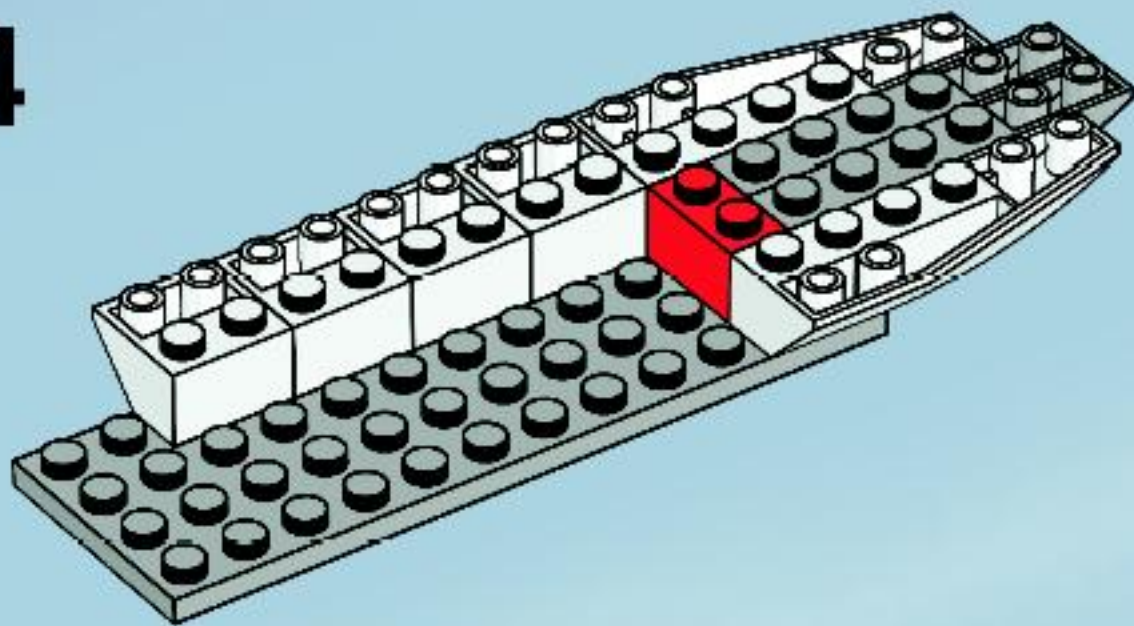

5

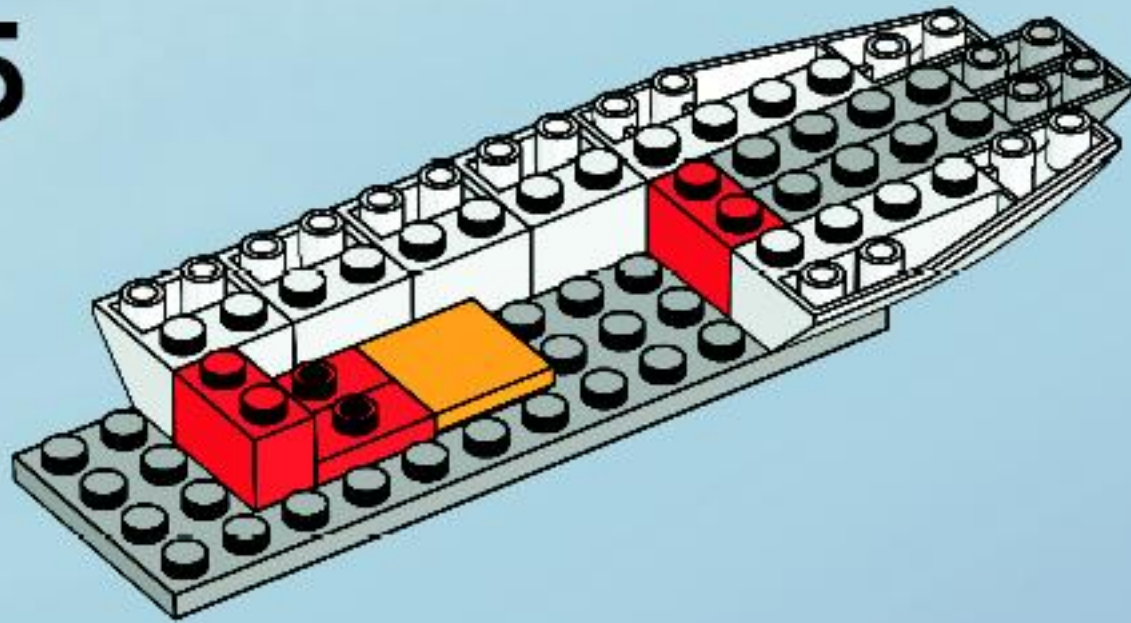

6

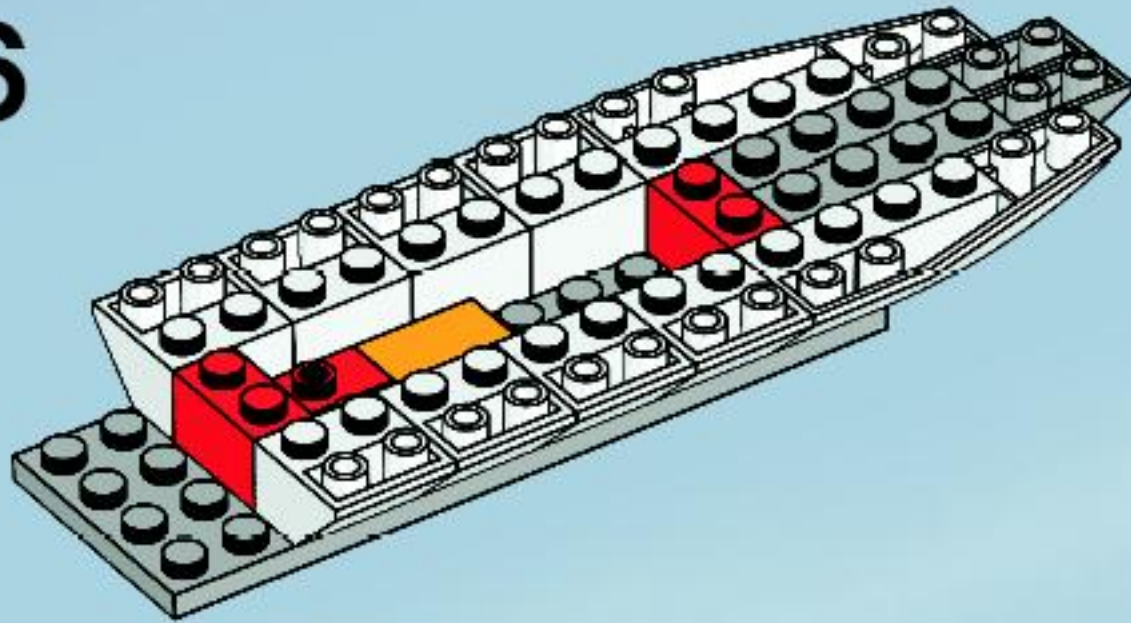

7

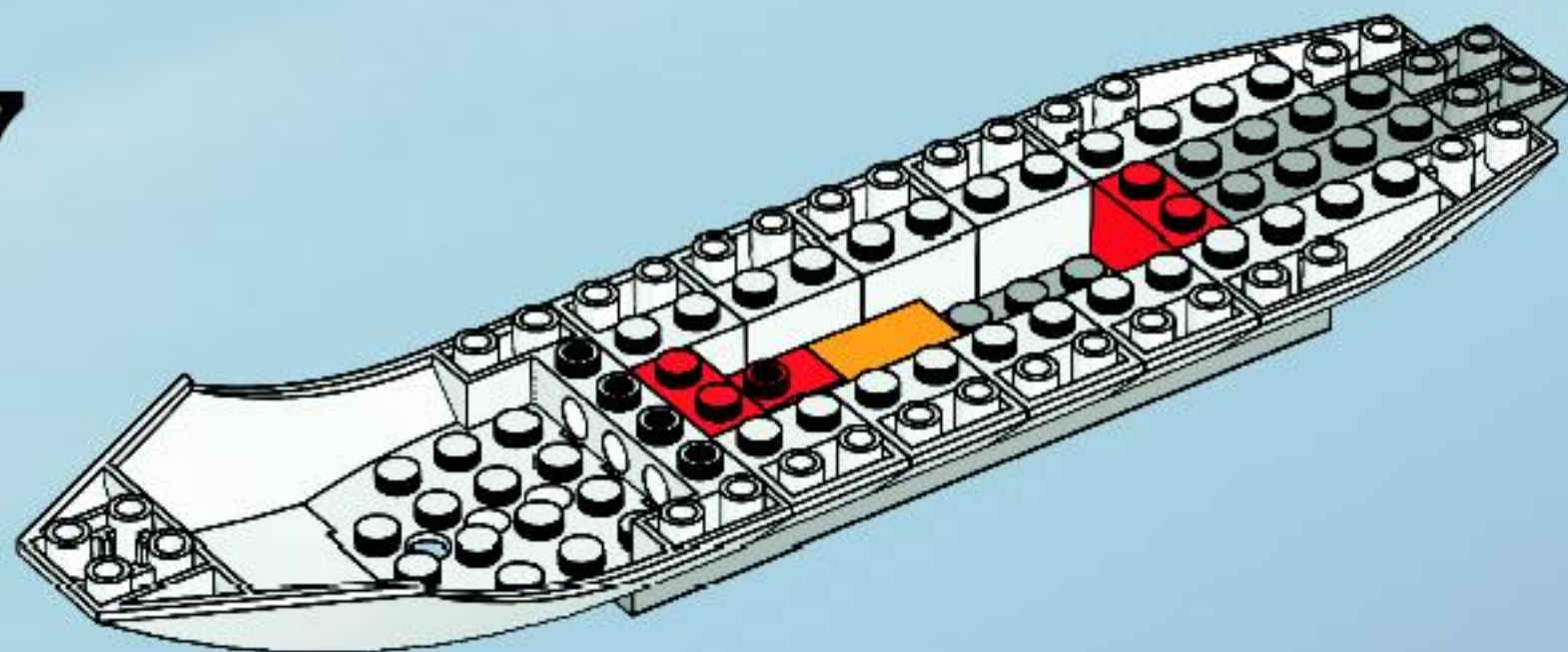

8

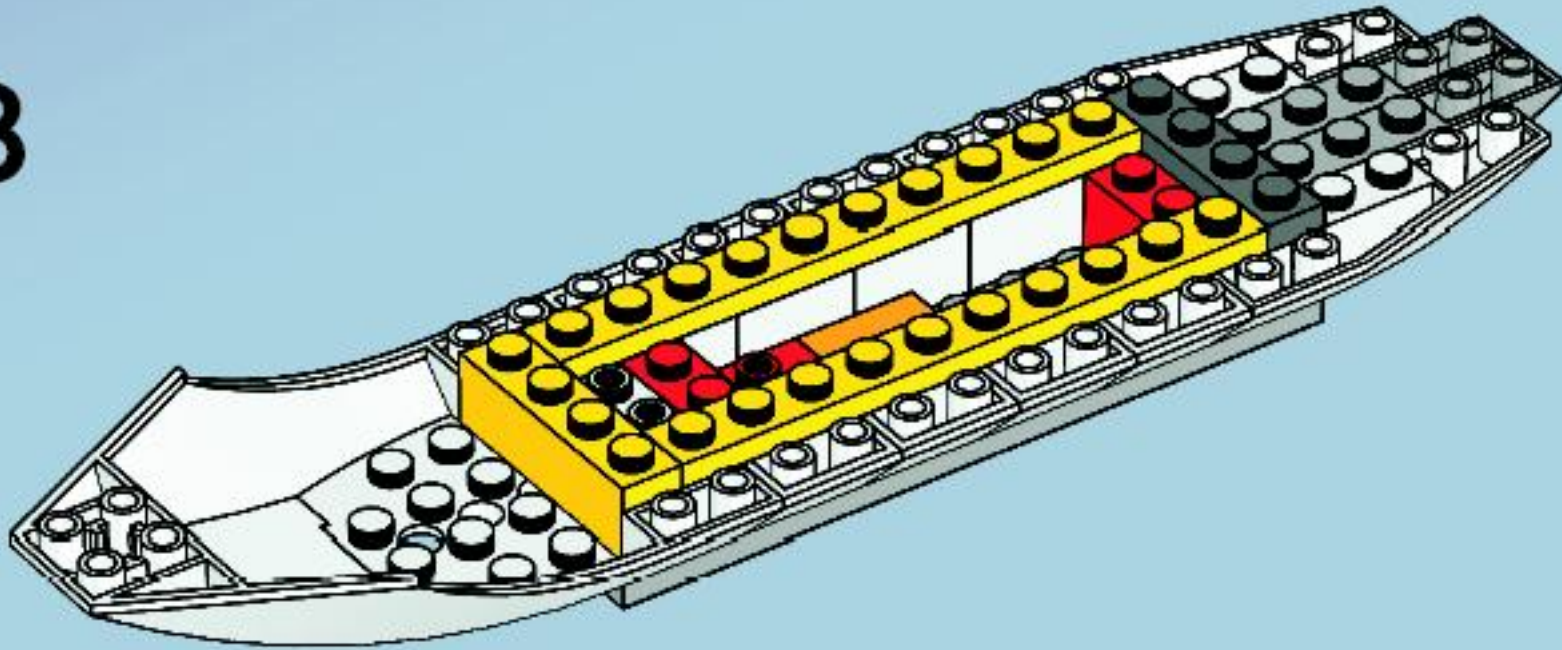

9

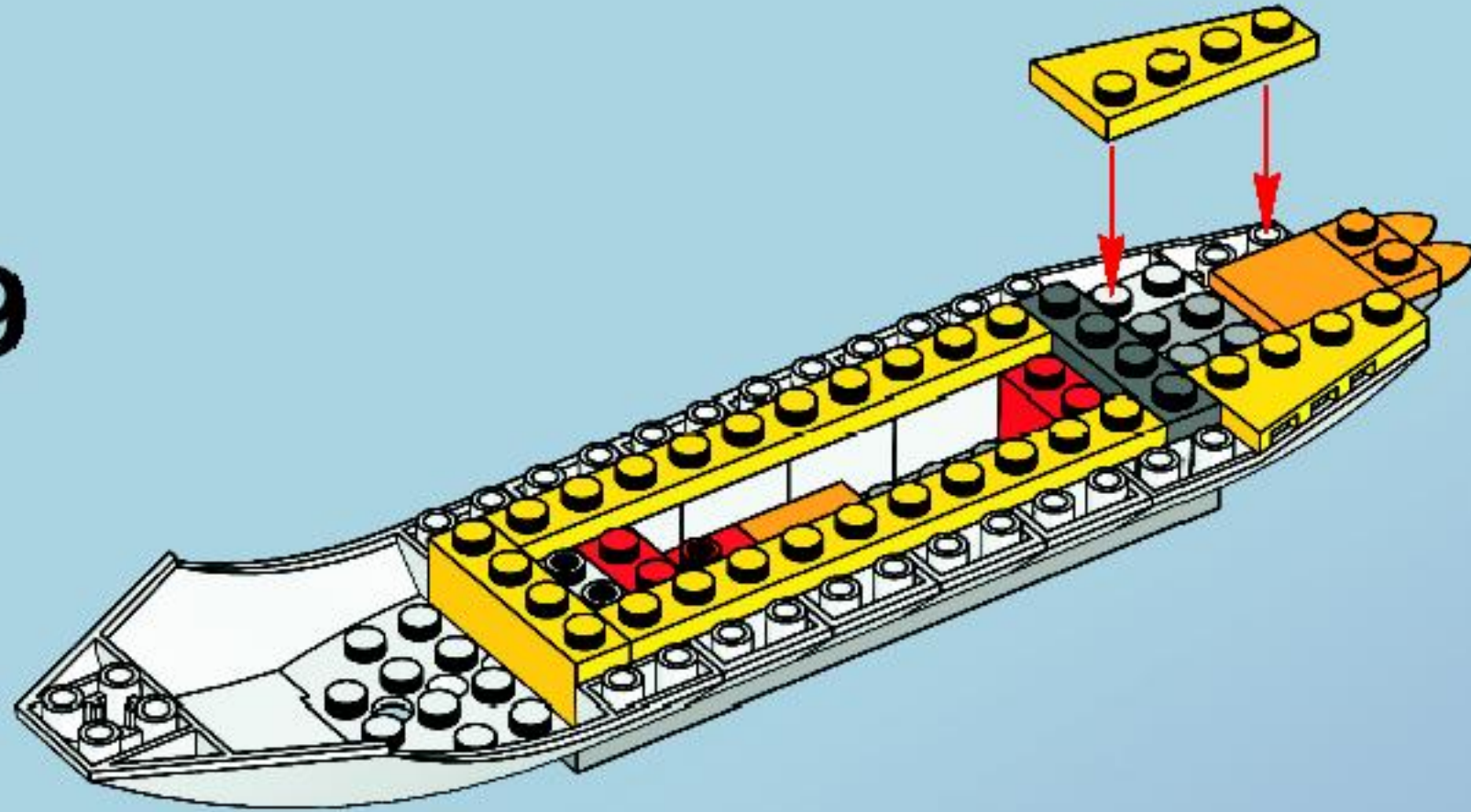

10

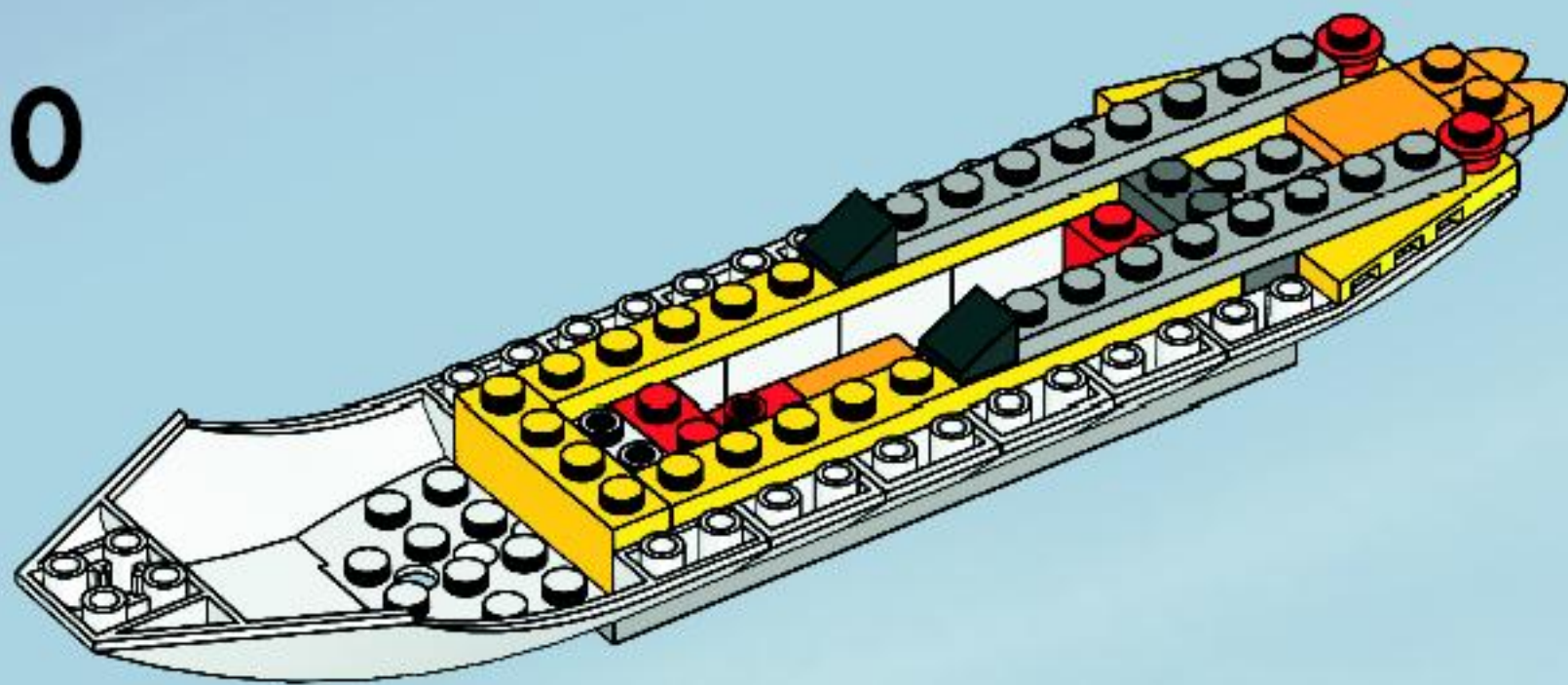

11

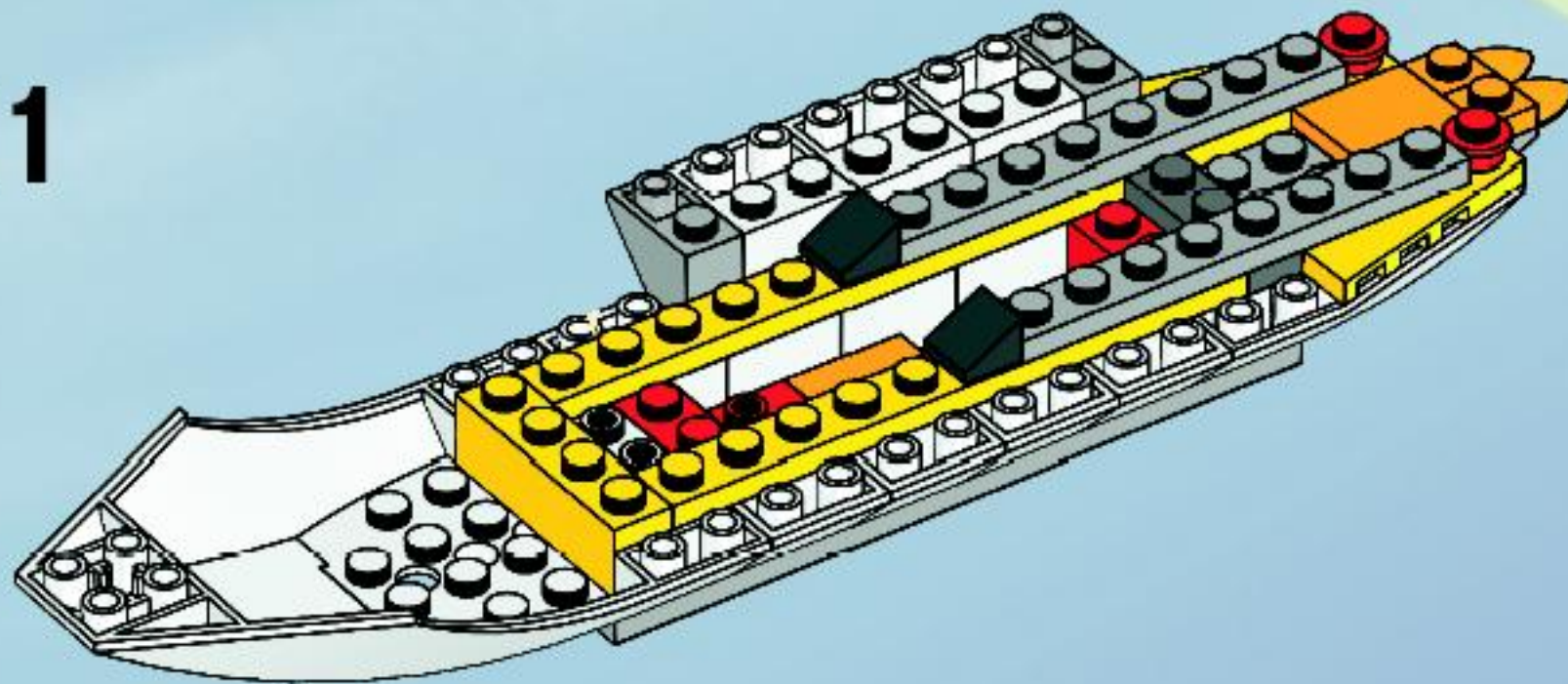

12

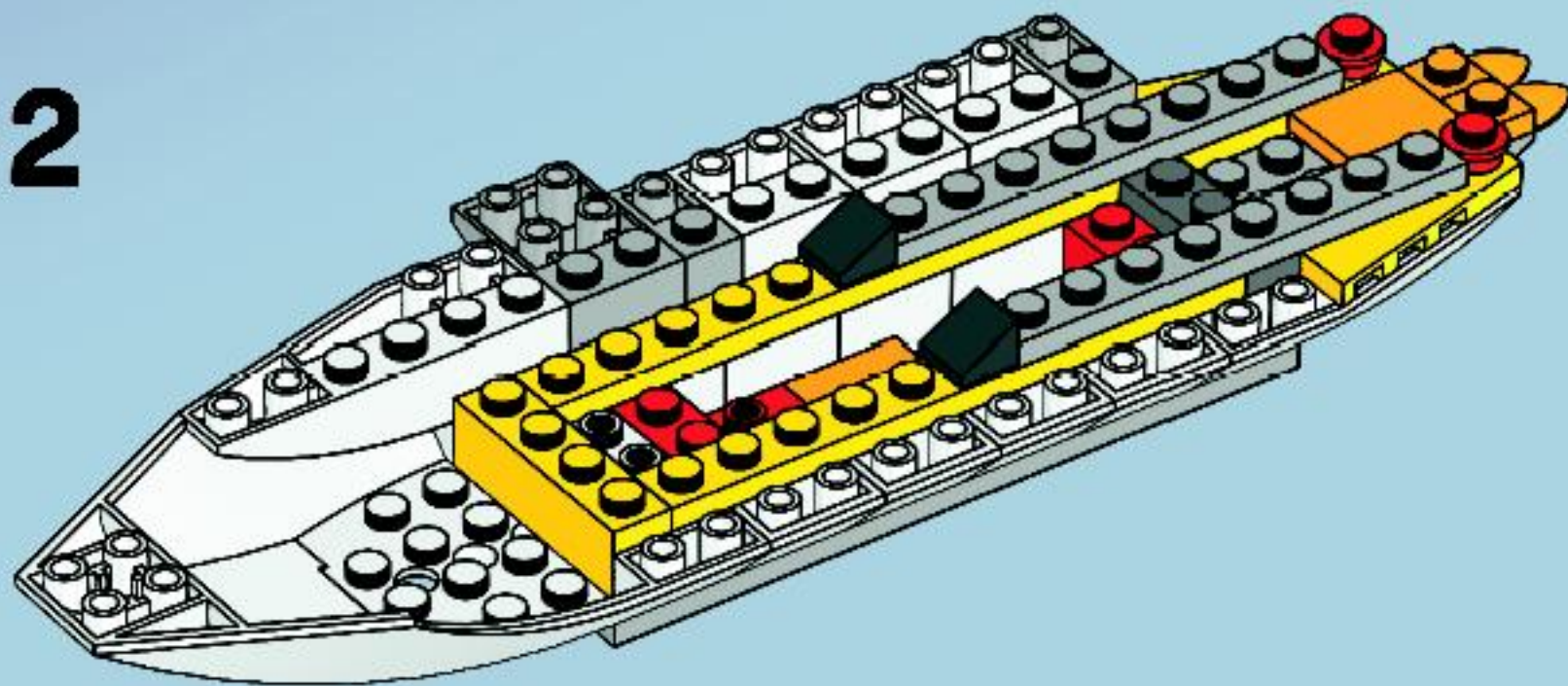

13

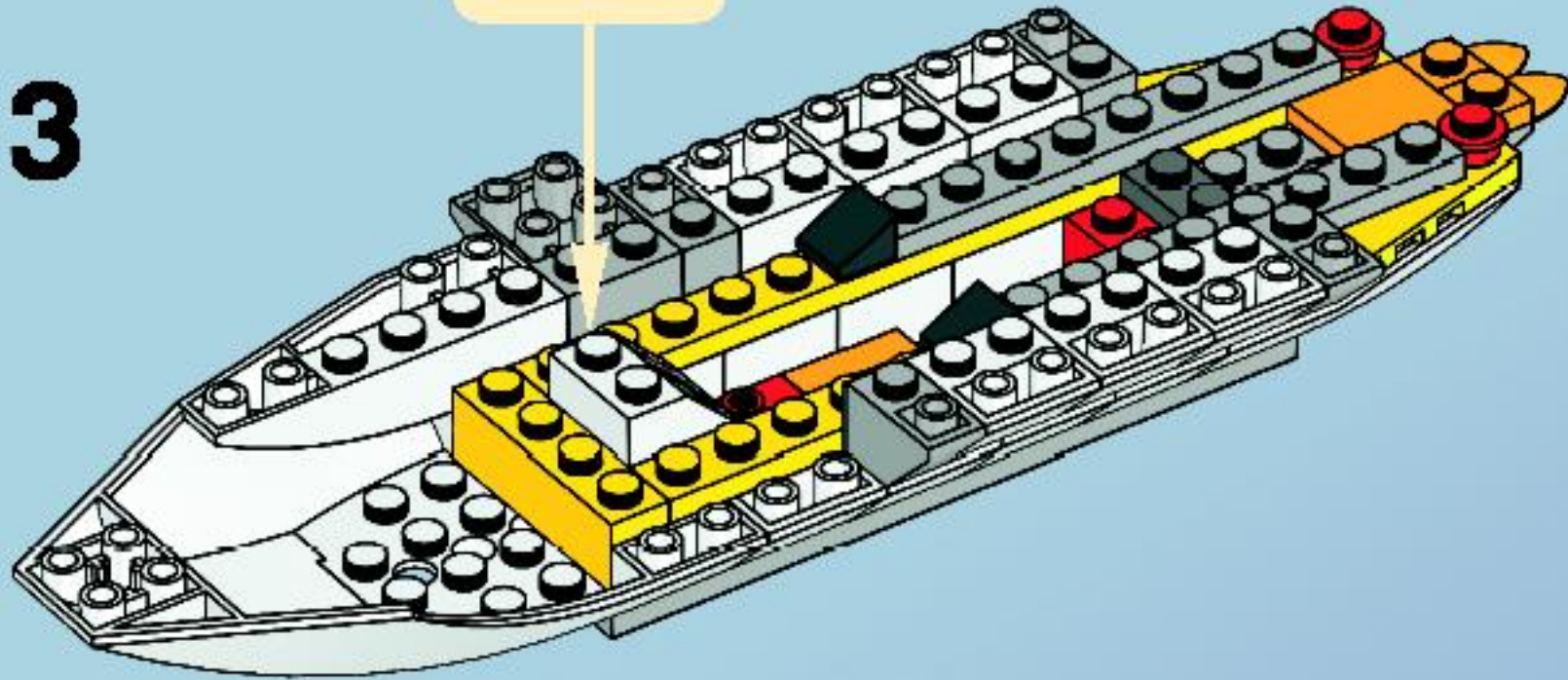

14

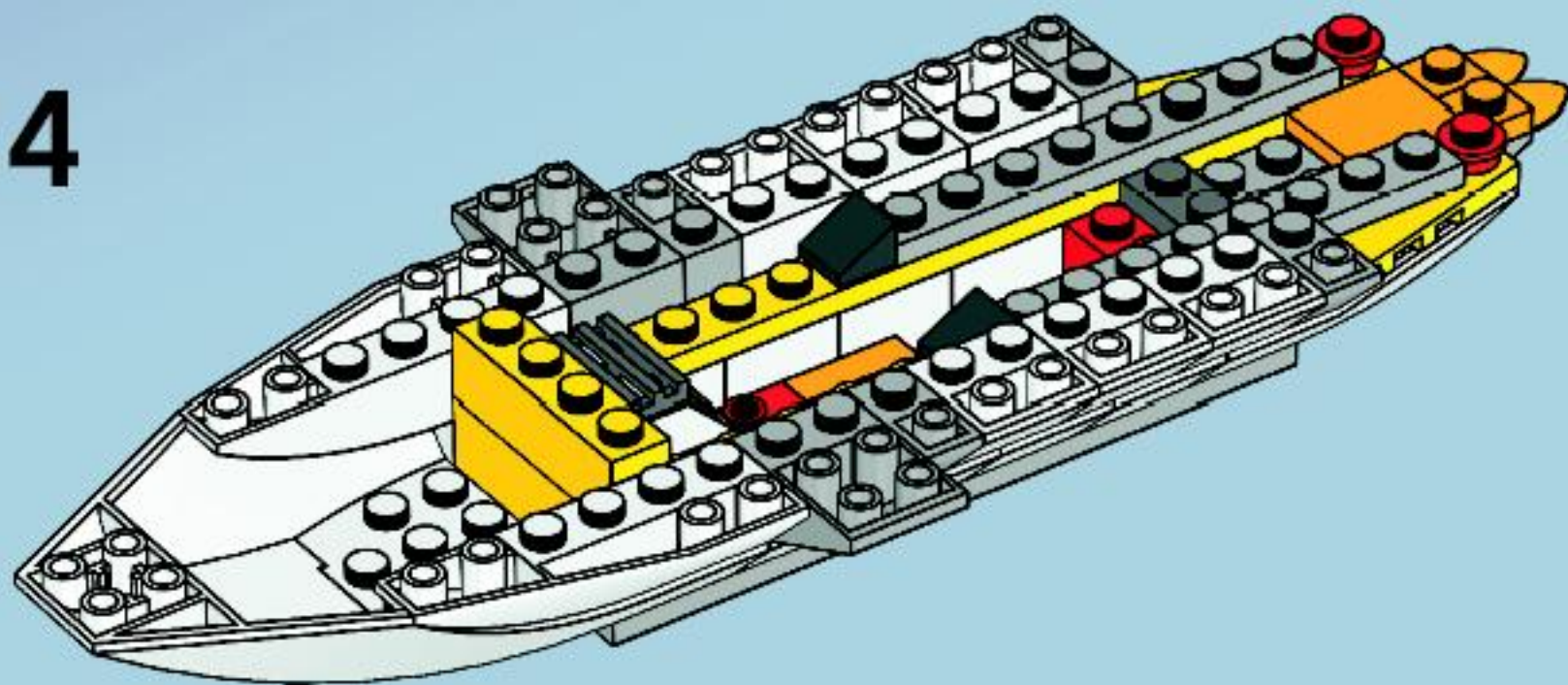

15

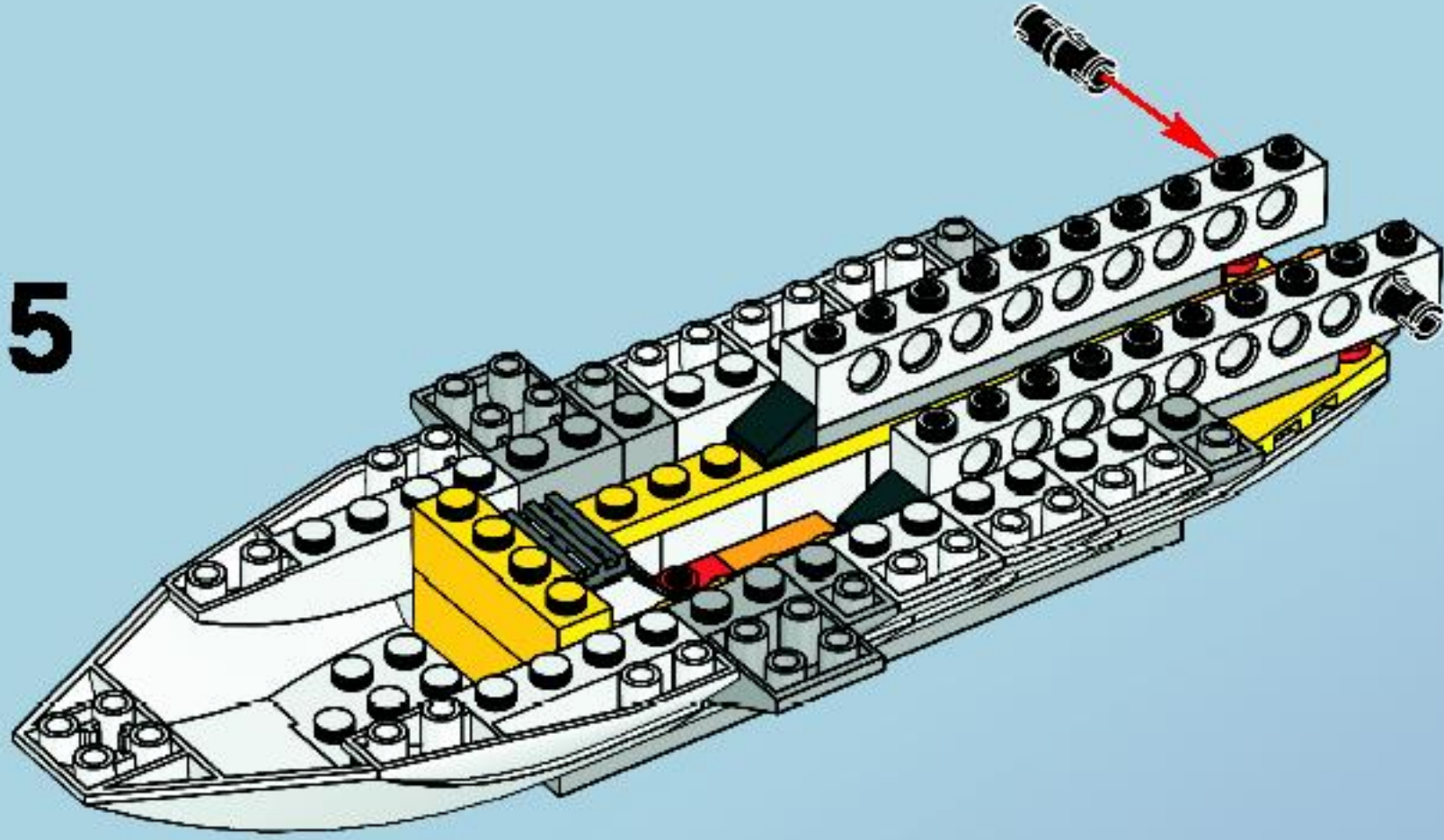

16

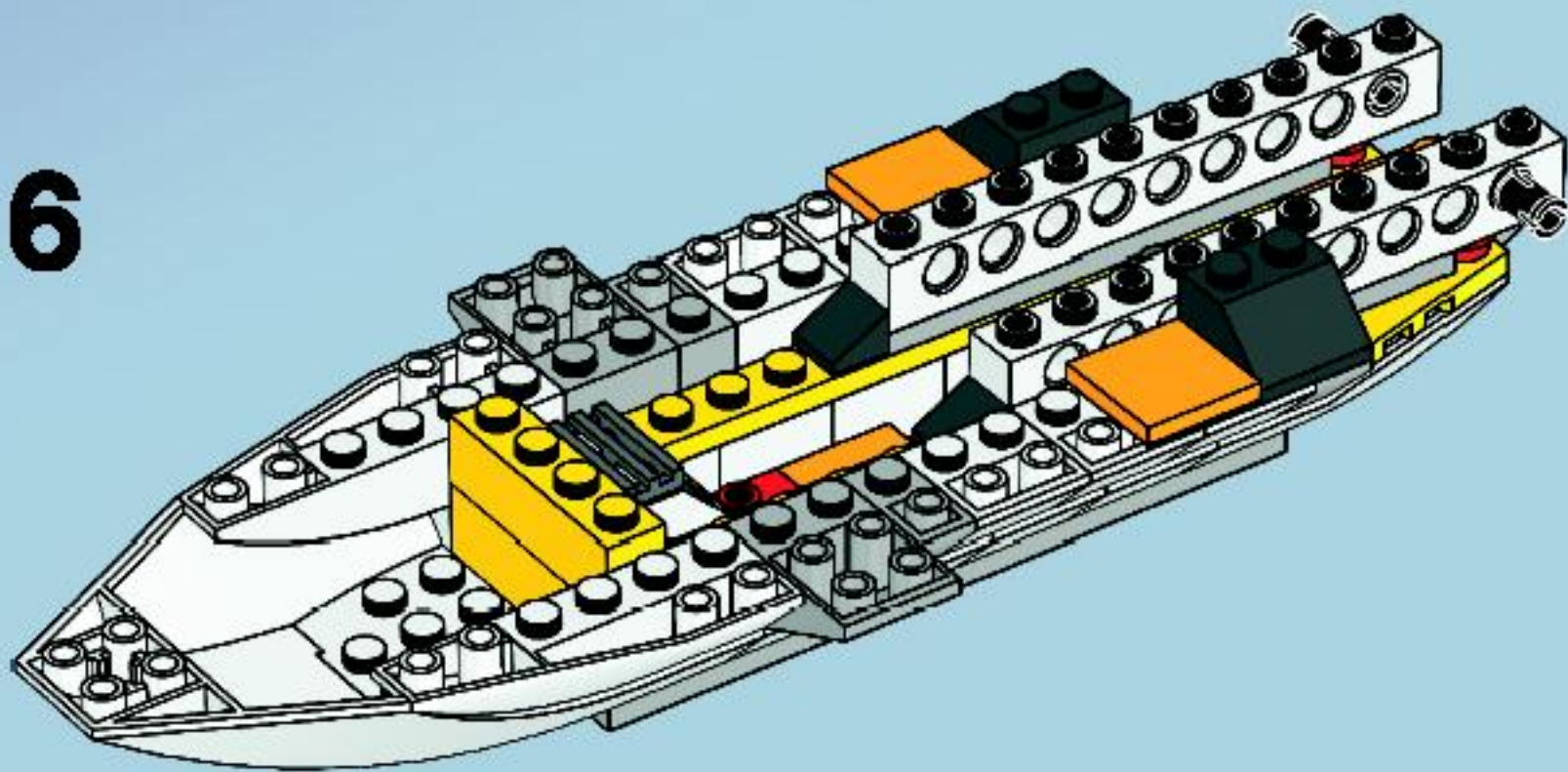

17

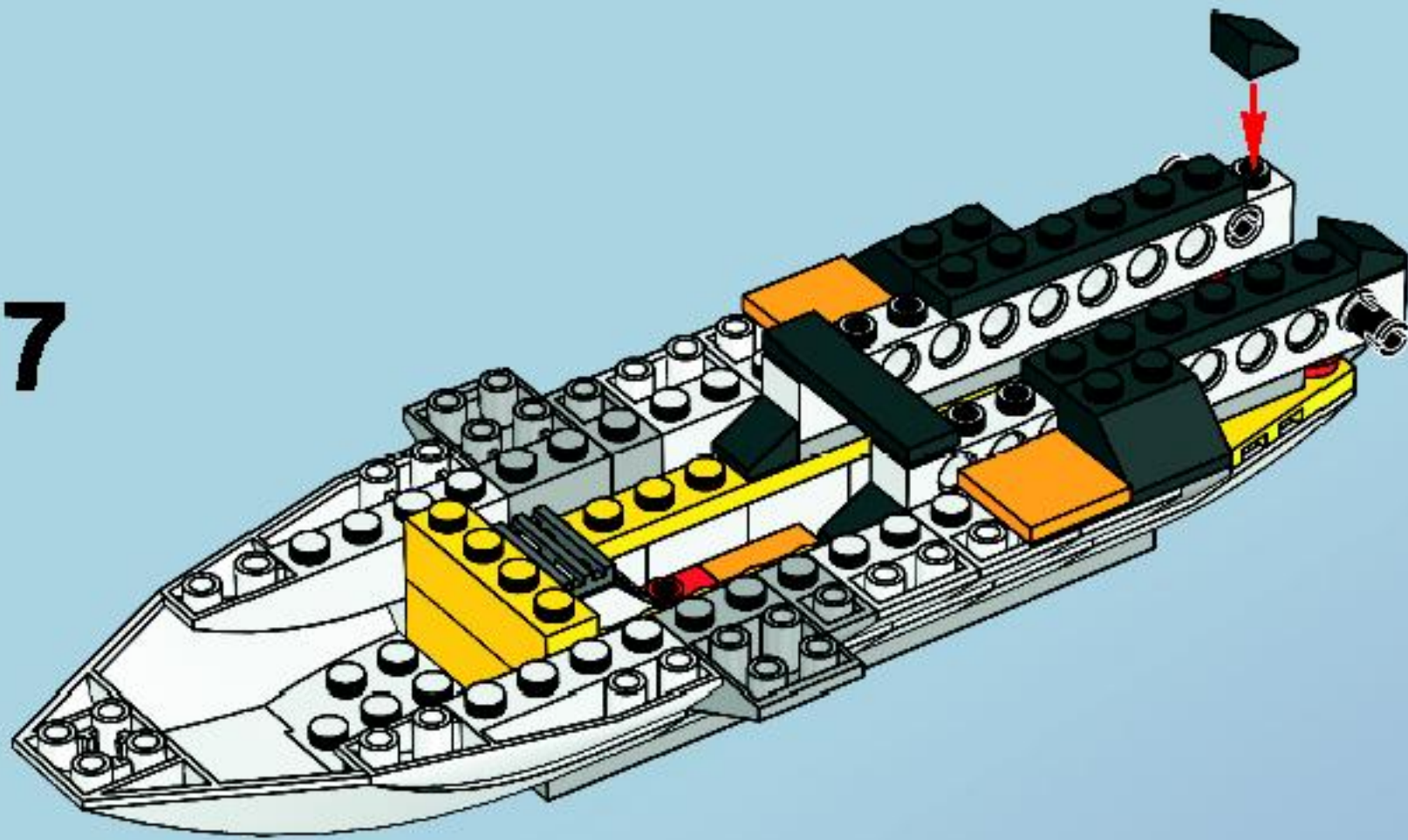

18

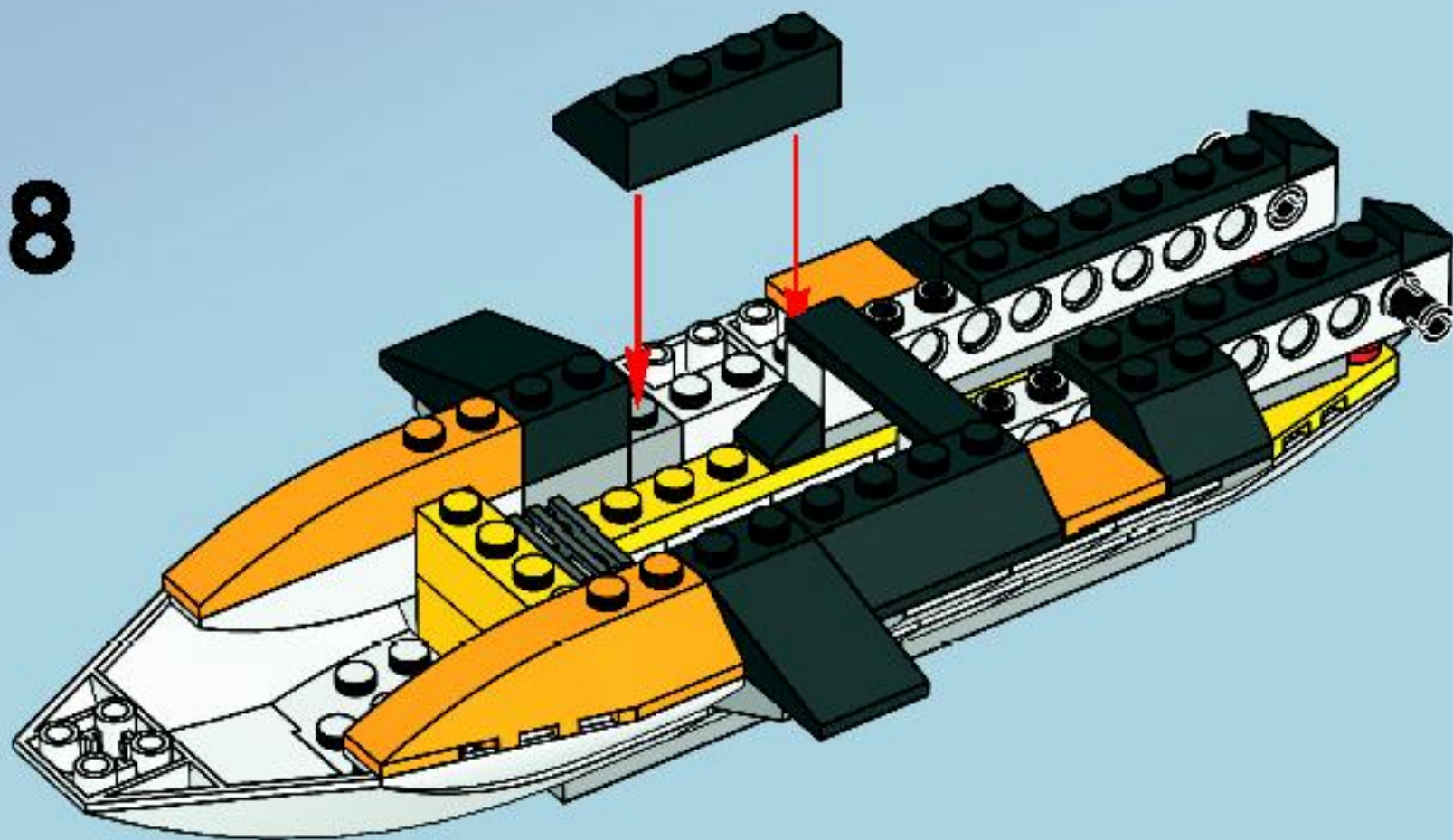

1

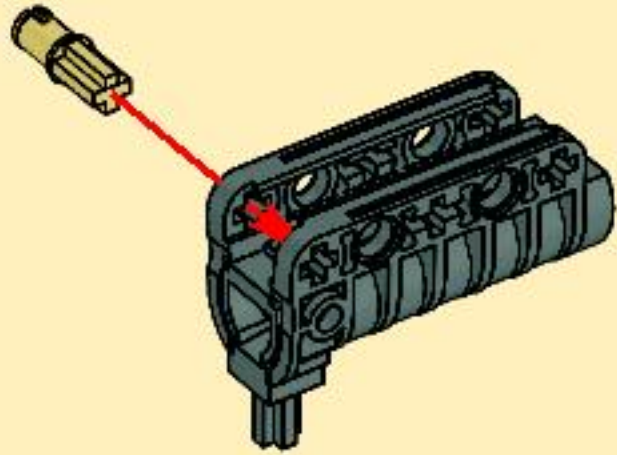

2

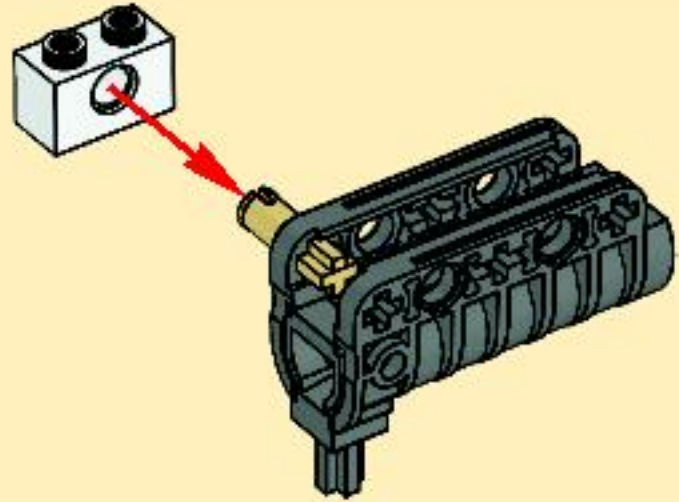

19

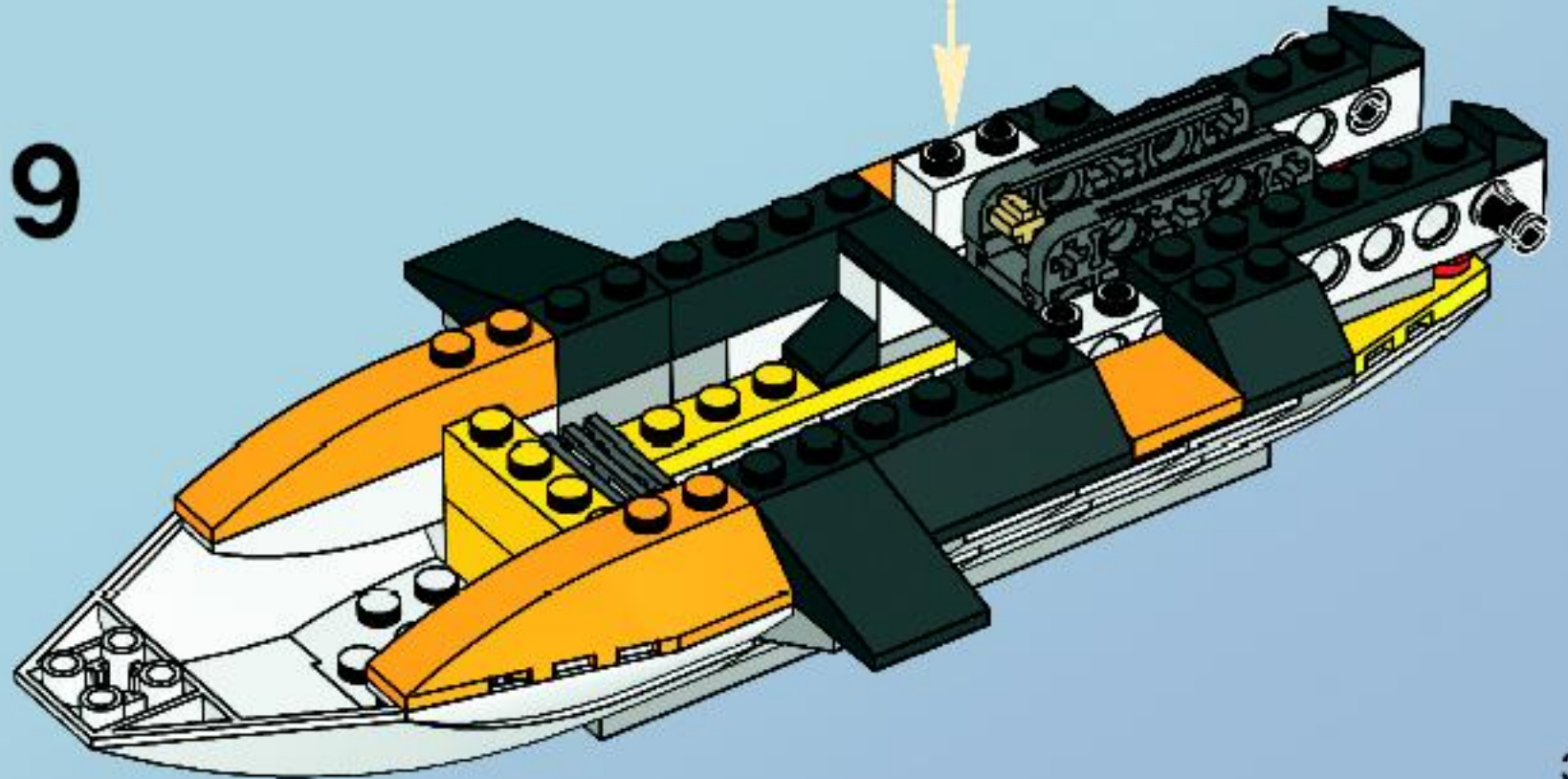

20

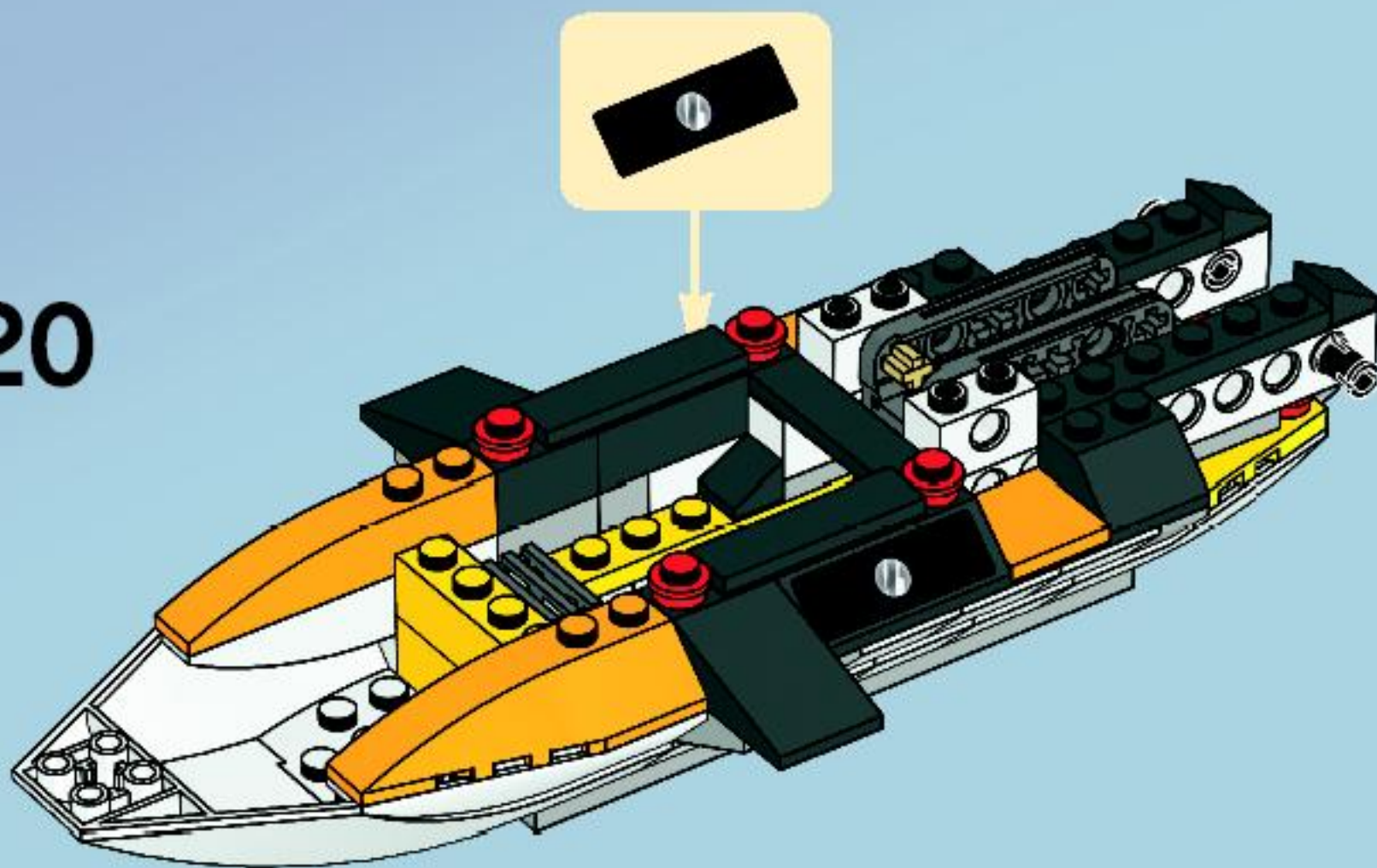

21

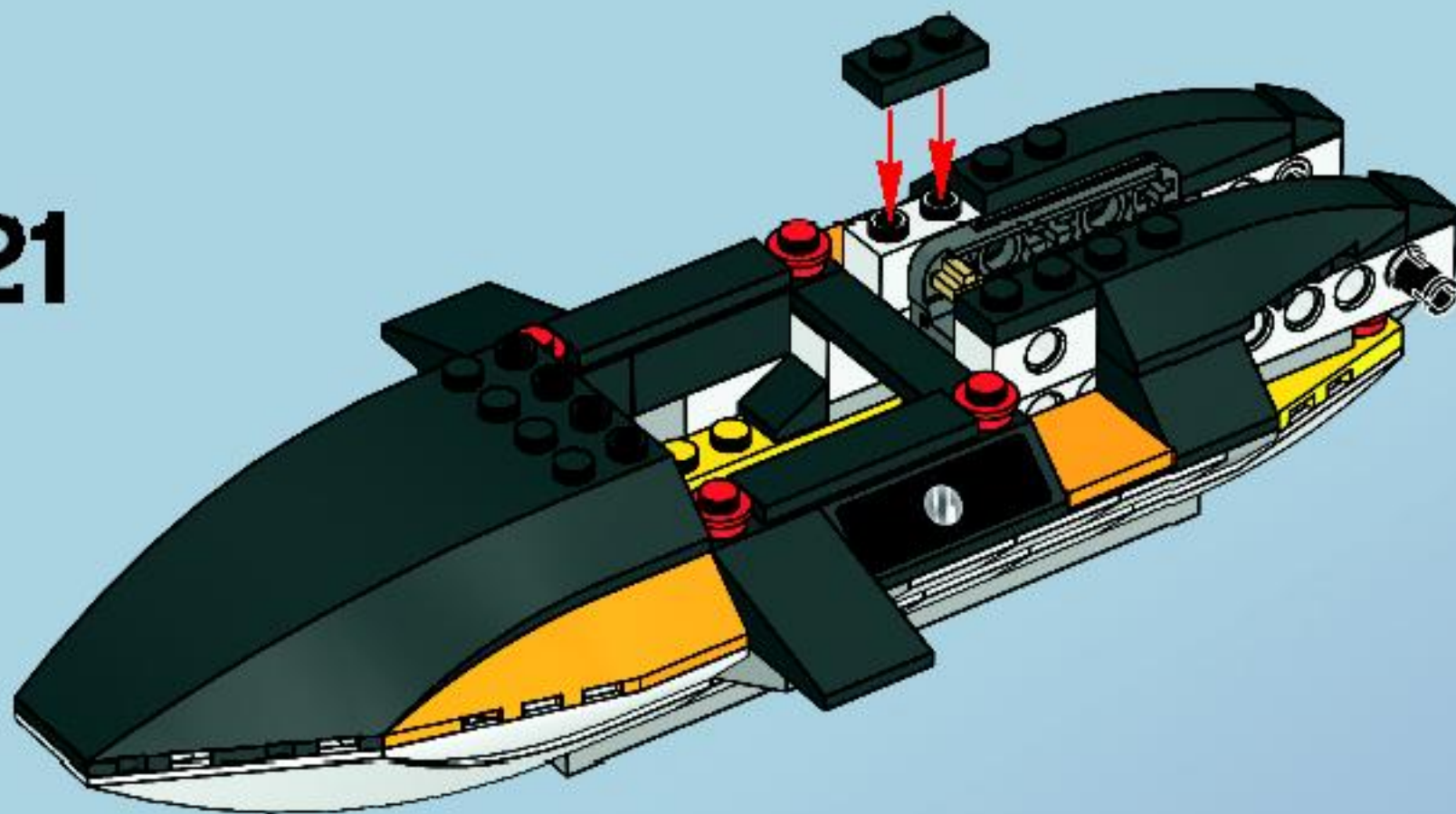

22

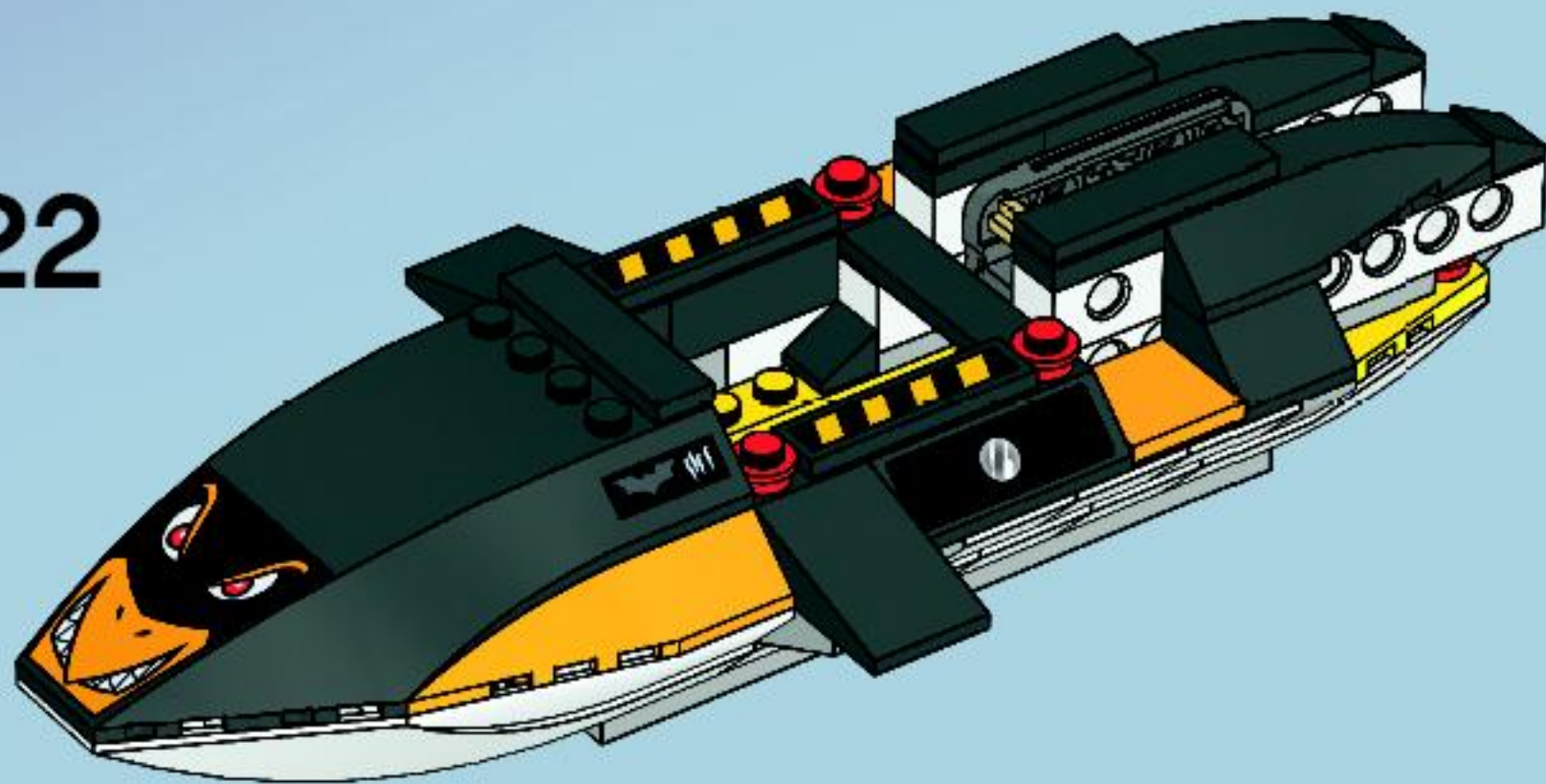

23

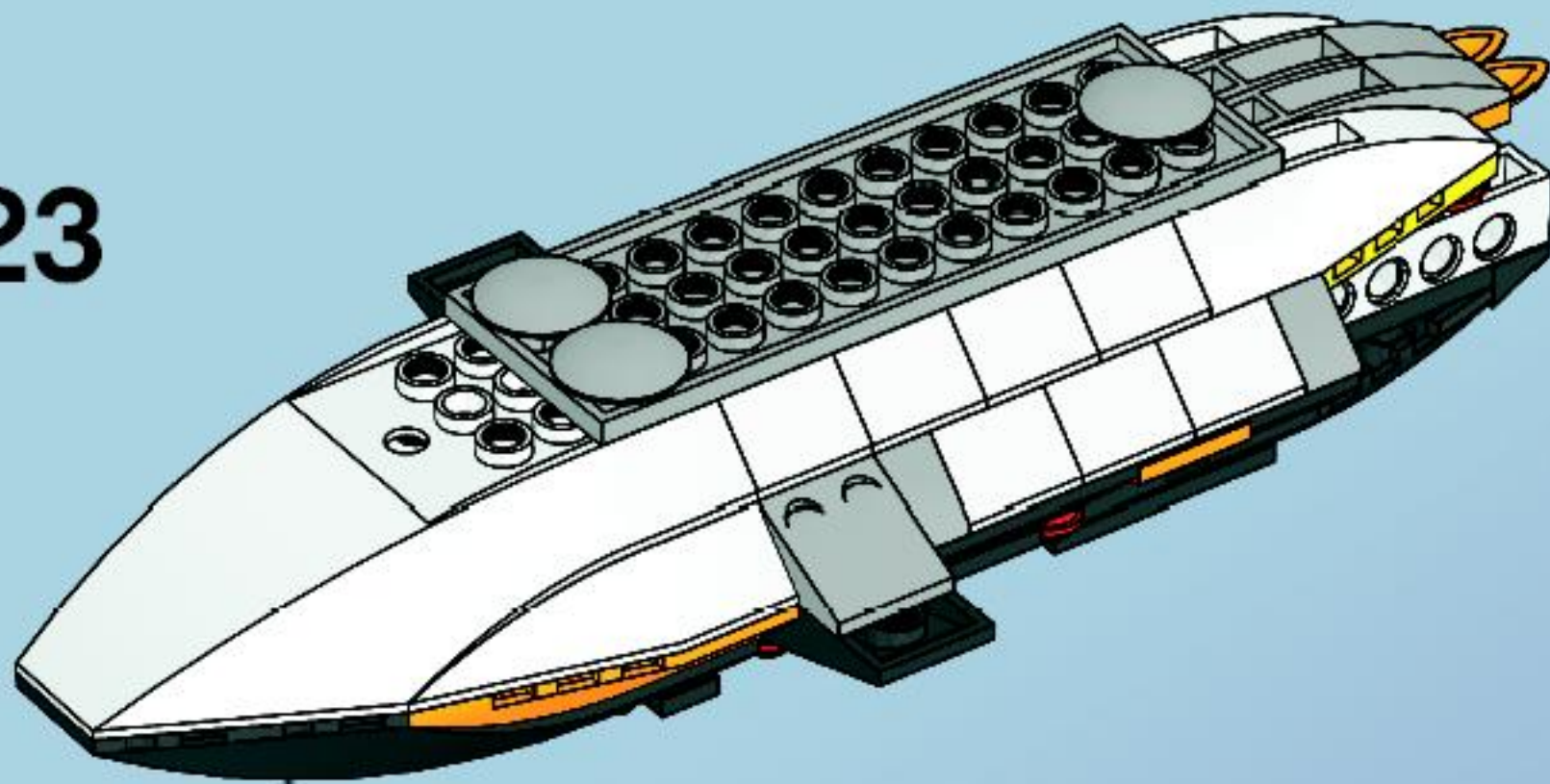

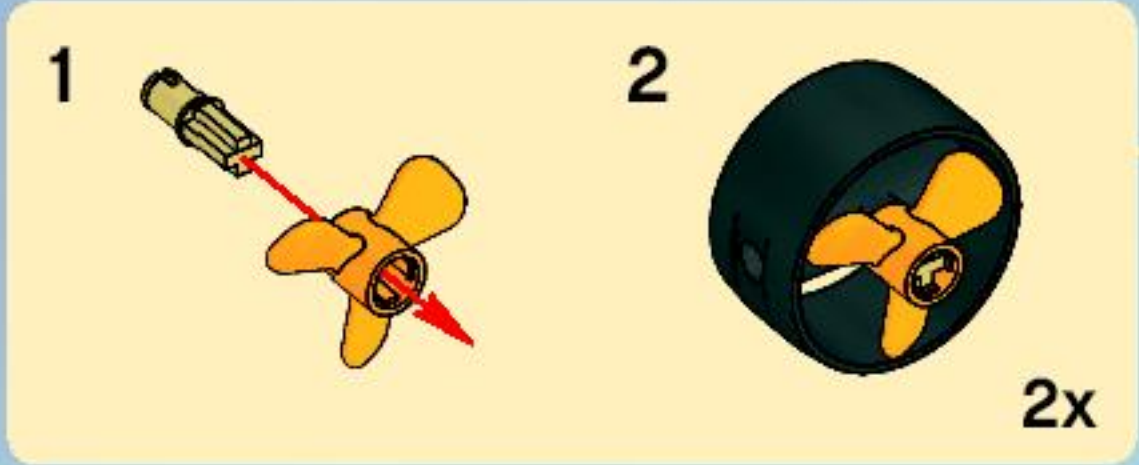

24

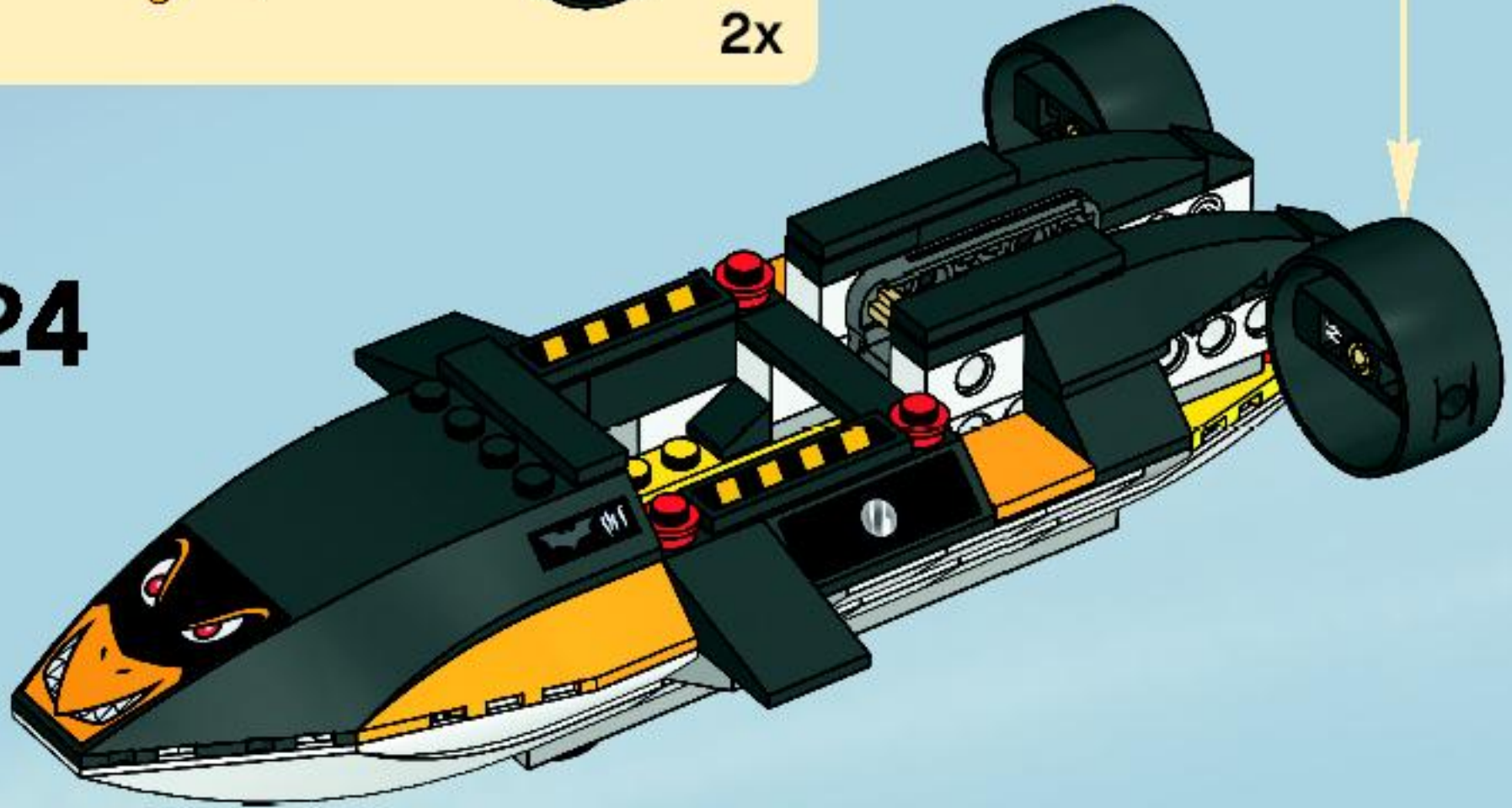

1

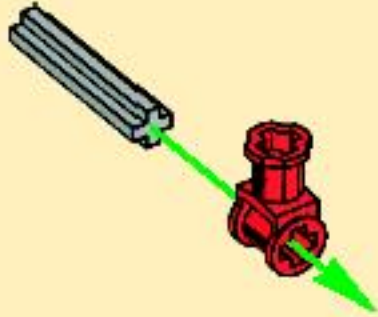

2



25

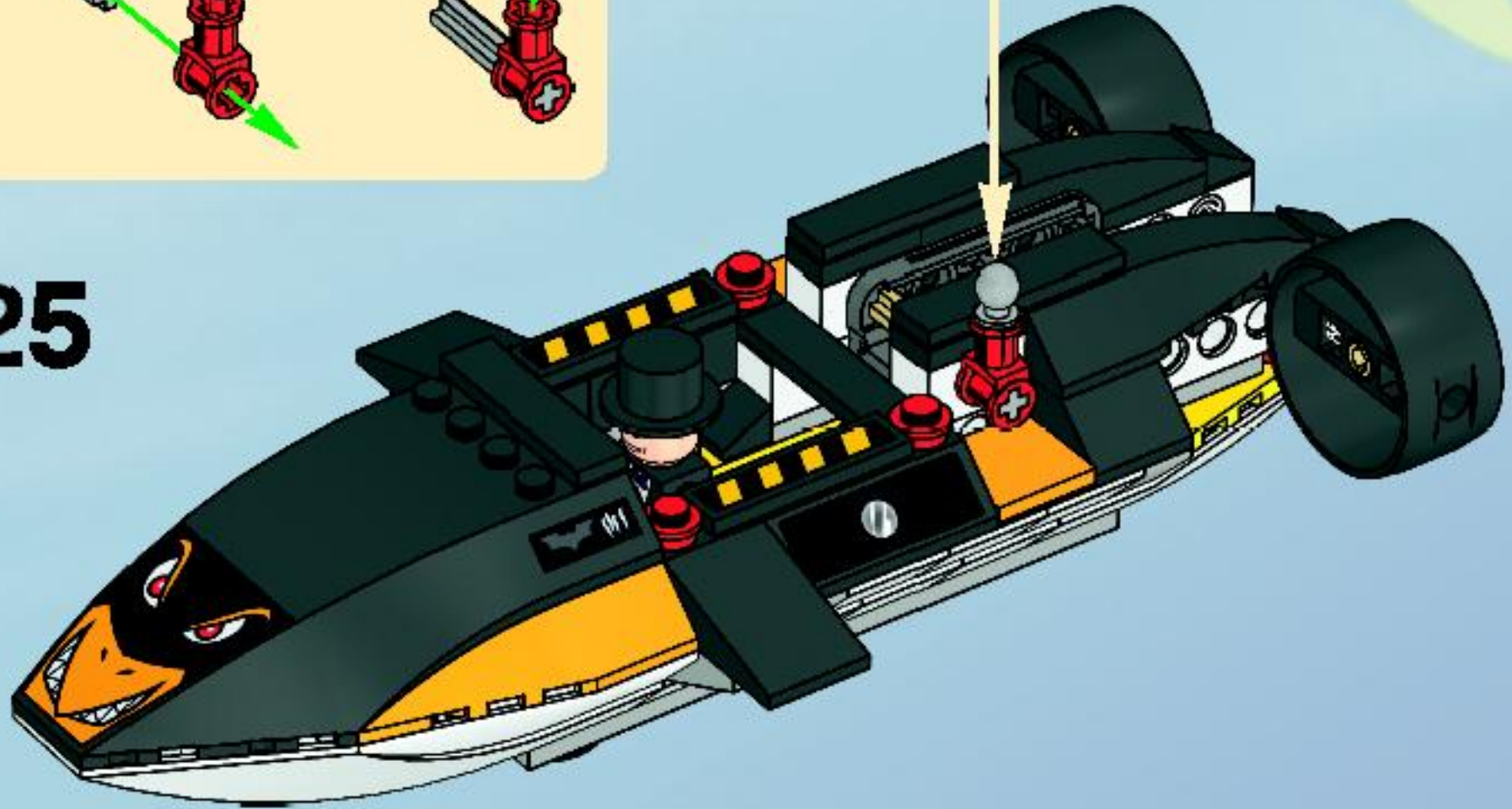



1

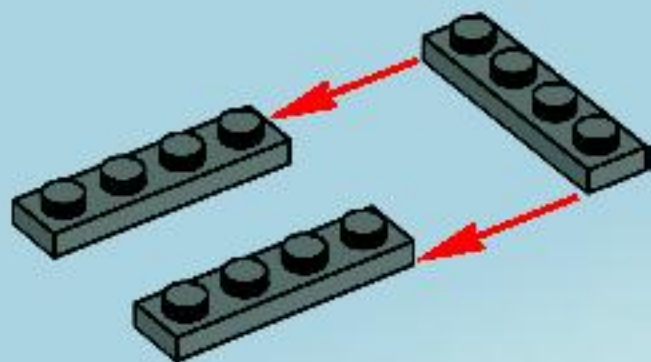

2

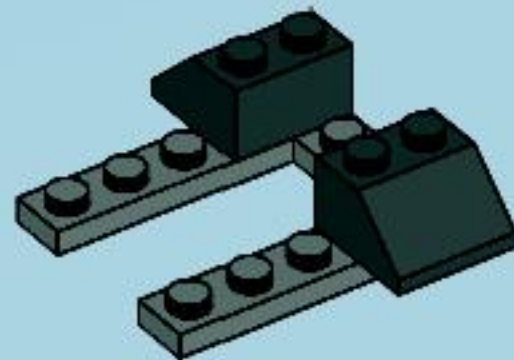

3

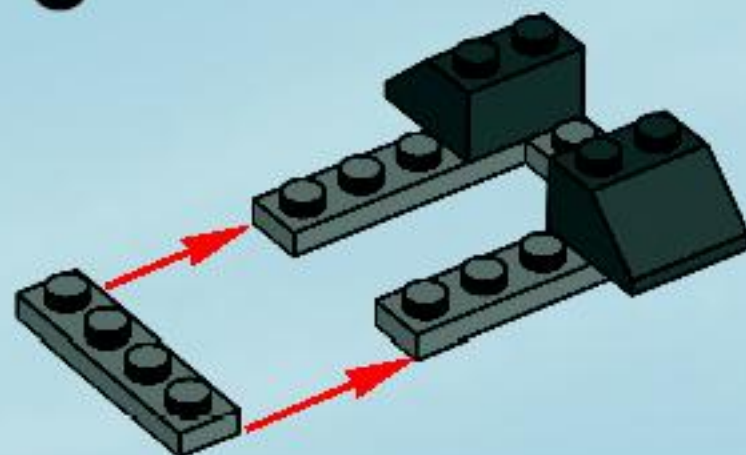



4

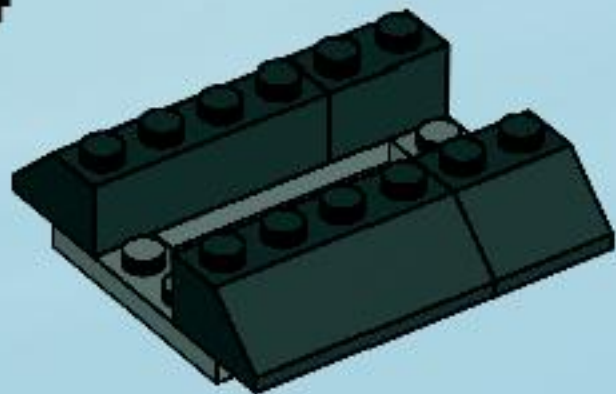

5

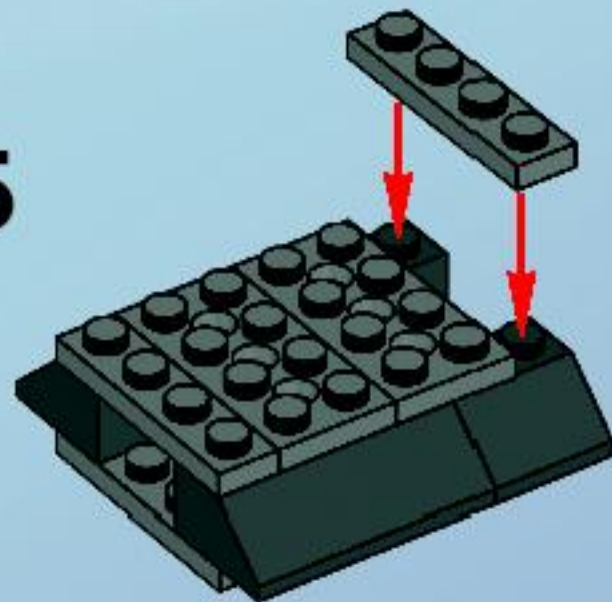

6

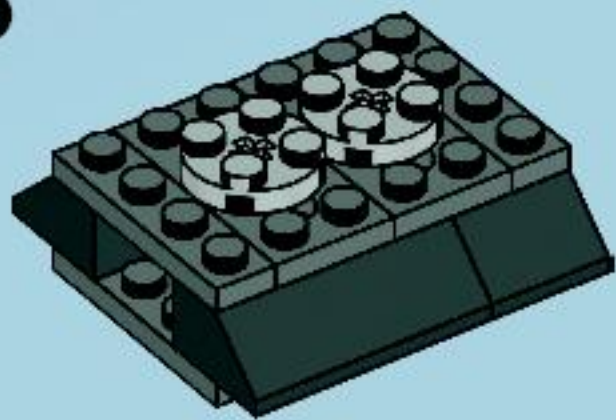

7

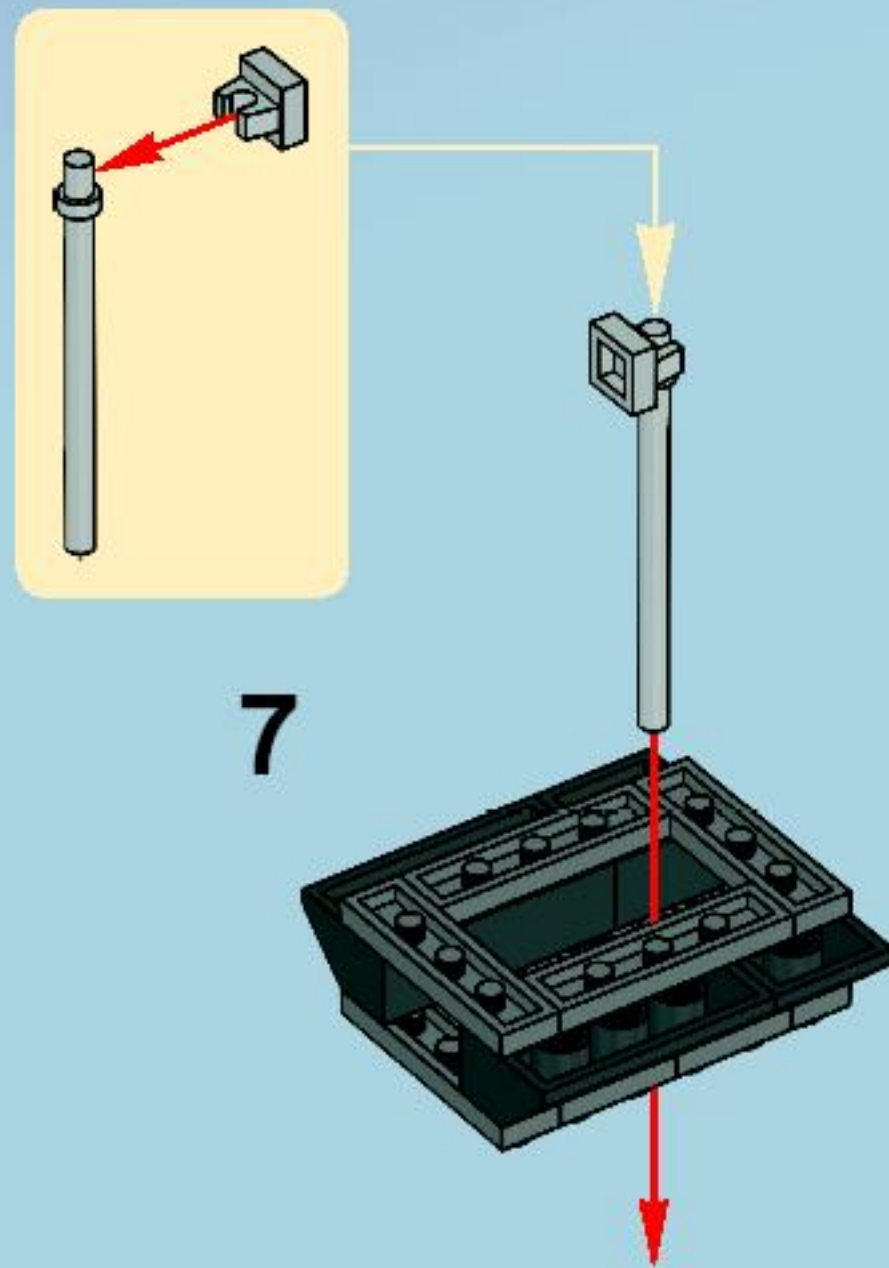

8

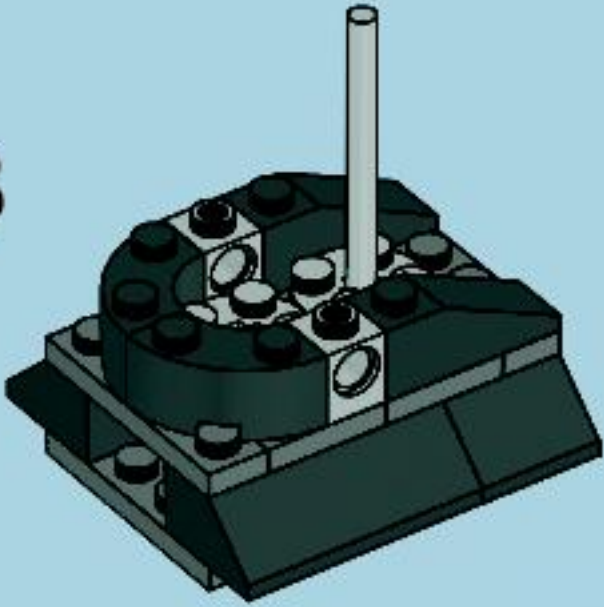

9

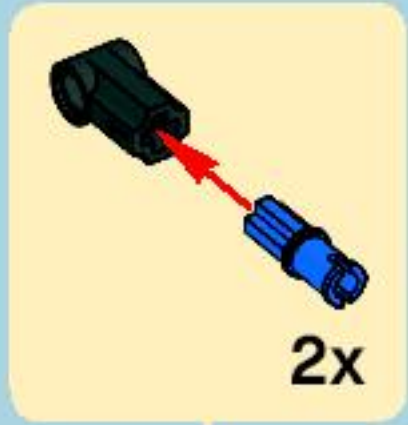
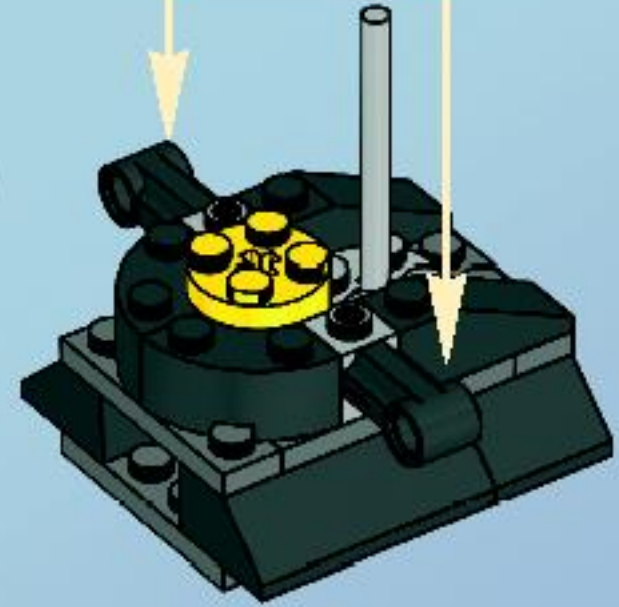

2x

10

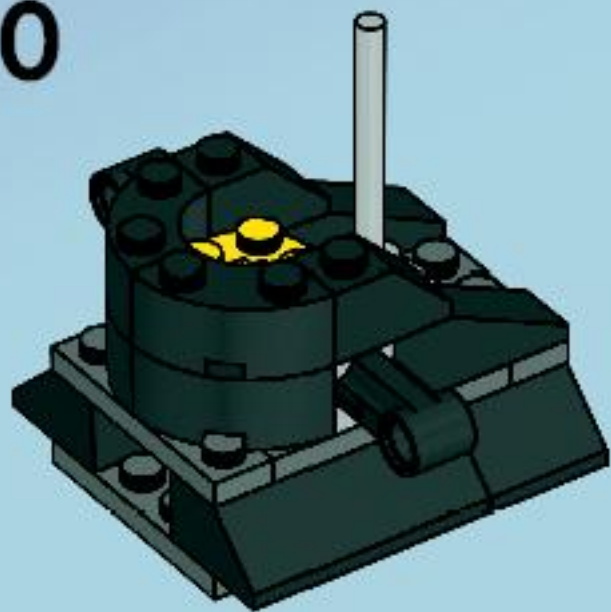

11

U99

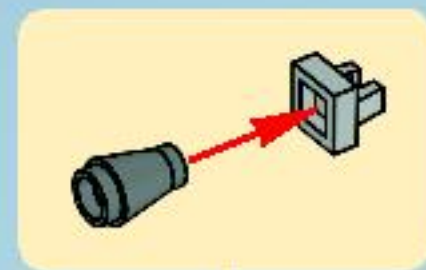
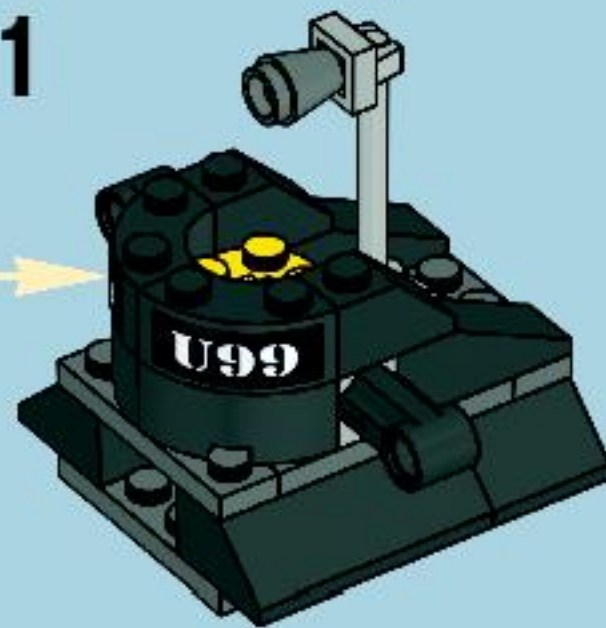

12

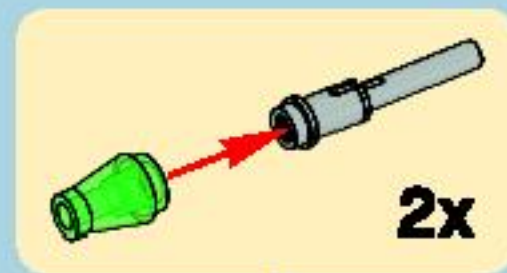
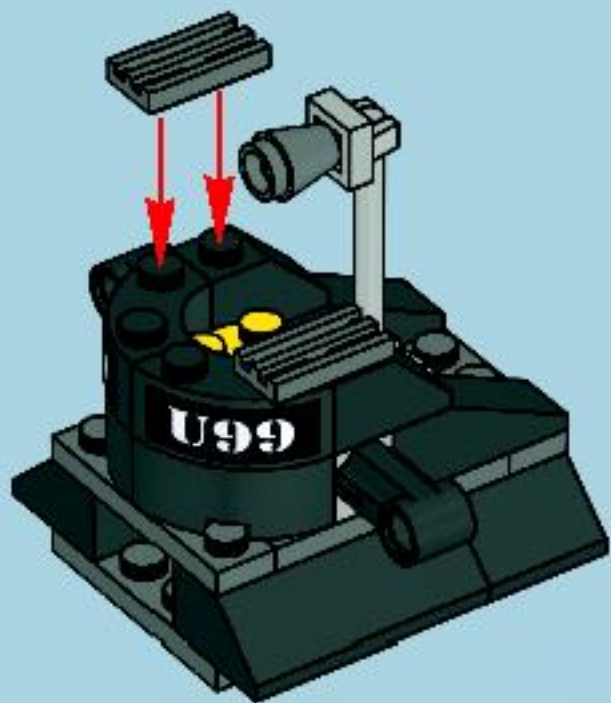

13

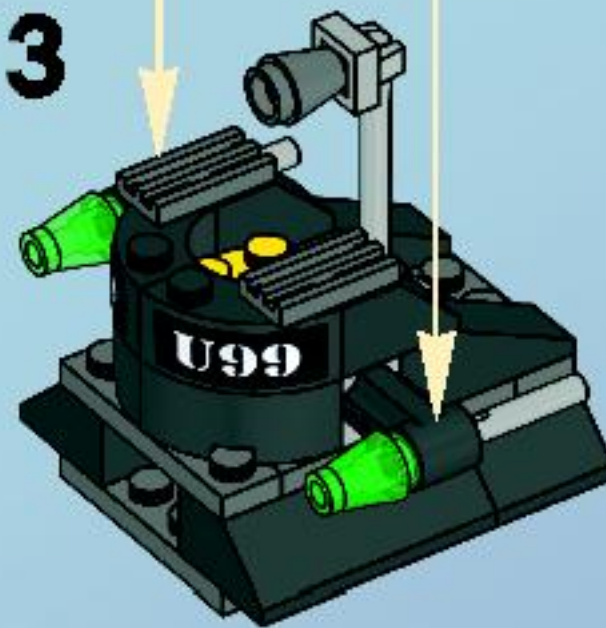



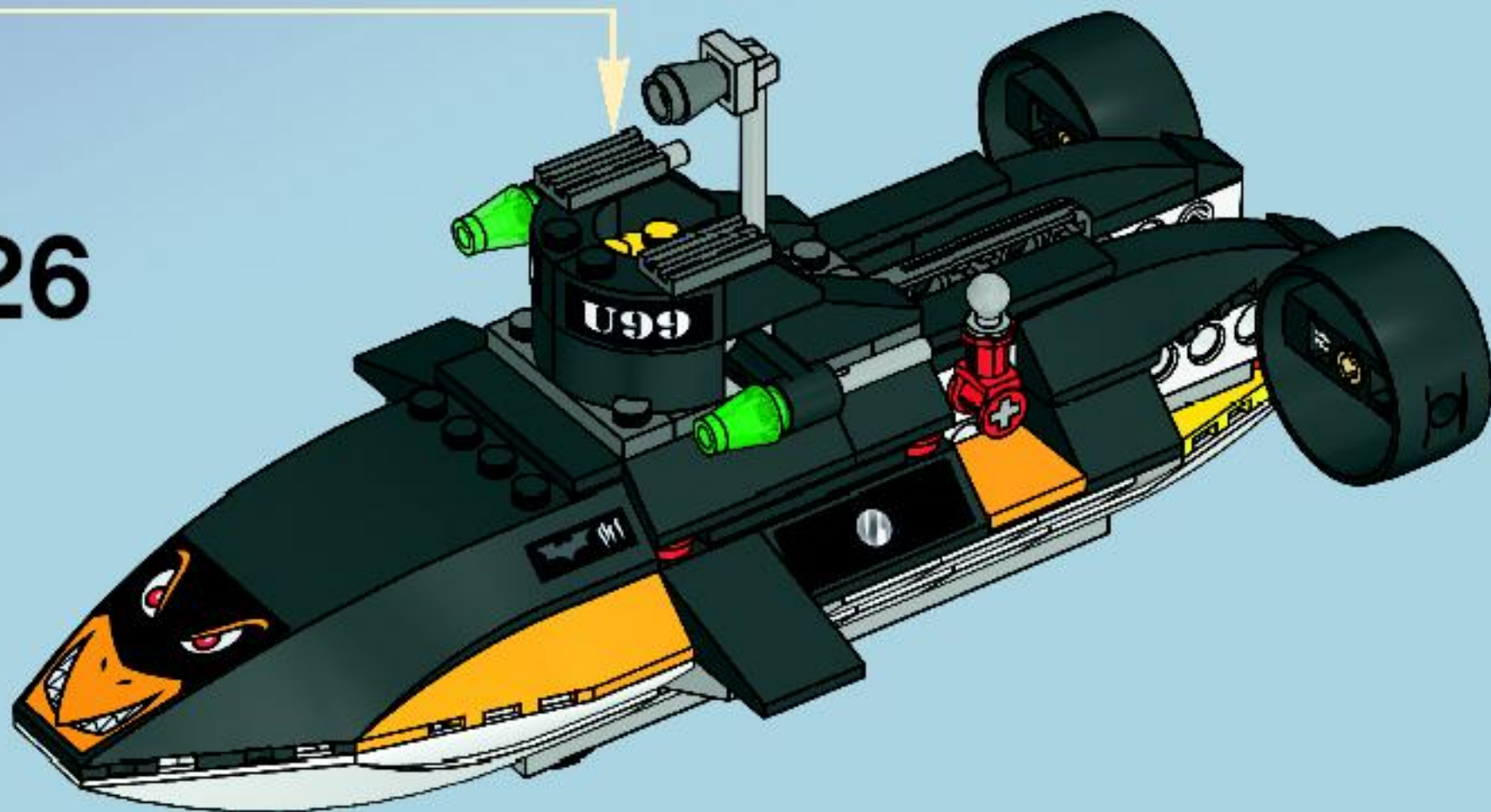



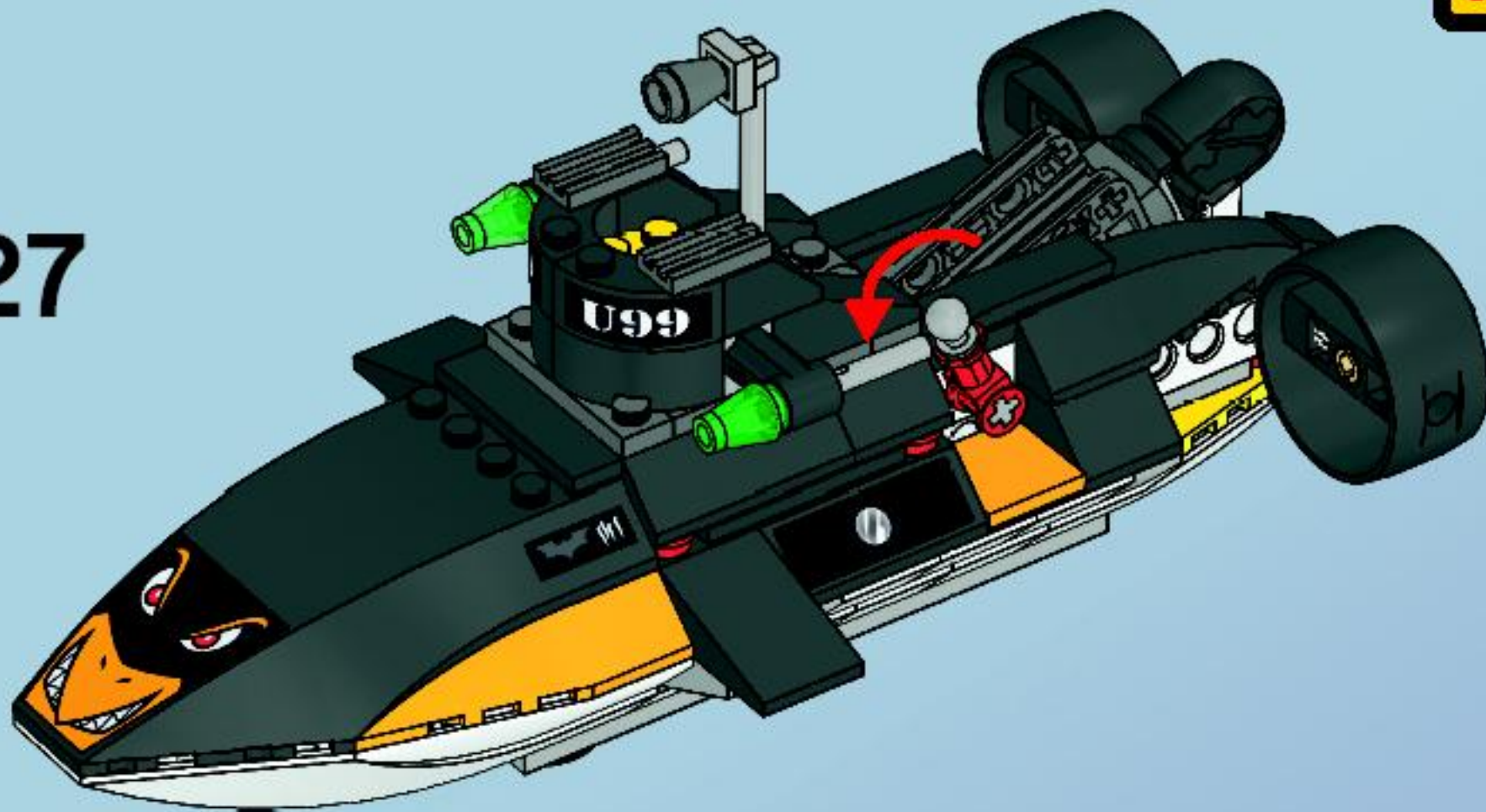

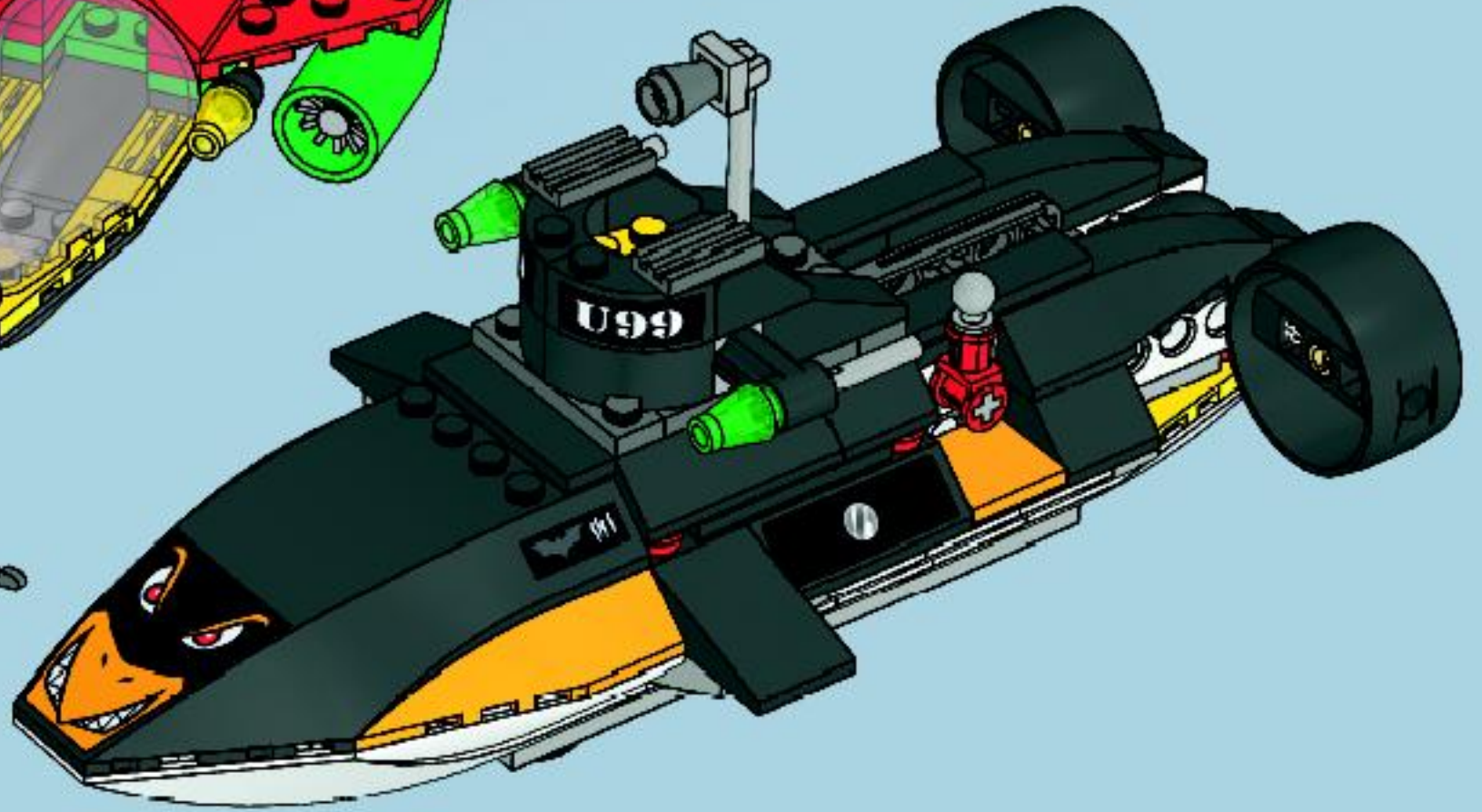
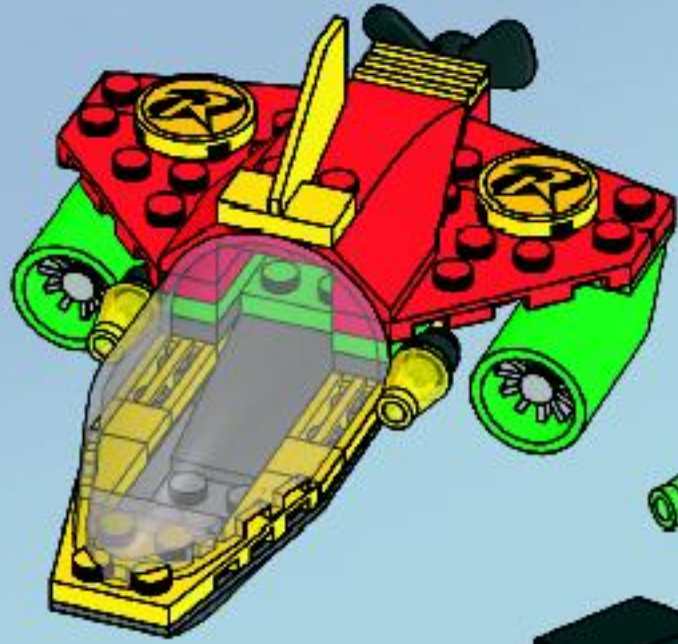



















































26



27

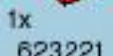



- | | | | | | | |
|--|--|--|---|--|--|--|
| 
4x
4282860 | 
2x
4161275 | 
1x
4296306 | 
1x
4161329 | 
2x
415024 | 
2x
447724 | 
2x
302326 |
| 
2x
4525873 | 
2x
4161260 | 
1x
4296307 | 
1x
4160866 | 
1x
4294641 | 
2x
408126 | 
1x
4105175 |
| 
4x
4525871 | 
2x
370001 | 
2x
4206482 | 
1x
4180480 | 
1x
4184296 | 
2x
4273590 | 
1x
4297626 |
| 
1x
4525867 | 
2x
273001 | 
6x
614121 | 
2x
4178728 | 
2x
301024 | 
2x
4107085 | 
2x
366626 |
| 
1x
4525866 | 
2x
273001 | 
2x
408521 | 
1x
4297613 | 
1x
4161331 | 
2x
255526 | 
1x
604126 |
| 
2x
4111971 | 
1x
4208132 | 
2x
379421 | 
2x
307024 | 
1x
4160868 | 
2x
4121715 | 
6x
4504382 |
| 
2x
307001 | 
1x
4262614 | 
1x
4118897 | 
2x
300421 | 
2x
4234927 | 
4x
4164471 | 
2x
4121966 |
| 
1x
4261941 | | 
2x
300421 | 
3x
241224 | 
2x
362324 | 
2x
307026 | 
2x
428626 |
| 
14x
366001 | | 
1x
623221 | 
1x
614324 | | 
6x
243126 | 
4x
303926 |

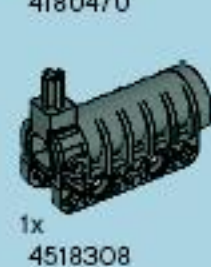
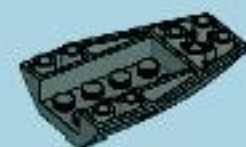
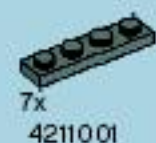
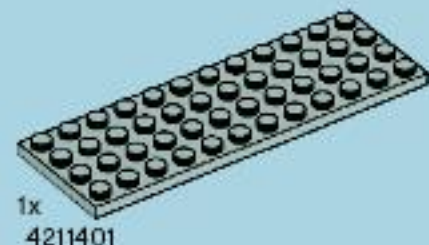
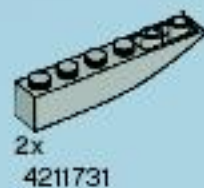

Customer Service

Kundenservice

Service Consommateurs

Servicio Al Consumidor

www.lego.com/service or dial



00800 5346 5555 :

1-800-422-5346 :



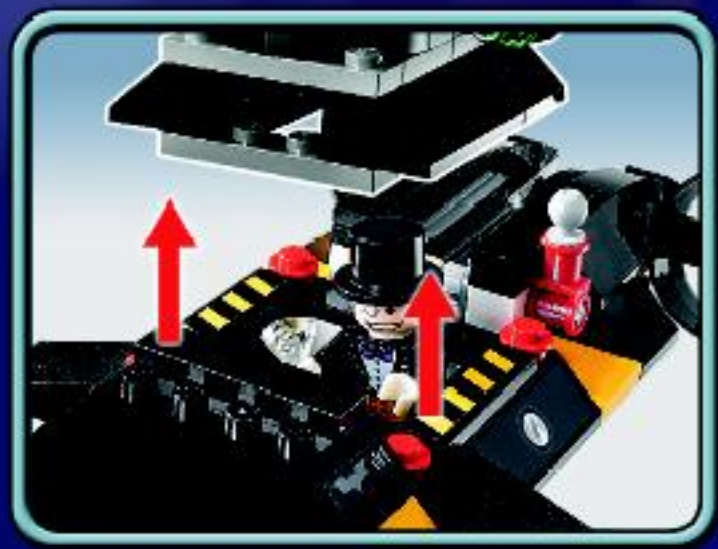
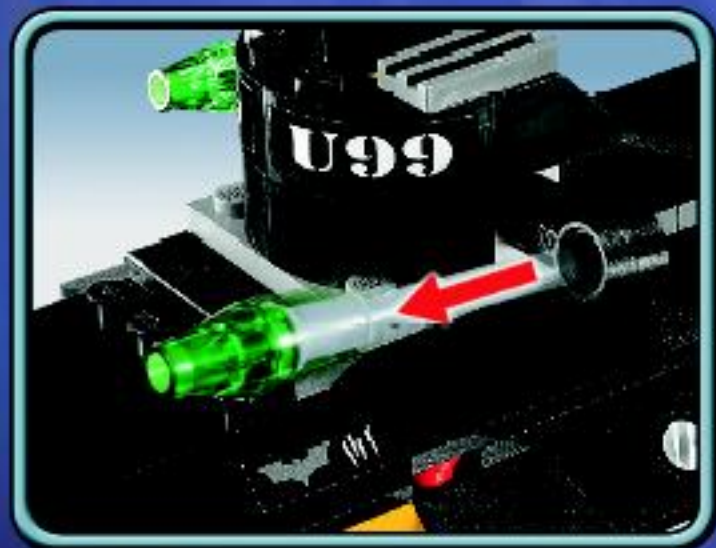

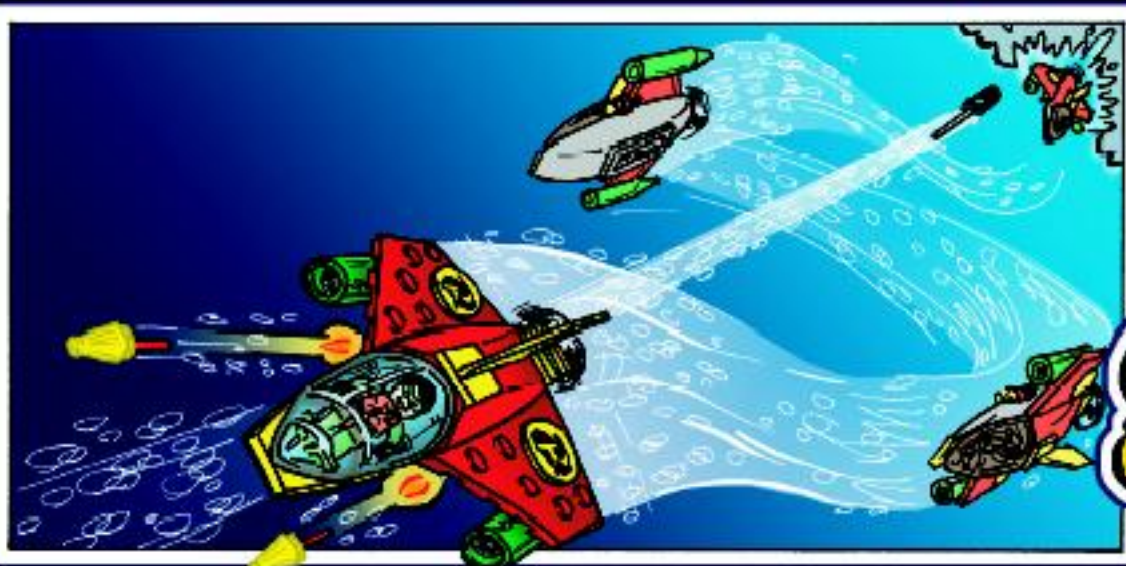



BATMAN™

THE VIDEOGAME

COMING FALL 2008



PlayStation 2

PLAYSTATION 3

NINTENDO DS



Games for Windows



XBOX 360 LIVE

Wii



LEGO is a registered trademark of the LEGO Group, which does not authorize, in any way, the use of the name "LEGO" for any other product or service.

© 2008 DC Comics. All rights reserved. Batman, Robin, Gotham City, and the DC Comics characters Batman, Robin, and Gotham City are trademarks of DC Comics. All other trademarks are the property of their respective owners.

LEGO, the LEGO logo, the Minifigures logo and the "LEGO" brand name in full or partial are trademarks of the LEGO Group. © 2008 Warner Bros. Entertainment Inc. All rights reserved. TM, ® and ® are used under license from DC Comics. All other trademarks are the property of their respective owners.

7886

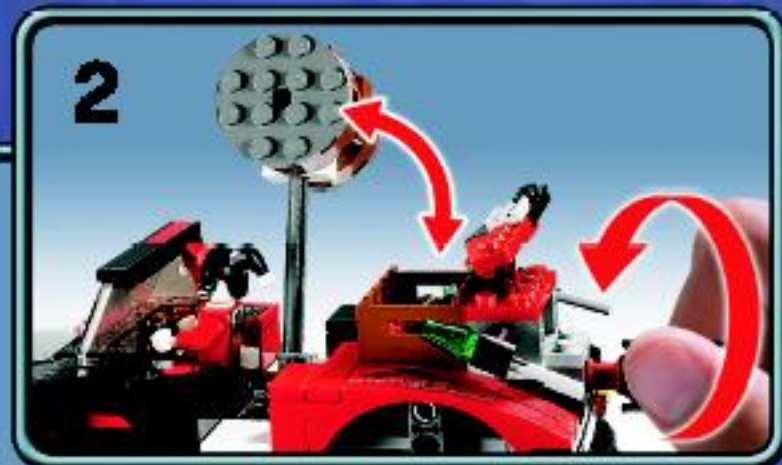

7884





7888



7885



7884



7886



club™



FREE LEGO Magazine • GRATUIT • GRATIS LEGO Magazin



Join Today!

**Abonne-toi
dès aujourd'hui!**

Meld je nu aan!

Jetzt anmelden!

BC2# US & Canada only
1-866-534-6258 / 1-877-518-5346

(in French)



00800 5346 5555

www.LEGOclub.com



**VISIT THE WORLD'S
BIGGEST LEGO® SHOP!**

www.LEGOshop.com

WIN LEGO® PRODUCTS

No purchase necessary.
Open to residents of all countries where not prohibited.
Go to www.lego.com for official rules and details.

WIN LEGO® PRODUCTEN

Kopen niet nodig.
Open voor alle leeftijden, en in alle landen waar geen verbod geldt.
Ga naar www.lego.com voor officiële regels en details.

GEWINNE LEGO® PRODUKTE

Die Teilnahme am Gewinnspiel führt zu keinerlei Kaufverpflichtungen.
Sie können in allen nicht ausgeschlossenen Ländern teilnehmen.
Die offiziellen Regeln und nähere Informationen finden Sie unter www.lego.com.

GAGNE DES PRODUITS LEGO®

Aucun achat n'est nécessaire.
Ouvert à tous les âges et aux résidents de tous les pays, sauf en cas d'interdiction.
Rendez-vous sur www.lego.com pour obtenir plus de détails et le règlement officiel.

レゴ®製品を「当てよう」

購入は不要です
禁止されていない限り、あらゆる年代およびあらゆる国の居住者の方々にご利用いただけます。
公認規則および詳細につきましては、www.lego.comをご覧ください



LEGO, the LEGO logo and the Minifigure are trademarks of the
sort des marques de commerce de son marcus regimadas de LEGO Group.
BATMAN and all related characters and elements are trademarks of and © DC Comics. BATMAN et tous
les personnages et éléments qui y sont associés sont des marques de commerce et © de DC Comics.
BATMAN y todos sus personajes y elementos relacionados son marcas y © de DC Comics.
© WB SHIELD: TMHC & © Warner Bros. Entertainment Inc.
(2008)

