



SONIC™

THE HEDGEHOG

76992



WARNING: CHOKING HAZARD. Toy contains small parts and a small ball. Not for children under 3 years.



Get excited about our new packaging!

We're switching from plastic to paper-based packaging. That's why you might find a mix of paper and plastic in our boxes!

Nos nouveaux emballages vous emballeront !

Nous passons des emballages en plastique aux emballages à base de papier. C'est pourquoi vous pourriez trouver un mélange de papier et de plastique dans nos boîtes !

¡Te presentamos nuestros nuevos empaques!

Estamos sustituyendo las bolsas de plástico por bolsas con base de papel. ¡Por eso, puedes encontrar una mezcla de papel y de plástico en nuestras cajas!

[LEGO.com/sustainable-packaging](https://www.lego.com/sustainable-packaging)



BUILDER



Apple and the Apple logo are trademarks of Apple Inc., registered in the U.S. and other countries and regions. App Store is a service mark of Apple Inc. Google Play and the Google Play logo are trademarks of Google LLC. Tencent and the Tencent logo are trademarks of Tencent Inc.

[LEGO.com/devicecheck](https://www.lego.com/devicecheck)

EN Ask parents' permission before going online | **DE** Eltern um Erlaubnis bitten, bevor du online gehst | **FR** Demande l'autorisation d'un parent avant d'aller en ligne | **IT** Chiedi il permesso ai tuoi genitori prima di andare online | **ES** Pídeles permiso a tus papás antes de conectarte a Internet | **PT** Peça autorização aos pais antes de acederes online | **ZH** 上网前应先征得父母的同意 | **PL** Poproś rodziców o zgodę, zanim wejdiesz do Internetu | **CS** Než půjdeš na internet, požádej rodiče o svolení | **SK** Skôr než pôjdeš na internet, vypýtaj si povolenie od rodičov | **HU** Kérj szülői engedélyt, mielőtt online csatlakoznál! | **RO** Cere permisiunea părinților înainte de a te conecta online | **BG** Поискайте разрешение от родител, преди да влезете онлайн | **LV** Pirms došanās tiešsaistē palūdz atļauju vecākiem | **ET** Enne Interneti kasutamist küsi vanematelt luba | **LT** Prieš prisijungdami prie interneto, atskirkite tėvų

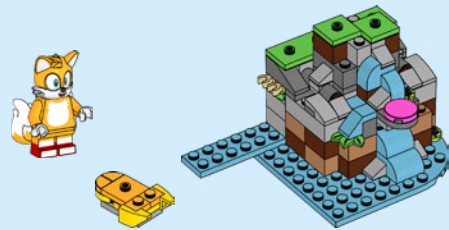
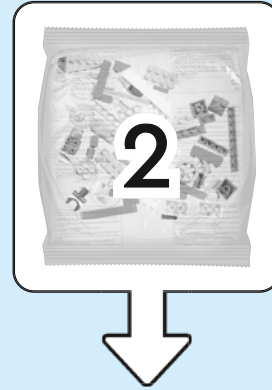

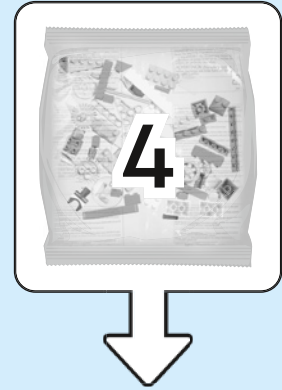
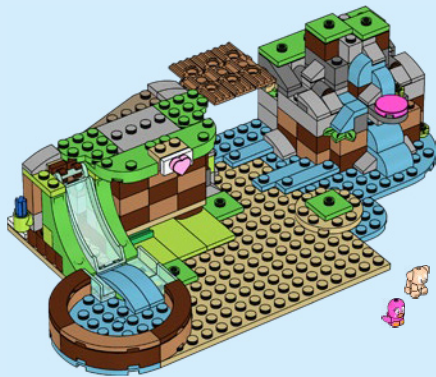



AVERTISSEMENT :
RISQUE D'ÉTOUFFEMENT.

Le jouet contient des petites pièces ainsi qu'une petite boule. Il ne convient pas aux enfants de moins de 3 ans.



ADVERTENCIA:
PELIGRO DE ASFIXIA.

Juguete que contiene partes pequeñas y una pelota pequeña. No recomendado para niños menores de 3 años.

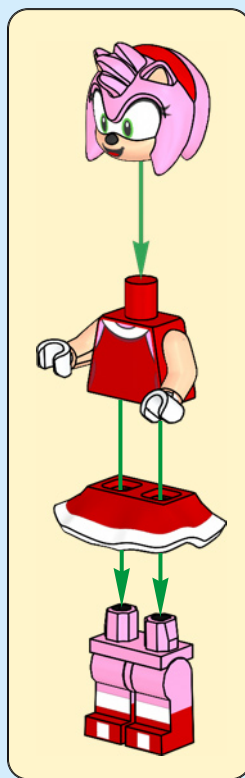

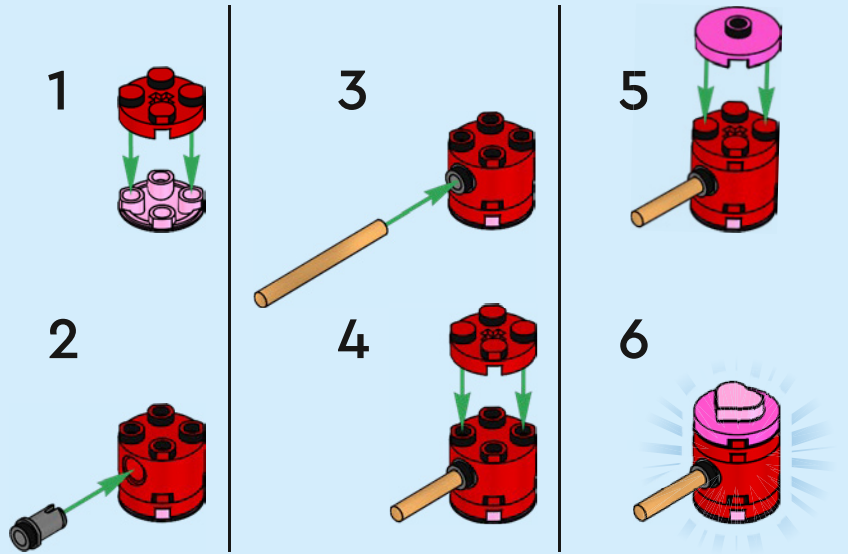

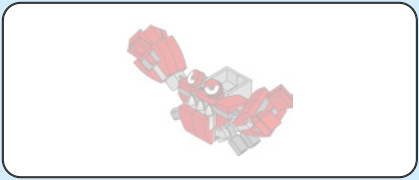

1

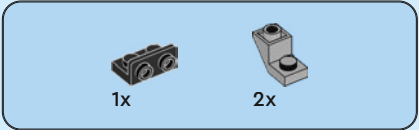

2

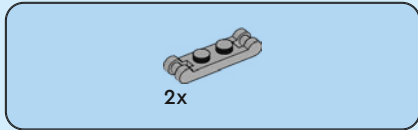
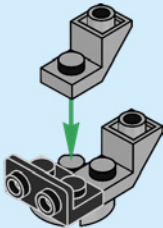

3

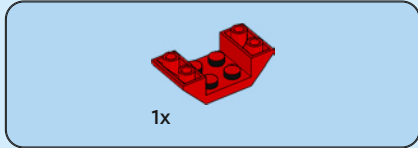
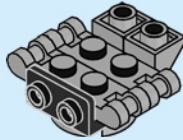

4

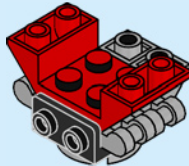

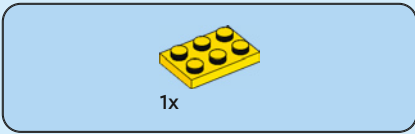

5

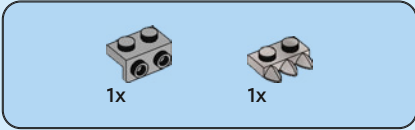
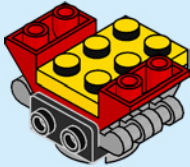

6

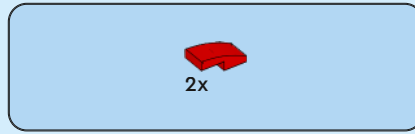
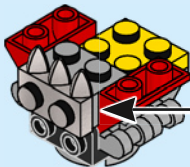
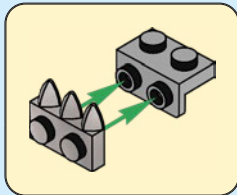

7

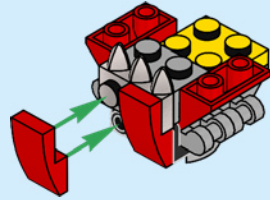

8

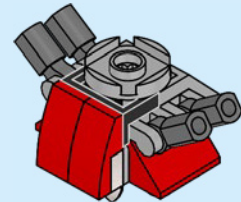



2x

9

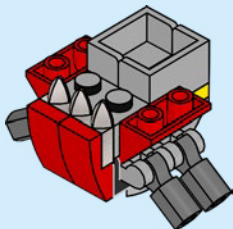

2x

10

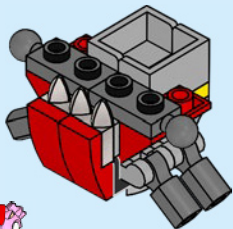

2x



1x

11

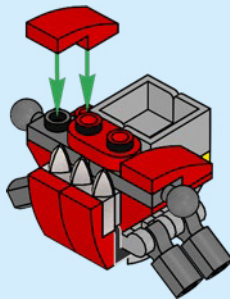

2x



2x

12

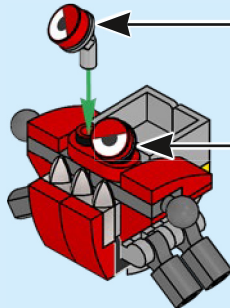

2x

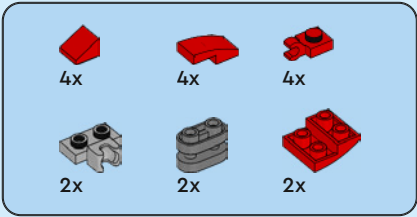

13

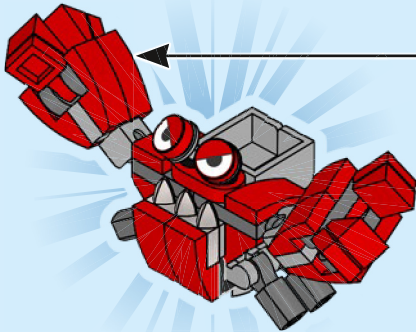
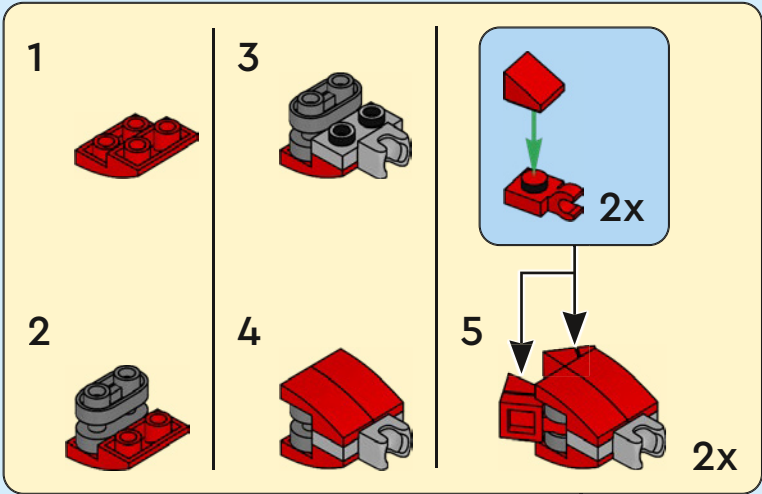

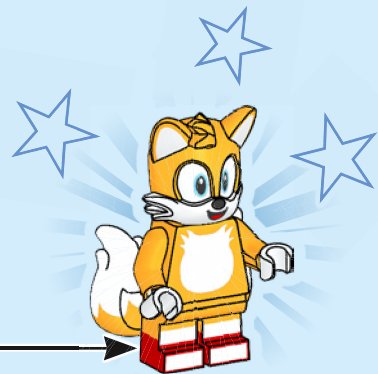
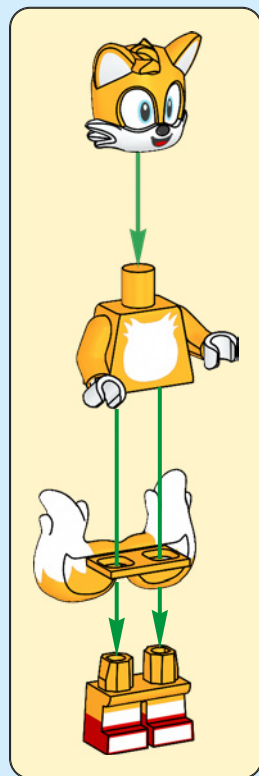

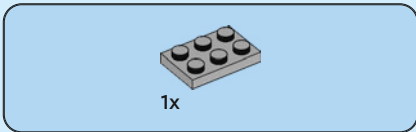

1x

1

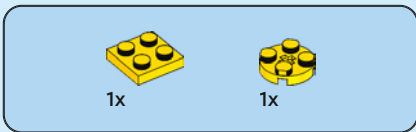
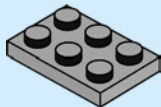

1x

1x

2

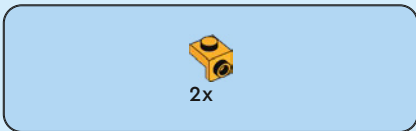
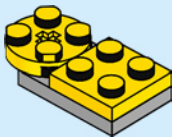

2x

3

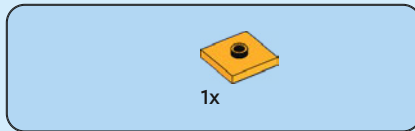
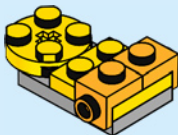

1x

4

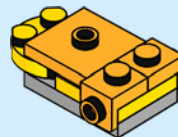

2x

5

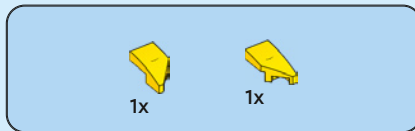
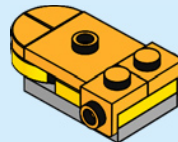

1x

1x

6



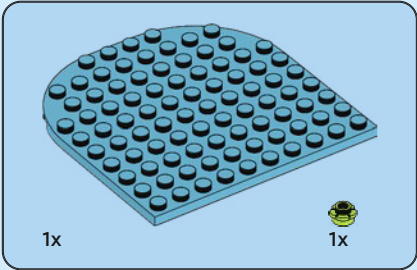
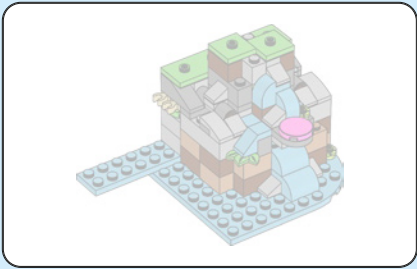

1

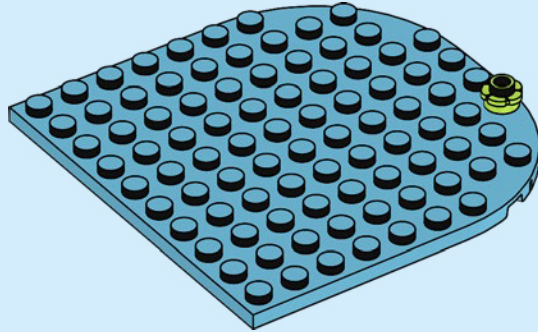



1x



1x

2

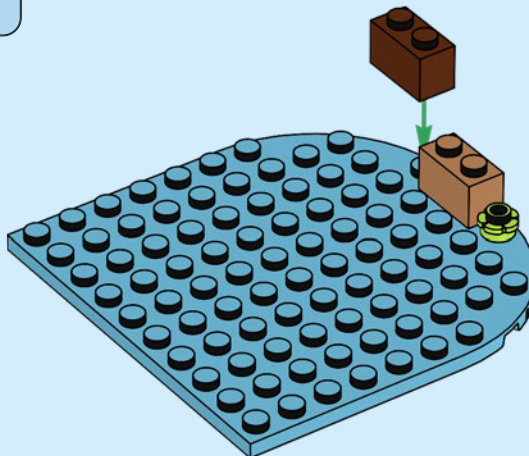

1x



1x

3

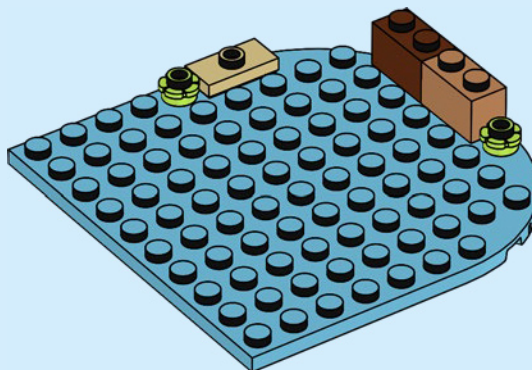

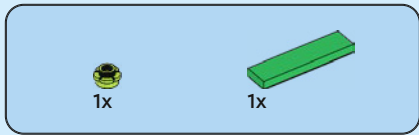

4

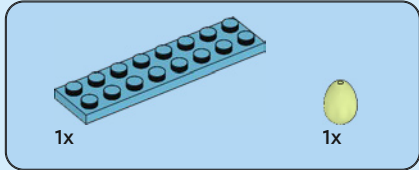
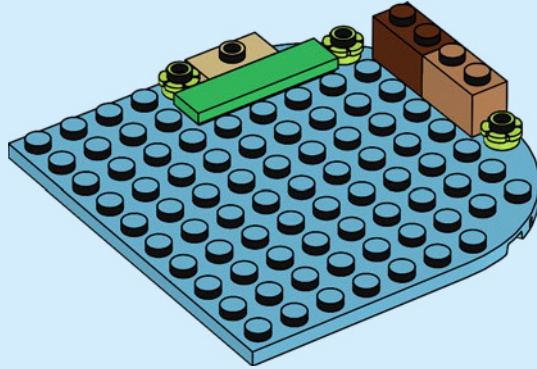

5

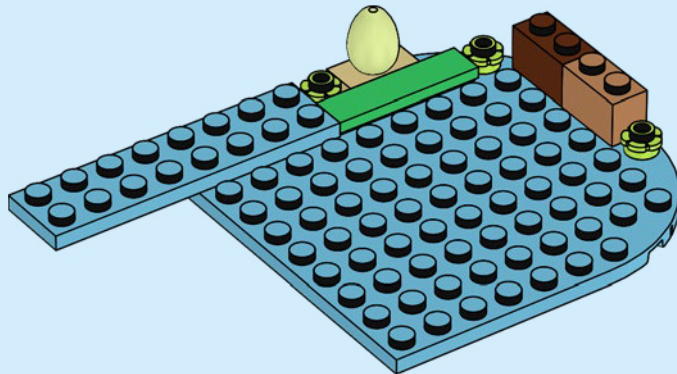

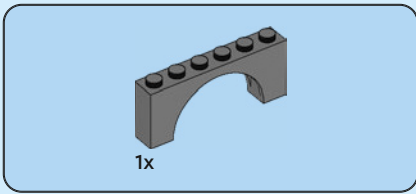

6

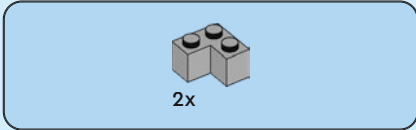
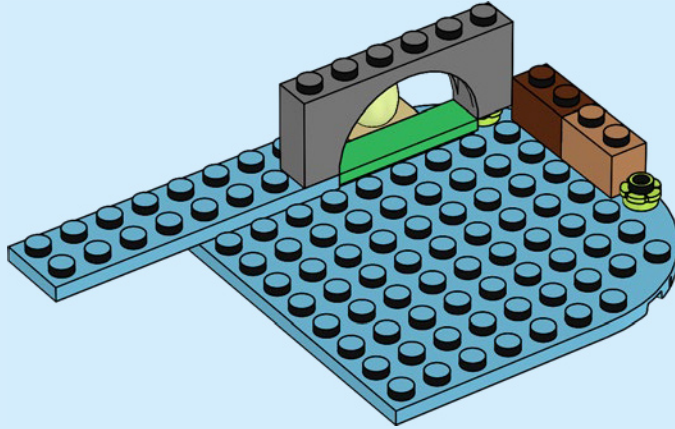

7

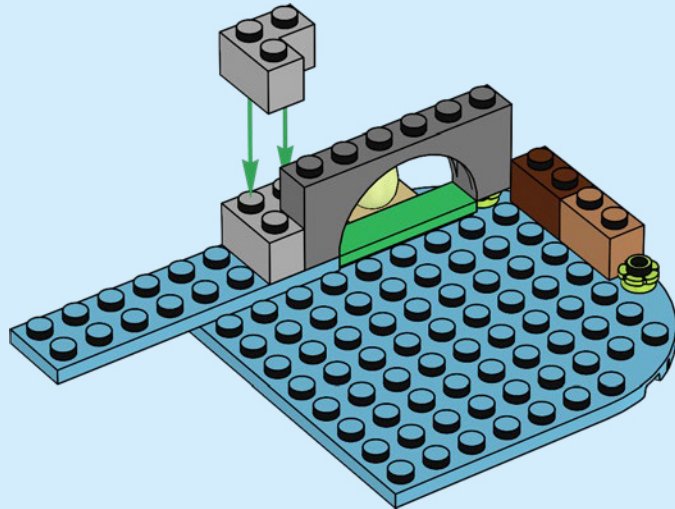

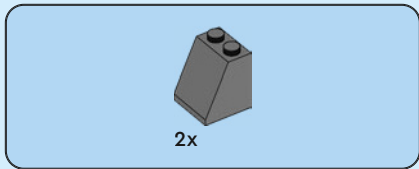

8

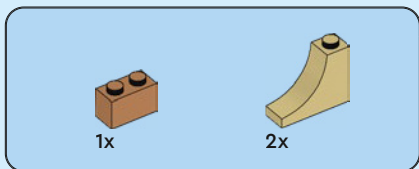
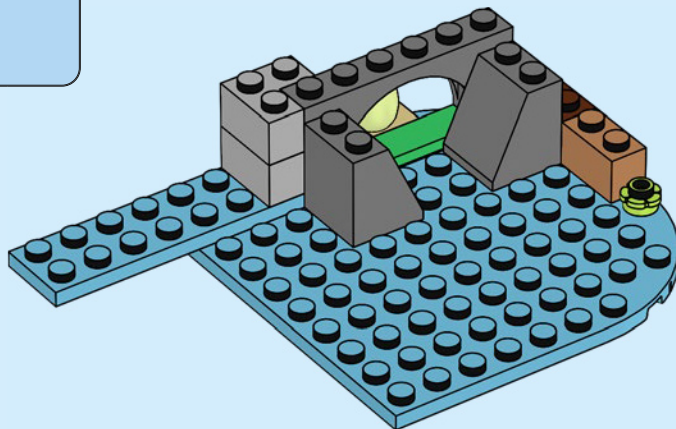

9

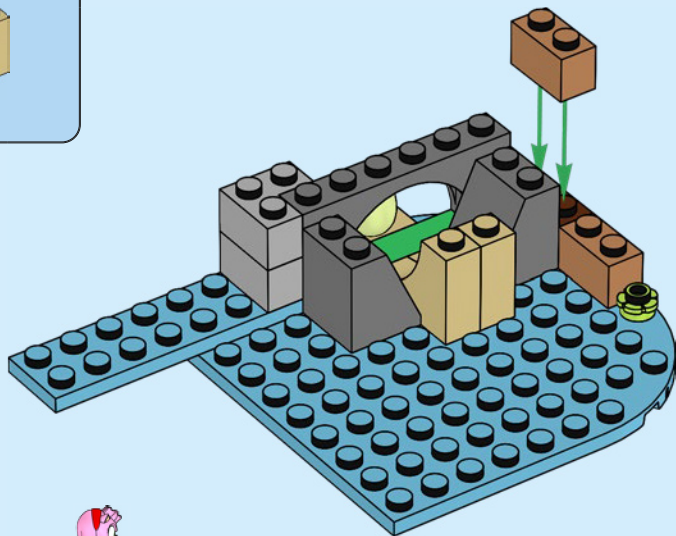

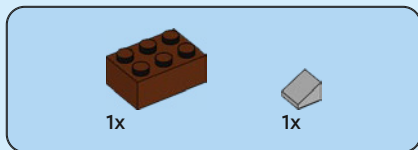

10

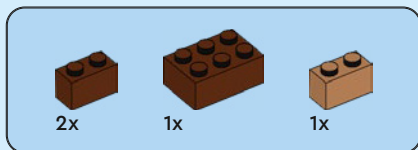
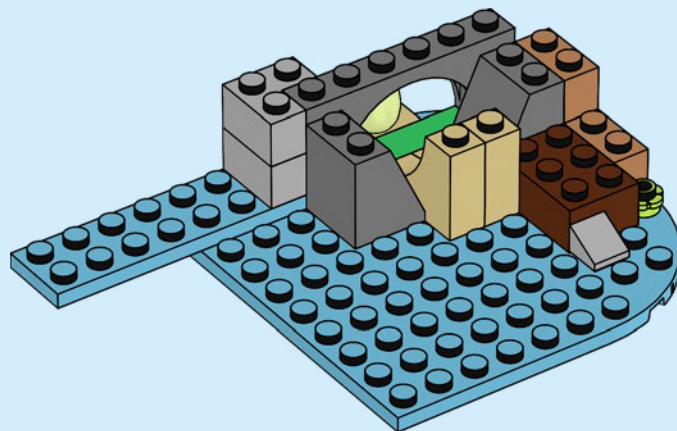

11

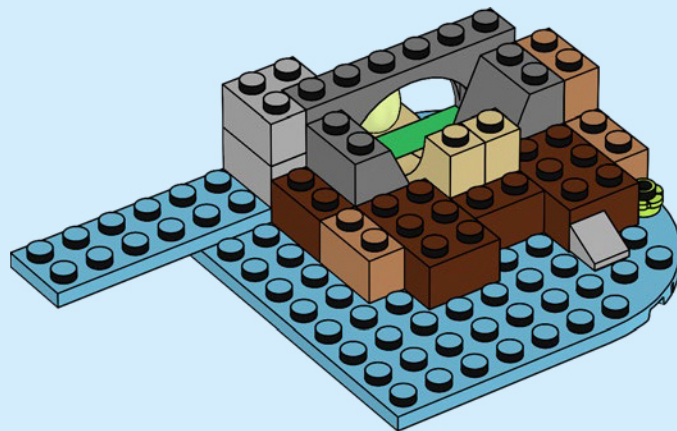

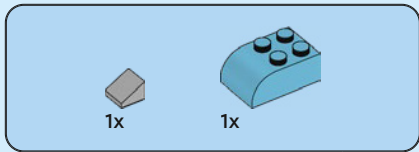

12

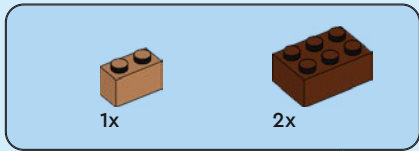
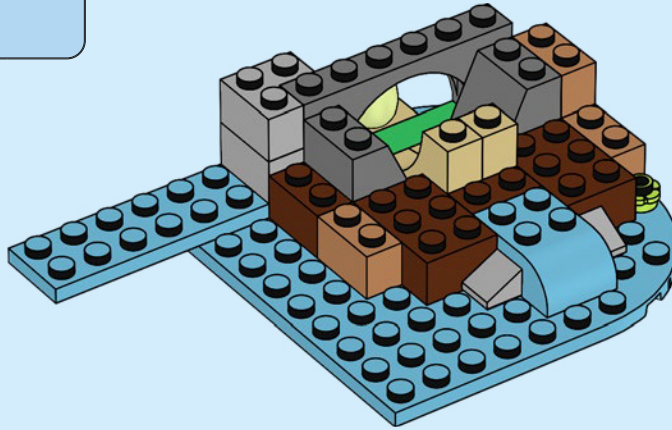

13

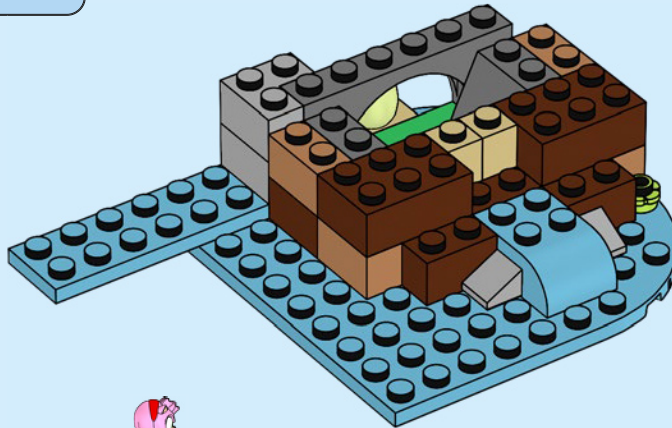

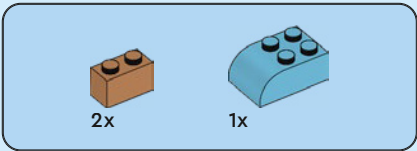

14

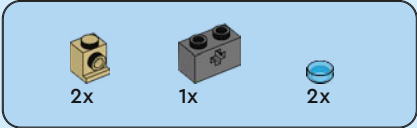
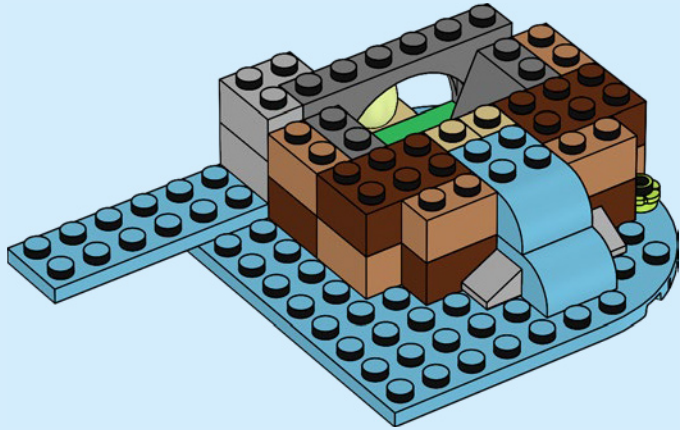

15

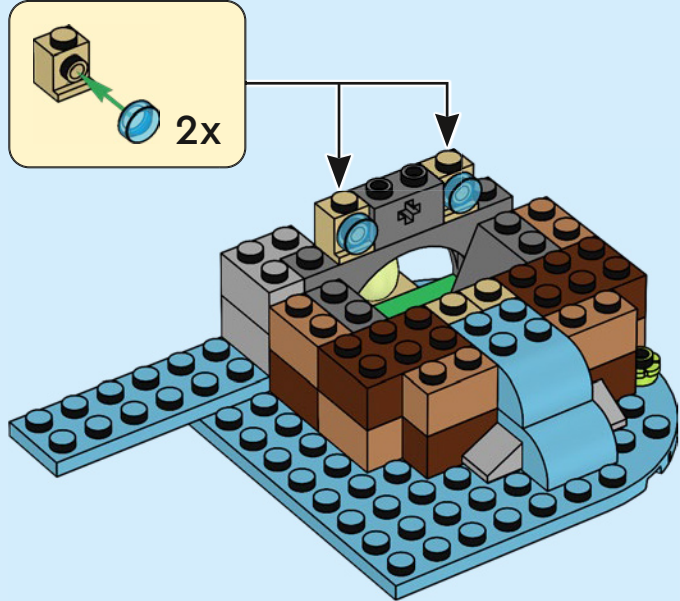



2x



1x

16

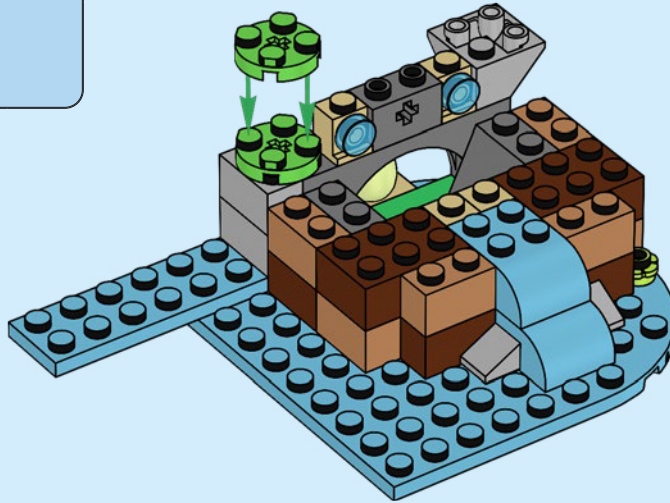

2x

17



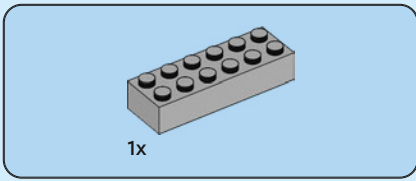

18

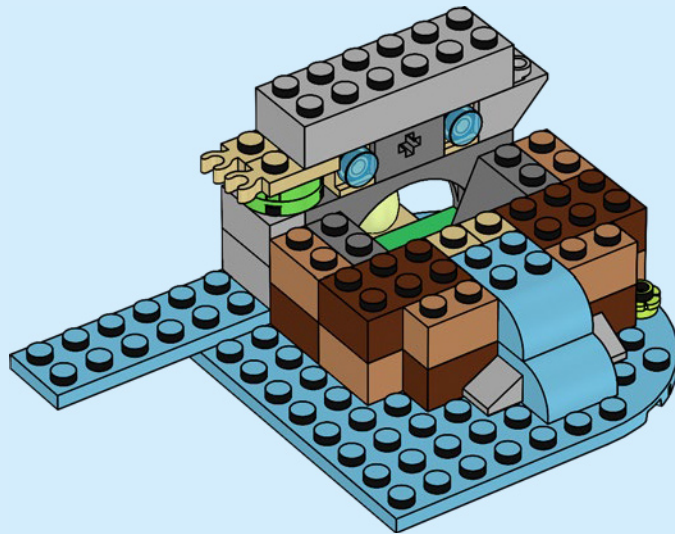

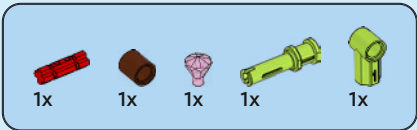

19

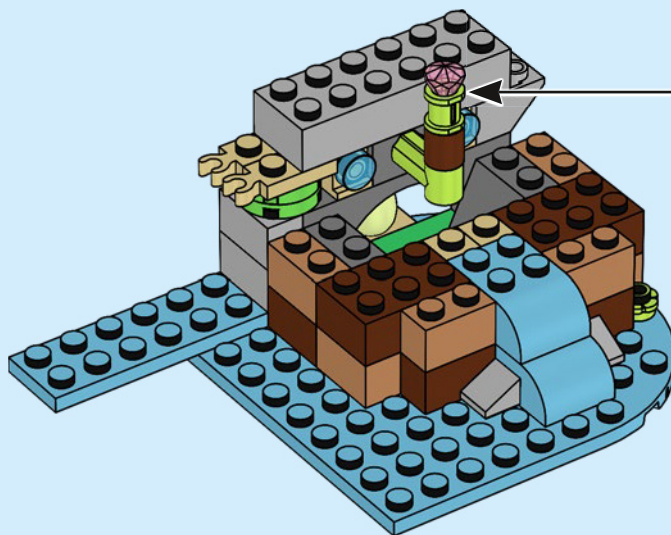
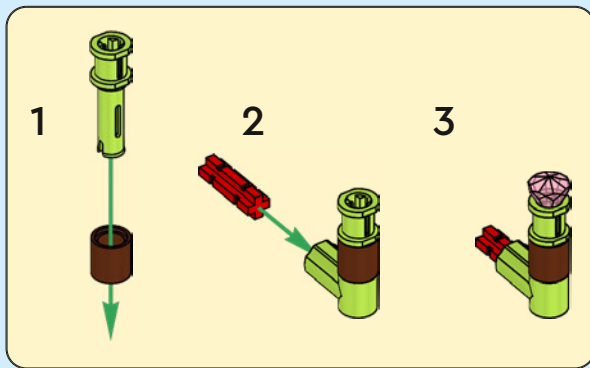

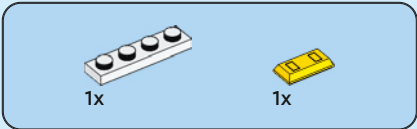

20

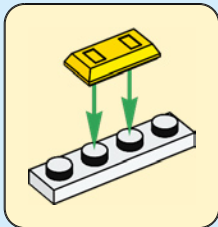

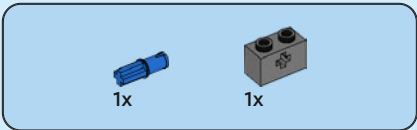

21

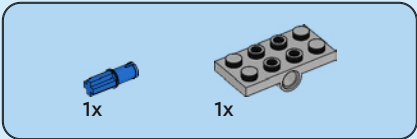
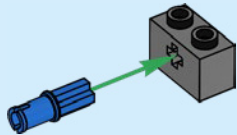

22

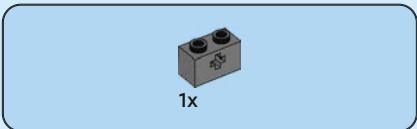
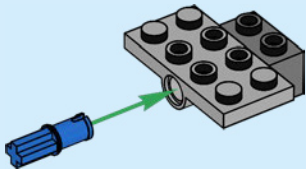

23

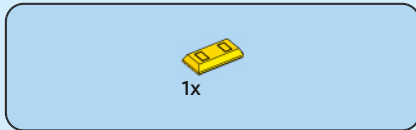
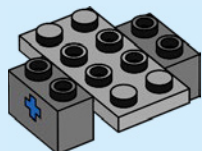

24

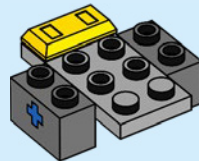

25

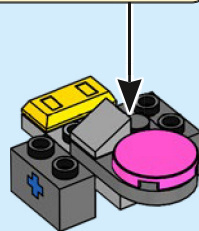

26

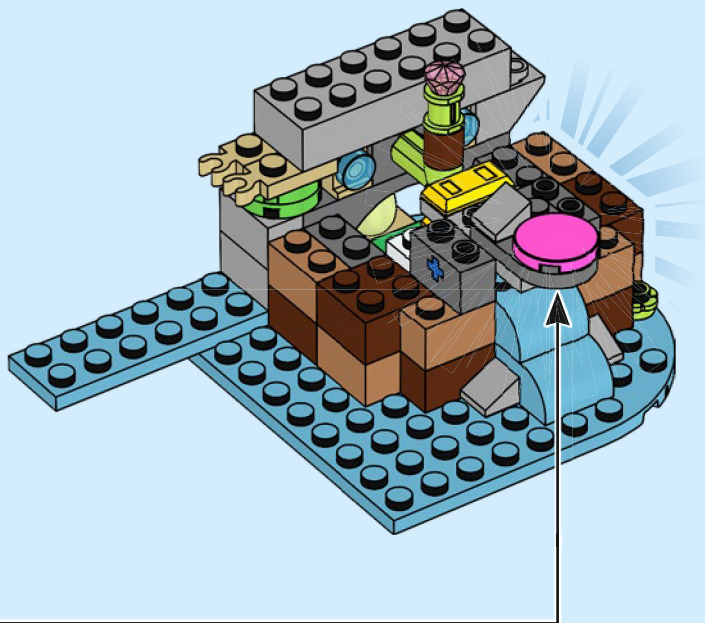



2x

27

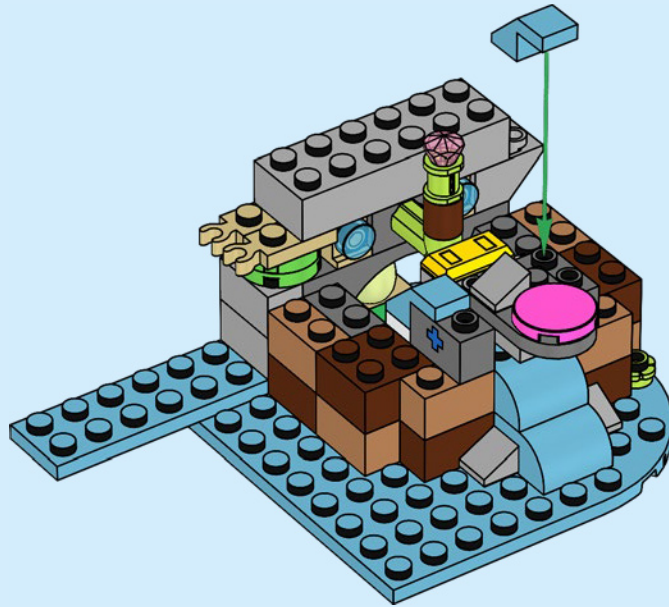

2x

28

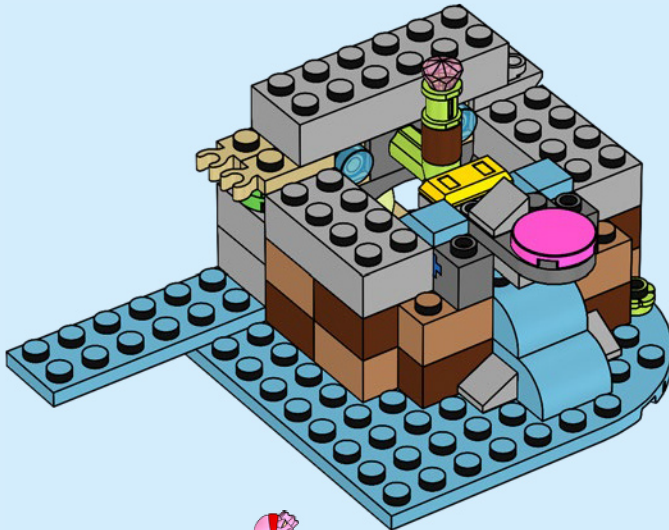



4x

29



2x

30

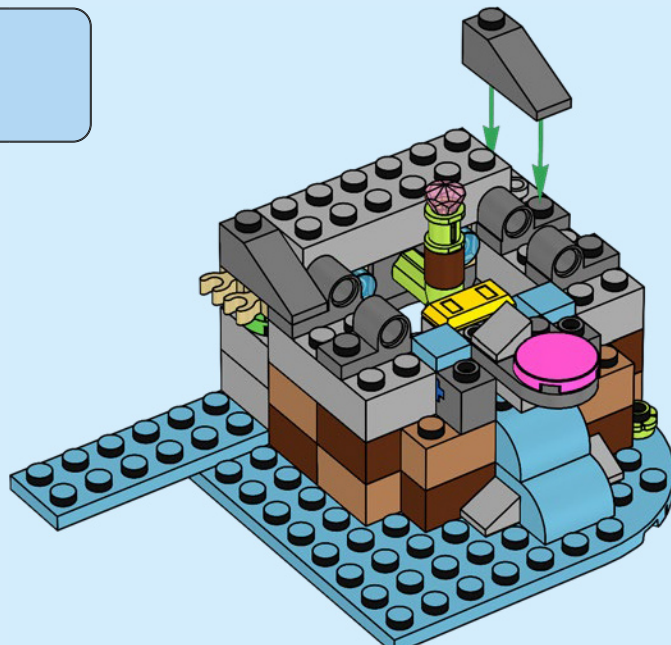

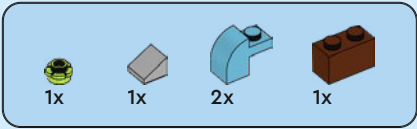

31

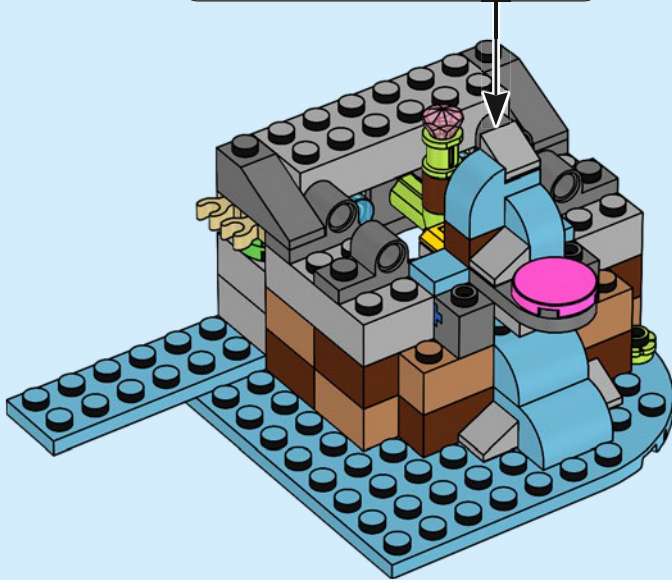
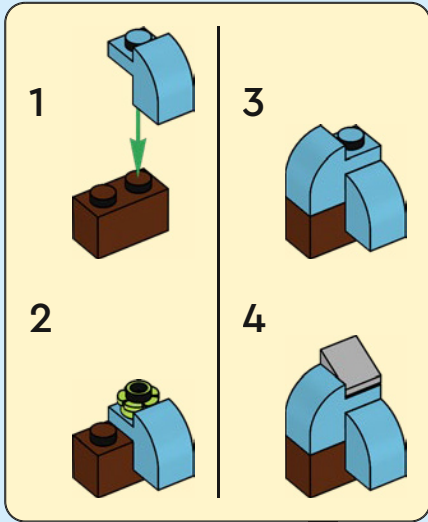

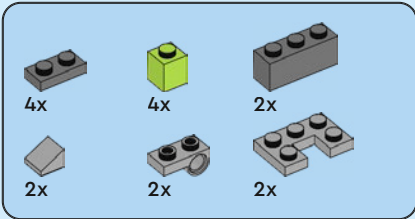

32

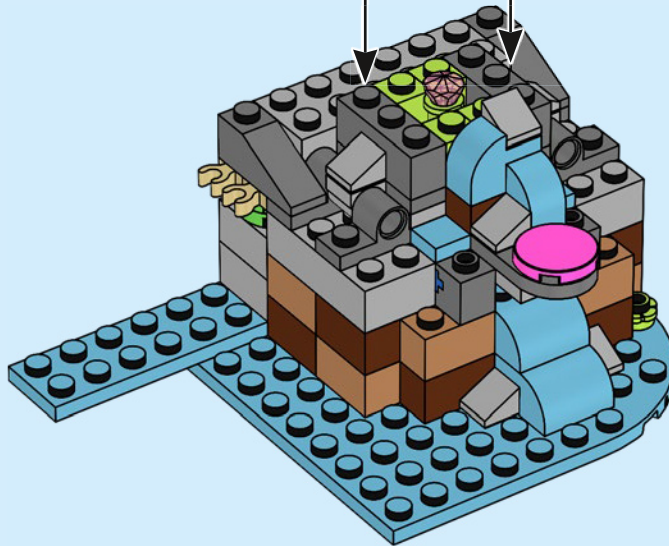
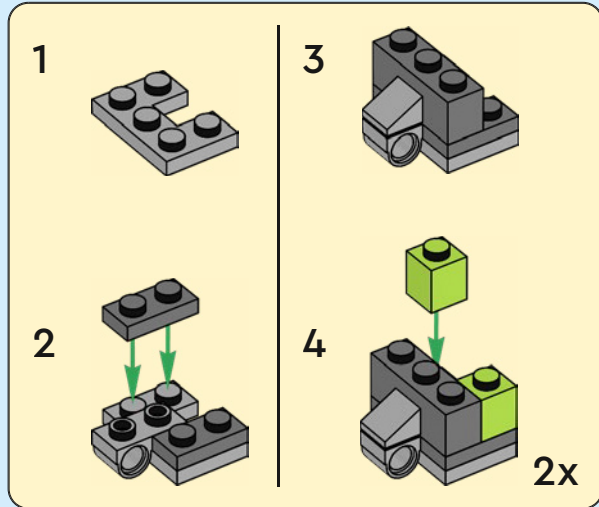

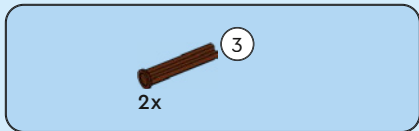

33

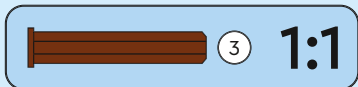
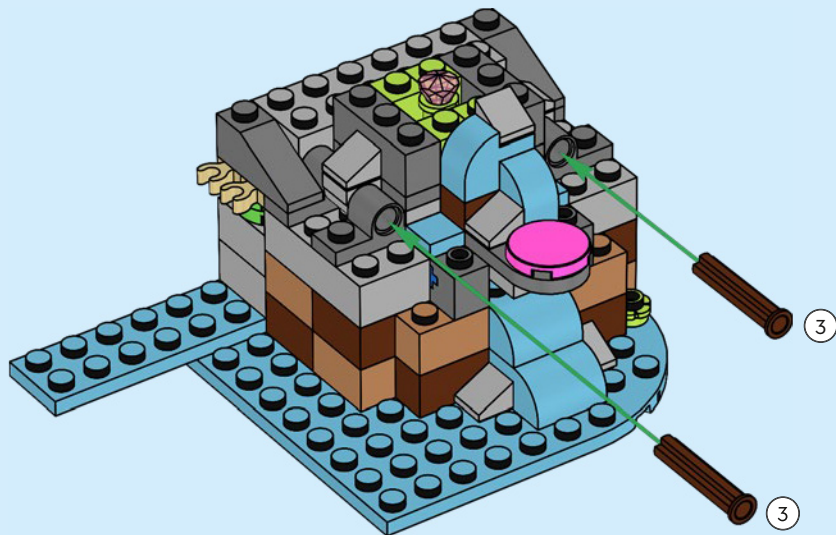



2x

34

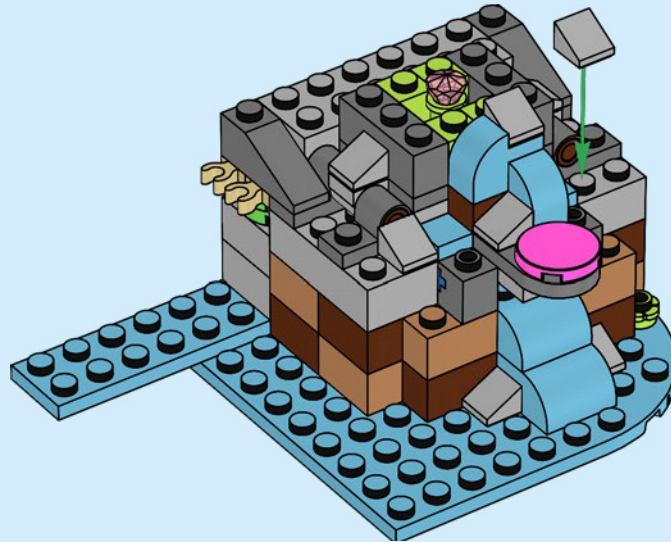



1x



1x

35



2x



1x

36





2x

37

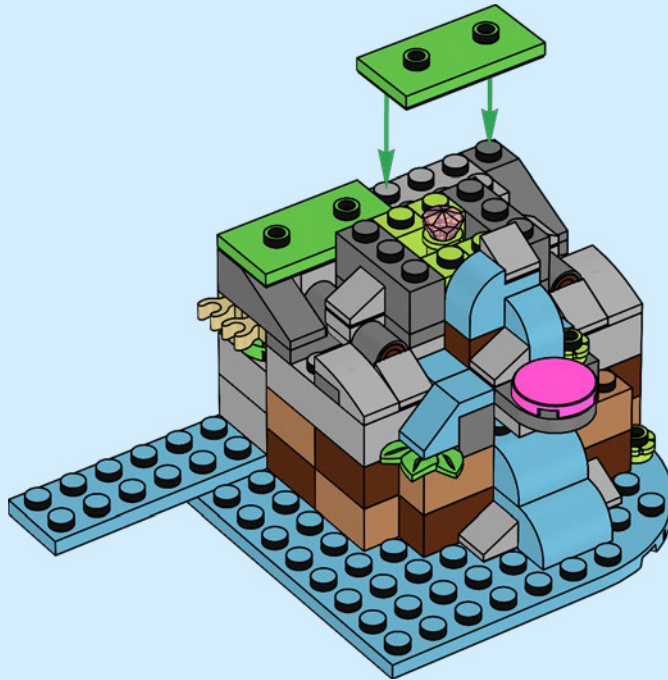

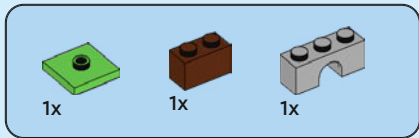

38

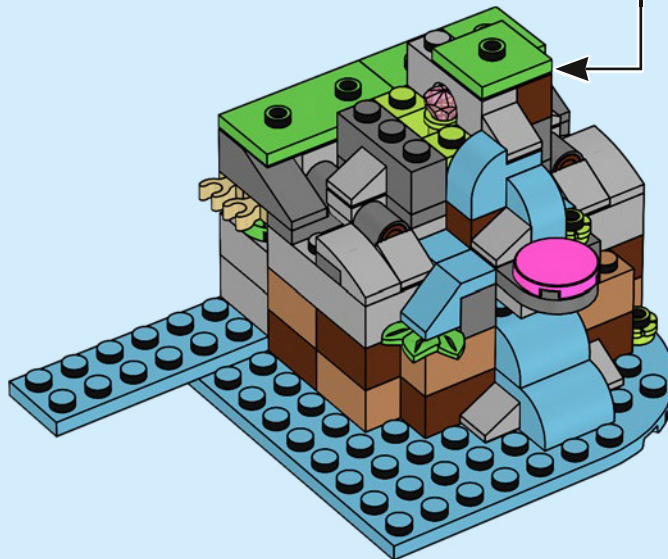
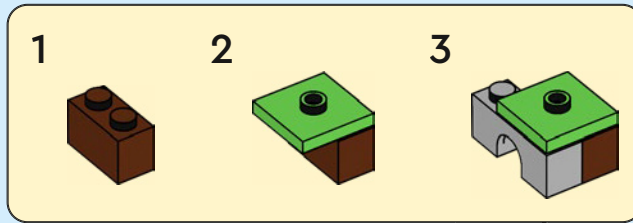

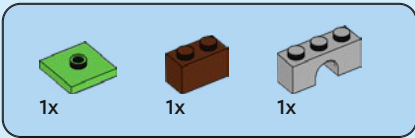

39

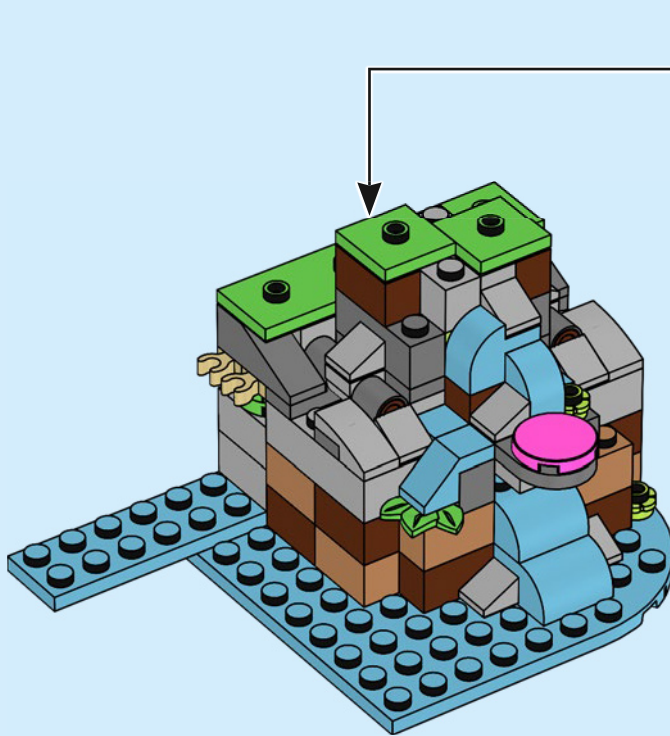
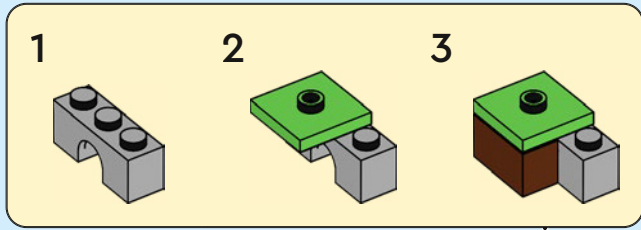

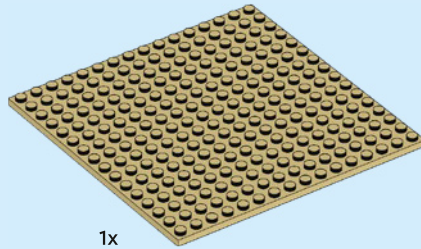
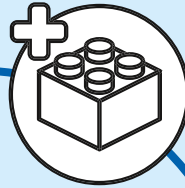

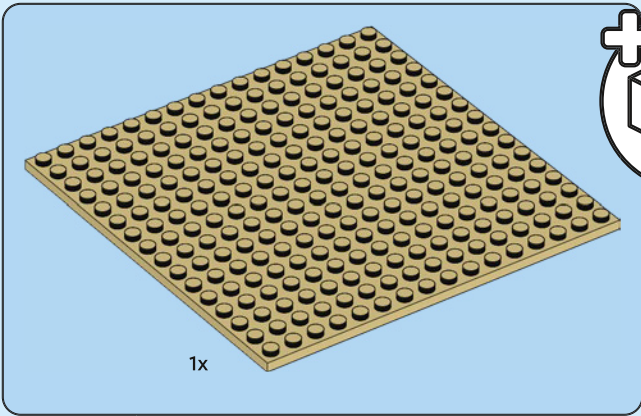

40

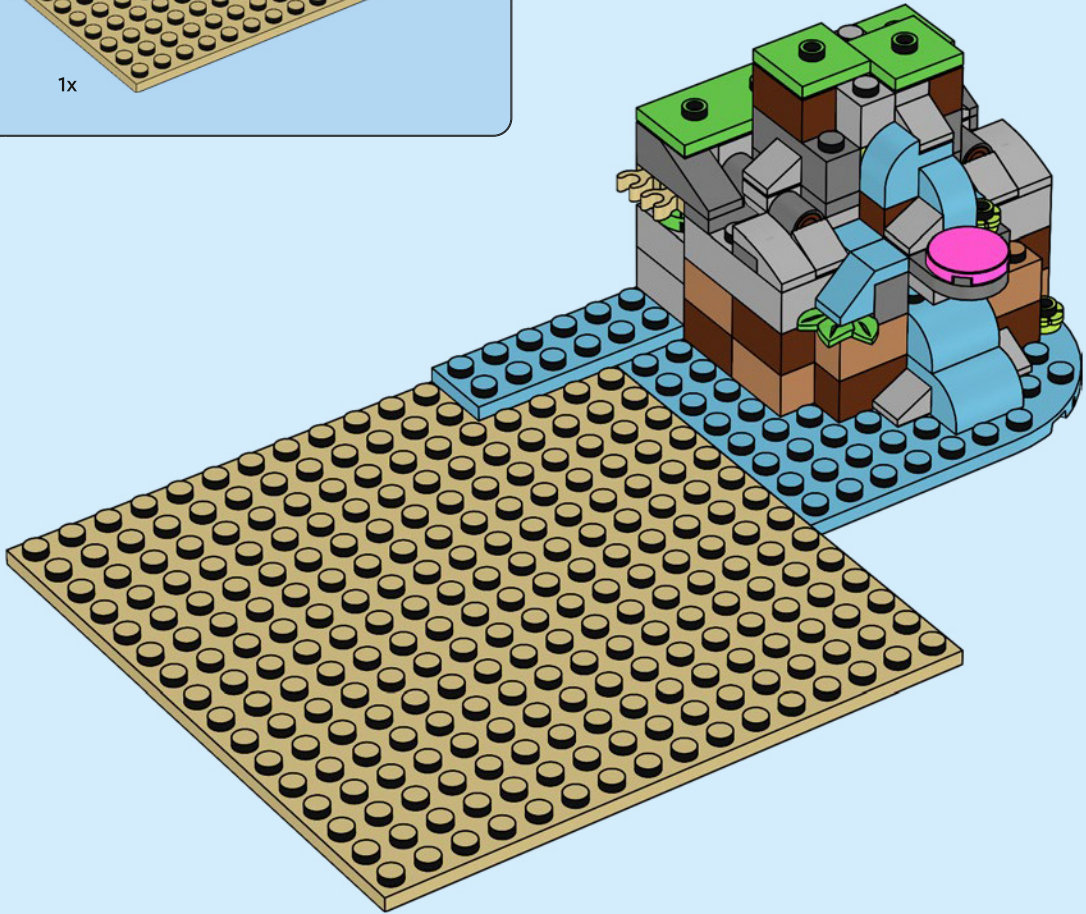

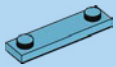

3x

41

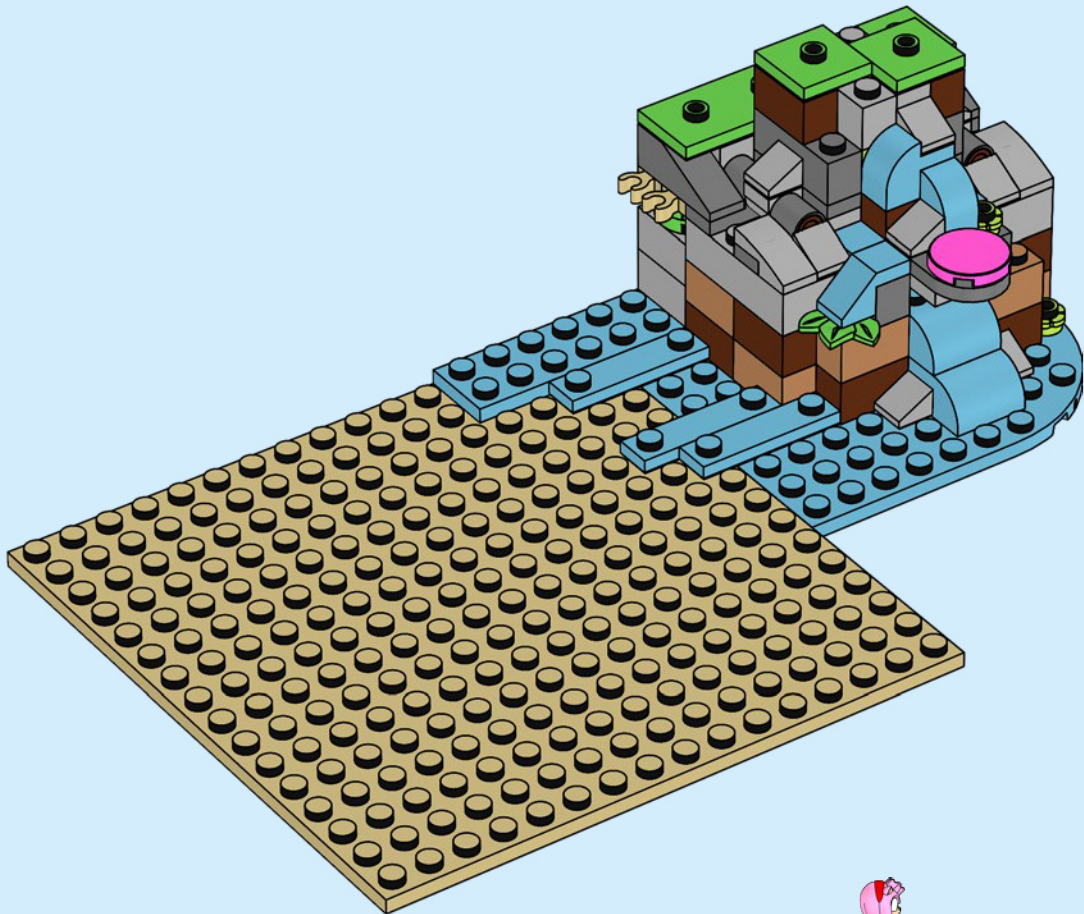

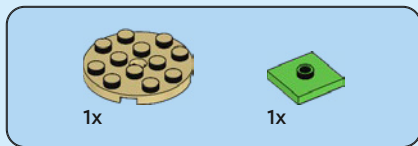

42

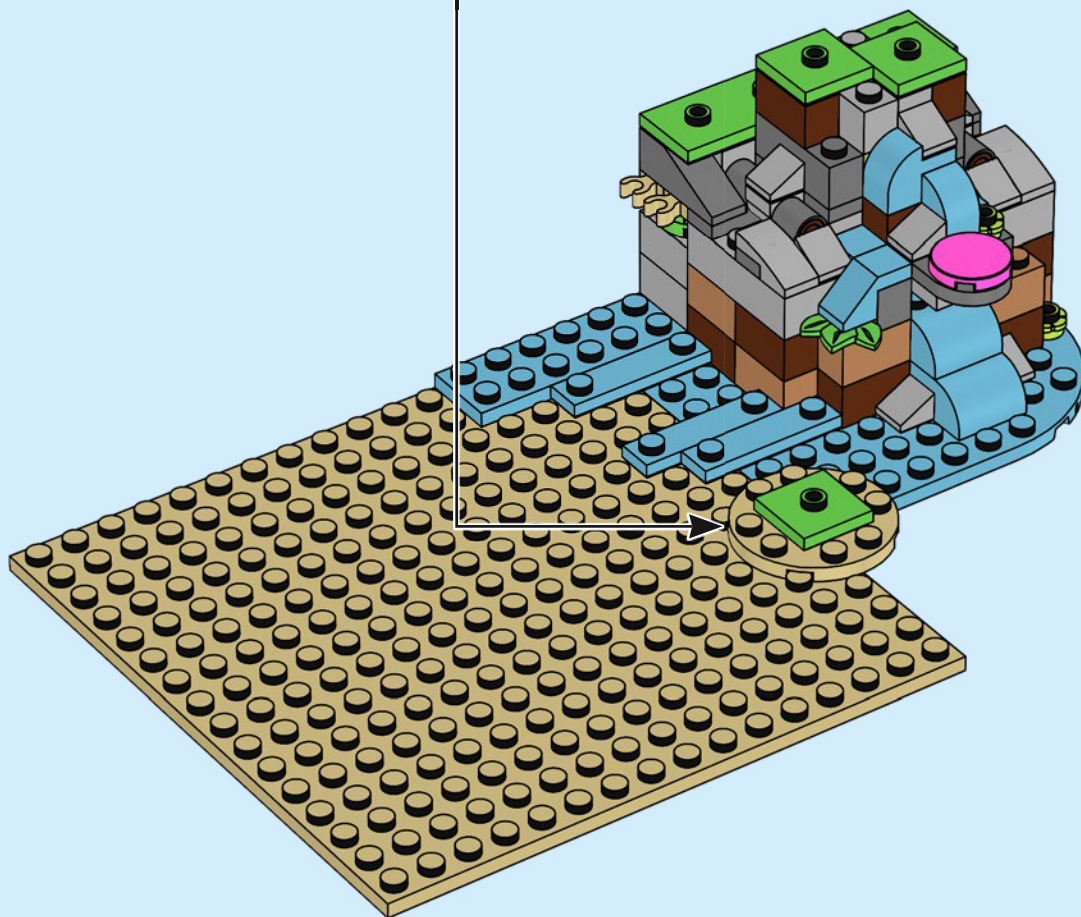
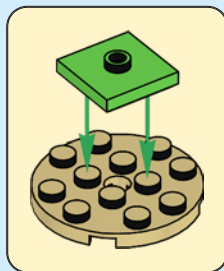

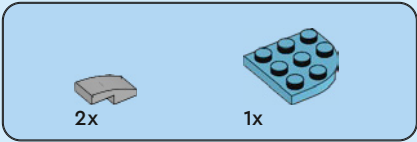

43

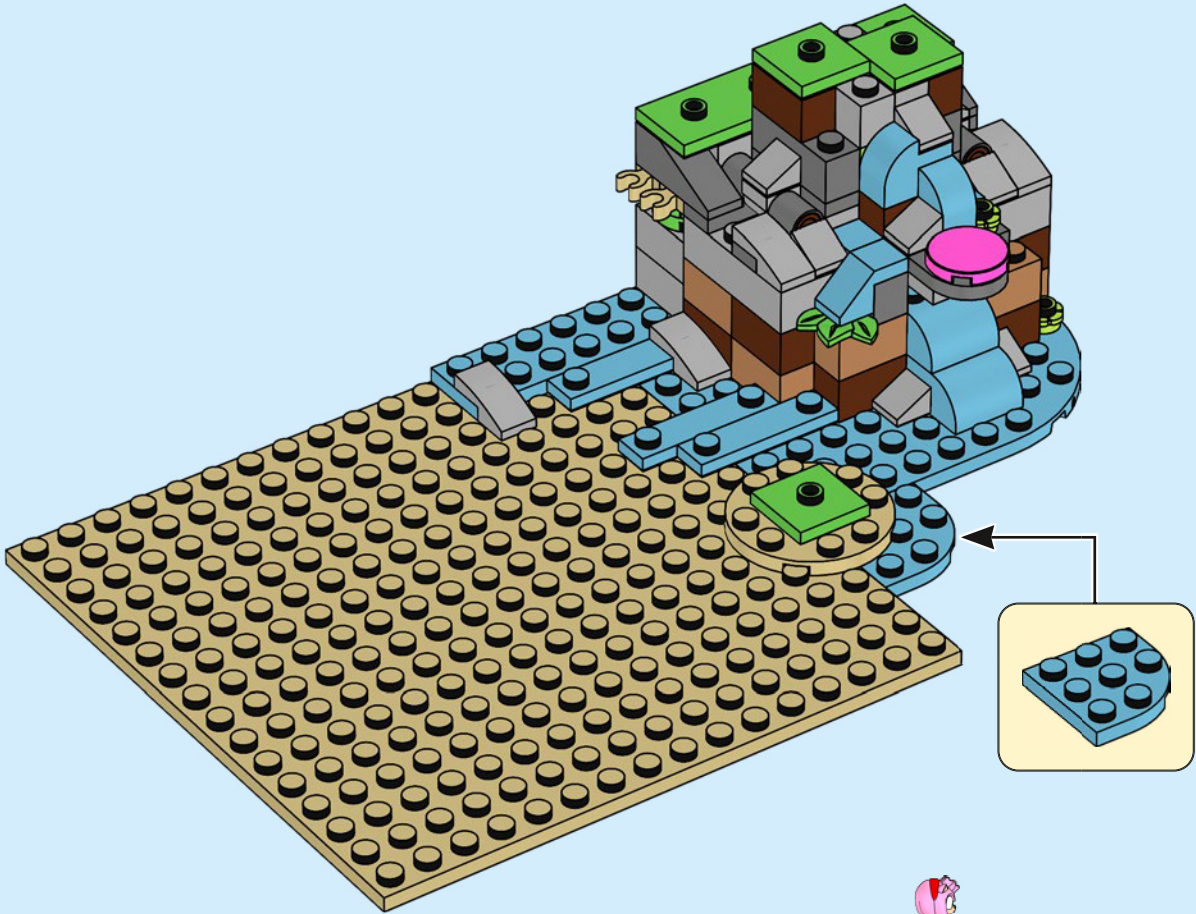

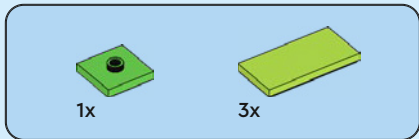

45

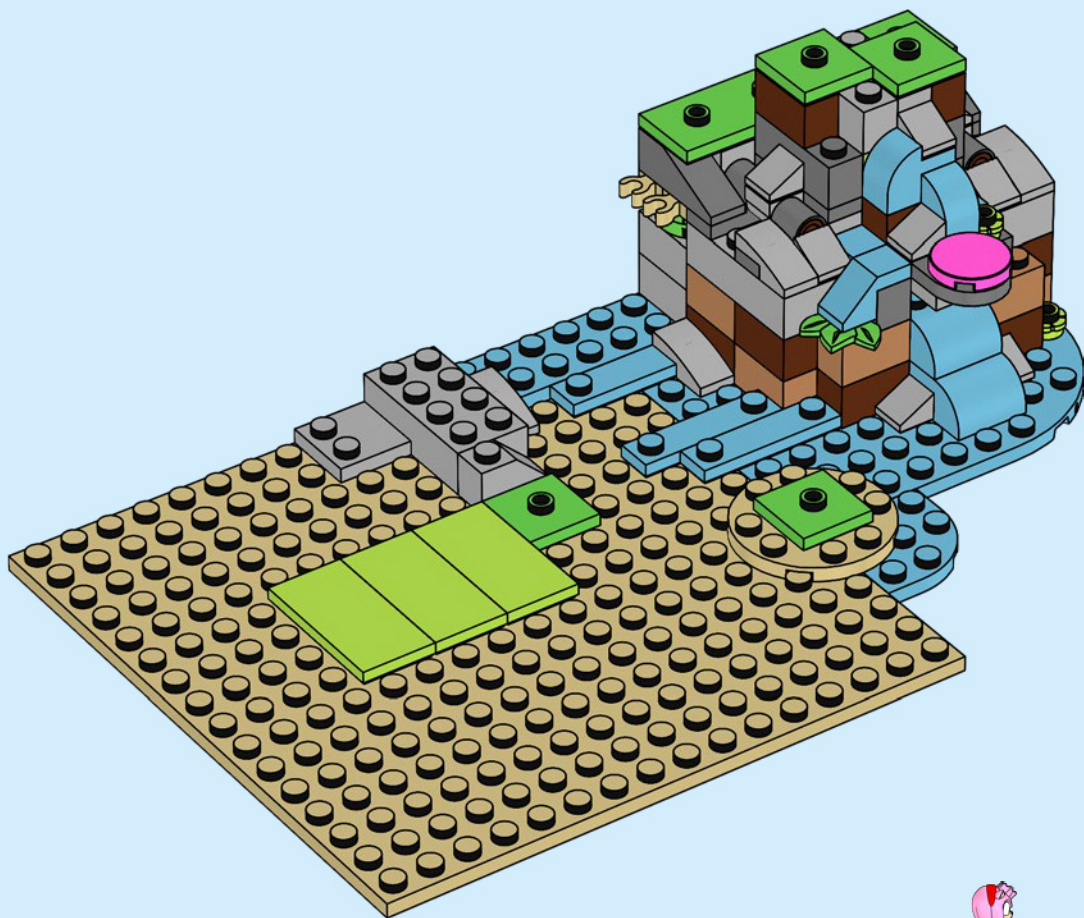

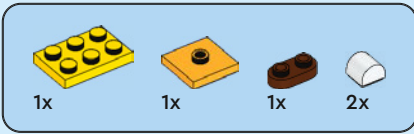

46

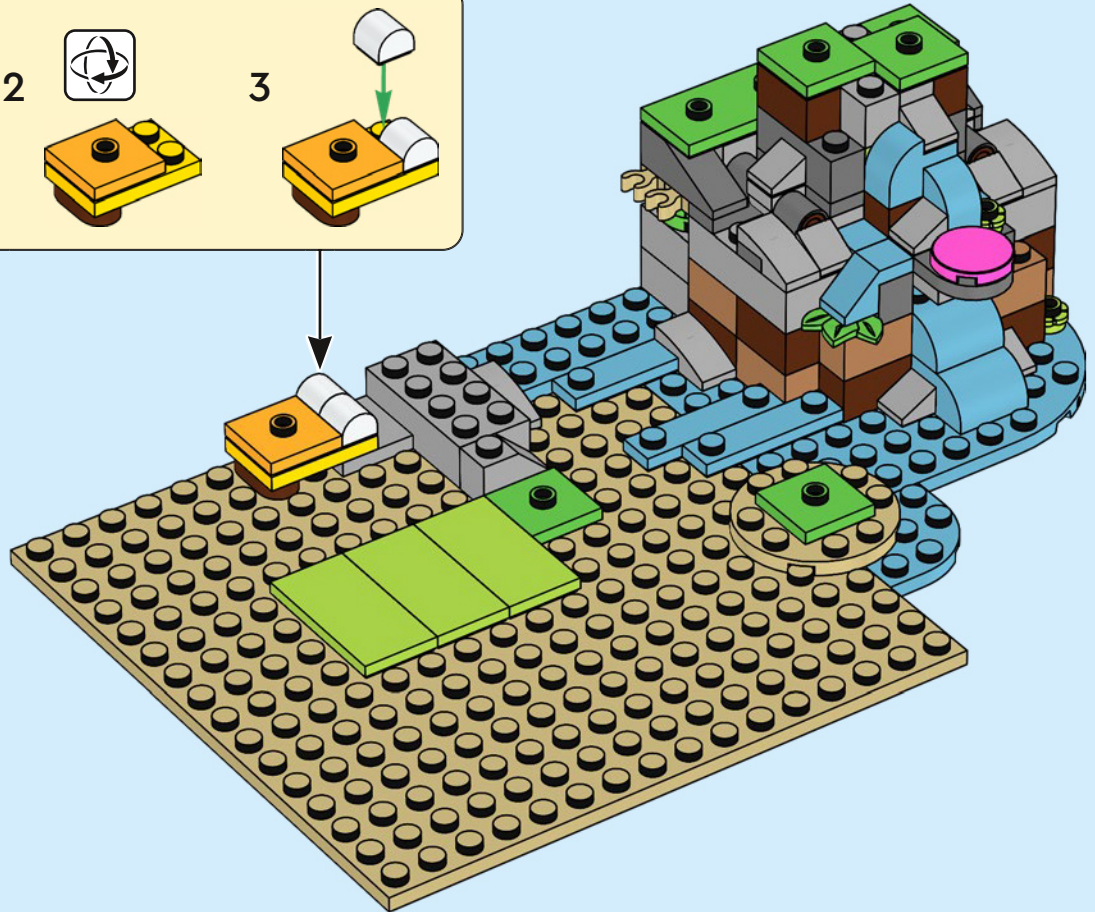
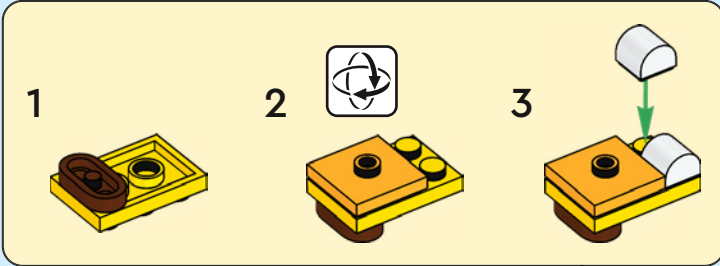

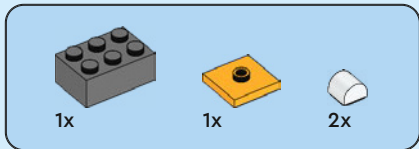

47

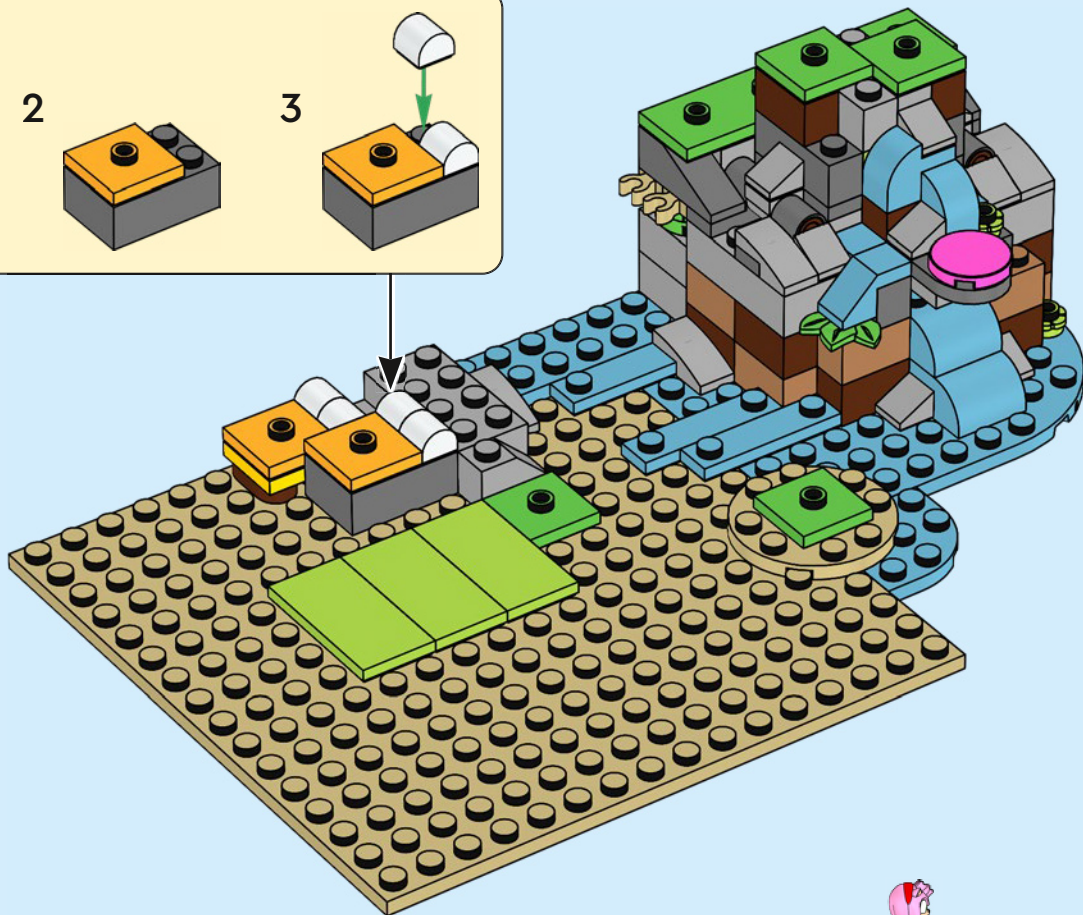
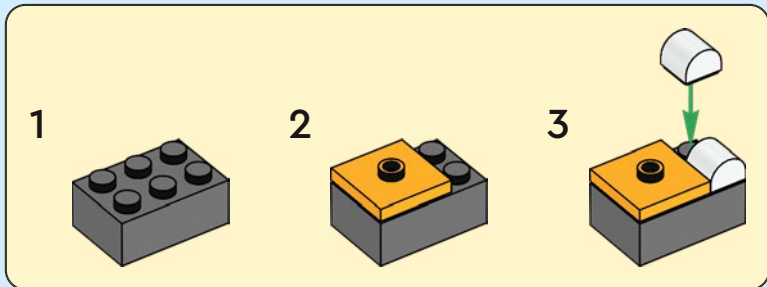



1x



1x

48

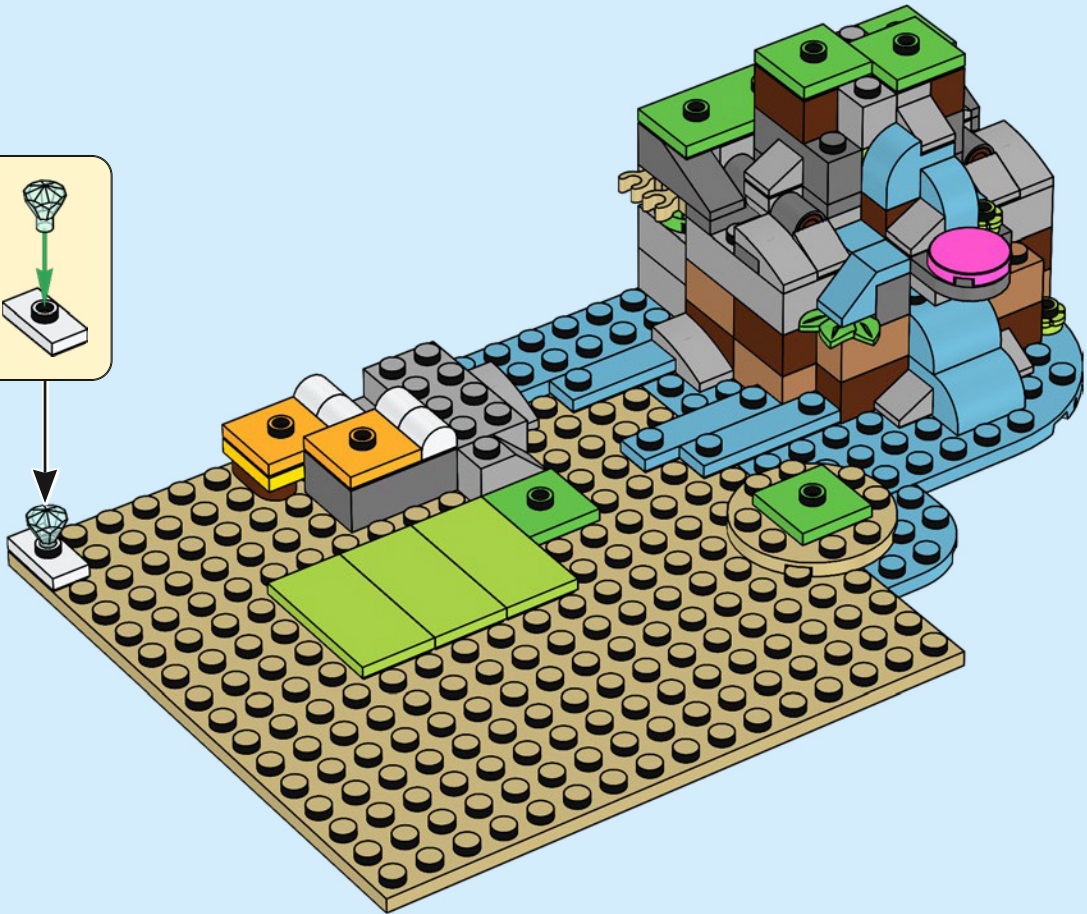
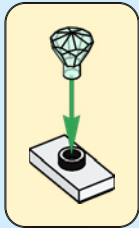

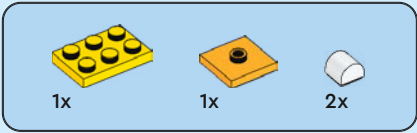

49

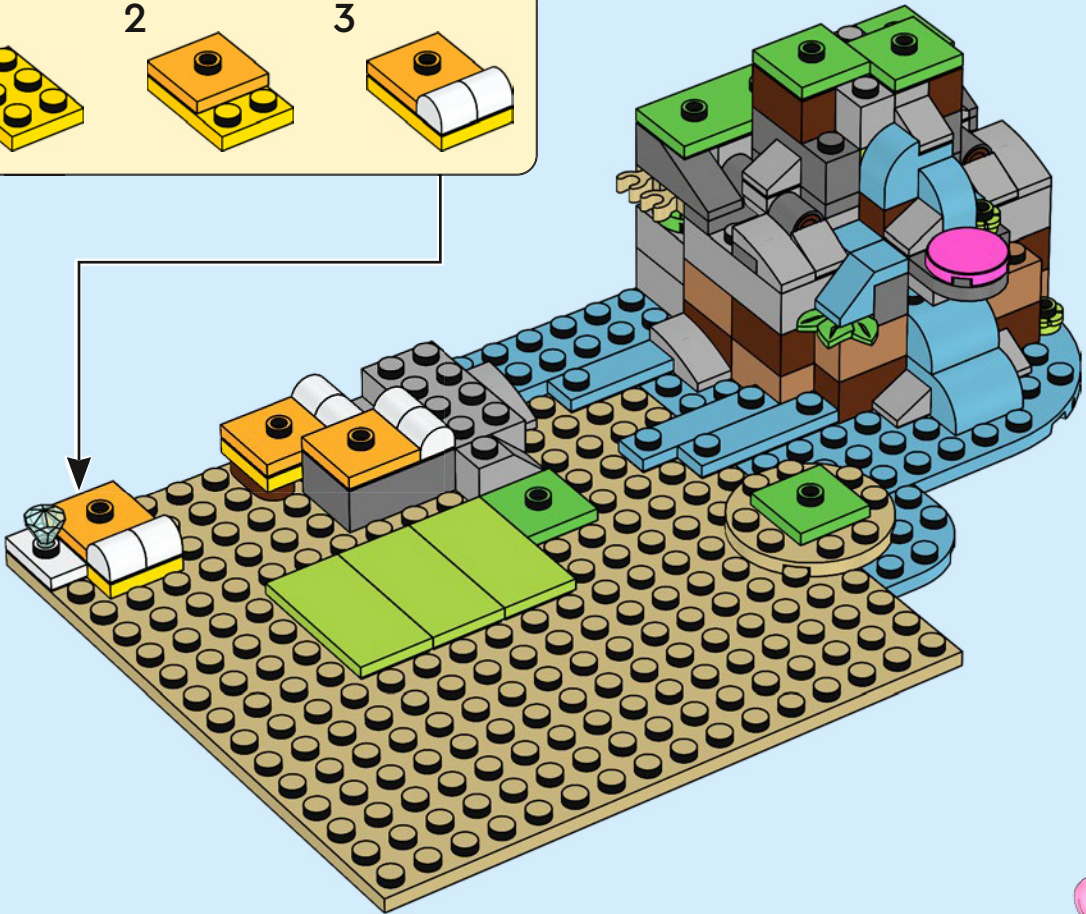
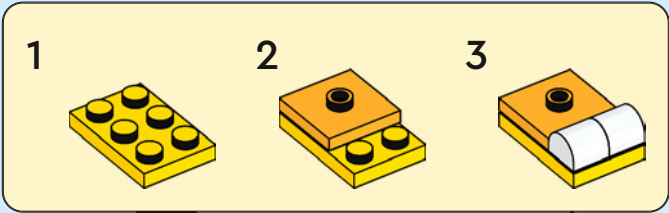



1x



1x

50

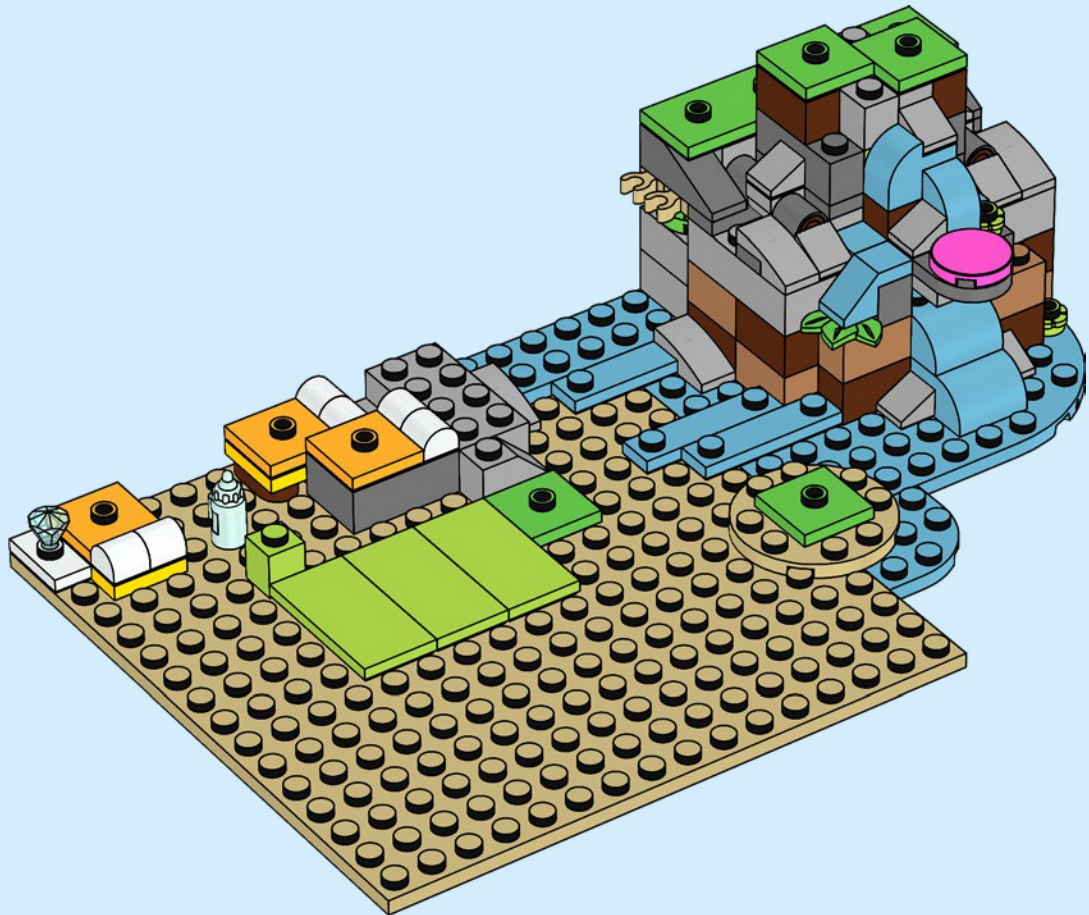



2x

51

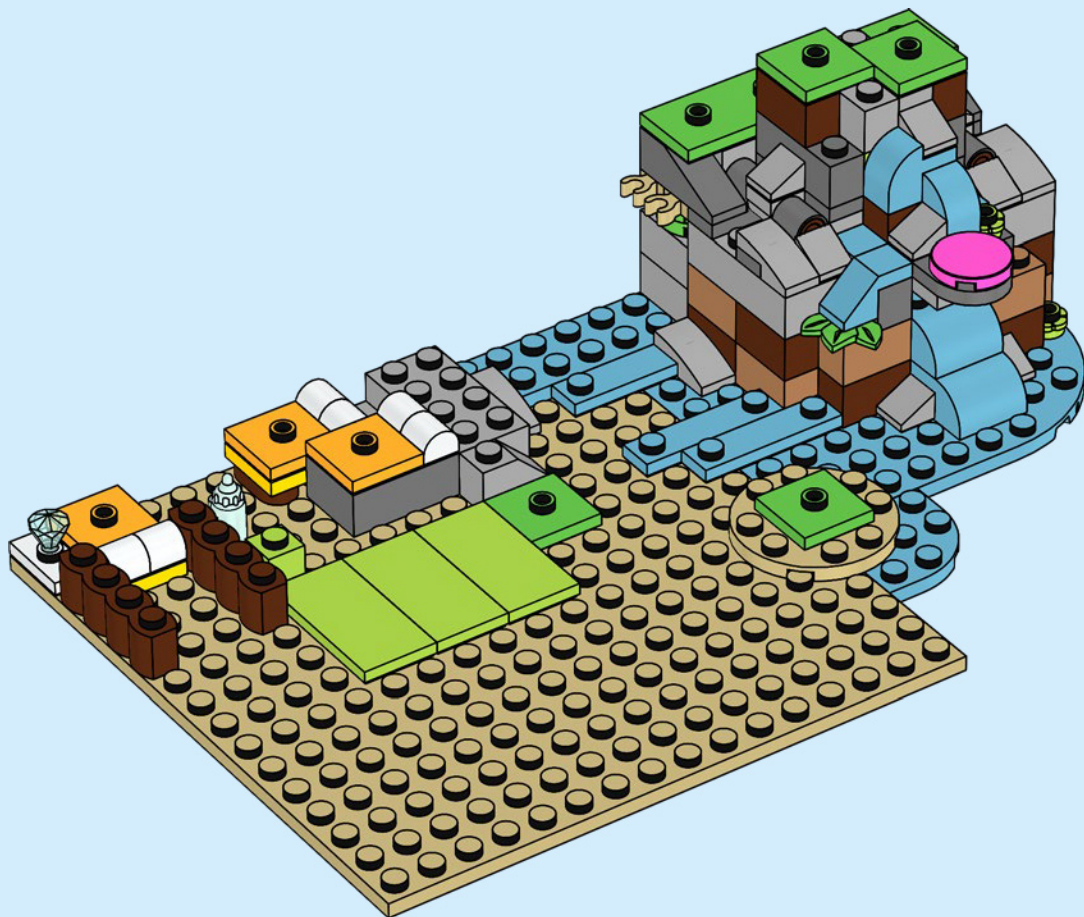

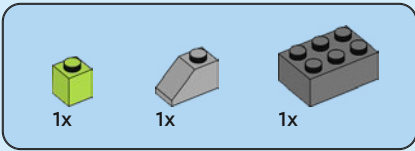

52

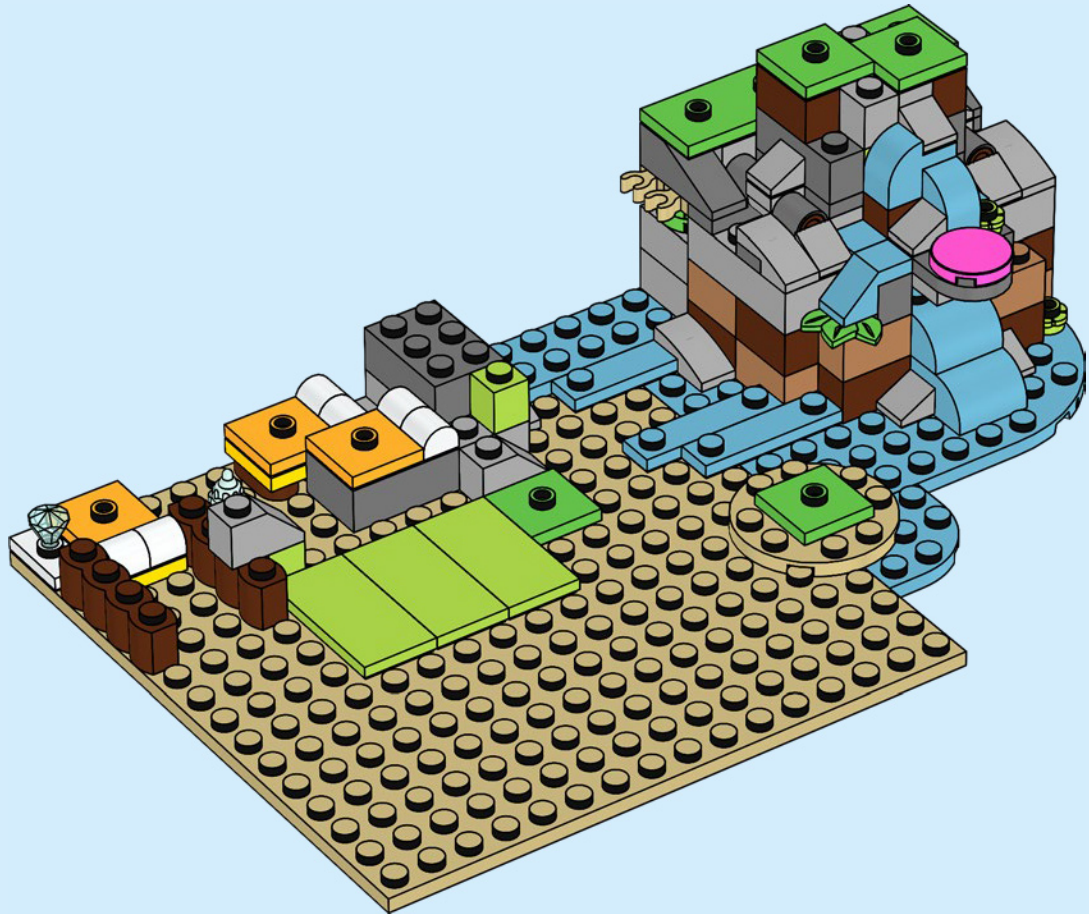

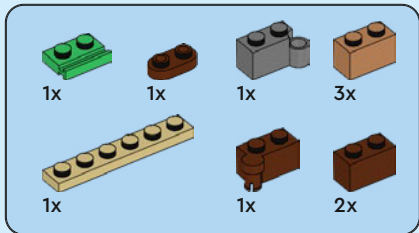

53

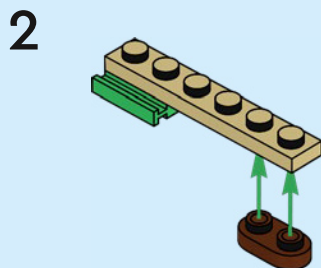
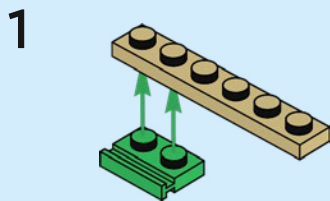

3

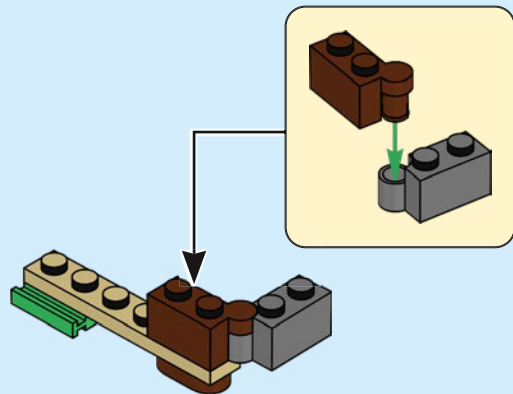

4

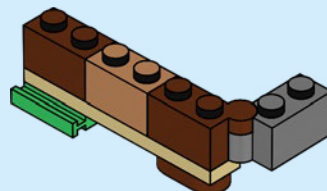

5

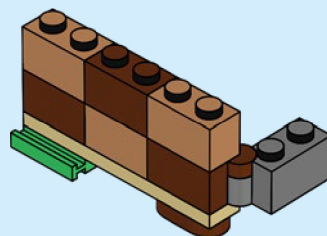

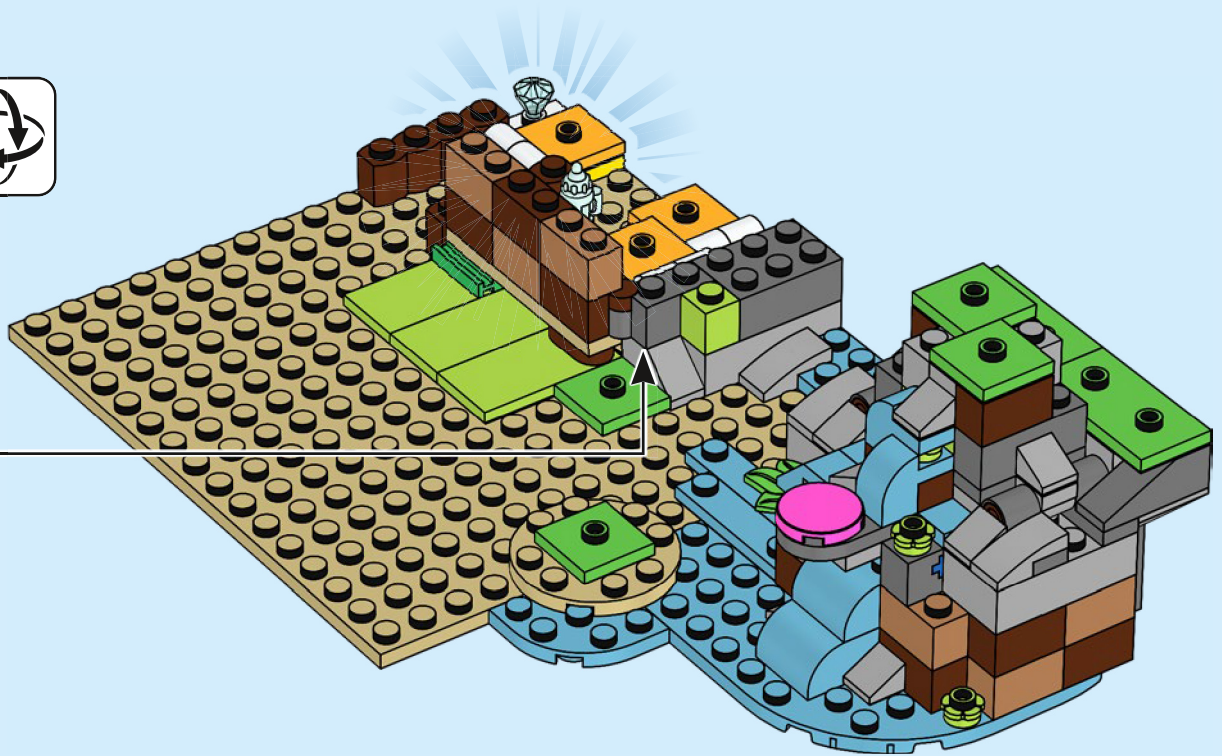

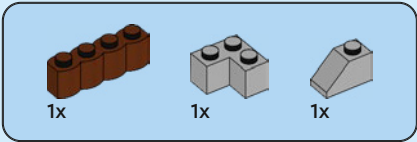

54

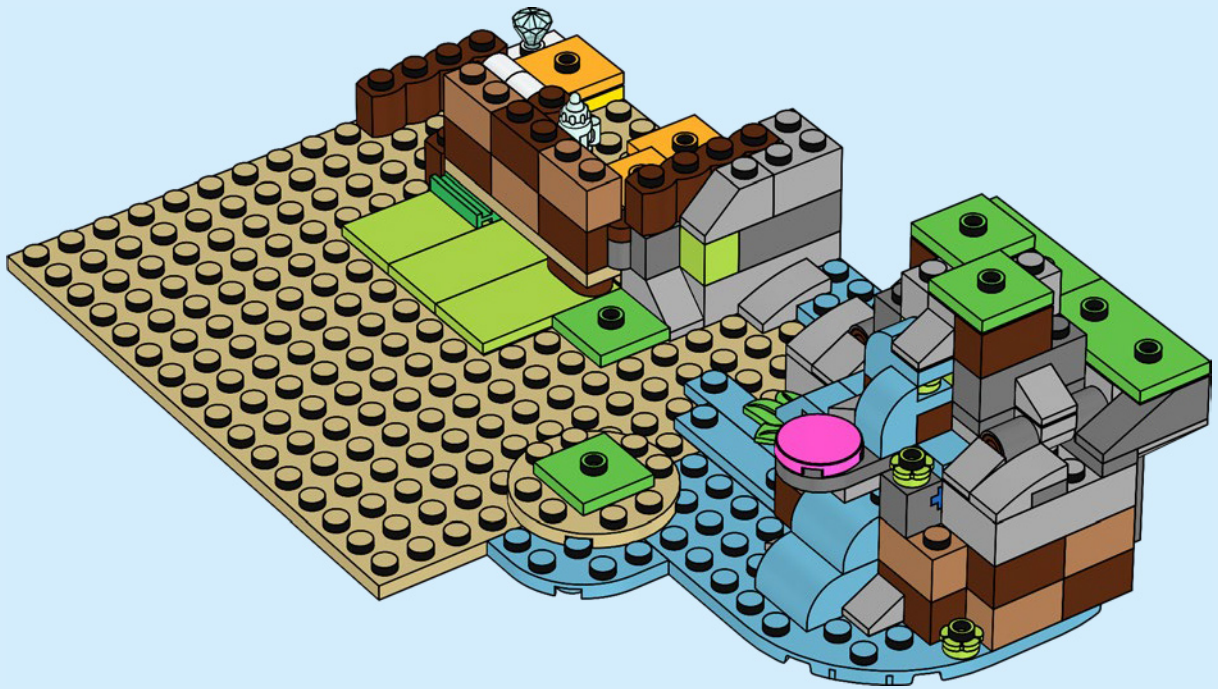

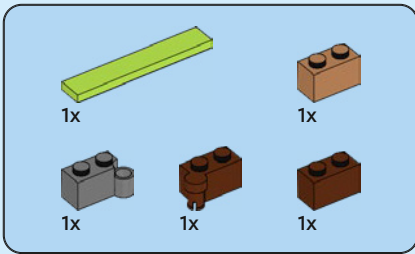

55

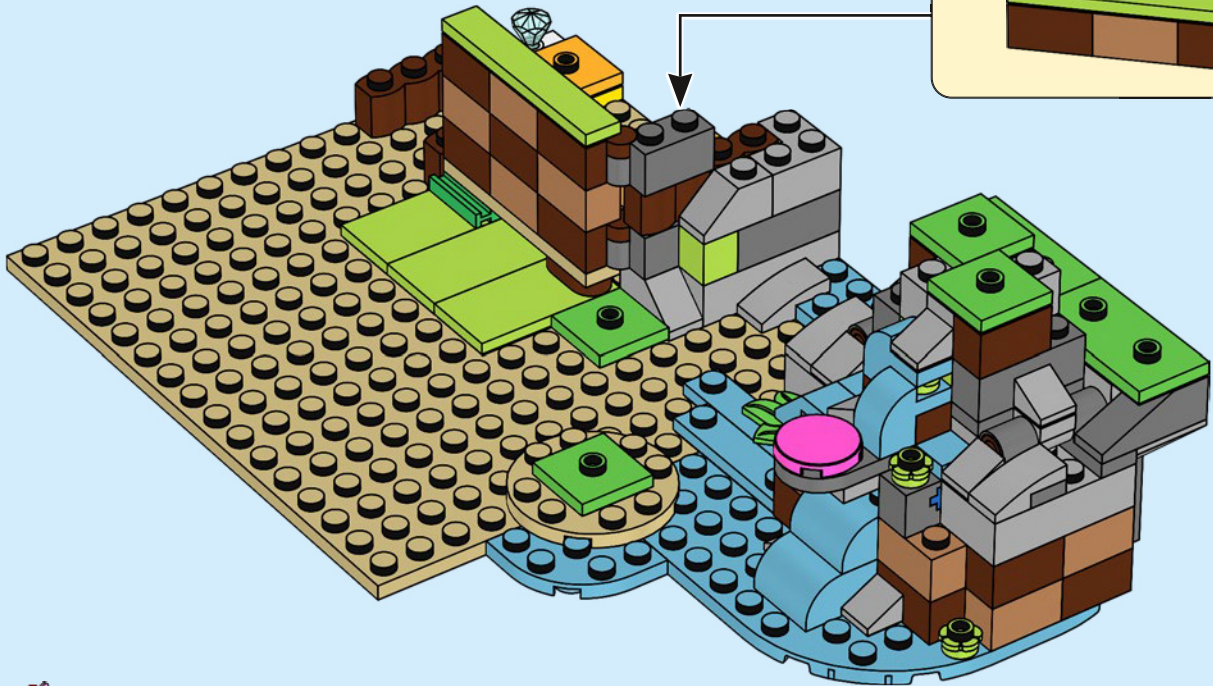
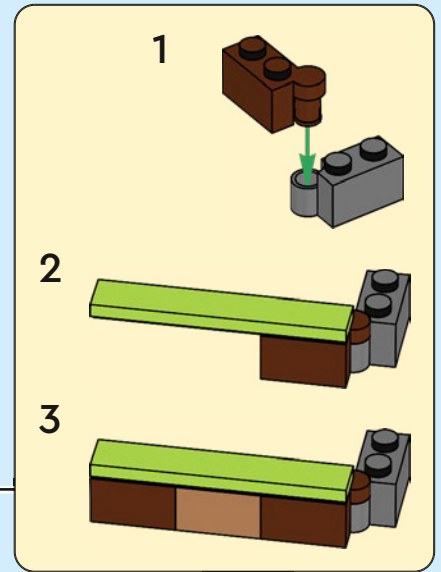

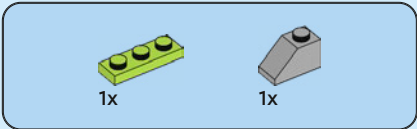

56

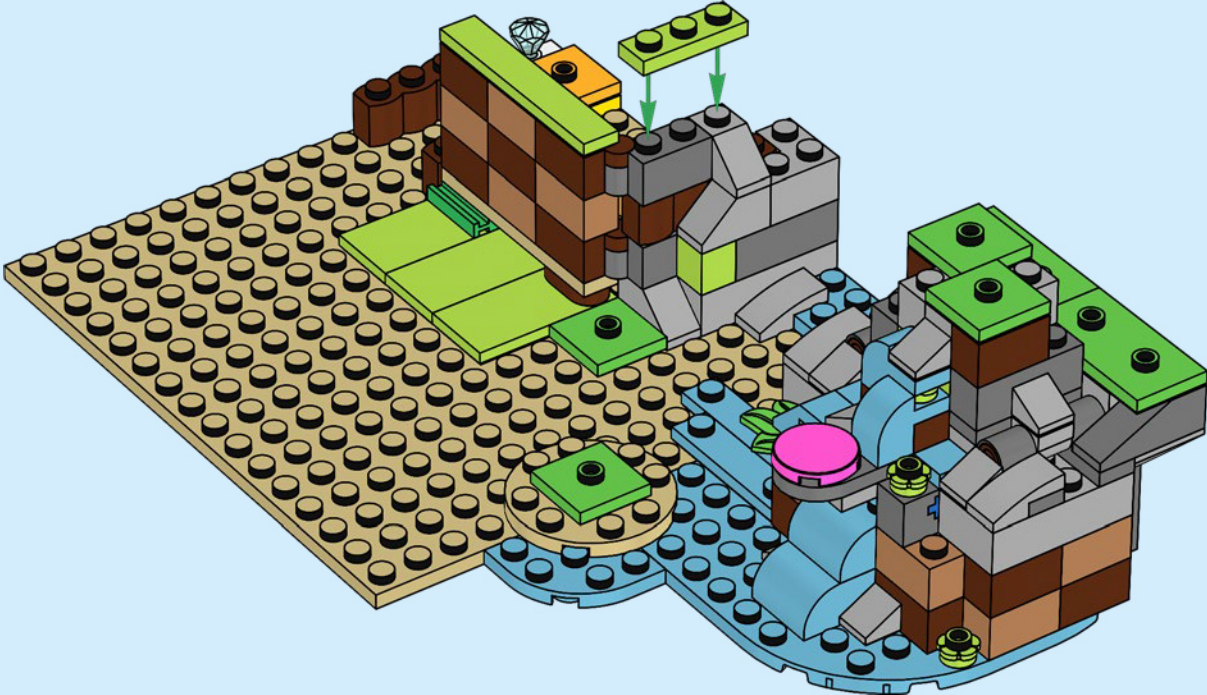

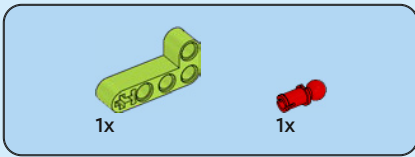

57

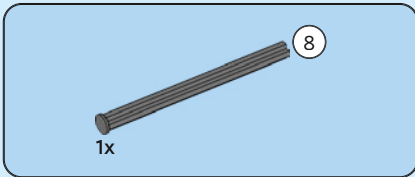
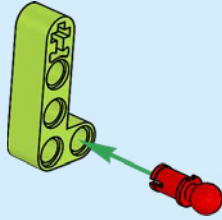

58

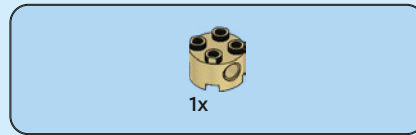
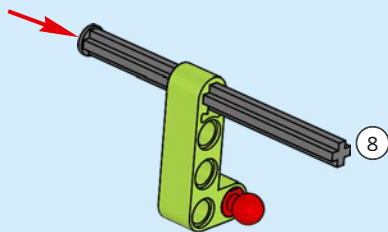

59

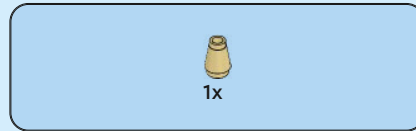
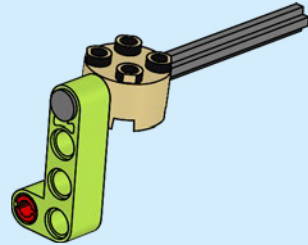

60

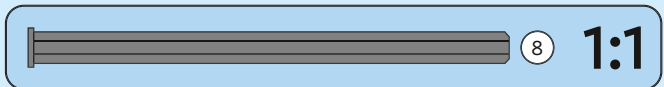
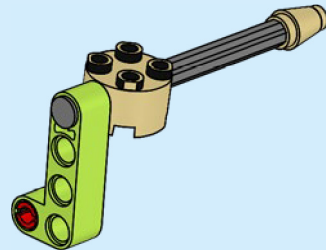

61

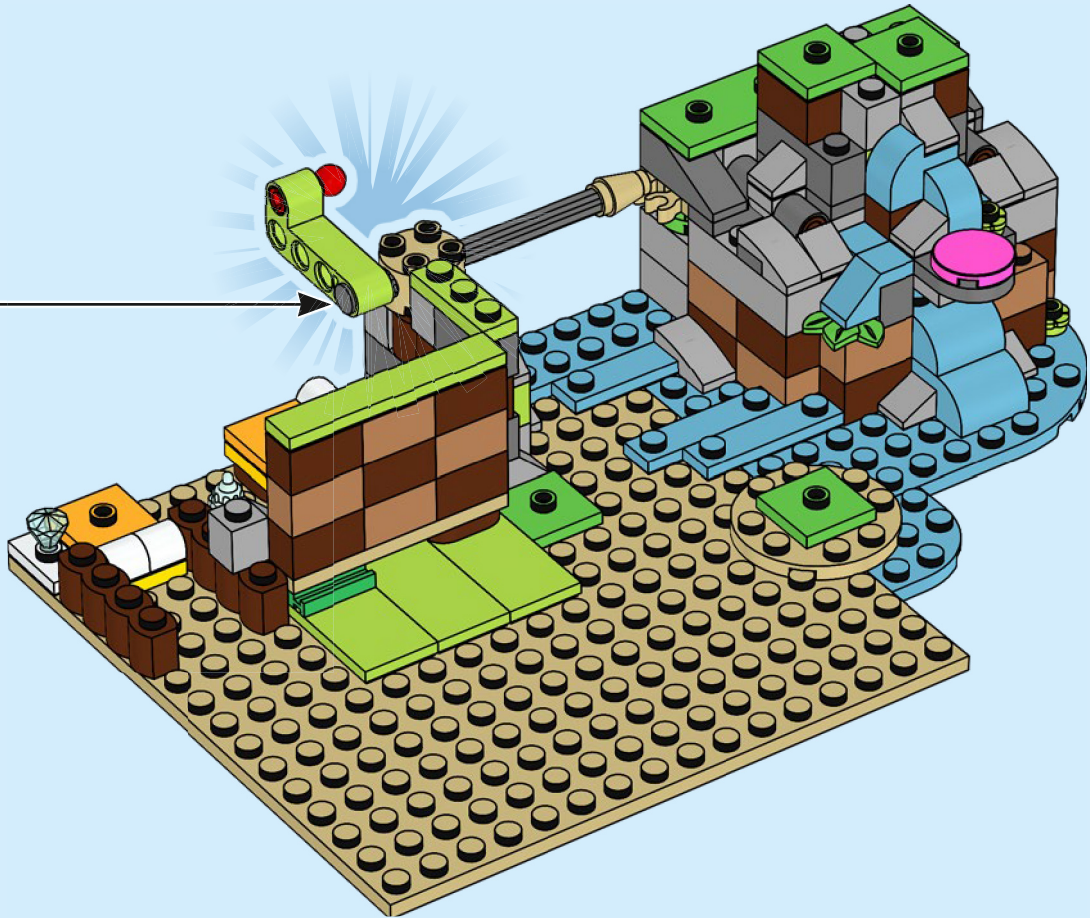



2x

62

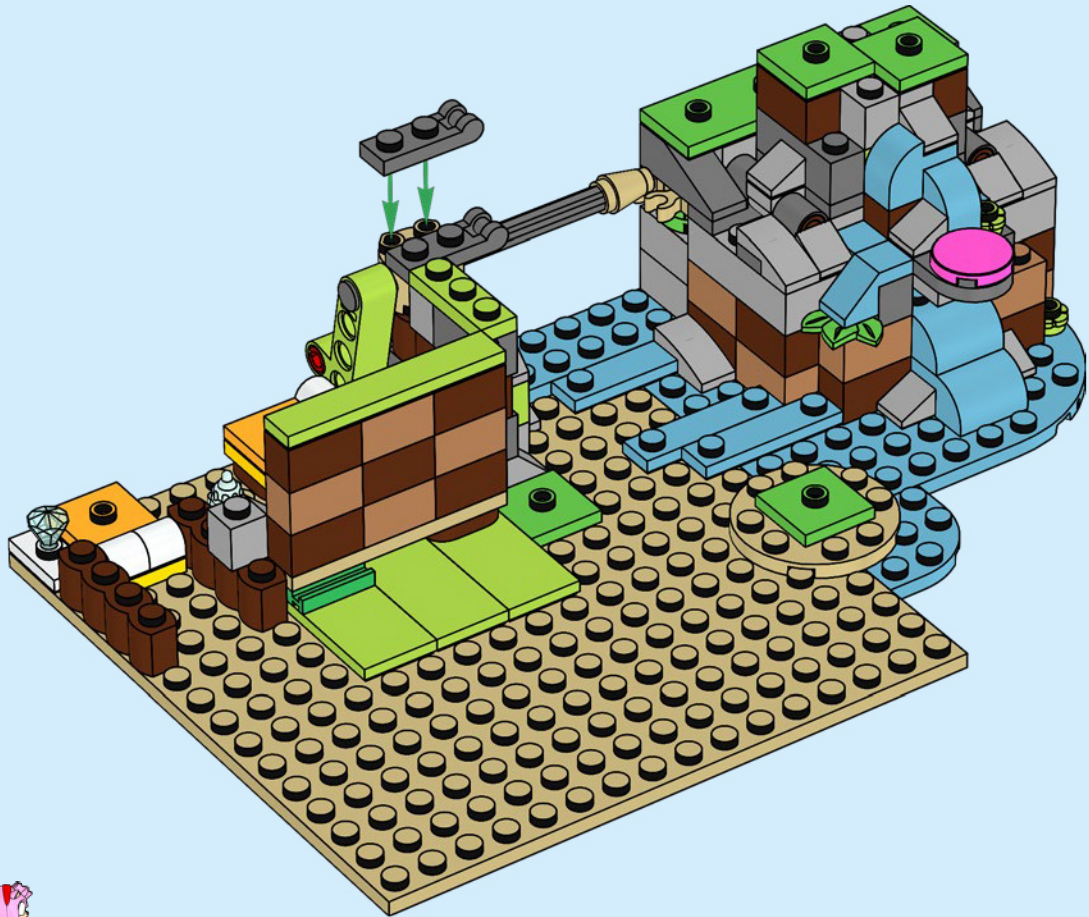



3x

63

1

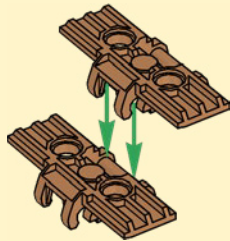

2

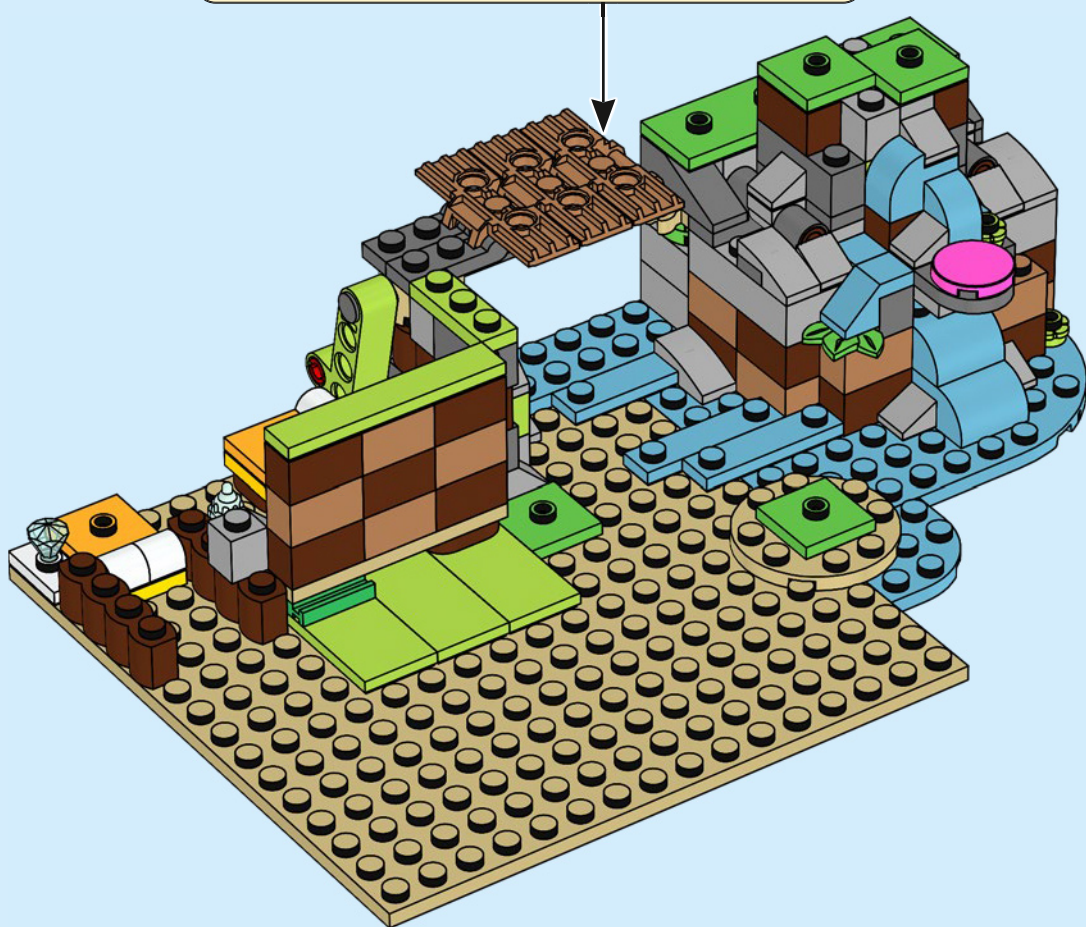
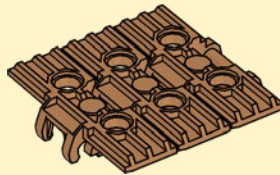

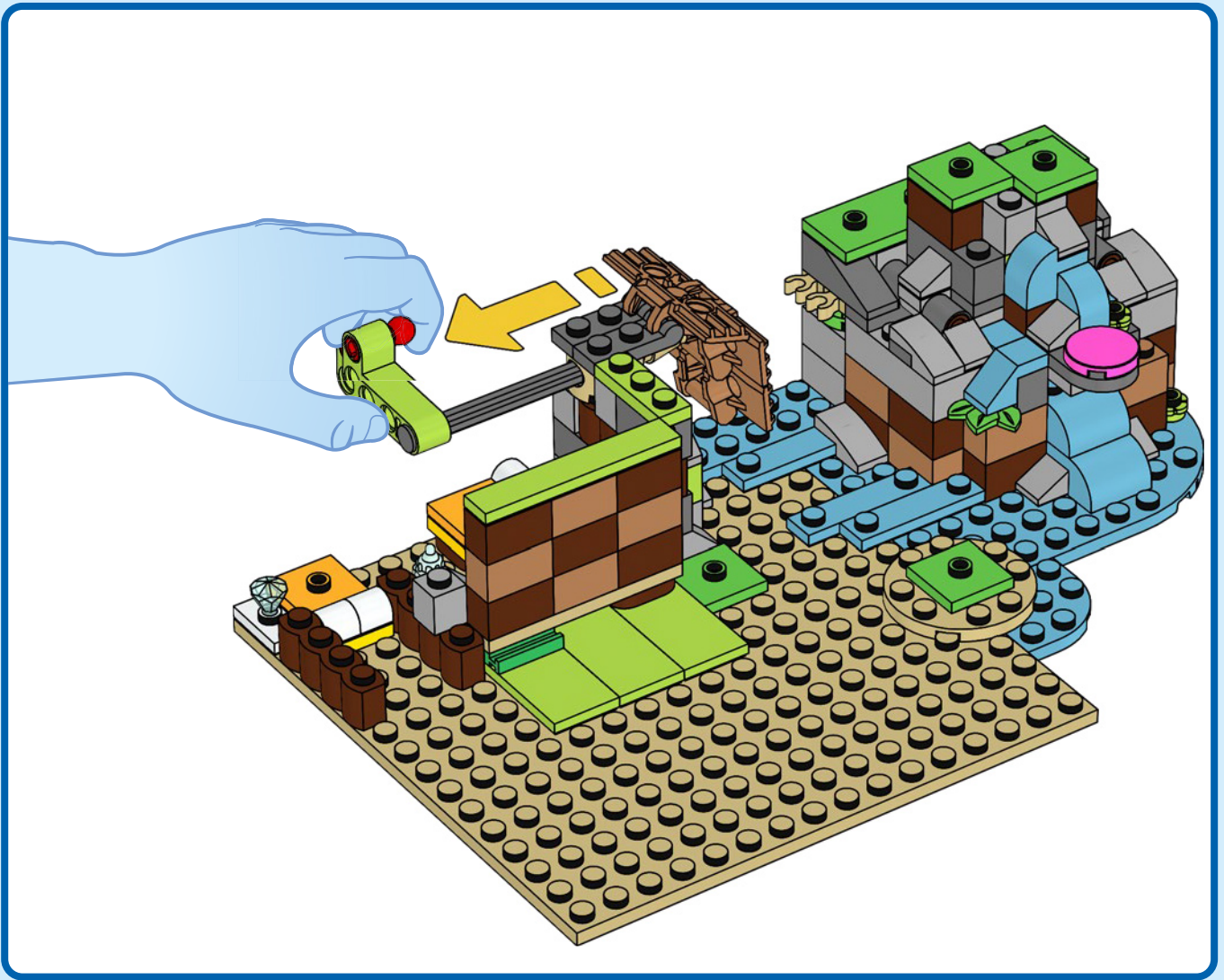

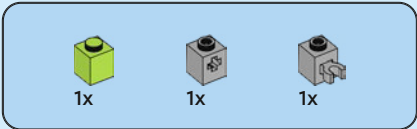

64





65

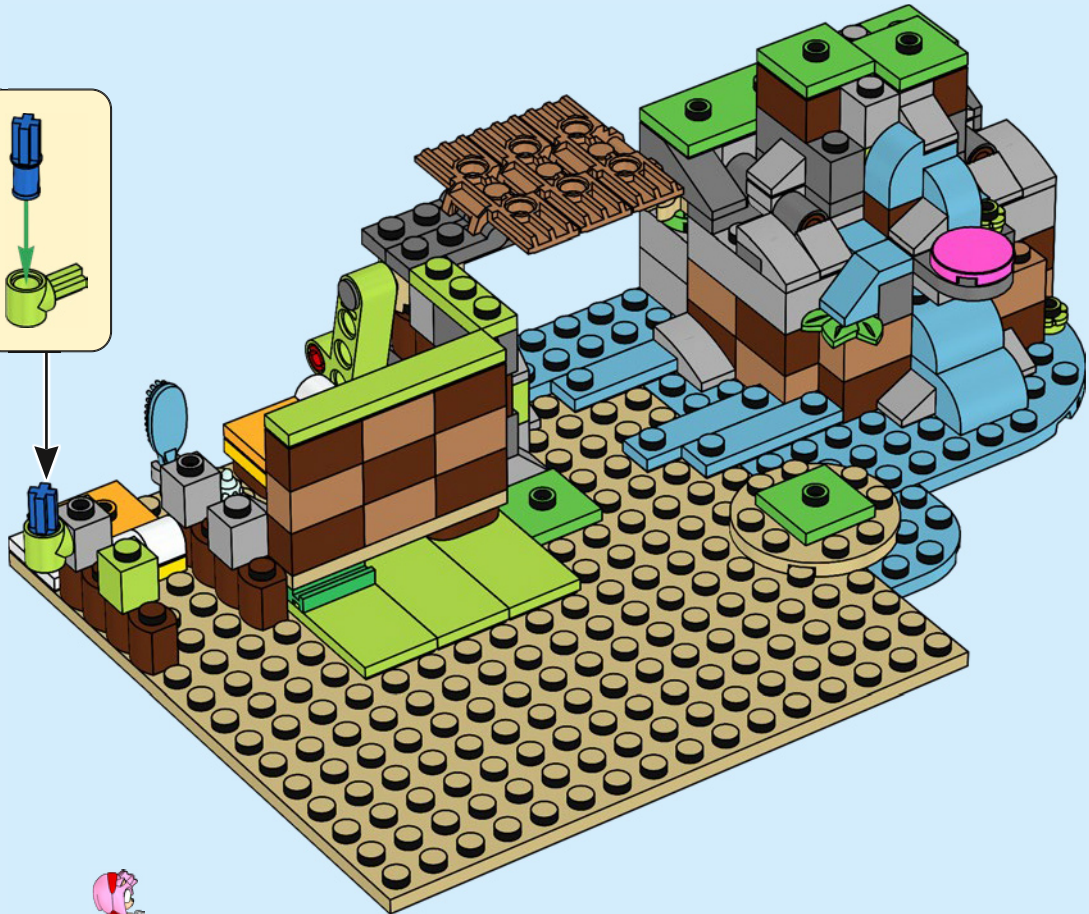
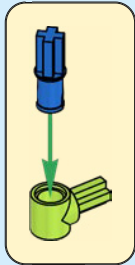

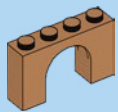

1x

66

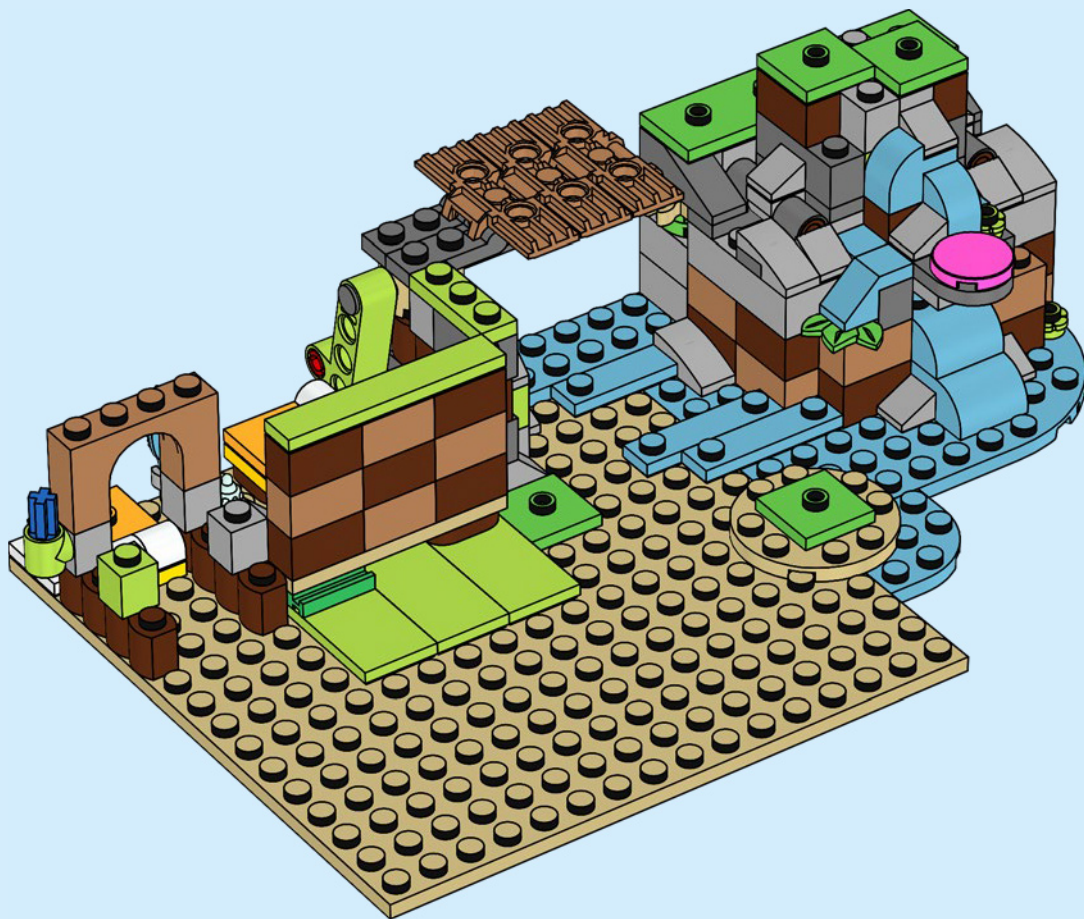

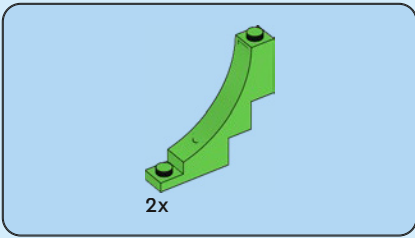

67

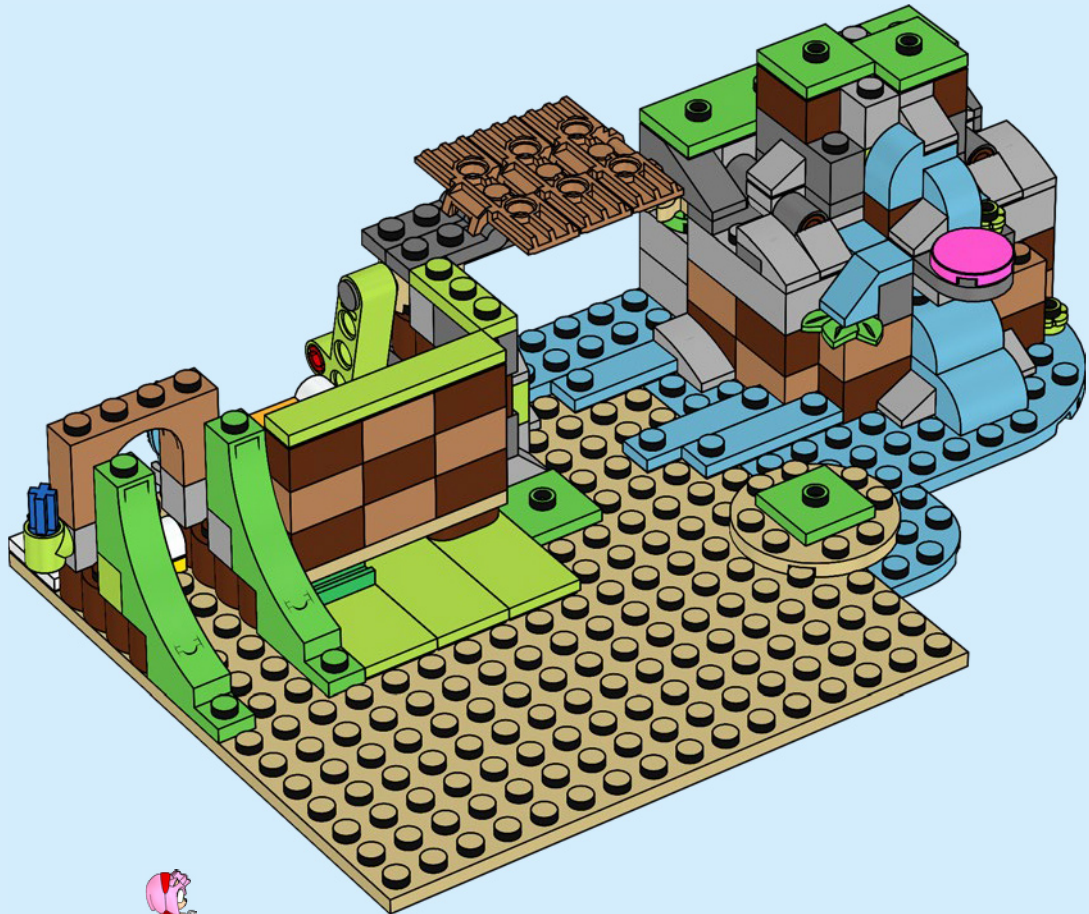



1x



1x

68

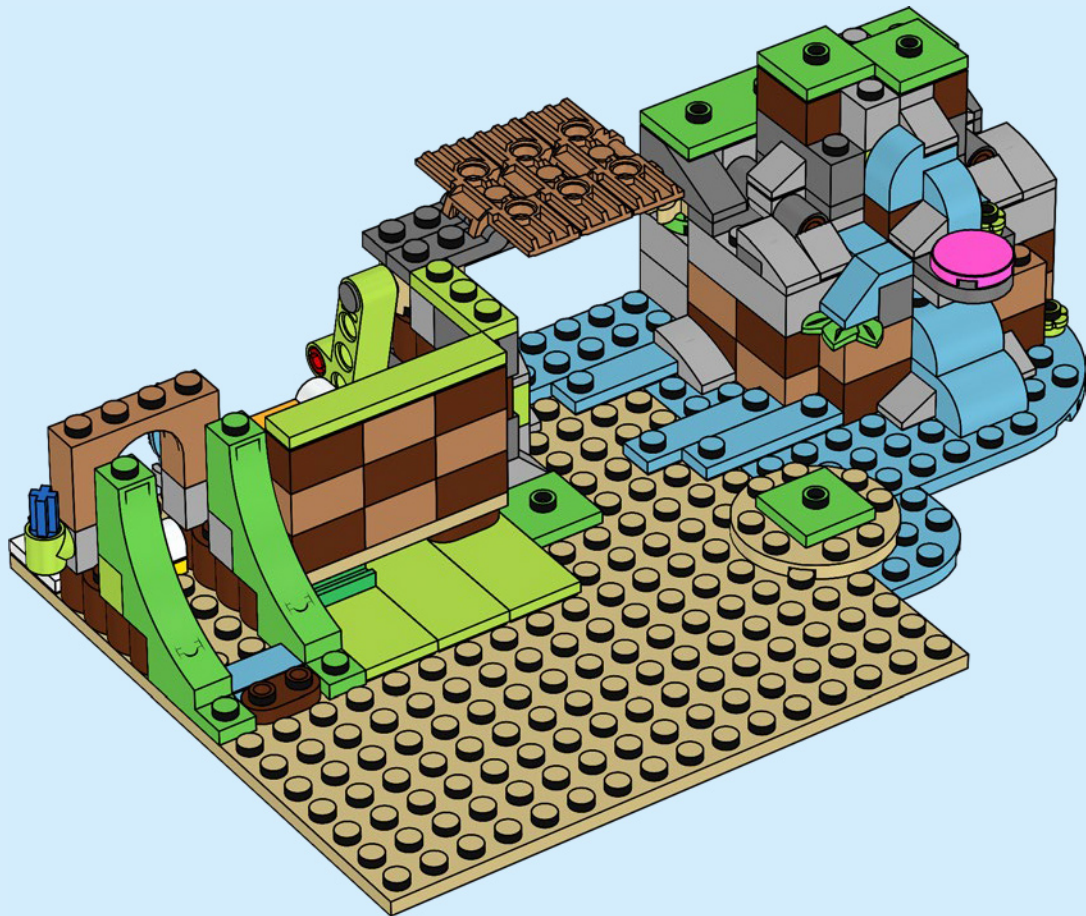

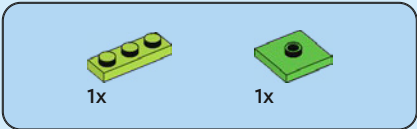

69

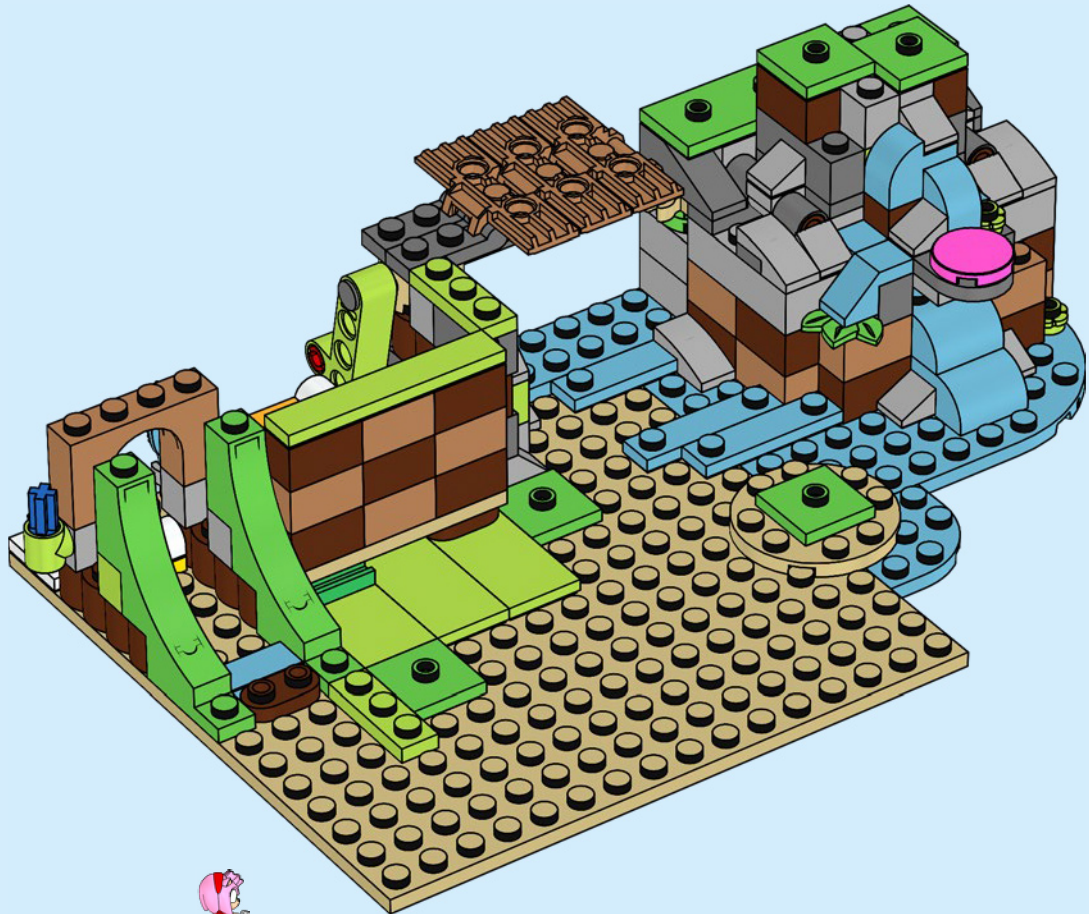



2x



1x

70

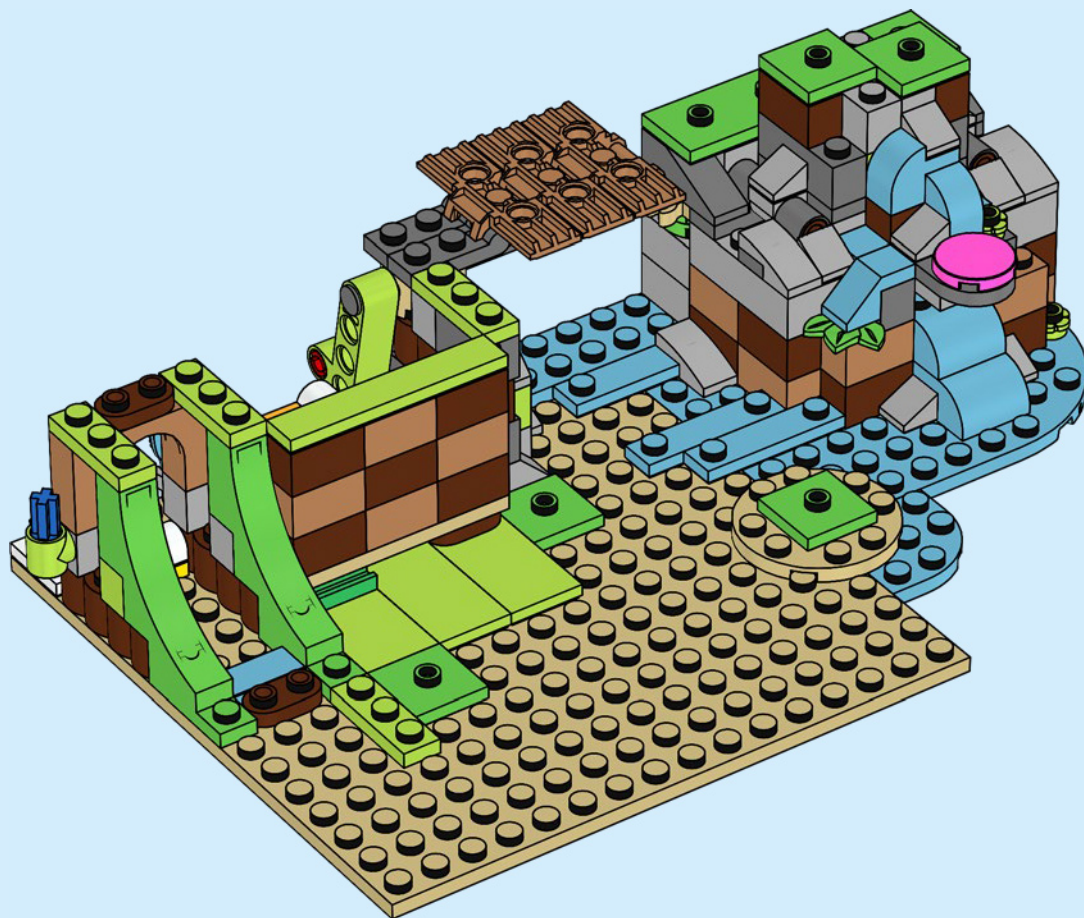

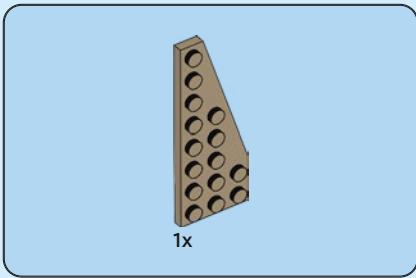

71

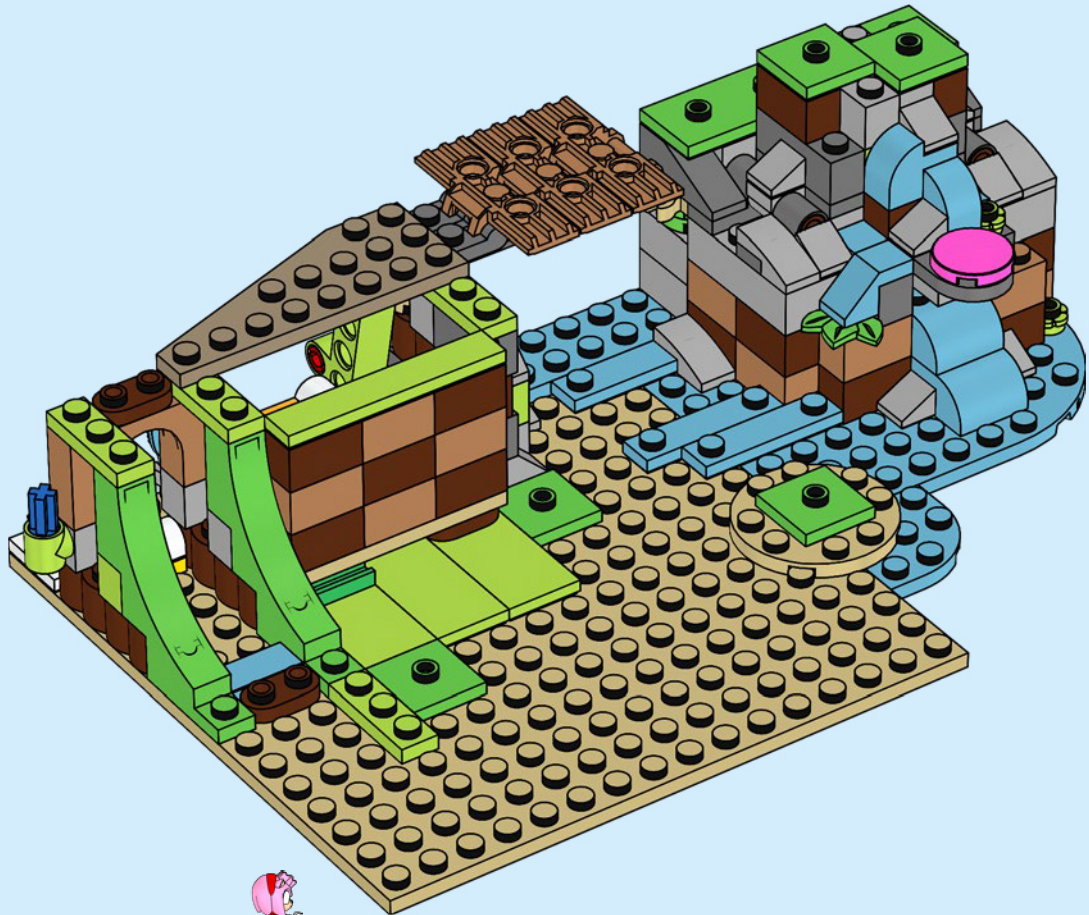



2x

72

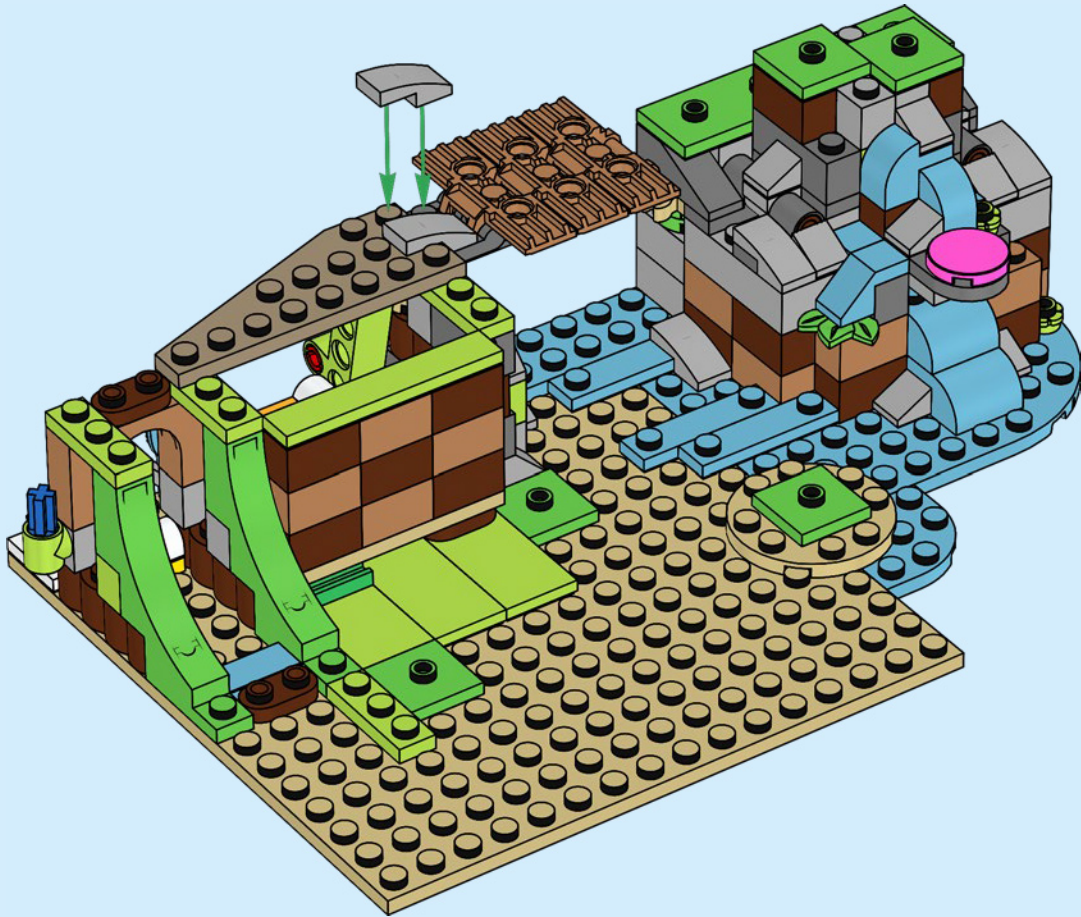



1x



2x

73

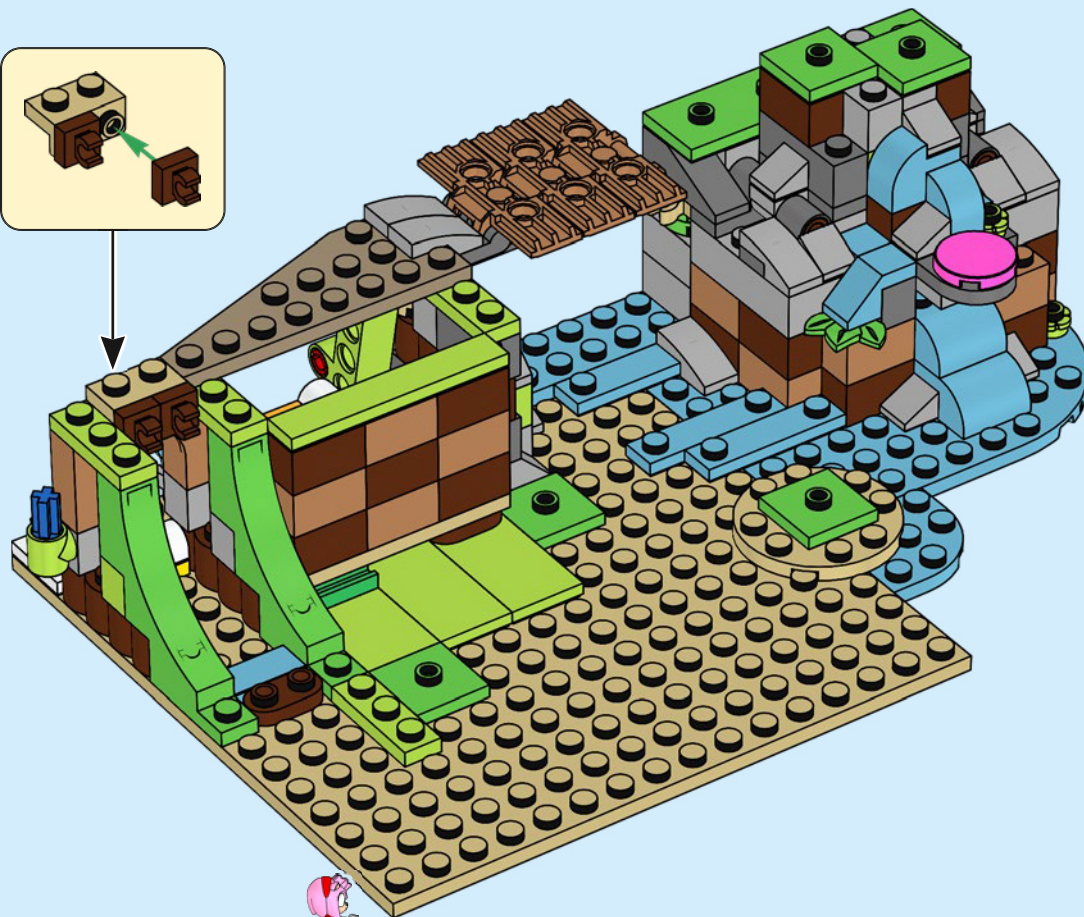
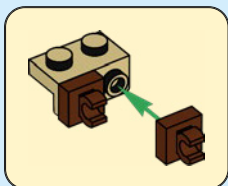

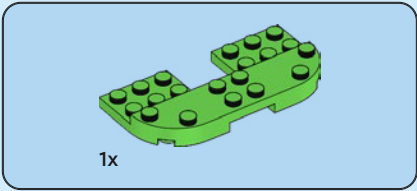

74

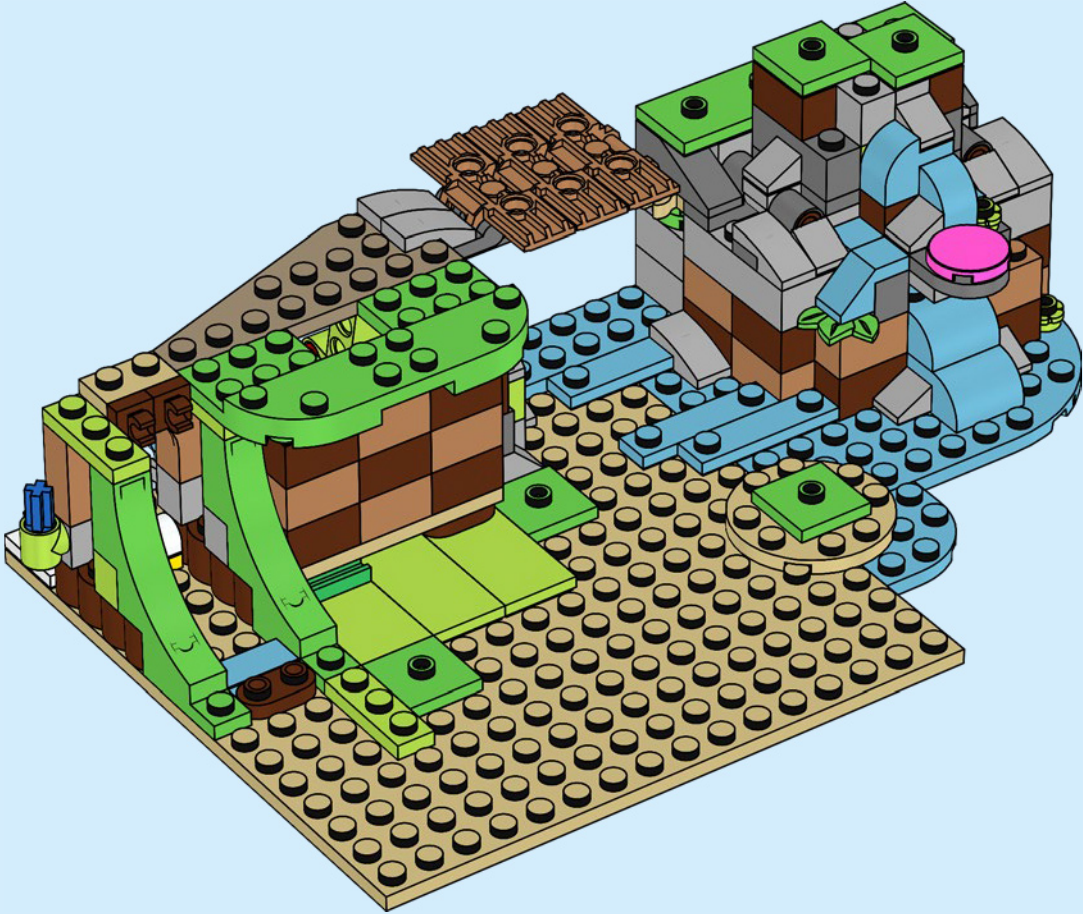

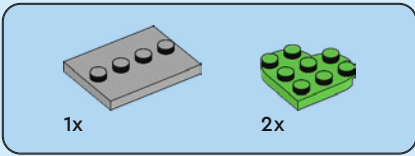

75

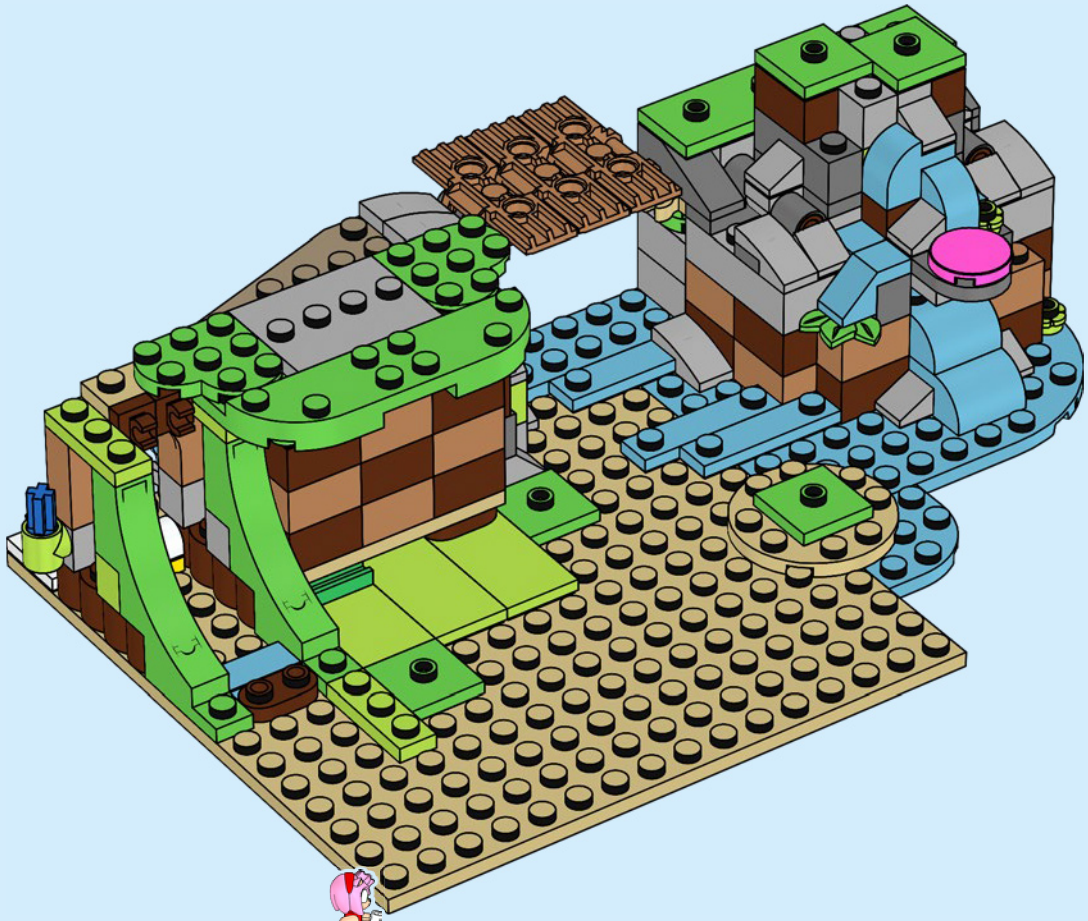

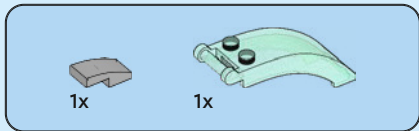

76

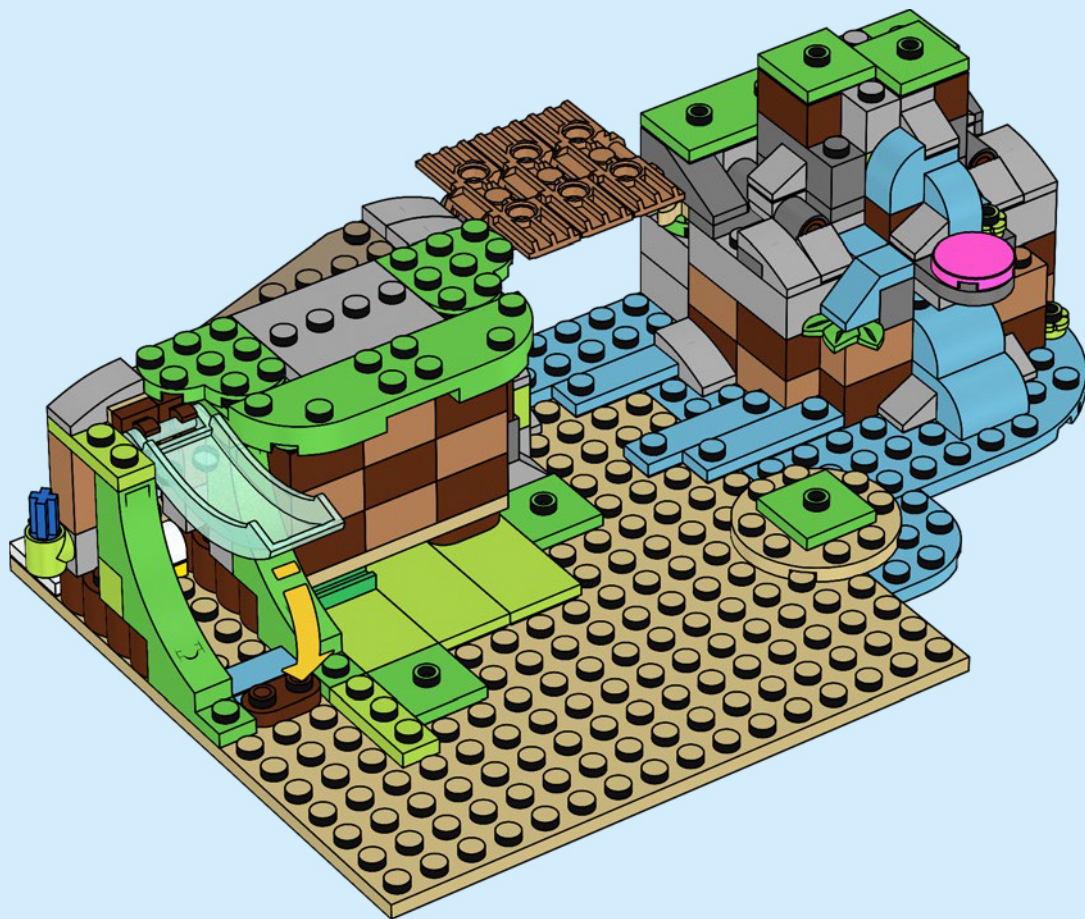

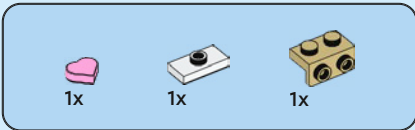

77

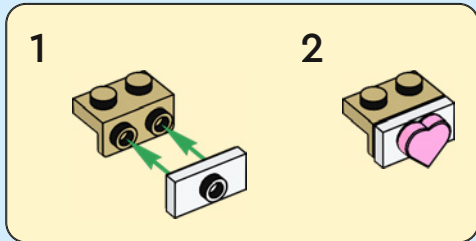

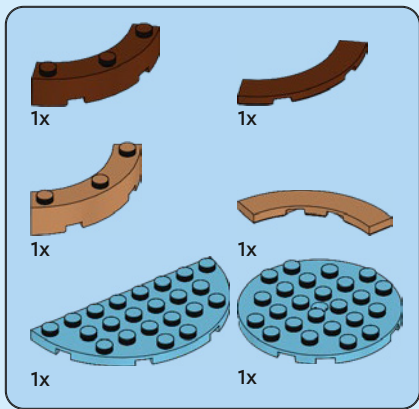

78

1

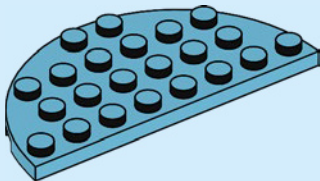

2

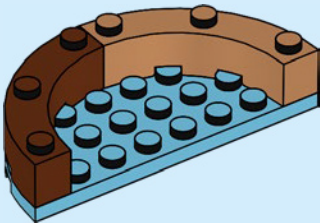

3

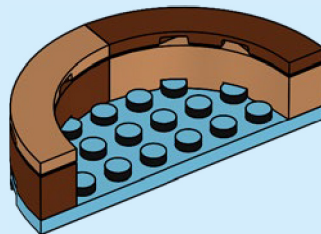

4

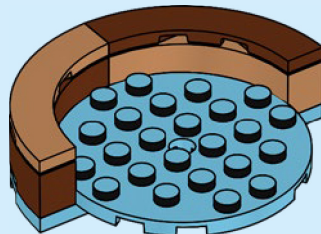

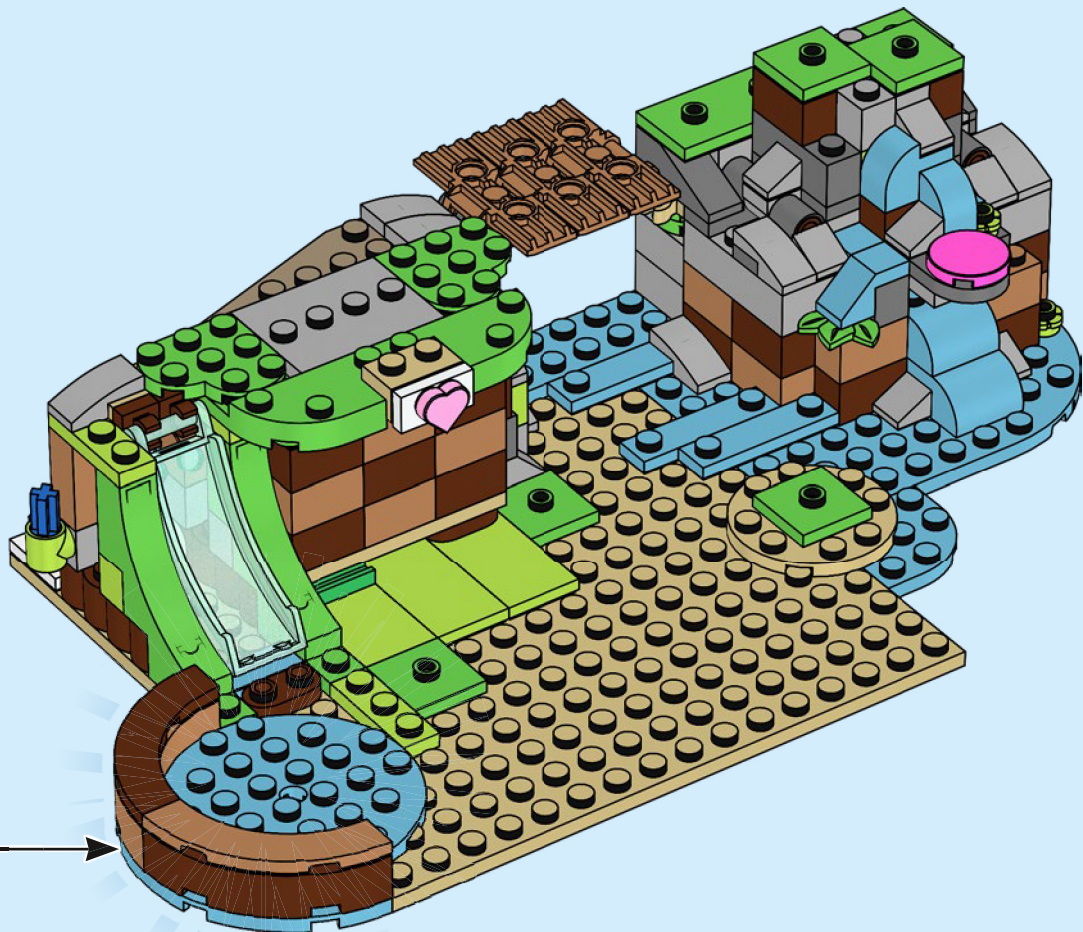

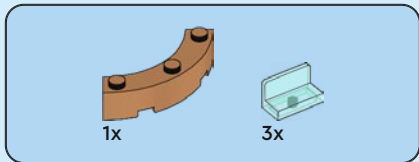

79

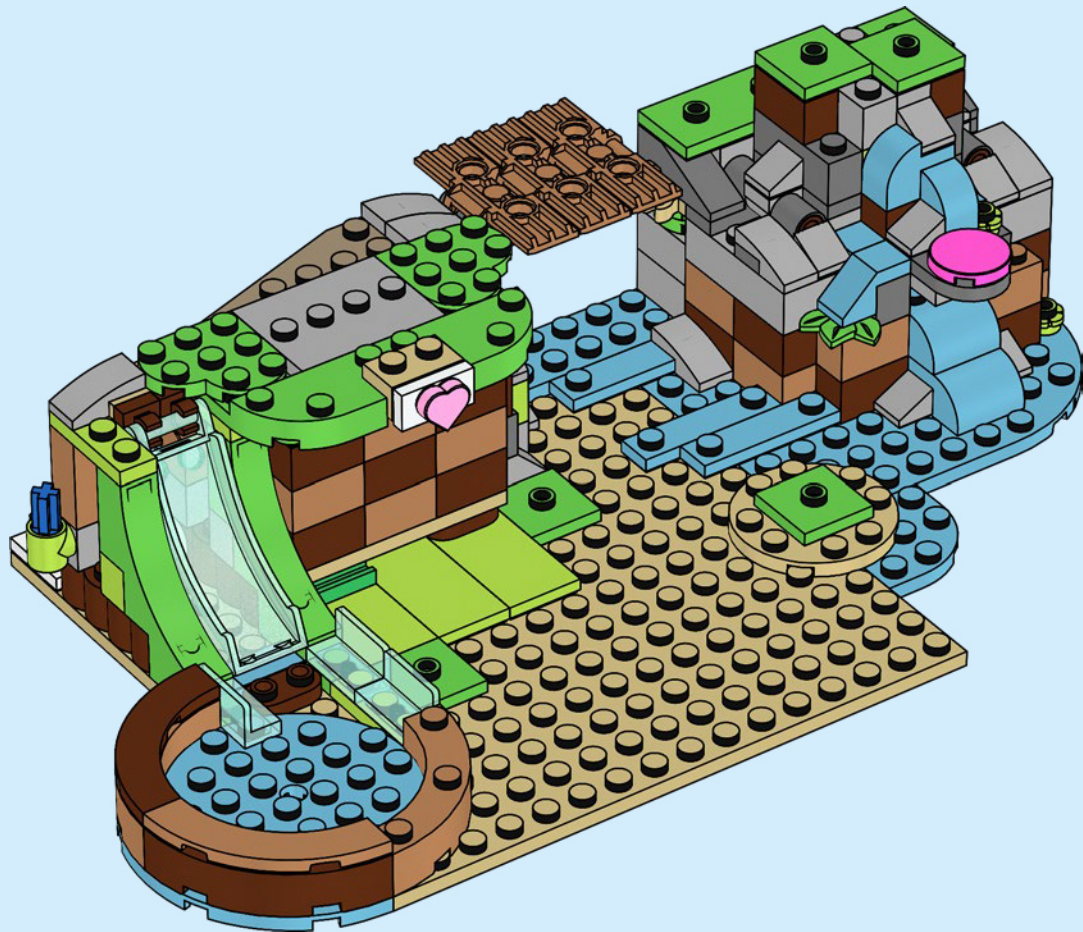

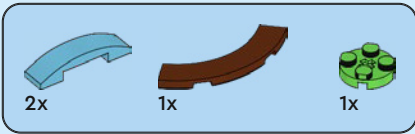

80

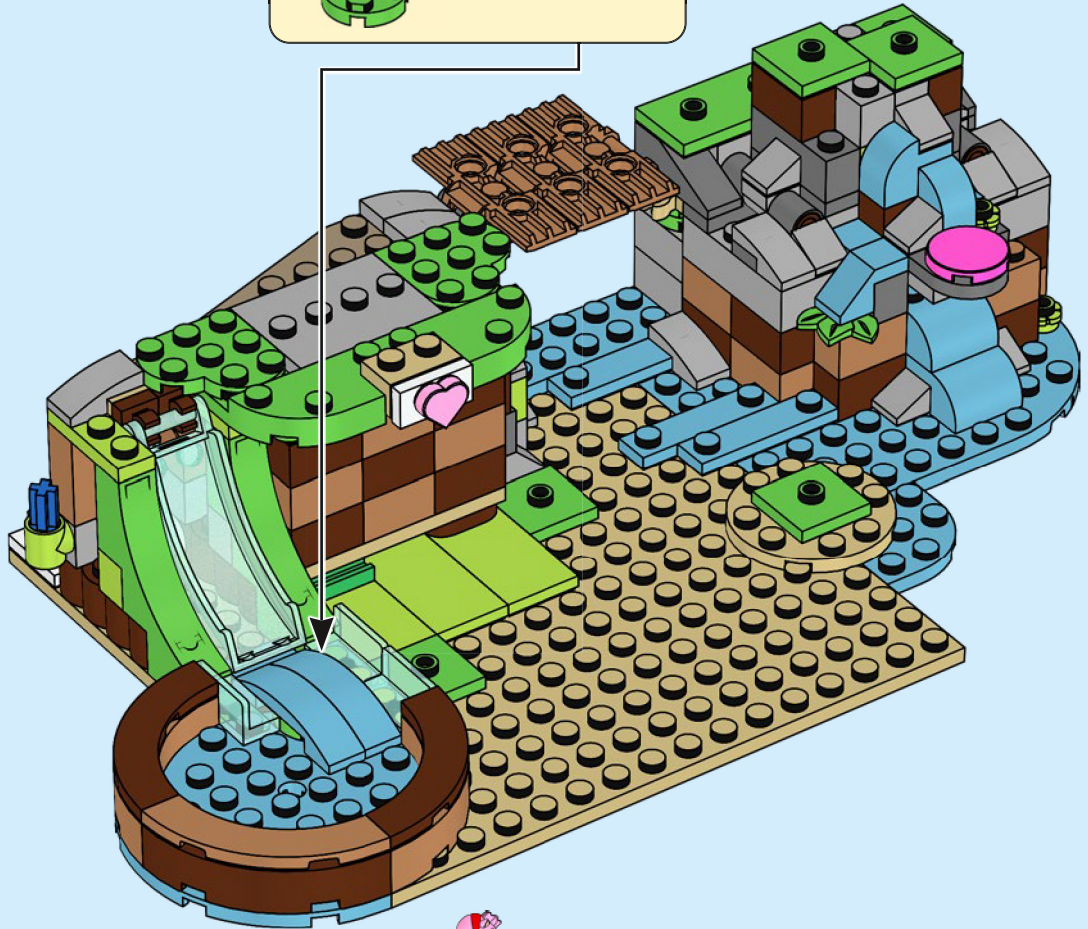
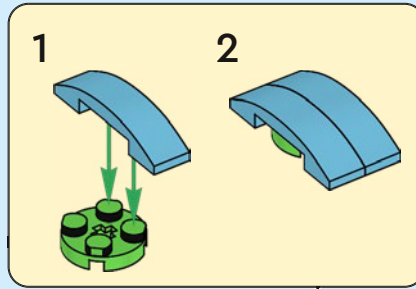



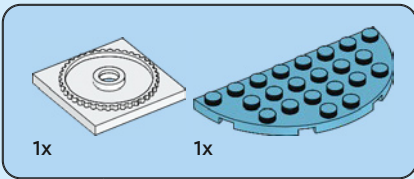

81

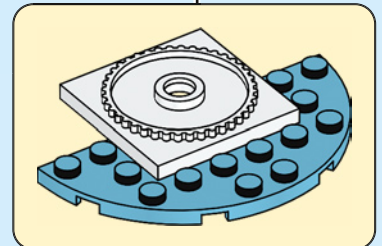



2x

82



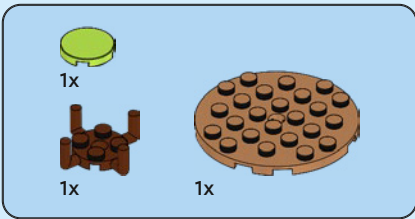

83

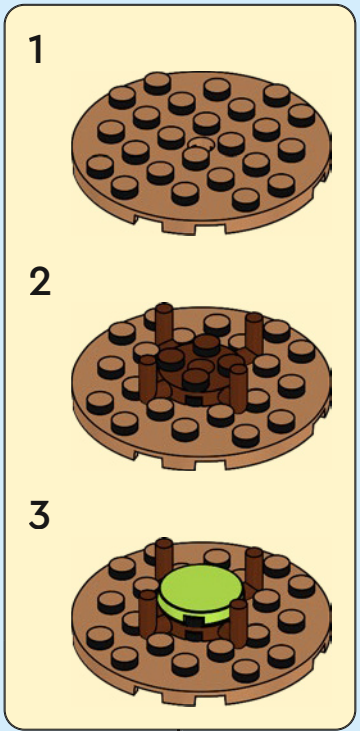



1x



1x

84

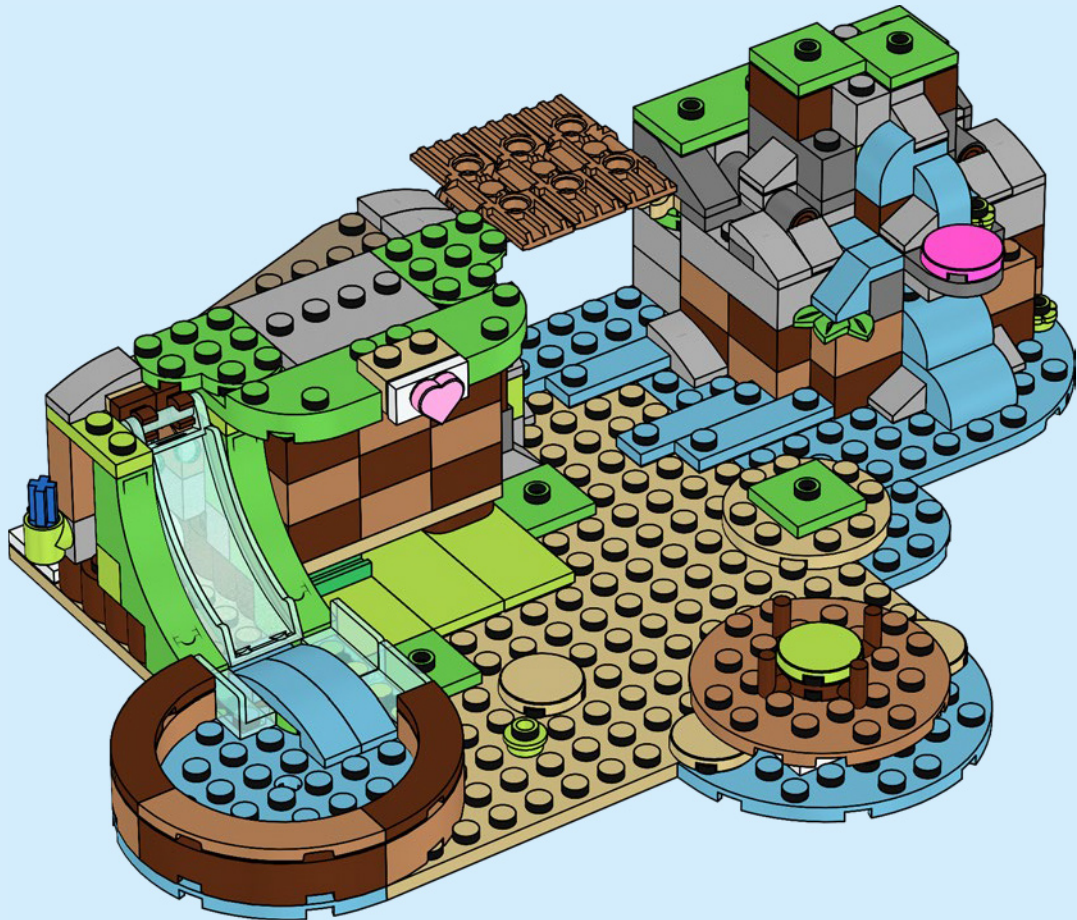



2x



1x

85

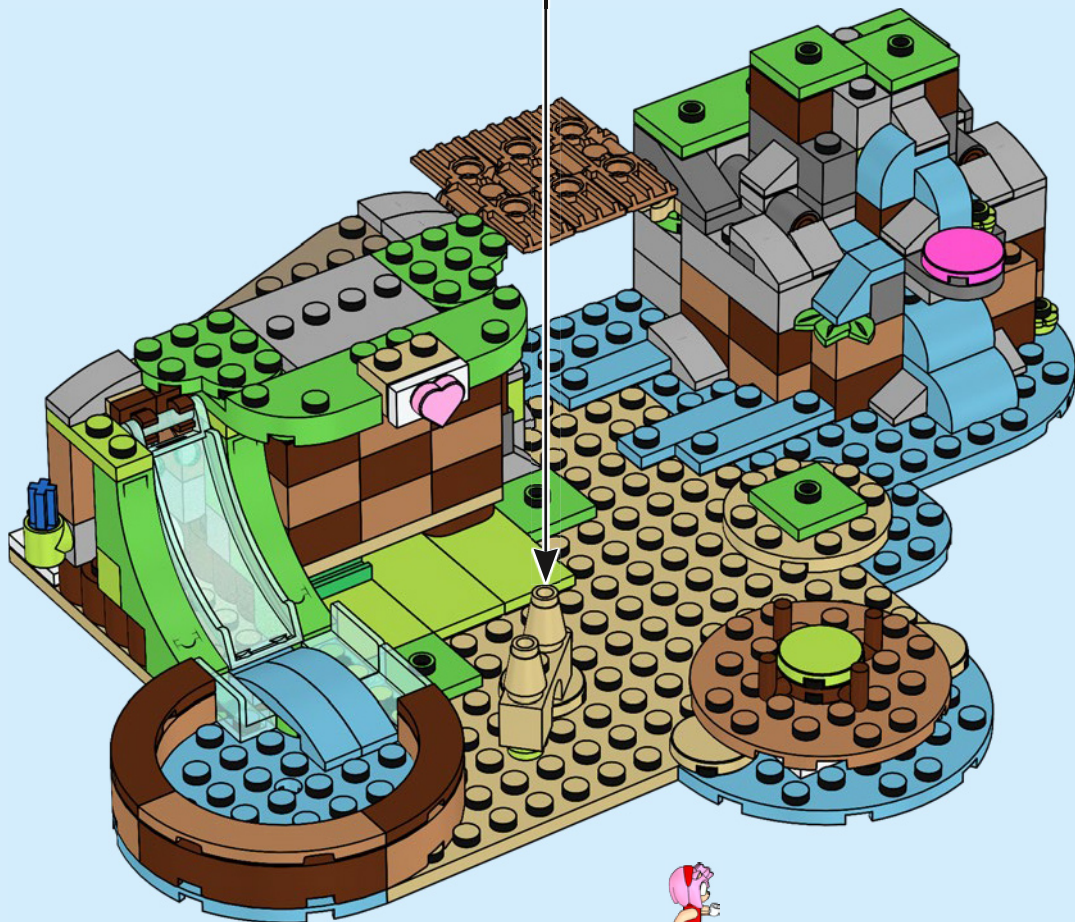
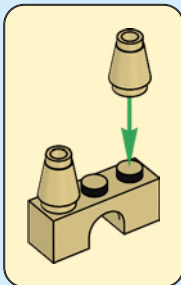



1x



1x

86

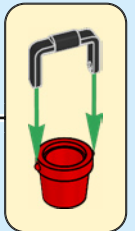
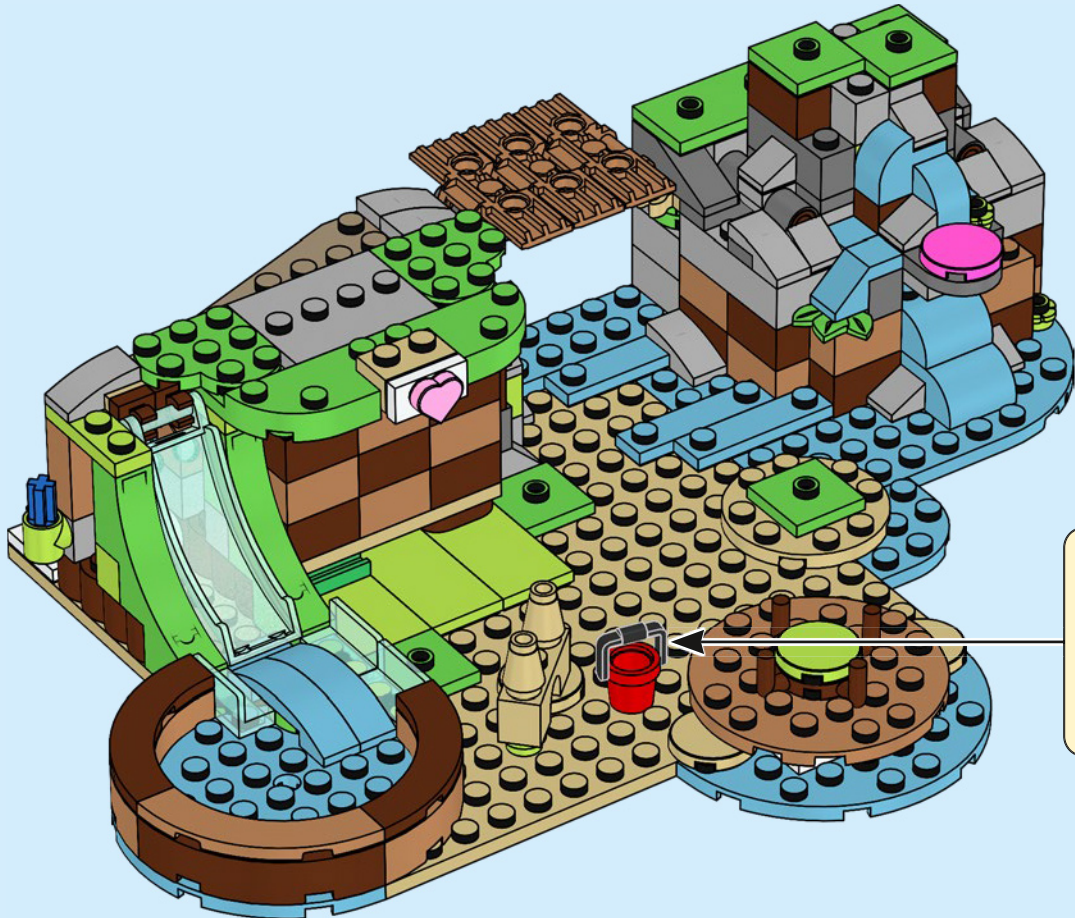

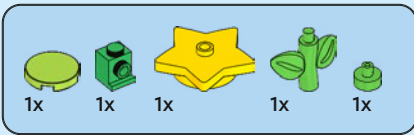

87

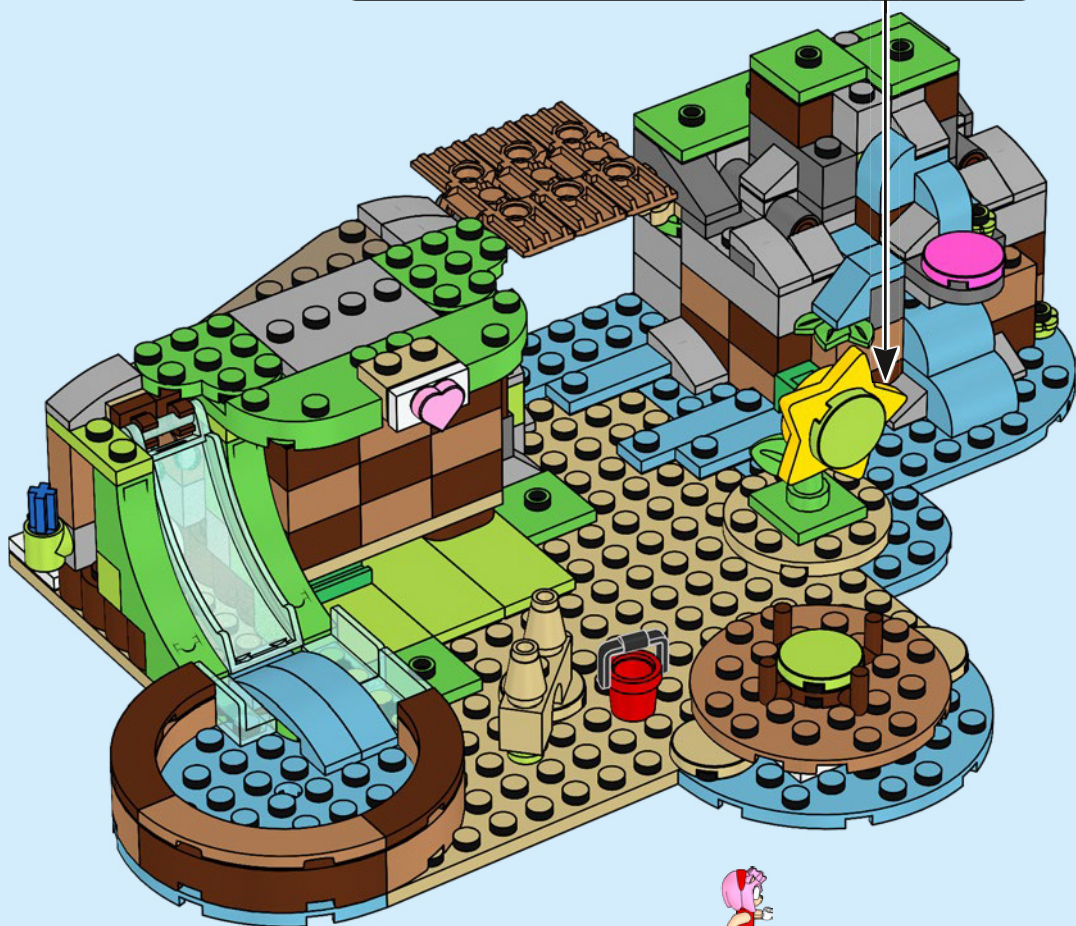
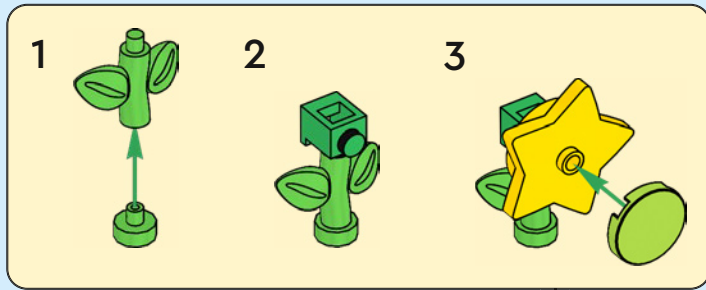

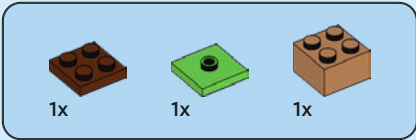

88

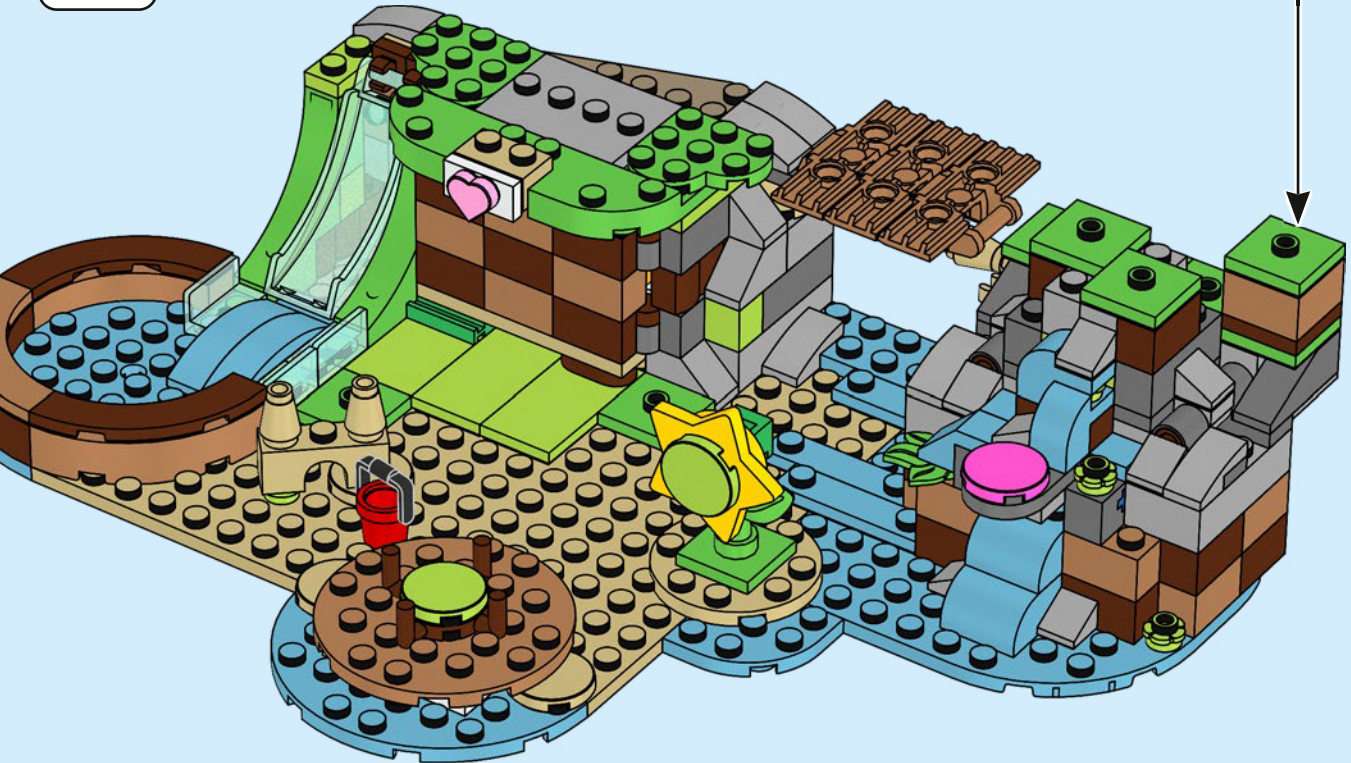
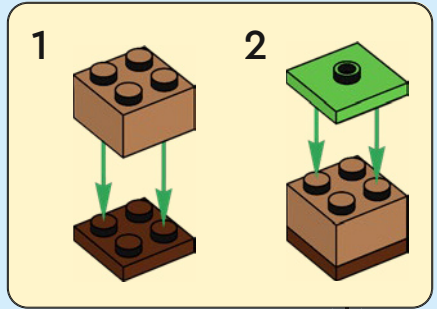

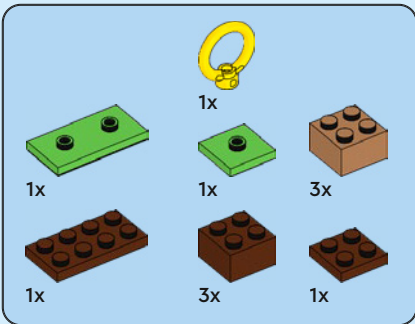

89

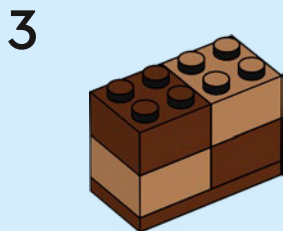
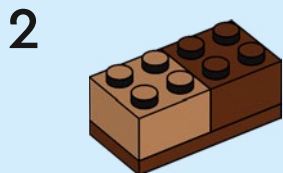

4

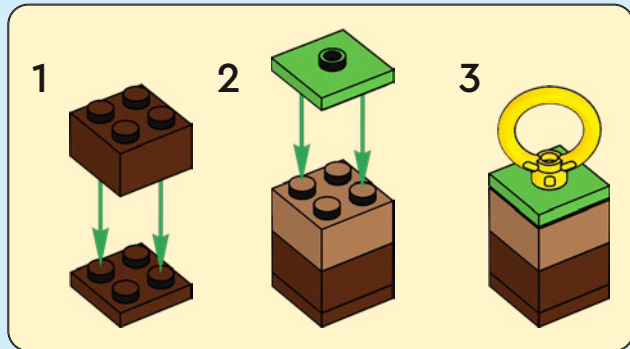
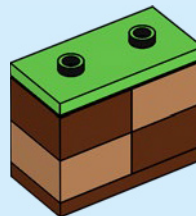

5

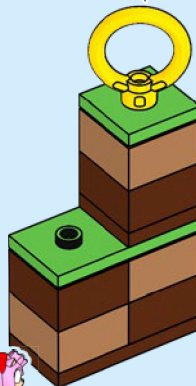





2x

90



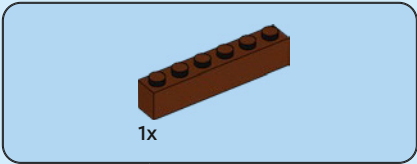

91



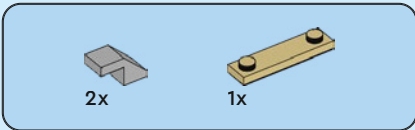

92

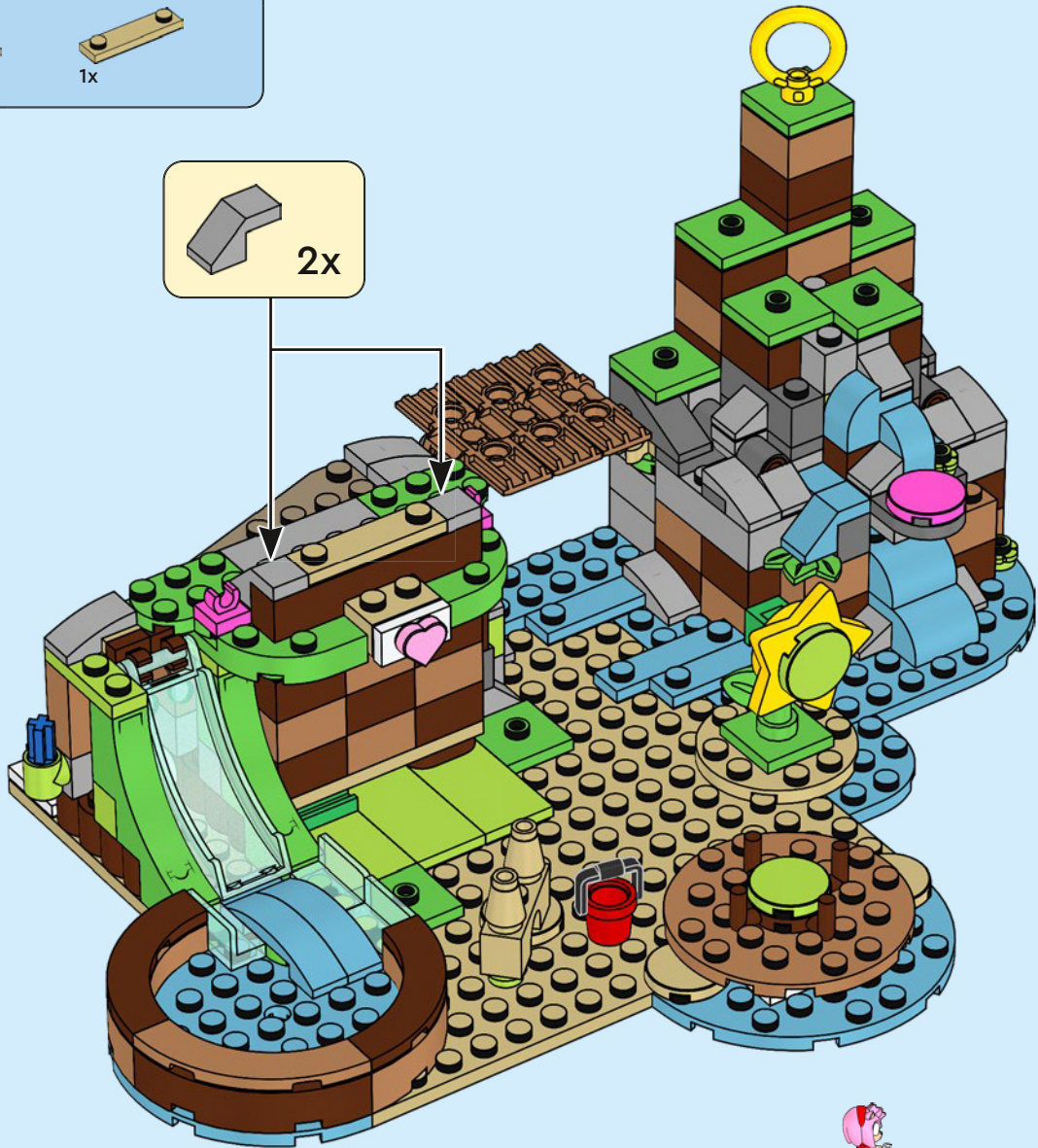
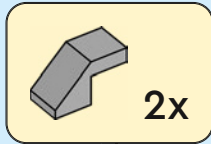

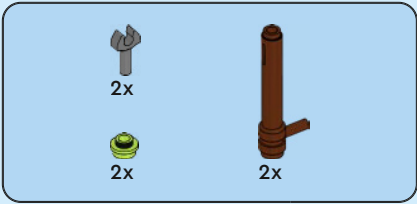

93

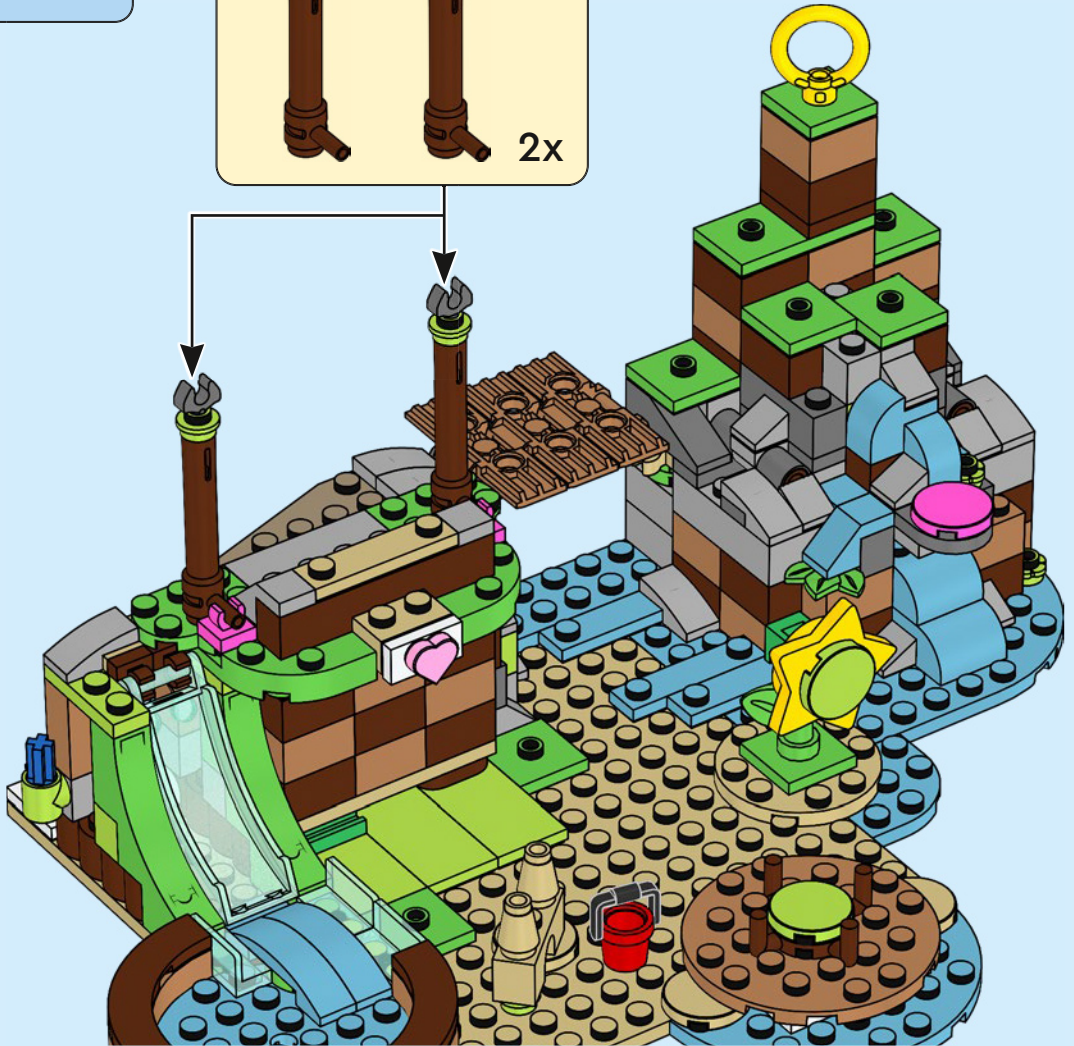
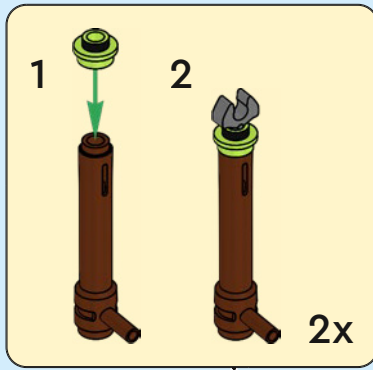



94

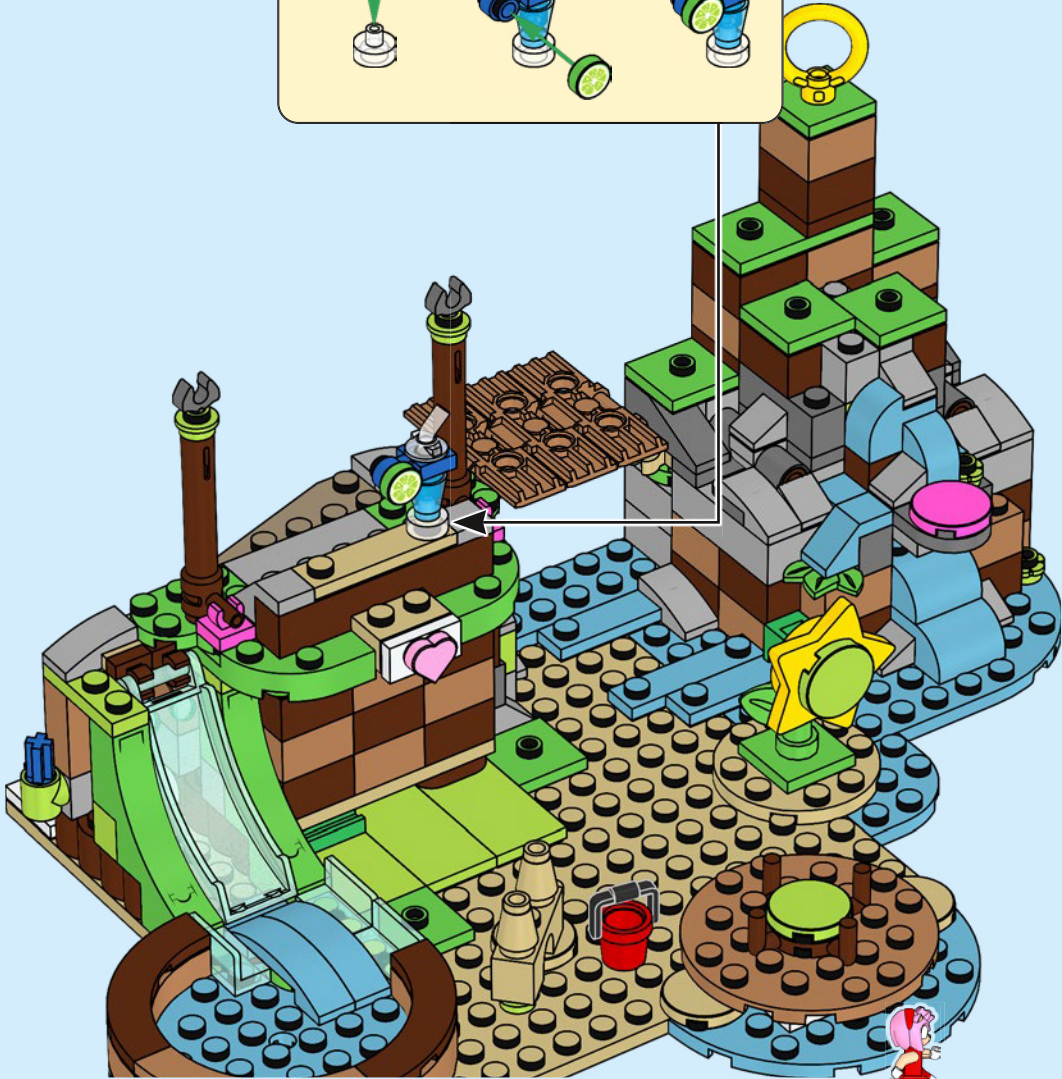
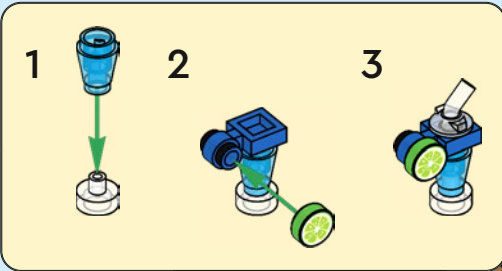

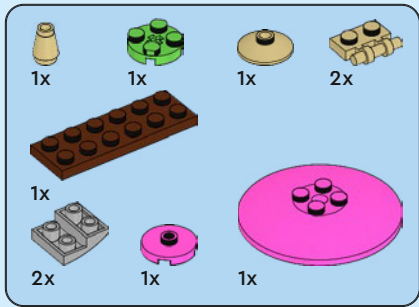

95

1

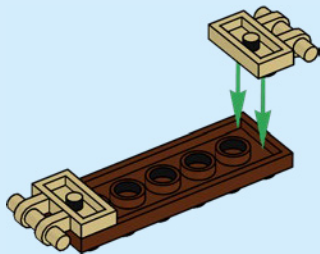

2

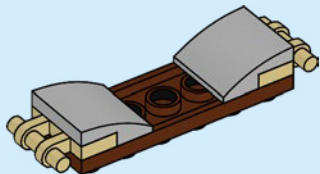

3

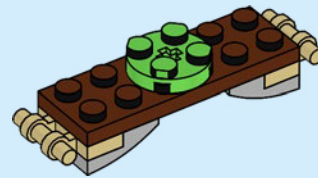

4

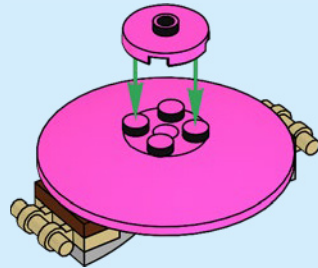

5

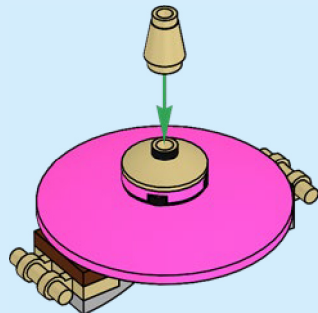



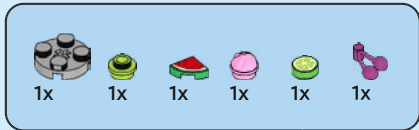

96



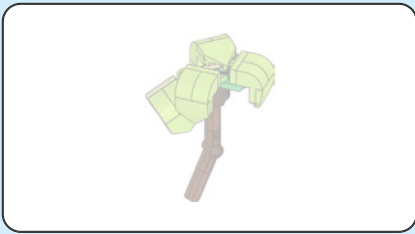

97



98

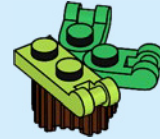

99



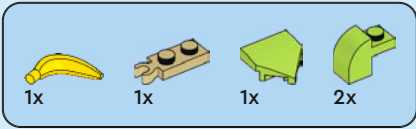

100

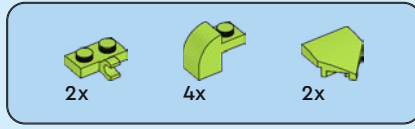
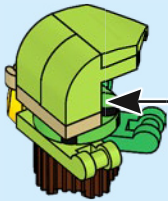
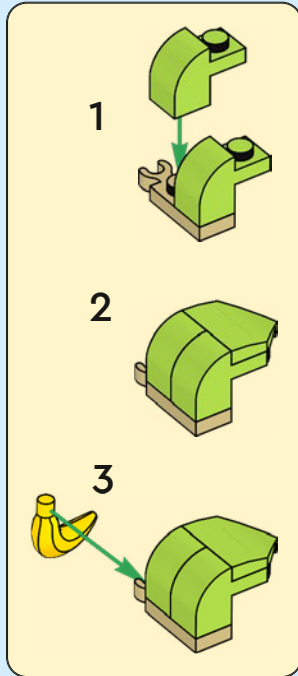

101

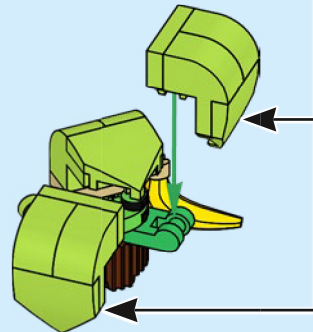
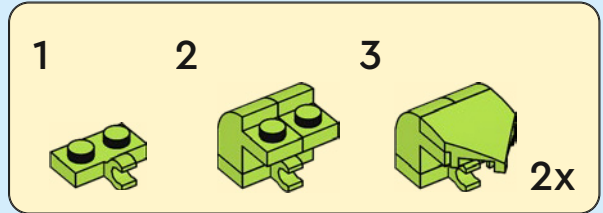

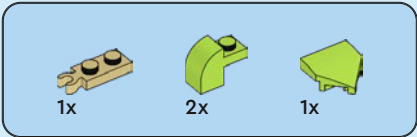

102

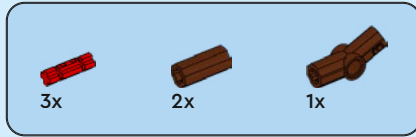
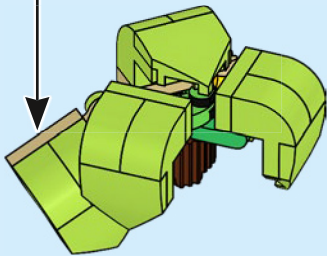
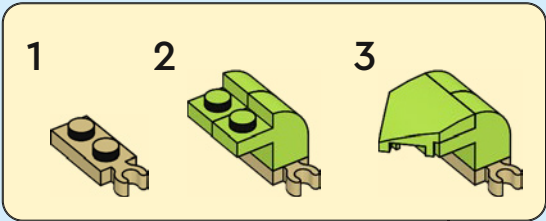

103

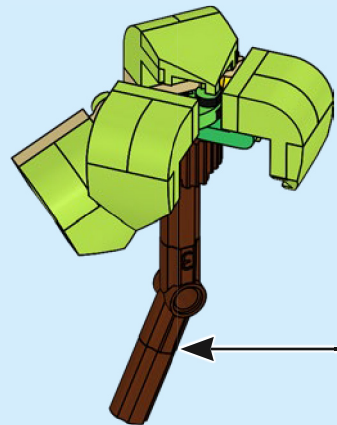
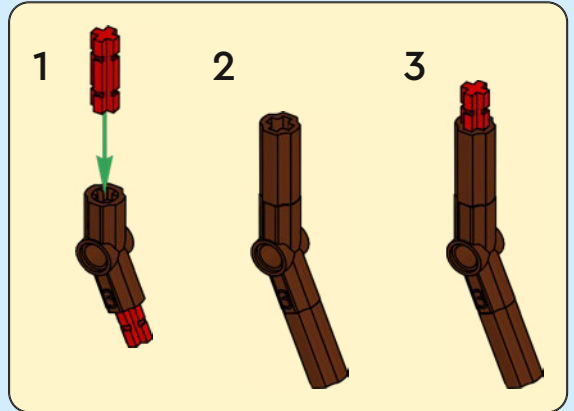

104







SONIC™

THE HEDGEHOG



Combine sets to expand your play!

Combiner les ensembles pour encore plus de jeu !

¡Combina sets para jugar mucho más!







1x
6398468



2x
6214457



2x
6359040



1x
6443193



1x
6443192



4x
6193972



1x
6452547



1x
6443191



1x
6170813



2x
6348057



4x
6248944

106



2x
6446092



1x
6036503



2x
4531751



9x
4211149



2x
6345000



1x
6330241



3x
4211210



2x
4216695



1x
6313506



2x
6135494



1x
6261388



4x
4216668



3x
4211181



1x
4211186



1x
4211193



2x
6176608



1x
4211247



2x
6326748



8x
4521921



1x
6336539



1x
6345426



2x
6407767



2x
4211475



4x
4211614

2x
6213378

7x
6028813



2x
6168633



2x
6043656



2x
6248492



1x
4654582



1x
6310976



1x
6212077



3x
4211349



2x
6185676



2x
4645397



2x
6093058



2x
6421522



1x
4211396

3x
4211385



1x
6176242



1x
6079461



1x
4211795



1x
6443198



1x
6174946



2x
6223767



2x
6375007



1x
6452622



4x
6336970



2x
6439040



1x
6395635



2x
6390673

4x
6019987



3x
6178919



4x
4211063



2x
4210795



2x
6123814



2x
4234534



2x
4521187



2x
4211045



2x
4211104



1x
4225733



2x
4211105



1x
6106191



1x
4499858



1x
6424008



2x
6275466



1x
6423955



1x
6452559



1x
6443212



1x
6443196



1x
6147169



10x
4569382



2x
6022004



4x
6058085



1x
6174192



3x
6442980

1x
6387478



1x
6058368



1x
4649741



3x
6296622



2x
6335566



1x
6264993



2x
6146866



3x
6252704



2x
6097093



1x
6029690



1x
6253666



2x
6138571



1x
6380619

3

8



6x 6258135
2x 6051511
1x 371001
1x 4611927
4x 4529237
2x 4118793
3x 6066344
1x 6232037
1x 4617765
1x 6092587
2x 6249809
2x 4140593
4x 6372047
2x 6212038

1x 4618651
1x 6257600
1x 6302268
1x 4124067
1x 4611414
2x 6443195
1x 6003001
4x 4504379
1x 6360104
1x 6210269
4x 6335377
2x 403221

1x 302224
1x 4114584
3x 302124
1x 6248804
3x 4206482
1x 6281991
1x 6289740
1x 6289743
1x 403224
1x 6441692
2x 6437958

1x 6186867
1x 6285587
1x 6028018
1x 6247792
3x 6246890
1x 6173922
4x 4142865
8x 6029946
2x 6442314
1x 6453242
1x 6466206
1x 487121

1x 6245281
1x 6020193
1x 6247796
2x 6273627
1x 6301313
1x 6443197
1x 4187334
1x 6151225
2x 6253140
1x 4272665
2x 6435099
1x 6400649
1x 6182261
1x 243128

5x 6138624
1x 6400112
7x 6389695
2x 6294357
3x 6293826
2x 6442978
1x 6340682
1x 6412881
1x 6100562
1x 6290571
1x 6442979

5x 6209692
4x 6190251
1x 6332867
1x 6133859
1x 6325515
4x 6210210
1x 6271826
3x 6212989

7x 4220634
2x 6092766
2x 6334046
1x 6308234
8x 6411328
4x 6442920
1x 6167465
1x 6345302



[LEGO.com/service](https://www.LEGO.com/service)

YOU COULD **WIN**



Scan this QR code or go to **LEGO.COM/PRODUCTFEEDBACK** and give us your short feedback about this LEGO® set for a chance to win a cool LEGO prize.

Terms and Conditions apply*

EN: YOU COULD WIN. Terms and Conditions apply* **DE: Du könntest GEWINNEN.** Es gelten die Teilnahmebedingungen* **FR: Tu pourrais GAGNER.** Des conditions s'appliquent* **IT: Potresti VINCERE tu.** Termini e condizioni sono applicabili* **ES: Puedes GANAR.** Aplican términos y condiciones* **PT: Poderá GANHAR.** Aplicam-se termos e condições* **ZH: 轻松获奖. 条款和条件适用*** **PL: Szansa na WYGRANĄ.** Obowiązują warunki korzystania* **CS: Máte šanci VYHRÁT.** Platí všeobecné smluvní podmínky* **SK: Máte šancu VYHRAŤ.** Platia všeobecné zmluvné podmienky* **HU: TE IS NYERHETSZ.** Felhasználási feltételek érvényesek* **RO: Ai putea CÂȘTIGA.** Se aplică termeni și condiții* **BG: Можете да СПЕЧЕЛИТЕ.** Има определени правила и условия* **LV: Tu vari LAIMĒT.** Ir spēkā noteikumi un nosacījumi.* **ET: Sul on võimalus VÕITA.** Kehtivad tingimused* **LT: Jūs galite LAIMĖTI.** Taikomos sąlygos*

*[LEGO.com/productfeedback-terms](https://www.lego.com/productfeedback-terms)

LEGO and the LEGO logo are trademarks of the/son des marques de commerce du/son marcas registradas de LEGO Group. ©2023 The LEGO Group. ©SEGA. All rights reserved. SEGA is registered in the U.S. Patent and Trademark Office. SEGA and SONIC THE HEDGEHOG are either registered trademarks or trademarks of SEGA CORPORATION.