

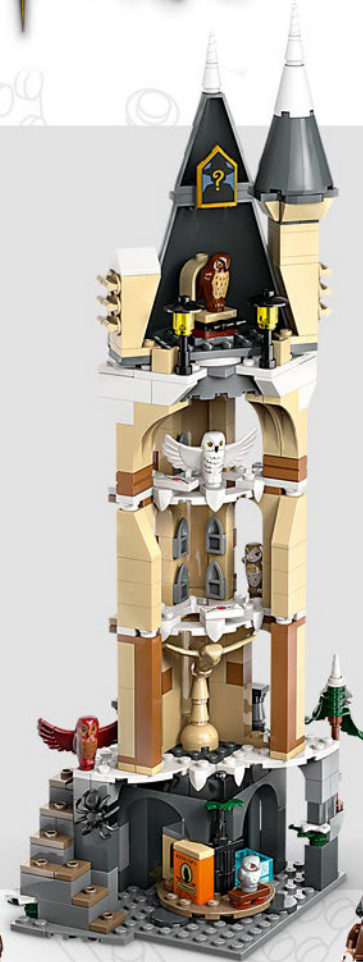

Harry Potter



76430



LEGO® Builder



LEGO.com/sustainable-packaging



FR
DONNEZ
OU
RECYCLEZ



OU



OU



ASSOCIATION

MAGASIN

DÉCHÈTERIE

Adresses sur quefairedemesdechets.fr

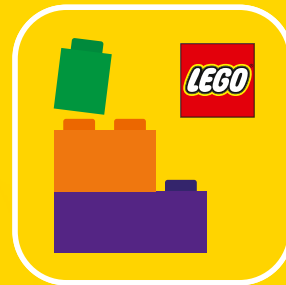

🔍 LEGO® Builder

BUILDER

Download on the
App Store

GET IT ON
Google Play

腾讯应用宝
安卓应用商店

Apple and the Apple logo are trademarks of Apple Inc., registered in the U.S. and other countries and regions. App Store is a service mark of Apple Inc. Google Play and the Google Play logo are trademarks of Google LLC. Tencent and the Tencent logo are trademarks of Tencent Inc.

🔍 LEGO.com/devicecheck

EN Ask parents' permission before going online | DE Eltern um Erlaubnis bitten, bevor du online gehst | FR Demande l'autorisation d'un parent avant d'aller en ligne | IT Chiedi il permesso ai tuoi genitori prima di andare online | ES Pídeles permiso a tus papás antes de conectarte a Internet | PT Peça autorização aos pais antes de acederes online | ZH 上网前应先征得父母的同意 | PL Poproś rodziców o zgodę, zanim wejdiesz do Internetu | CS Než půjdeš na internet, požádej rodiče o svolení | SK Skôr než pôjdeš na internet, vypýtaj si povolenie od rodičov | HU Kérj szülői engedélyt, mielőtt online csatlakoznál! | RO Cere permisiunea părinților înainte de a te conecta online | BG Поискайте разрешение от родител, преди да влезете онлайн | LV Pirms došanās tiešsaistē palūdz atļauju vecākiem | ET Enne Interneti kasutamist küsi vanematelt luba | LT Prieš prisijungdami prie interneto, atsklauskite tėvų

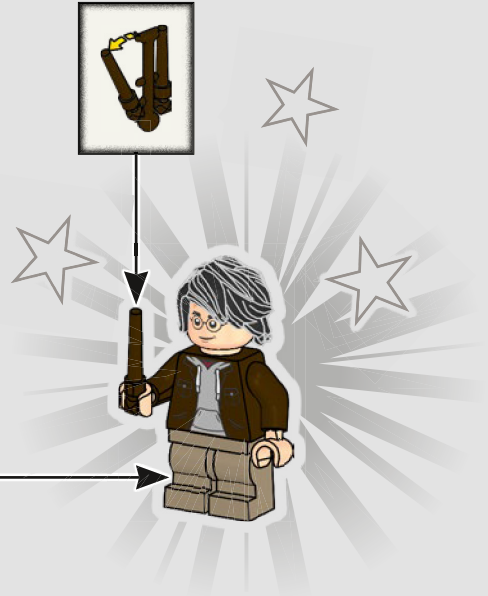
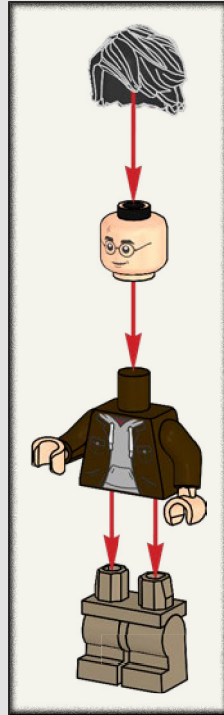

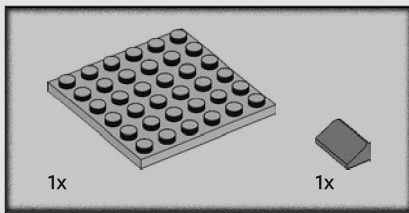

1

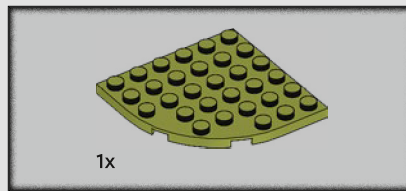
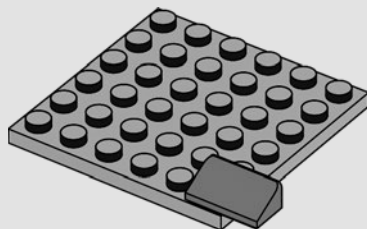

2

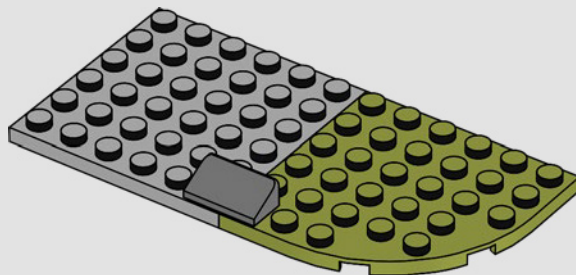

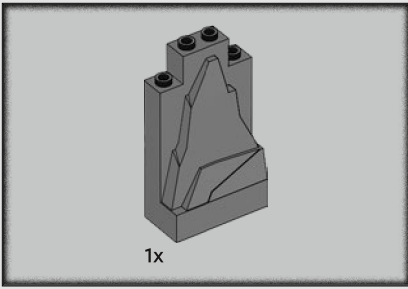

3

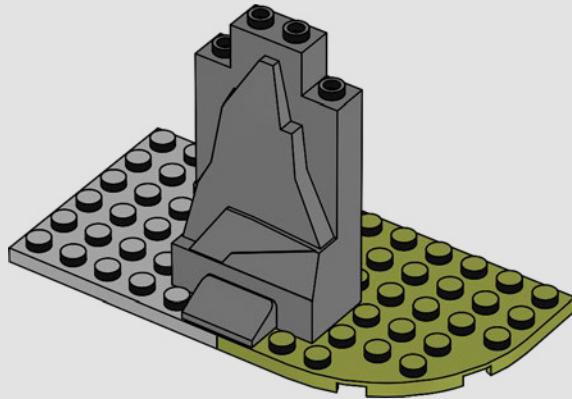



4

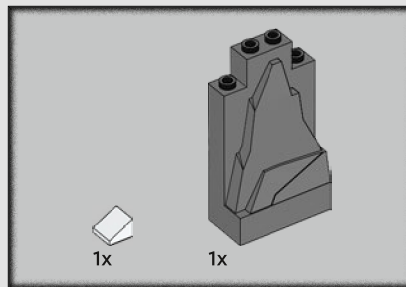
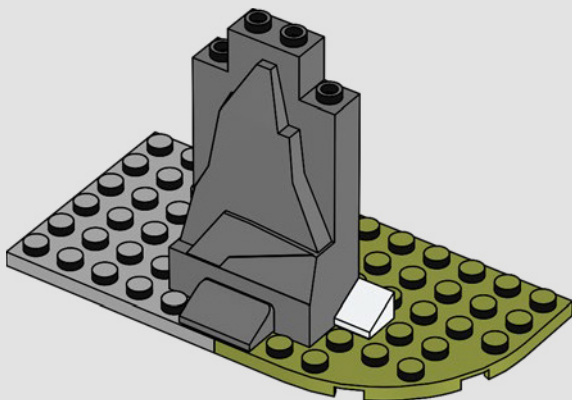

5

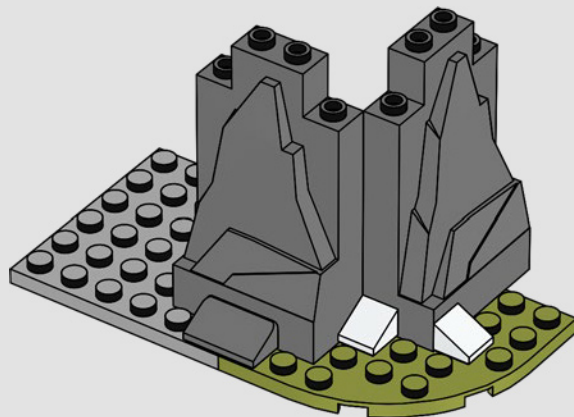

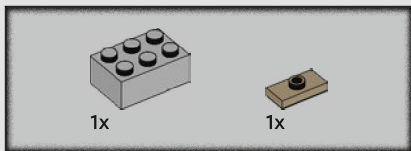

6

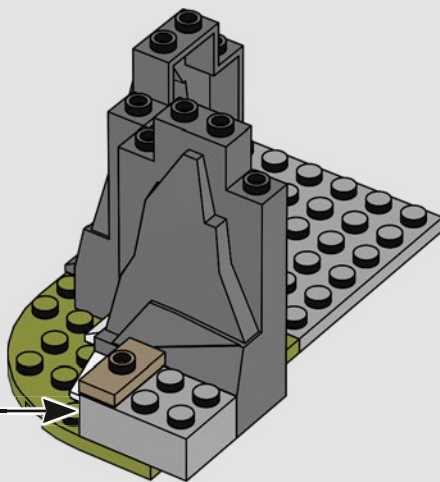
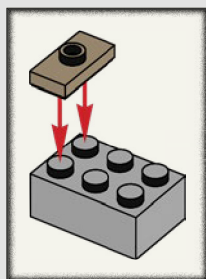

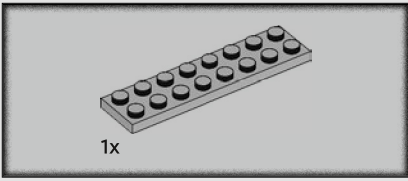

7

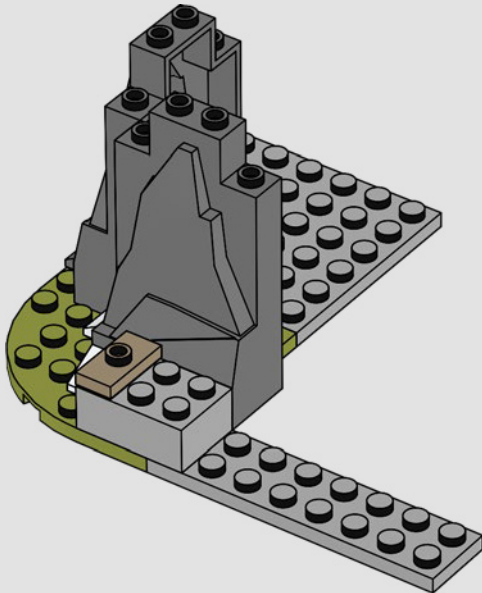

8

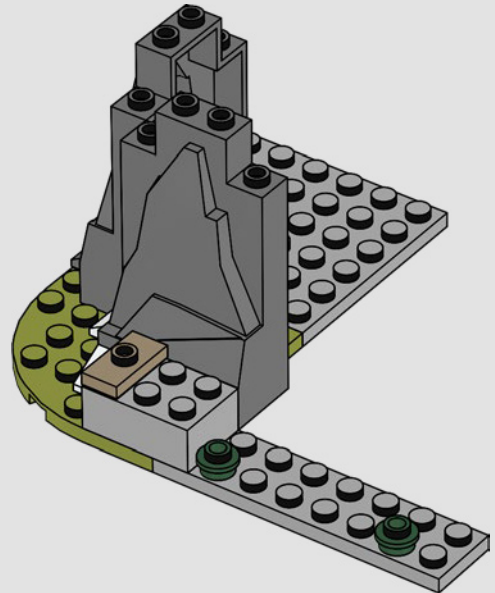

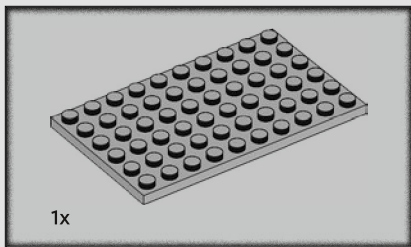

9

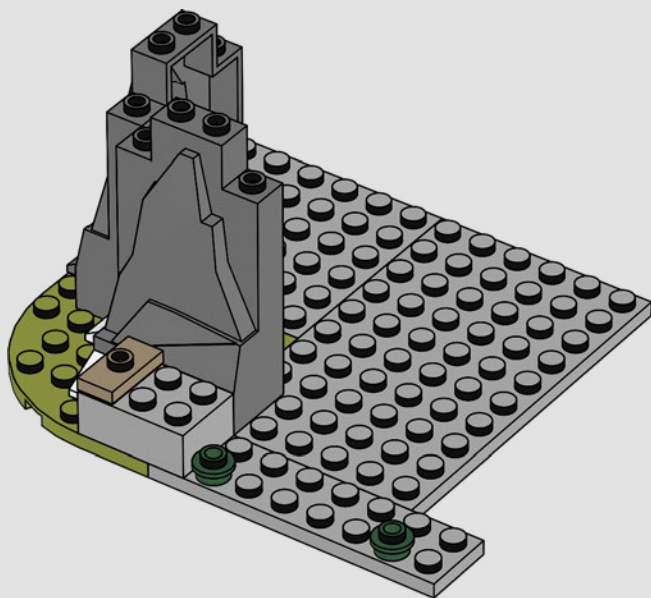

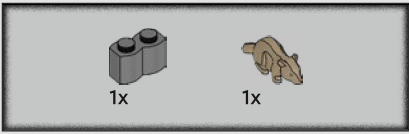

10

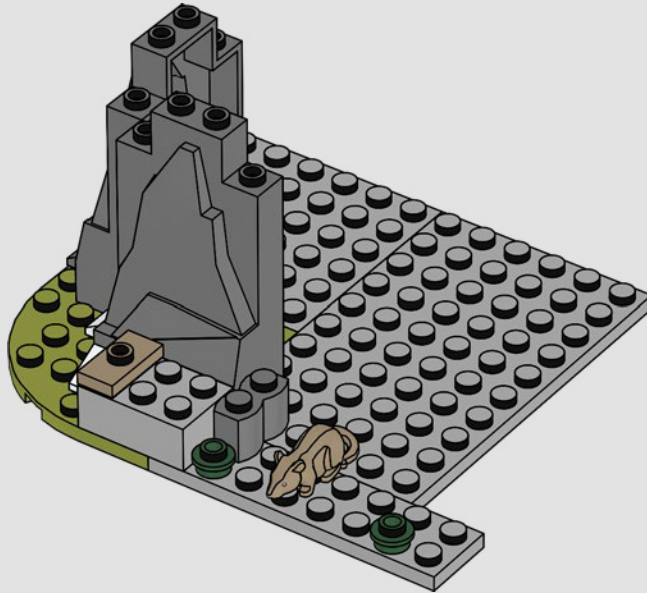

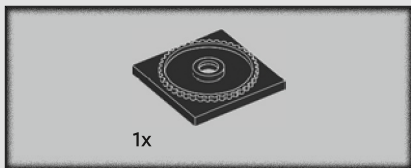

11



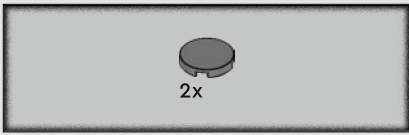

12



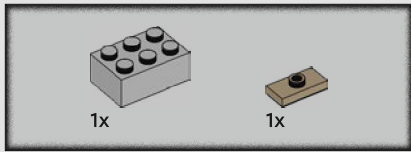

13

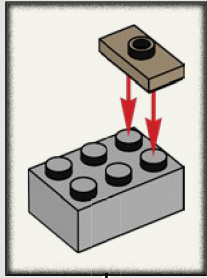

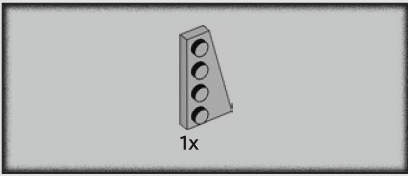

14

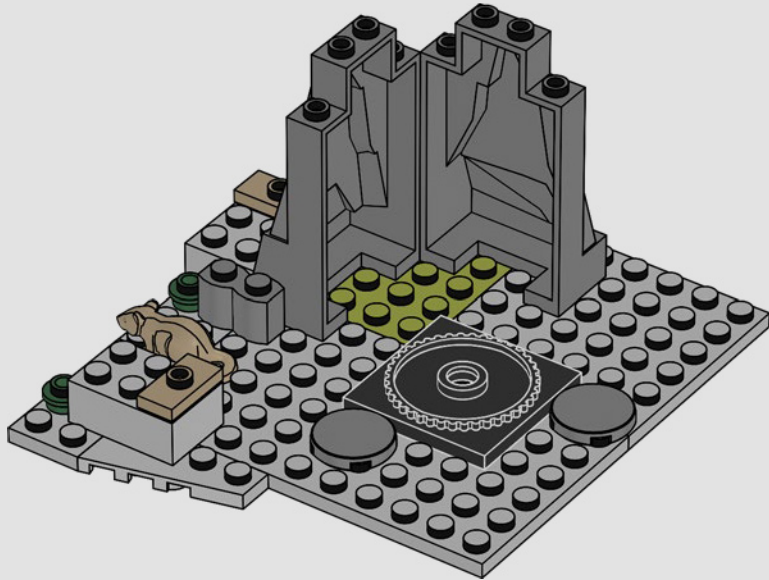

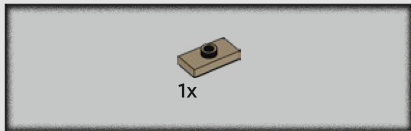

15

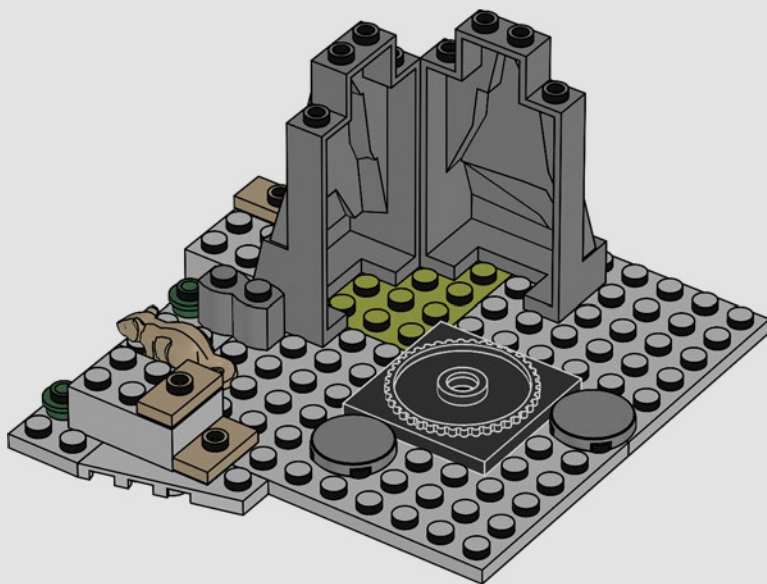

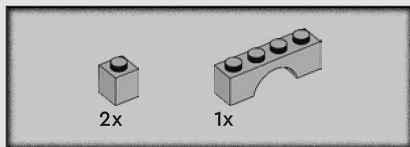

16

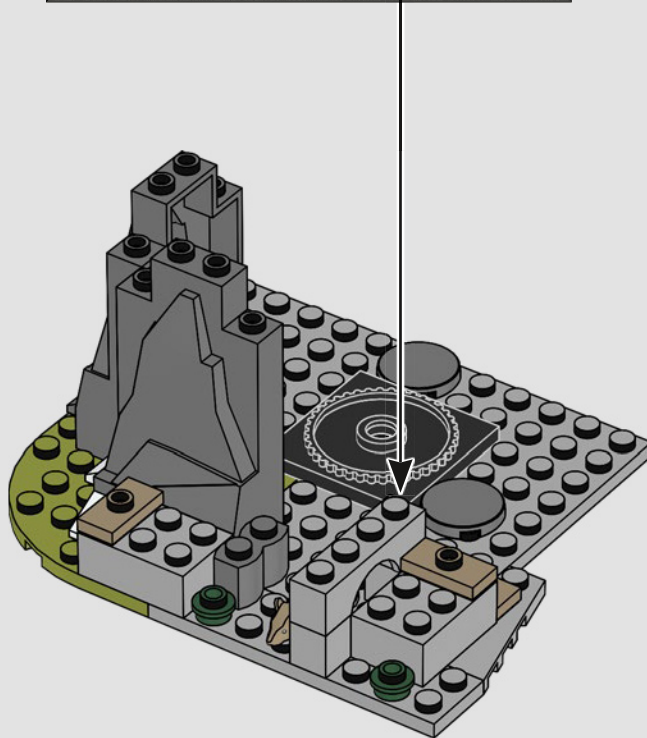
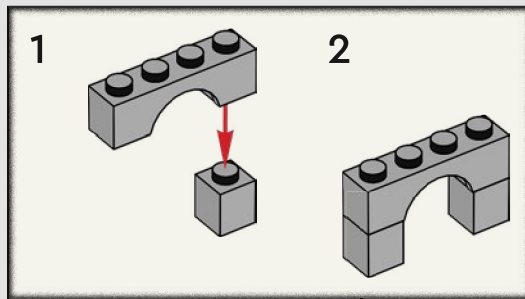



17

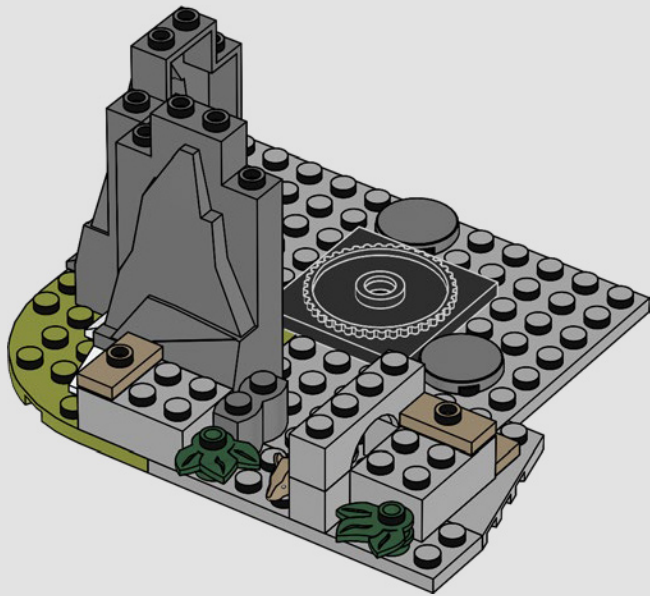



2x

18

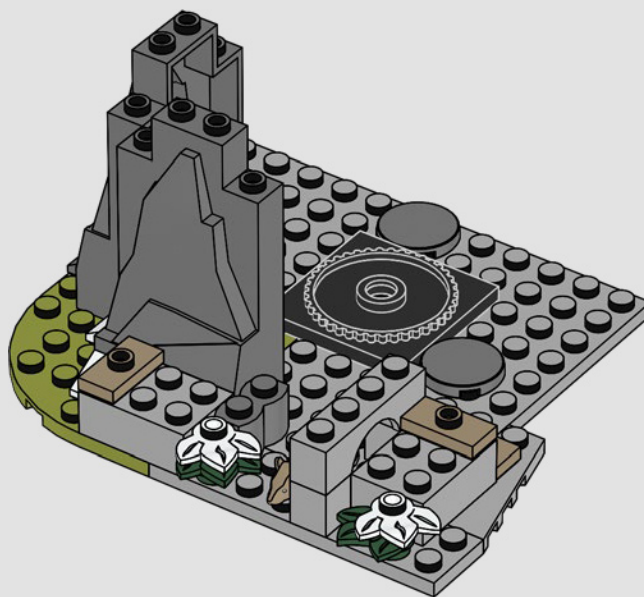

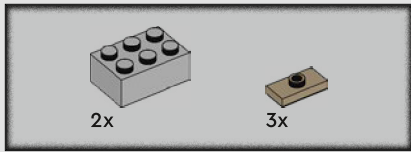

19

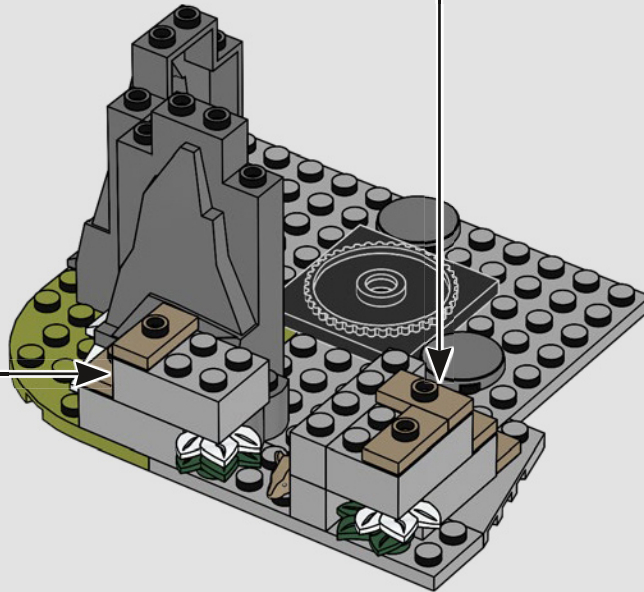
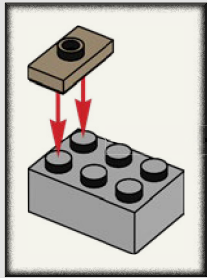
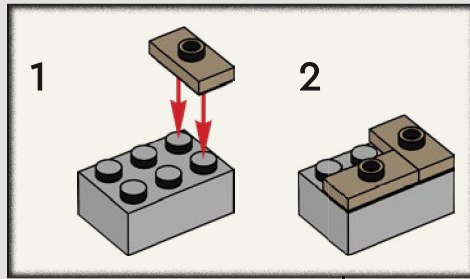

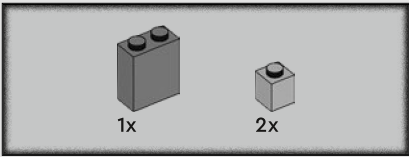

20

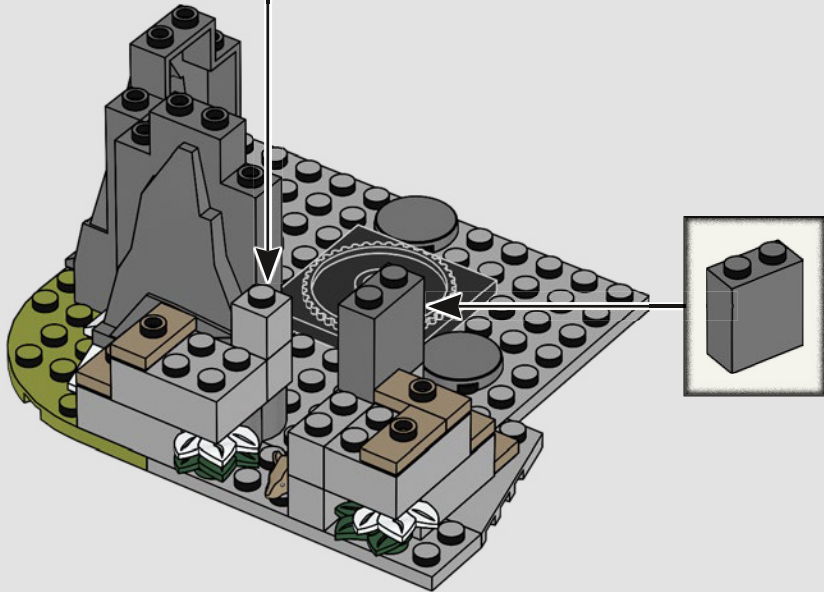
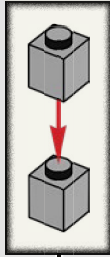

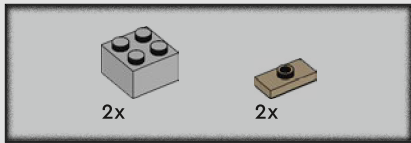

21

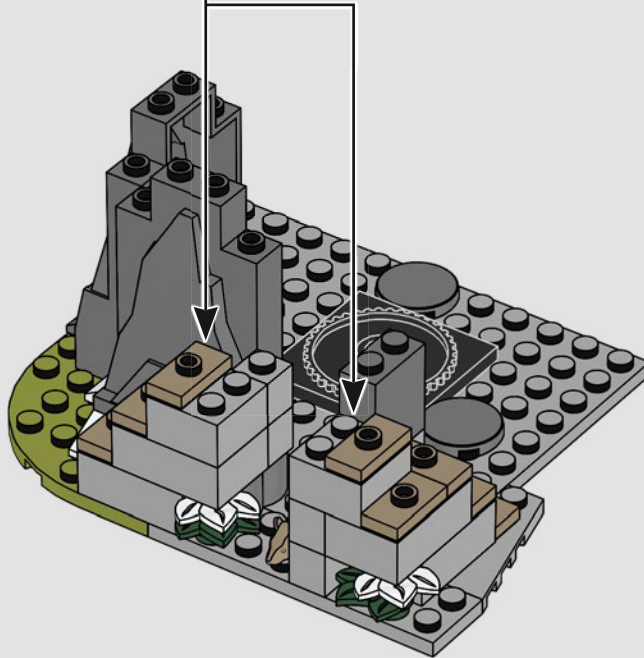
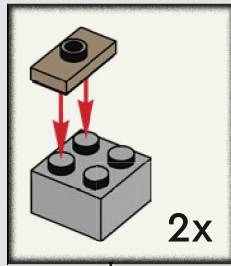

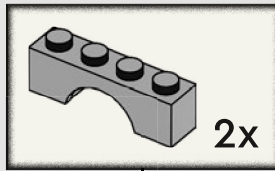
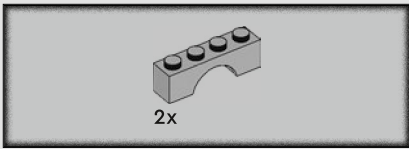

22

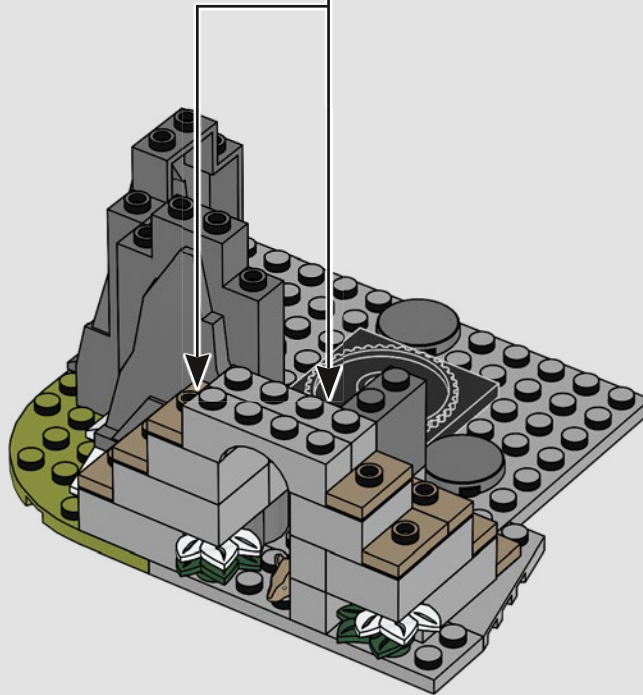

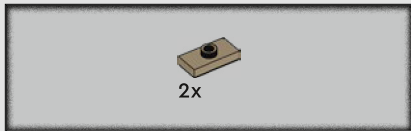

23

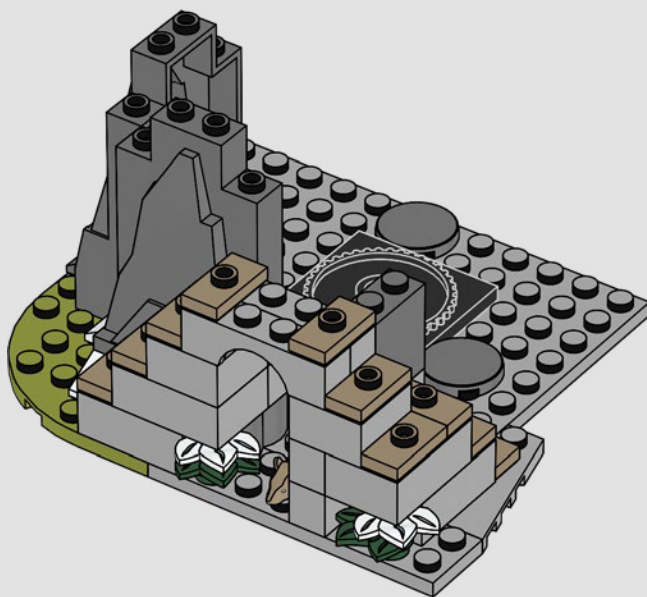

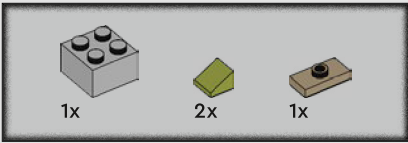

24

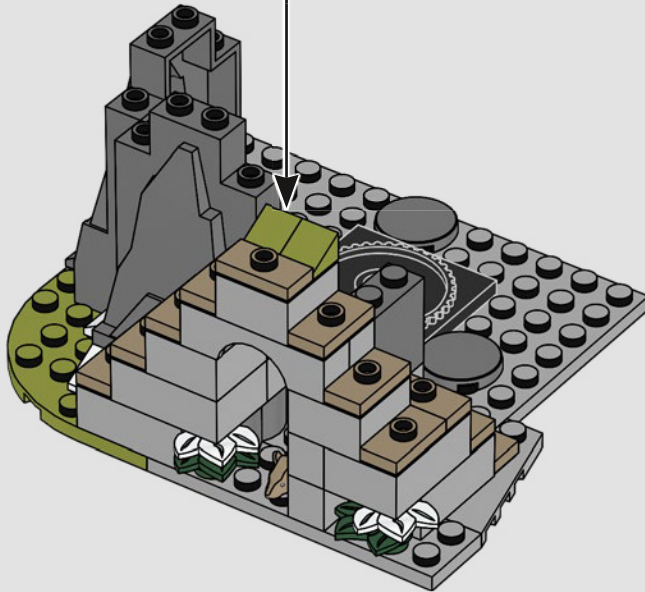
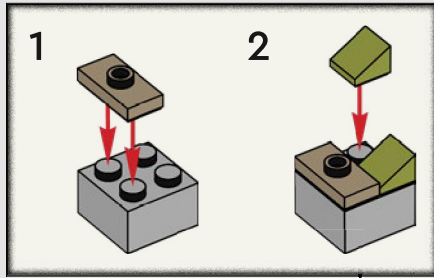

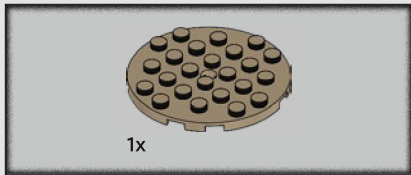

25

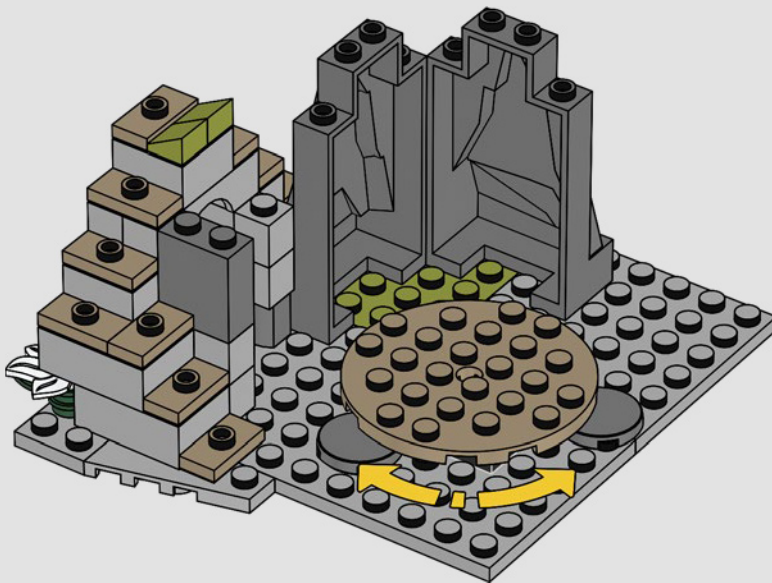

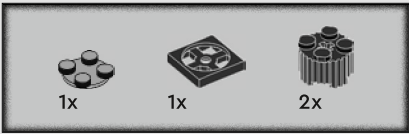

26

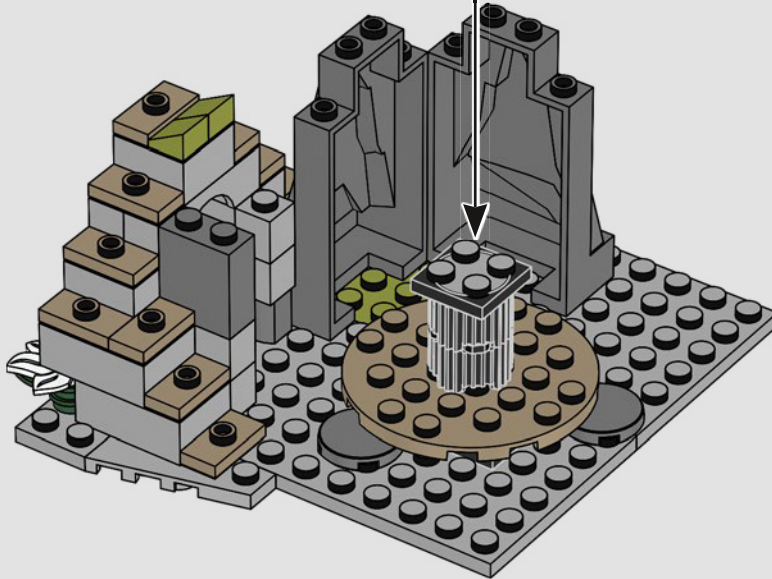
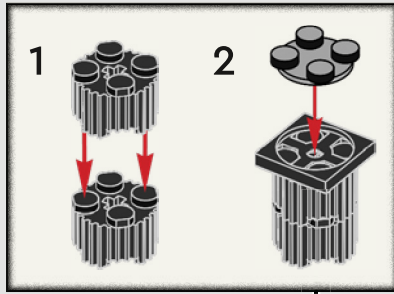

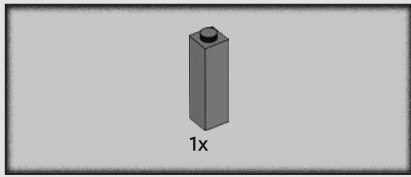

27

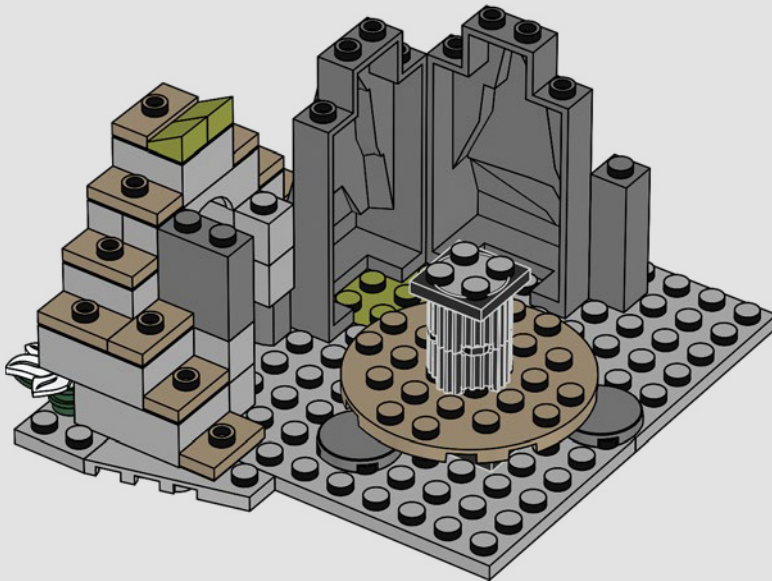

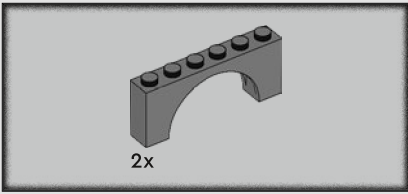

28

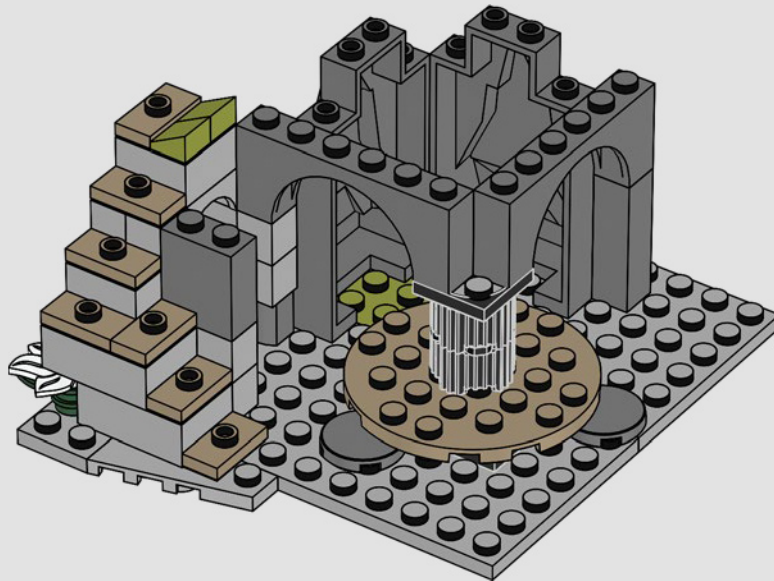

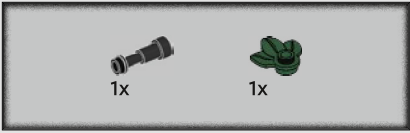

29

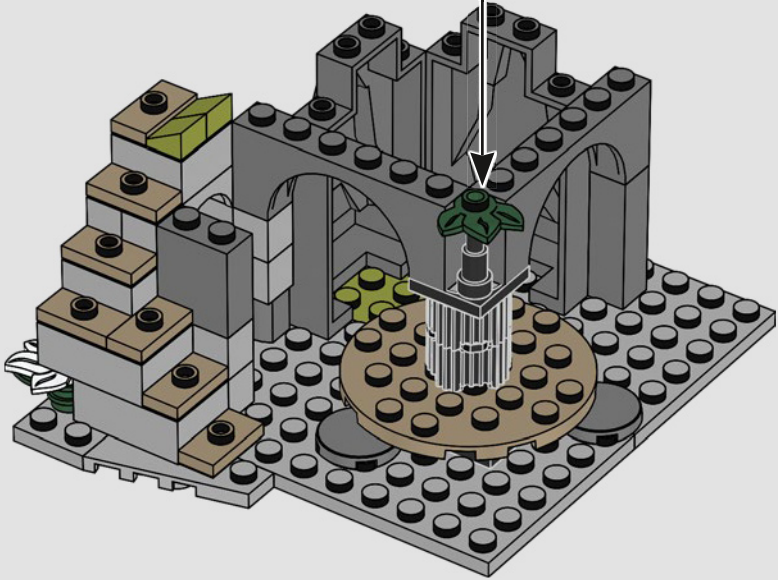
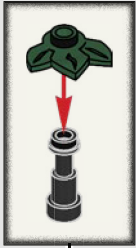

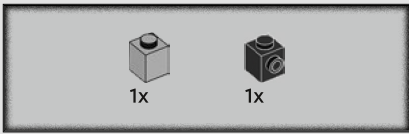

30

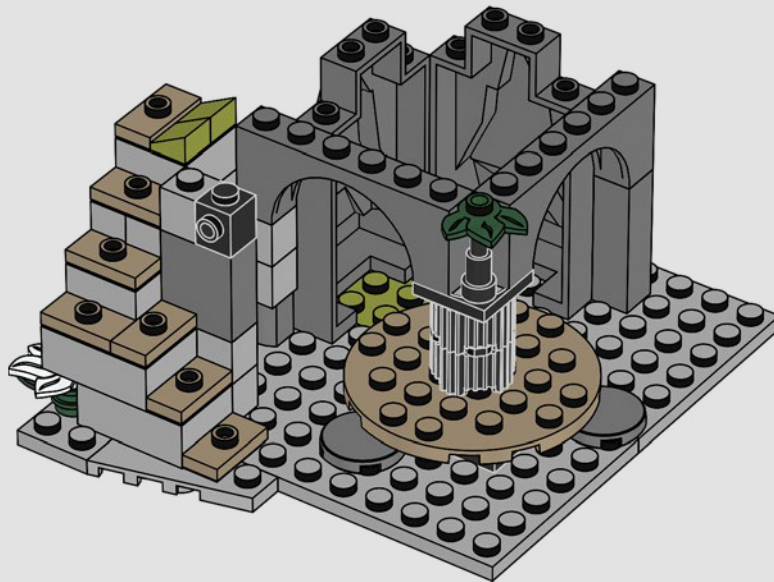

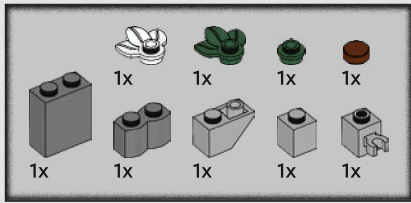

31

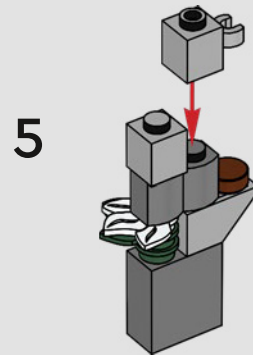
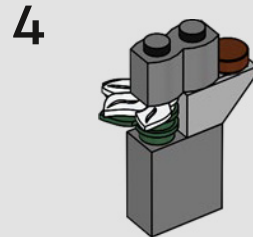
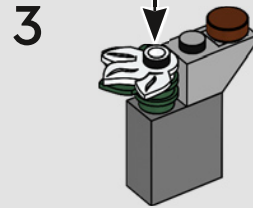
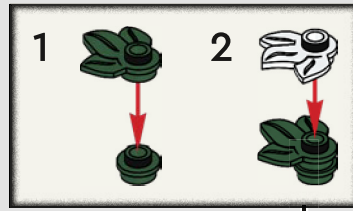
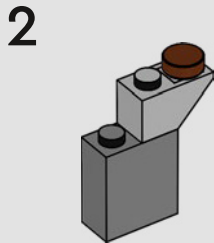
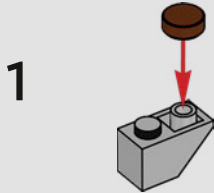

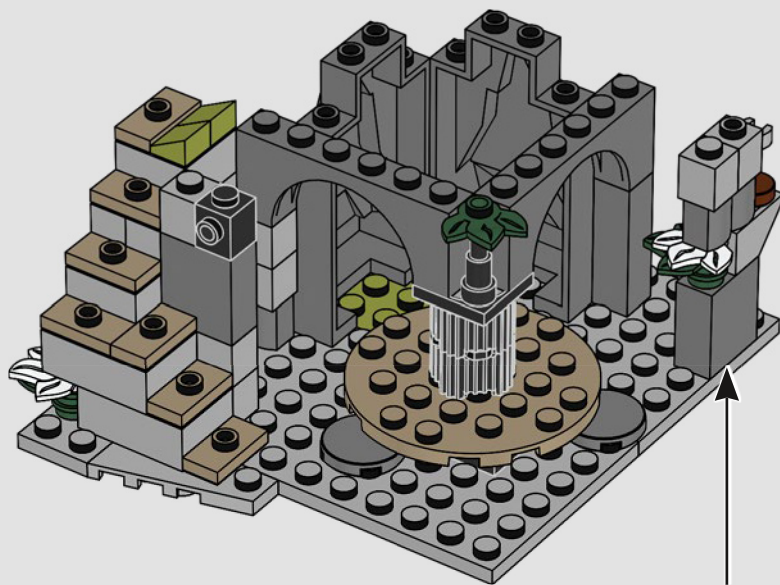

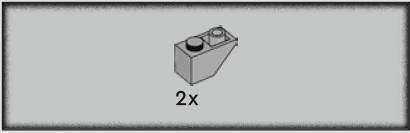

32



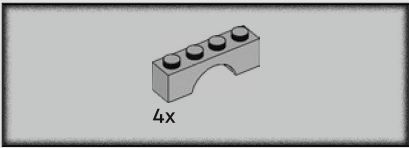

33

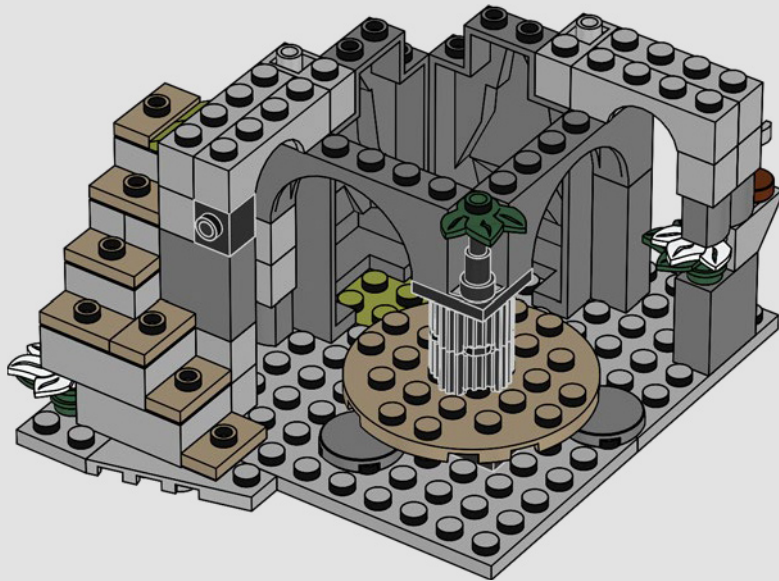

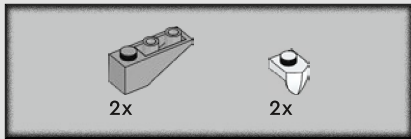

34

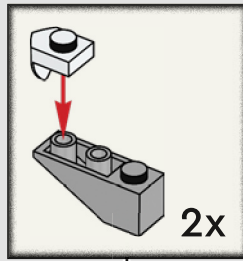

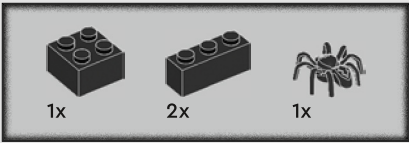

35

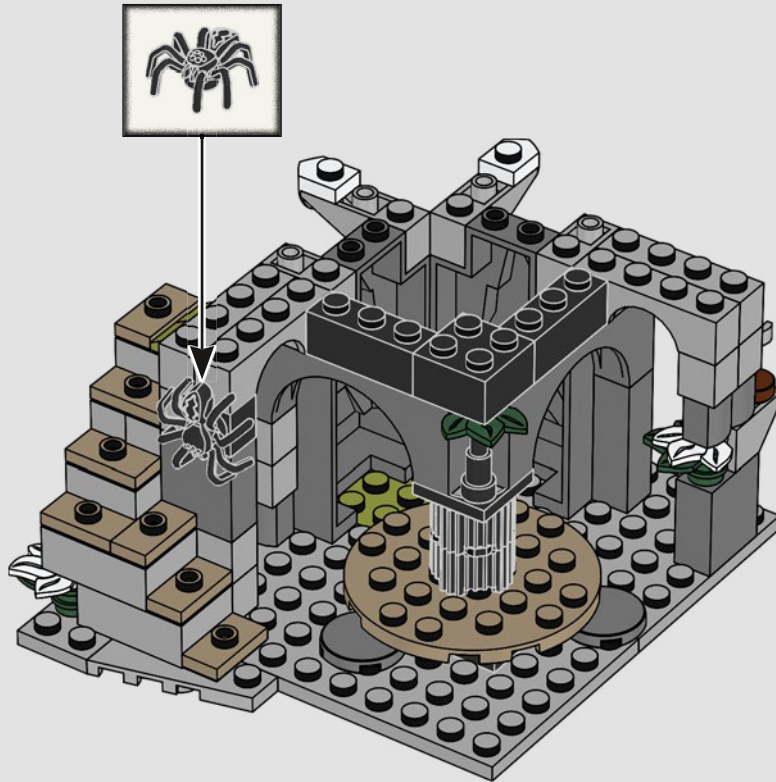

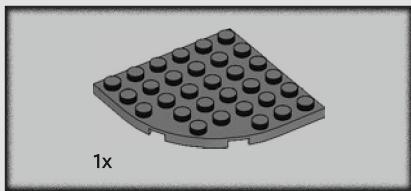

36



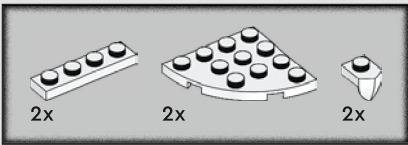

37

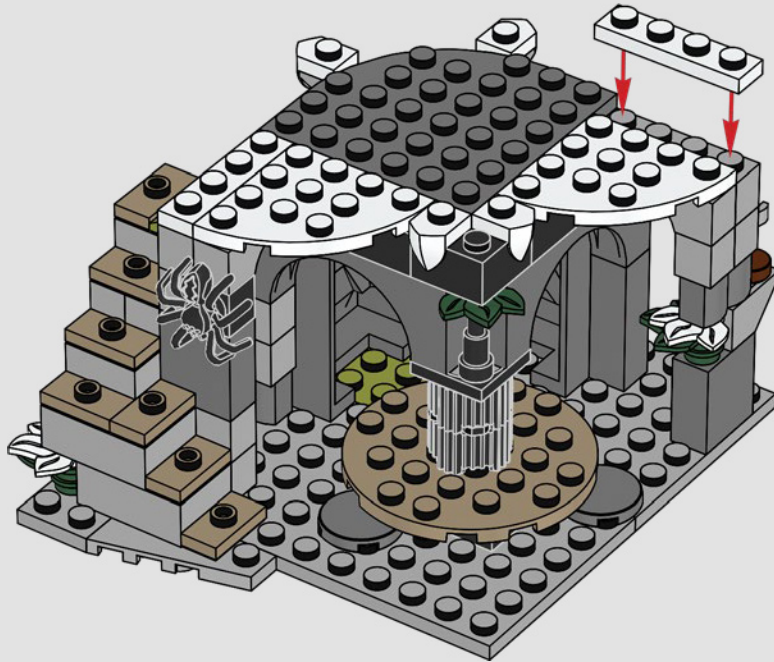

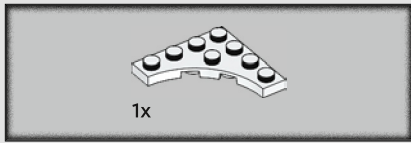

38

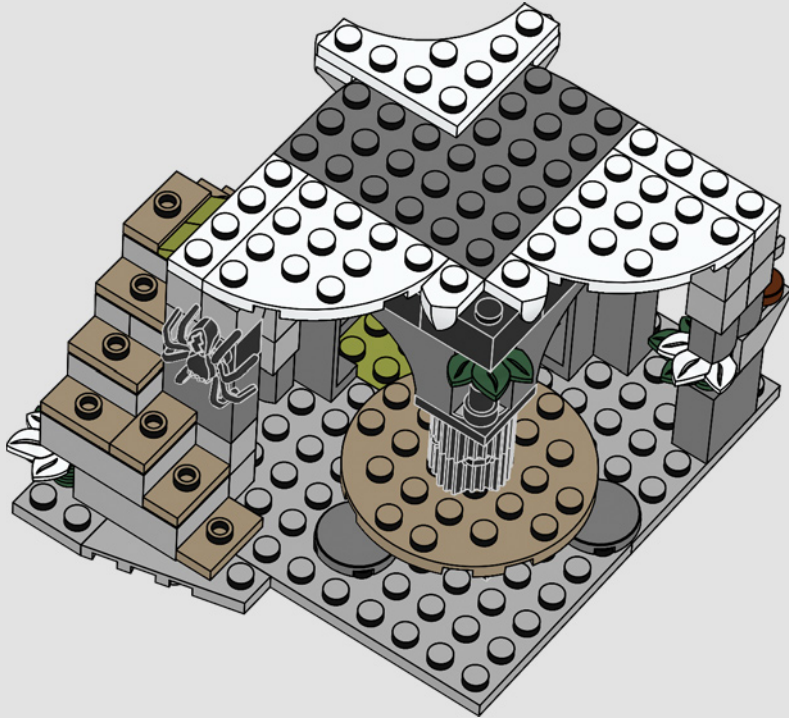

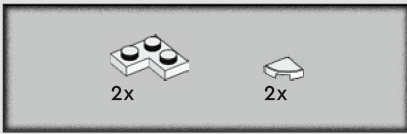

39

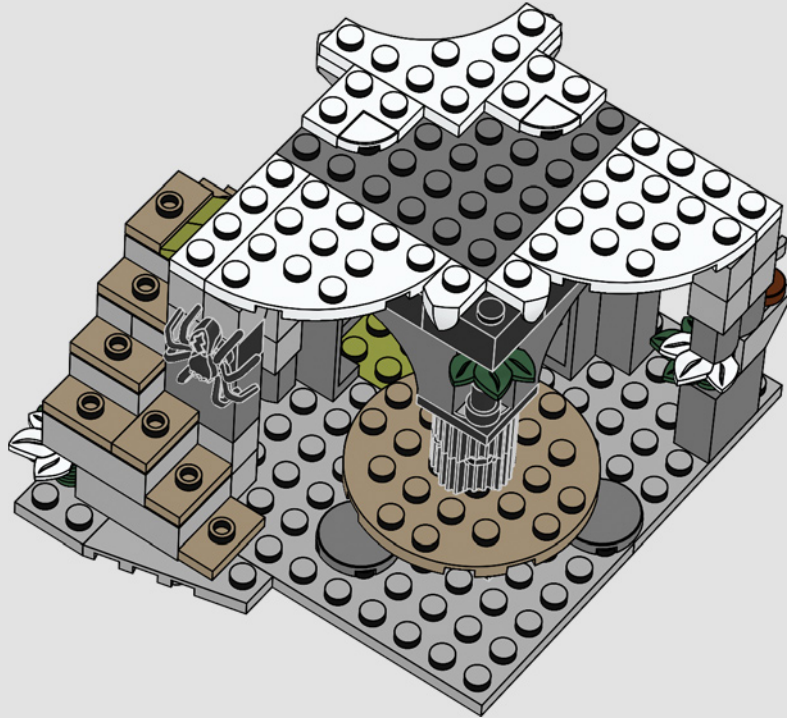



40

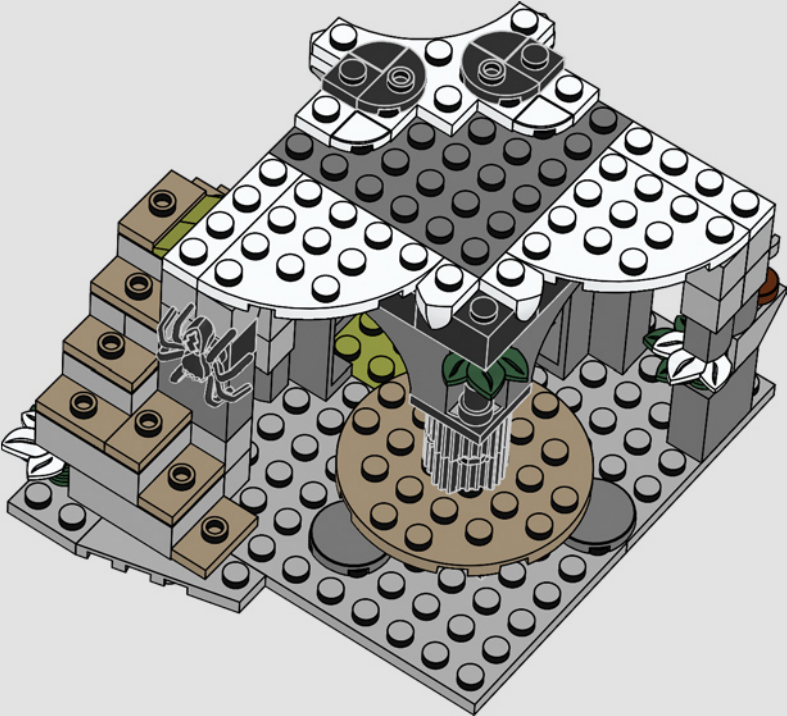



2x



1x

41

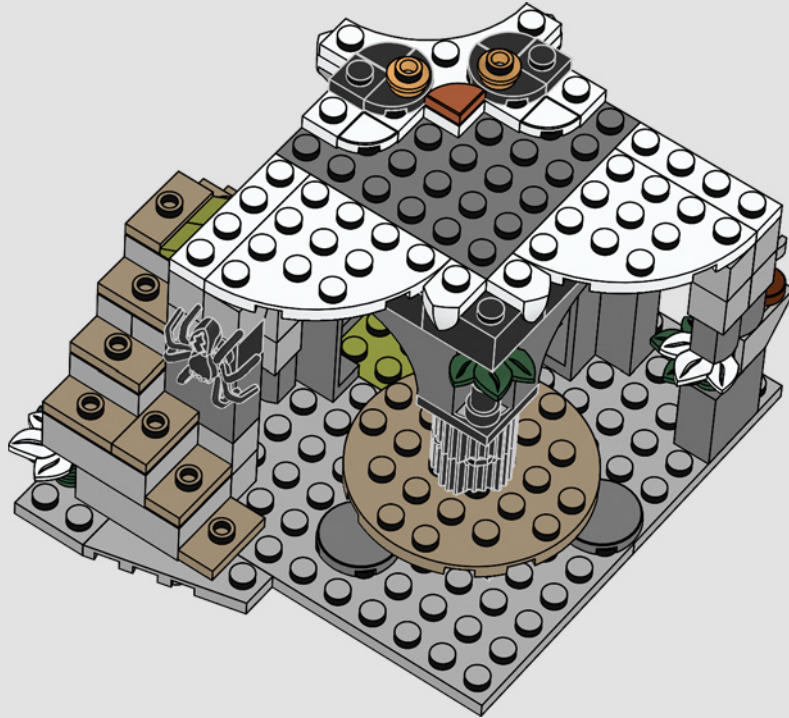



1

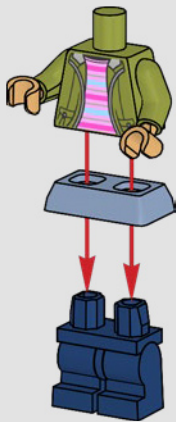

2

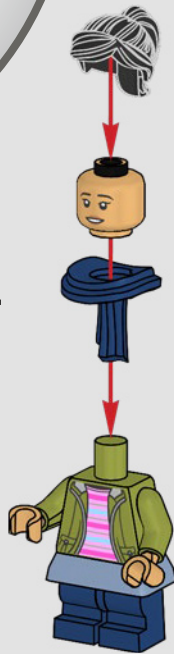

3



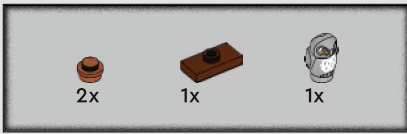

42

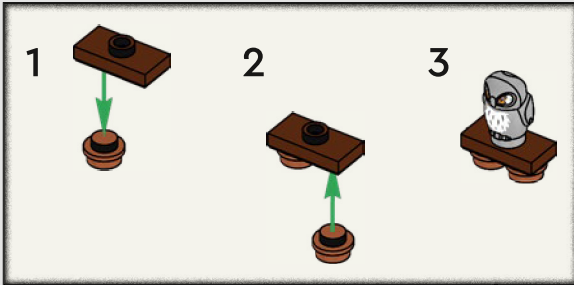



2x

43

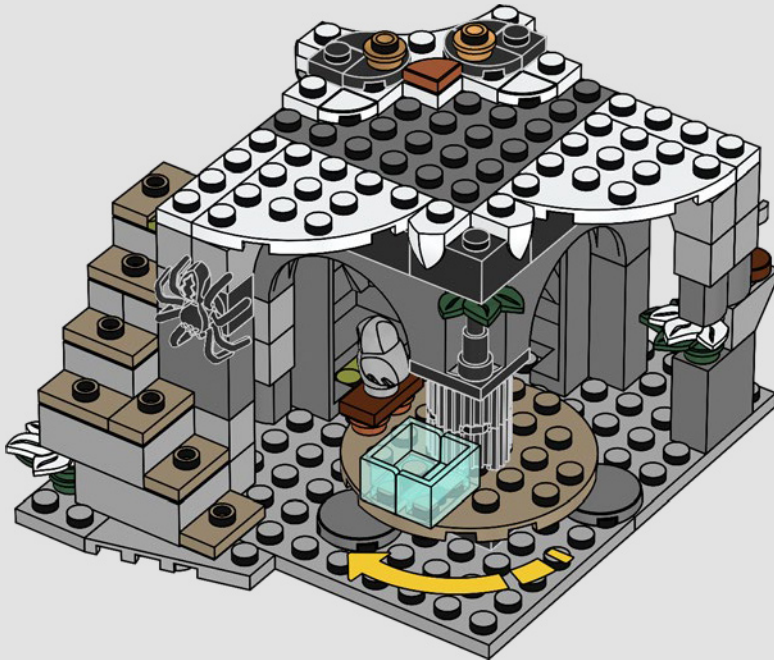

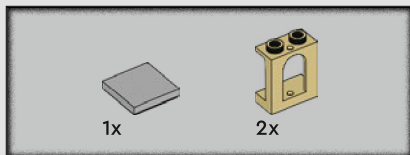

44

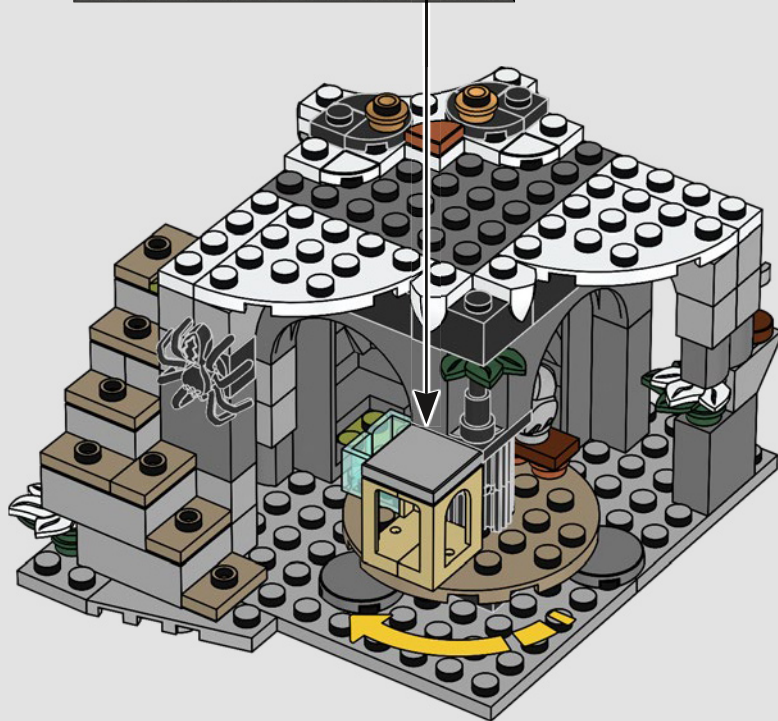
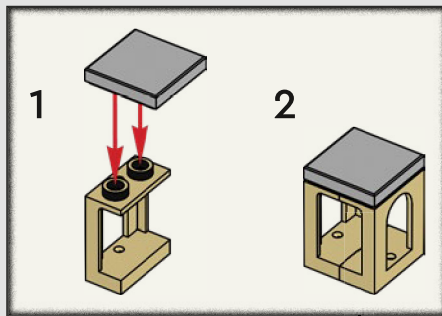

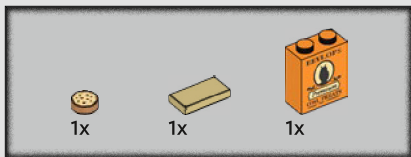

45

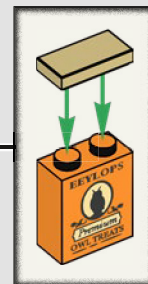
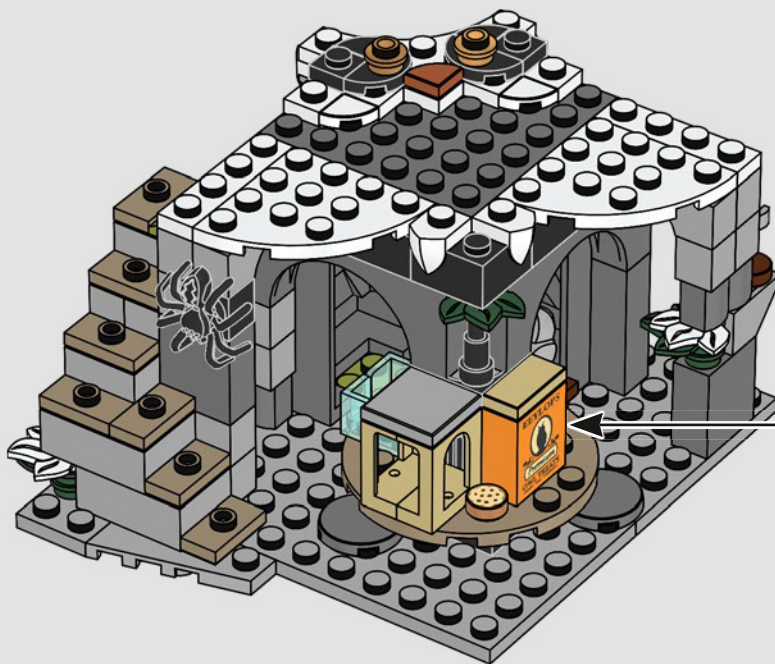

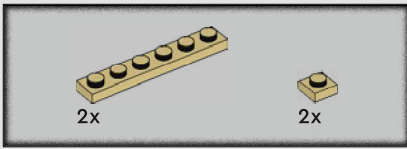

46

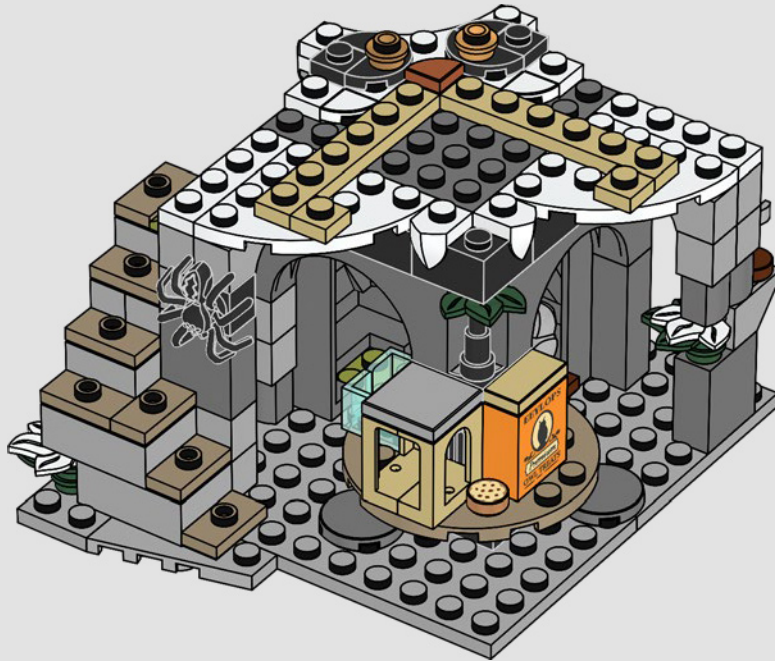



2x



2x

47

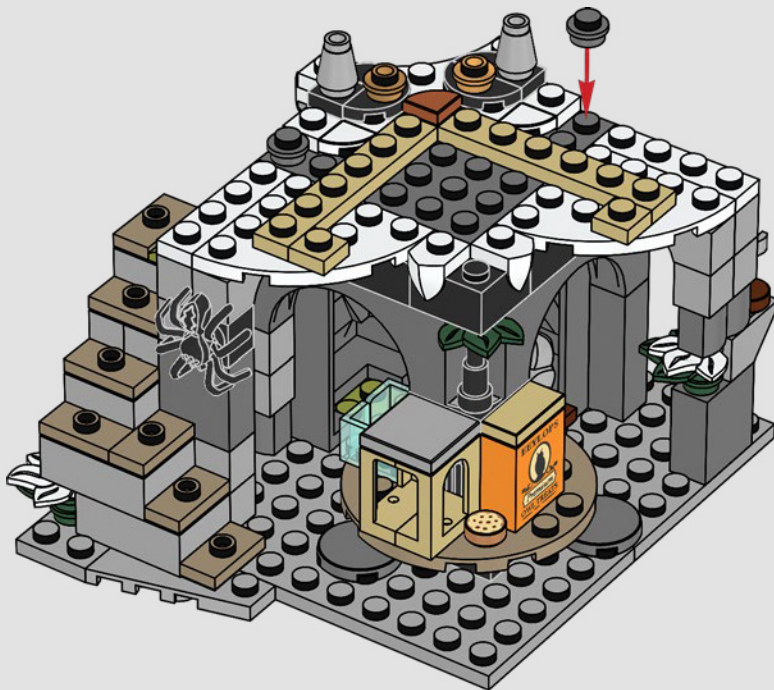

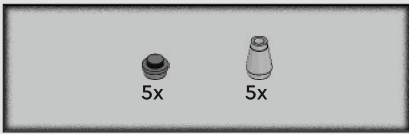

48

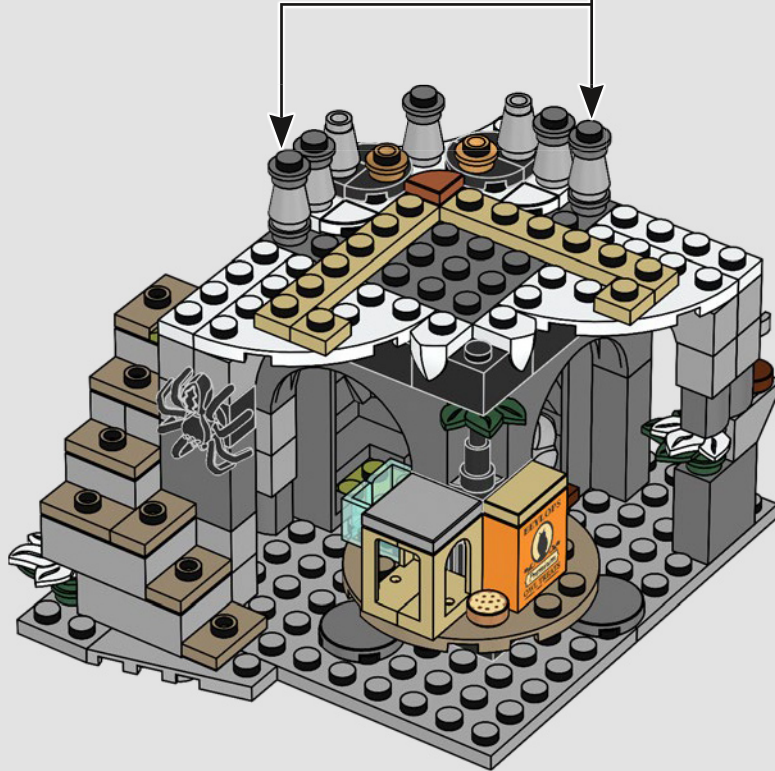
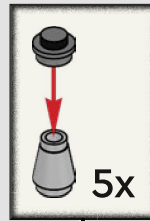

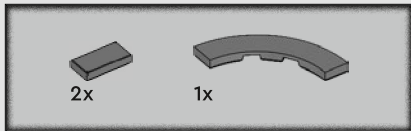

49

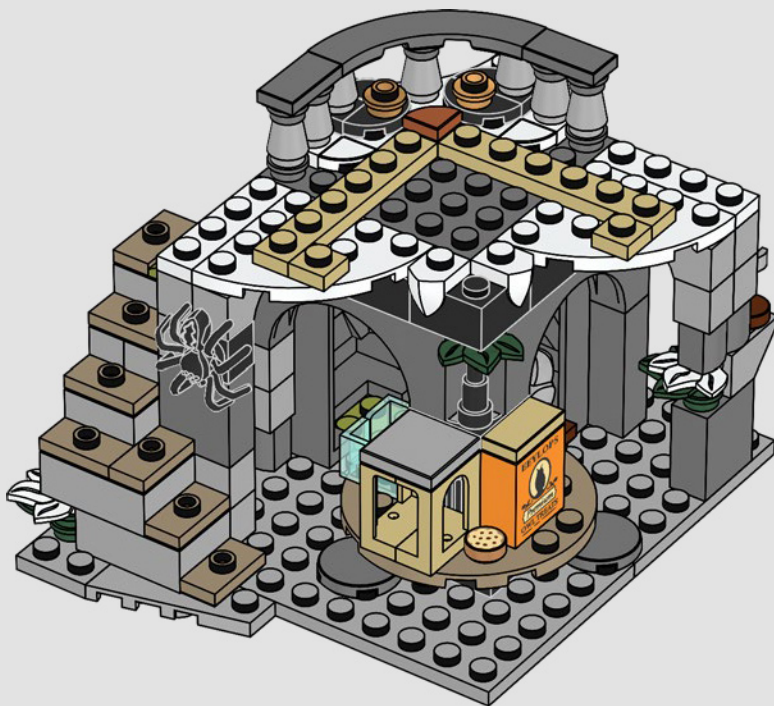

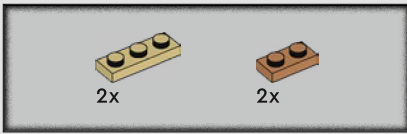

50





51

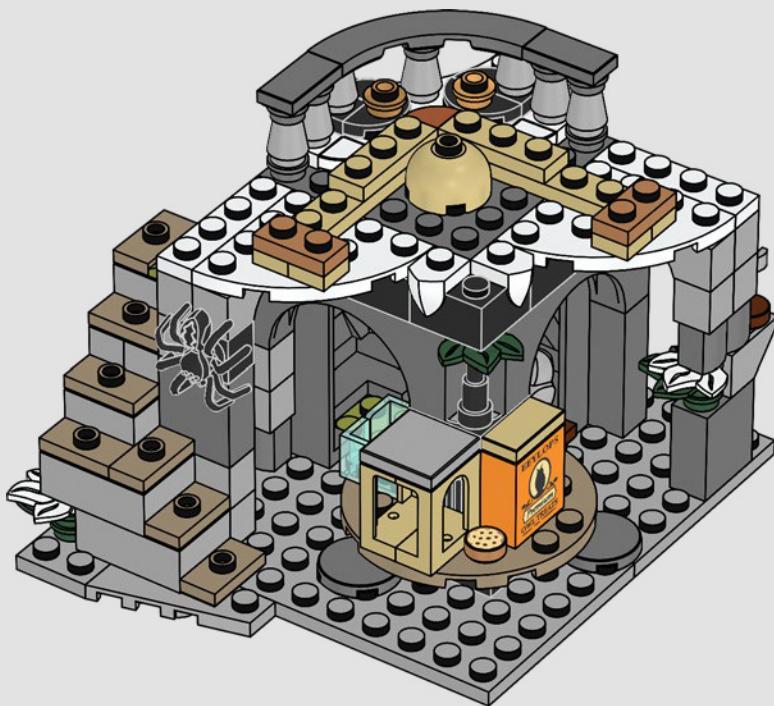

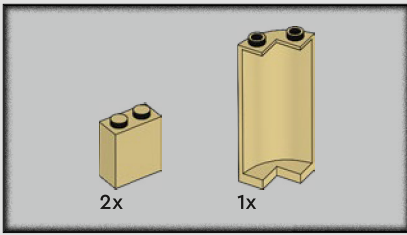

52

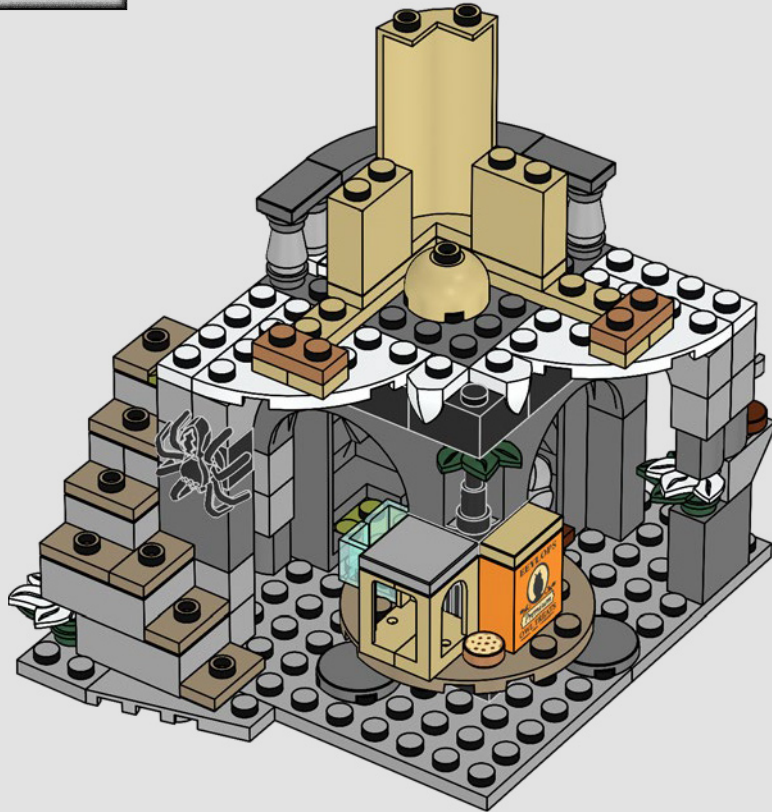



2x

53

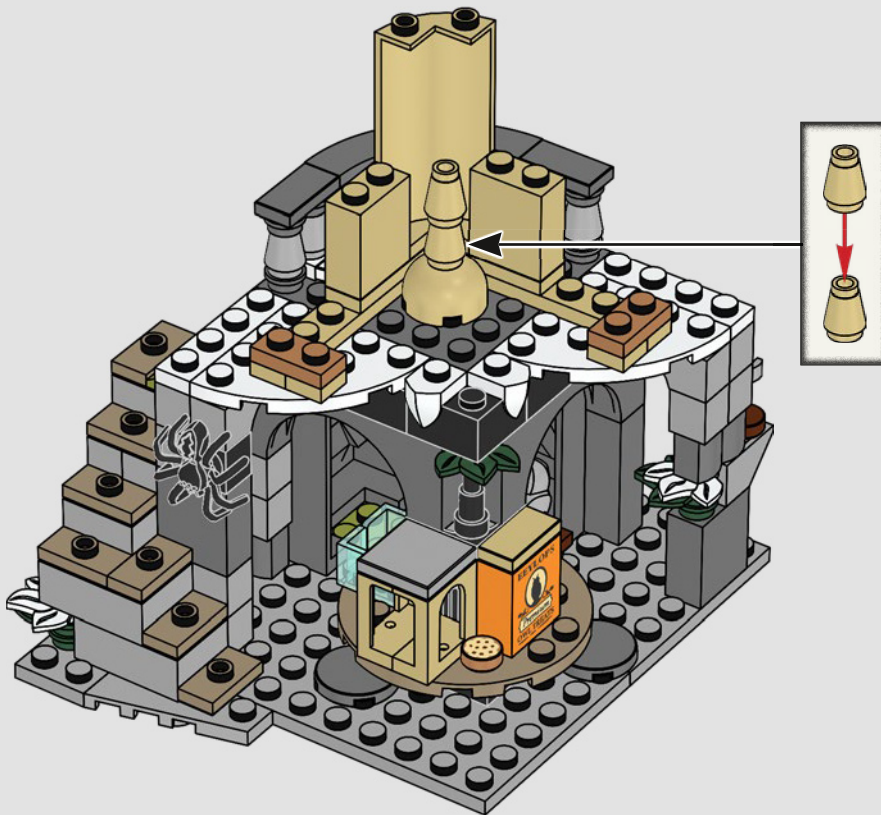

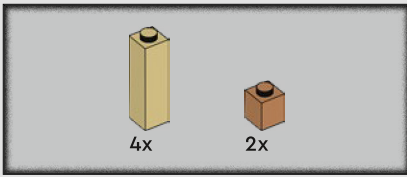

54

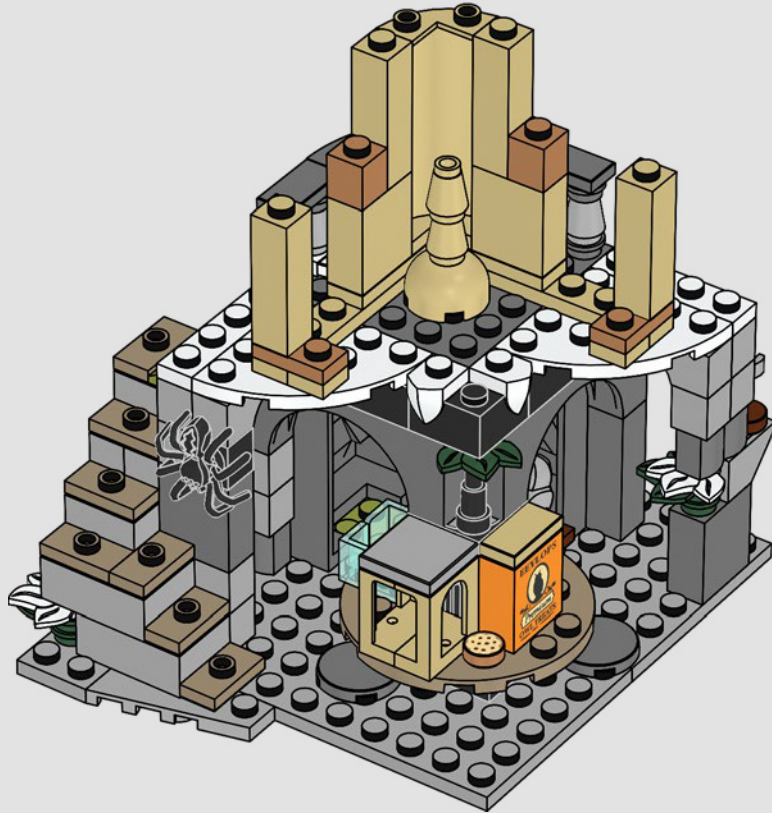

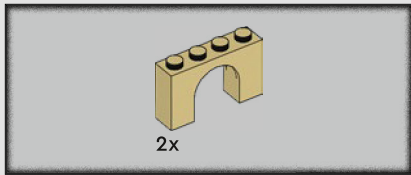

55

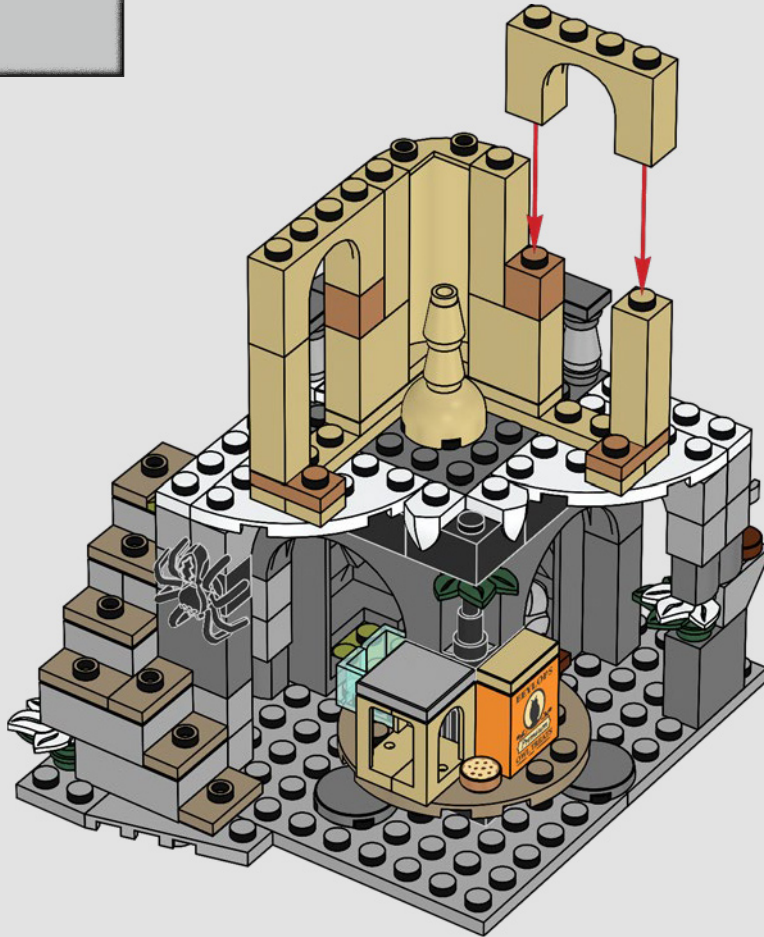

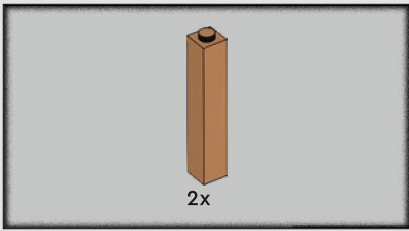

56

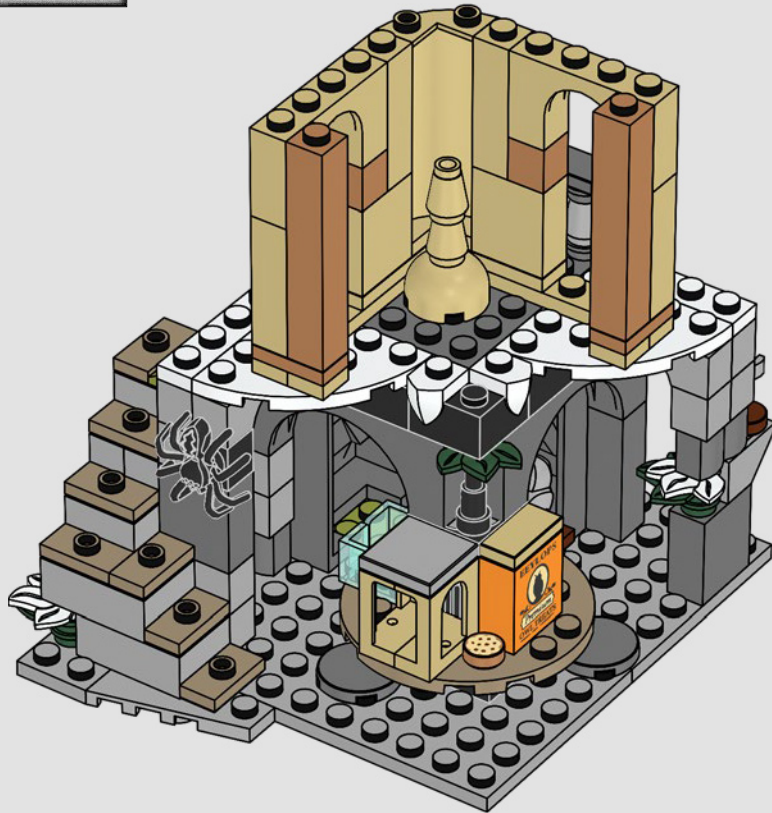

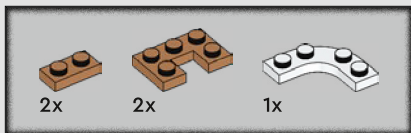

57

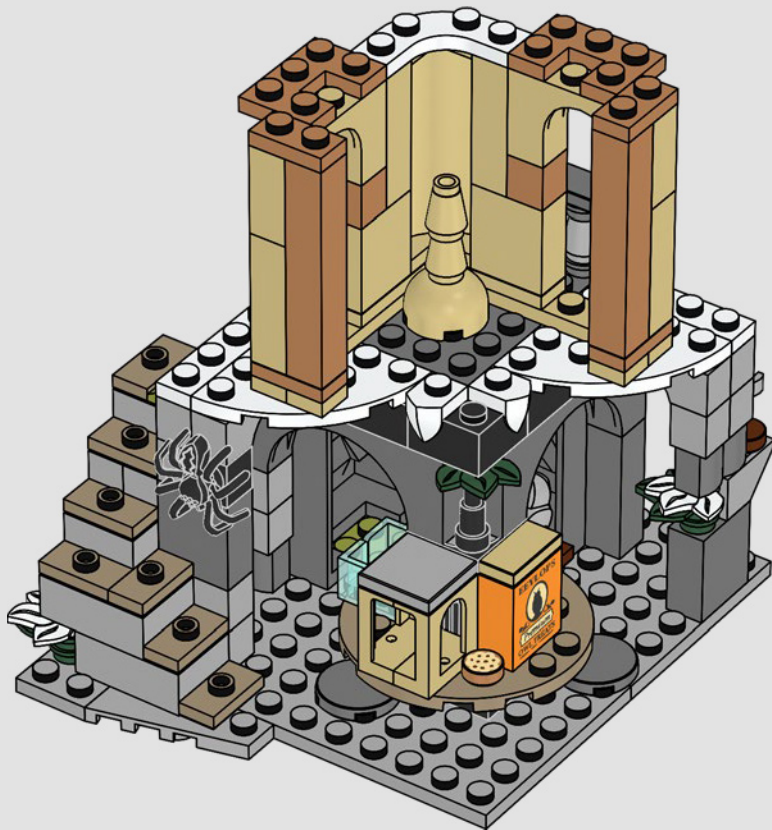

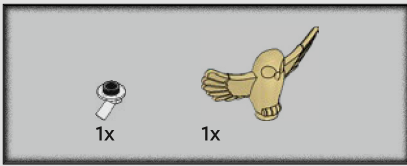

58

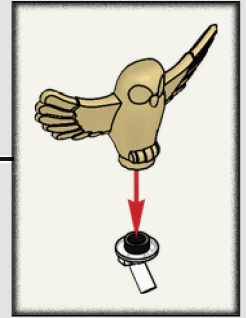
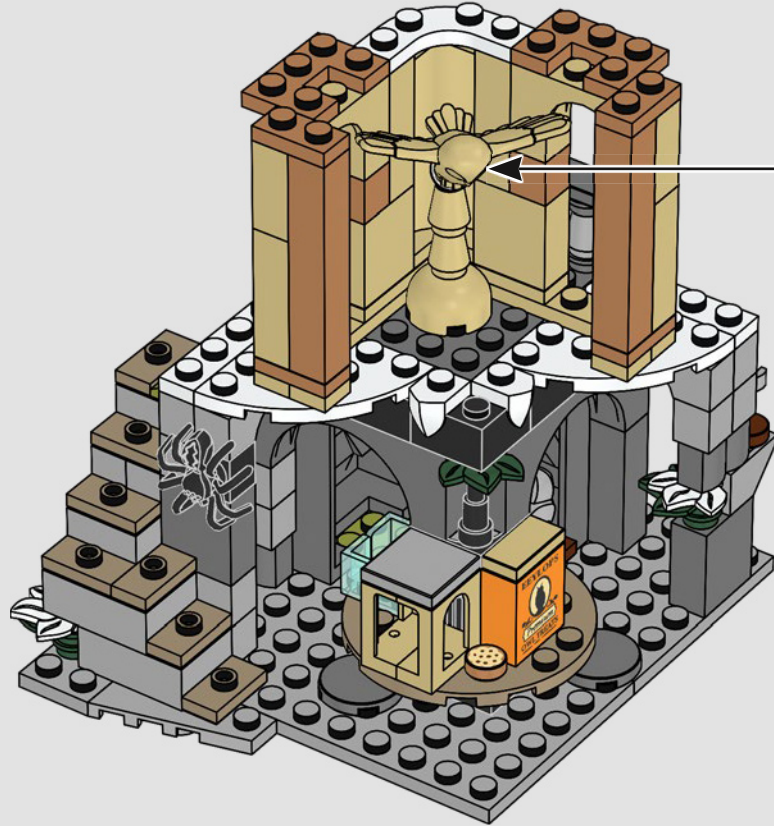

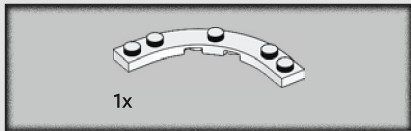

59

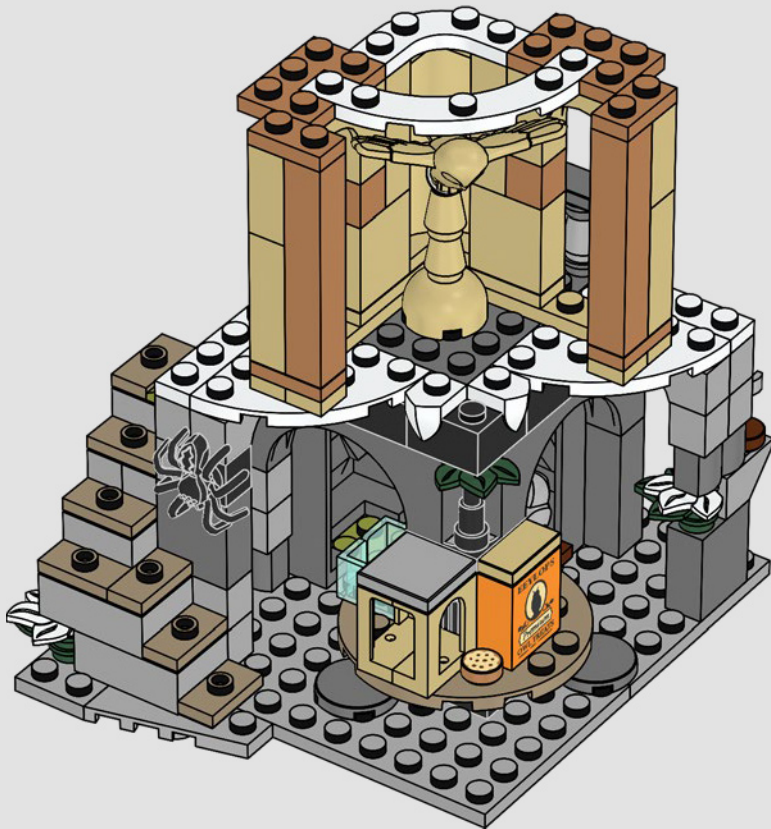

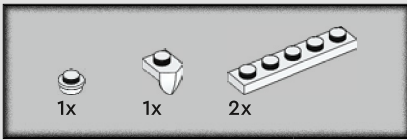

60

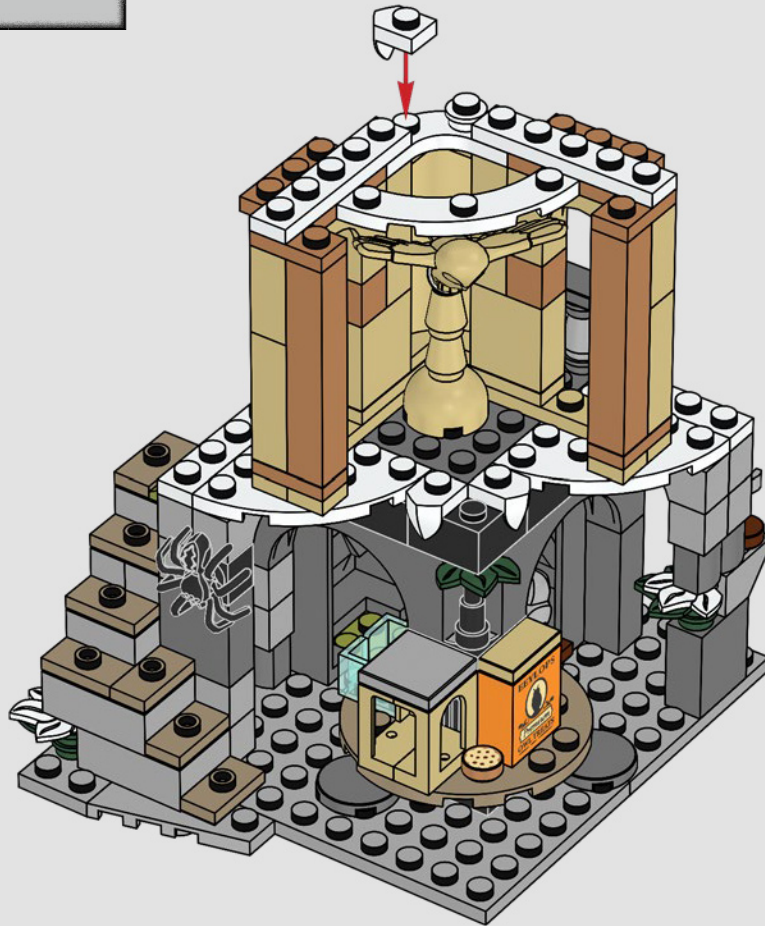

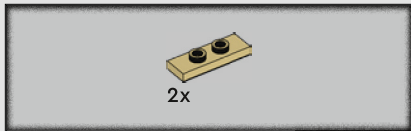

61

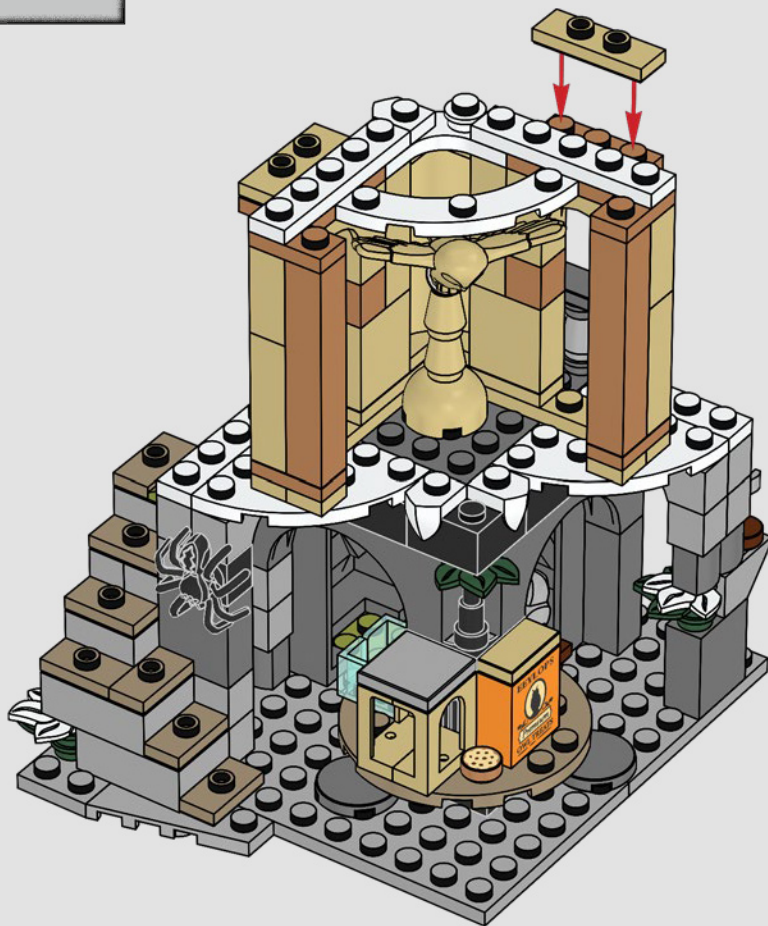



3x



2x

62

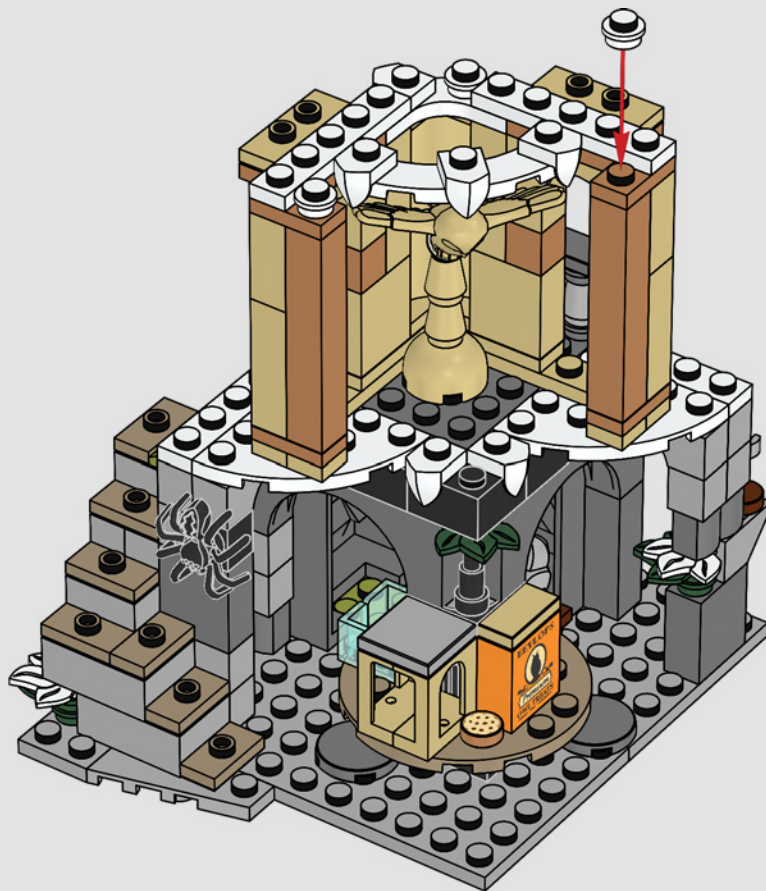

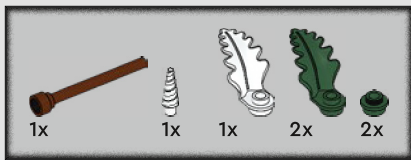

63

1



2



3



4



5



6



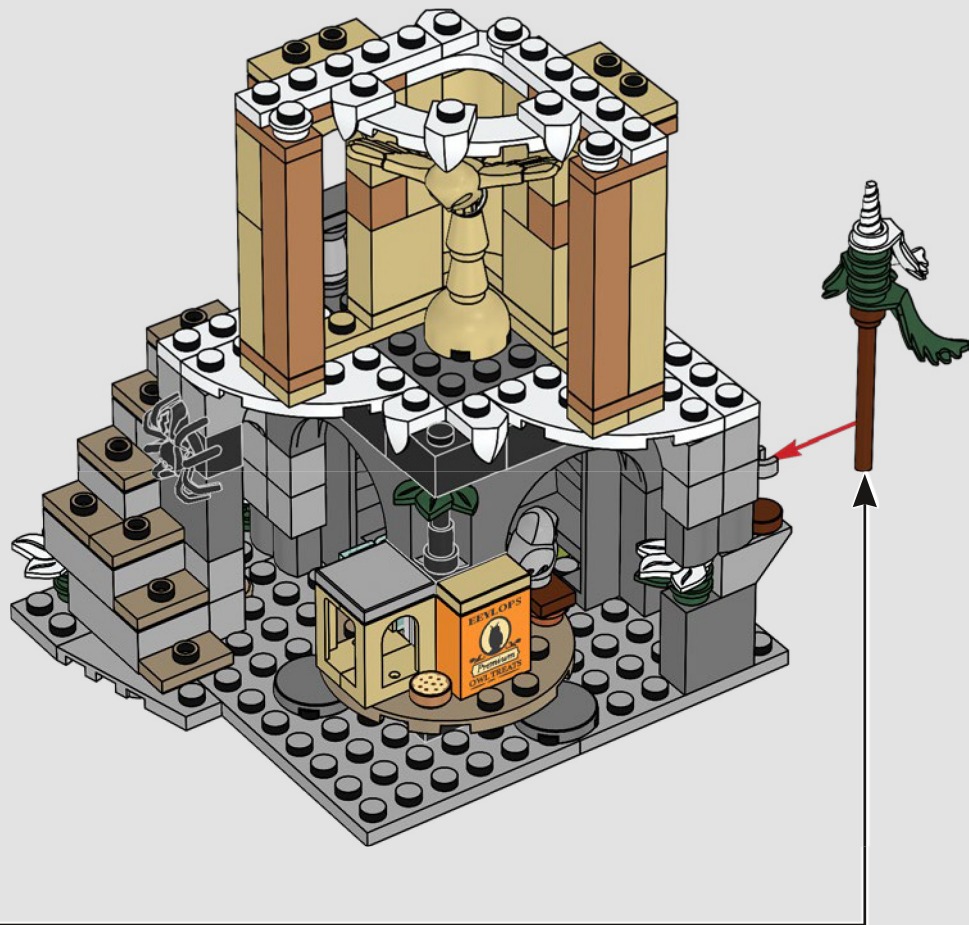

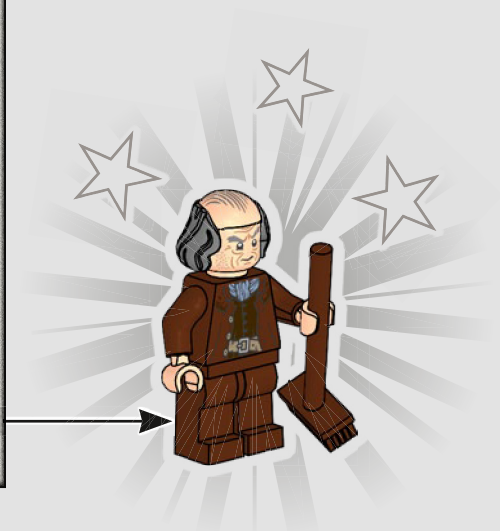
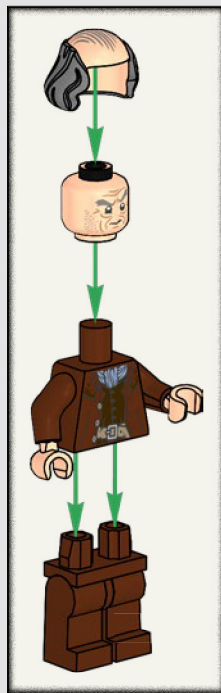

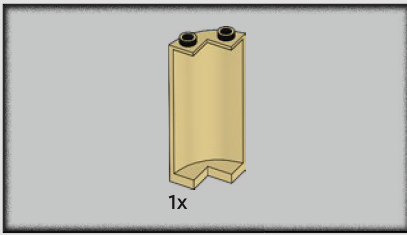

64

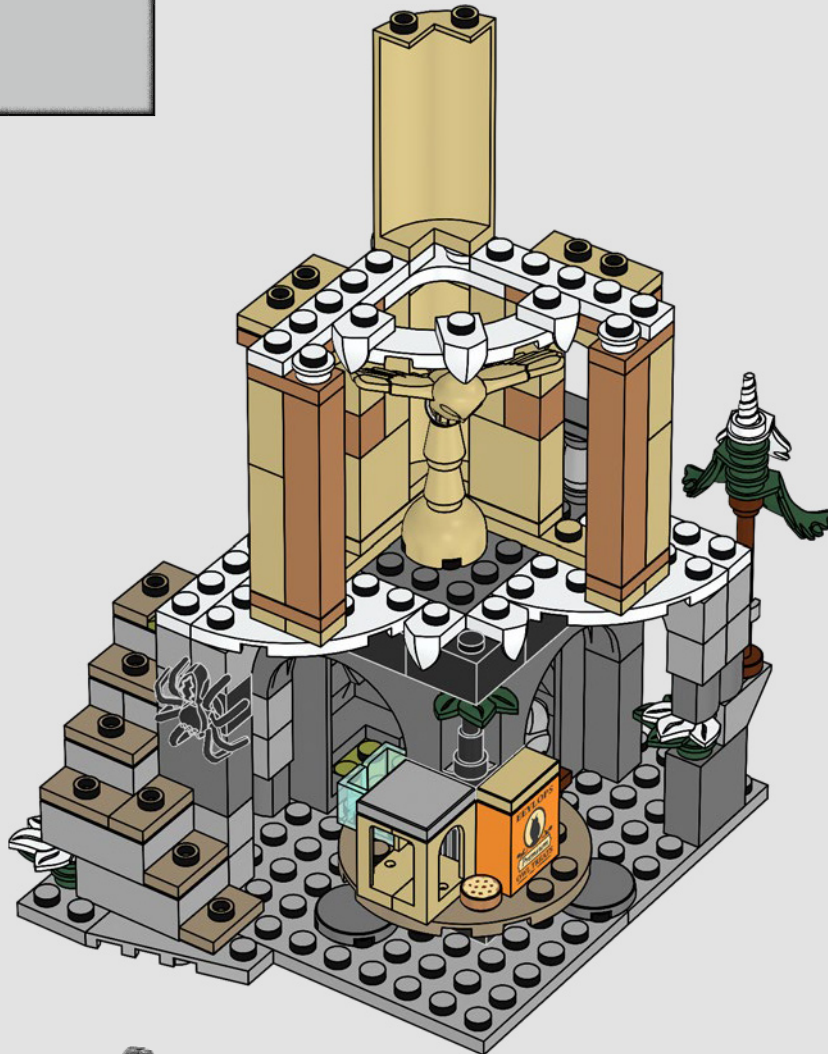

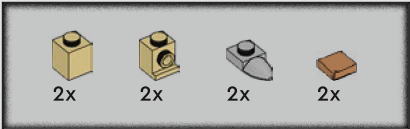

65

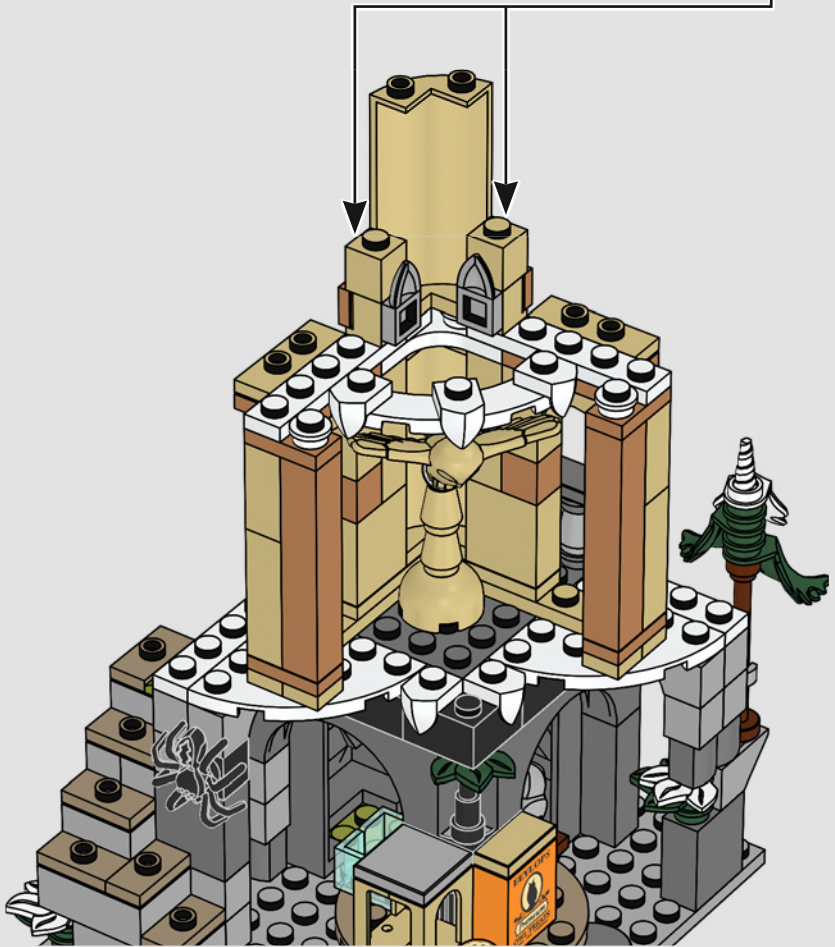
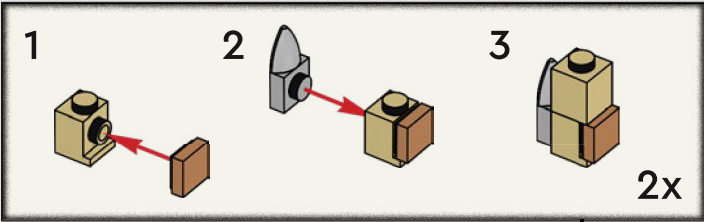



66

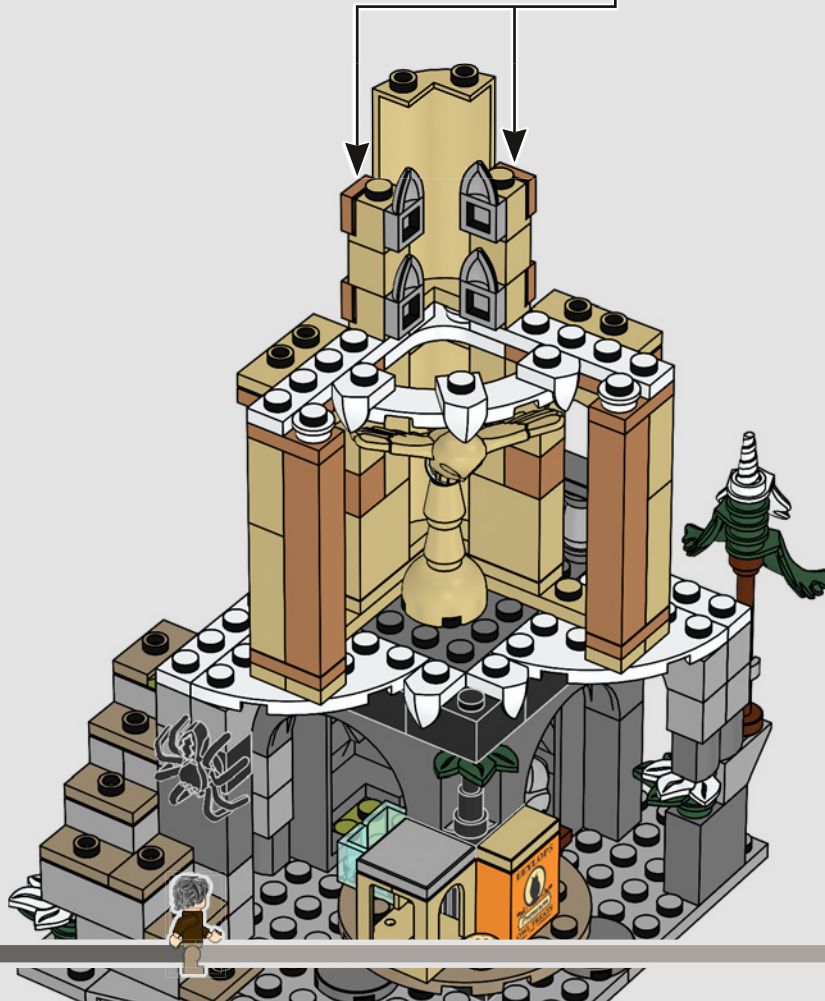
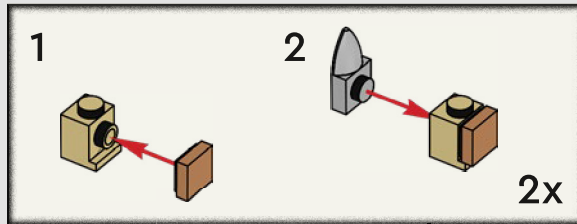



6x

67

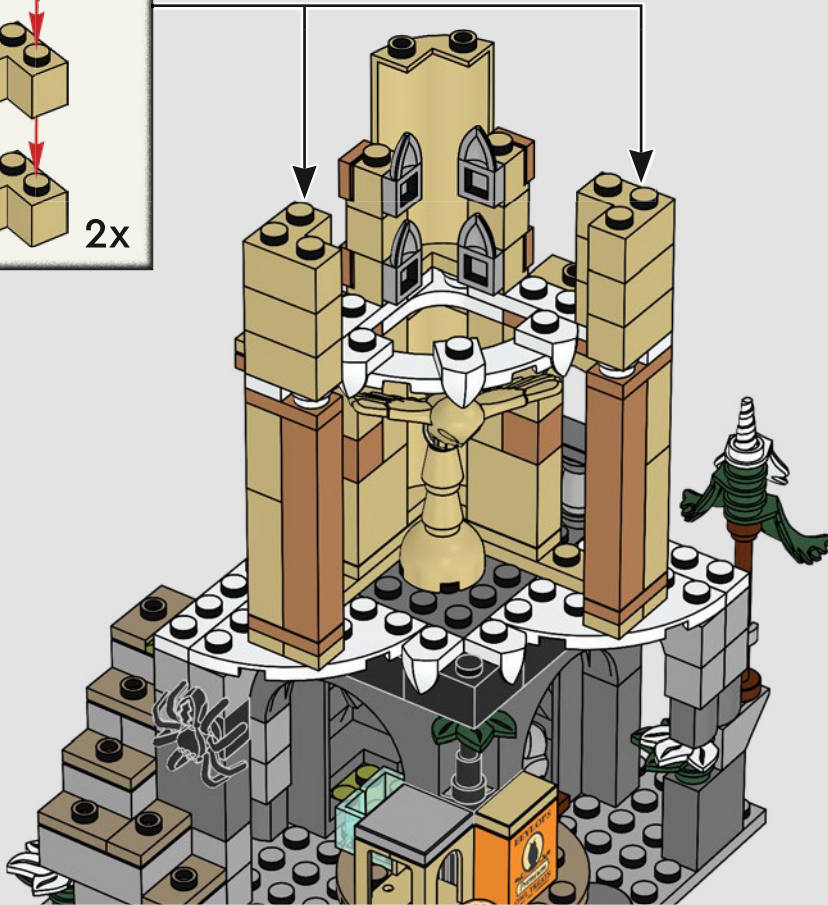
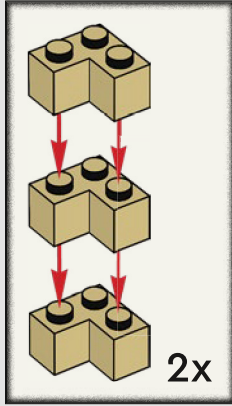

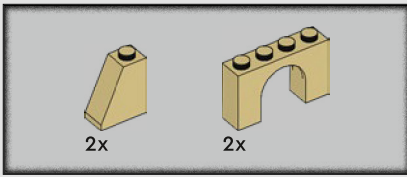

68

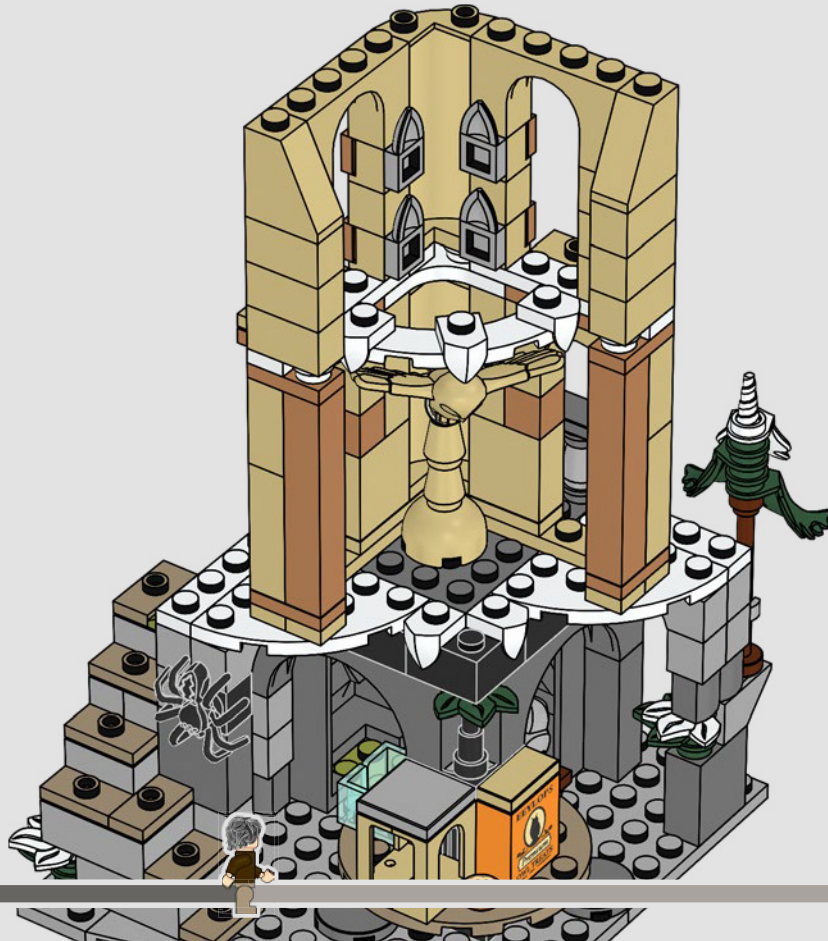

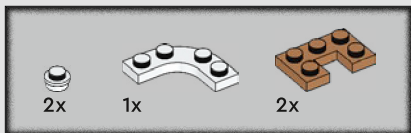

69



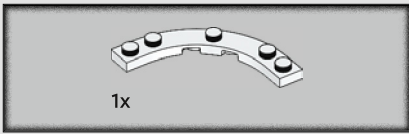

70



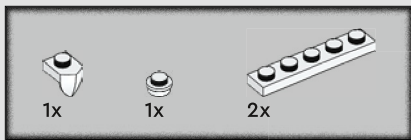

71

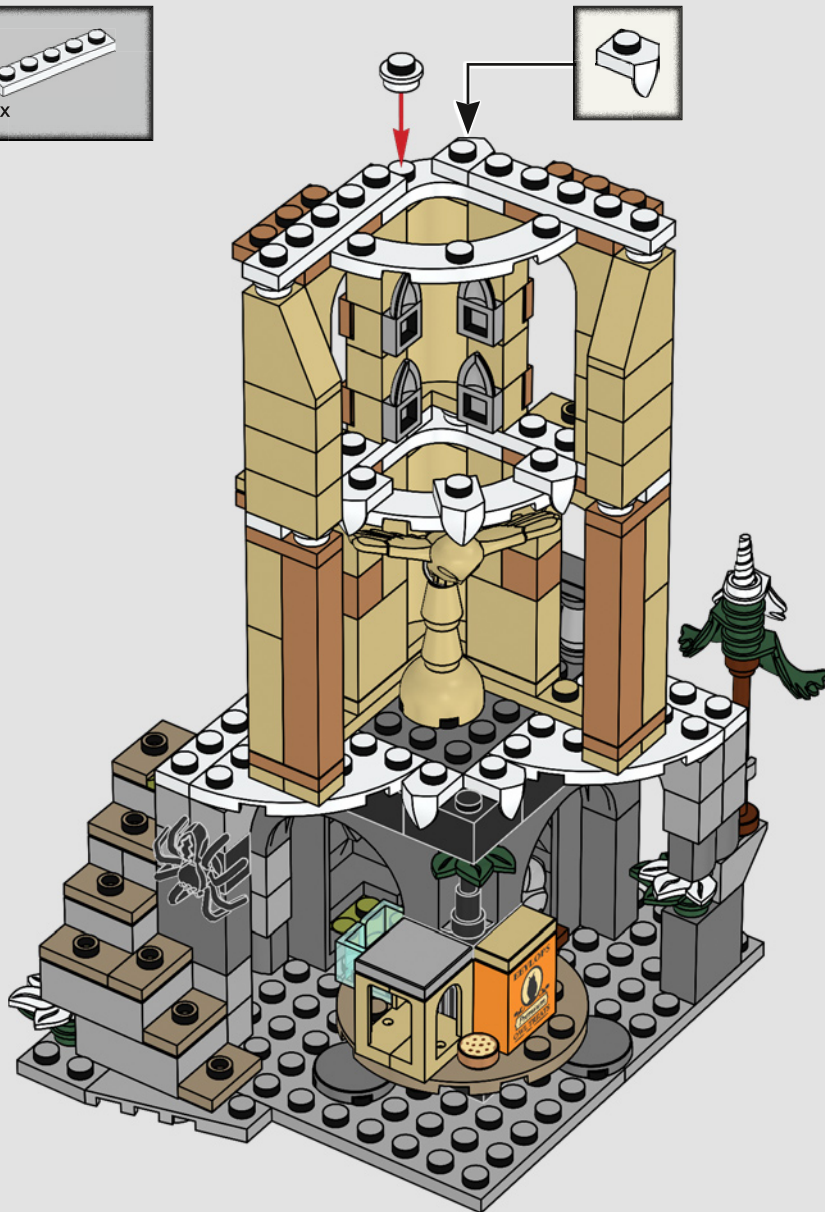

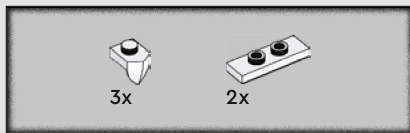

72

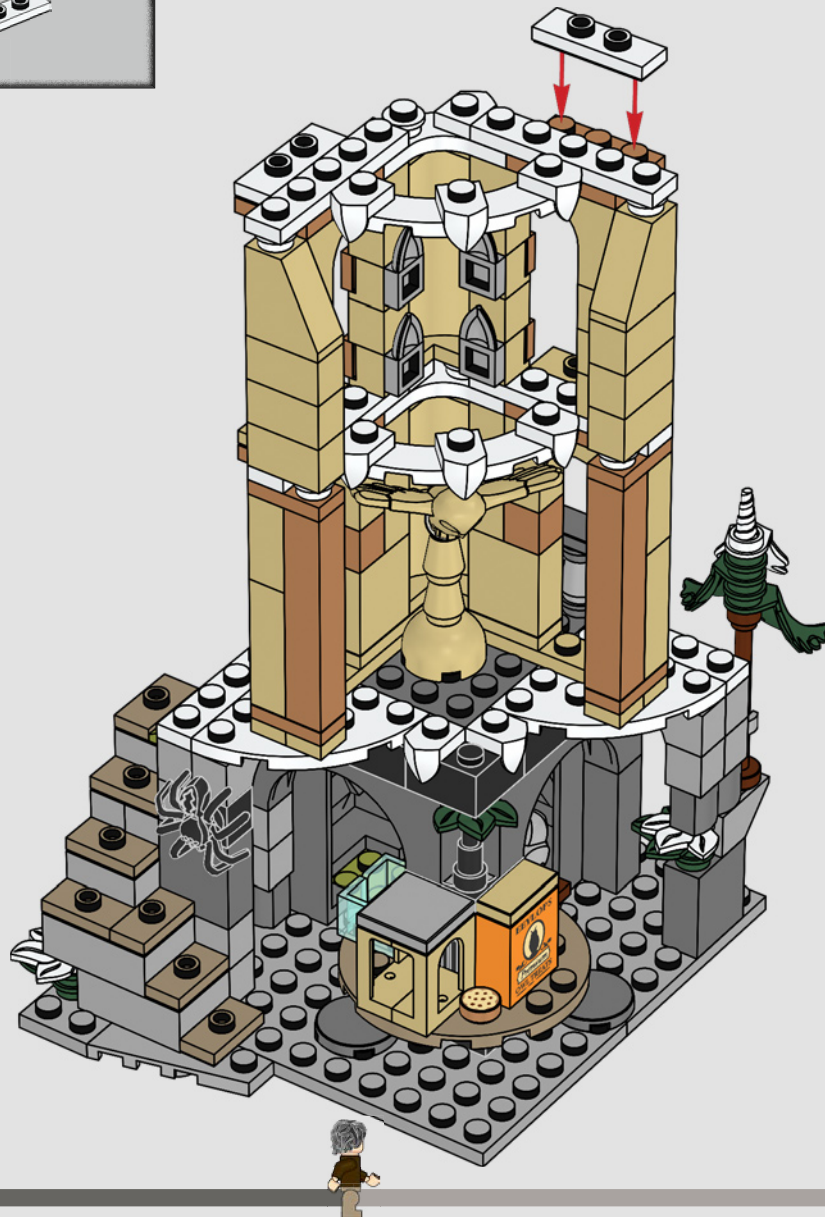

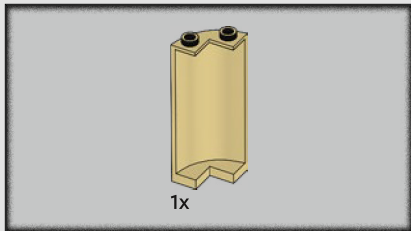

73

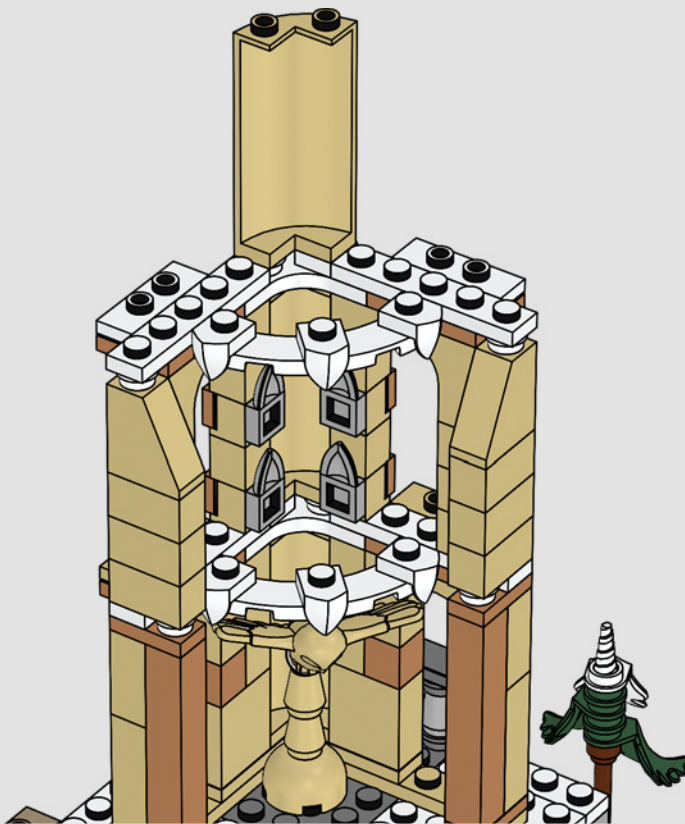

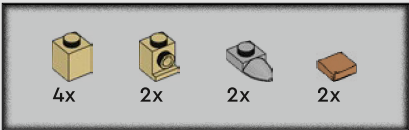

74

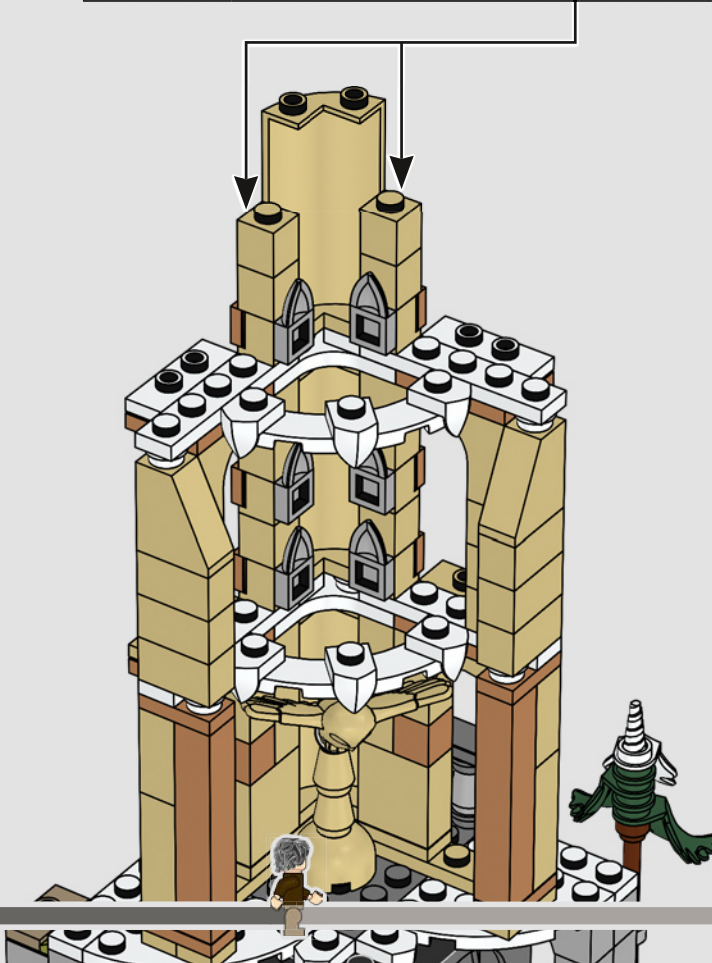
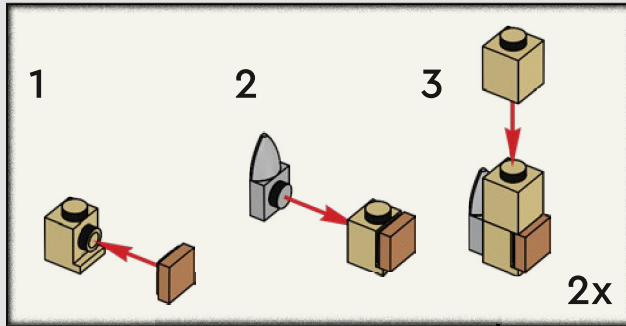



2x

75

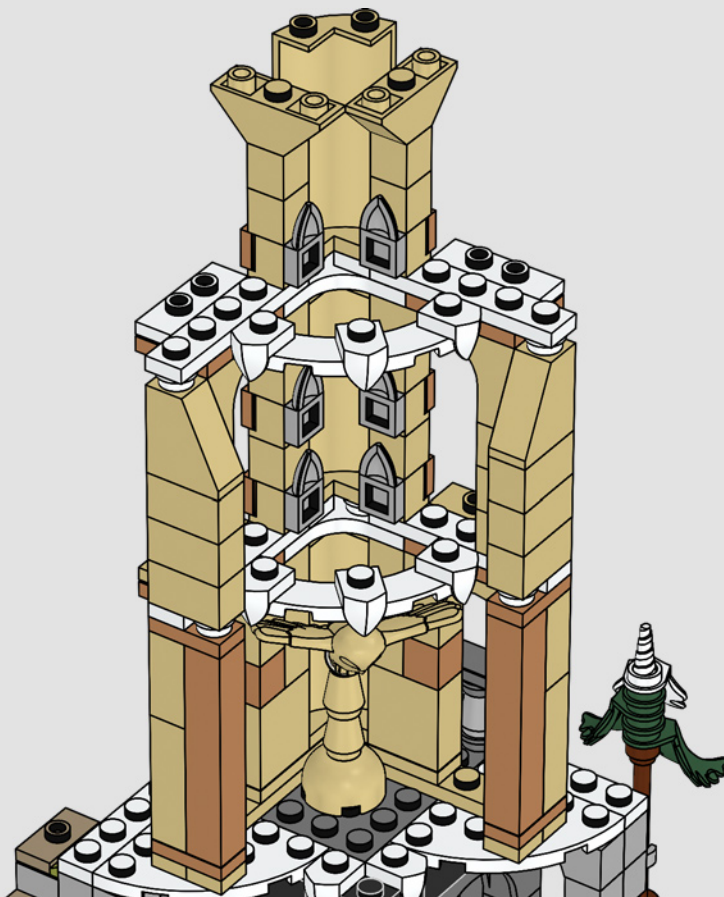

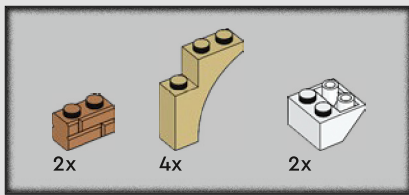

76

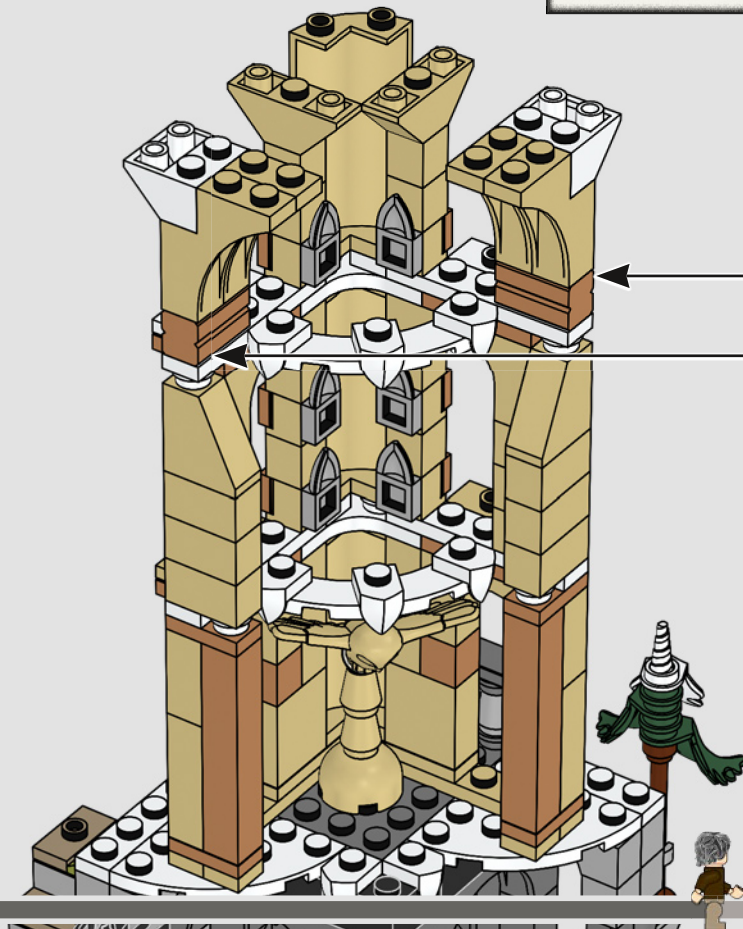
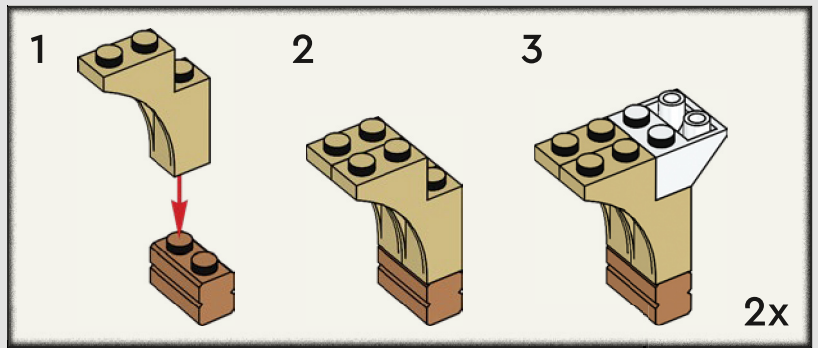

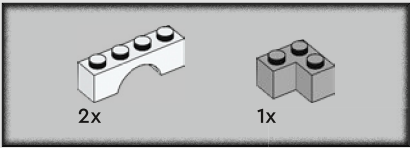

77

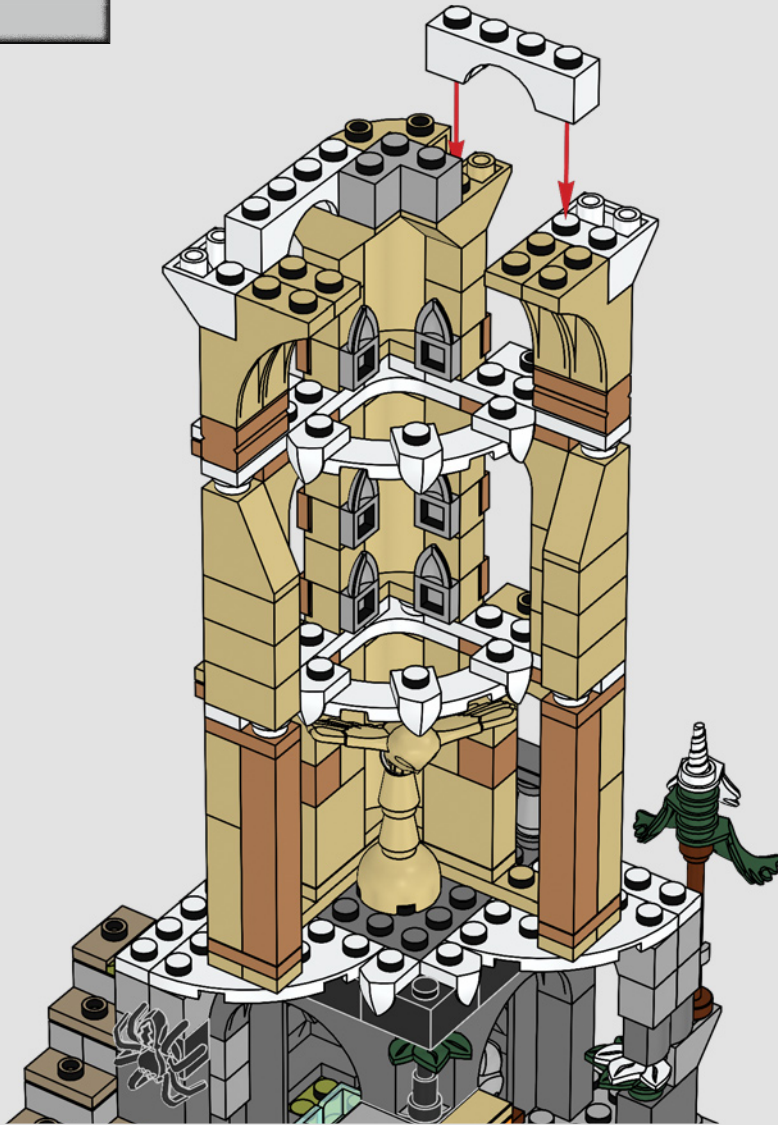

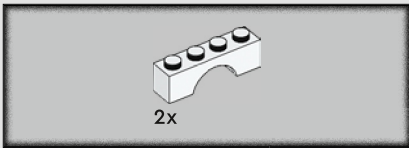

78

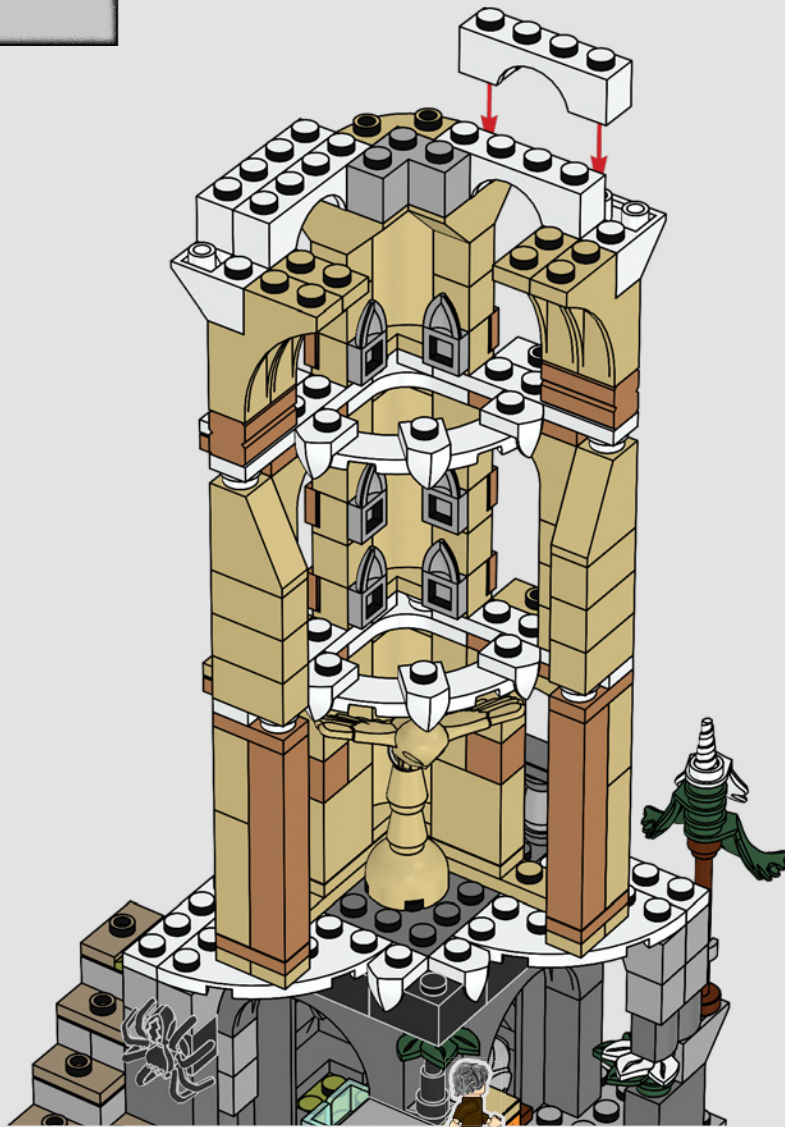

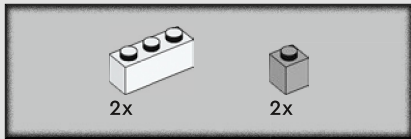

79

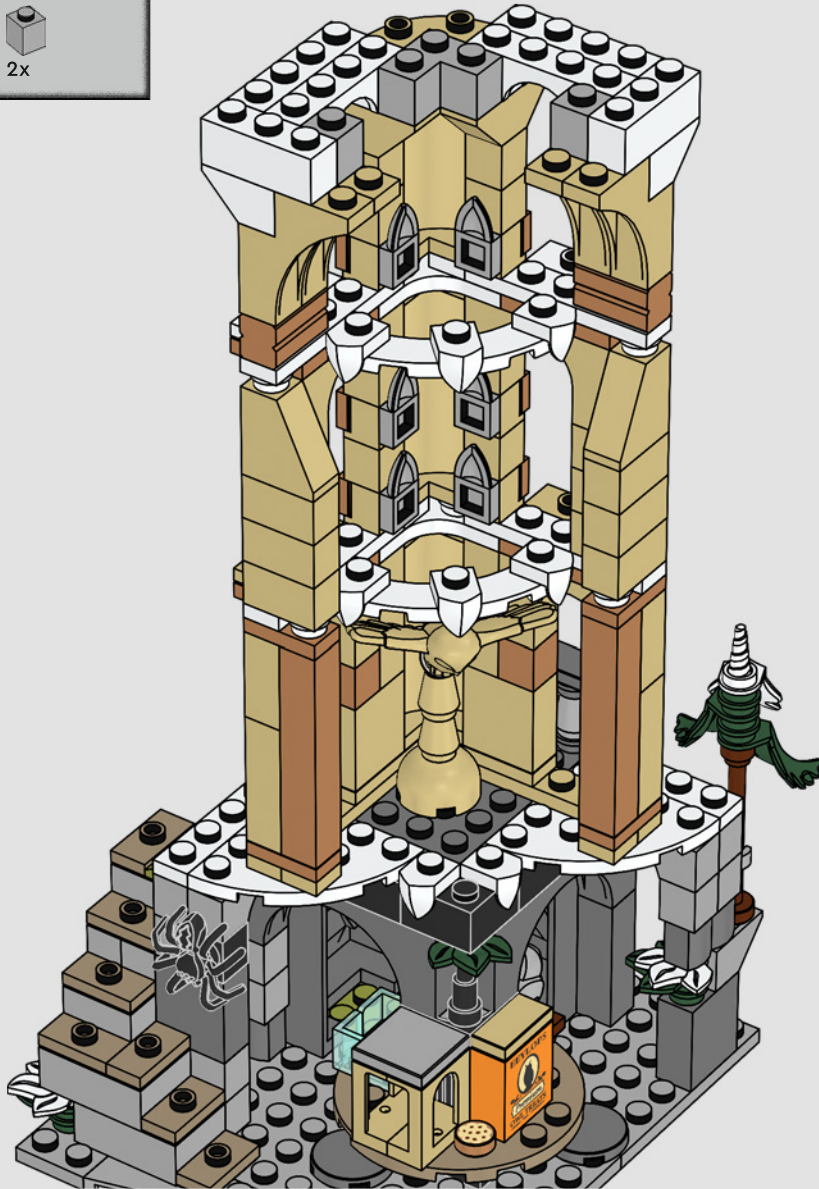

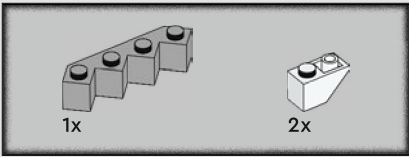

80

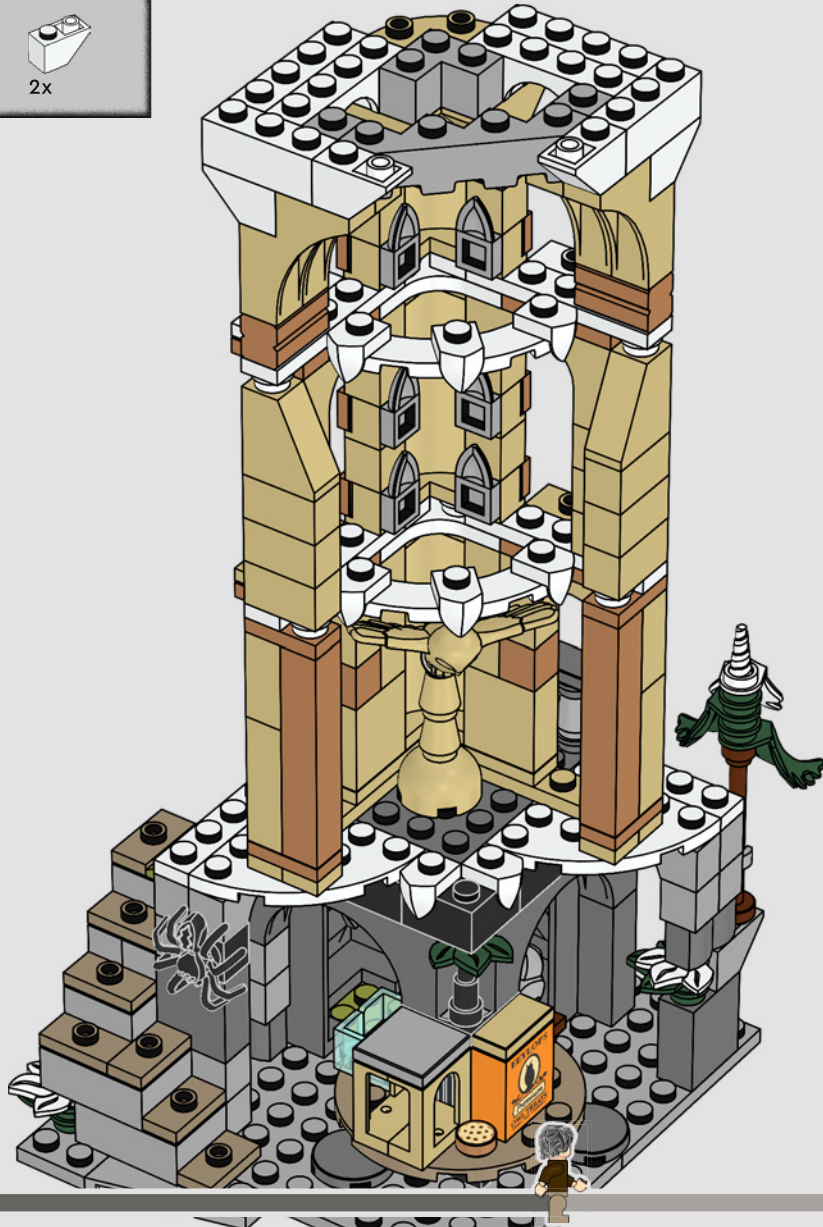

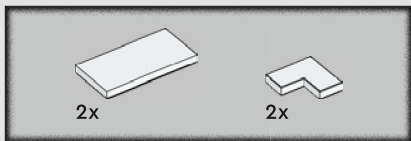

81

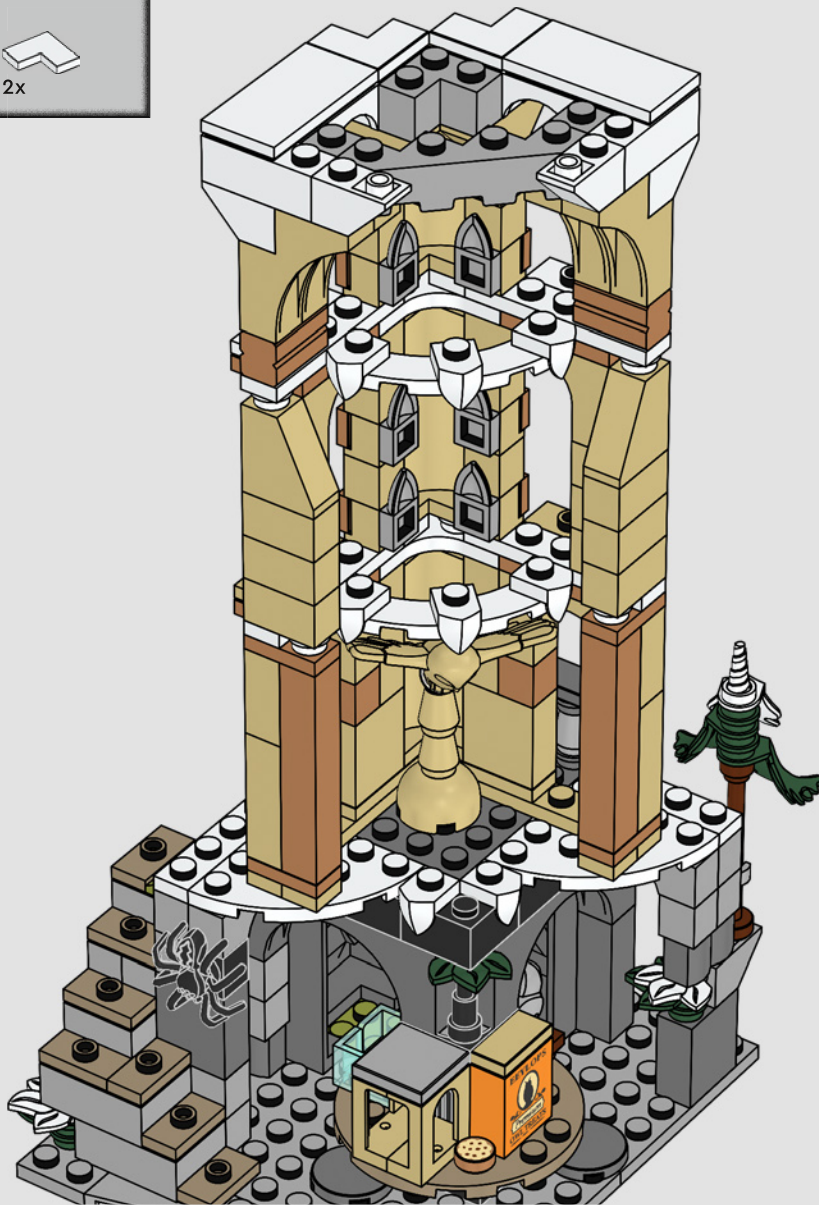

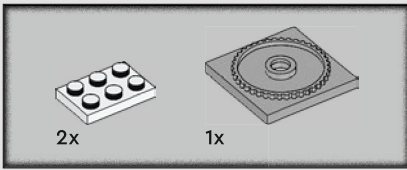

82

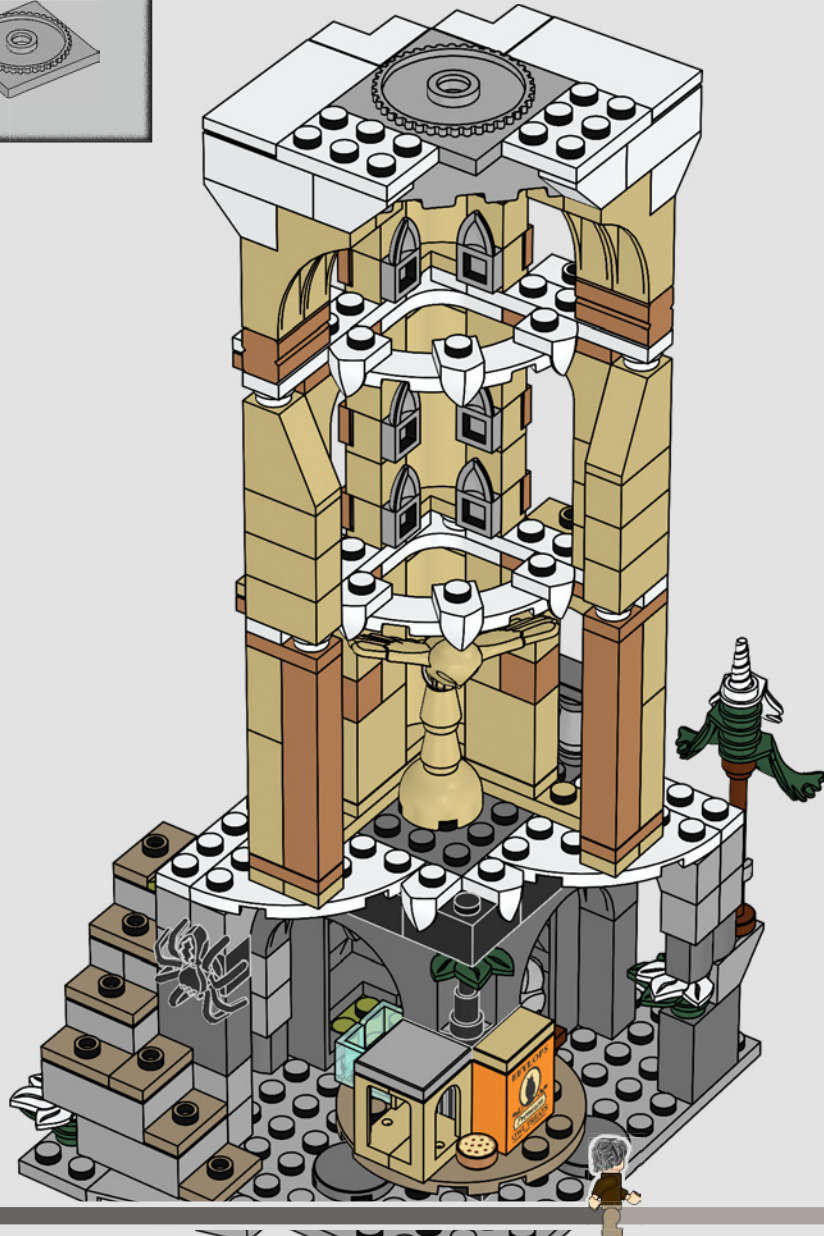



2x

83

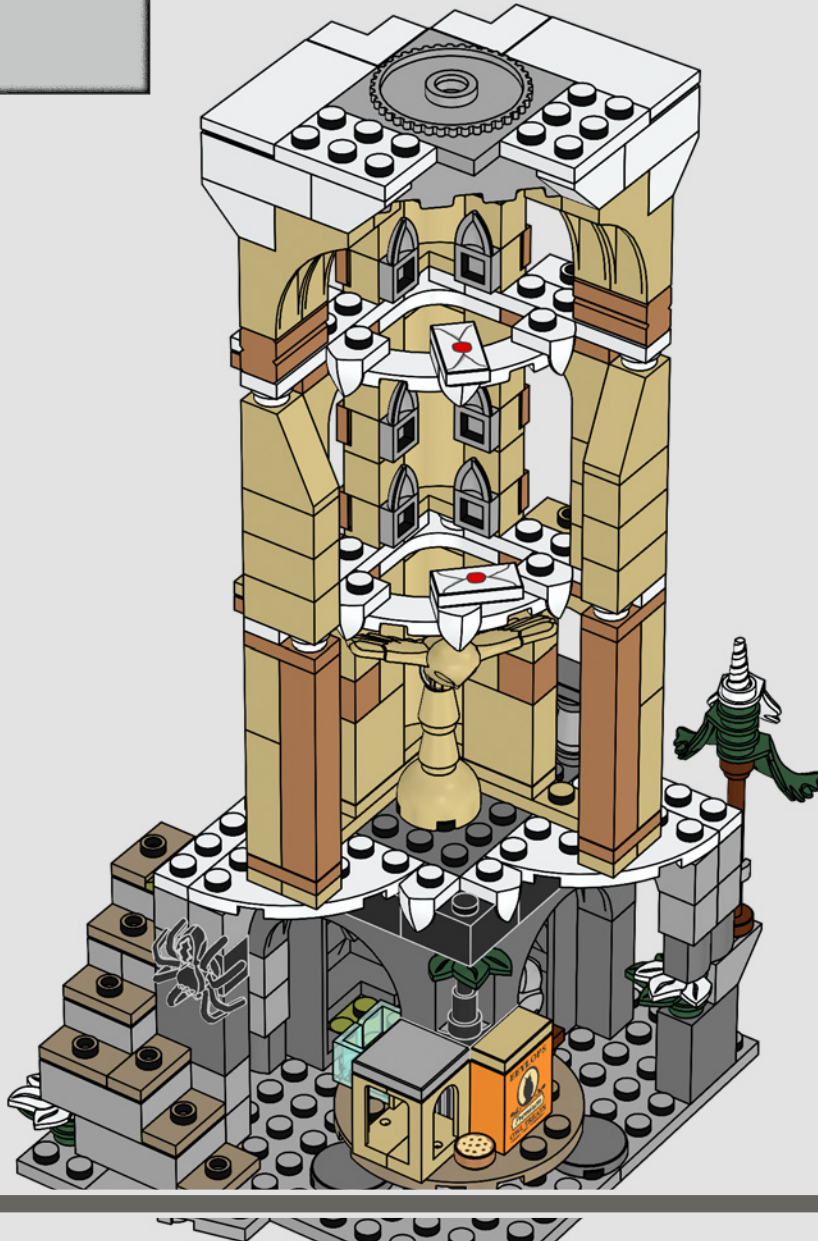



84

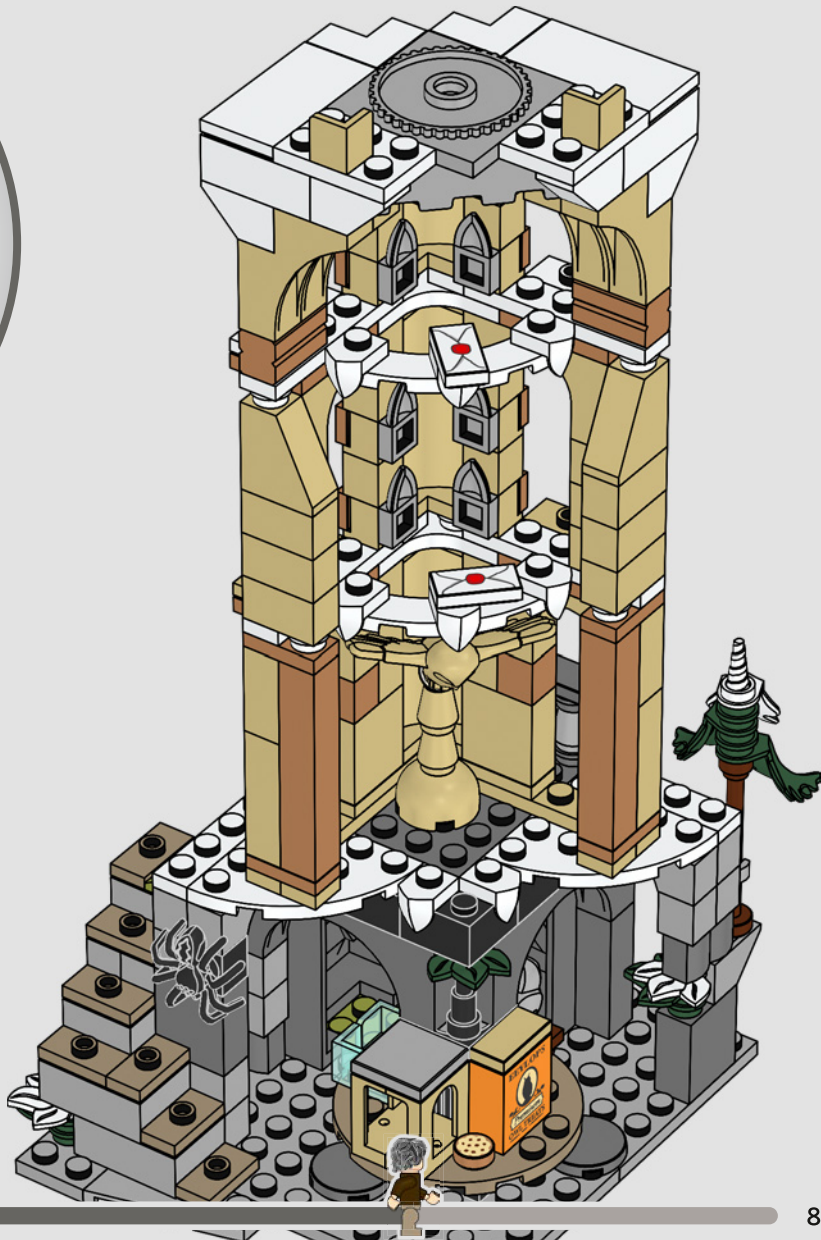

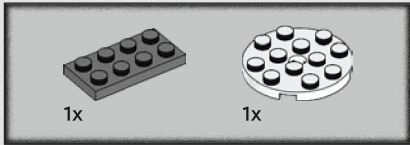
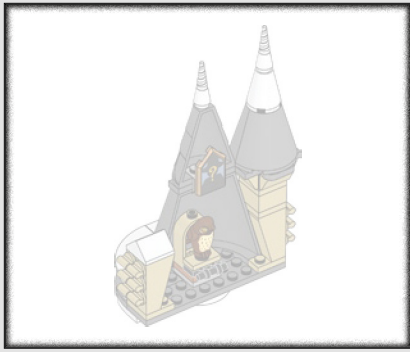

85

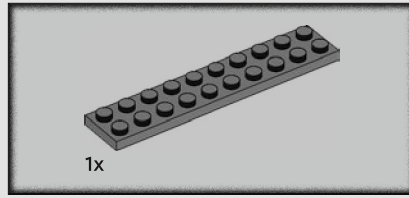
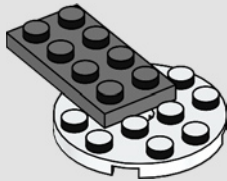

86

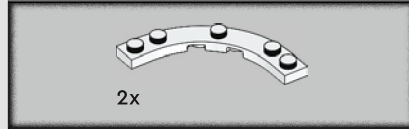
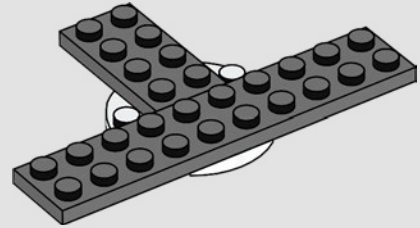

87

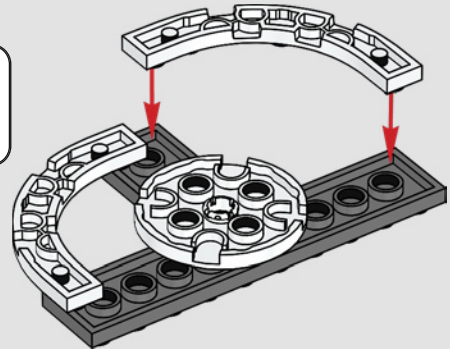

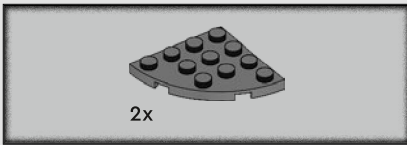

88

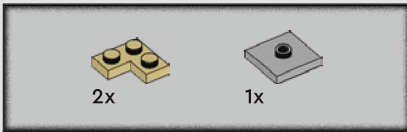
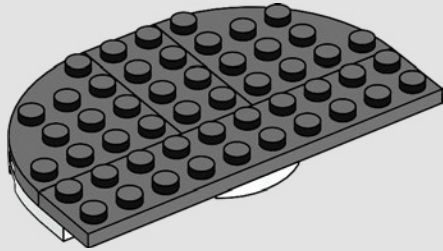

89

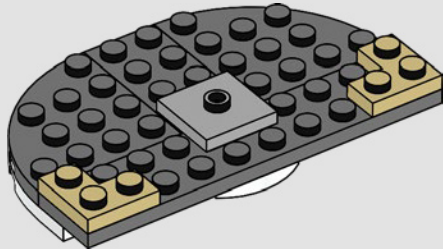

90

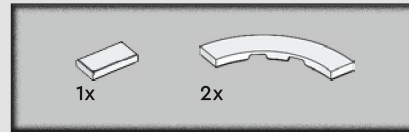
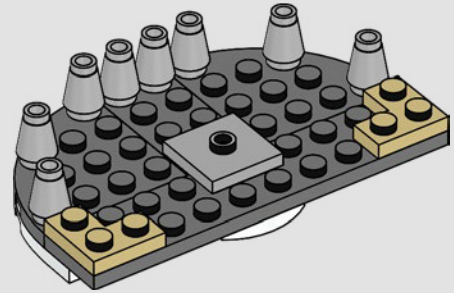

91

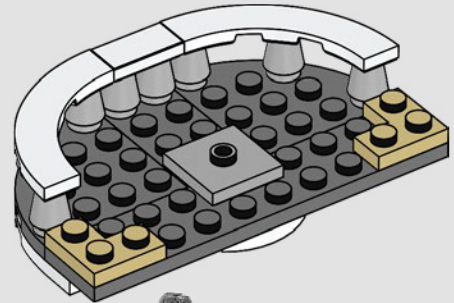

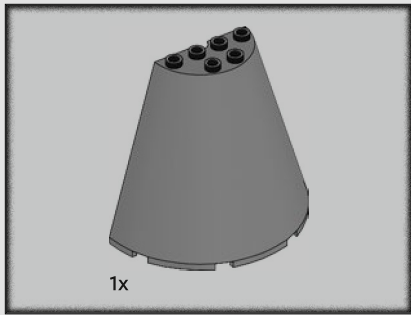

92

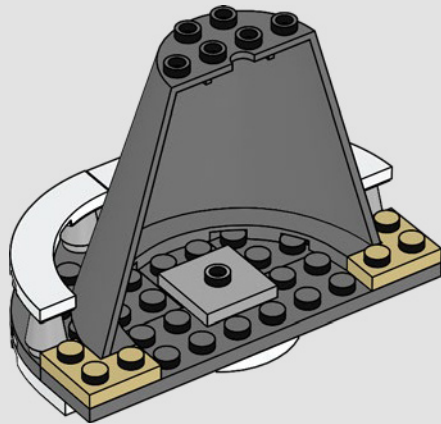

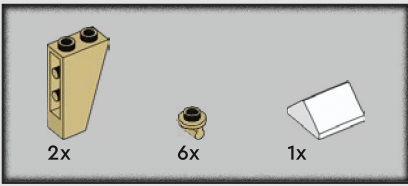

93

1

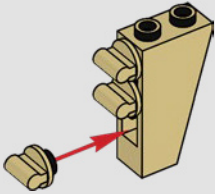

2

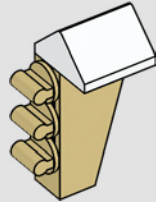

3

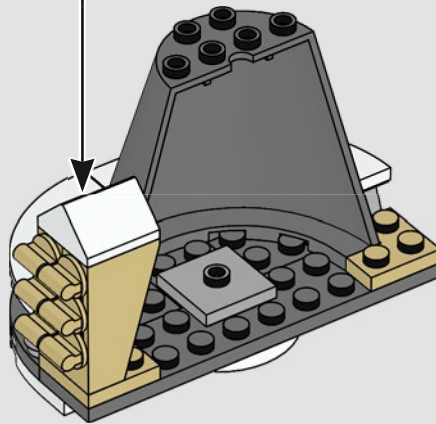
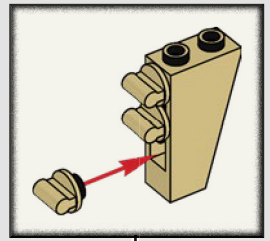
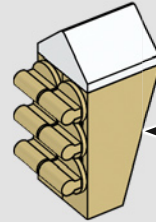

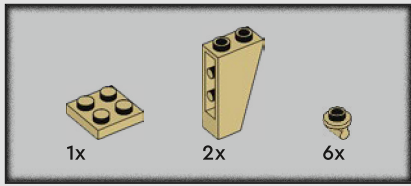

94

1

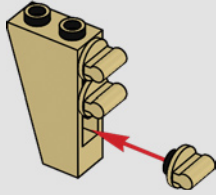

2

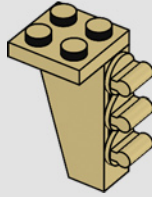

3

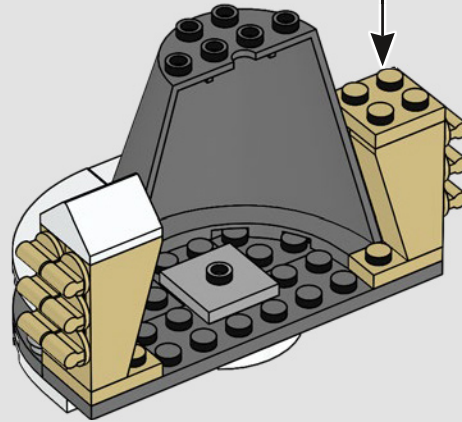
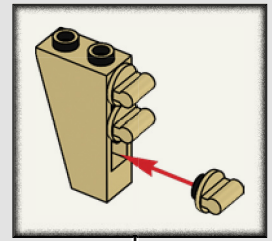
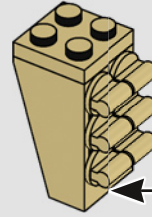

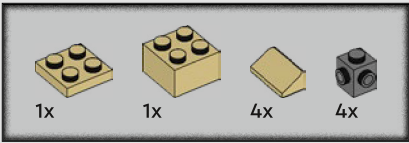

95

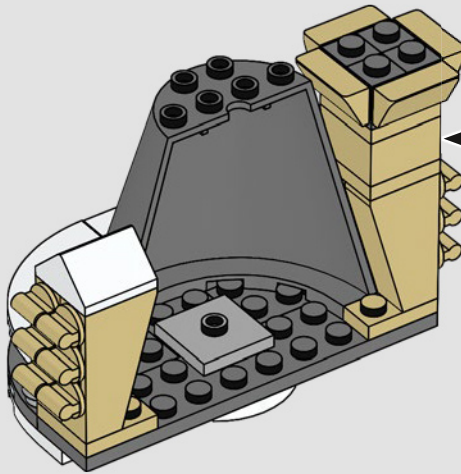
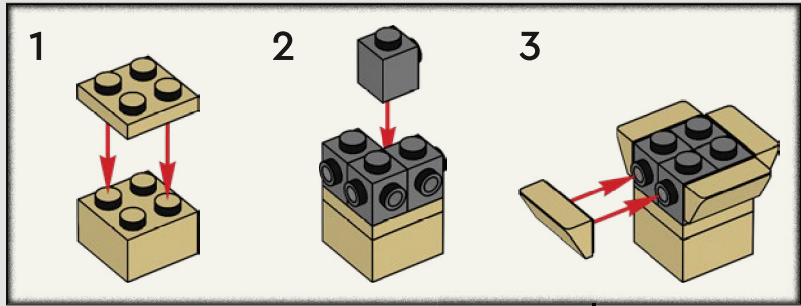

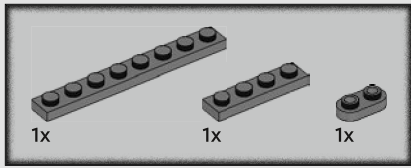

96

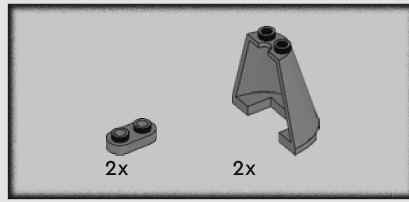
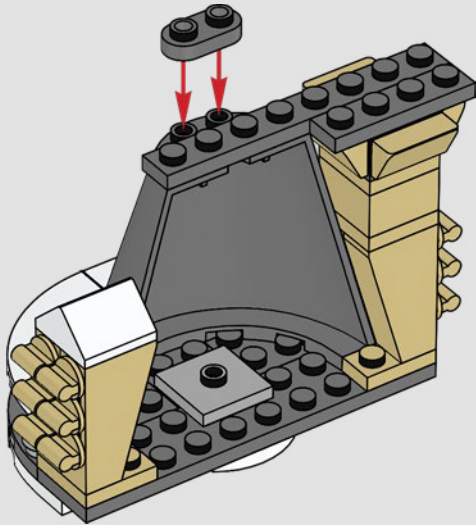

97

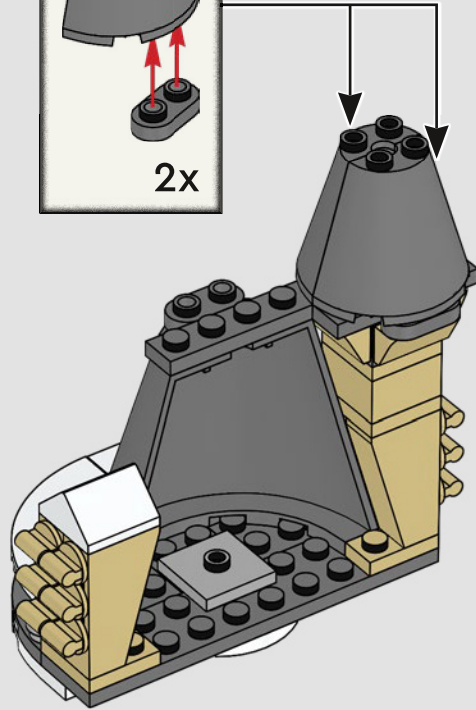
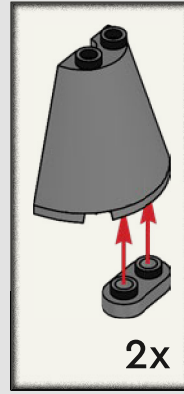

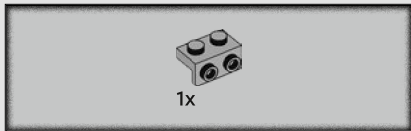

98

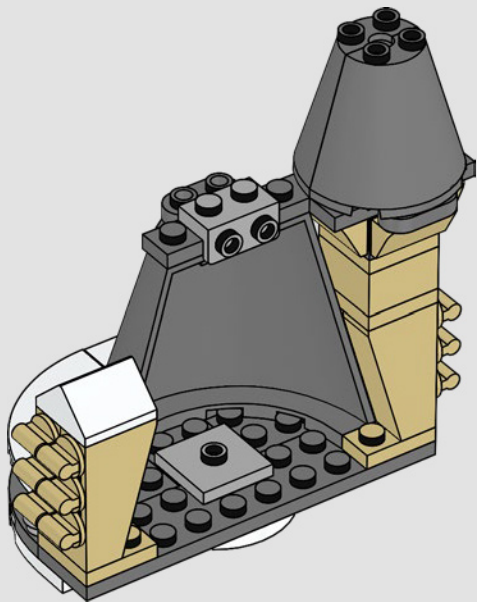

99

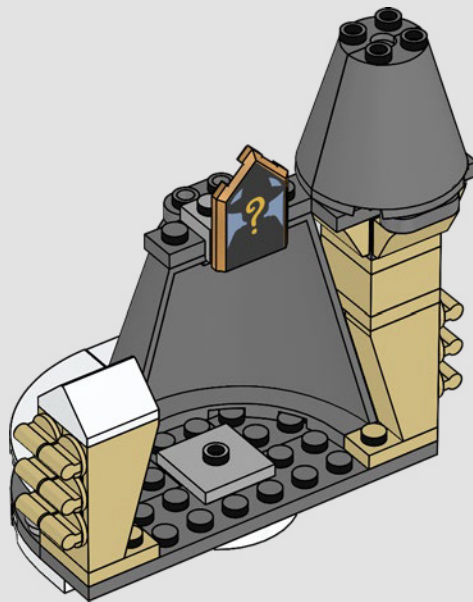

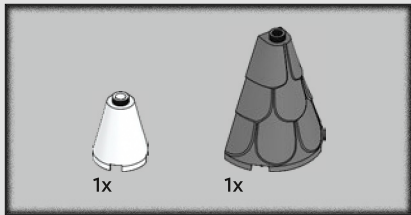

100

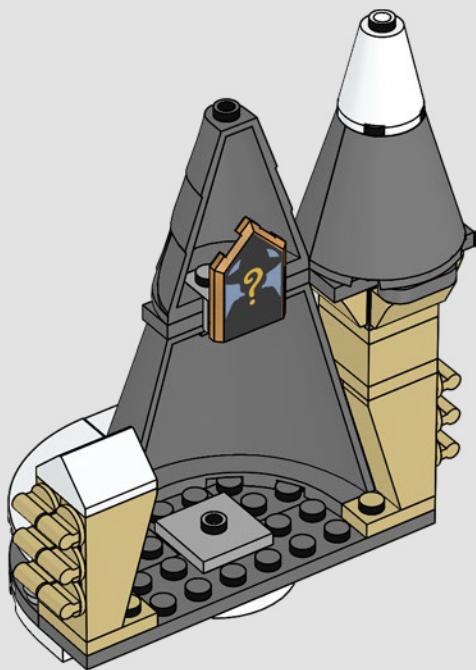

101

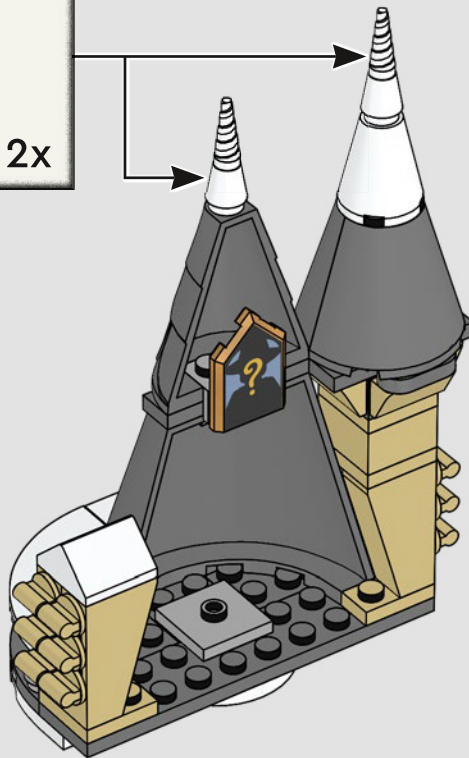
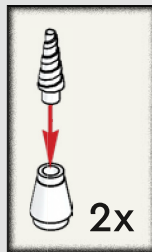

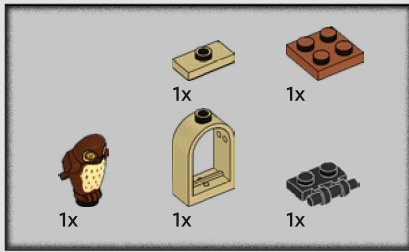

102

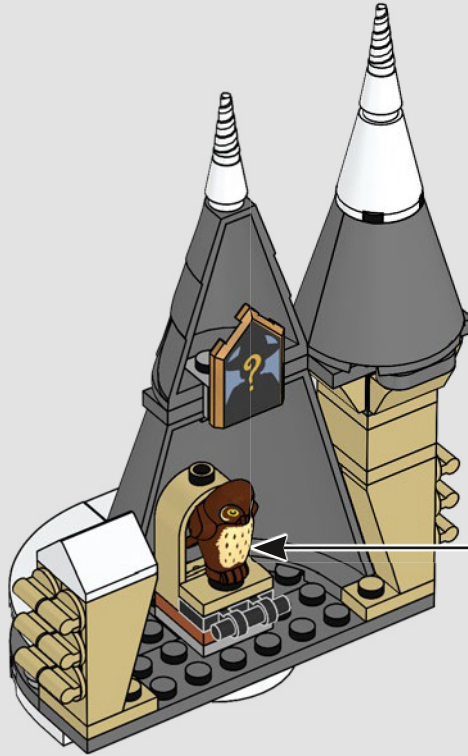
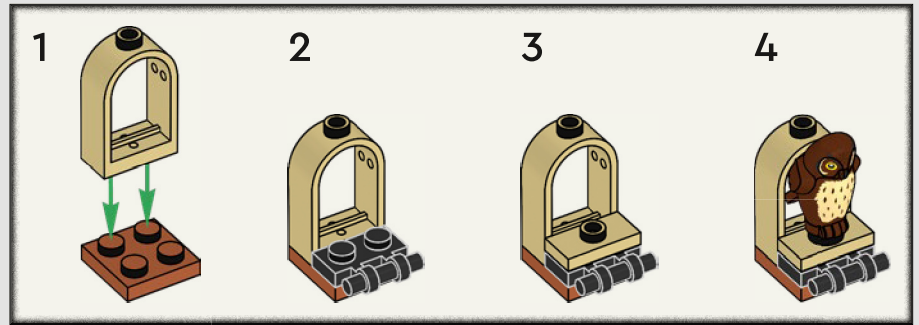

103

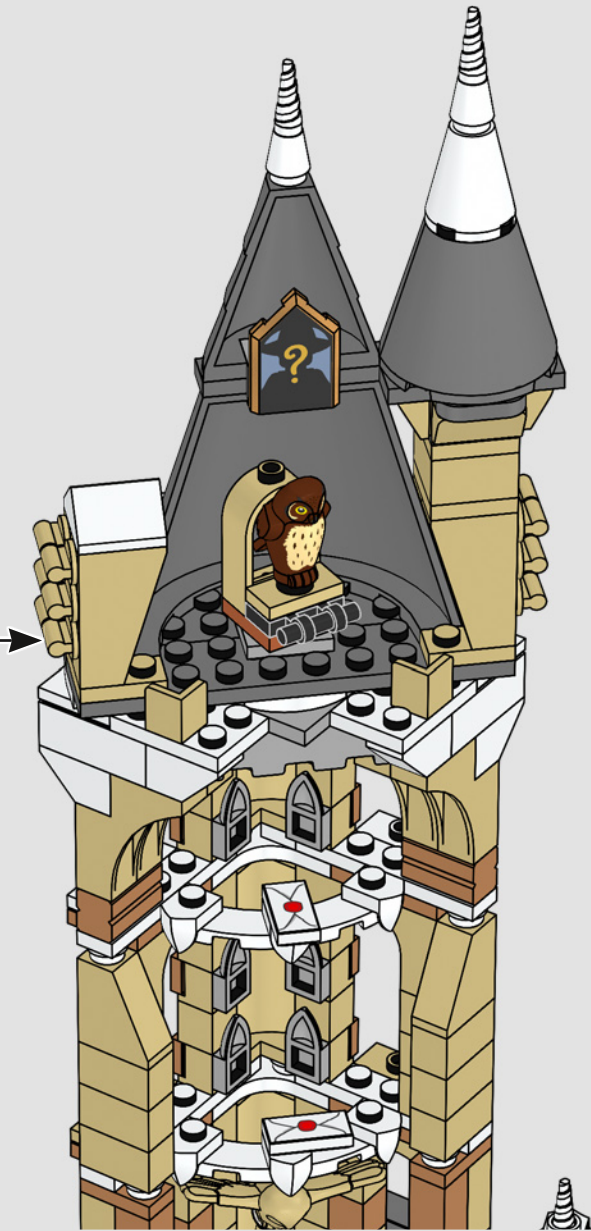

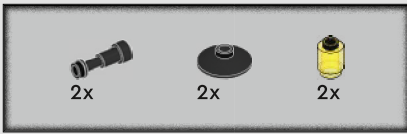

104

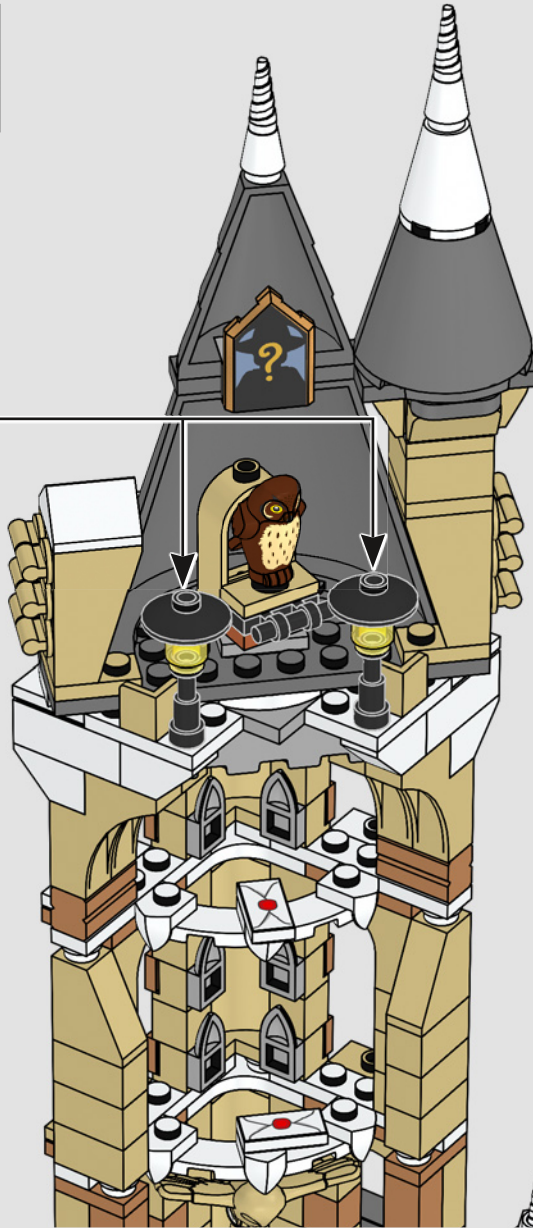
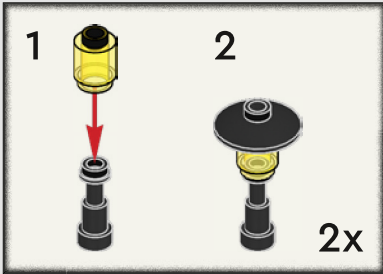

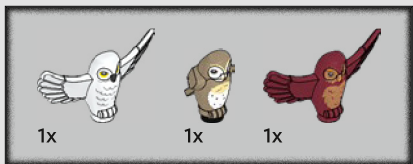

105

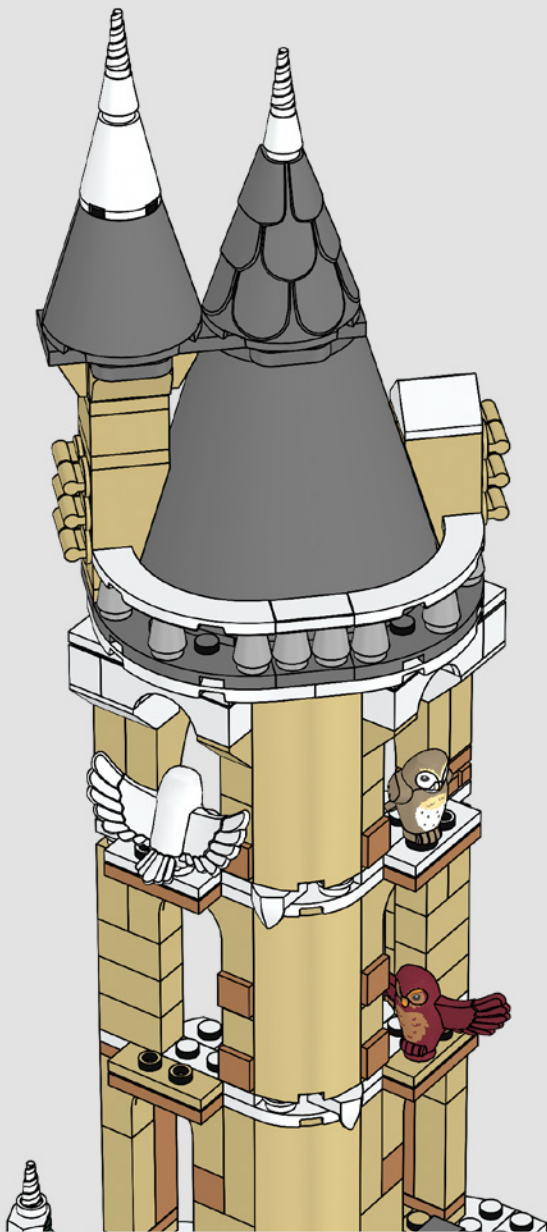





Harry Potter



Build the most detailed HOGWARTS™ CASTLE



76426



76430

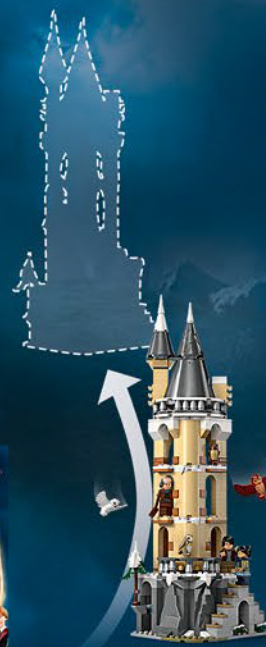

Baue das detailreichste Schloss Hogwarts™ / Construisez le château de Poudlard le plus détaillé / Costruisci il Castello di Hogwarts™ più dettagliato di sempre / Construye el Castillo de Hogwarts™ más detallado / Construa o mais detalhado Castelo de Hogwarts™ / 拼搭精美的霍格沃茨“城堡” / Zbuduj najbardziej szczegółowy zamek Hogwart™ / Postavte si ten najdetailnejši Bradavický hrad / Postavte si najdetailnejši Rokfortský hrad / Építsd meg a legrészletgazdagabb Roxfort™ kastélyt! / Construieste cel mai detaliat Castel Hogwarts™ / Постройте наиболее-детальную версию из замка Хогвортс / Uzbuiv visdetailizetako Cúkkárpas pili / Pane kokku kõige üksikasjalikum Sigatütka™ loss / Sukonstruokite nepaprastai detalią Hogwartso pilį

Each set sold separately and available for different periods of time / Jedes Set ist separat und in unterschiedlichen Zeiträumen erhältlich. / Chaque set est vendu séparément et sera disponible à des périodes différentes. / Ogni set è venduto separatamente ed è disponibile per periodi di tempo diversi. / Cada set se vende por separado y está disponible durante un cierto período de tiempo. / Os sets são vendidos separadamente e estão disponíveis por diferentes períodos de tempo. / 每款套装于不同时间段单独出售。 / Zestawy są sprzedawane osobno i są dostępne w różnym czasie / Každá stavebnice se prodává samostatně a je k dispozici v různých časových obdobích / Každá stavebnica sa predáva samostatne a je k dispozícii v rôznych časových obdobiach / Minden egyes készlet külön-külön és más-más időszakban kapható. / Seturile se vând separat și sunt disponibile pentru perioade diferite de timp / Всеки комплект се продава отделно и е наличен за различен период от време. / Katrs komplekts tiek pārdots atsevišķi, un to pieejamības periodi atšķiras. / Kõik komplektid on müügil eraldi ja saadaval erinevates ajavahemikes. / Kiekvienas rinkinys parduodamas atskirai ir tik ribotą laiką

Collect all 14 Portraits

Portrait tiles are packed randomly
in the sets.

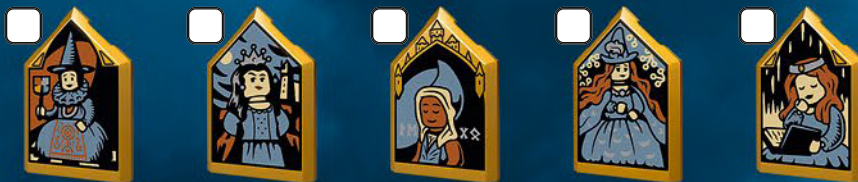

Samle alle 14 Porträts / Collectionnez les 14 portraits / Collezione i 14 ritratti / Colecciona los 14 retratos / Coleccione todos os 14 retratos /
集齐所有 14 种肖像 / Zbierz wszystkie 14 portretów / Posbírejte všech 14 portrétů / Nazbieraj všetkých 14 portrétov / Gyűjtsd össze mind a 14 portrét! /
Coleccionează toate cele 14 portrete / Сбeрeтe вcички 14 портрeтa в кoлeкция / Sakrāj visus 14 portretus / Kogu kokku kõik 14 portreed / Surinkite
visus 14 portretų

Die Porträt-Steinchen werden nach dem Zufallsprinzip in die Sets gepackt. / Les tuiles avec des portraits sont réparties de manière aléatoire dans les sets. / Le tessere dei ritratti sono inserite in maniera casuale in ogni set. / Las cubiertas con retratos se incluyen en los sets de forma aleatoria. / As peças dos retratos estão distribuídas aleatoriamente nos sets. / 肖像光板随机附于套装中。 / W zestawach znajdują się losowe płytki do portretów. / Díky s portréty jsou do stavebnic baleny náhodně. / Díelky s portrétmi sú do stavebníc balené náhodne. / A portrét véletlenszerűen kerülnek a csomagba. / Pláčuțele cu portrete sunt incluse aleatoriu în seturi. / Плочките с портрети са включени в комплектите на случаен принцип. / Portretu elementi komplektiem tiek pievienoti pēc nejaušības principa. / Portree detailid pakitakse komplektidesse juhuslikult. / Rinkiniuose esančios portretų plytelės parinktos atsitiktinai.

| | | | | | | |
|--|--|---|--|--|---|--|
|  3x 6192793 |  2x 6366391 |  2x 4178429 |  2x 4612603 |  1x 6092587 |  1x 6435972 |  1x 6467915 |
|  6x 614101 |  1x 6371464 |  4x 6399559 |  2x 4159553 |  1x 4114026 |  1x 6399008 |  1x 6270032 |
|  2x 4518400 |  2x 6195371 |  2x 6457244 |  6x 4118793 |  6x 4124455 |  1x 6265371 |  1x 6481084 |
|  2x 4504369 |  2x 362201 |  1x 6287854 |  6x 4113915 |  2x 4114077 |  1x 6236686 |  1x 6480305 |
|  2x 6172366 |  2x 302101 |  2x 6057986 |  4x 6057517 |  2x 4114084 |  2x 6315782 |  1x 6284586 |
|  12x 6046905 |  2x 371001 |  6x 6177146 |  2x 4626200 |  1x 4114306 |  1x 6228968 |  1x 6270028 |
|  3x 6382783 |  4x 365901 |  2x 6339311 |  4x 6030731 |  2x 4121921 |  1x 4615606 |  1x 4596335 |
|  1x 6044601 |  1x 4515347 |  2x 4656783 |  1x 4623514 |  2x 6211966 |  1x 6353937 |  1x 4211157 |
|  1x 6439714 |  2x 6339103 |  4x 6218360 |  4x 6442933 |  2x 6404700 |  1x 6265367 |  1x 4221886 |
|  2x 366501 |  1x 6299912 |  4x 6336665 |  2x 4642933 |  4x 6058093 |  1x 6226594 |  1x 6092590 |
|  2x 6299836 |  2x 4560178 |  12x 6472548 |  2x 4159279 |  4x 6031057 |  11x 6092591 |  1x 6401304 |
|  1x 306901 |  4x 6350399 |  2x 4529237 |  2x 4159279 |  1x 6472549 |  1x 6166127 |  1x 4538252 |
|  2x 242001 |  1x 6254335 |  4x 4624086 |  3x 6318113 |  2x 4124067 | | |
|  2x 6058329 | |  1x 6429062 | | | | |

15x
4529241

1x
6467916

8x
4211389

6x
6213644

1x
6345426

1x
4211732

1x
4540203

3x
4211437

1x
4654582

1x
4211413

3x
4211387

1x
4211349

1x
6126082

2x
4211489

4x
4211386

7x
4211435

1x
6039346

1x
6045718

1x
4211406

1x
4211474

1x
4211405

1x
4558954

2x
6172383

2x
302426

1x
6402958

2x
6438919

1x
6365482

2x
6024730

2x
474026

3x
4538456

1x
6234806

1x
4140588

1x
368026

1x
300326

2x
362226

1x
4517986

7x
4210633

1x
6396489

4x
6332045

3x
6221607

1x
4567887

2x
6056296

2x
4211095

2x
4210978

2x
4211052

1x
4211001

1x
4211065

1x
6458171

2x
6106191



1x
6232139



1x
4500517



1x
4210678



1x
4210998



2x
6235153



1x
6230280



2x
4222042

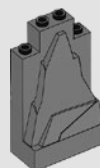

2x
4513326

1x
6285587

2x
6238674

5x
6230571

4x
6400754

2x
6447541

1x
6481813

2x
6002841



1x
6218088

2x
6248908

2x
6190252

1x
6478297

1x
6482585

1x
6263969

1x
6482586



 [LEGO.com/service](https://www.LEGO.com/service)

YOU COULD **WIN**



Scan this QR code or go to **LEGO.COM/PRODUCTFEEDBACK** and give us your short feedback about this LEGO® set for a chance to win a cool LEGO prize.

Terms and Conditions apply*

EN: YOU COULD WIN. Terms and Conditions apply* **DE: Du könntest GEWINNEN.** Es gelten die Teilnahmebedingungen* **FR: Tu pourrais GAGNER.** Des conditions s'appliquent* **IT: Potresti VINCERE tu.** Termini e condizioni sono applicabili* **ES: Puedes GANAR.** Aplican términos y condiciones* **PT: Poderá GANHAR.** Aplicam-se termos e condições* **ZH: 轻松获奖. 条款和条件适用*** **PL: Szansa na WYGRANĄ.** Obowiązują warunki korzystania* **CS: Máte šanci VYHRÁT.** Platí všeobecné smluvní podmínky* **SK: Máte šancu VYHRAŤ.** Platia všeobecné zmluvné podmienky* **HU: TE IS NYERHETSZ.** Felhasználási feltételek érvényesek* **RO: Ai putea CÂȘTIGA.** Se aplică termeni și condiții* **BG: Можете да СПЕЧЕЛИТЕ.** Има определени правила и условия* **LV: Tu vari LAIMĒT.** Ir spēkā noteikumi un nosacījumi.* **ET: Sul on võimalus VÕITA.** Kehtivad tingimused* **LT: Jūs galite LAIMĖTI.** Taikomos sąlygos*

*[LEGO.com/productfeedback-terms](https://www.lego.com/productfeedback-terms)

LEGO and the LEGO logo are trademarks of the LEGO Group. ©2024 The LEGO Group.

WIZARDING WORLD and all related trademarks, characters, names, and indicia are © & ™ Warner Bros. Entertainment Inc. Publishing Rights © JKR. (s24)