



MARVEL

76281



Q LEGO® Builder



LEGO.com/sustainable-packaging



FR
DONNEZ
OU
RECYCLEZ



OU



OU



ASSOCIATION

MAGASIN

DÉCHÈTERIE

Adresses sur quefairedemesdechets.fr

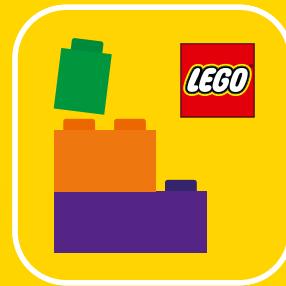

🔍 LEGO® Builder

BUILDER

Download on the
App Store

GET IT ON
Google Play

腾讯应用宝
安卓应用商店

Apple and the Apple logo are trademarks of Apple Inc., registered in the U.S. and other countries and regions. App Store is a service mark of Apple Inc. Google Play and the Google Play logo are trademarks of Google LLC. Tencent and the Tencent logo are trademarks of Tencent Inc.

🔍 LEGO.com/devicecheck

EN Ask parents' permission before going online | **DE** Eltern um Erlaubnis bitten, bevor du online gehst | **FR** Demande l'autorisation d'un parent avant d'aller en ligne | **IT** Chiedi il permesso ai tuoi genitori prima di andare online | **ES** Pídeles permiso a tus papás antes de conectarte a Internet | **PT** Pede autorização aos pais antes de acederes online | **ZH** 上网前应先征得父母的同意 | **PL** Poproś rodziców o zgodę, zanim wejdiesz do Internetu | **CS** Než půjdeš na internet, požádej rodiče o svolení | **SK** Skôr než pôjdeš na internet, vypýtaj si povolenie od rodičov | **HU** Kérj szülői engedélyt, mielőtt online csatlakoznál! | **RO** Cere permisiunea părinților înainte de a te conecta online | **BG** Поискайте разрешение от родител, преди да влезете онлайн | **LV** Pirms došanās tiešsaistē palūdz atļauju vecākiem | **ET** Enne Interneti kasutamist küsi vanematelt luba | **LT** Prieš prisijungdami prie interneto, atsilkauskite tėvų

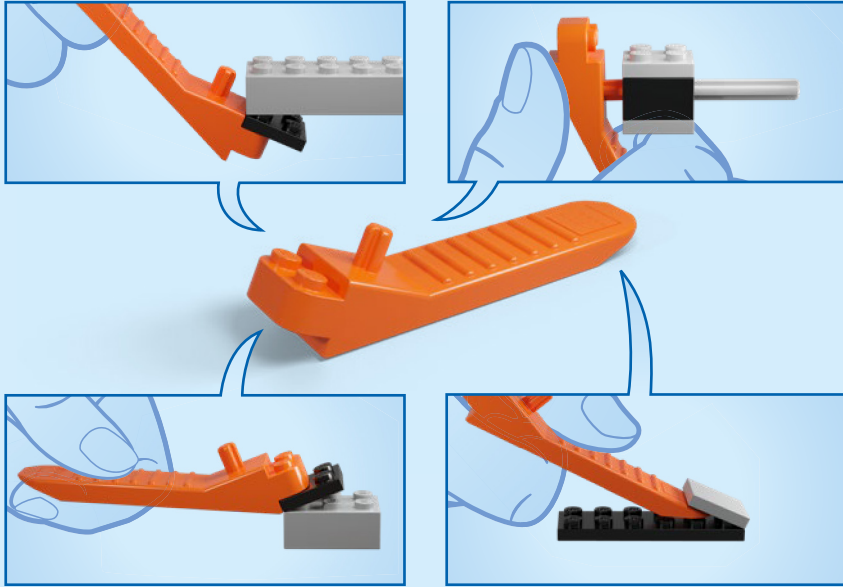

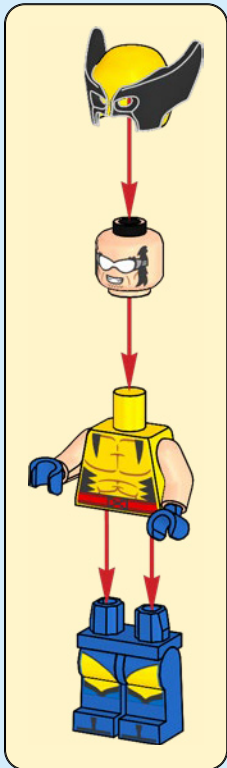

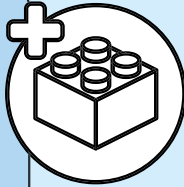
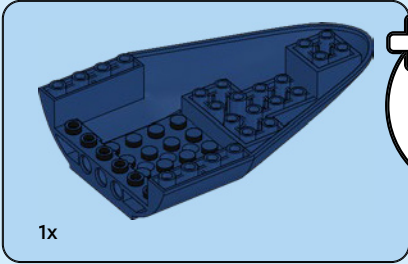
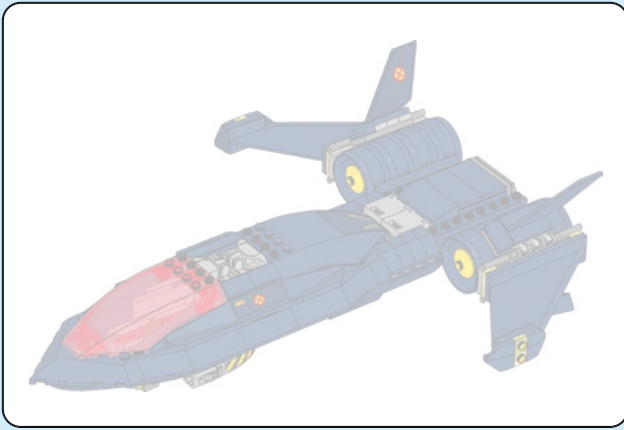

1

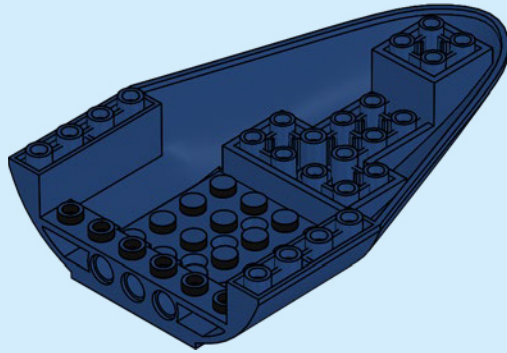

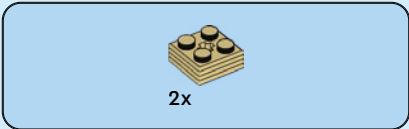

2

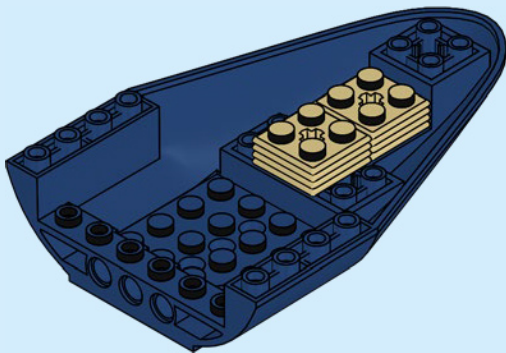

3

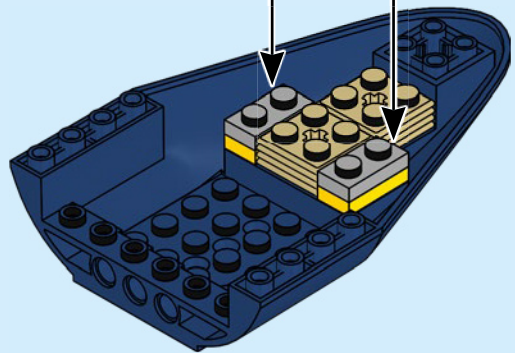
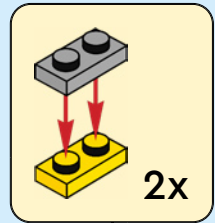



2x

4

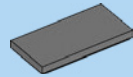
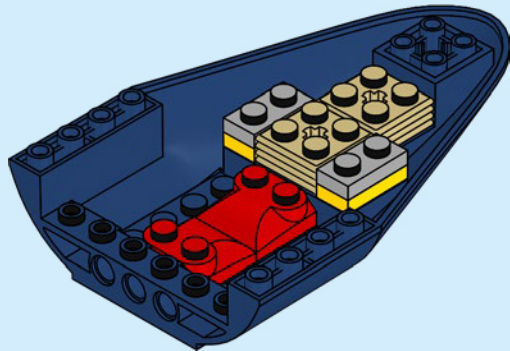

1x

5

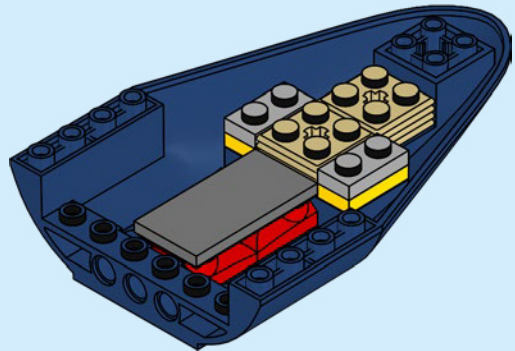

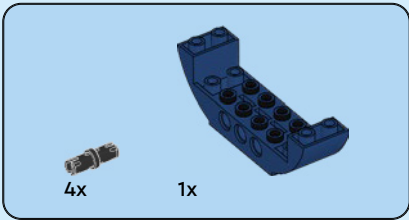

6

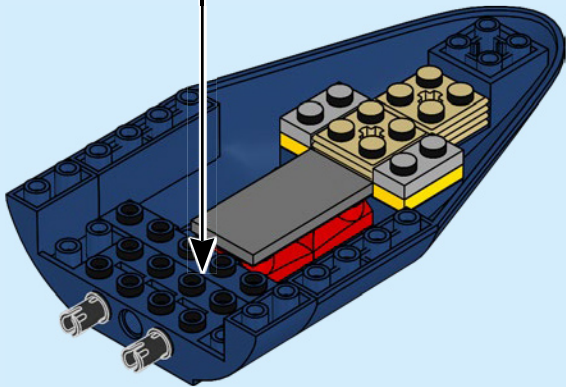
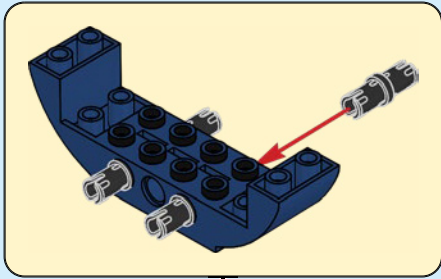

7

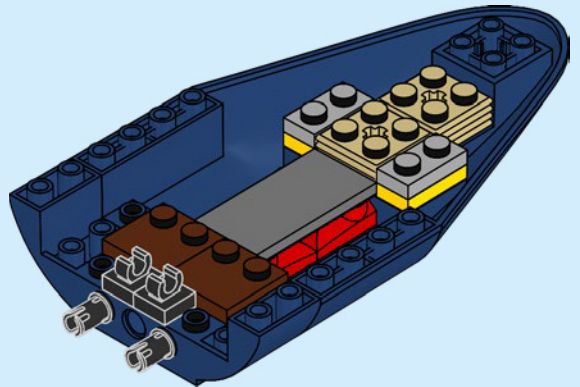

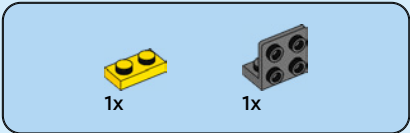

8

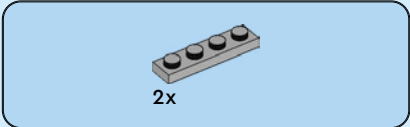
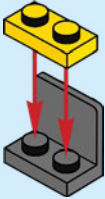

9

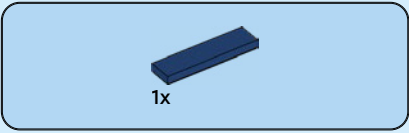
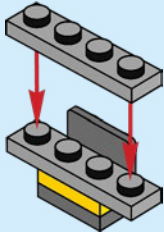

10

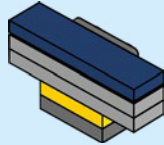

11

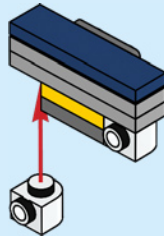

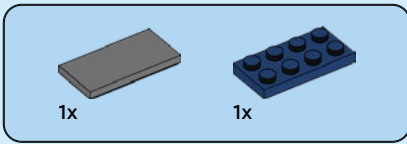

12

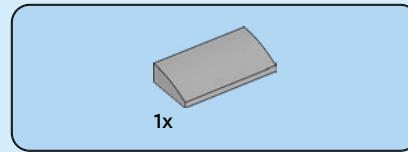
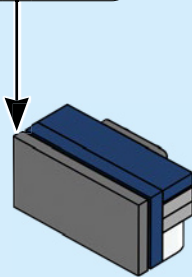
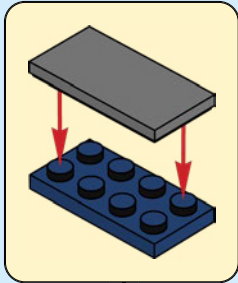

13

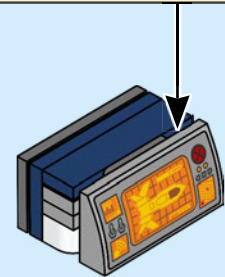
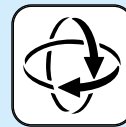
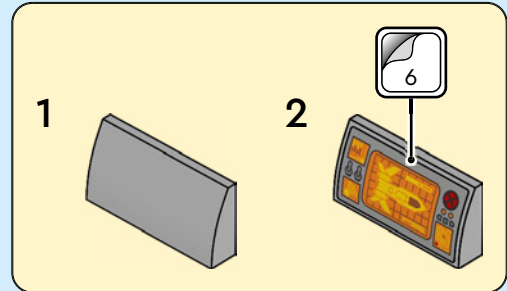

14

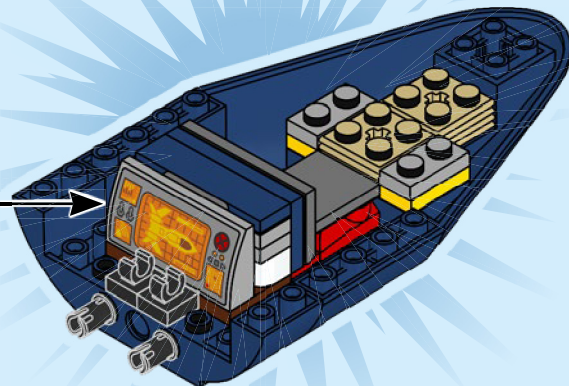

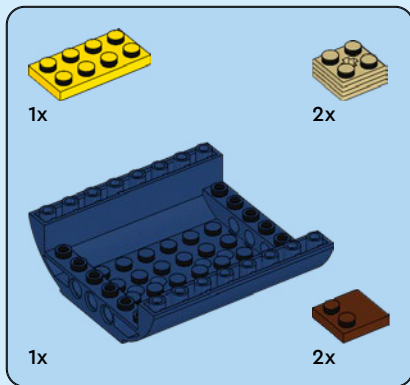

15

1

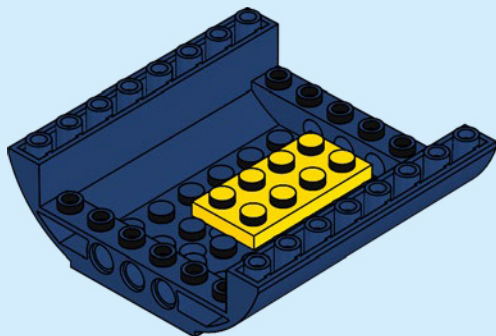

2

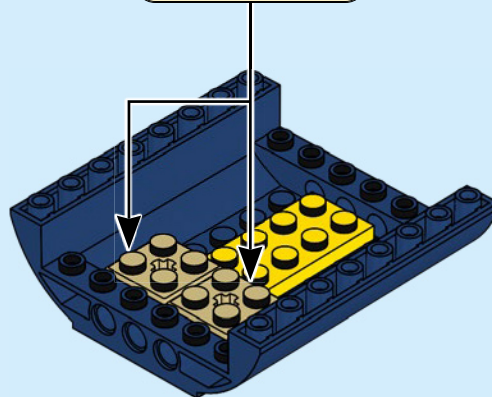
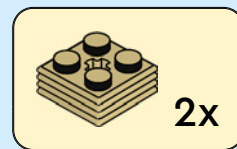

3

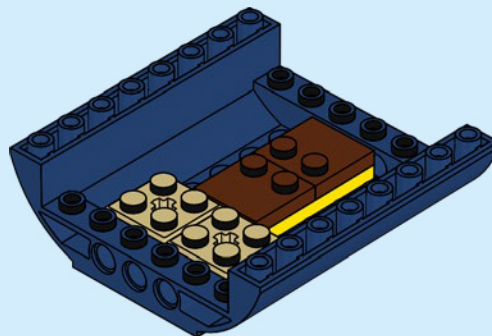

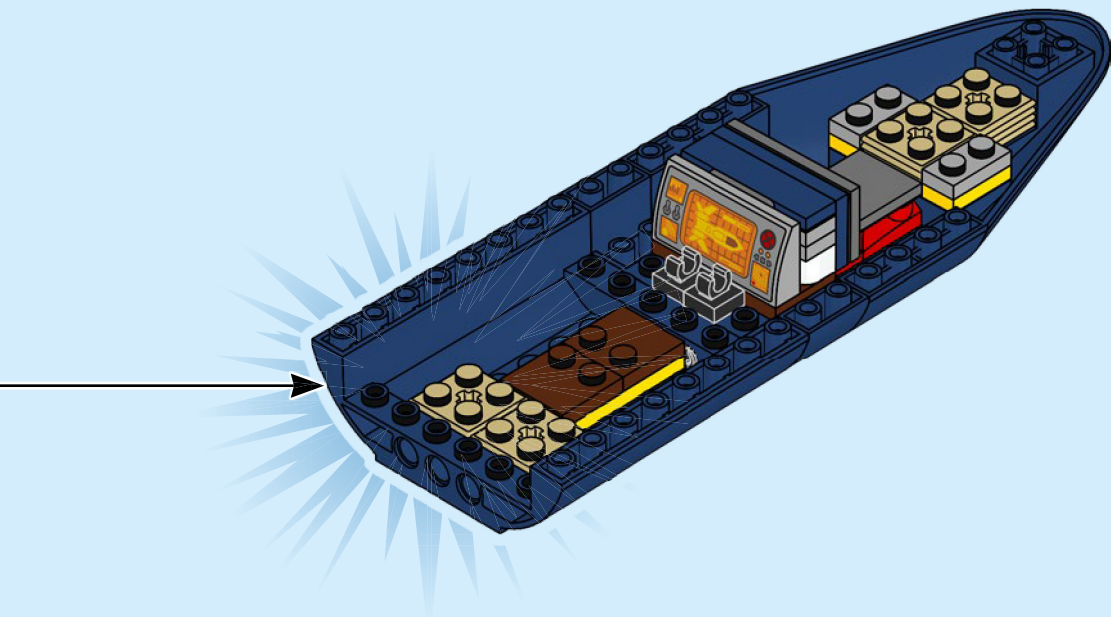

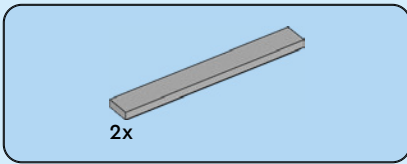

16

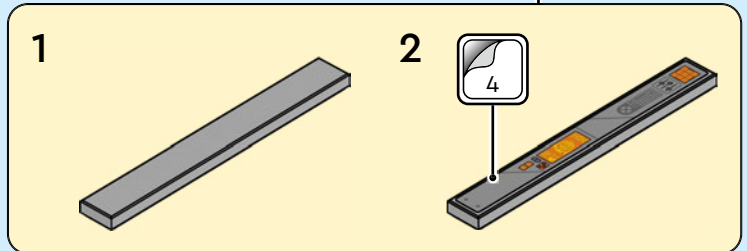
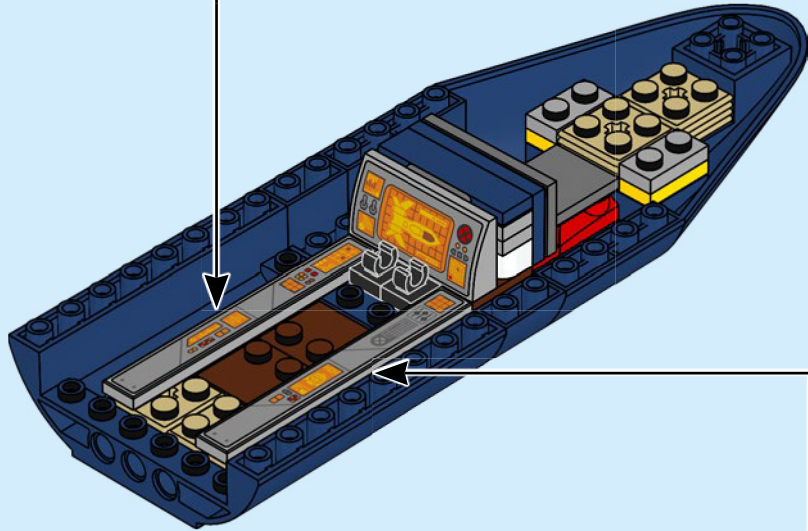
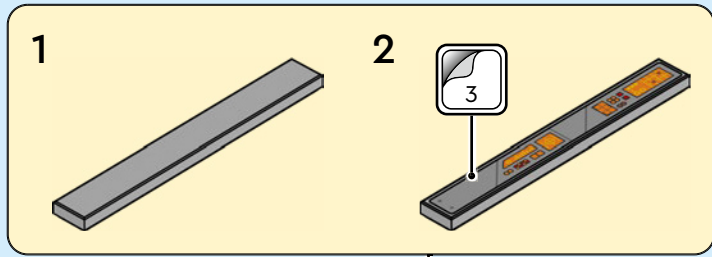

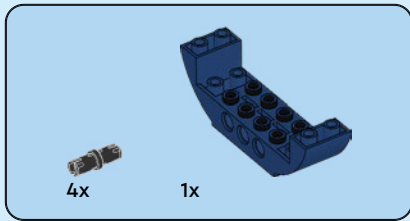

17

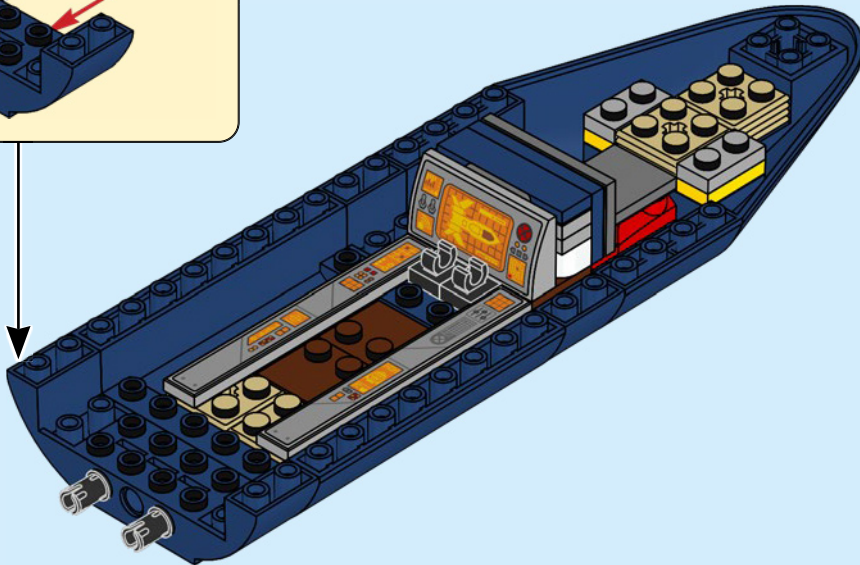
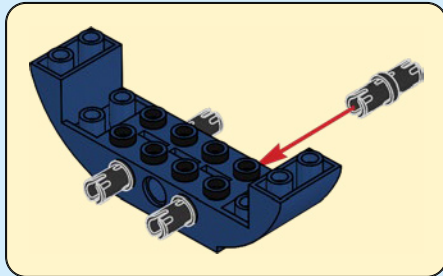

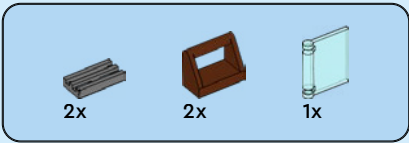

18

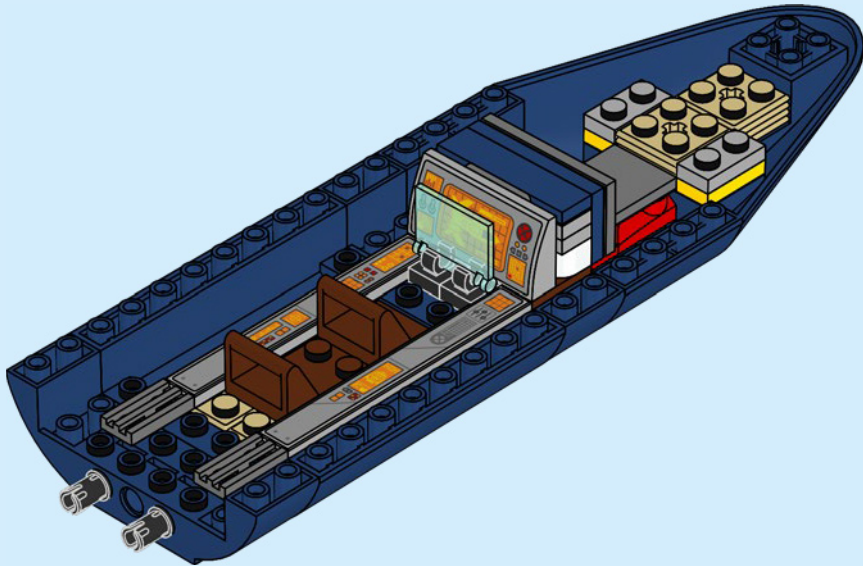

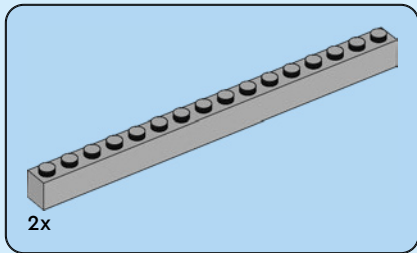

19

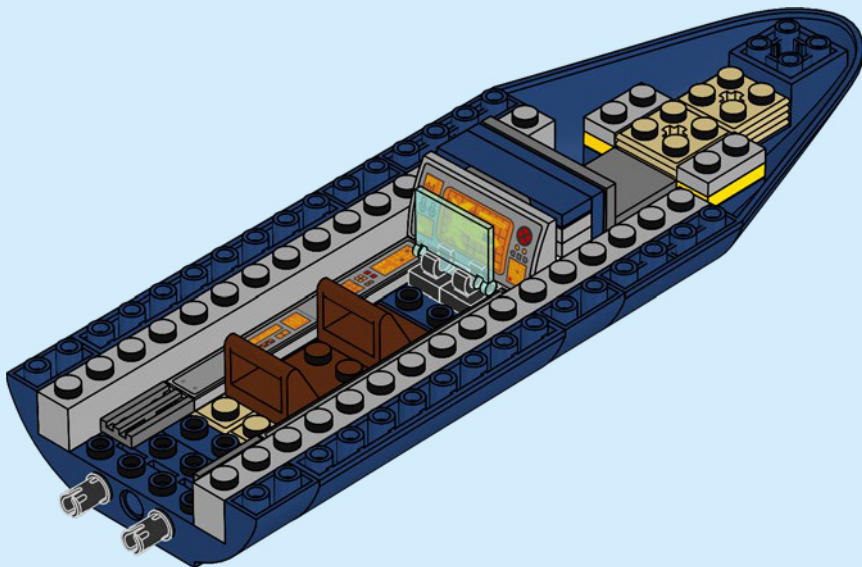

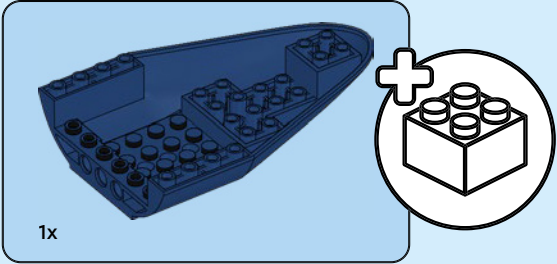
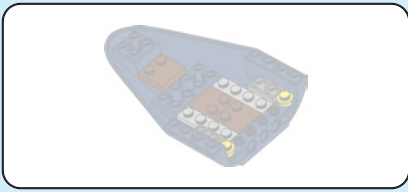

20

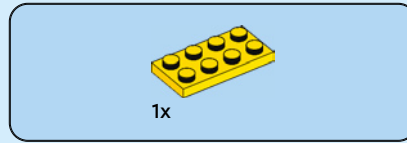
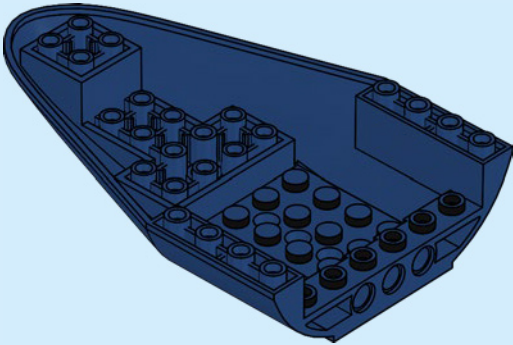

21

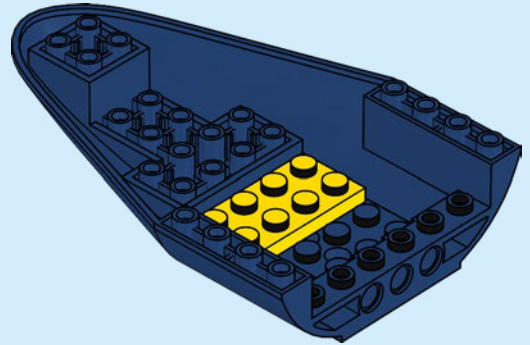

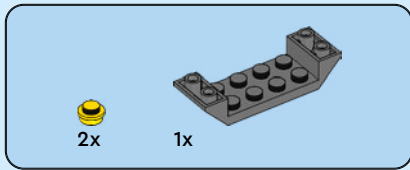

22

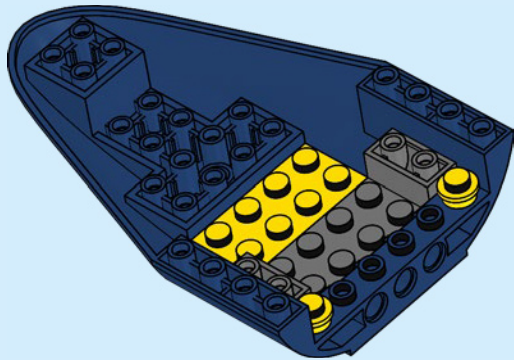

23

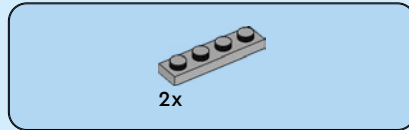
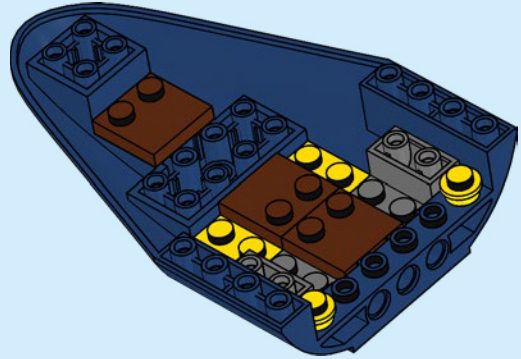

24

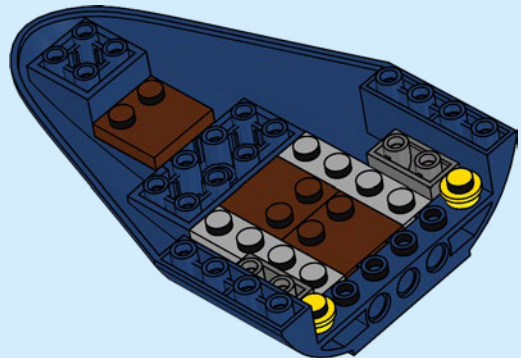

25

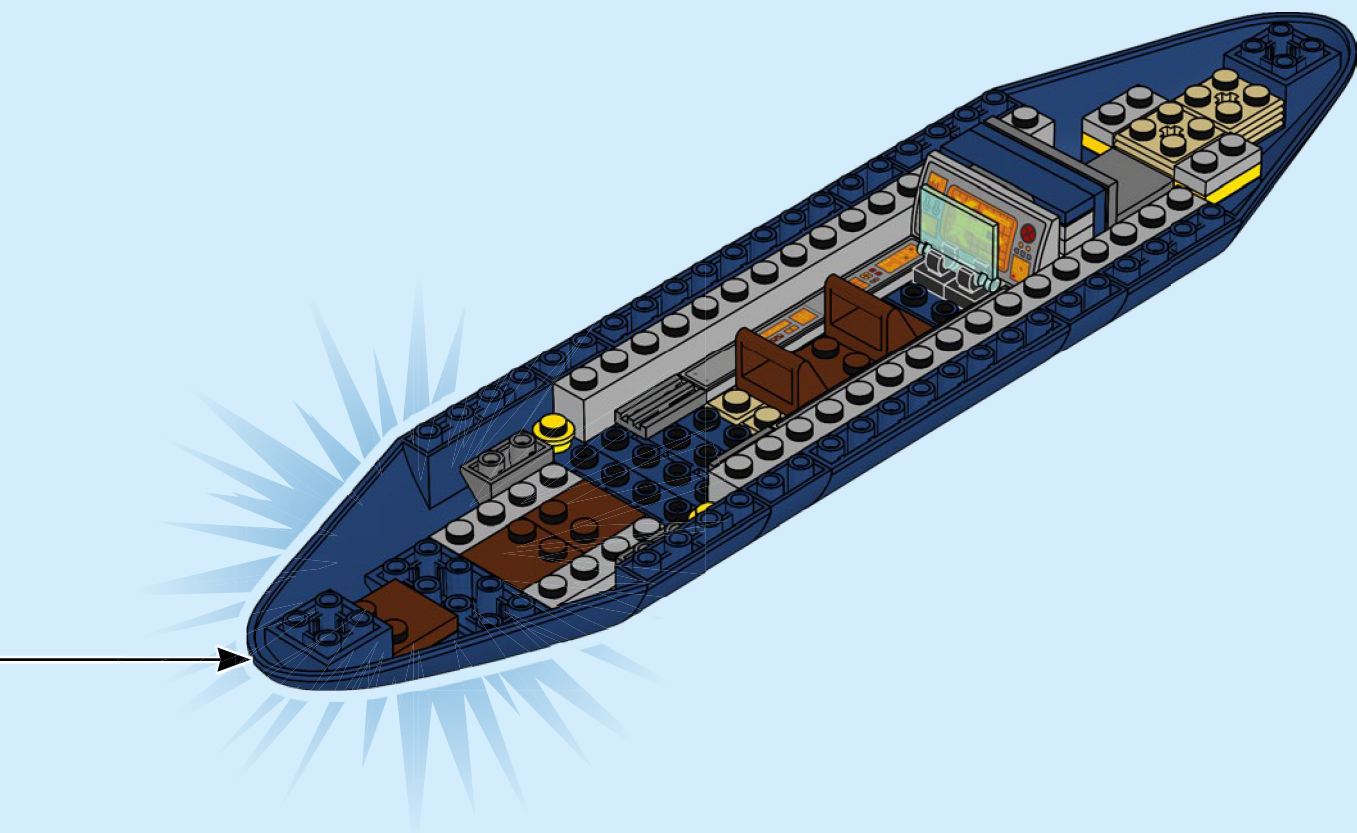

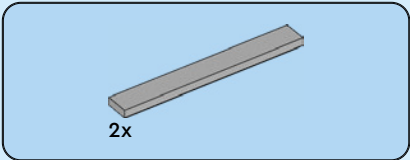

26

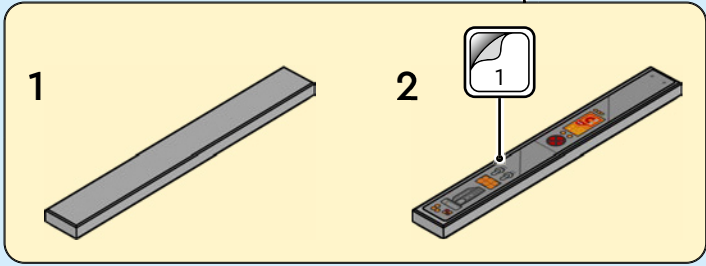
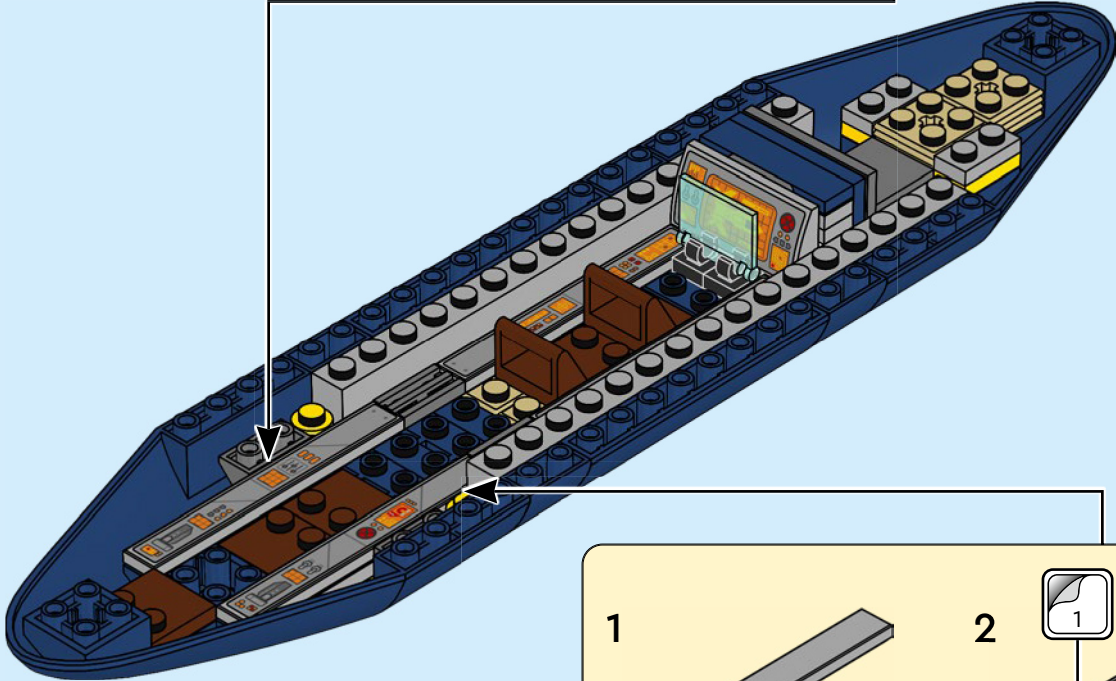
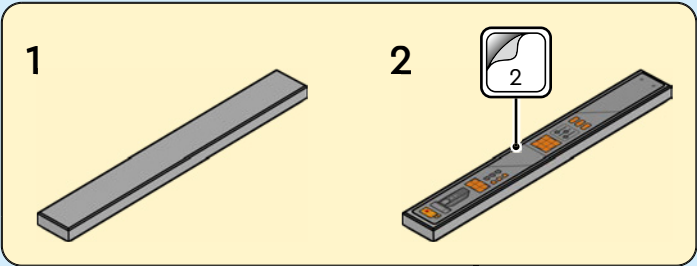

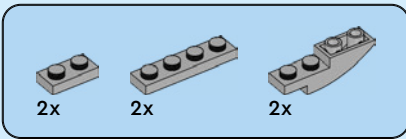

27

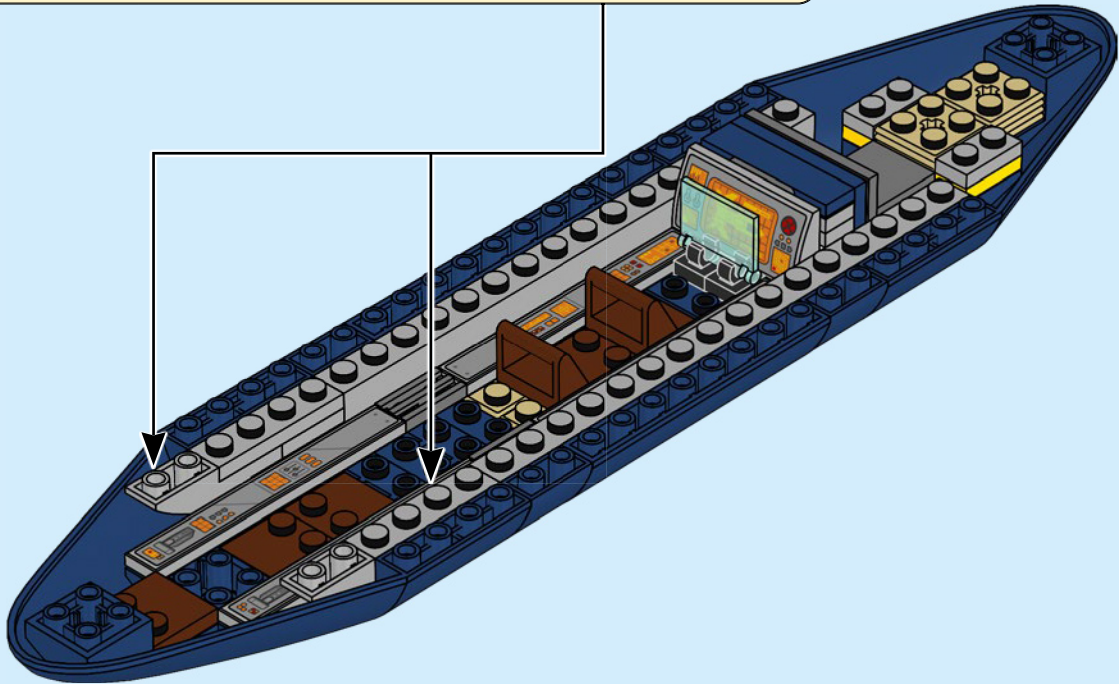
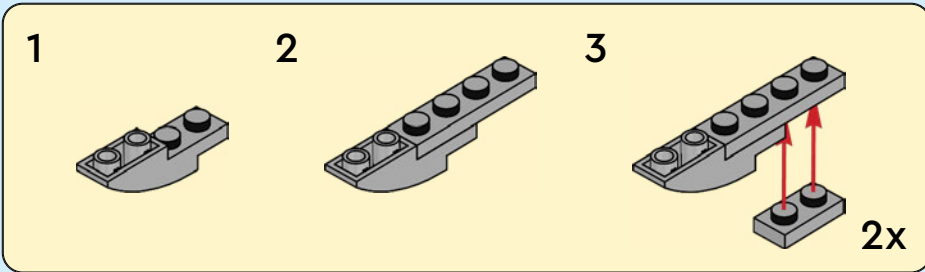

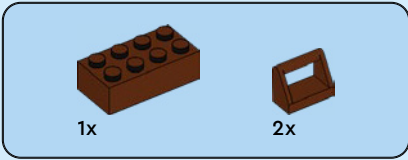

28

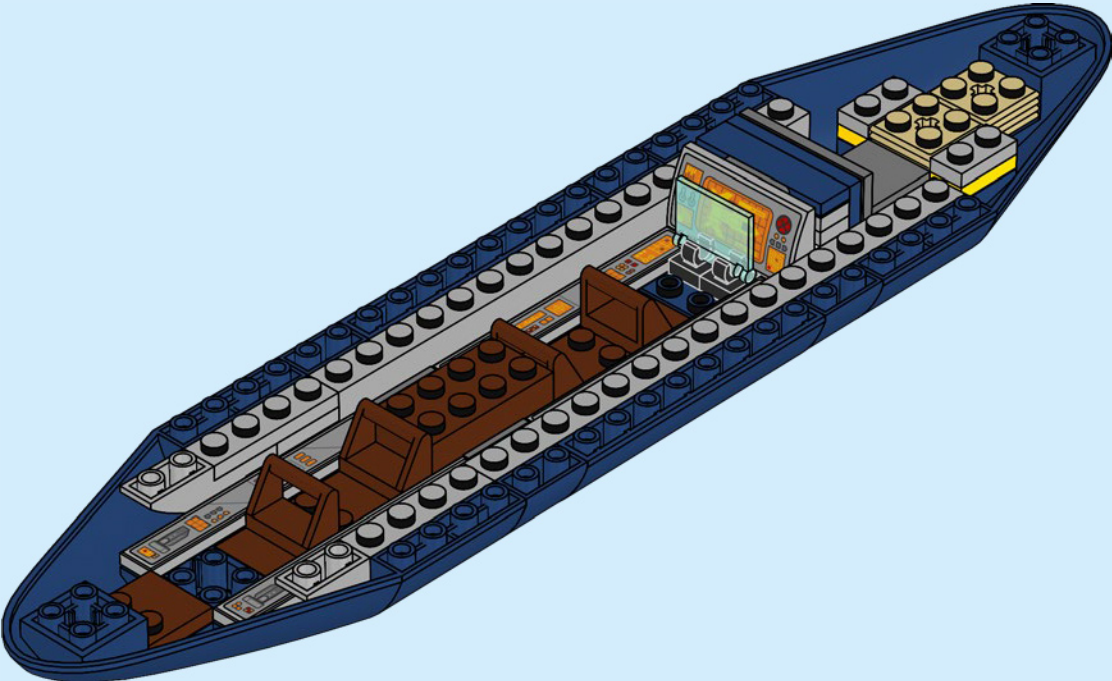

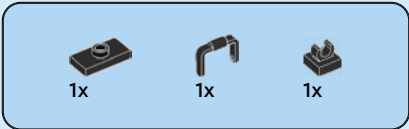

29

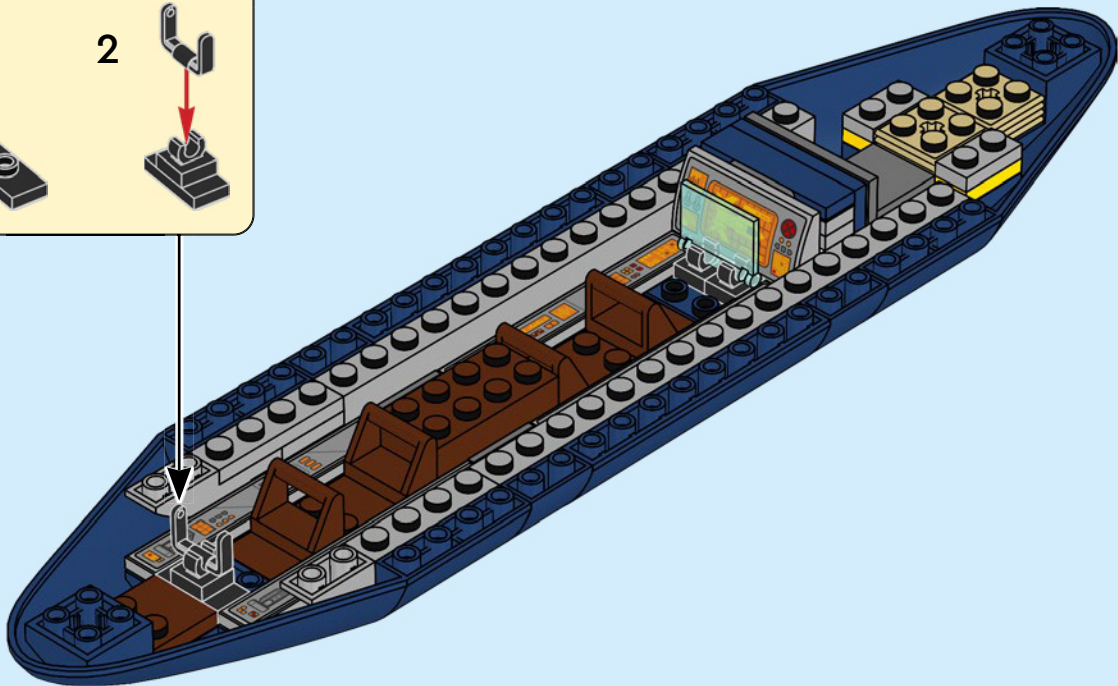
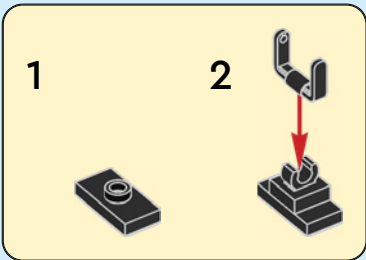

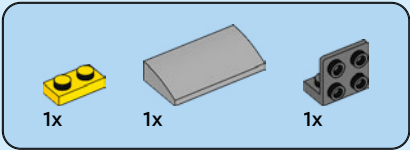

30

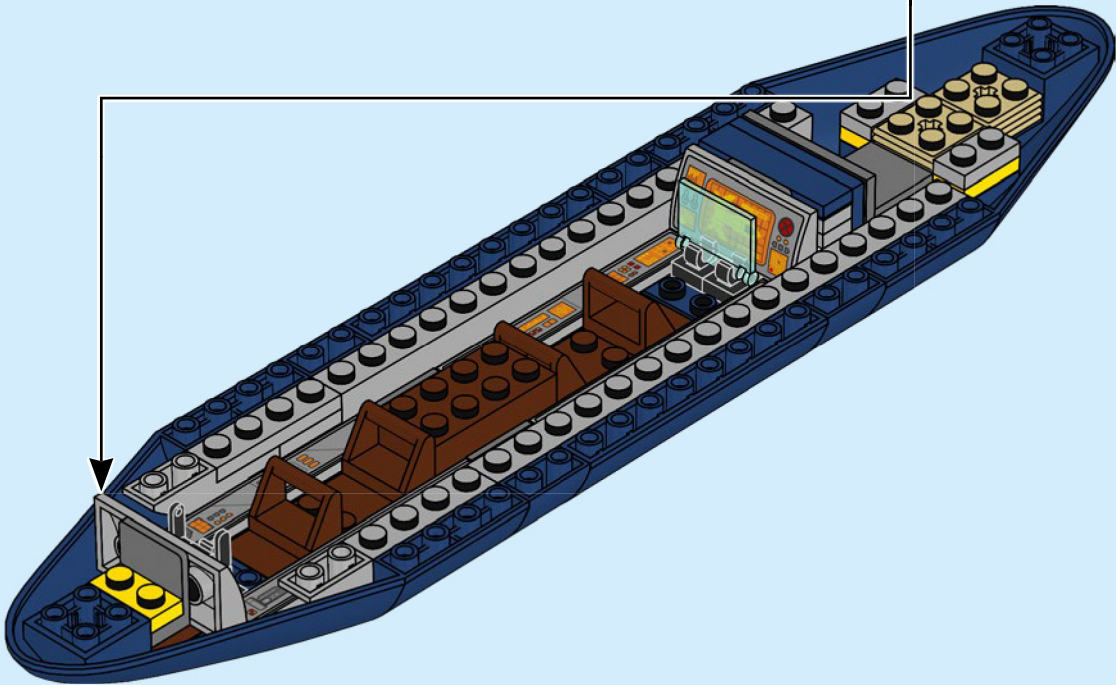
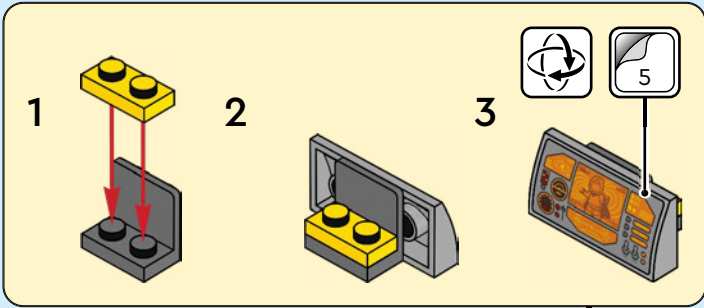

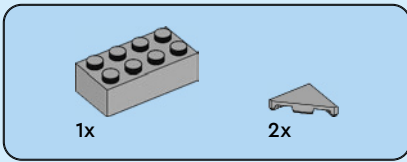

31

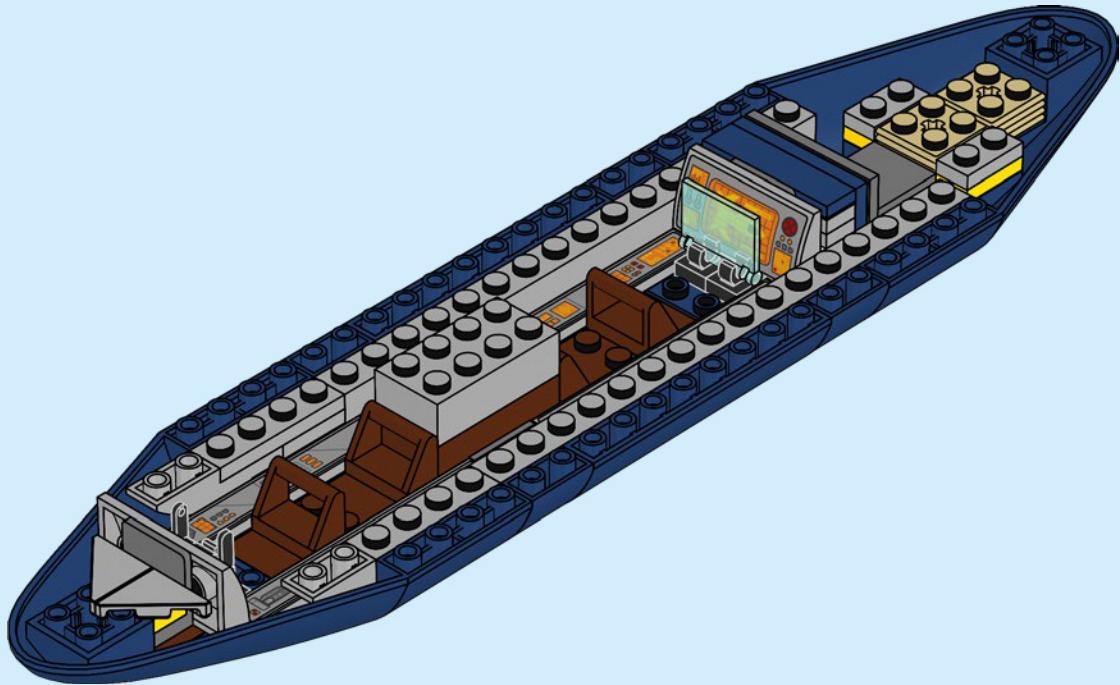



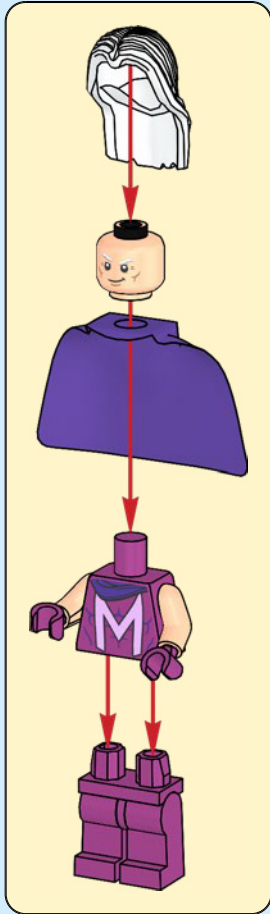

1



2

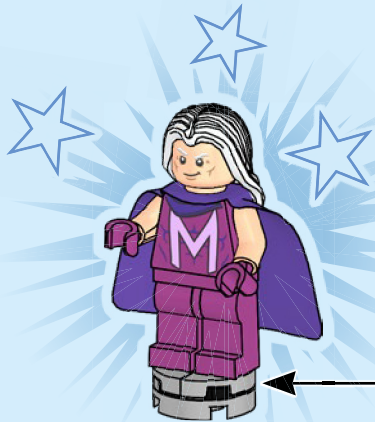

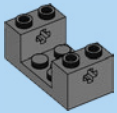

2x

32

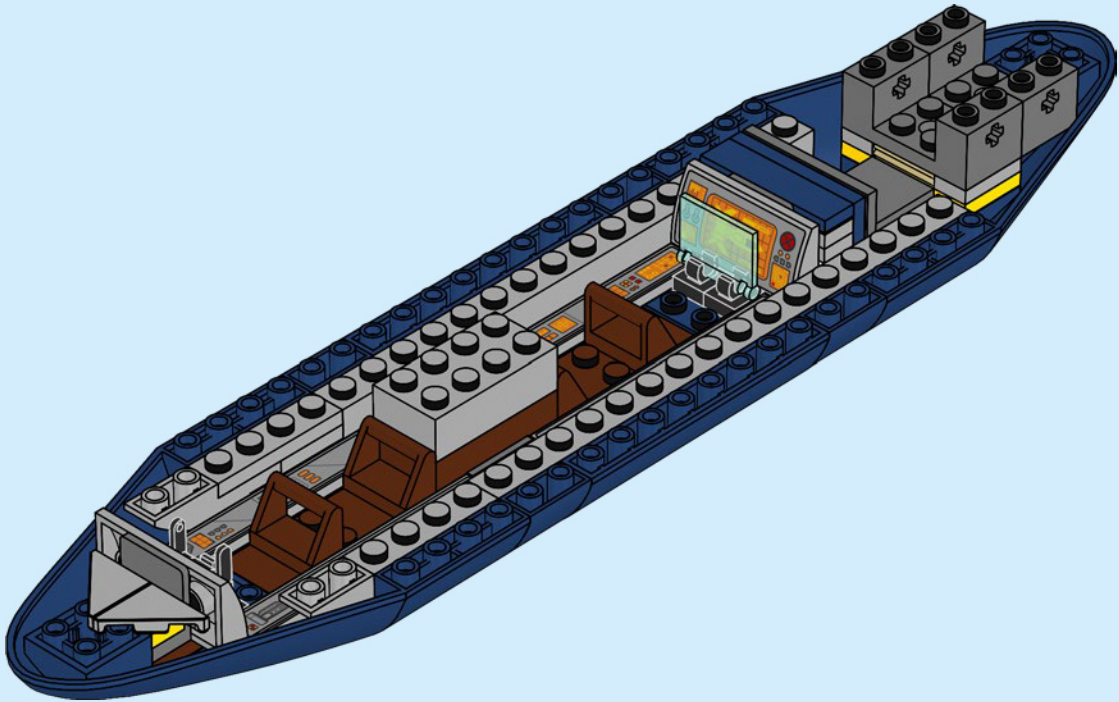

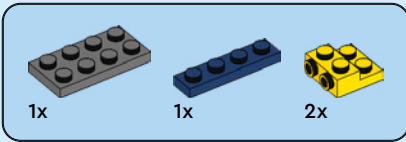

33

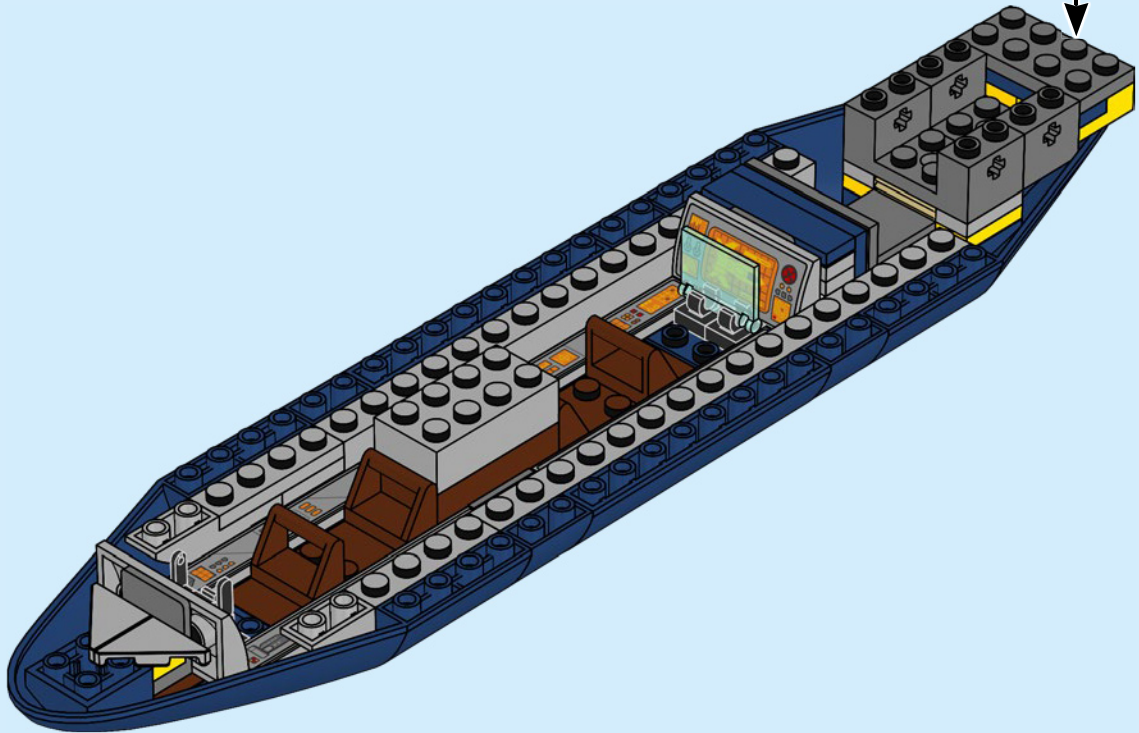
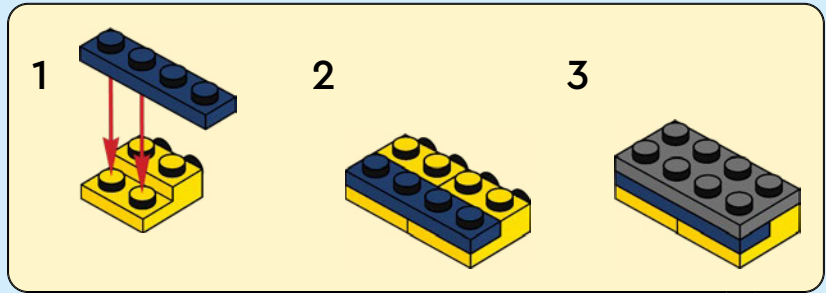

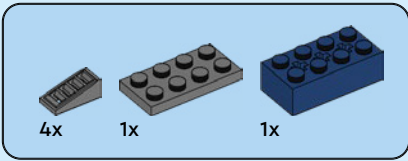

34

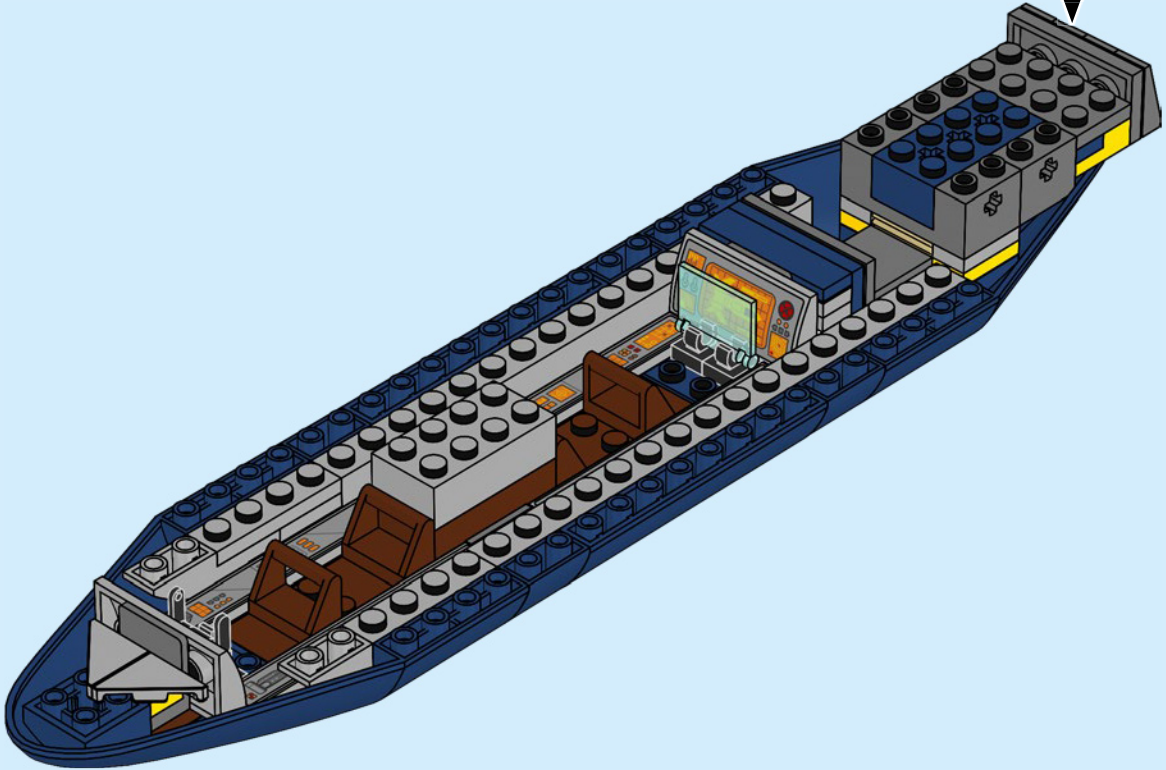
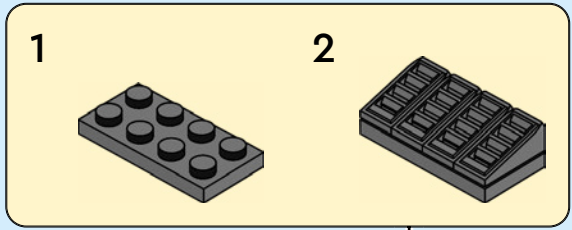

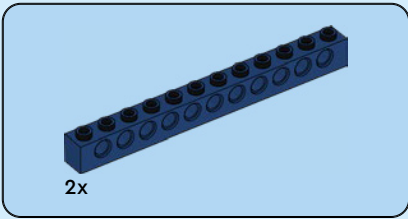

35

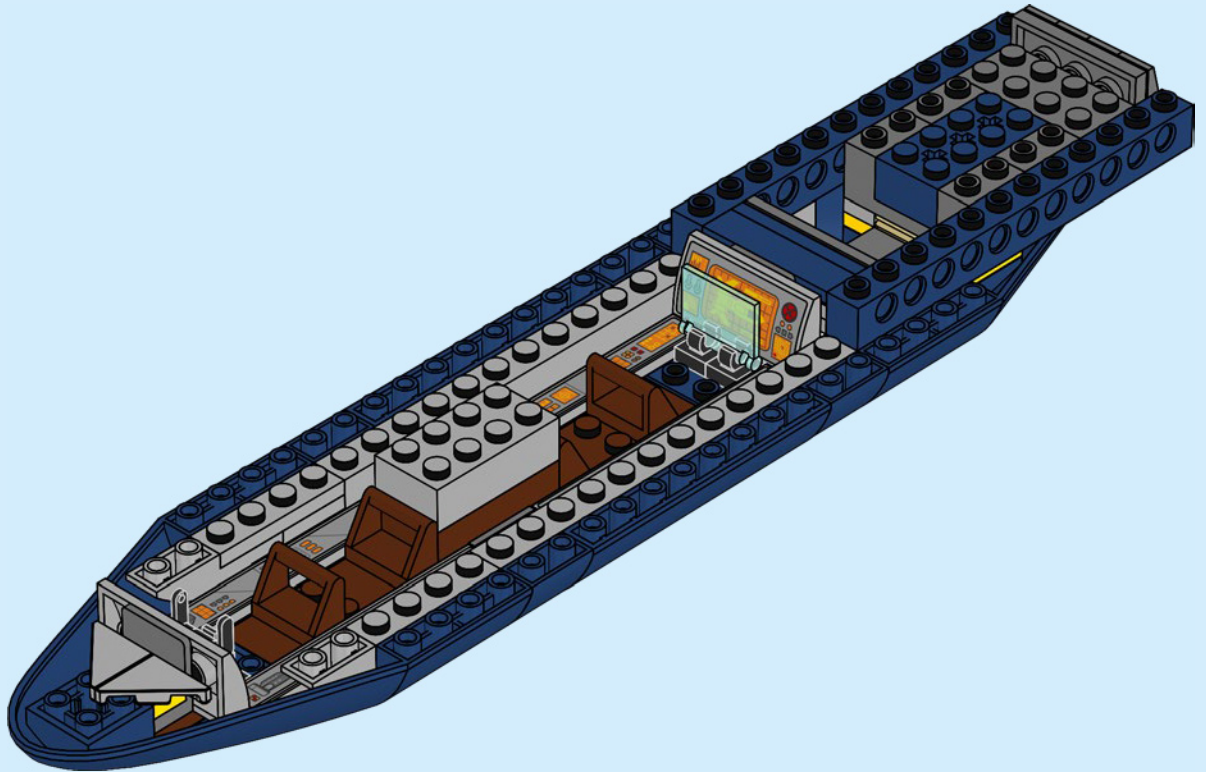

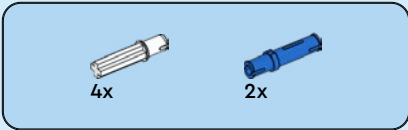

36

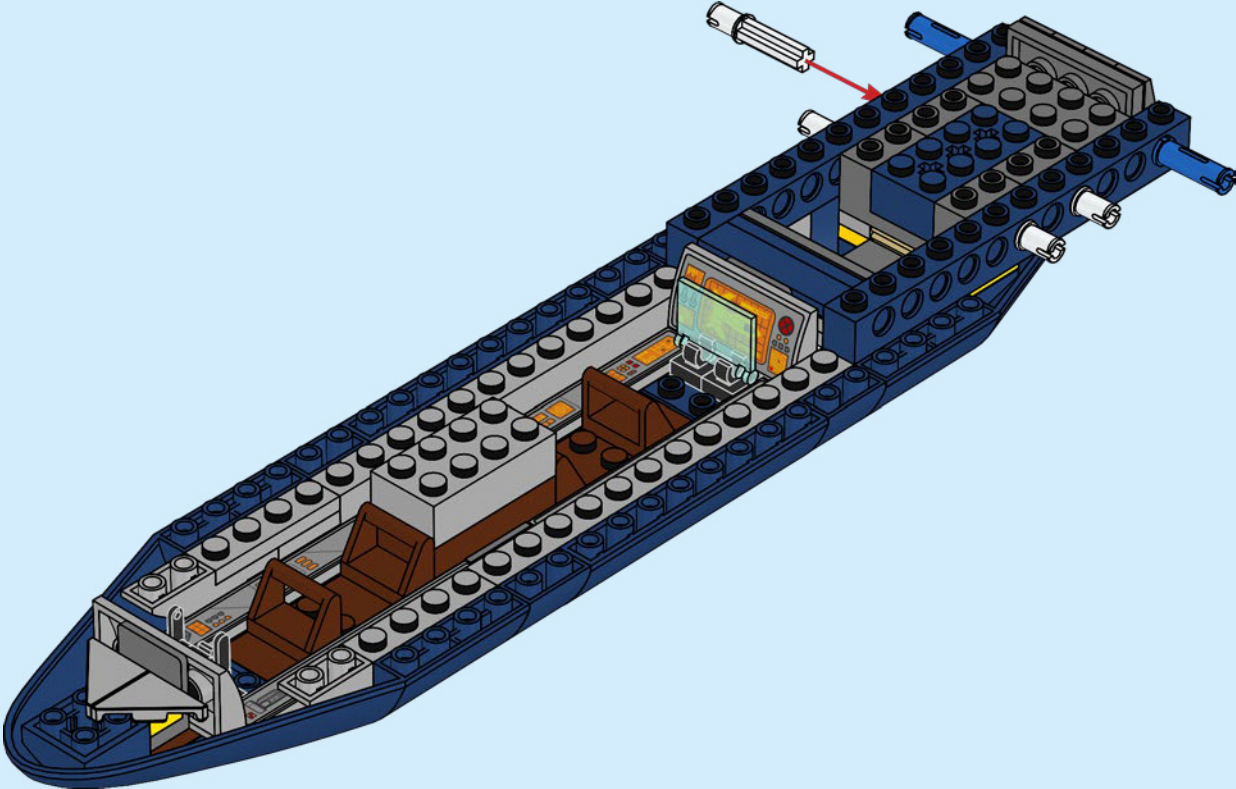

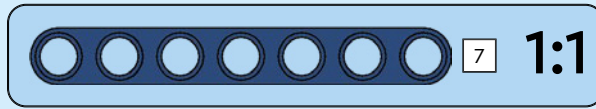
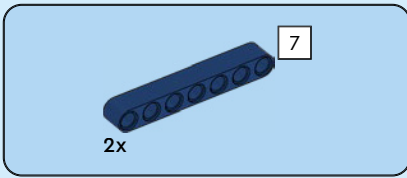

37

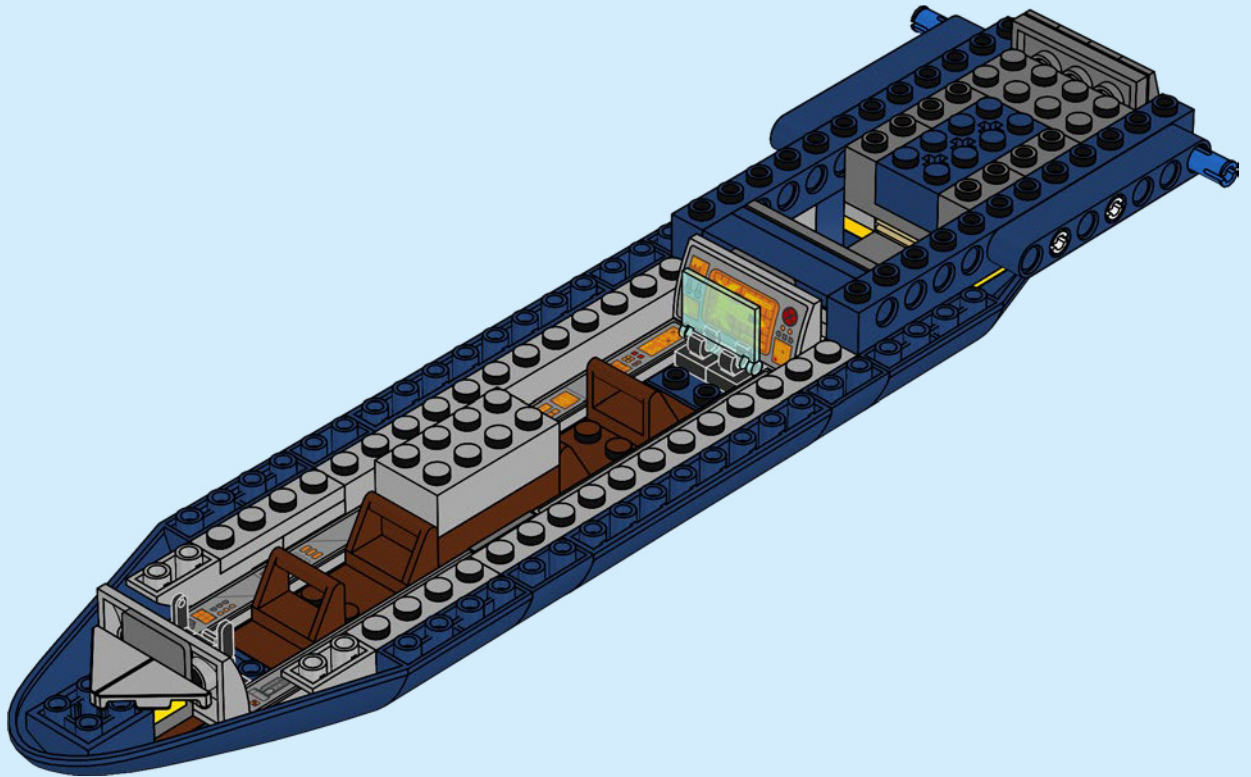



6x

38

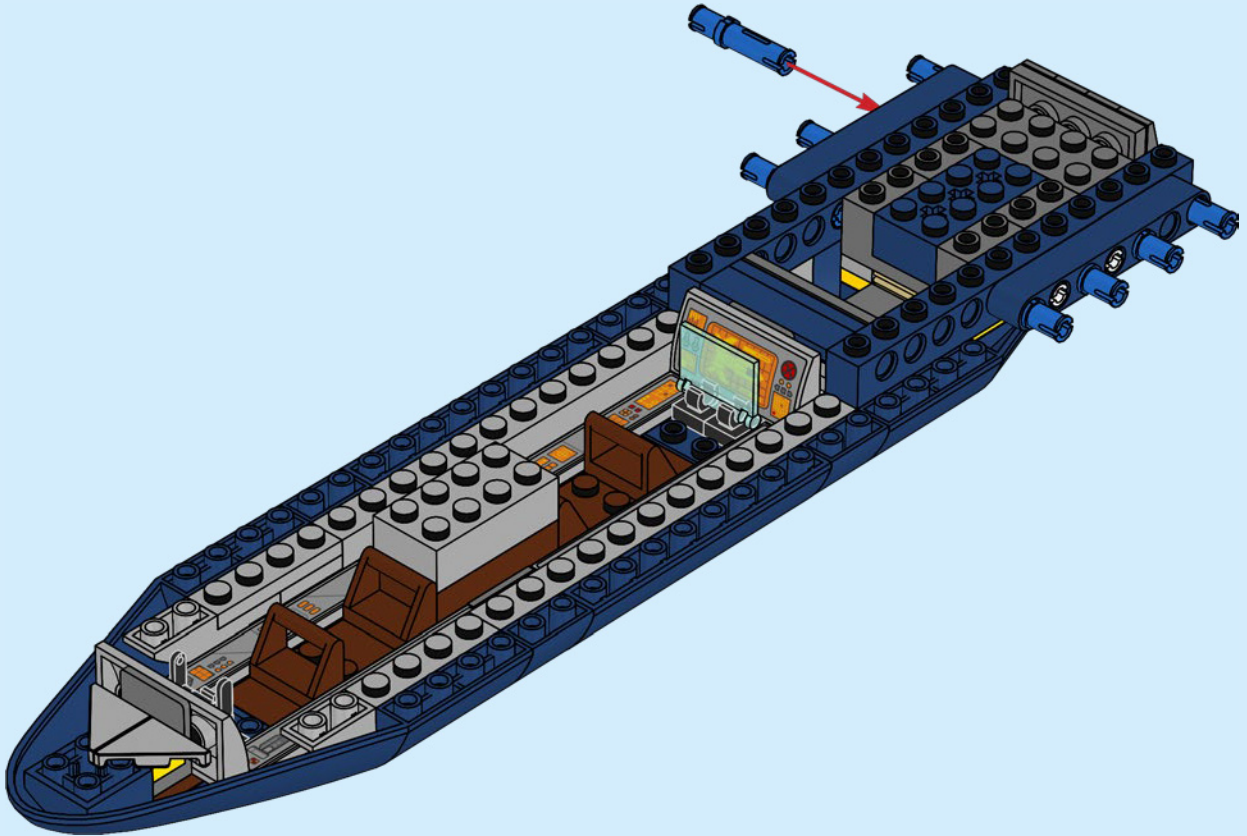

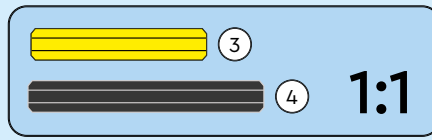
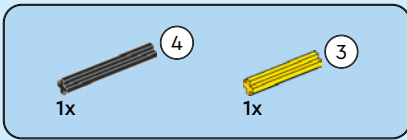

39

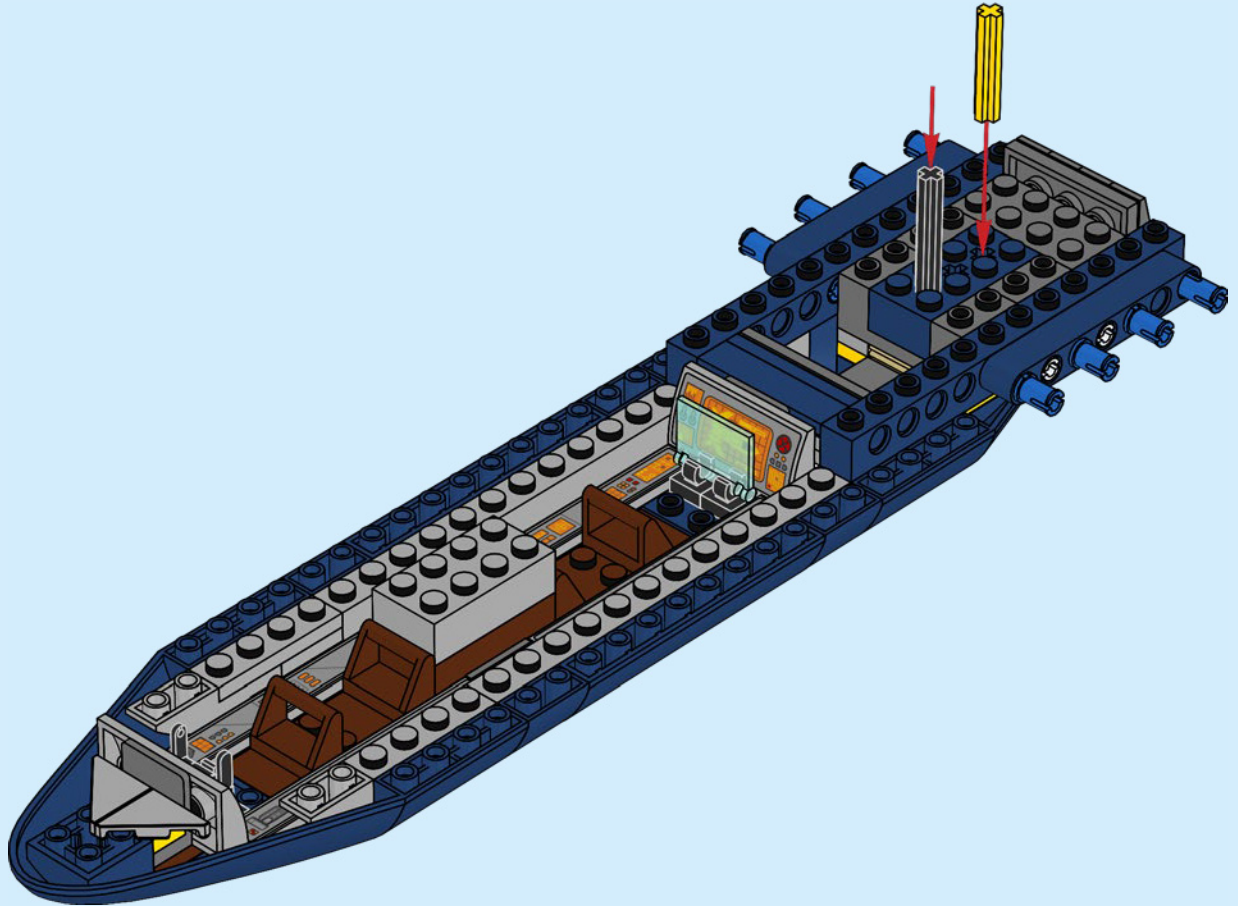



2x

40

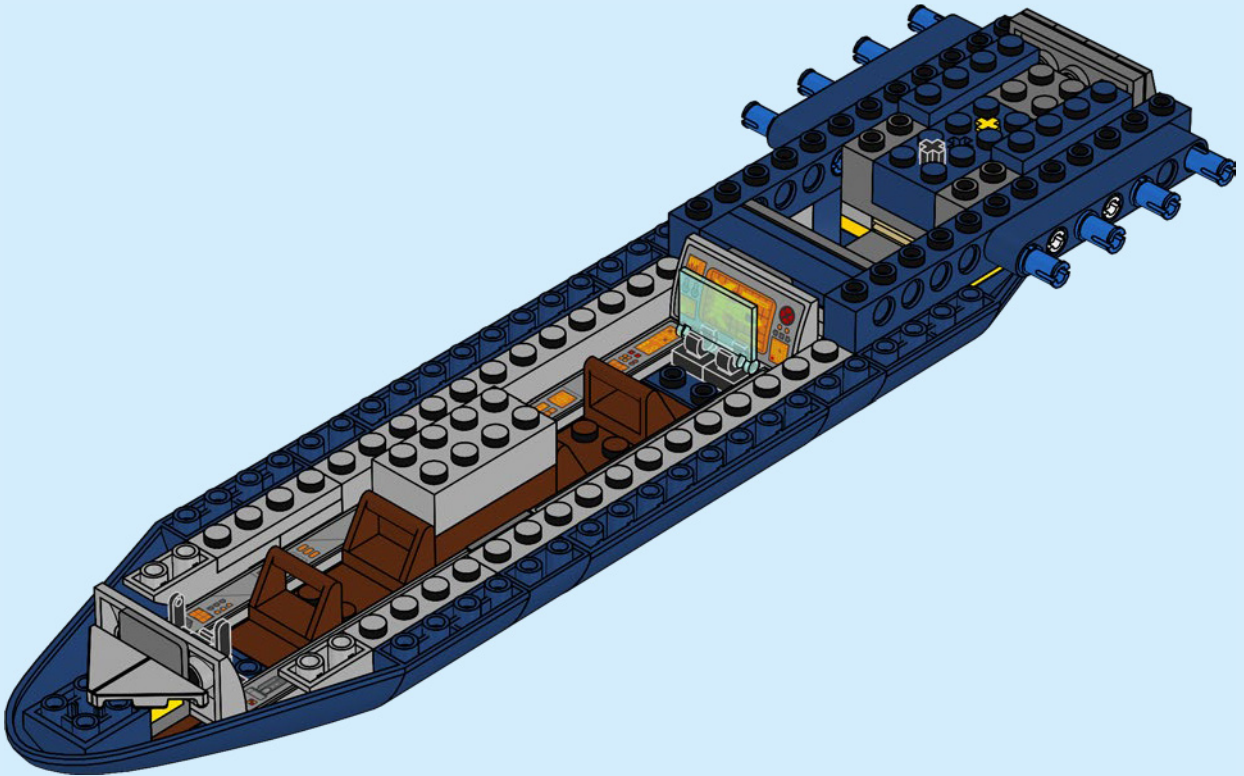

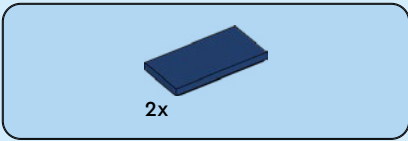

41

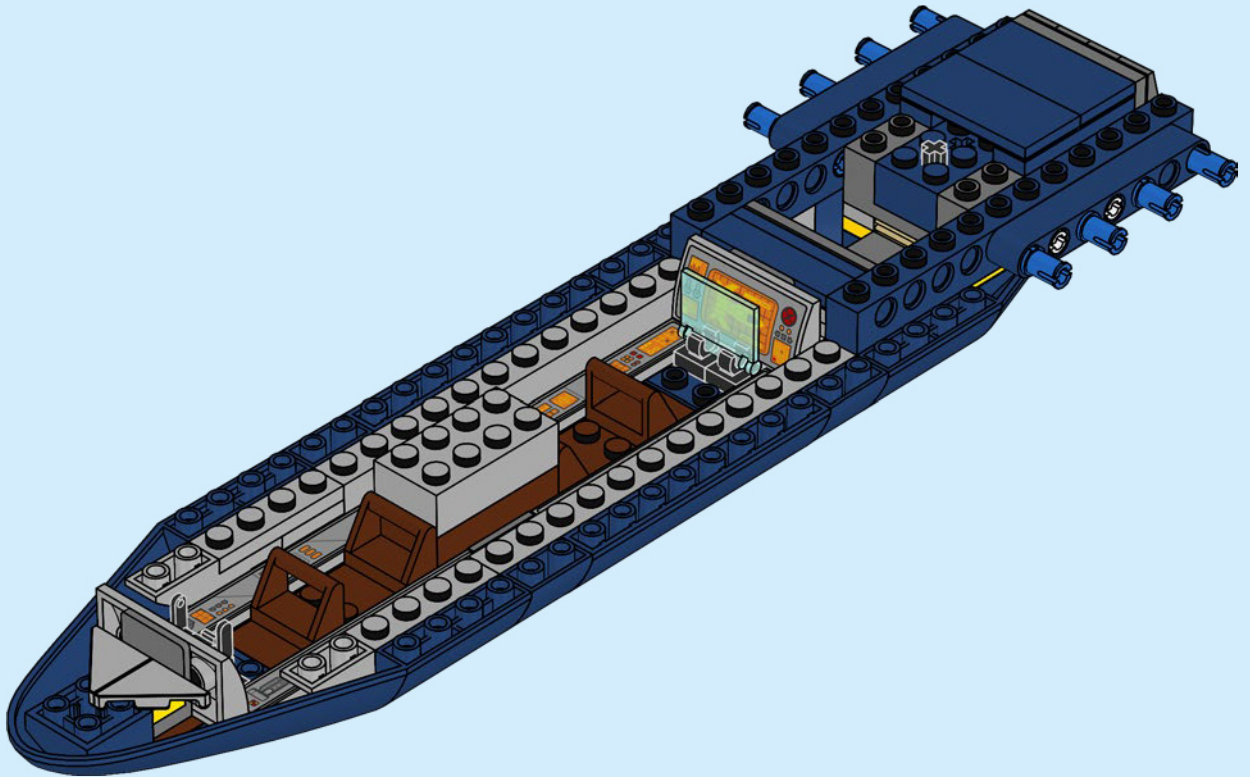

8x



8x

42



8x

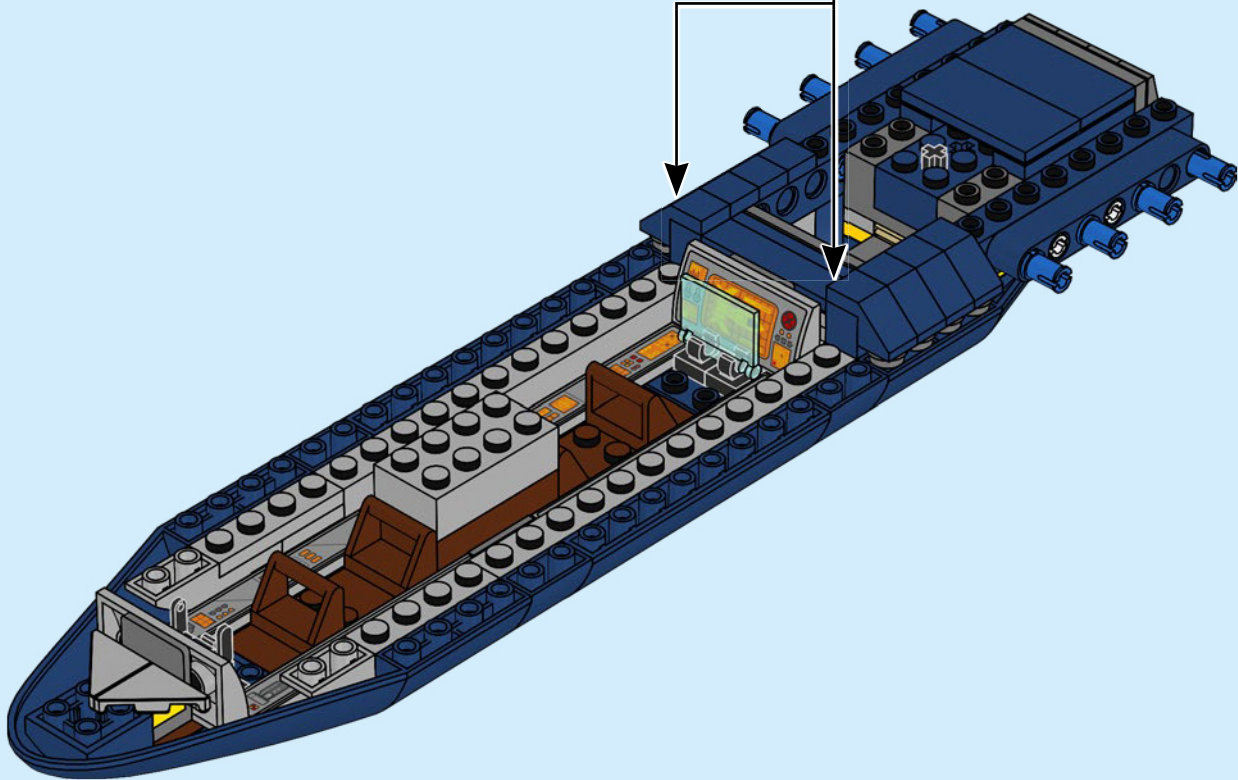



43

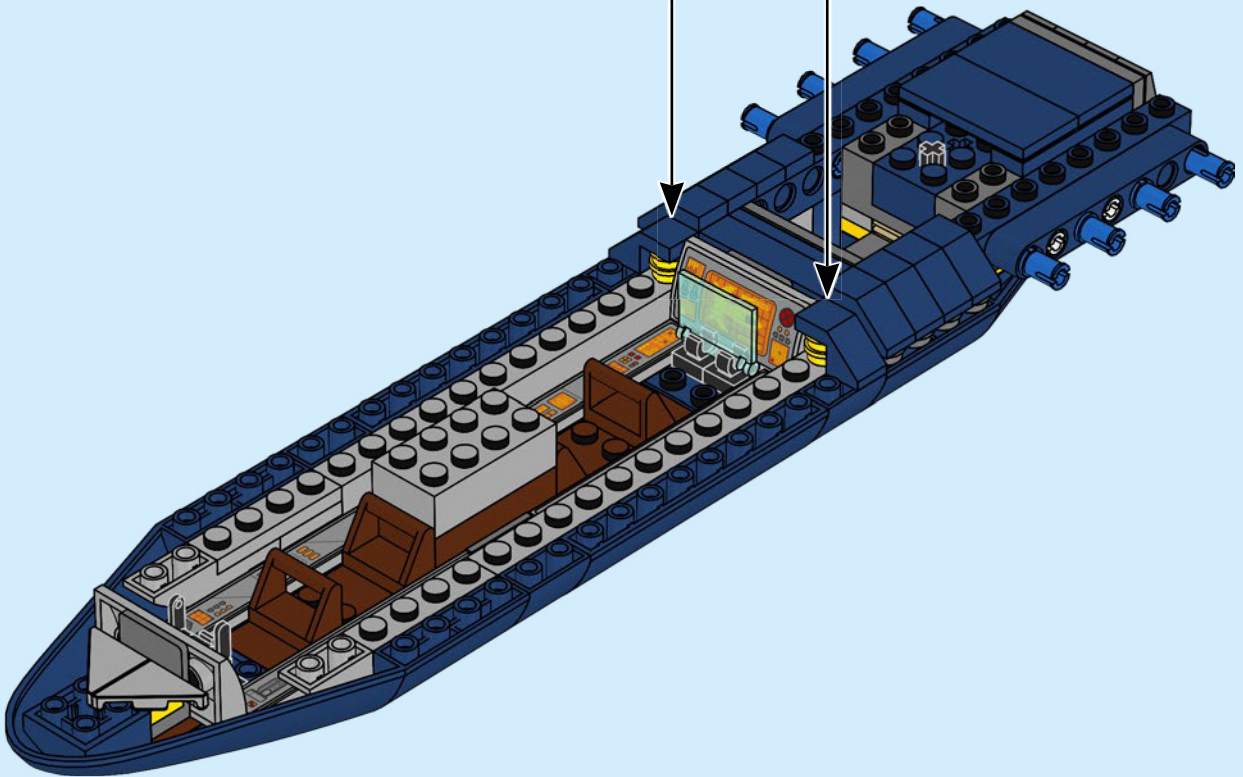
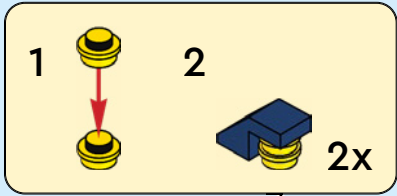

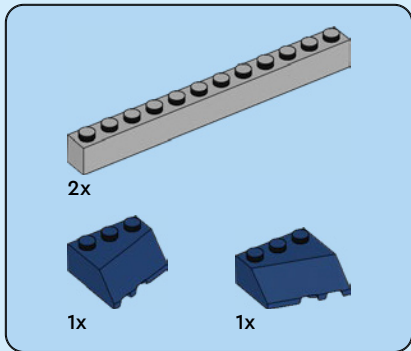

44

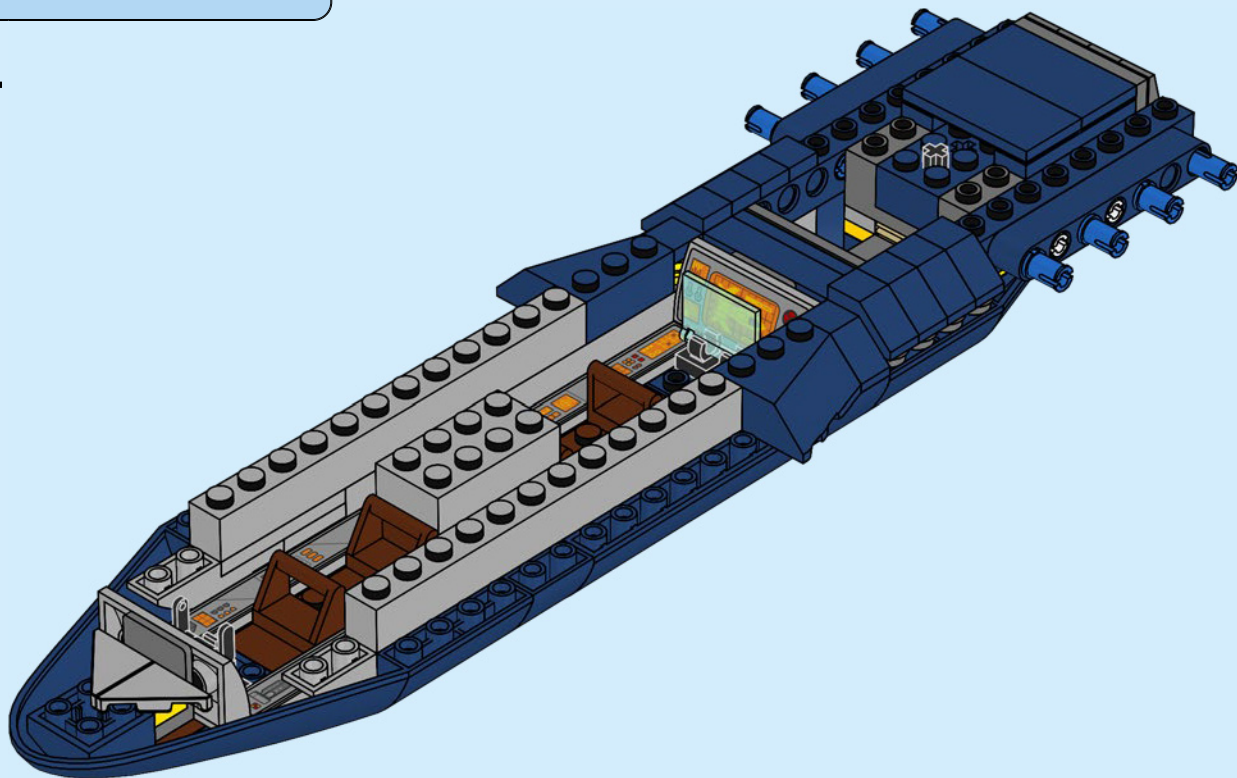

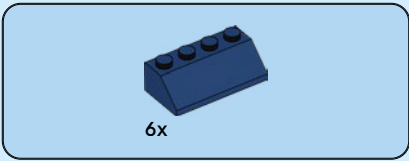

45

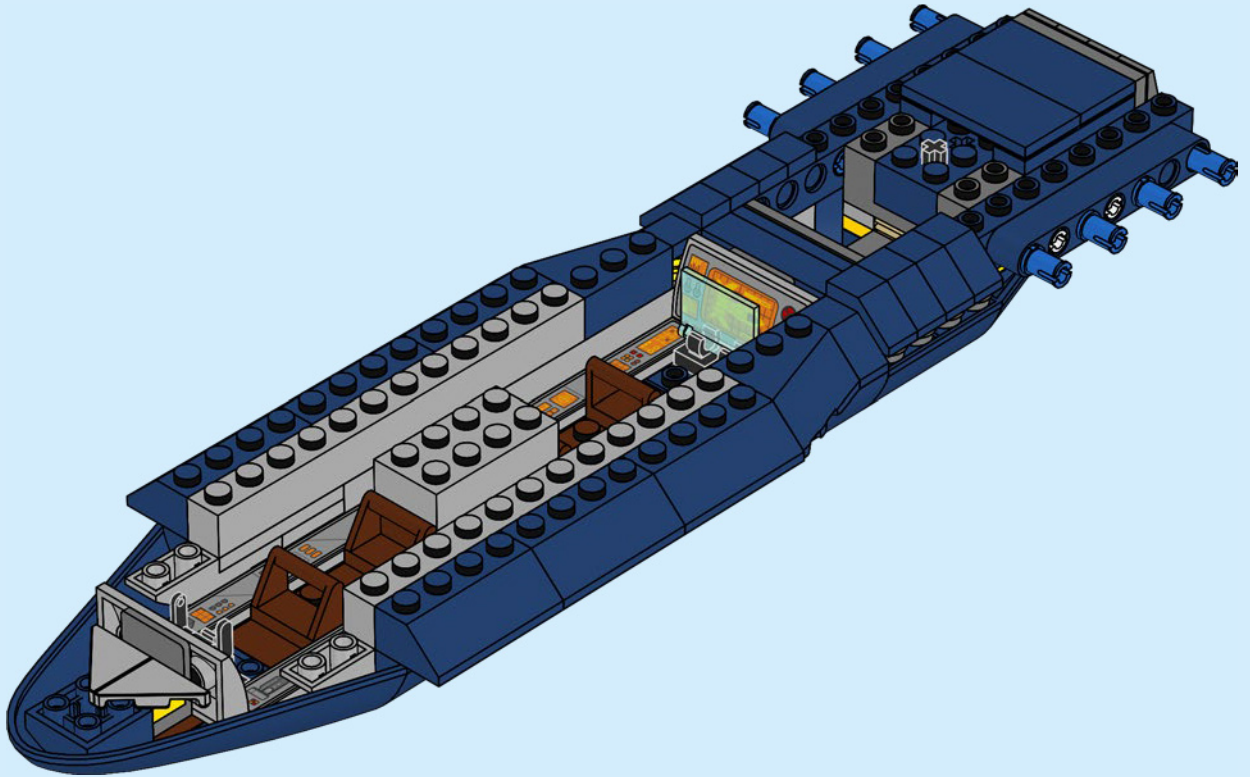



4x

46

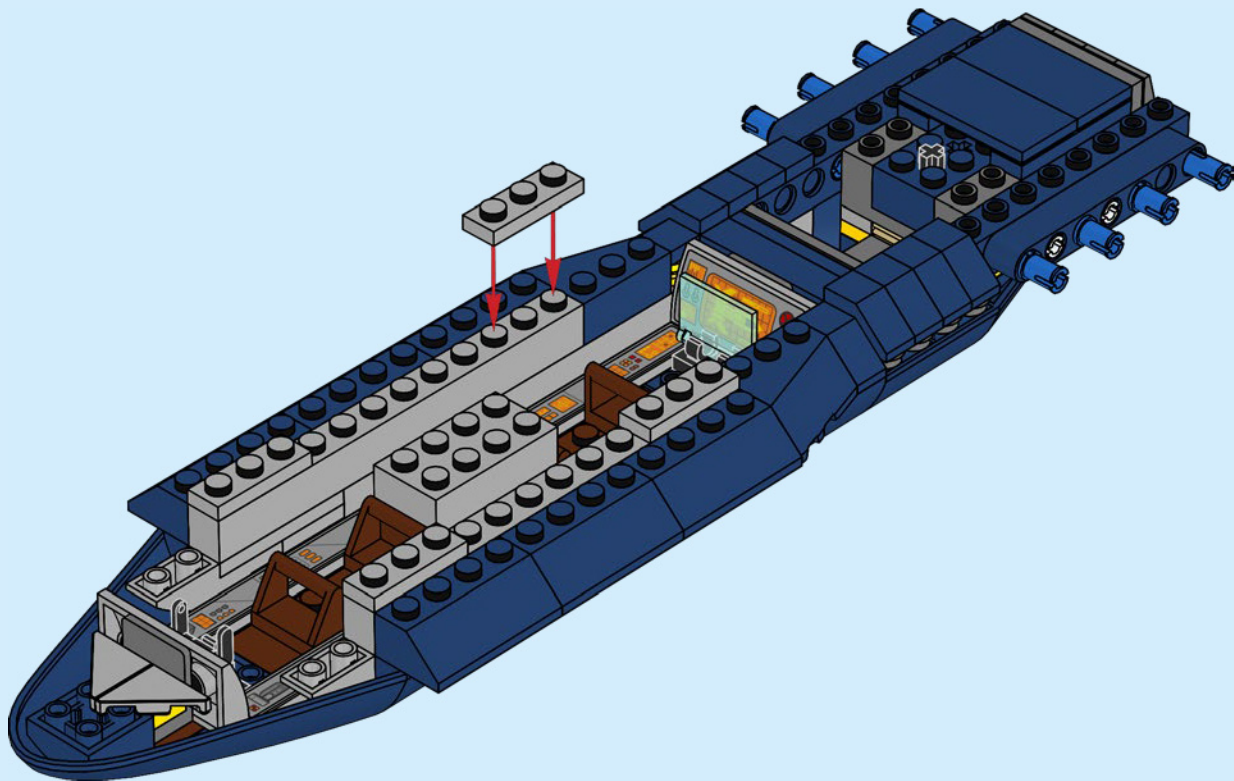

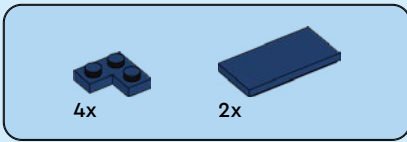

47

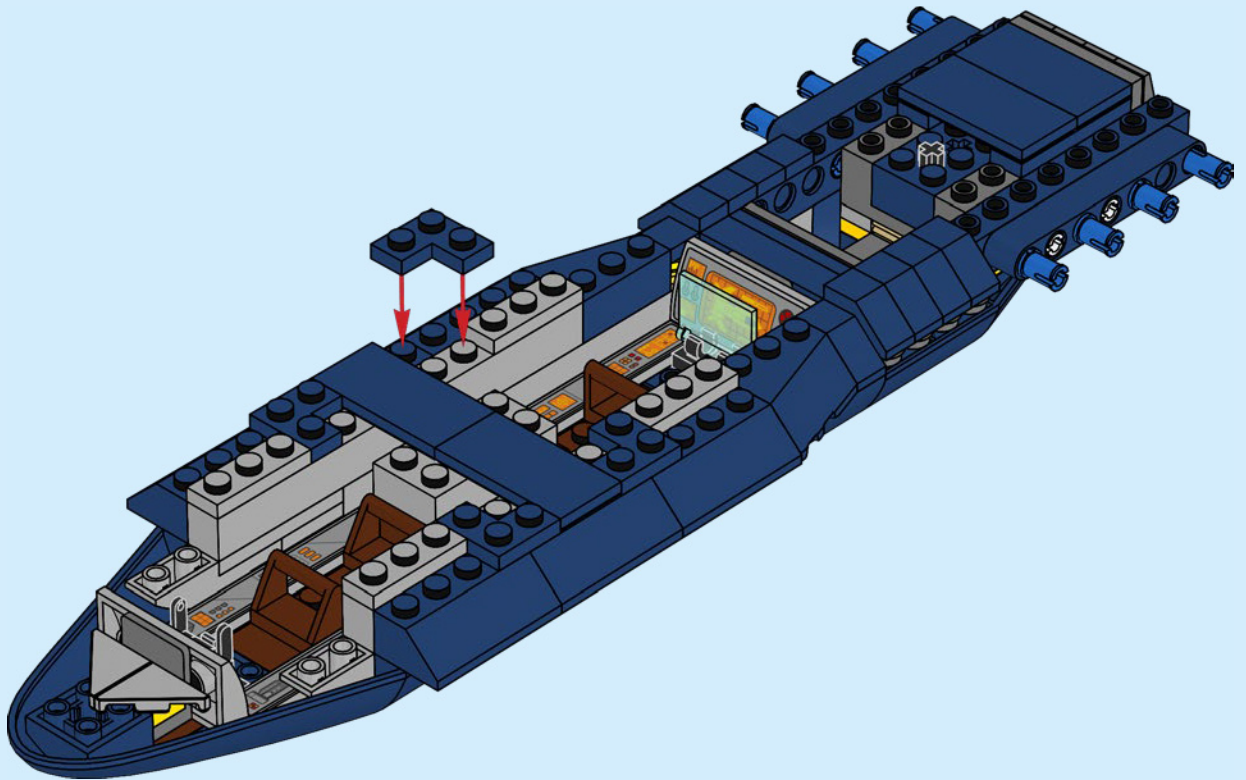

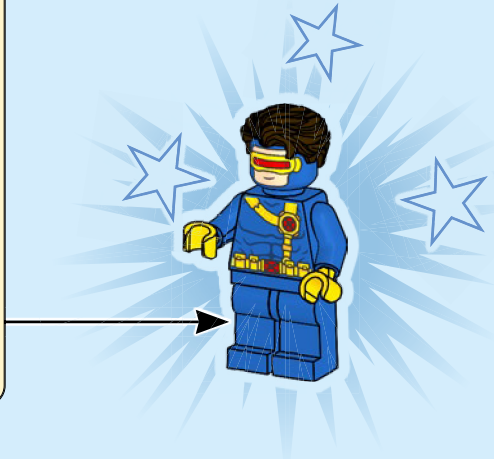
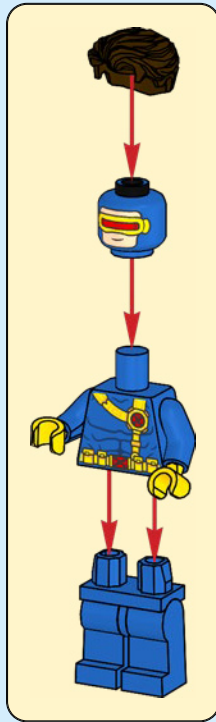

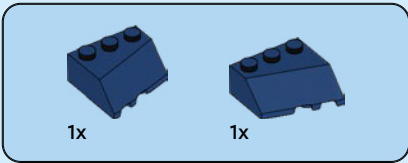

48

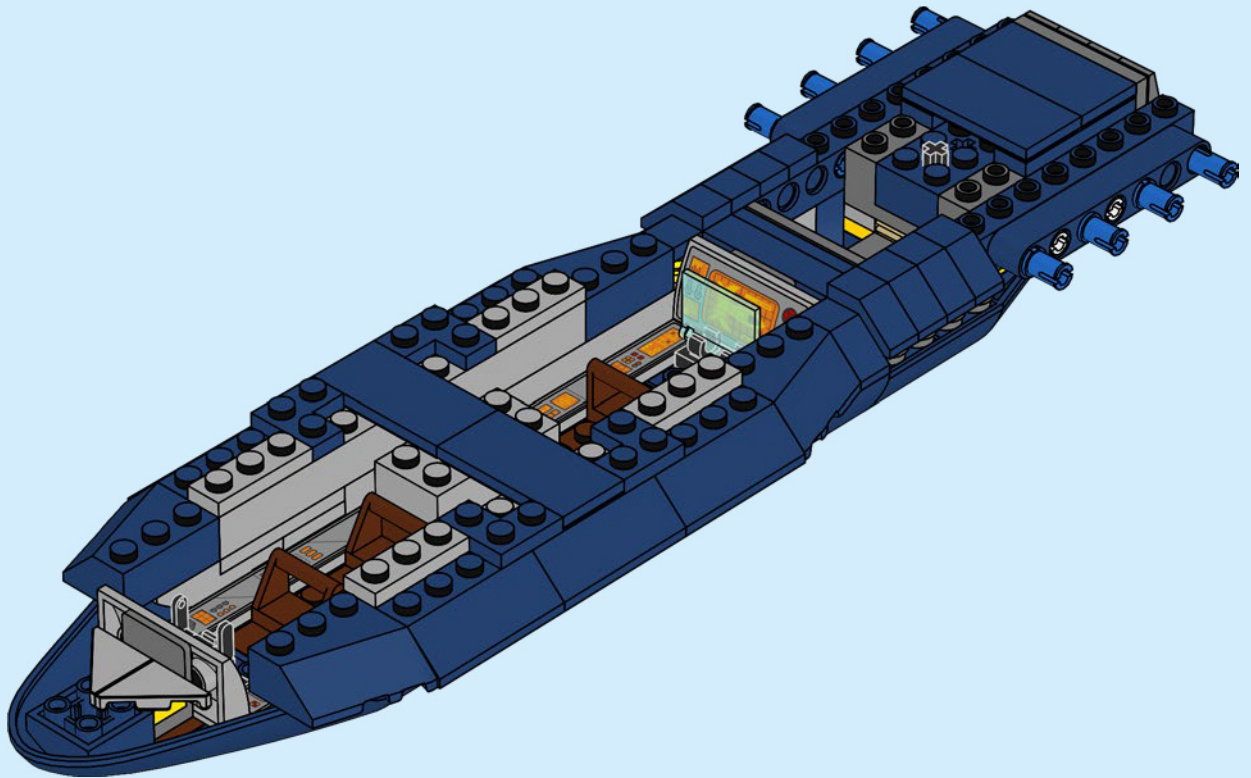



4x

49

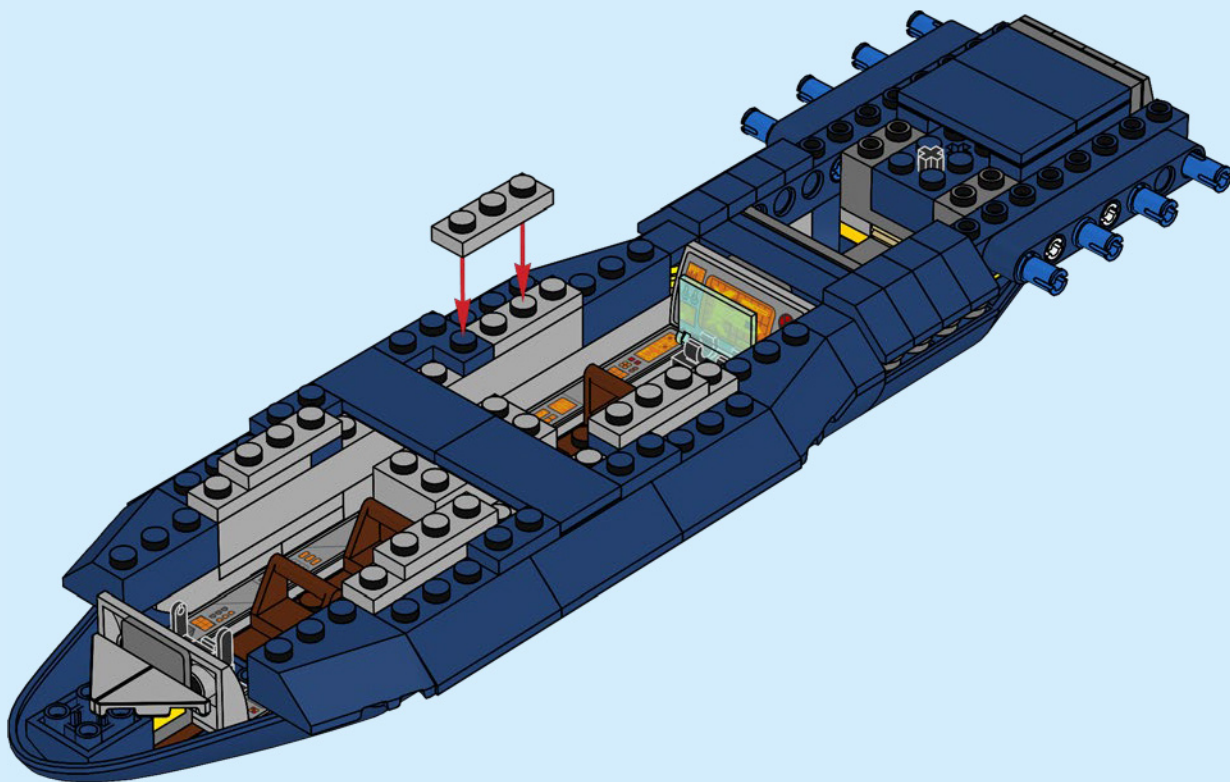



4x

50

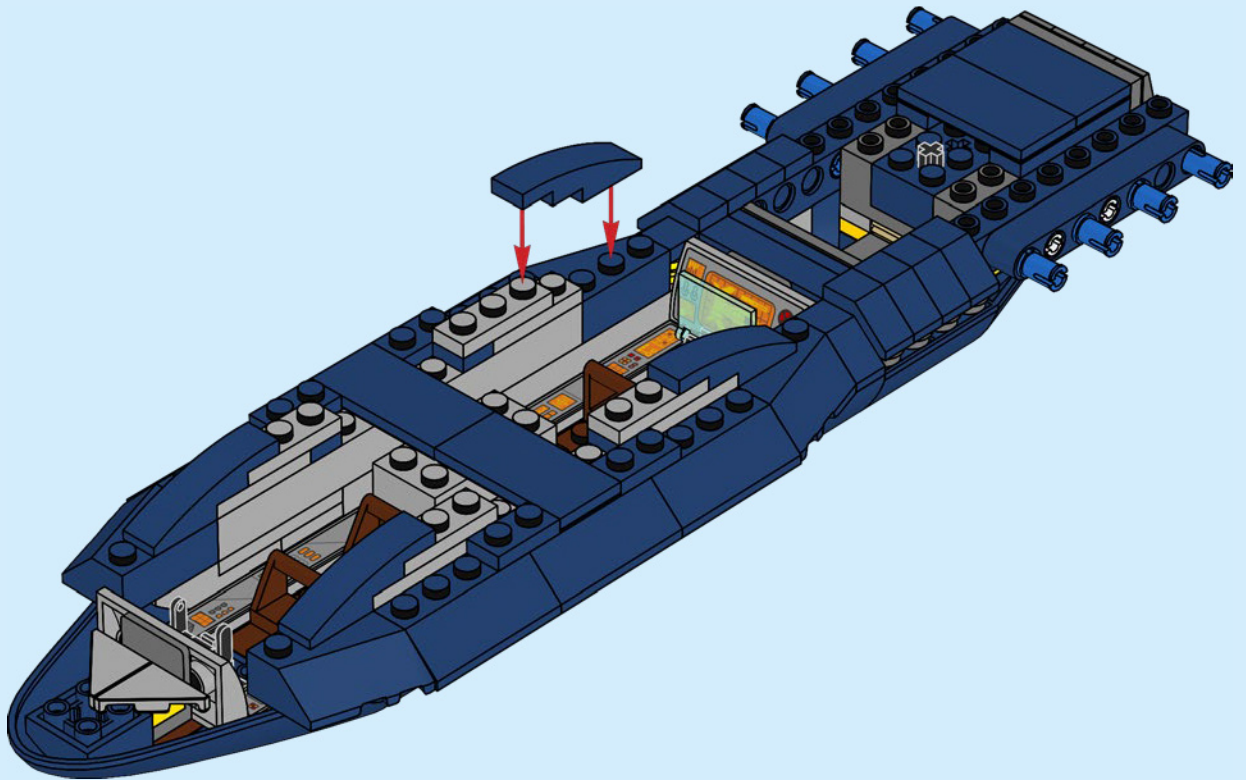

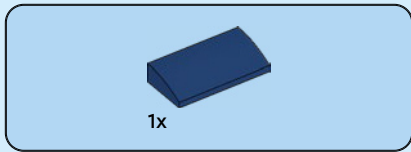

51

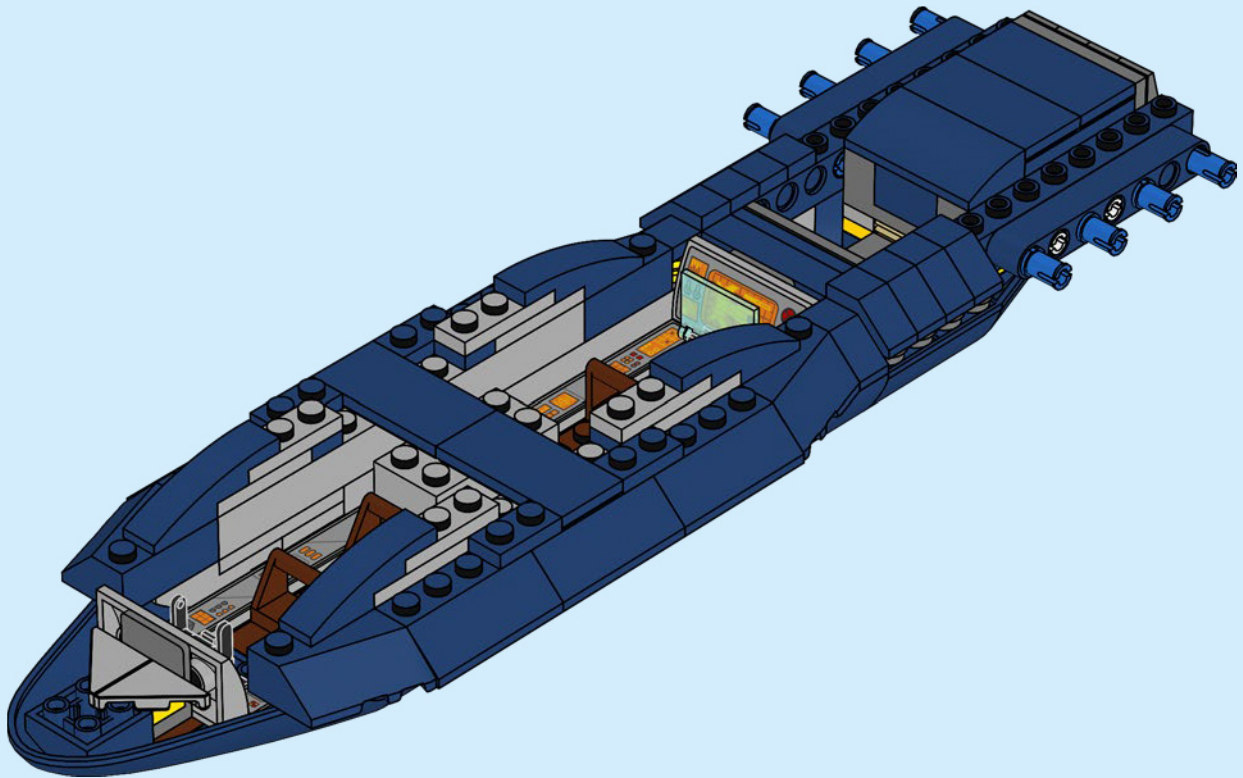

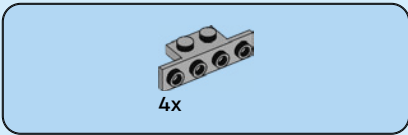

52

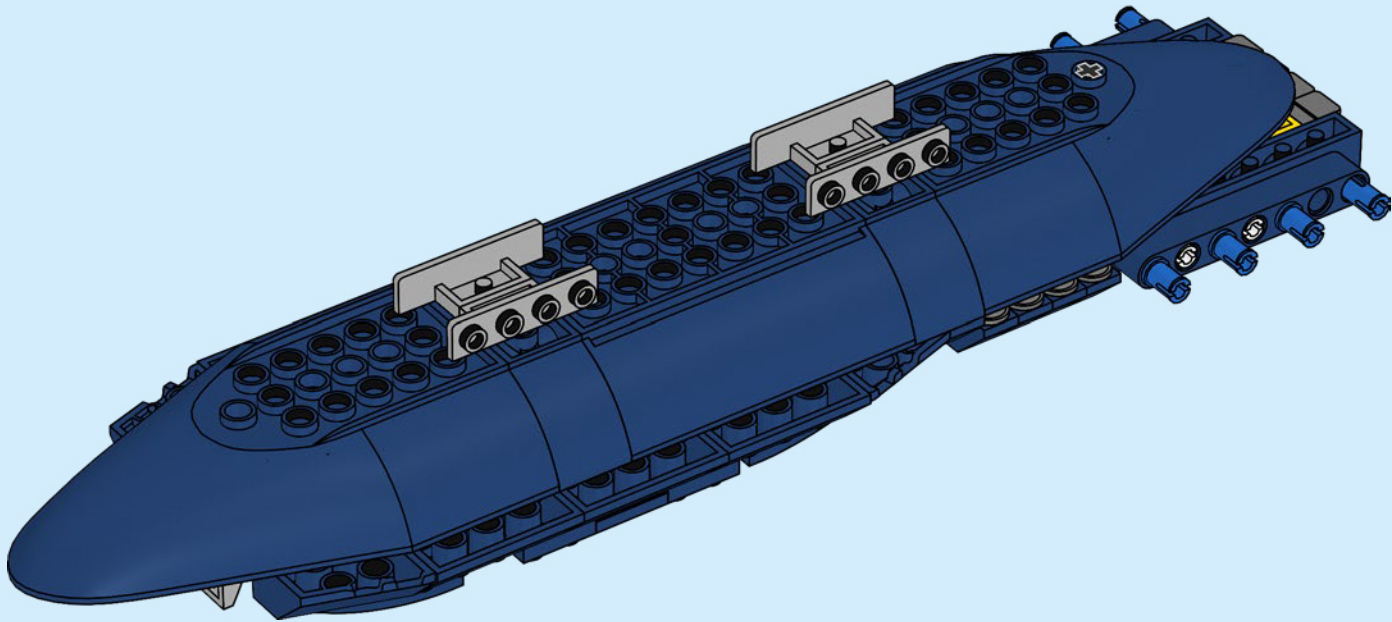



4x

53

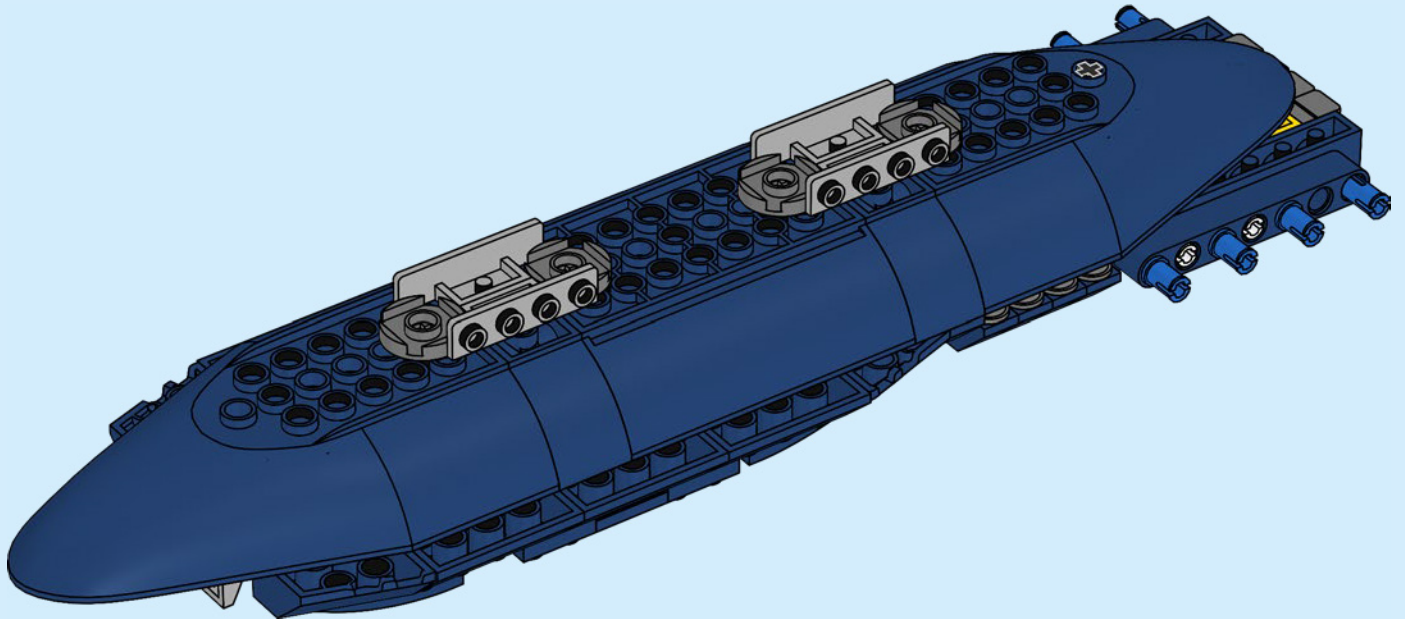



4x

54

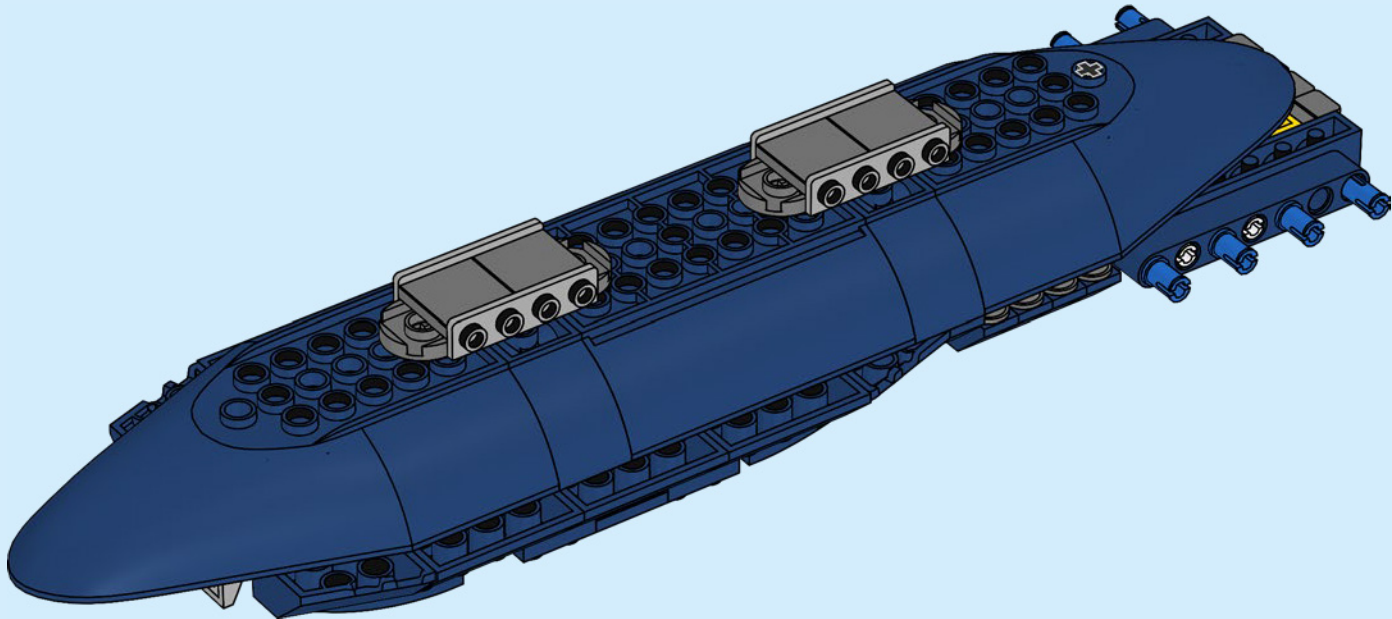



4x

55

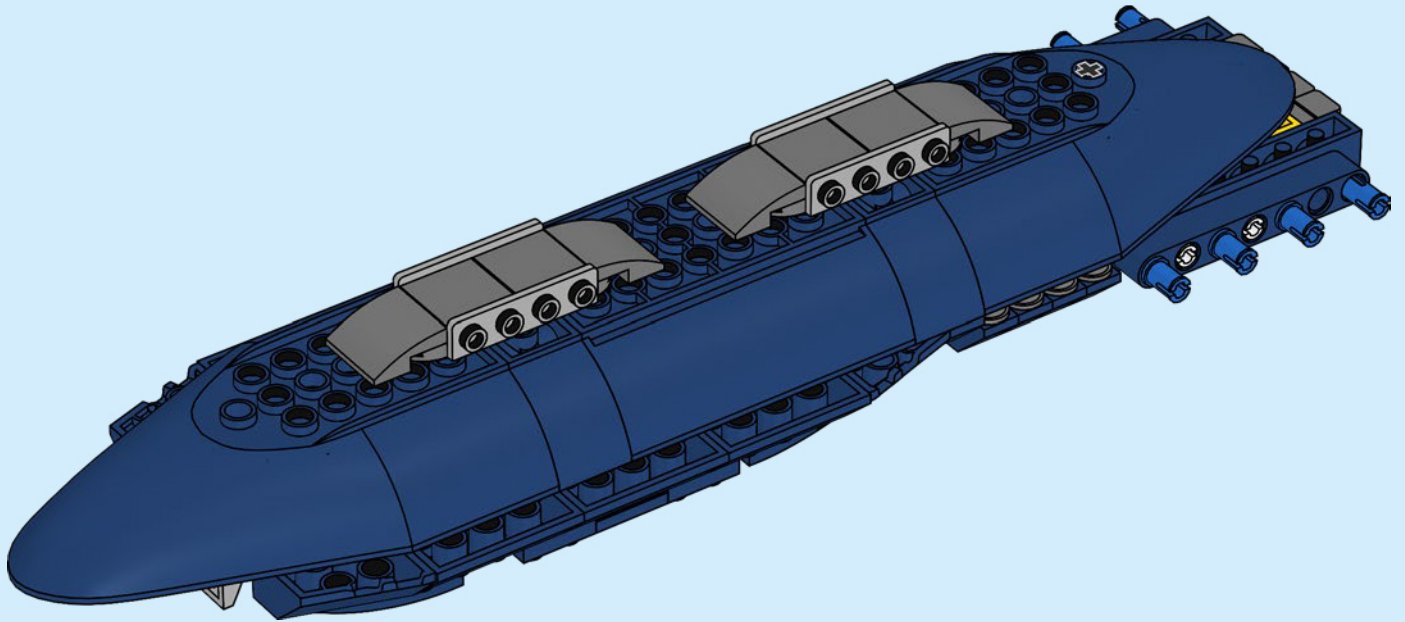



4x

56

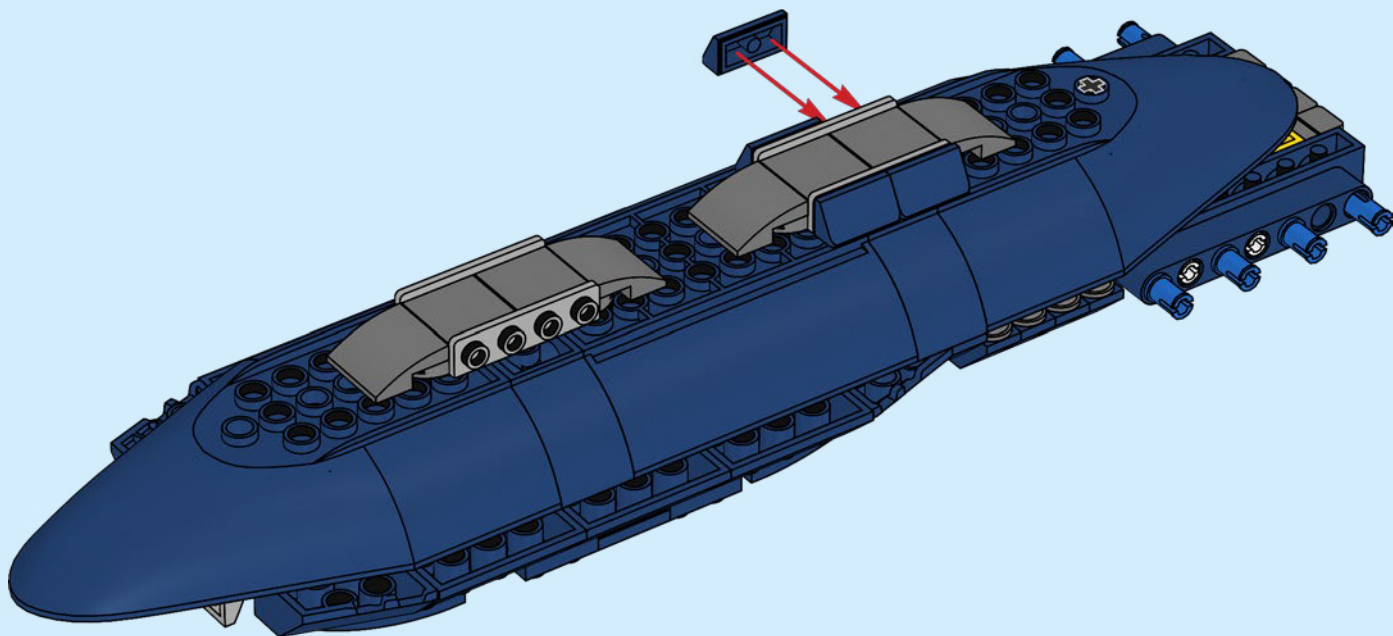

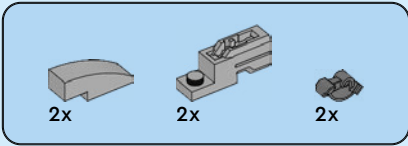

57

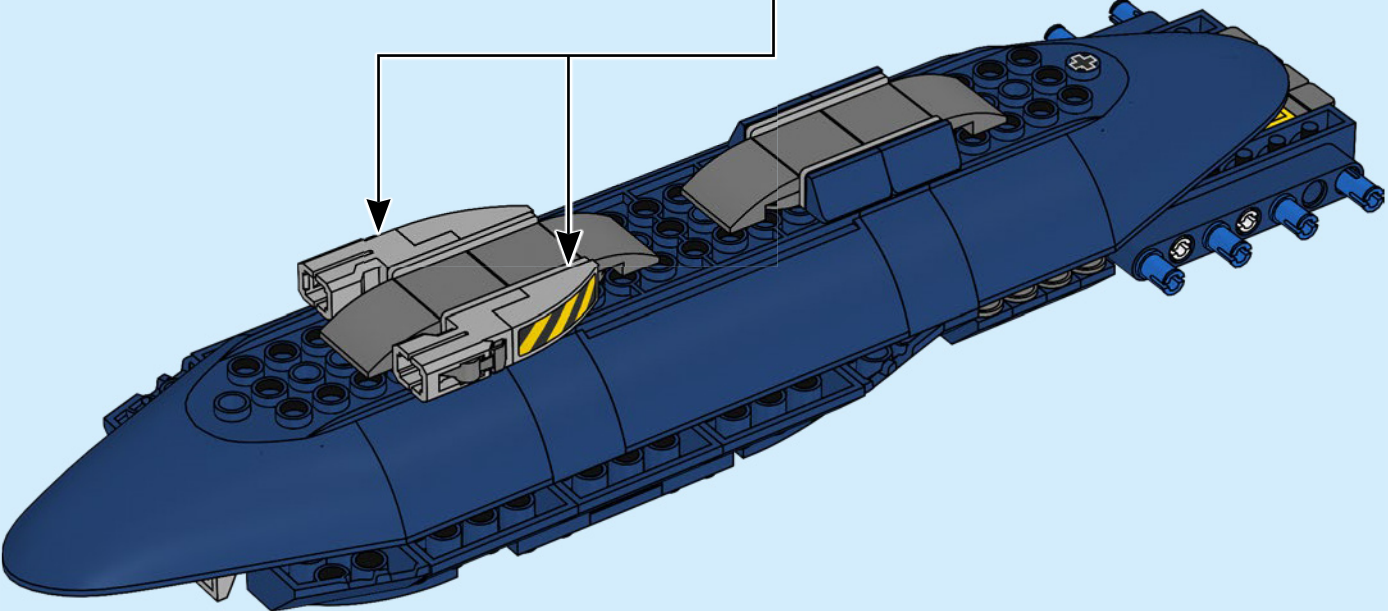
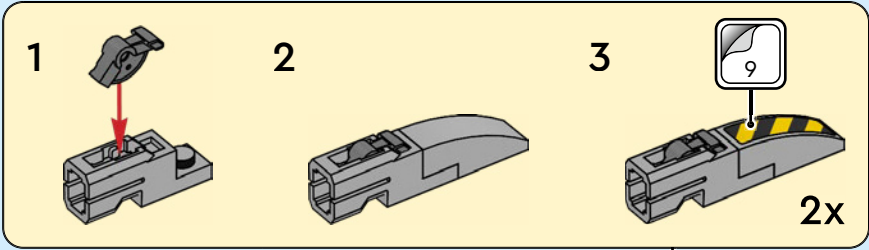

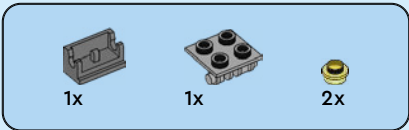

58

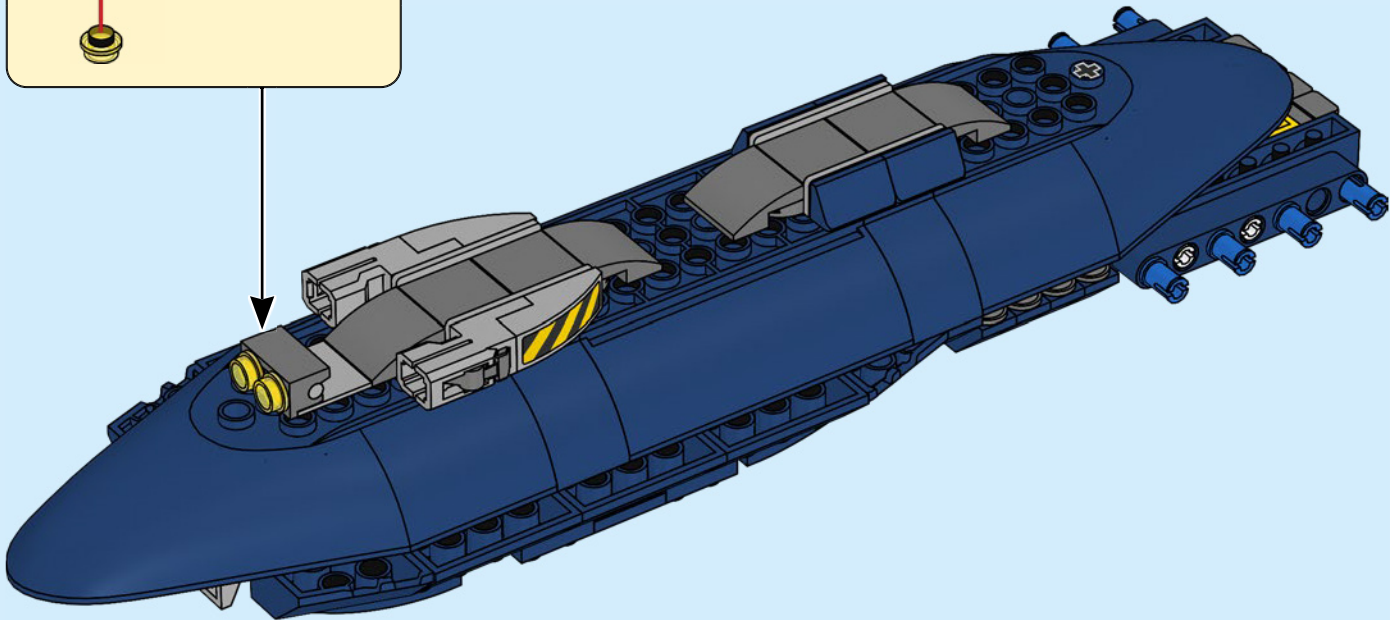
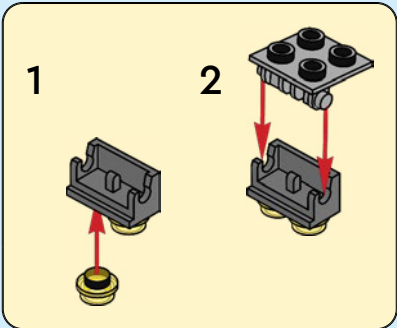



2x



2x



2x



4x



2x



2x



4x

59

1

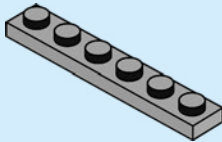

2

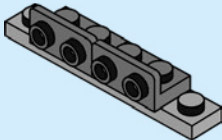

3

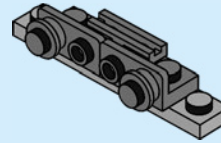

4

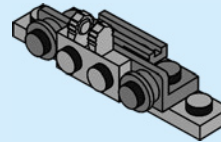

5

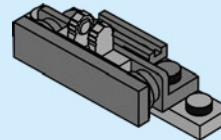

2x

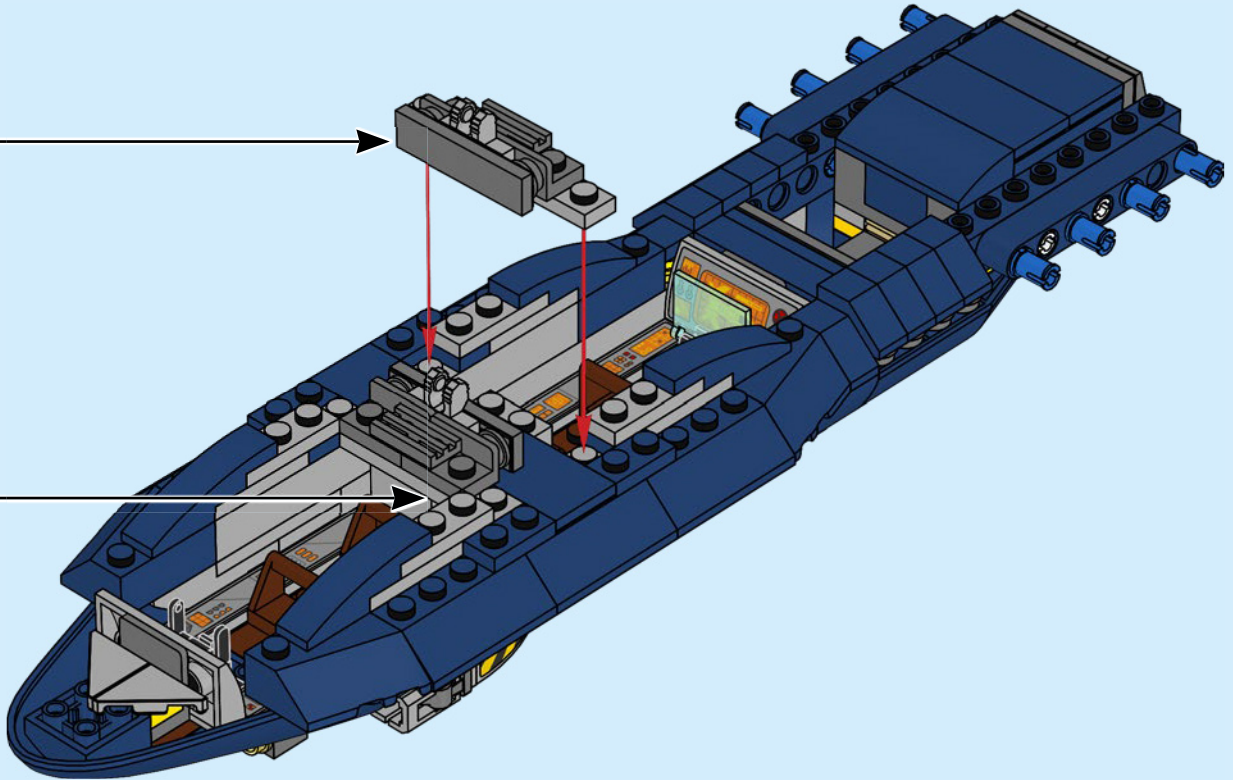



4x



4x

60

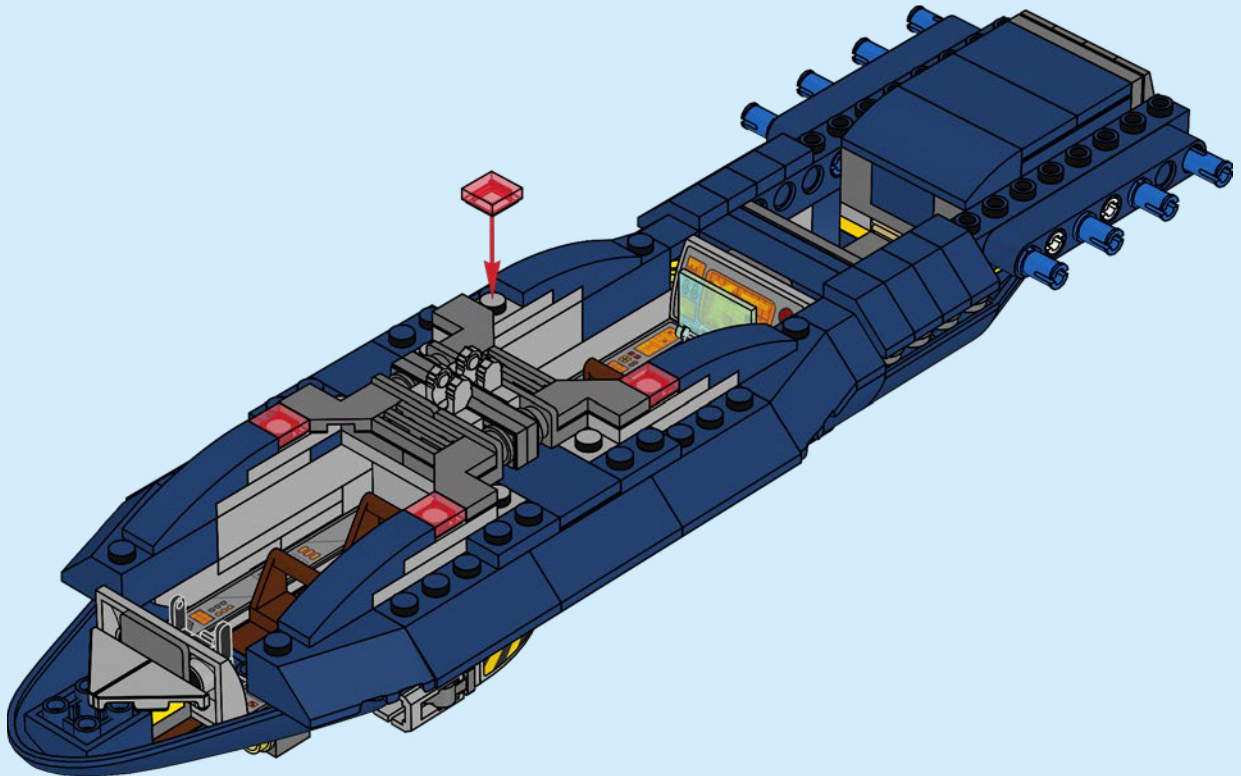

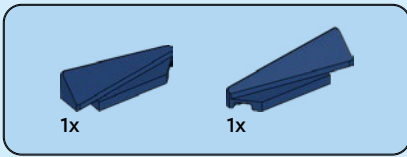

61

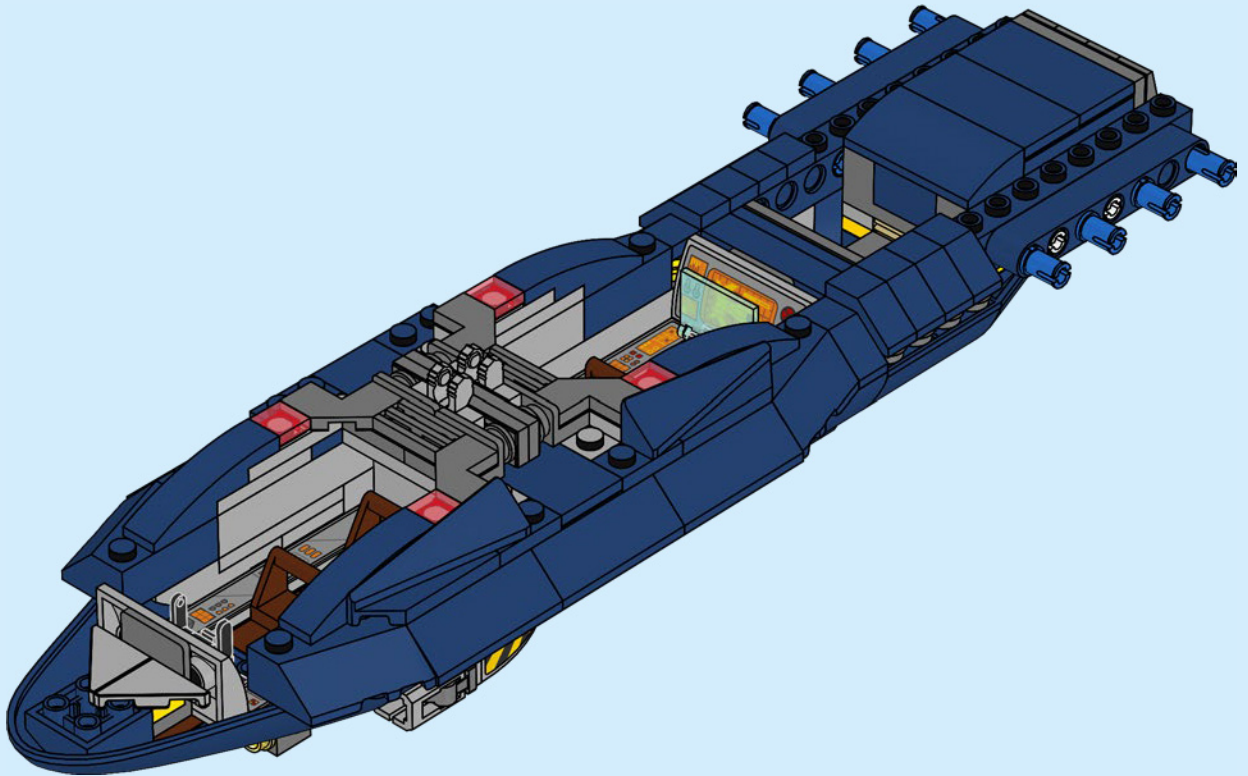

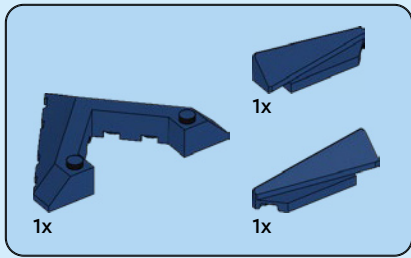

62

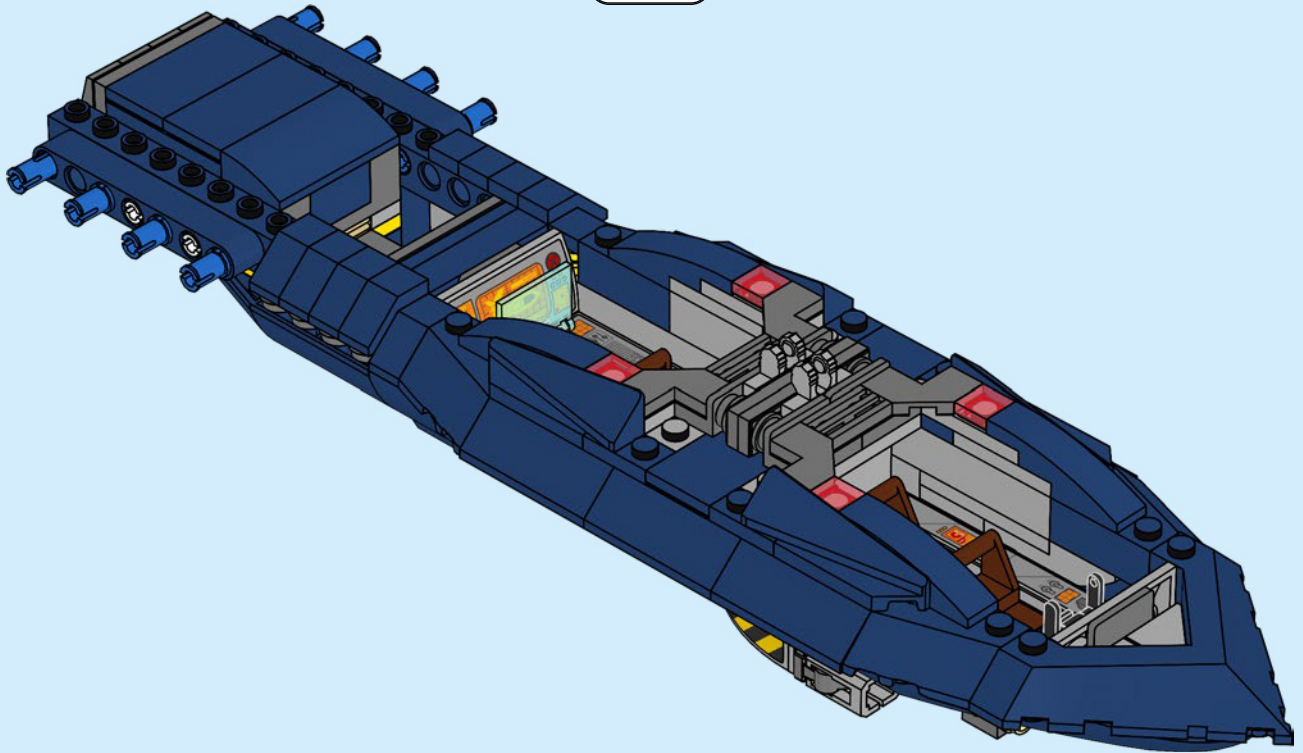

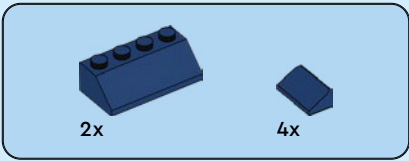

63

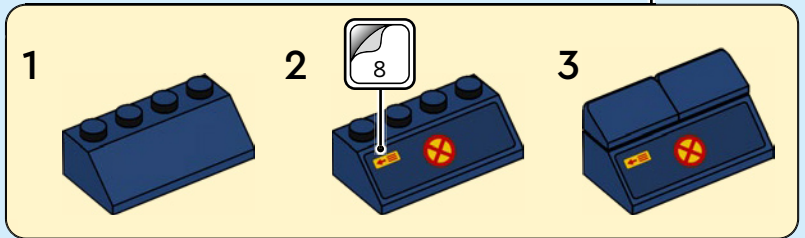
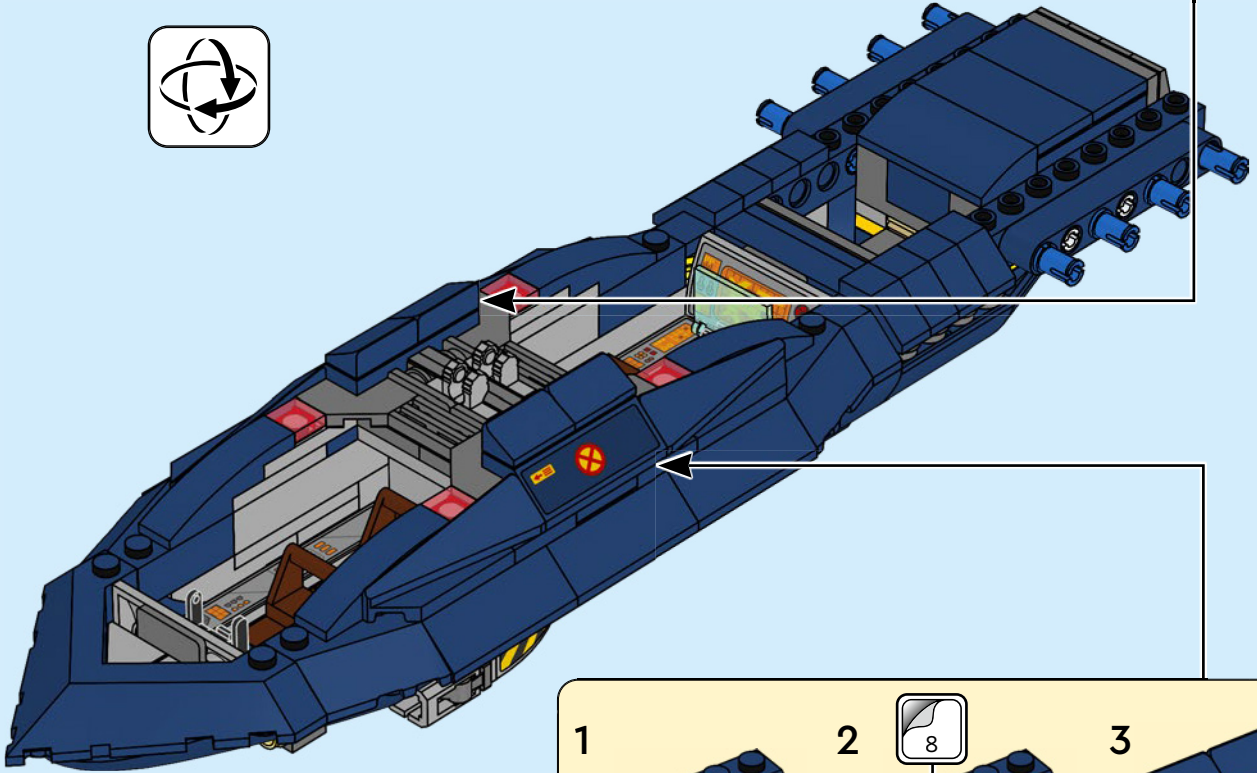
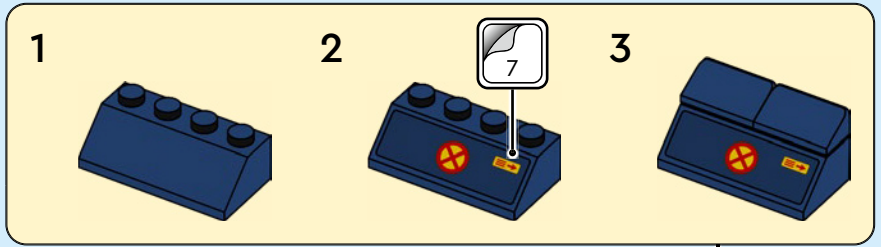

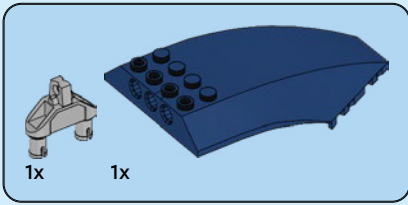

64

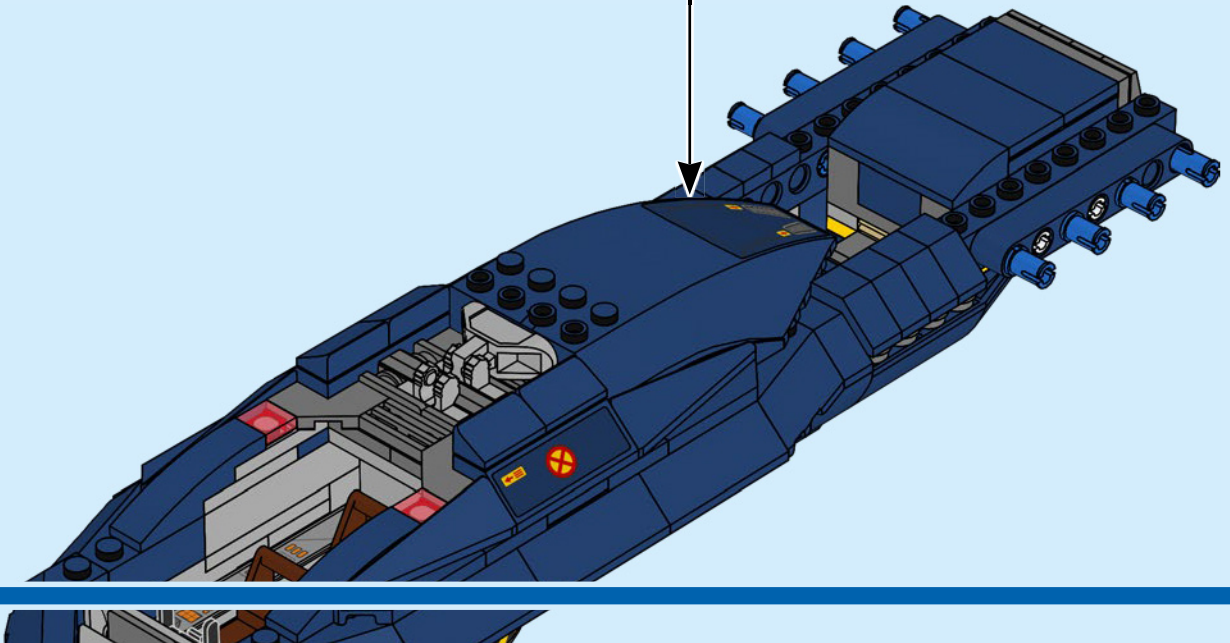
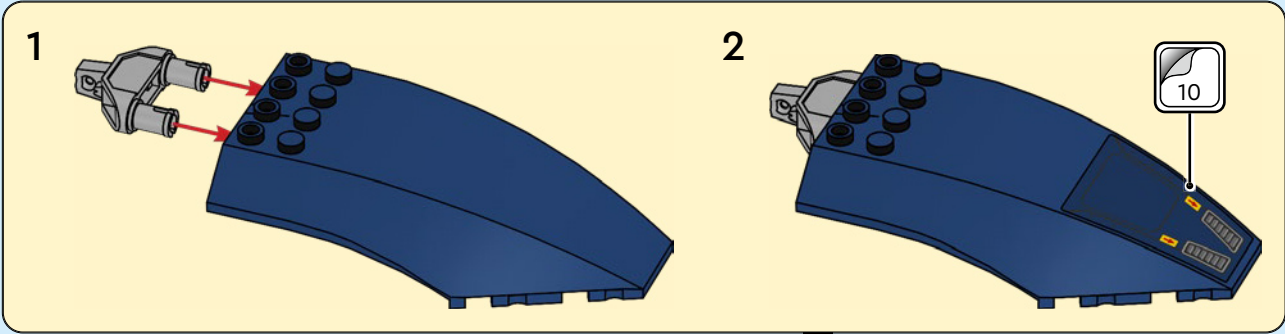

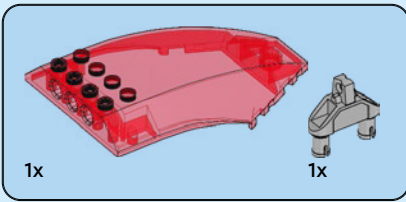

65

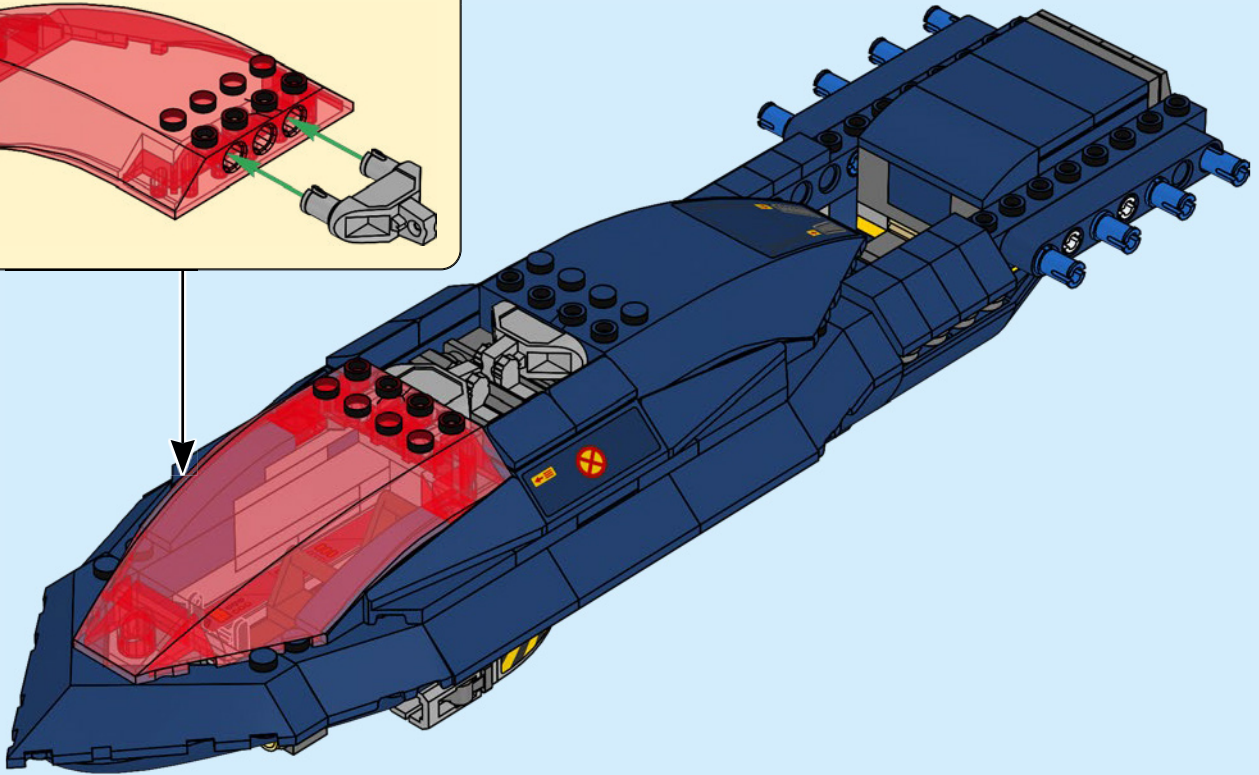
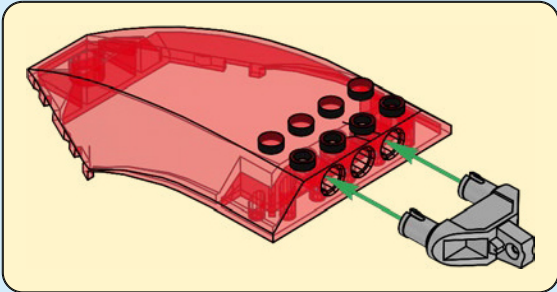

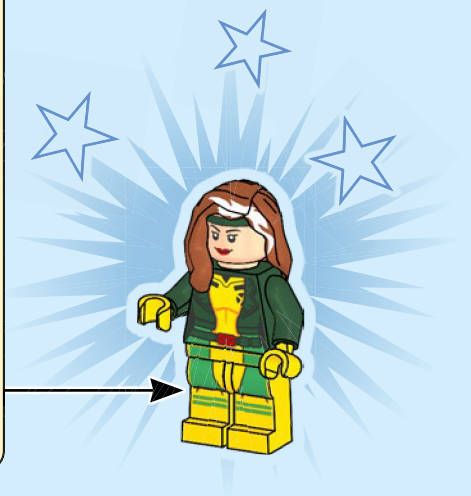
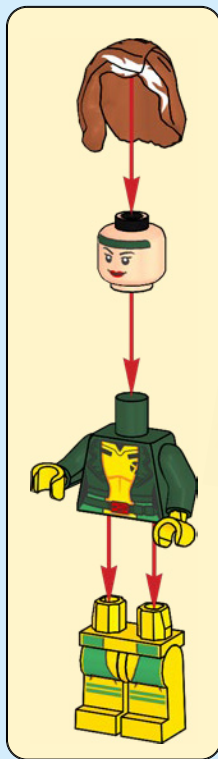

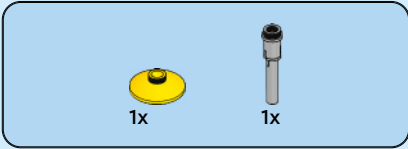
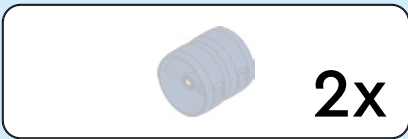

66

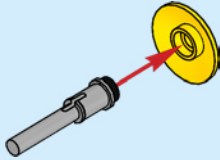

67

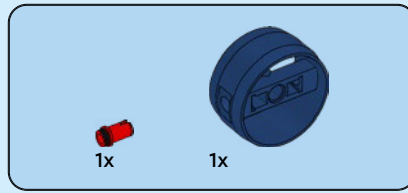
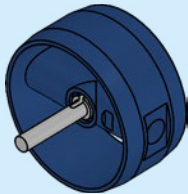

68

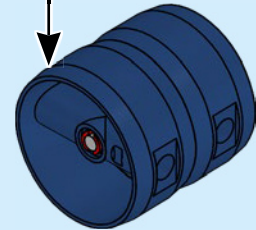
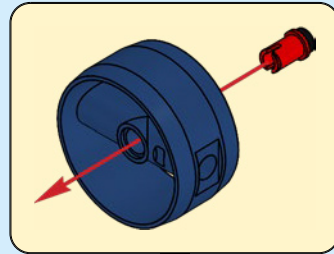

2x



69

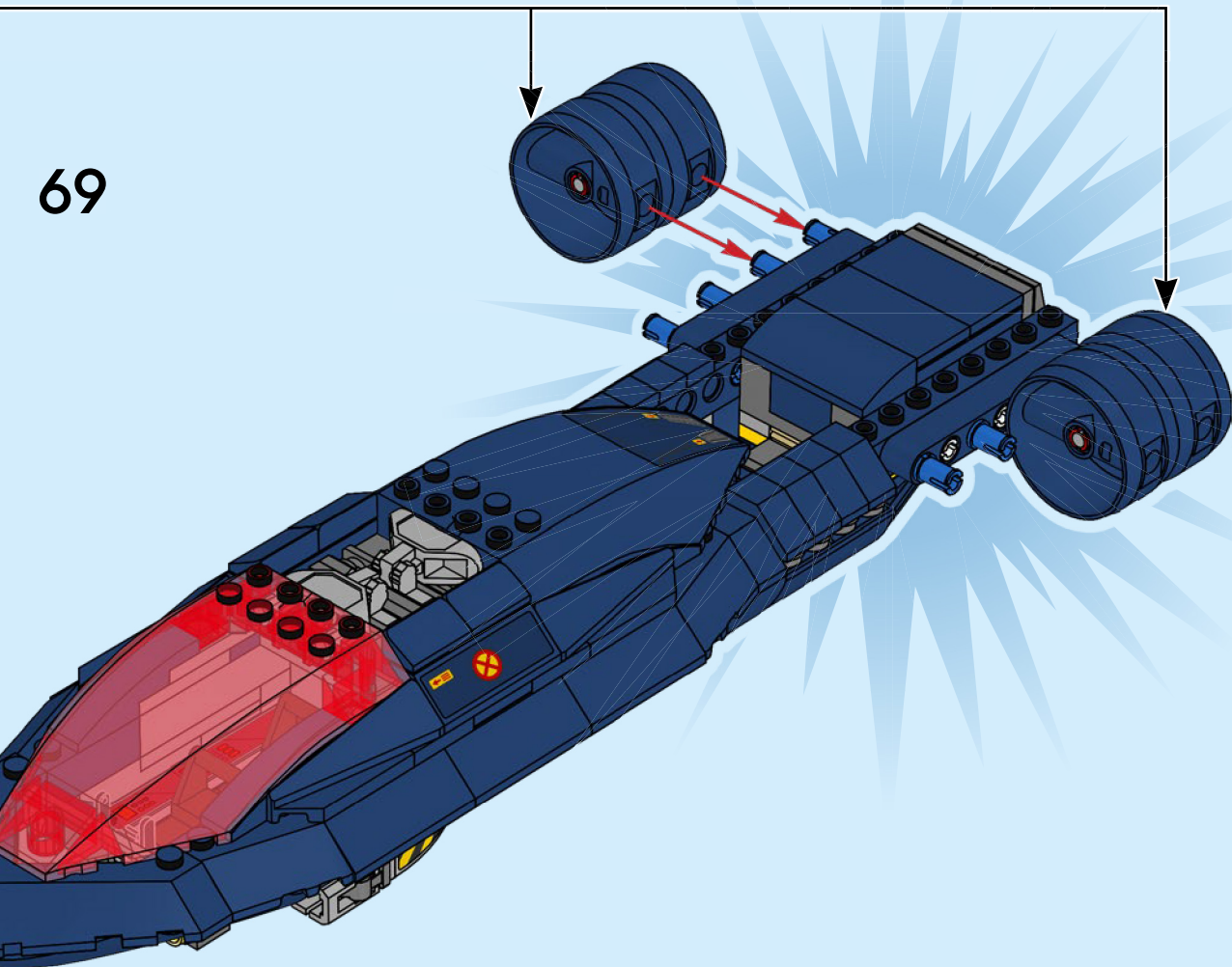

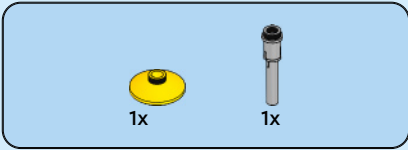

70

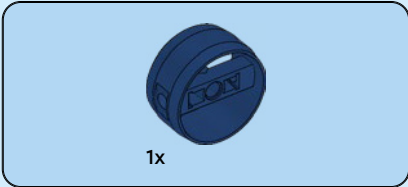
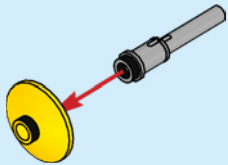

71

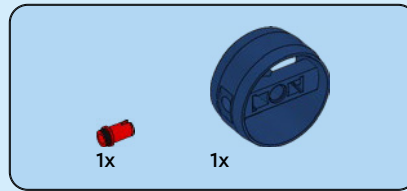
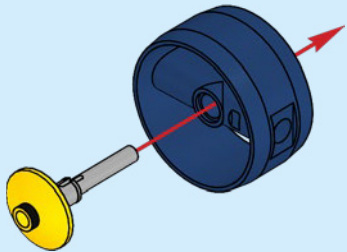

72

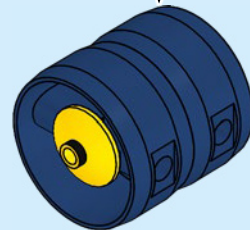
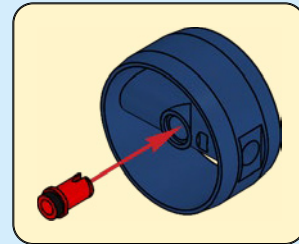

2x



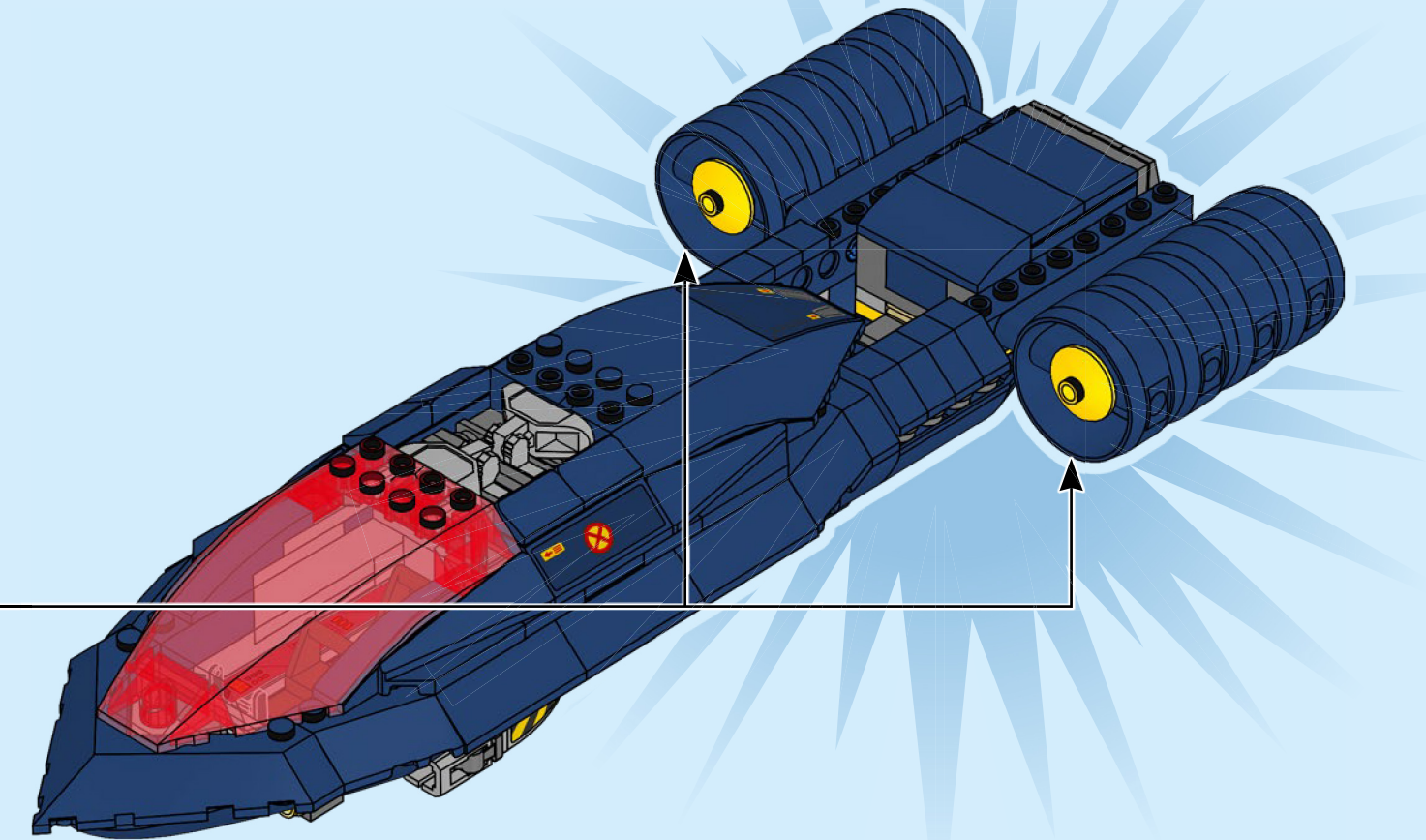

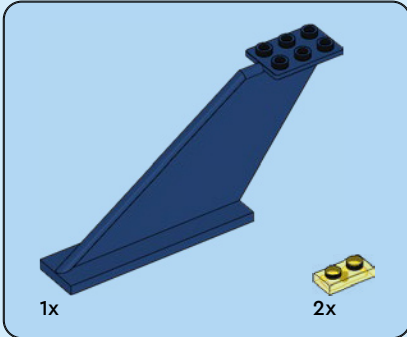
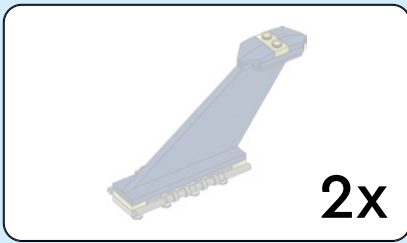

74

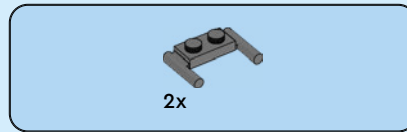
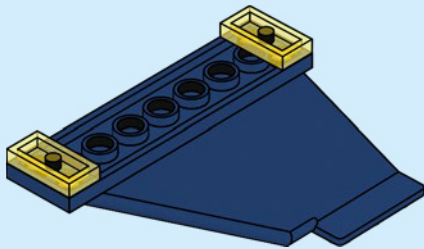

75

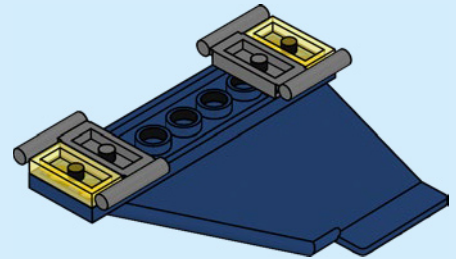



2x

76

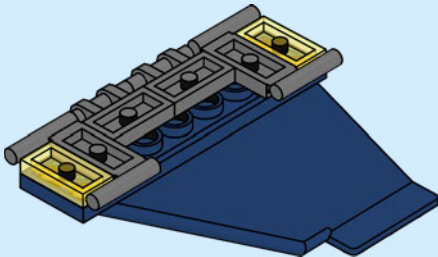

2x

77

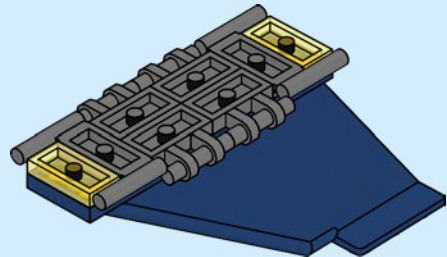



4x

78

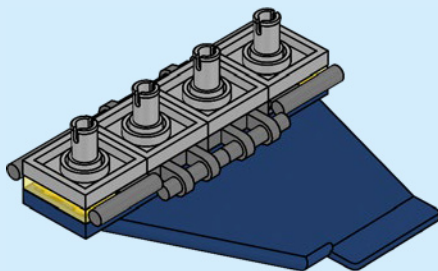

1x

79

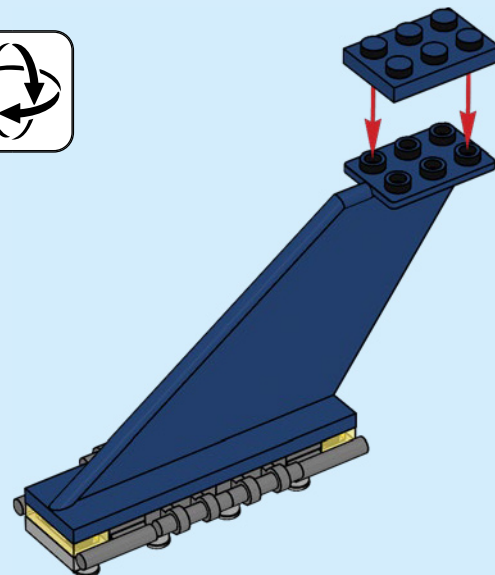
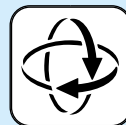



80

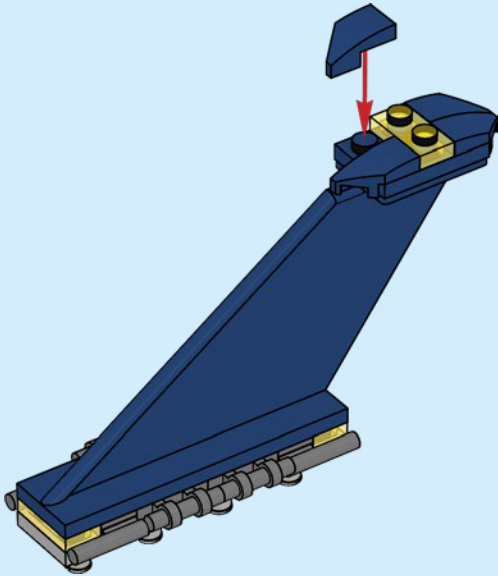

2x

81

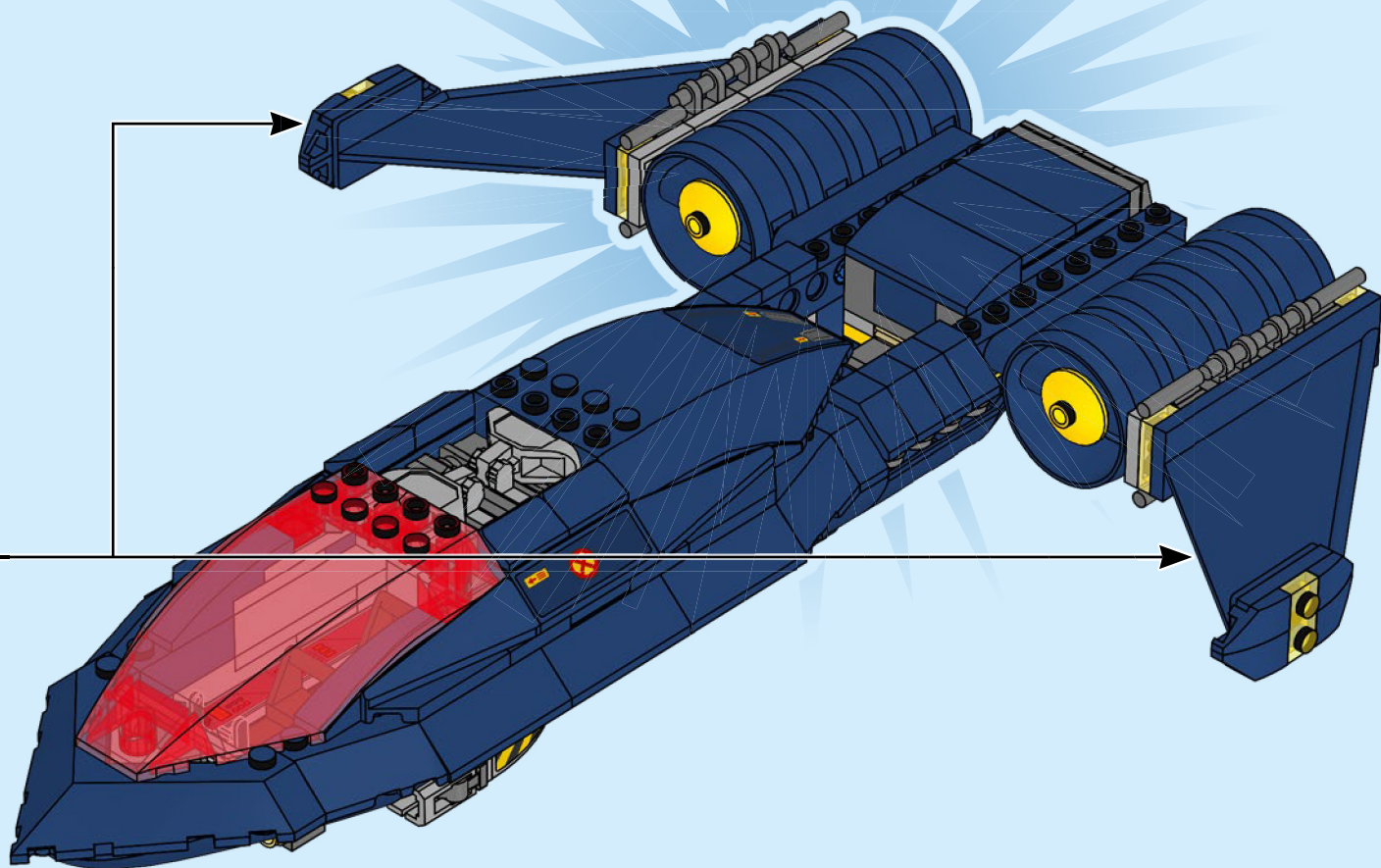



1x

82

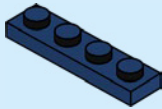

2x

83

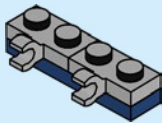

1x

84

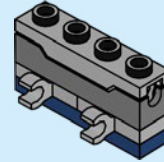

1x

85

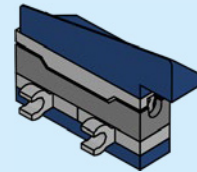

86

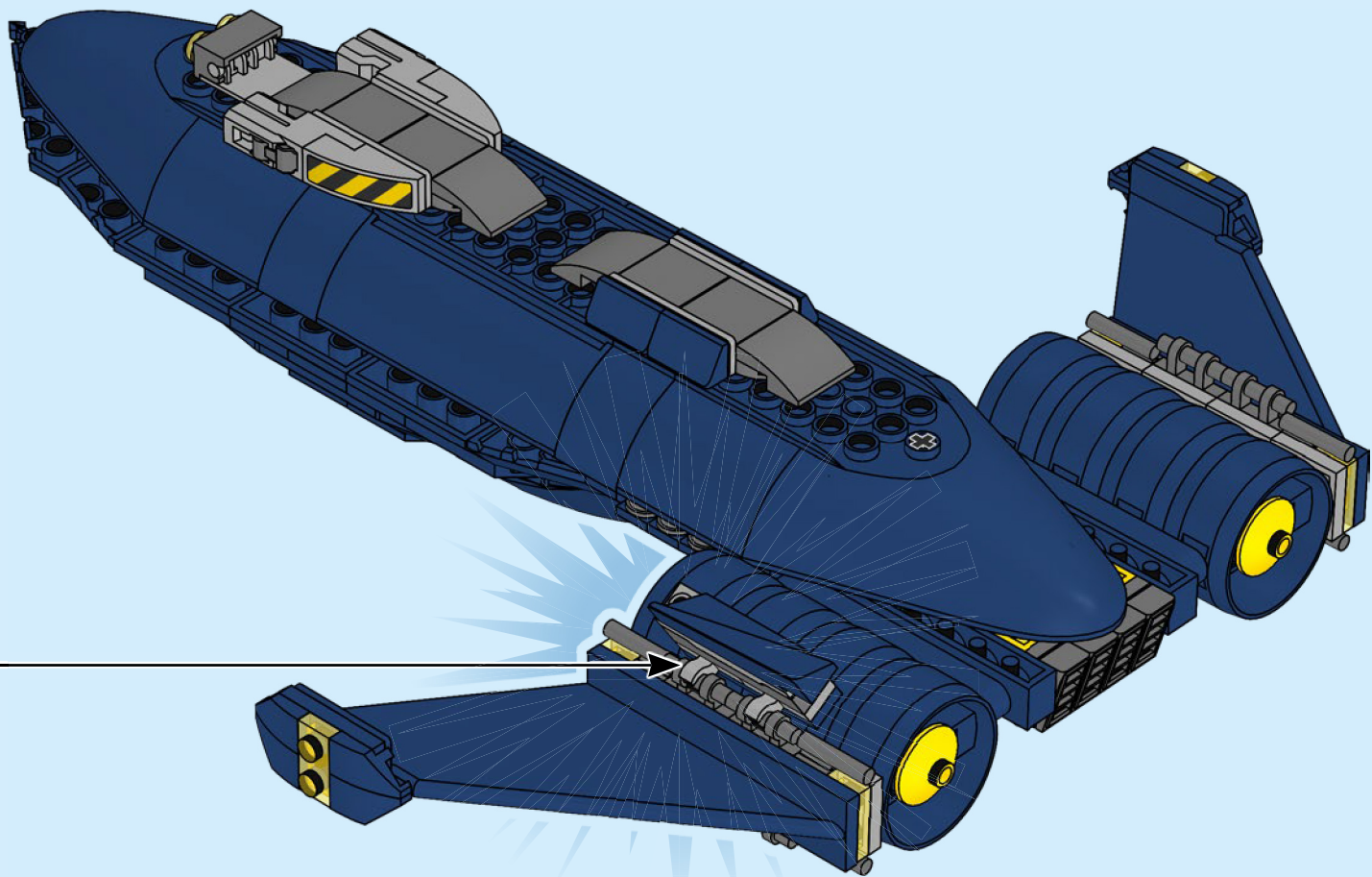
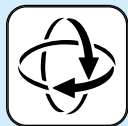

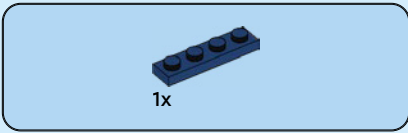

87

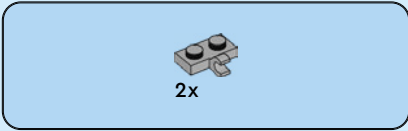
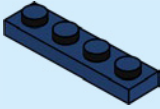

88

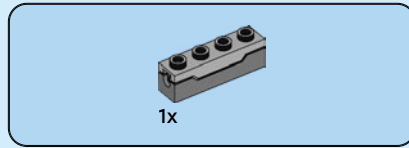
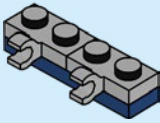

89

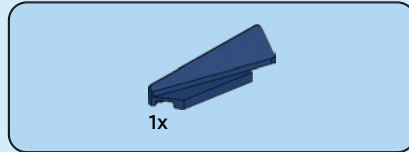
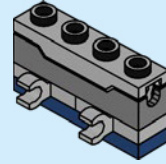

90

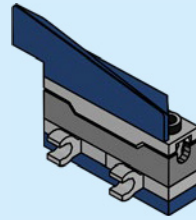

91

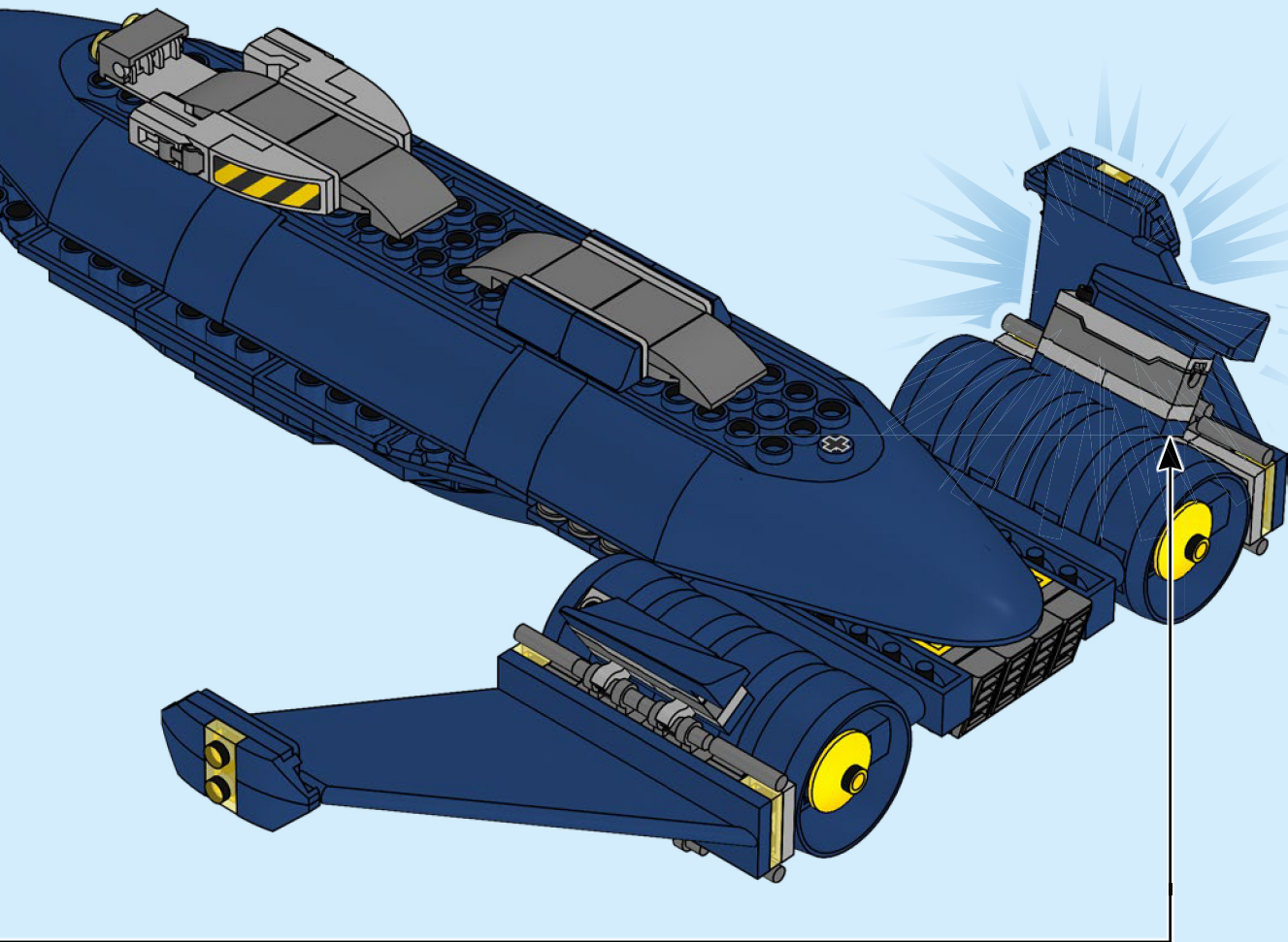

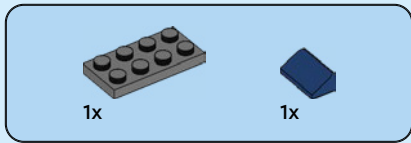

92

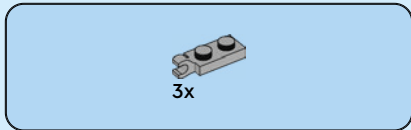
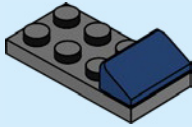

93

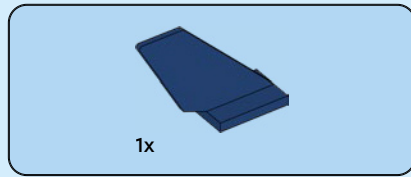
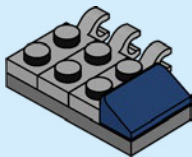

94

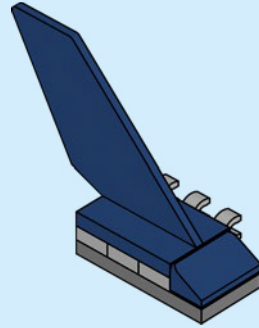

95

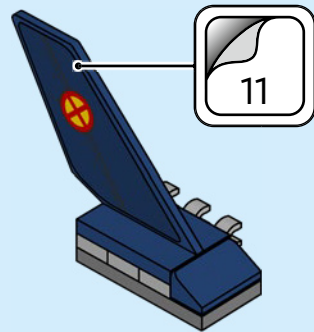

96

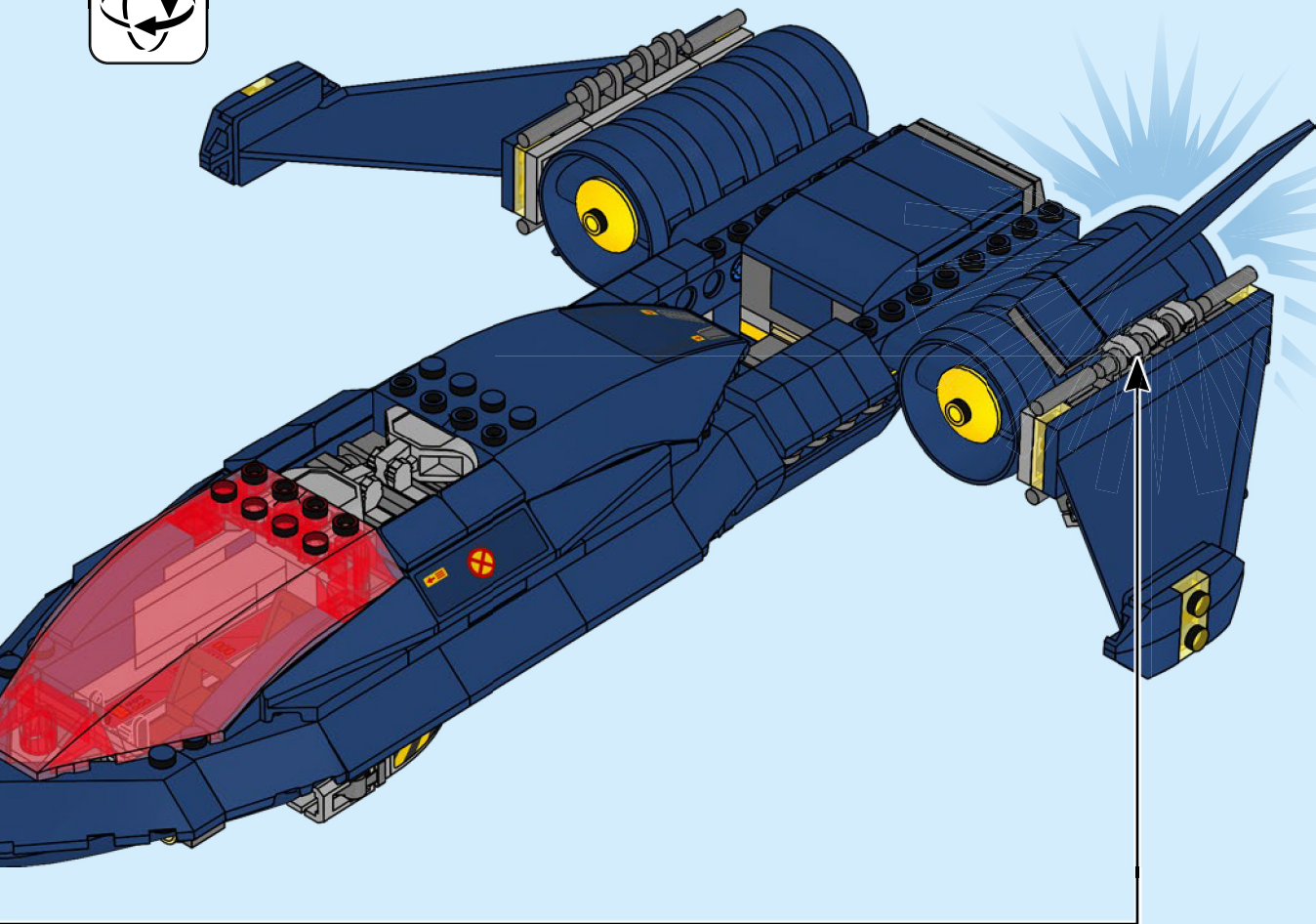

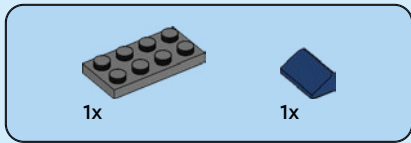

97

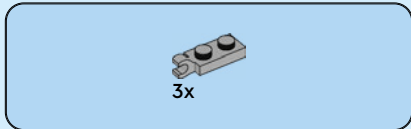
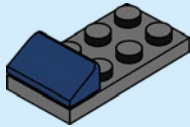

98

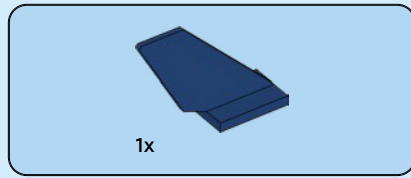
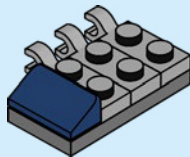

99

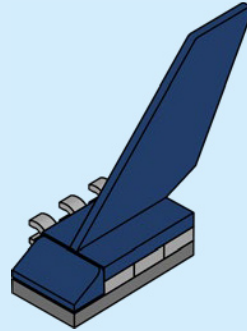

100

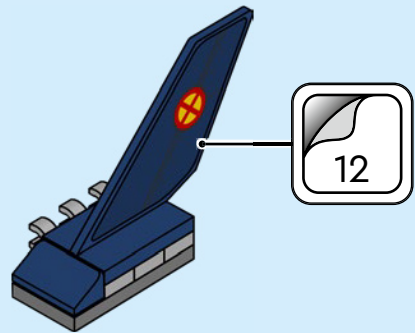

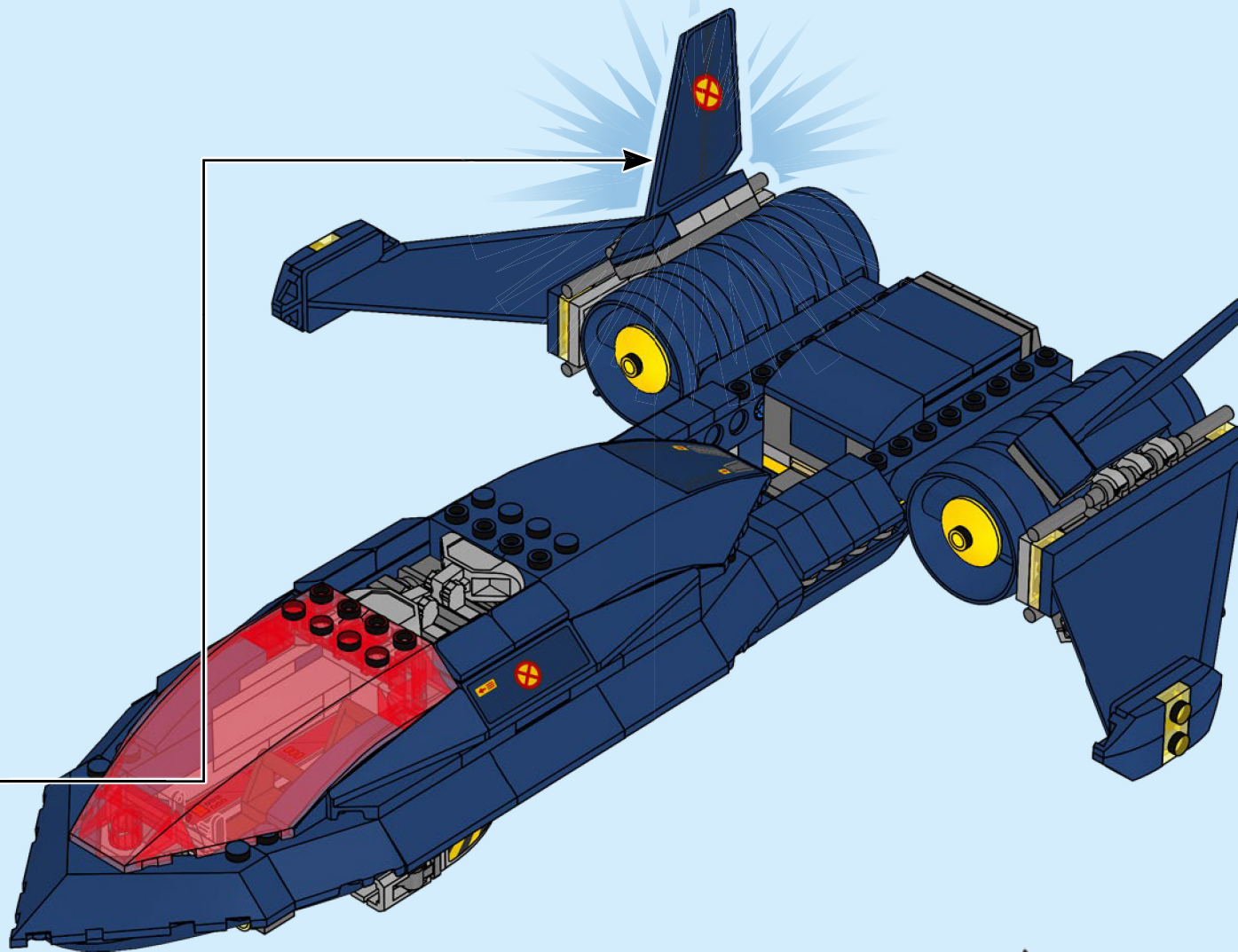

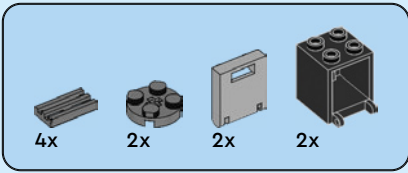

102

1



2

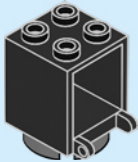

3

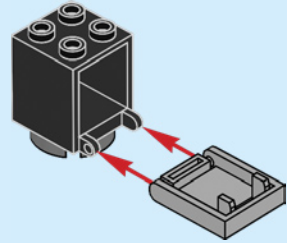

4

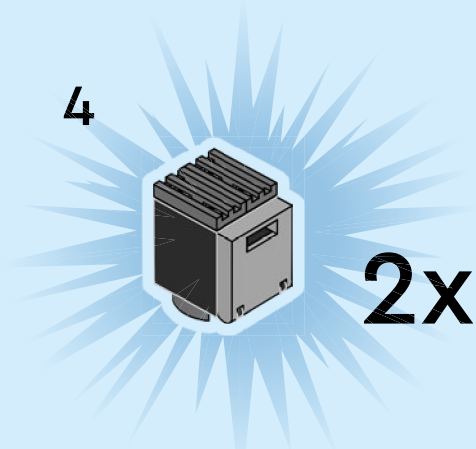

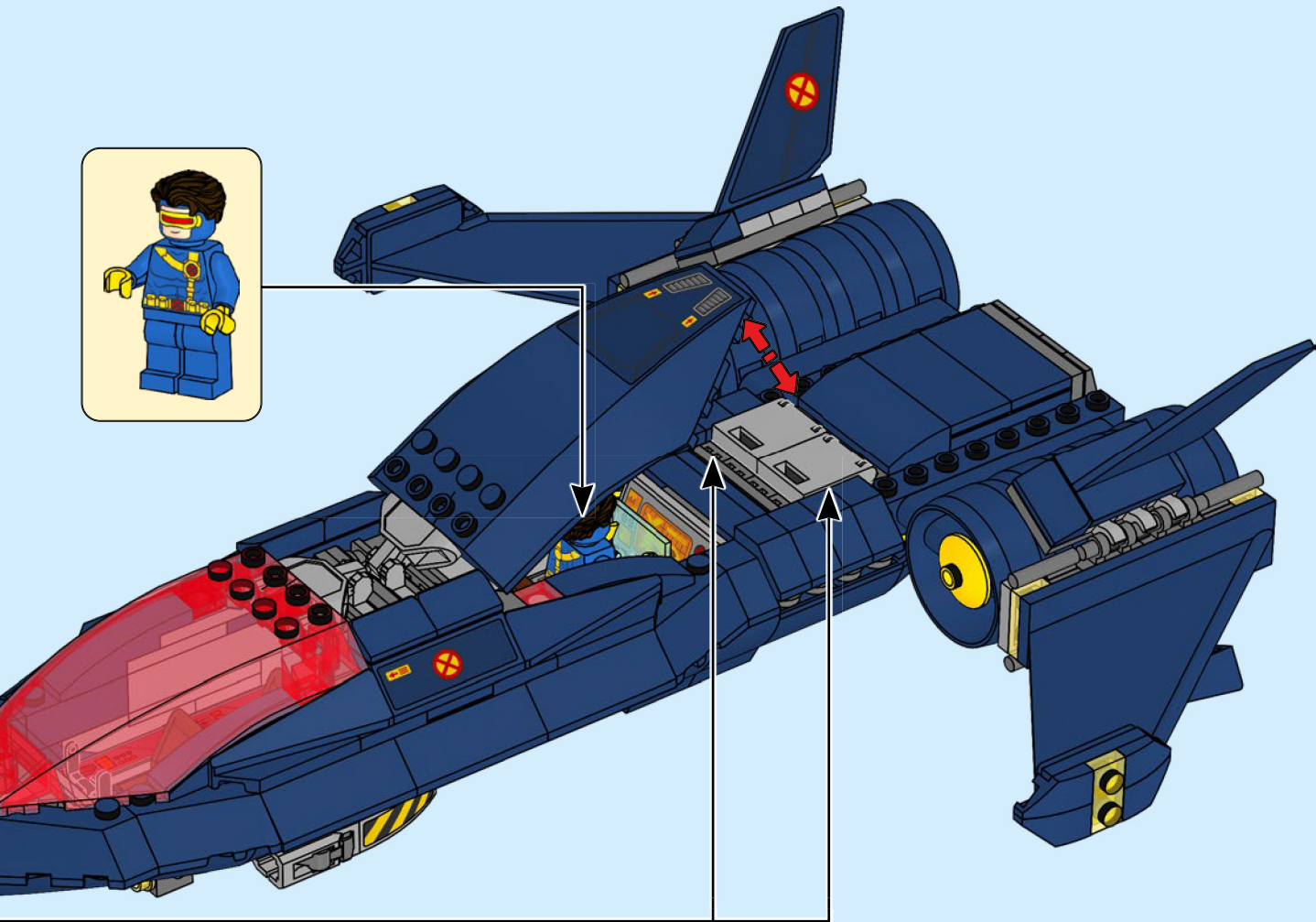

103

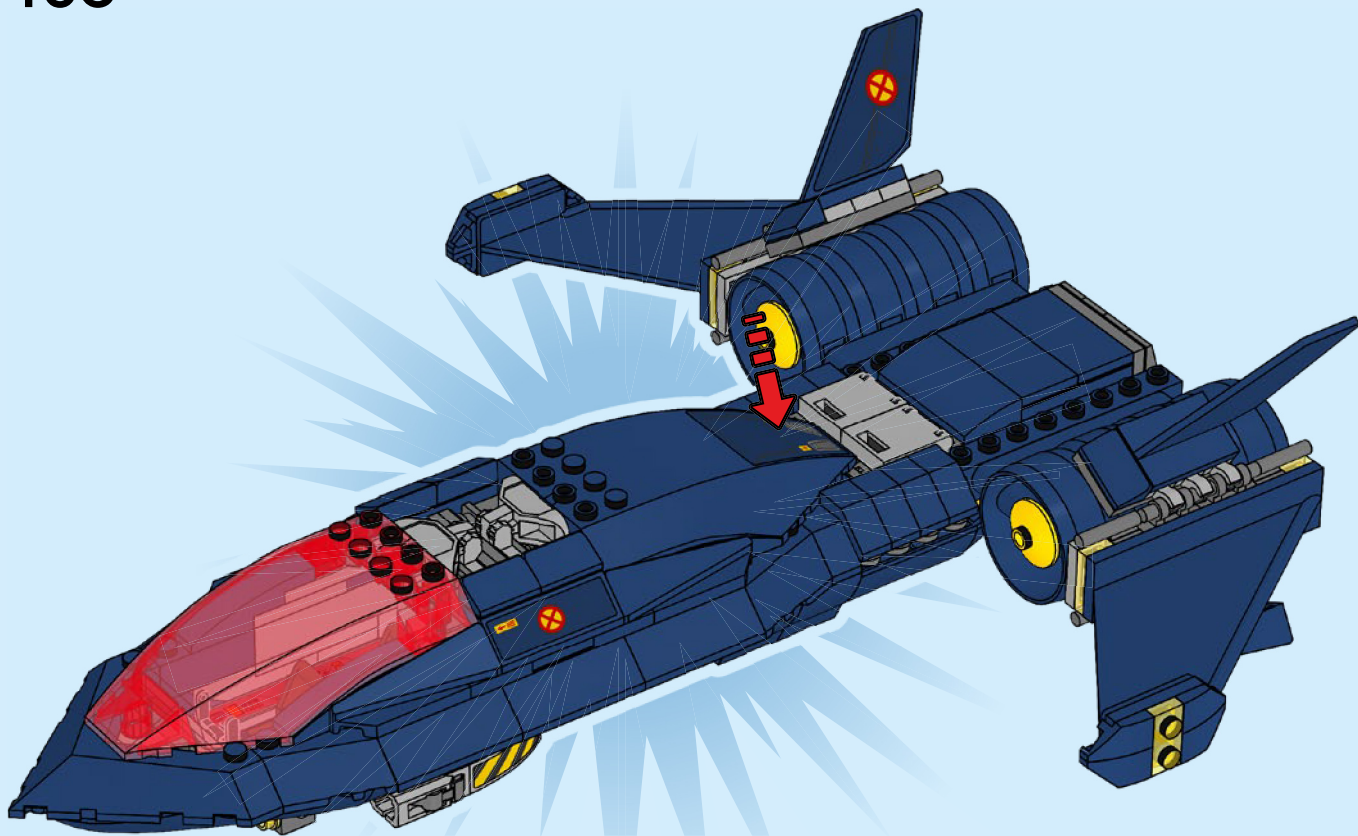

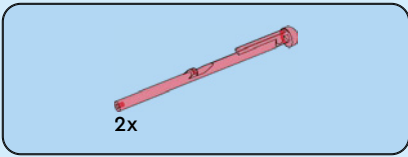

104

1

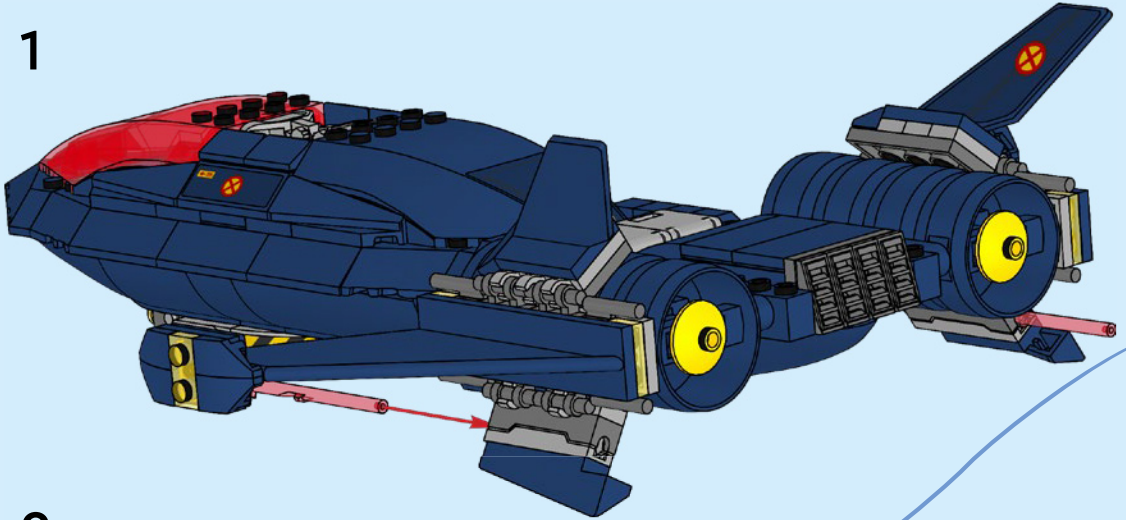

2

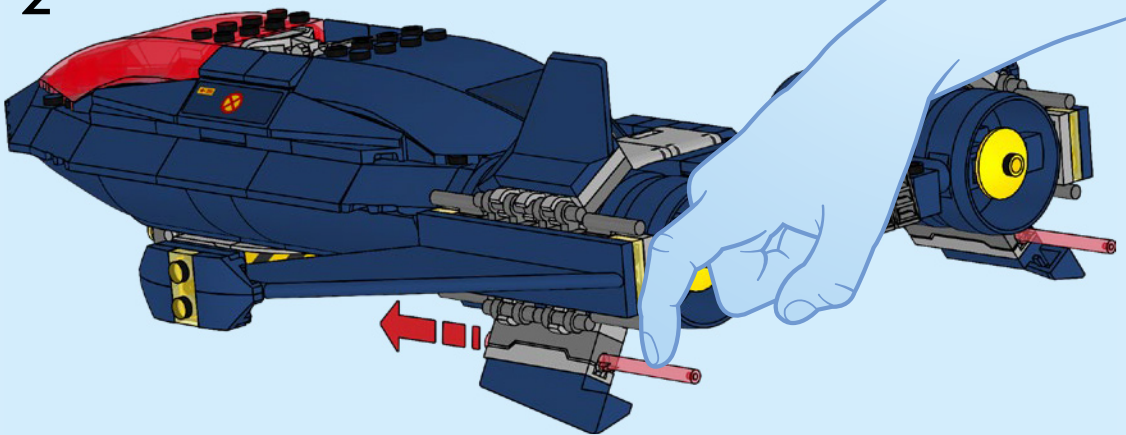



8x



105

1

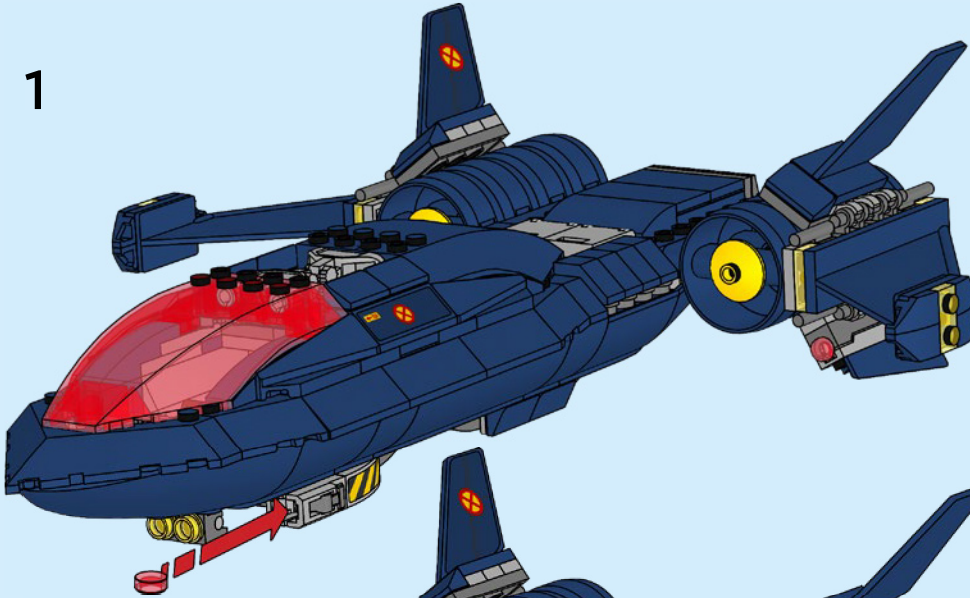

2

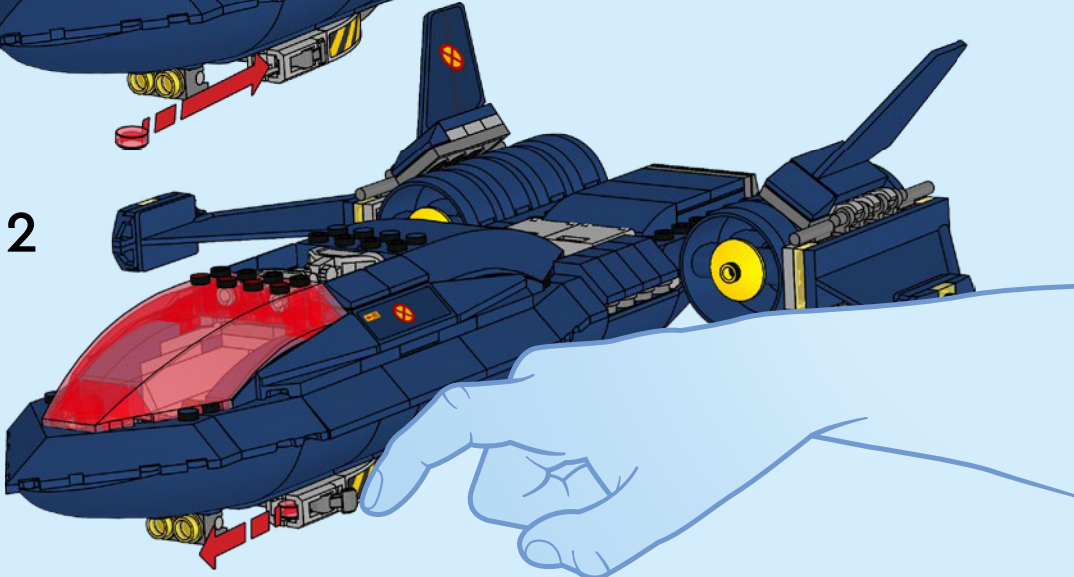



2x
6446788

1x
6353972

4x
6289797

4x
6330903

4x
6378120

2x
4220515

1x
6467581

1x
6467580

1x
9341

8x
6299413

1x
6480277

6x
614124

4x
4169960

90

4x
302324

1x
6447508

1x
6130007

2x
6469455

1x
6471852

2x
302024

3x
6335388

1x
6245281

8x
6279875

1x
6092585

2x
6138634

1x
370526

1x
6467583

8x
6258607

4x
6254248

2x
6287550

1x
6376786

1x
6311467

2x
6240216

6x
6240211

1x
6240515

1x
6392168

1x
6480276

4x
6214811

4x
6214812

10x
6216905

10x
6166857

4x
4528482

2x
4530028

2x
6440474

5x
4502089

4x
6042956

1x
6103985

3x
6482967

2x
6440475

8x
6482974

8x
4578094

1x
6097430

4x
4569836

1x
4667595

1x
6384912

3x
6482968

2x
6482963

2x
6482969

2x
6217673

1x
6482966

2x
6482971

1x
6443709

2x
6482970

1x
6480278

4x
4211219

7x
6196221

1x
4211201

4x
6347715

2x
6420741

2x
4211492

3

7

4

1x
4211475

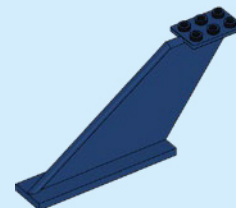
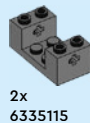
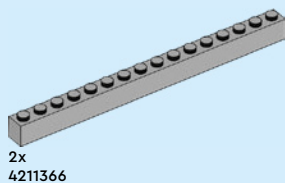
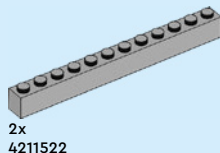
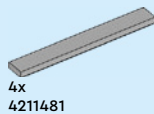
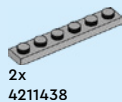
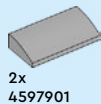
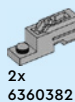

 [LEGO.com/service](https://www.LEGO.com/service)

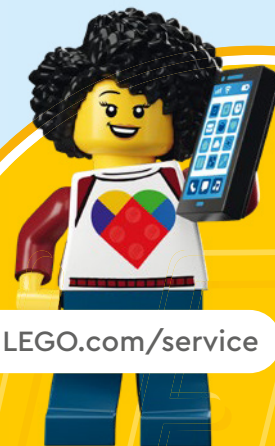

YOU COULD **WIN**

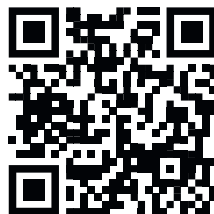

Scan this QR code or go to **LEGO.COM/PRODUCTFEEDBACK** and give us your short feedback about this LEGO® set for a chance to win a cool LEGO prize.

Terms and Conditions apply*



EN: YOU COULD WIN. Terms and Conditions apply* **DE: Du könntest GEWINNEN.** Es gelten die Teilnahmebedingungen* **FR: Tu pourrais GAGNER.** Des conditions s'appliquent* **IT: Potresti VINCERE tu.** Termini e condizioni sono applicabili* **ES: Puedes GANAR.** Aplican términos y condiciones* **PT: Poderá GANHAR.** Aplicam-se termos e condições* **ZH: 轻松获奖. 条款和条件适用*** **PL: Szansa na WYGRANĄ.** Obowiązują warunki korzystania* **CS: Máte šanci VYHRÁT.** Platí všeobecné smluvní podmínky* **SK: Máte šancu VYHRAŤ.** Platia všeobecné zmluvné podmienky* **HU: TE IS NYERHETSZ.** Felhasználási feltételek érvényesek* **RO: Ai putea CÂȘTIGA.** Se aplică termeni și condiții* **BG: Можете да СПЕЧЕЛИТЕ.** Има определени правила и условия* **LV: Tu vari LAIMĒT.** Ir spēkā noteikumi un nosacījumi.* **ET: Sul on võimalus VÕITA.** Kehtivad tingimused* **LT: Jūs galite LAIMĖTI.** Taikomos sąlygos*

*[LEGO.com/productfeedback-terms](https://www.lego.com/productfeedback-terms)

LEGO and the LEGO logo are trademarks of the LEGO Group. ©2024 The LEGO Group.
© 2024 MARVEL