

Booklet available in English on
Livret disponible en français sur
Folleto disponible en español en

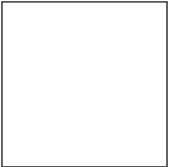



WE'RE MAKING OUR PACKAGING MORE SUSTAINABLE

We're transitioning from single-use plastic to paper-based packaging. As we progress, you may find a mix of paper and plastic in our boxes.

NOUS RENDONS NOS EMBALLAGES PLUS DURABLES

Nous passons des emballages en plastique à usage unique aux emballages à base de papier. Durant la transition, vous pourriez trouver un mélange de papier et de plastique dans nos boîtes.

QUEREMOS HACER MÁS SUSTENTABLES NUESTROS MATERIALES DE EMBALAJE

Estamos cambiando las bolsas de plástico desechables por bolsas con base de papel. Conforme avanzamos en este propósito, puedes encontrar una mezcla de papel y de plástico en nuestras cajas.

[LEGO.com/sustainable-packaging](https://www.lego.com/sustainable-packaging)

LEGO® VIP

1. SIGN UP
INSCRIVEZ-VOUS
REGÍSTRATE

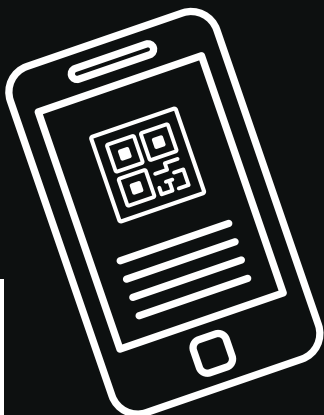

2. EARN POINTS FOR PURCHASES
GAGNEZ DES POINTS POUR
VOS ACHATS
GANA PUNTOS POR TUS
COMPRAS

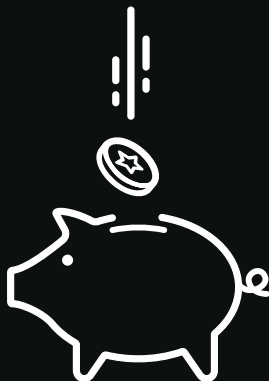

3. REDEEM POINTS FOR
REWARDS, EXPERIENCES,
DISCOUNTS & MORE
ÉCHANGEZ DES POINTS
CONTRE DES RÉCOMPENSES,
DES EXPÉRIENCES, DES
RÉDUCTIONS ET PLUS ENCORE
CANJEA PUNTOS POR
RECOMPENSAS, EXPERIENCIAS,
DESCUENTOS Y MUCHO MÁS

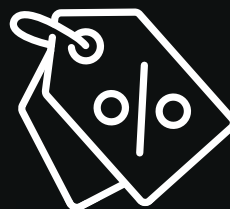
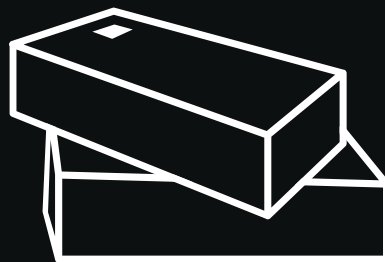

EARTH'S MIGHTIEST HEADQUARTERS

In *The Avengers*, Tony Stark's beacon of self-sustaining clean energy is a formidable focal point on the Manhattan skyline. Severely shattered in the climactic Battle of New York, the Avengers Tower rises from the ashes to become the official assembly of Earth's mightiest heroes. A detailed, architectural gem featured in so many memorable scenes throughout Marvel's Infinity Saga, the Avengers Tower has long been on LEGO® Marvel fans' wish list – and an irresistible challenge for the LEGO design team!

LE QUARTIER GÉNÉRAL LE PLUS GLORIEUX DE LA PLANÈTE

Dans *Les Avengers*, le flambeau d'une nouvelle énergie verte autogénérée de Tony Stark ne passe pas inaperçu dans l'horizon de Manhattan. Gravement endommagée lors de la bataille de New York, la tour des Avengers renaît de ses cendres pour devenir le lieu de rassemblement officiel des plus grands héros de la Terre. Un bijou architectural détaillé apparaissant dans de nombreuses scènes mémorables de la Saga de l'Infini de Marvel, la tour des Avengers est depuis longtemps un rêve pour les amateurs de LEGO® Marvel... et un défi irrésistible pour l'équipe de conception LEGO !

EL CUARTEL GENERAL MÁS PODEROSO DE LA TIERRA

En *The Avengers: Los Vengadores*, el faro de energía limpia autosuficiente de Tony Stark es un formidable punto de referencia en el horizonte de Manhattan. Gravemente dañada tras la decisiva batalla de Nueva York, la Torre de los Vengadores resurge de sus cenizas para convertirse en la sede oficial de los héroes más poderosos de la Tierra. Una exquisita joya arquitectónica que protagoniza numerosas escenas memorables de la Saga Infinity de Marvel, la Torre de los Vengadores llevaba mucho tiempo en la lista de deseos de los fans de LEGO® Marvel, ¡y era un desafío irresistible para el equipo de diseño de LEGO!





Mark Stafford,
Senior LEGO® Model Designer / Concepteur de modèles principal LEGO® / Modelista sénior de LEGO®

Justin Ramsden,
Senior LEGO® Model Designer / Concepteur de modèles principal LEGO® / Modelista sénior de LEGO®

FROM THE DESIGN TEAM

Based on the Avengers Tower as seen in *Avengers: Age of Ultron*, the building itself is a fascinating structure. The rear is much wider than the front, and the concave side has a twist to it. Just as the movie model evolved over time, we modified the twisted double inverse curve to make our model structurally sound and incorporate the removable wall to reveal the detailed interior. Get ready to explore a cornucopia of action scenes, more than 30 characters and fun Easter eggs from Marvel's Infinity Saga, from the Chitauri invasion to containment pods and hidden Pym particles!

UN MOT DE L'ÉQUIPE DE CONCEPTION

Basé sur la tour des Avengers vue dans *Avengers : L'Ère d'Ultron*, le bâtiment lui-même est une structure fascinante. L'arrière est beaucoup plus large que l'avant, et le côté concave est tordu. Tout comme le modèle du film a évolué avec le temps, nous avons modifié la double courbe inverse torsadée pour rendre notre modèle structurellement solide et incorporer la paroi amovible pour révéler l'intérieur détaillé. Préparez-vous à découvrir une foule de scènes d'action, plus de 30 personnages et des œufs de Pâques amusants de la Saga de l'Infini de Marvel, de l'invasion Chitauri aux capsules de confinement en passant par les particules Pym cachées !



Mark Tranter,
LEGO® Graphic Designer / Graphiste LEGO® / Diseñador gráfico de LEGO®



IMPRESIONES DEL EQUIPO DE DISEÑO

Basada en la Torre de los Vengadores que aparece en *Avengers: Era de Ultrón*, el edificio mismo es una estructura fascinante. La parte trasera es mucho más ancha que la delantera, y el lado cóncavo tiene un giro difícil de reproducir. Al igual que el modelo de la película evolucionó con el tiempo, modificamos la doble curva inversa enroscada para que nuestro modelo fuera estructuralmente sólido e incorporamos la pared removible para ofrecer acceso al detallado interior. Prepárate para explorar un sinfín de escenas de acción, más de 30 personajes y divertidas sorpresas ocultas de la Saga Infinity de Marvel, ¡desde la invasión Chitauri hasta los módulos de contención y las partículas Pym escondidas!



MAKE YOURSELF AT HOME

From the lobby to the rooftop, each floor represents scenes with the heroes and villains of the Infinity Saga. You'll find Wanda Maximoff and Vision battling Ultron, Tony Stark examining Loki's scepter/"glow stick of destiny" or working on his Iron Man suits with Ms. Potts, Dum-E fighting fire hazards (actual or perceived), and who can forget the Hulk "Puny God"-smashing Loki through the floor, or Captain America admiring his own... well, if you know, you know. Ready to move into your new headquarters? Feel free to bring your own shawarma.

FAITES COMME CHEZ VOUS

De l'entrée au toit, chaque étage représente des scènes avec les héros et les méchants de la saga de l'Infini. Vous trouverez Wanda Maximoff et Vision en train de combattre Ultron, Tony Stark examinant le sceptre/la « baguette fluo de la destinée » de Loki ou travaillant sur ses armures d'Iron Man avec Mme Potts, Dum-E luttant contre les risques d'incendie (réels ou supposés), sans oublier Hulk écrasant Loki sur le sol tel un « petit dieu », ou Capitaine America admirant son propre... vous-savez-quoi. Préparez-vous à emménager dans votre nouveau quartier général. N'hésitez pas à apporter votre propre shawarma.



SIÉNTETE COMO EN CASA

Desde el vestíbulo hasta la azotea, todas las plantas reproducen escenas con los héroes y villanos de la Saga Infinity. Encontrarás a Wanda Maximoff y Visión peleando contra Ultrón, a Tony Stark examinando el cetro/"linternita del destino" de Loki o trabajando en sus armaduras de Iron Man con la Sra. Potts, a Dum-E enfrentando peligros de incendio (reales o percibidos), y quién puede olvidar a Hulk aplastando al debilucho de Loki contra el suelo, o al Capitán América admirando su... Bueno, si lo sabes, lo sabes. ¿Listo para mudarte a tu nuevo cuartel general? Puedes traerte tu propio *shawarma*.



BUILDERS, ASSEMBLE!

Avengers Tower is now yours to assemble. We hope you'll love it 3000 and enjoy the experience!

CONSTRUCTEURS, RASSEMBLEMENT !

Vous pouvez maintenant assembler la tour des Avengers. Nous espérons que vous aimerez l'expérience plus que trois fois mille !

¡CONSTRUCTORES, UNIDOS!

La Torre de los Vengadores es ahora tuya para construirla. ¡Esperamos que la ames 3 millones y disfrutes de la experiencia!

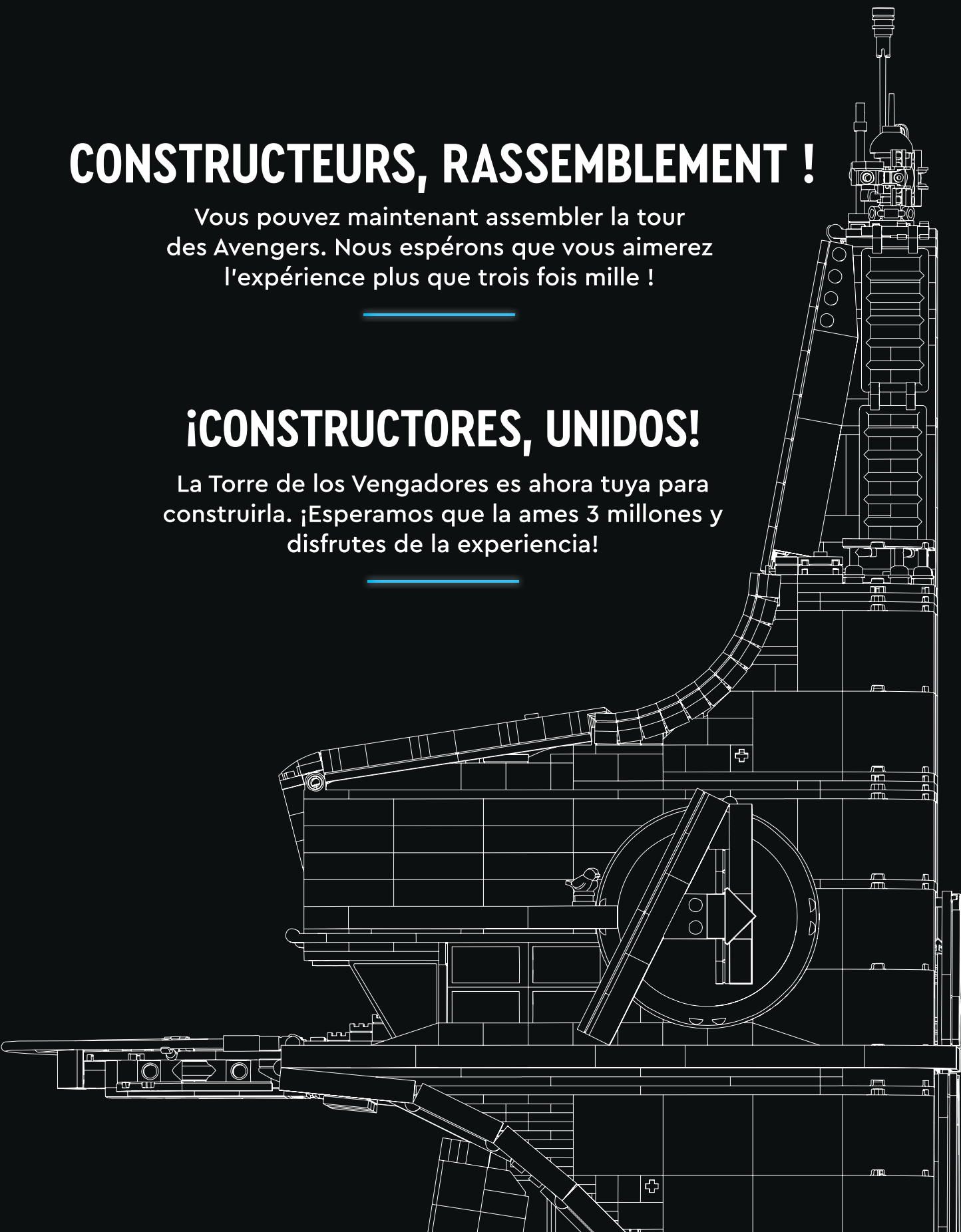

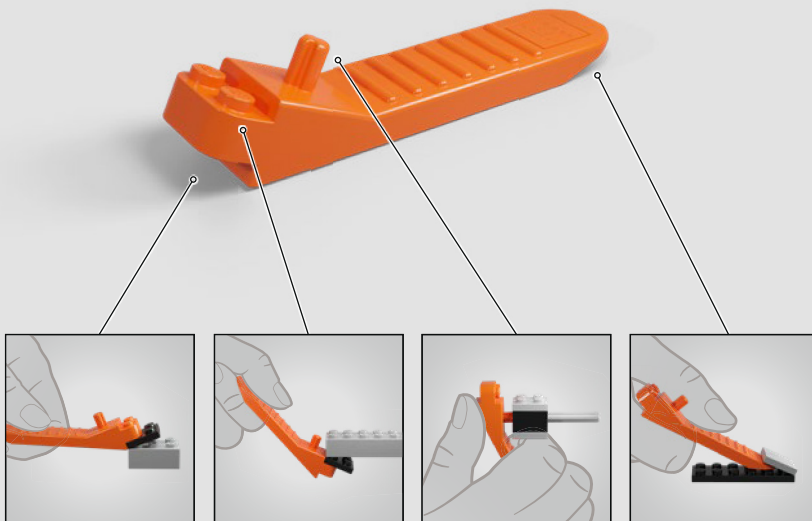

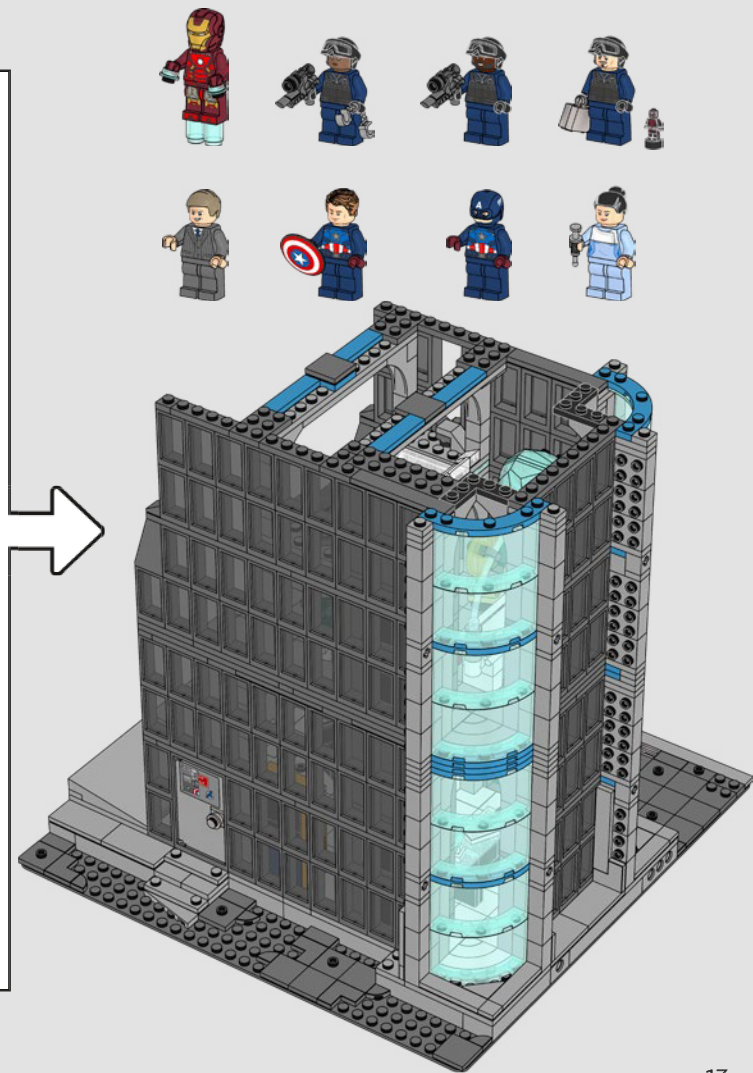
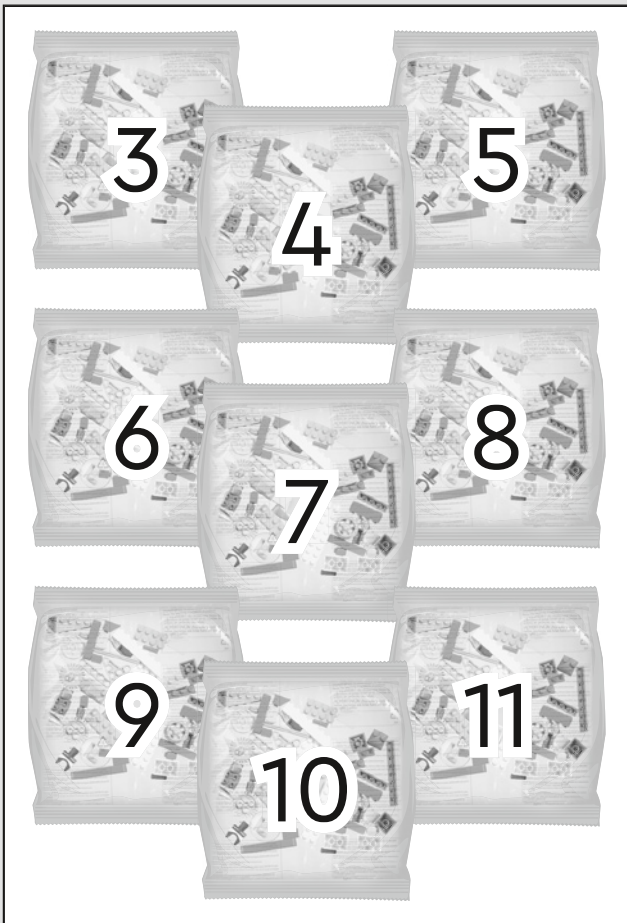
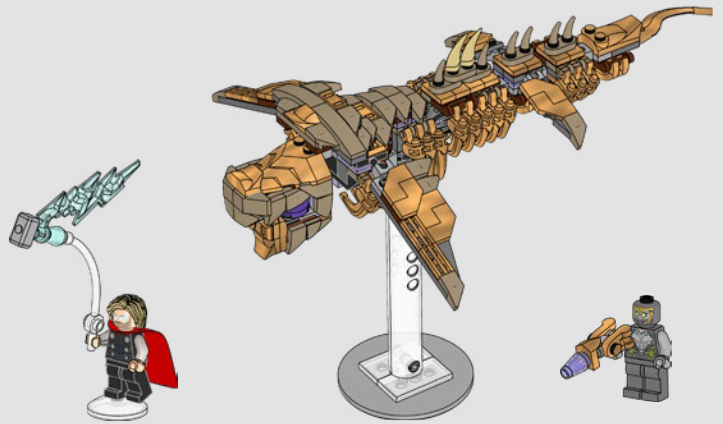
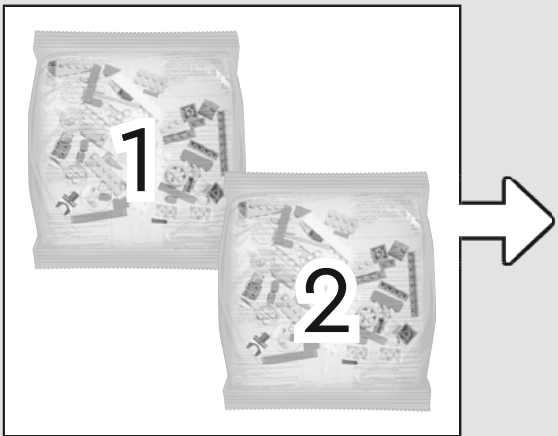

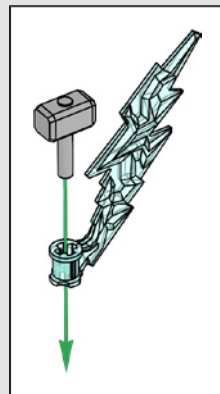
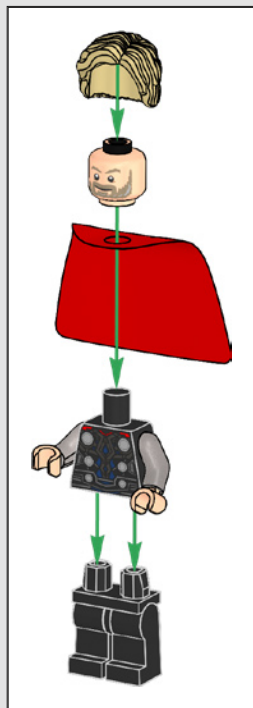

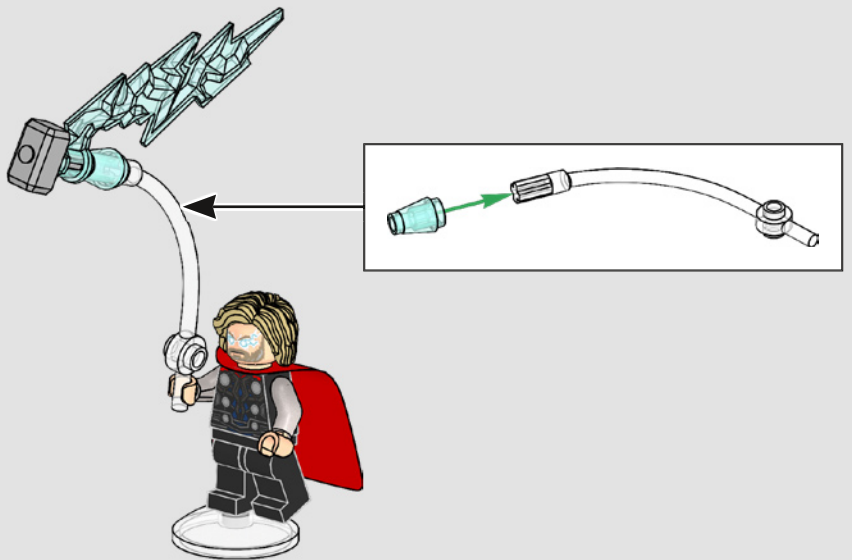
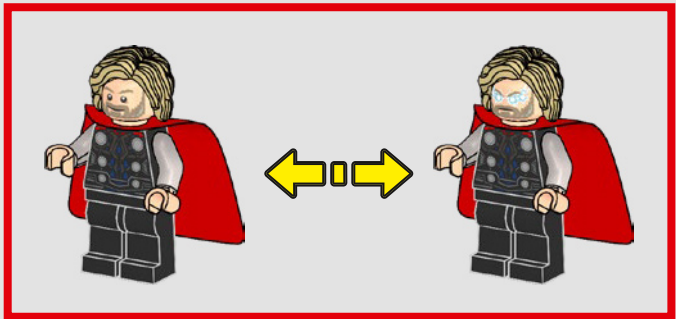

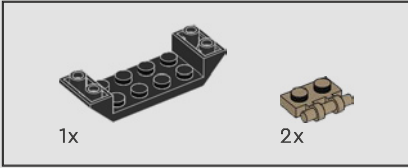
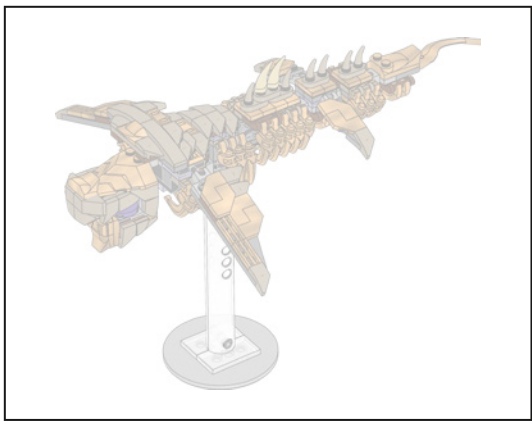

1

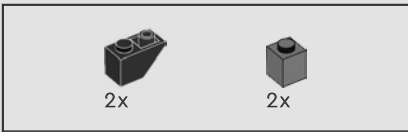
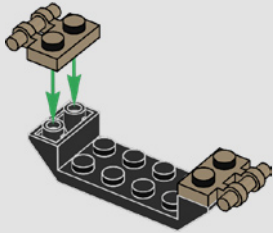

2

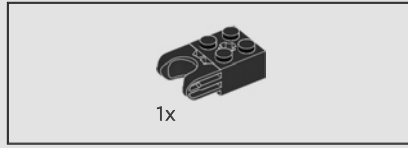
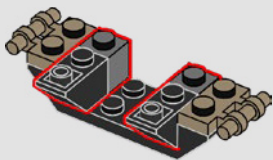

3

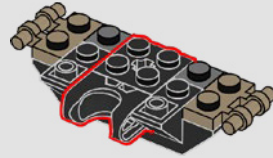

4

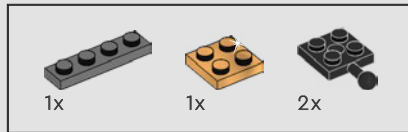

5



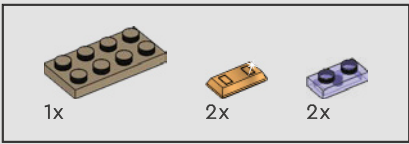

6

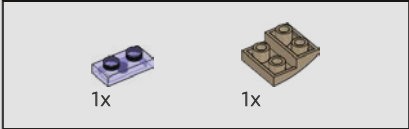
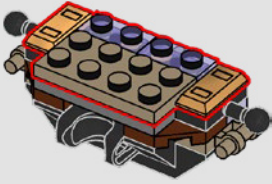

7

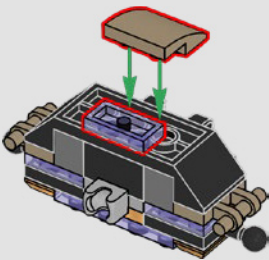

8

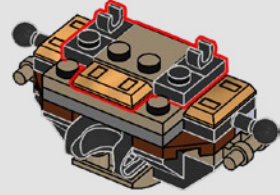

9

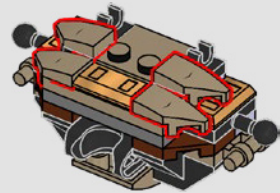

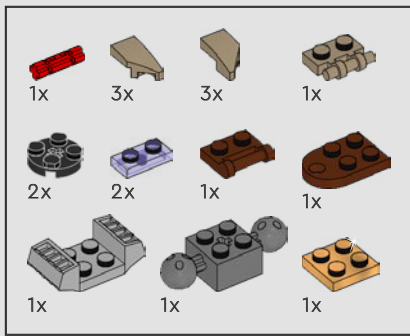

10

1

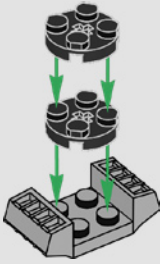

2

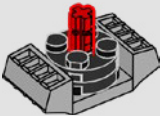

3

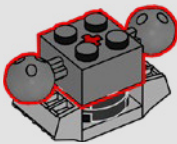

4

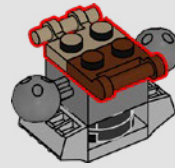

5

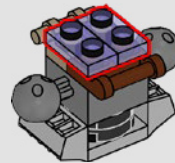

6

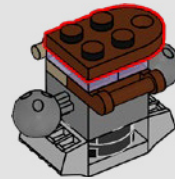

7

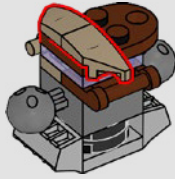

1

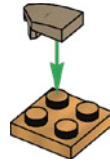

2



8

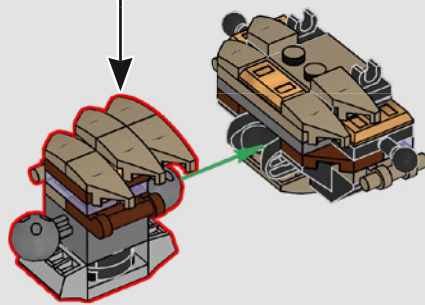
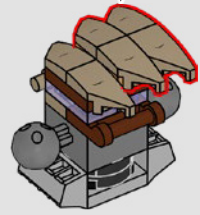

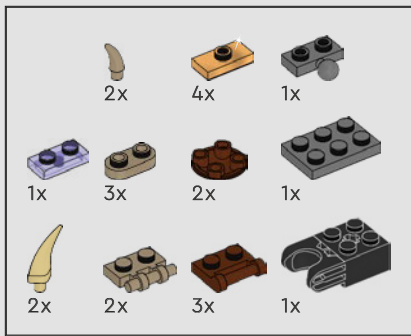

11

1

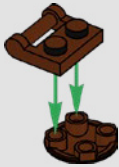

2

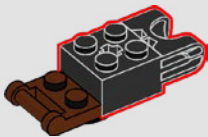

3

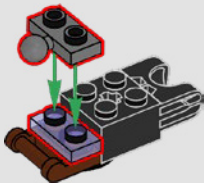

4

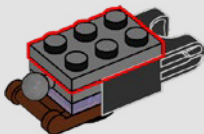

5

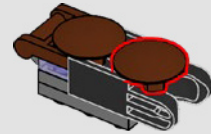
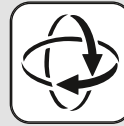

6

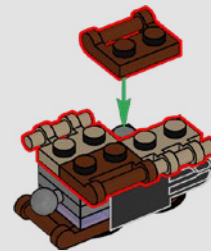
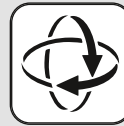

7

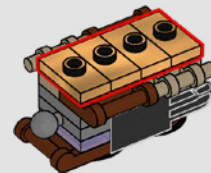

8

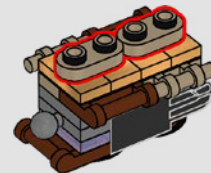

9

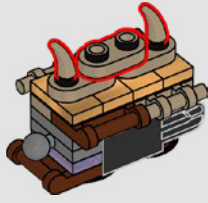

10

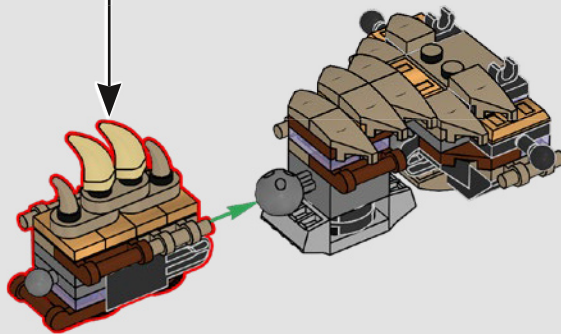
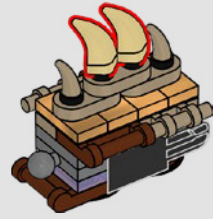

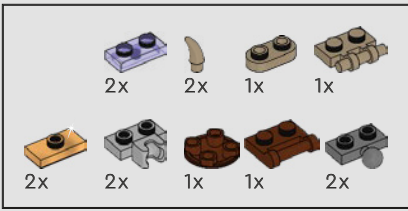

12

1

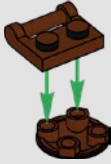

2



3

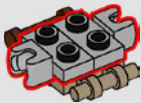

4

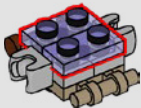

5

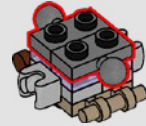

6

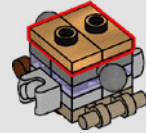

7

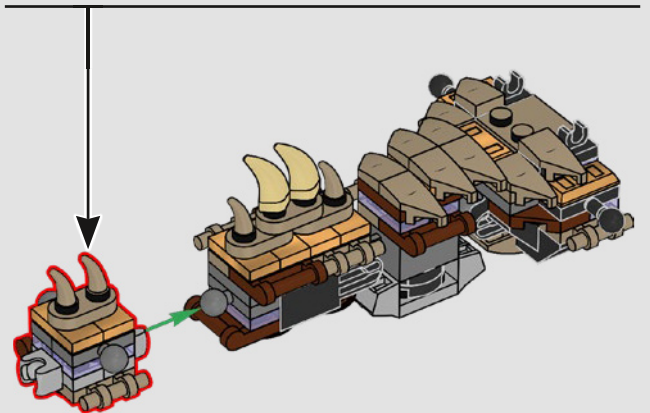
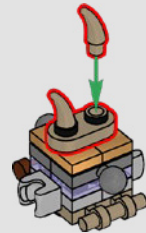



13

1

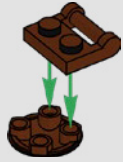

2



3



4



5



6



7

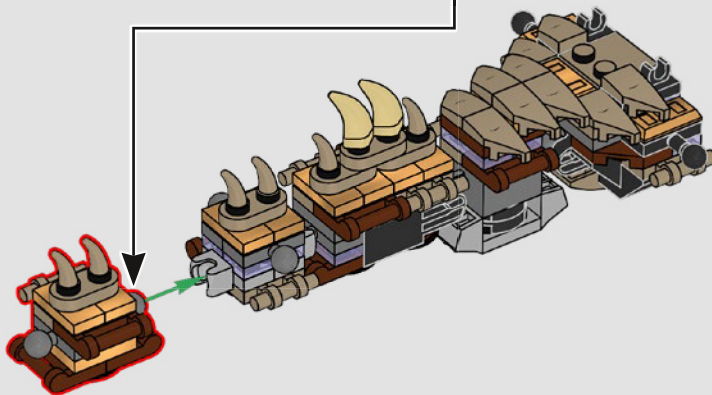
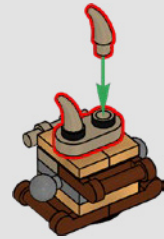

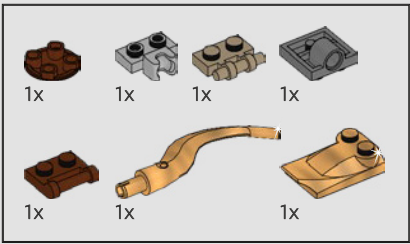

14

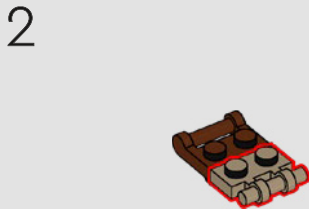
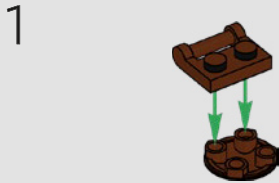

3

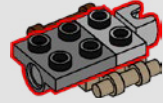

4

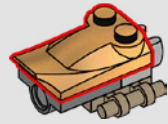

5

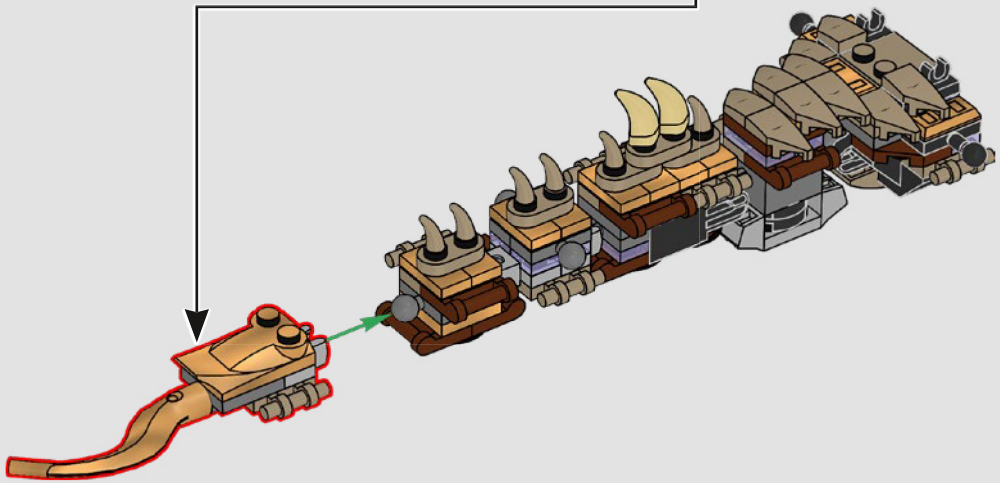
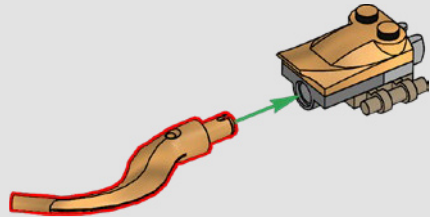

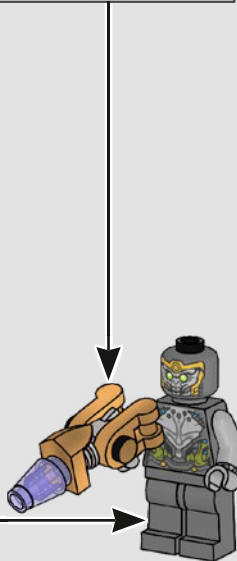
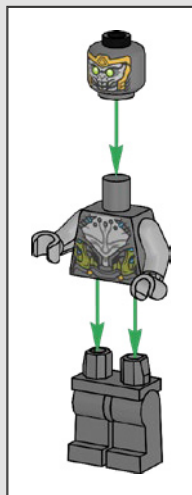
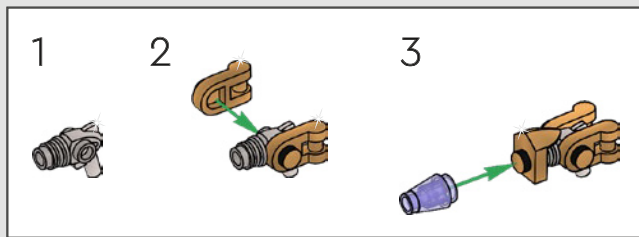
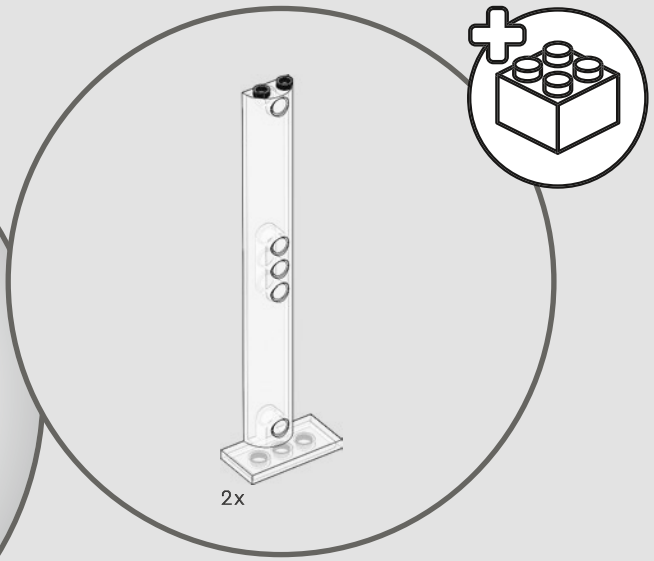
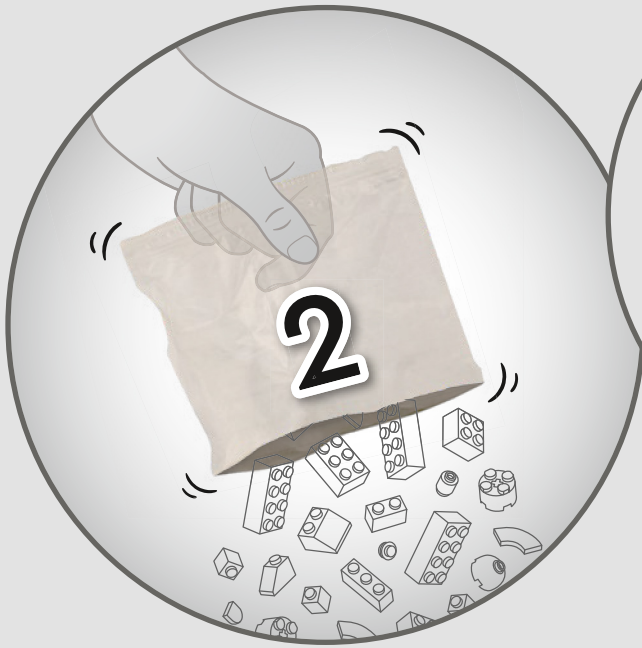

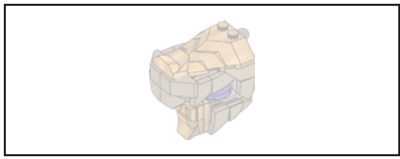

15

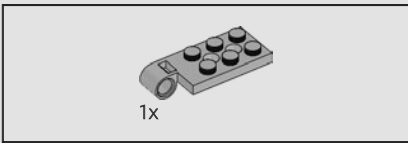
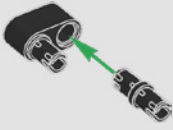

16

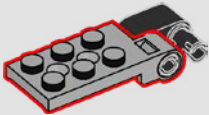

17

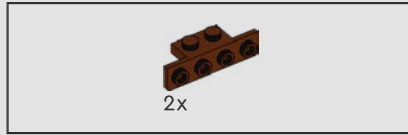
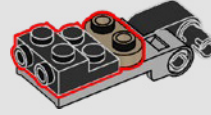

18

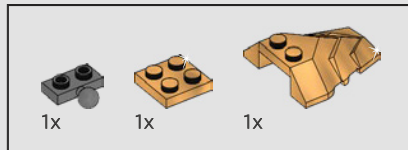
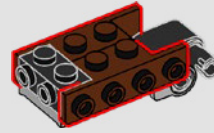

19

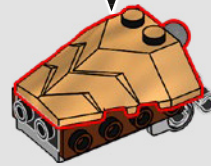
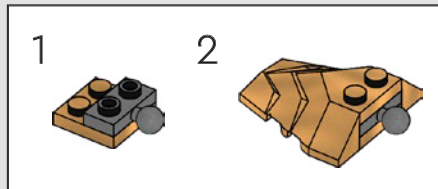



20

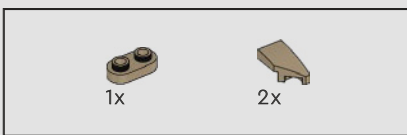
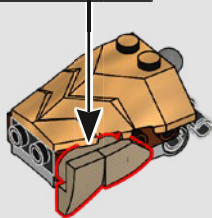
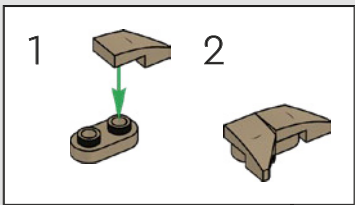

21

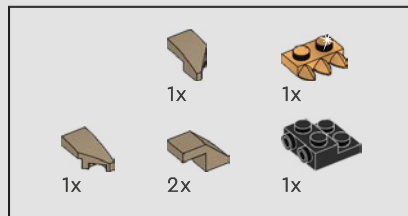
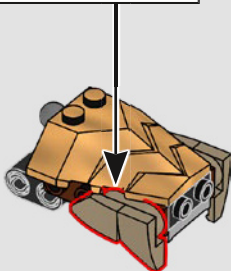
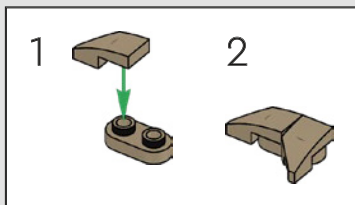

22

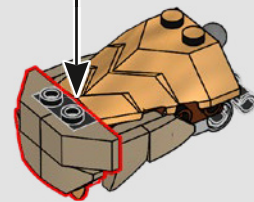
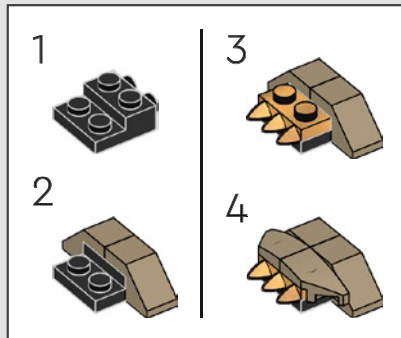

23

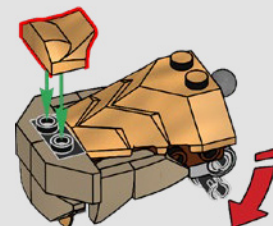



24

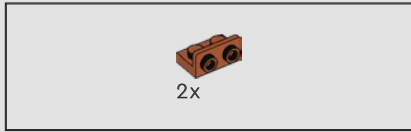
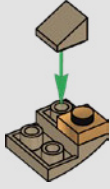

25

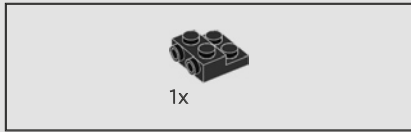
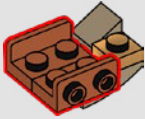

26

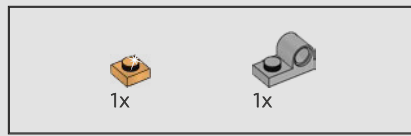
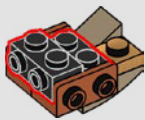

27

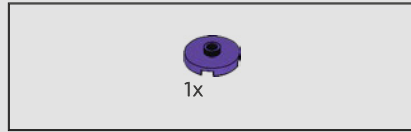
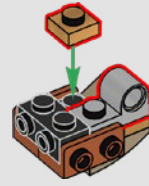

28

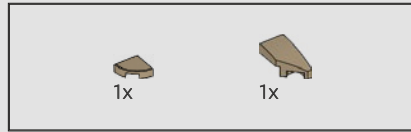
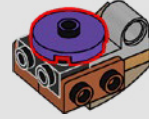

29

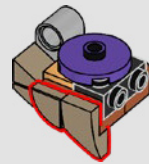

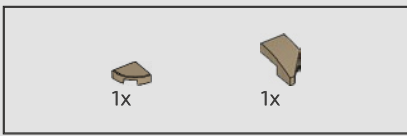

30

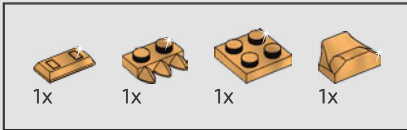
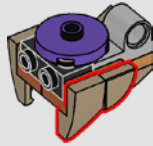

31

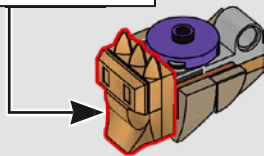
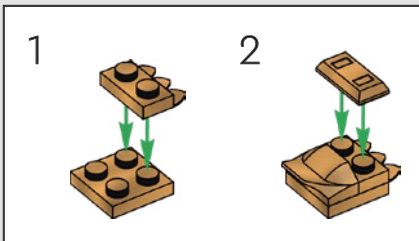

32

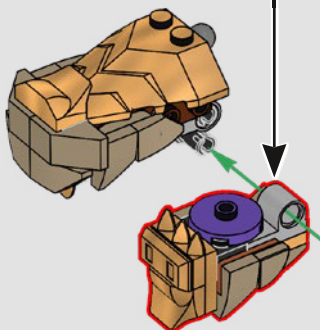

33

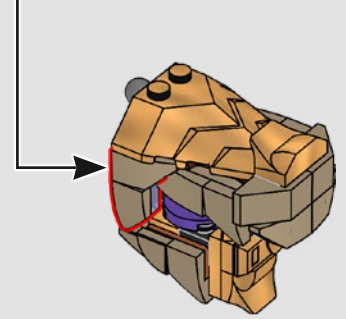
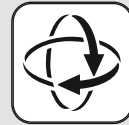
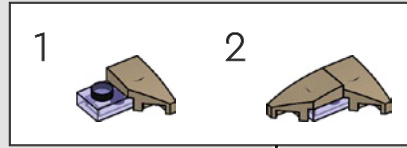

34

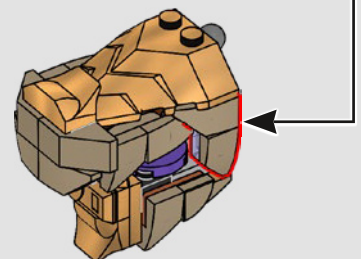
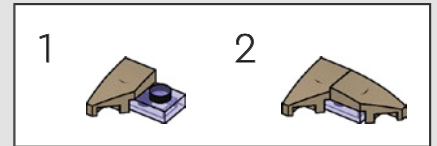

35

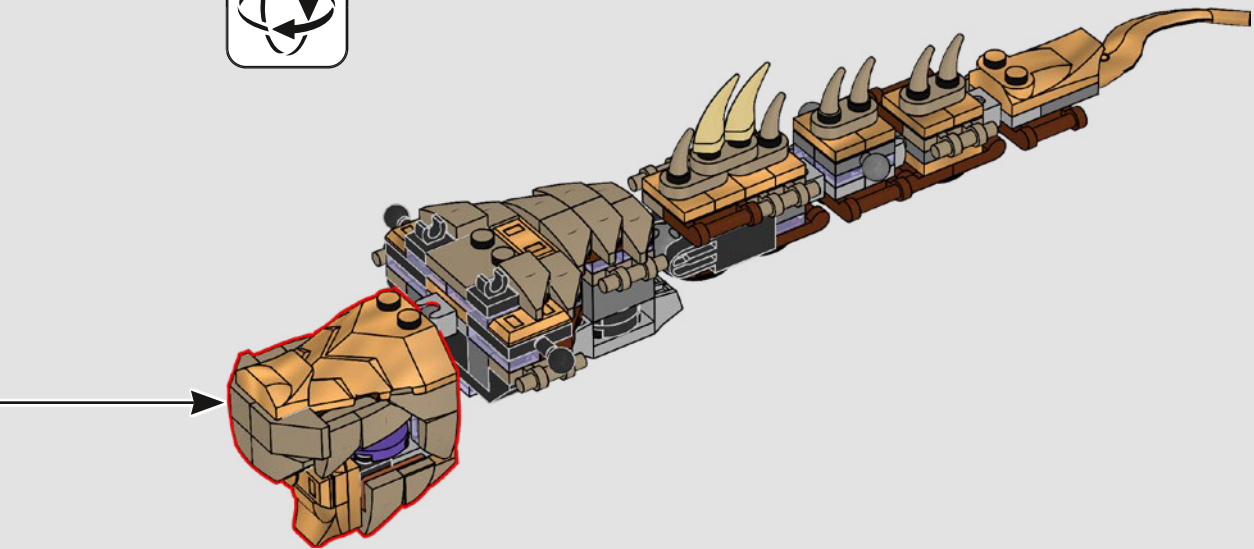



36

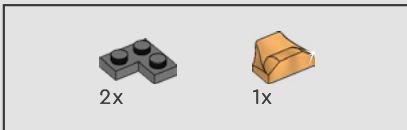
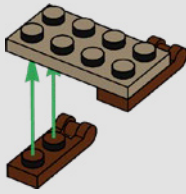

37

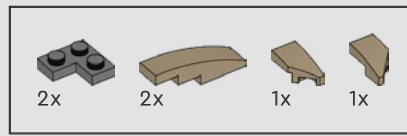
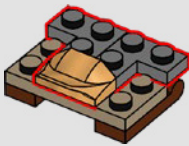

38

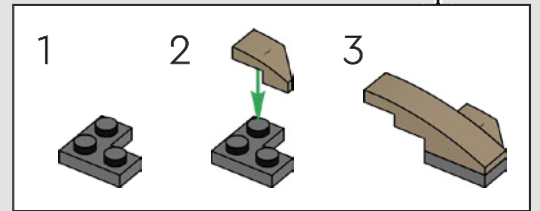
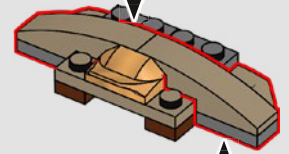
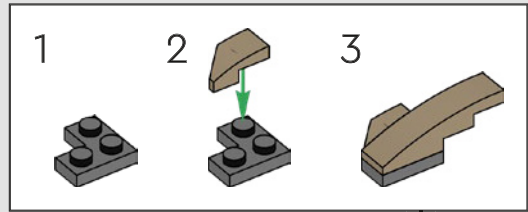

39

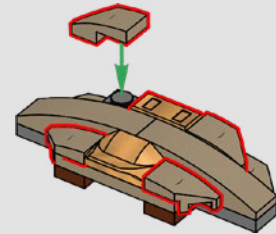

40

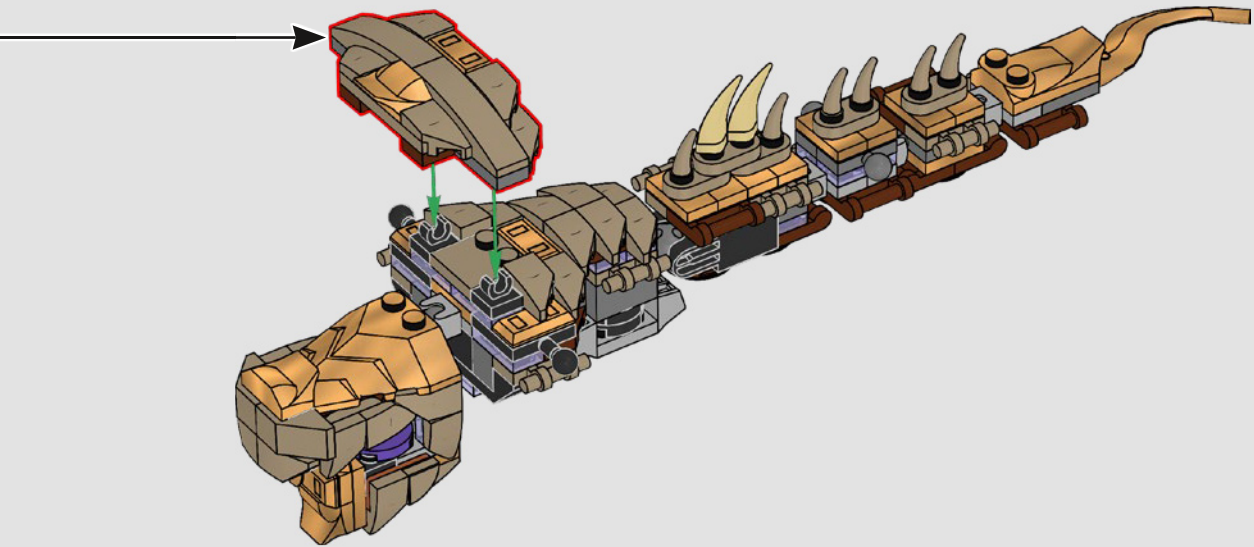

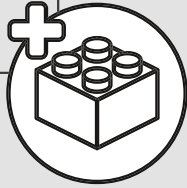
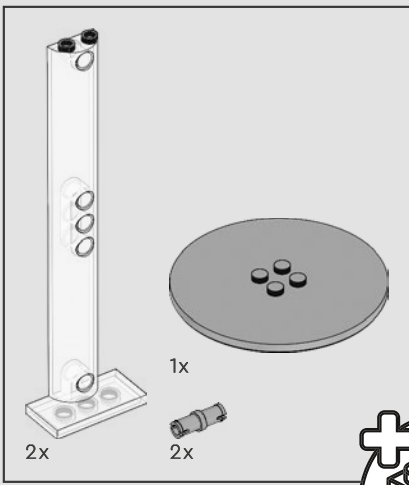

41

1

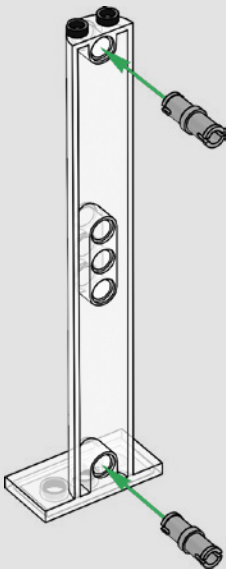

2

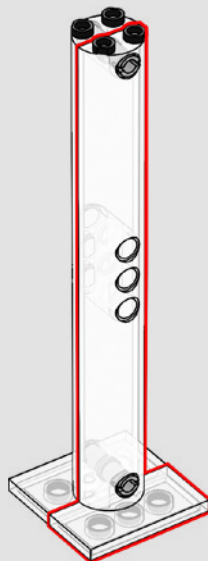

3

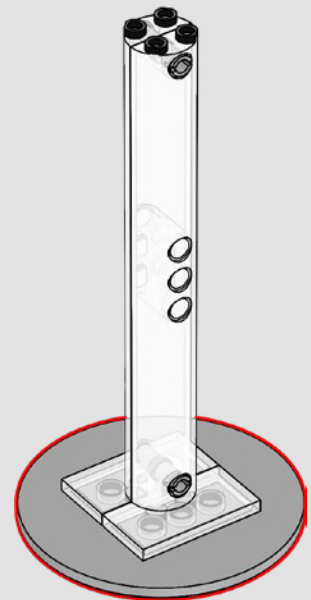

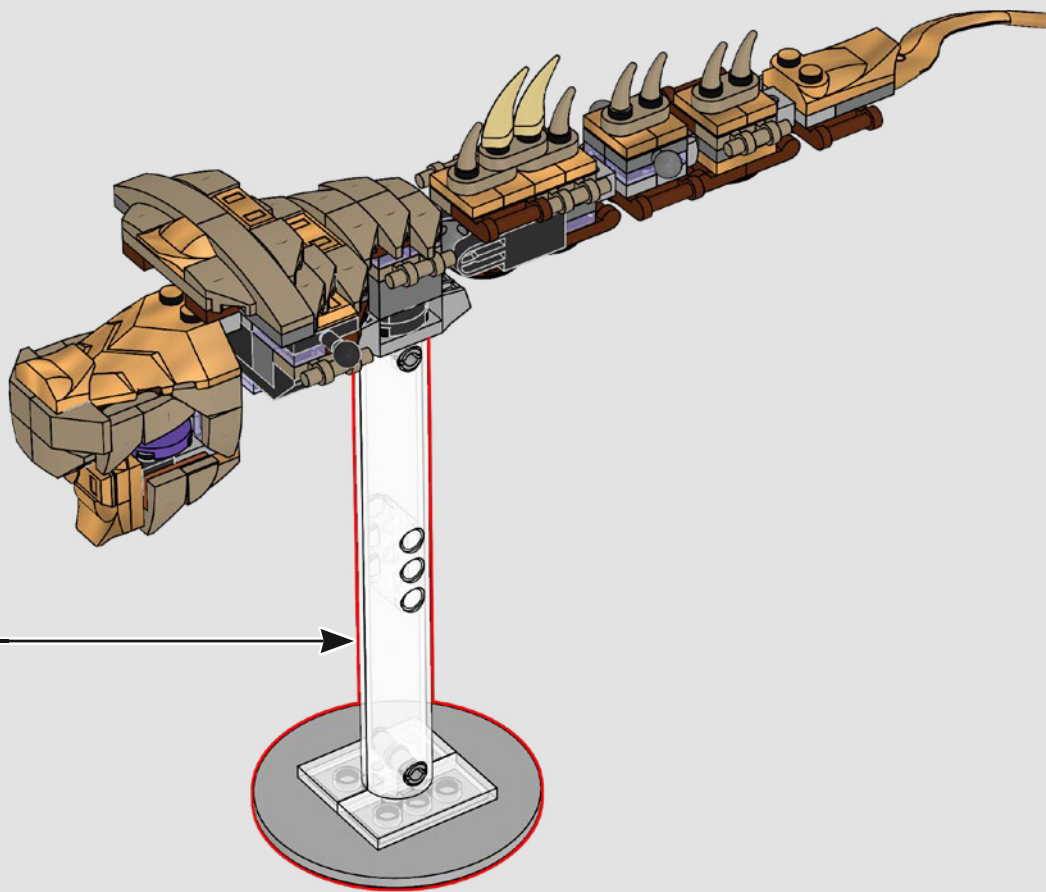

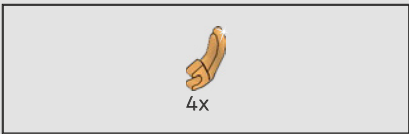

42

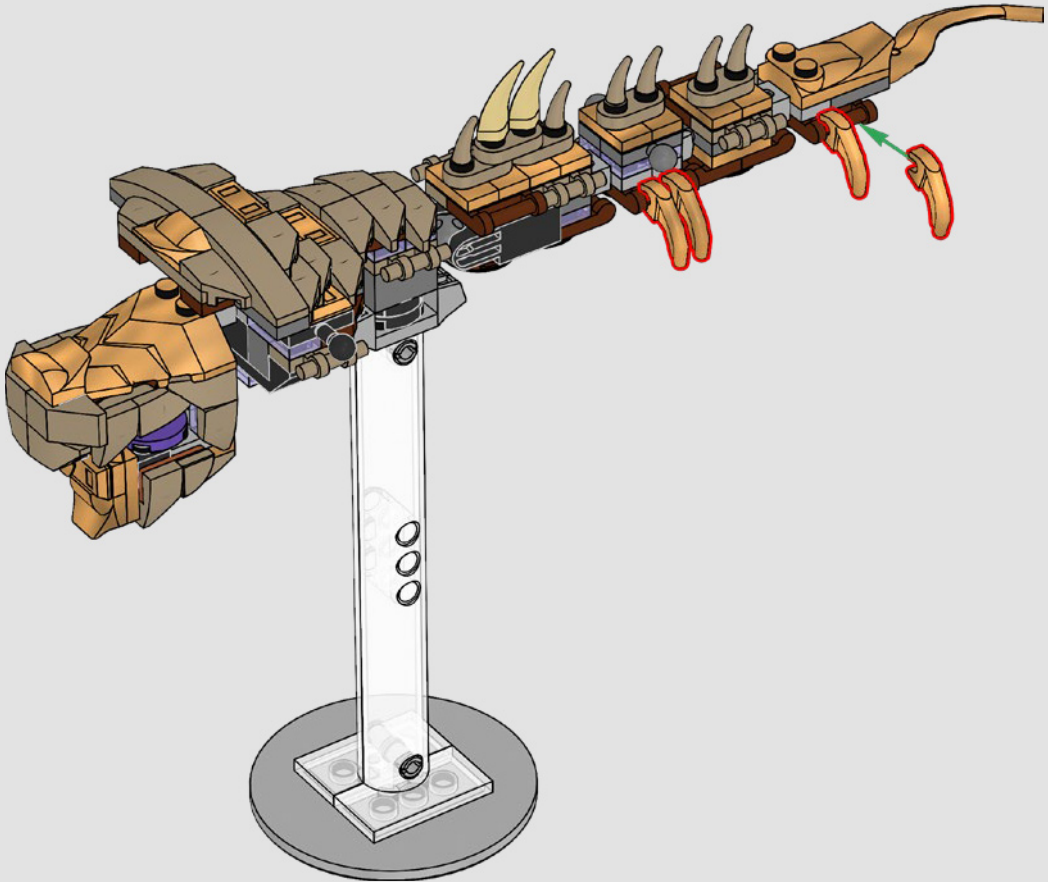

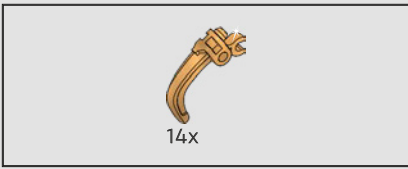

43

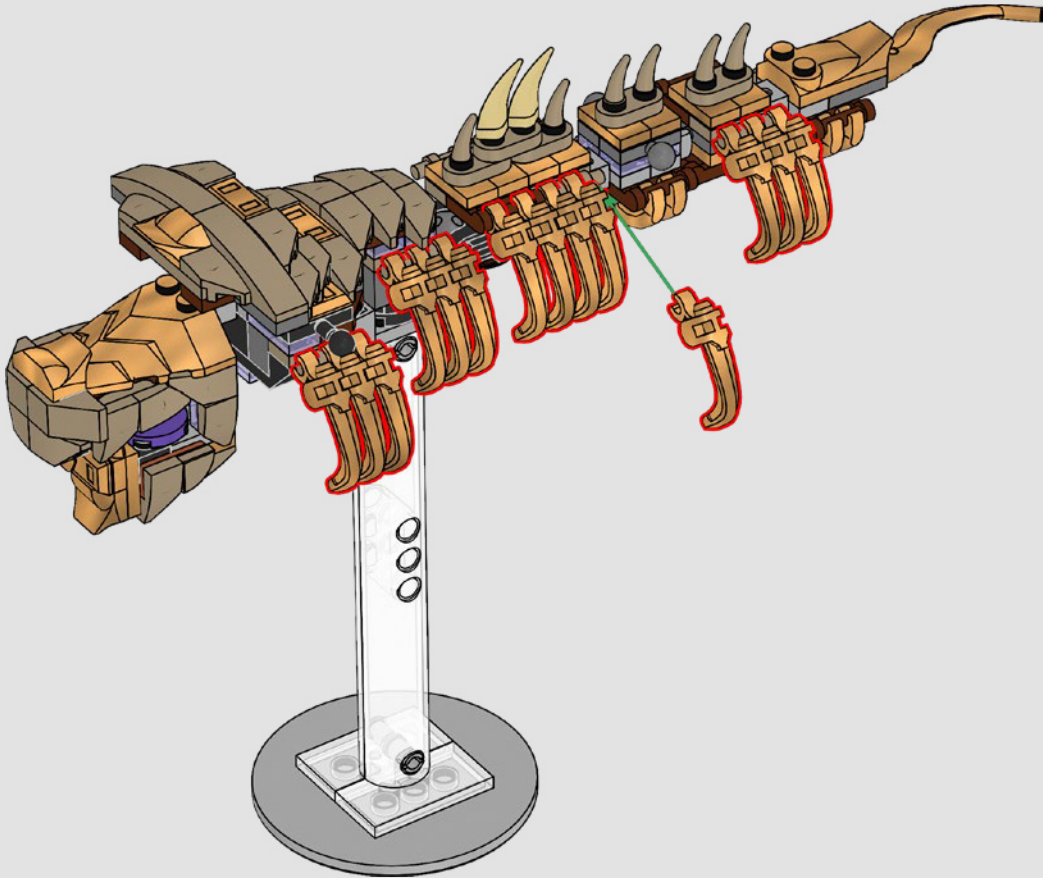

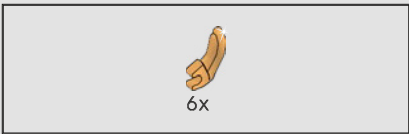

44

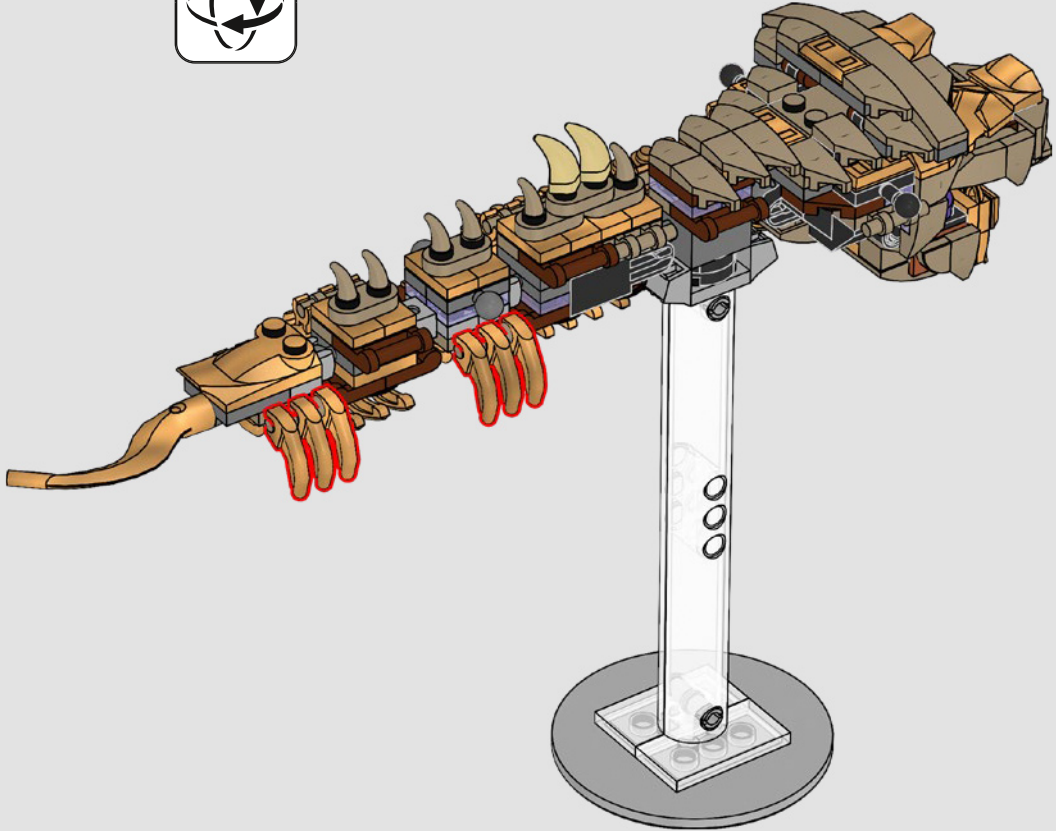



45

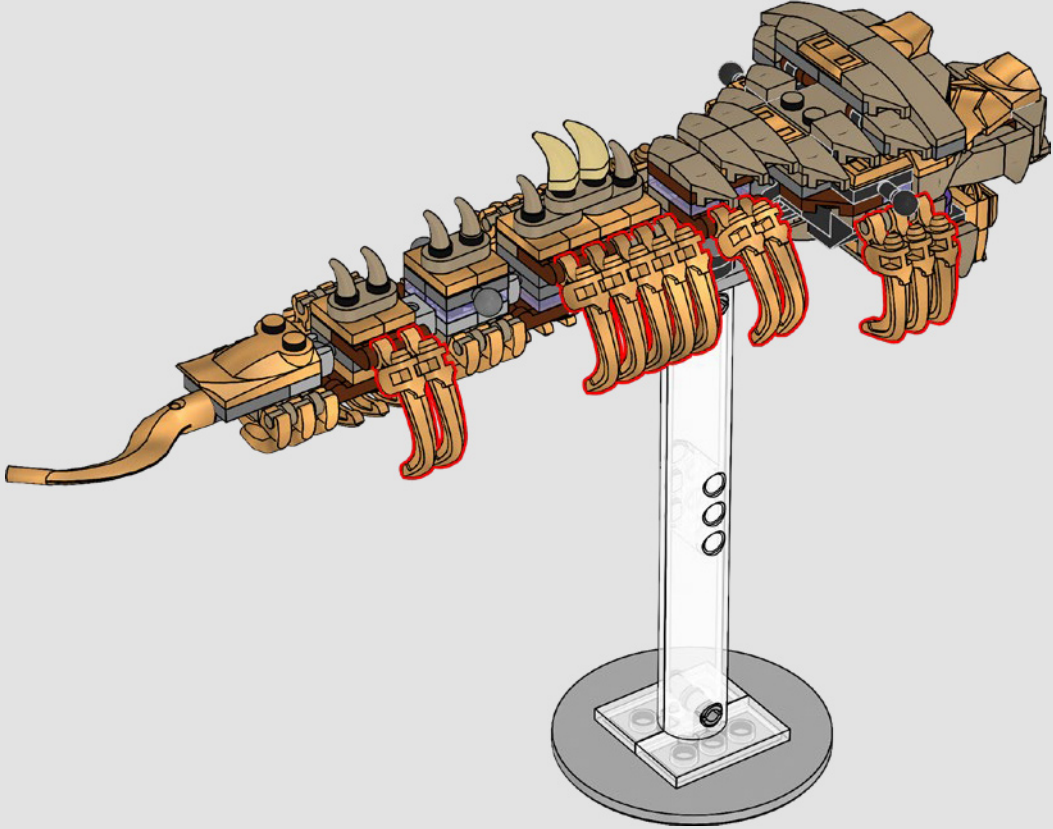

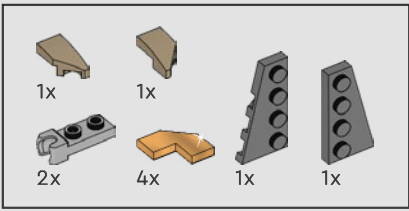

46

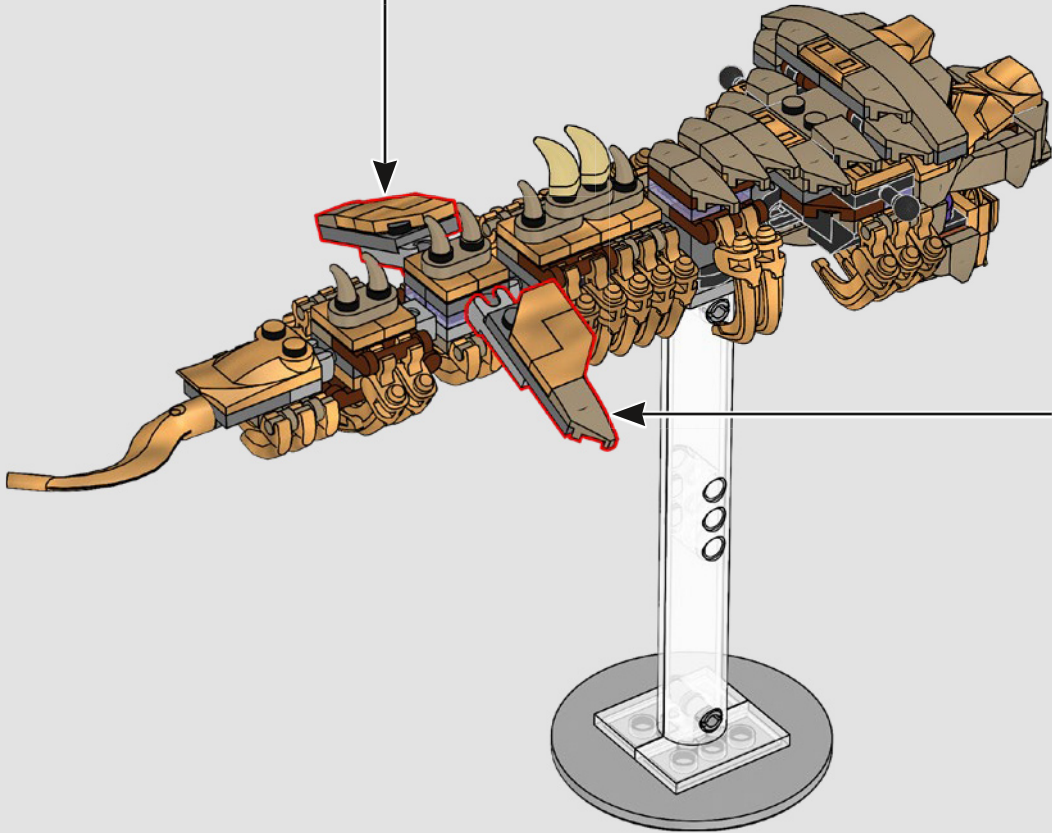
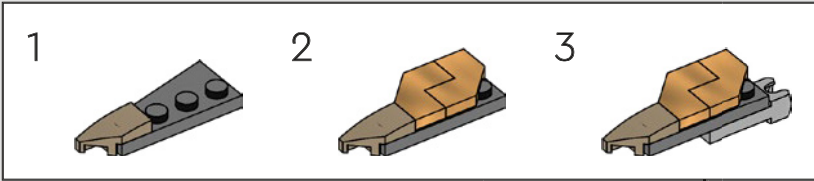
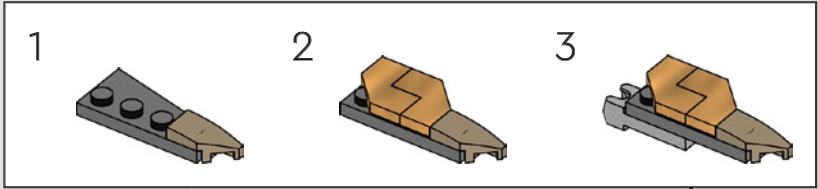

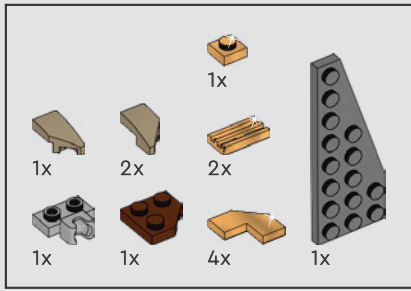

47

1

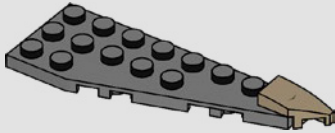

2

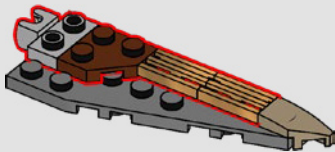

3

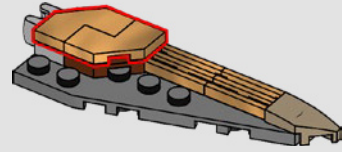

4

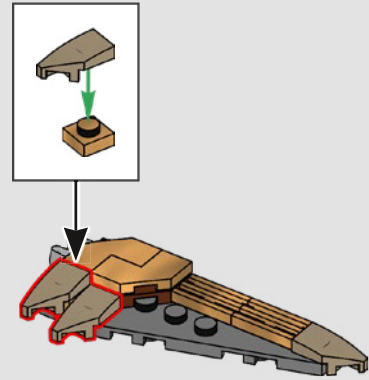

5

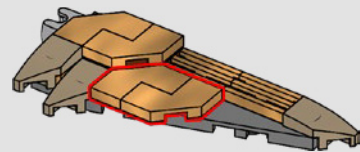

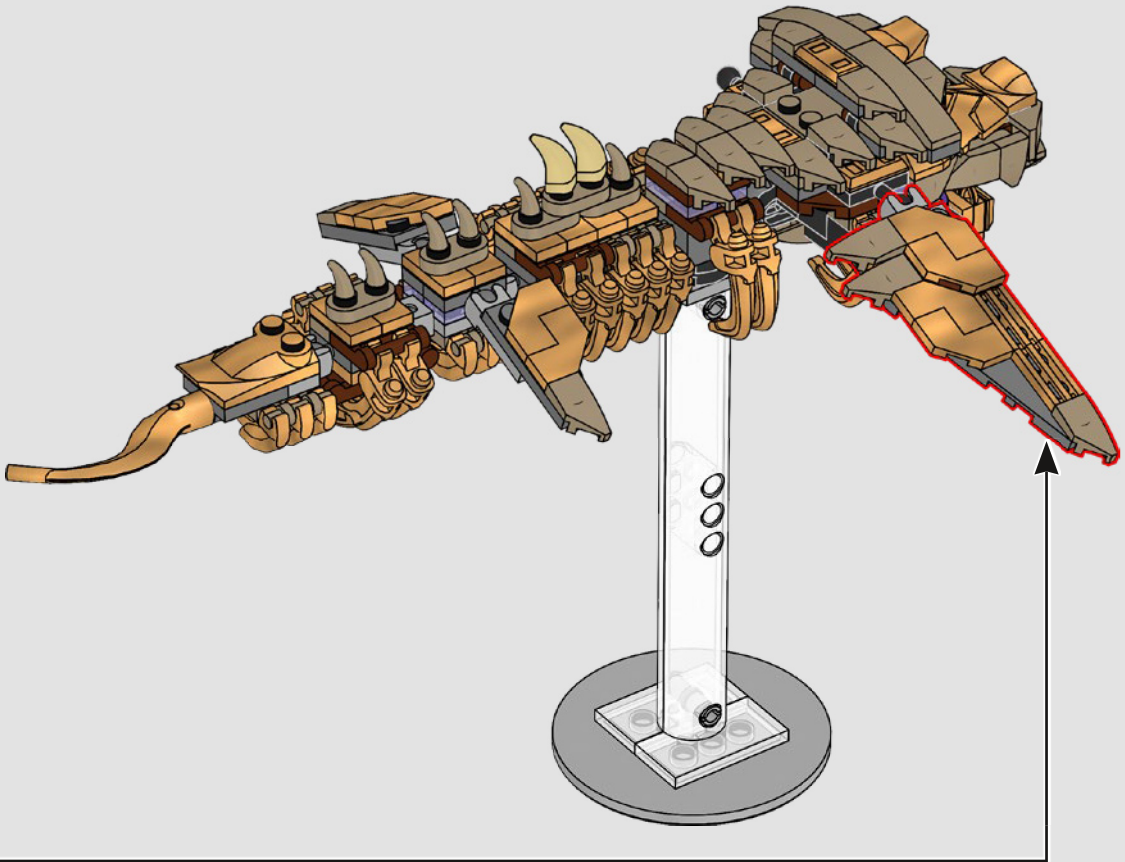

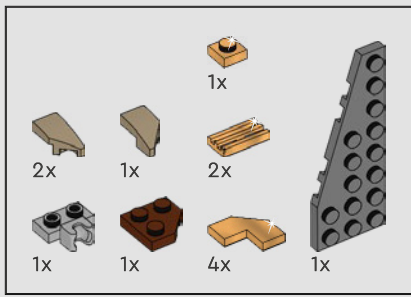

48

1

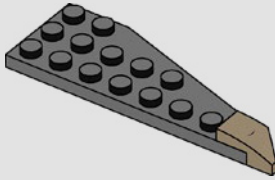

2

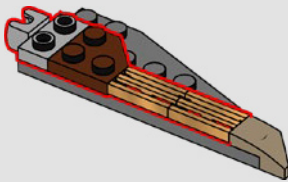

3

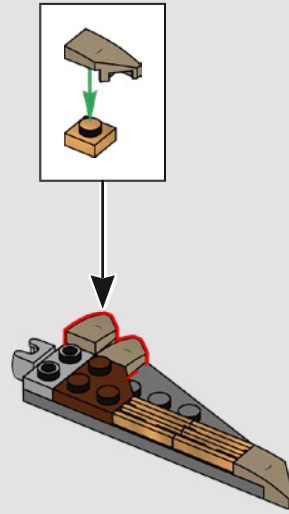

4

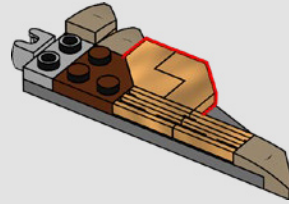

5

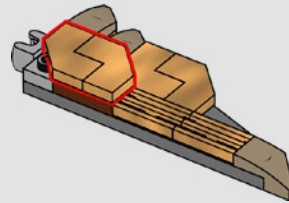

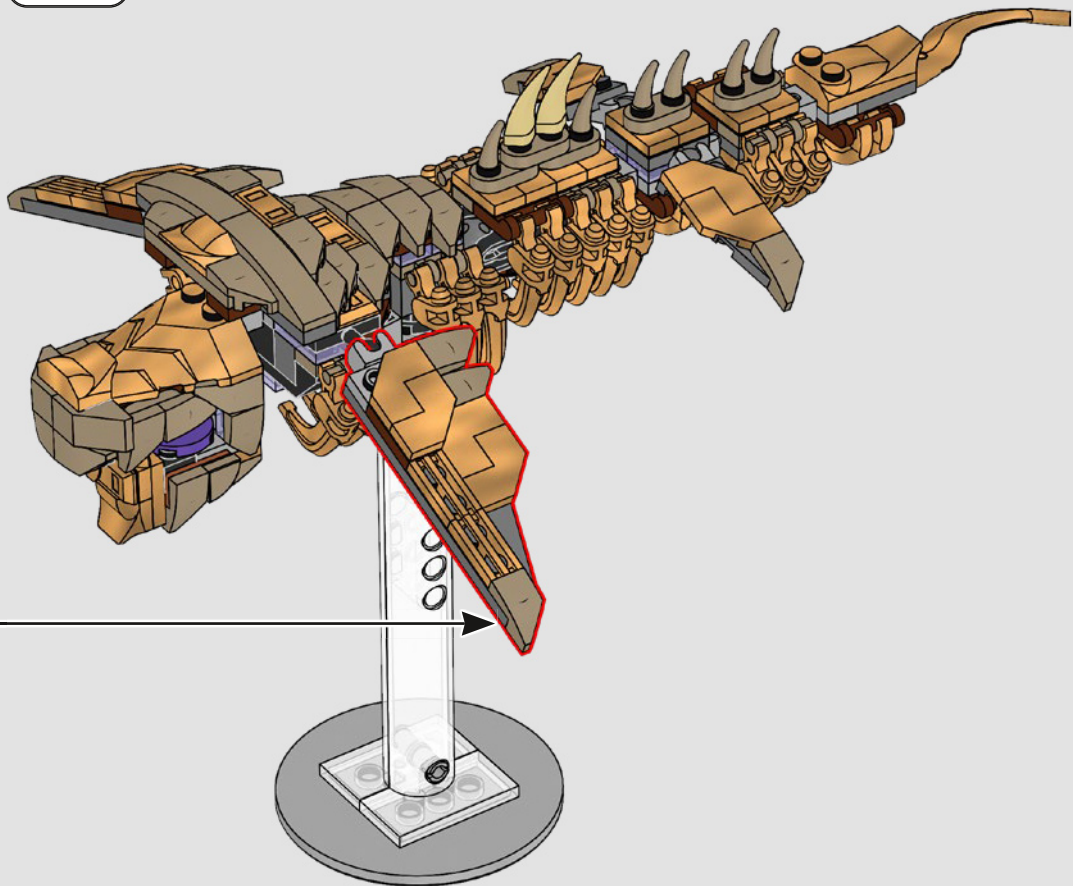

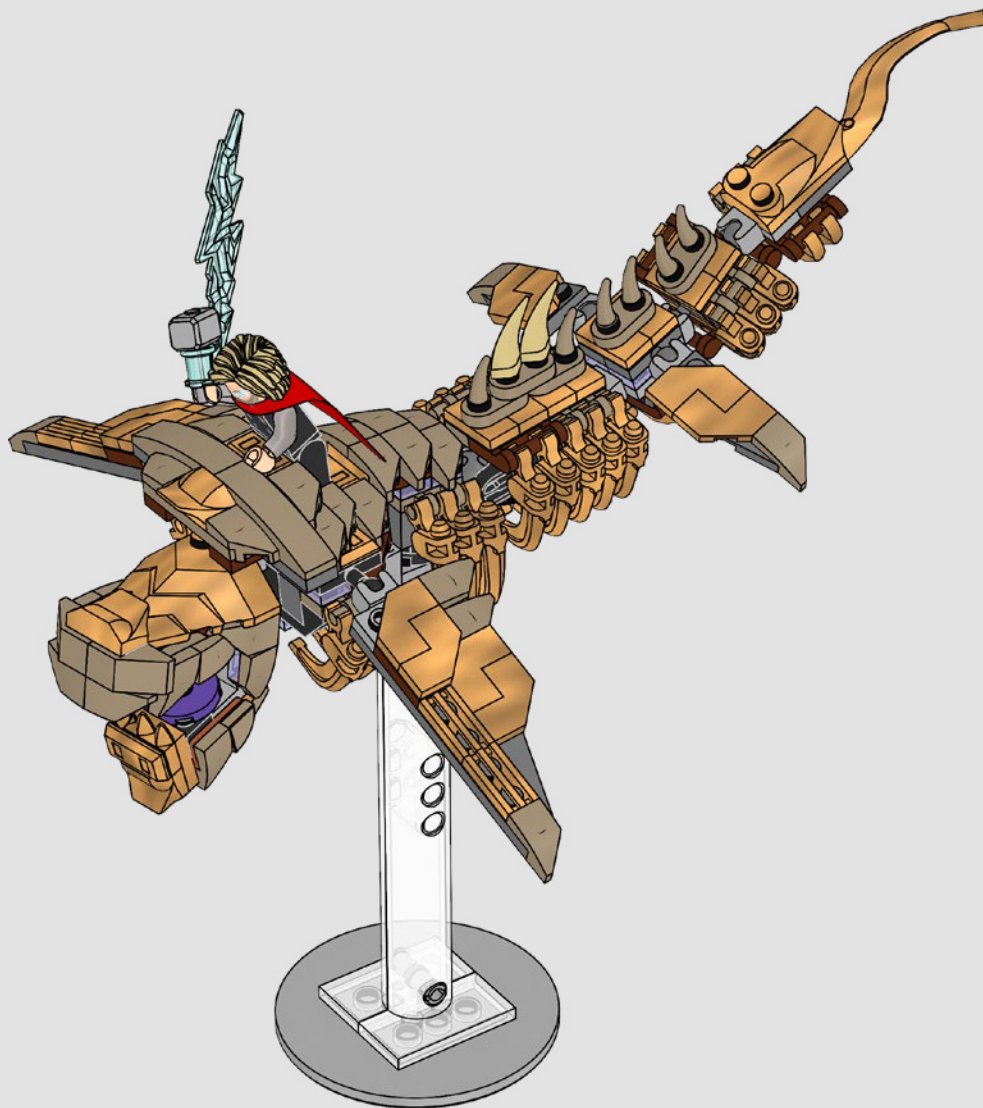

During the climactic battle with the Chitauri in *The Avengers*, Thor destroys one of the monstrous Leviathans in one blow!

Lors de la bataille décisive contre les Chitauri dans *Les Avengers*, Thor détruit l'un des monstrueux Léviathans d'un seul coup !

Durante la batalla culminante contra los Chitauri en *The Avengers: Los Vengadores*, ¡Thor acaba con uno de los monstruosos leviatanes de un solo golpe!



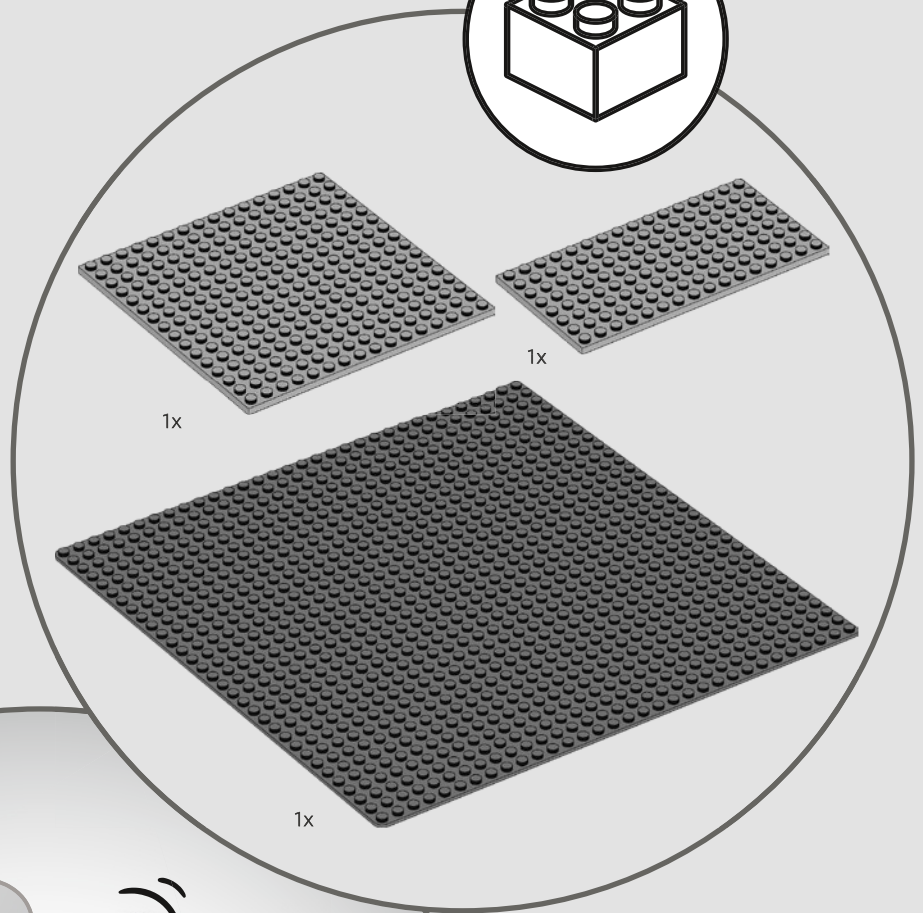
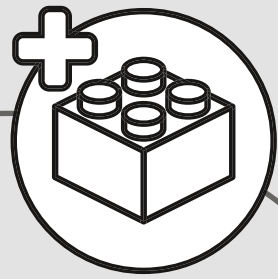

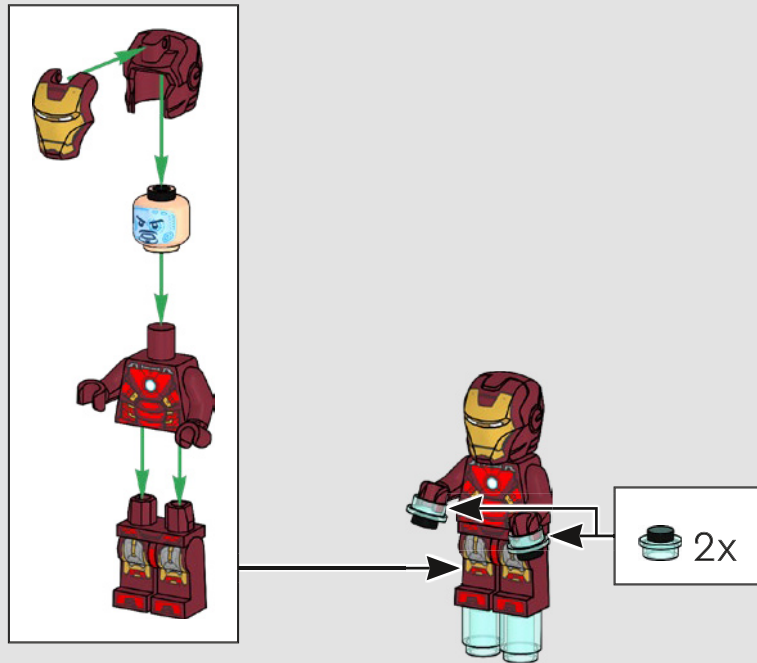

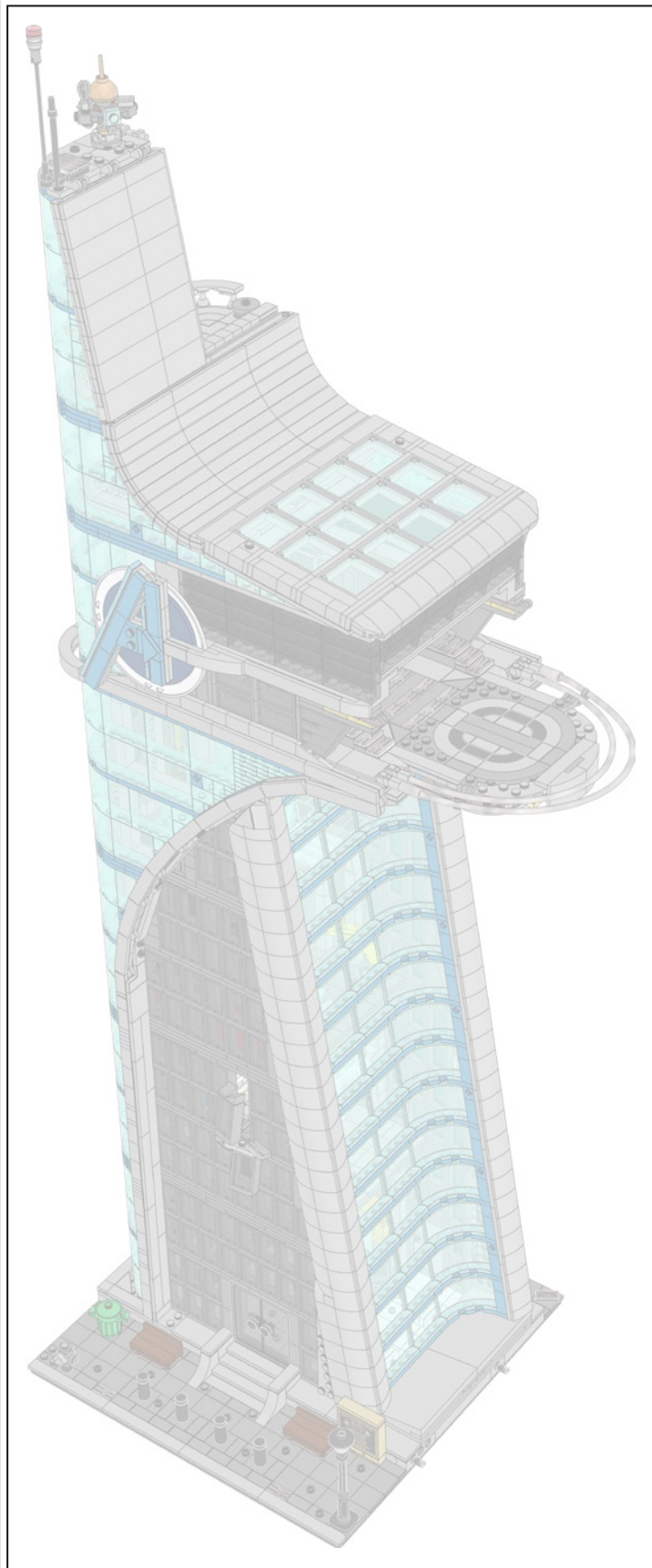

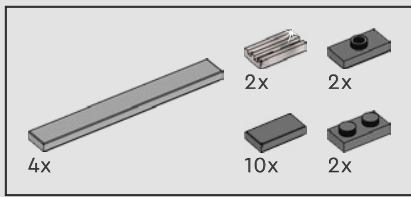

1

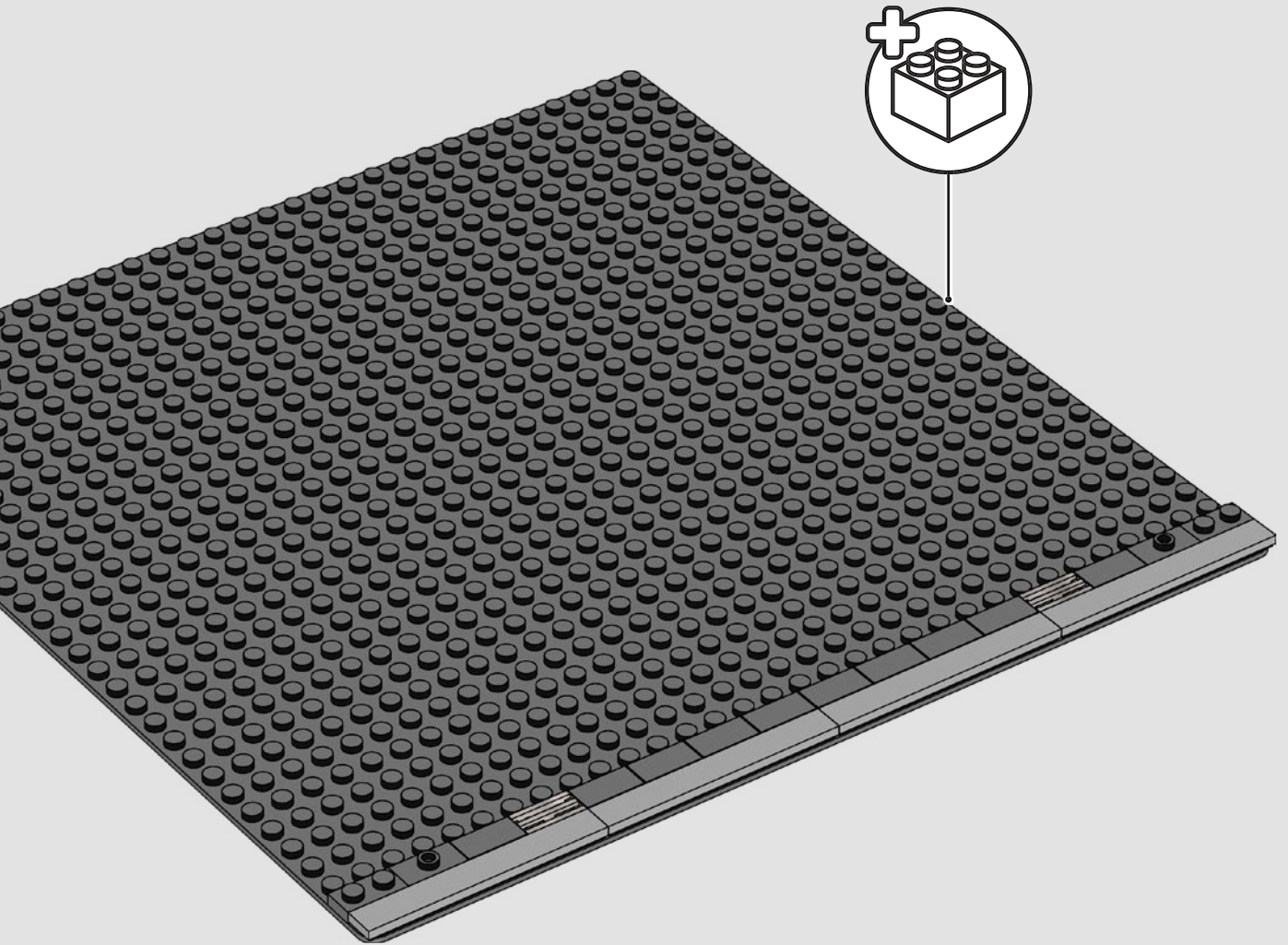

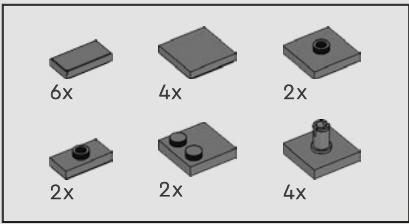

2

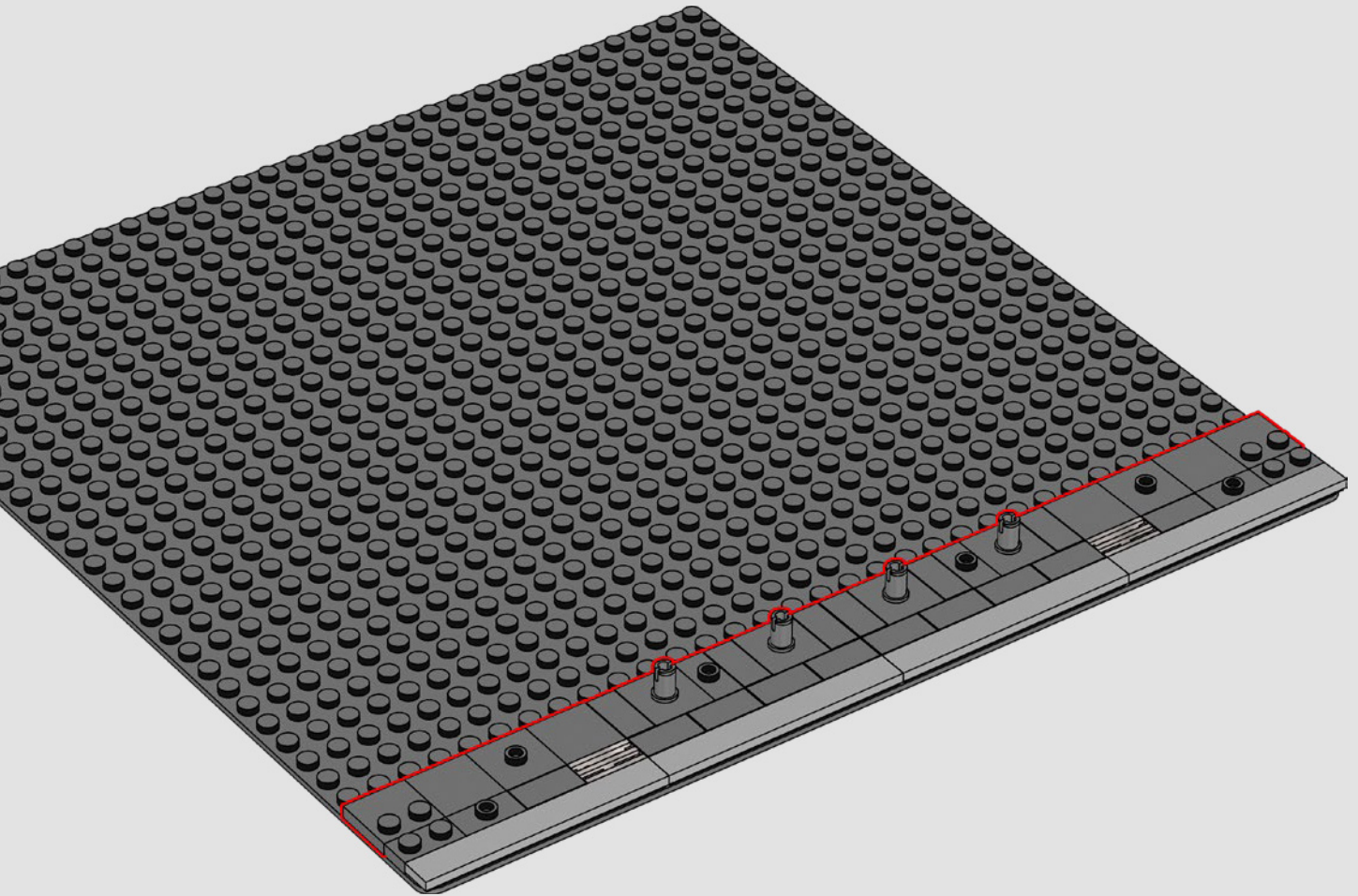

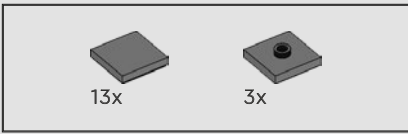

3

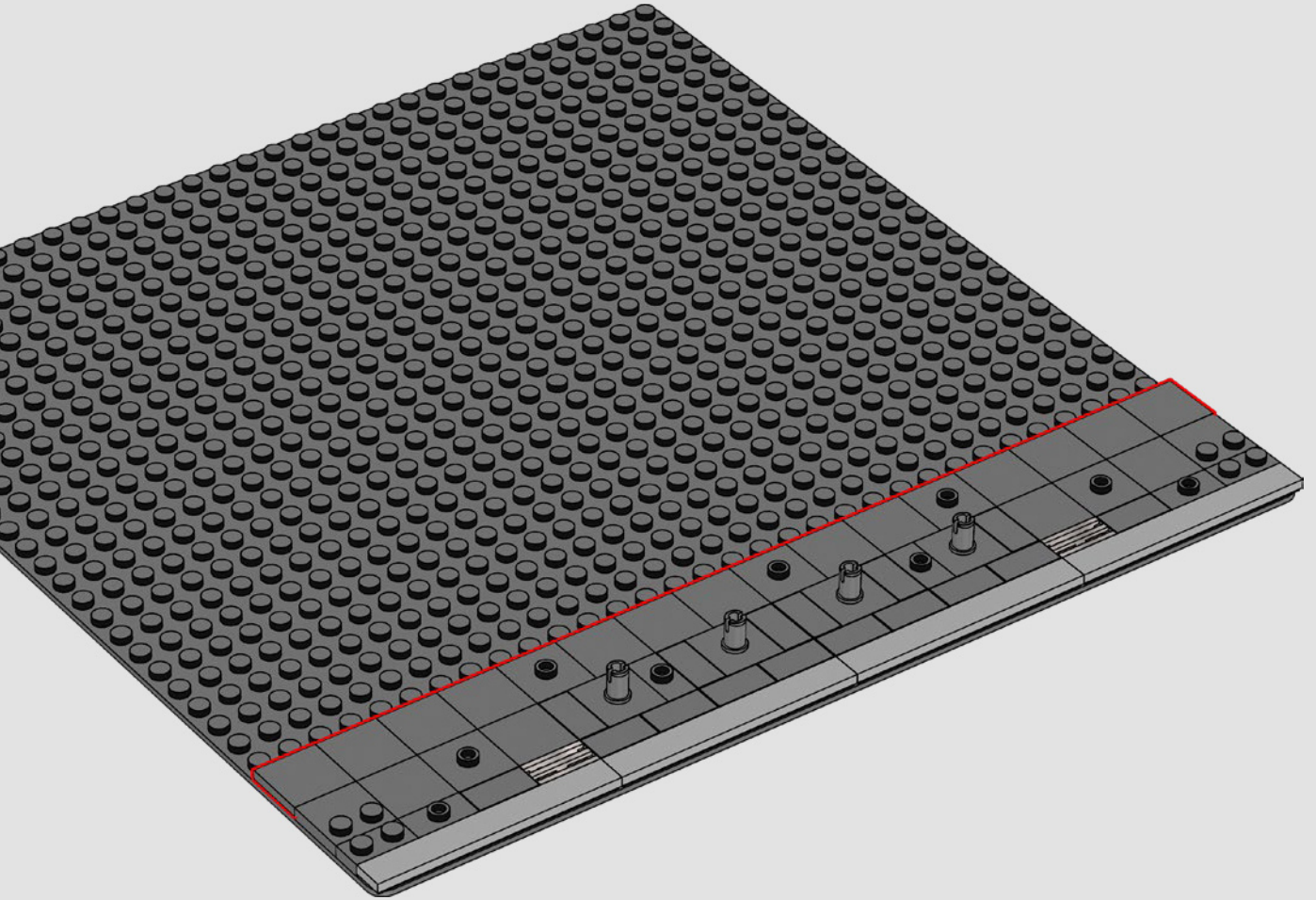

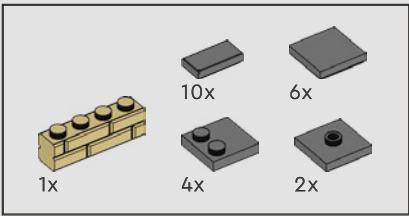

4

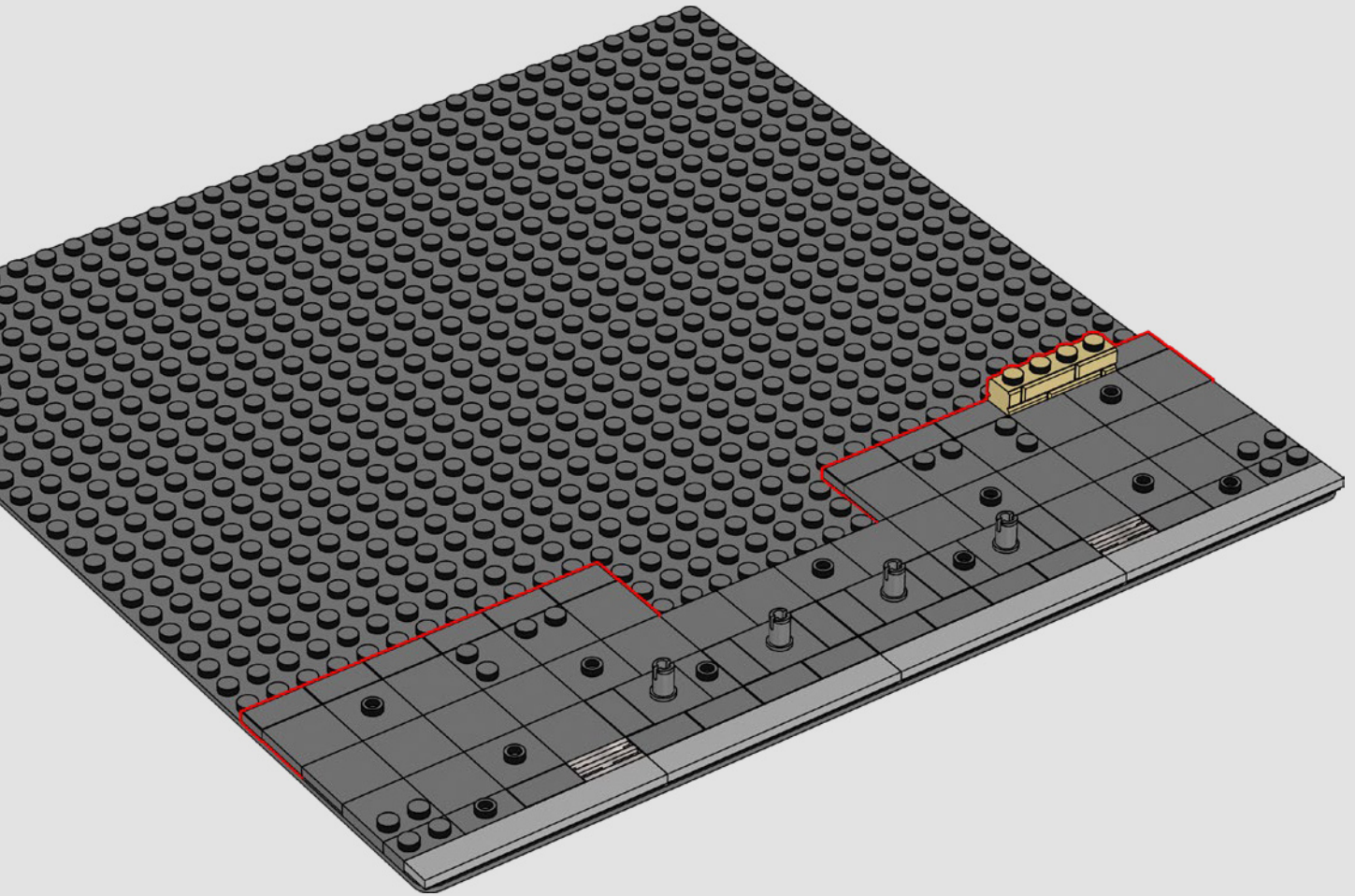

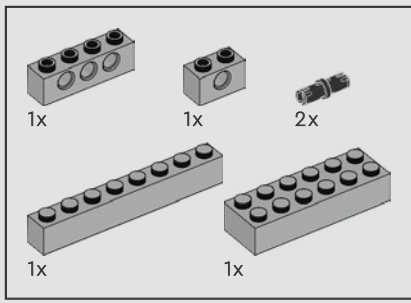

5

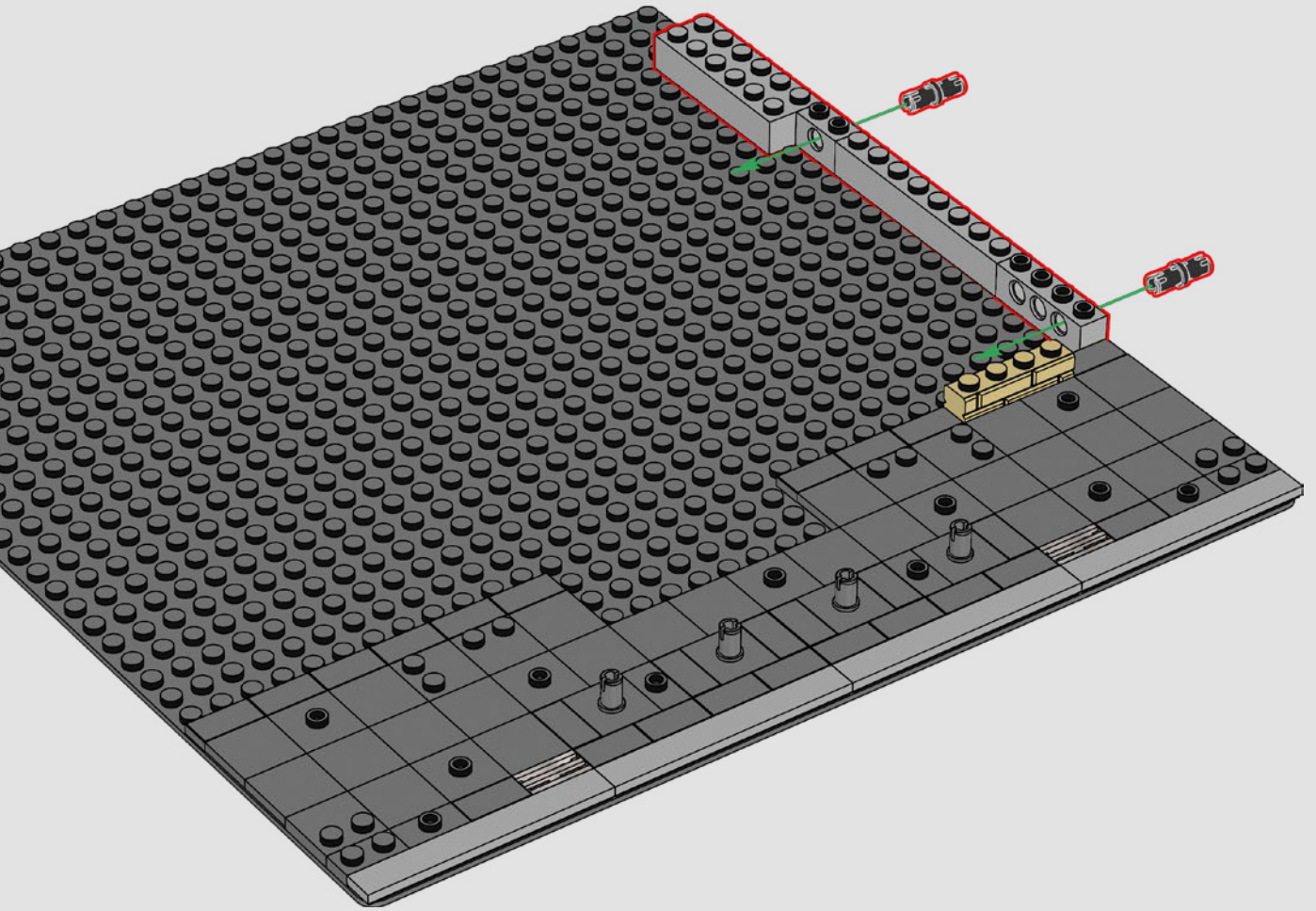

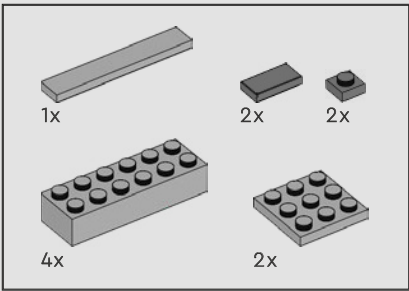

6

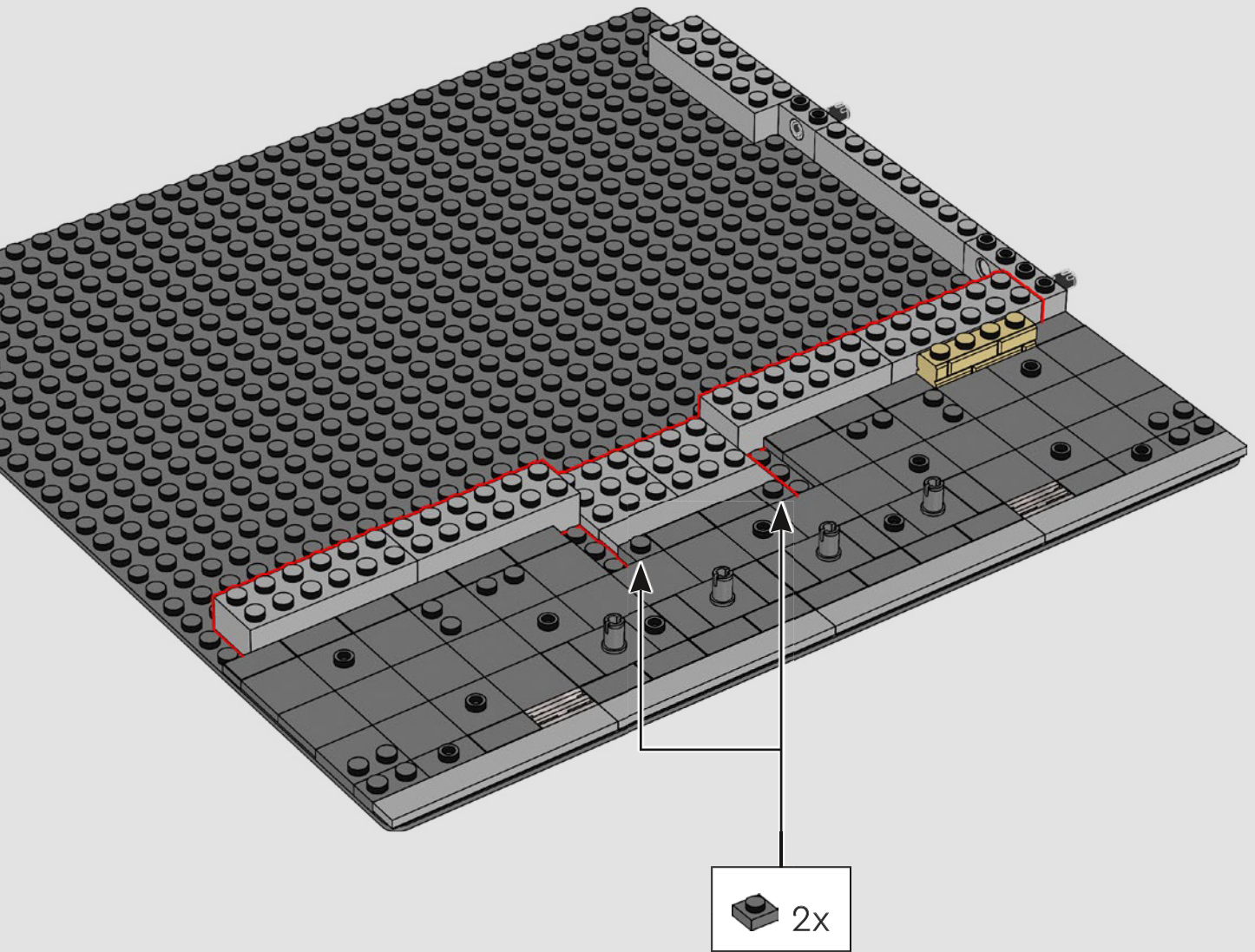

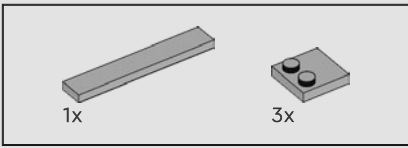

7

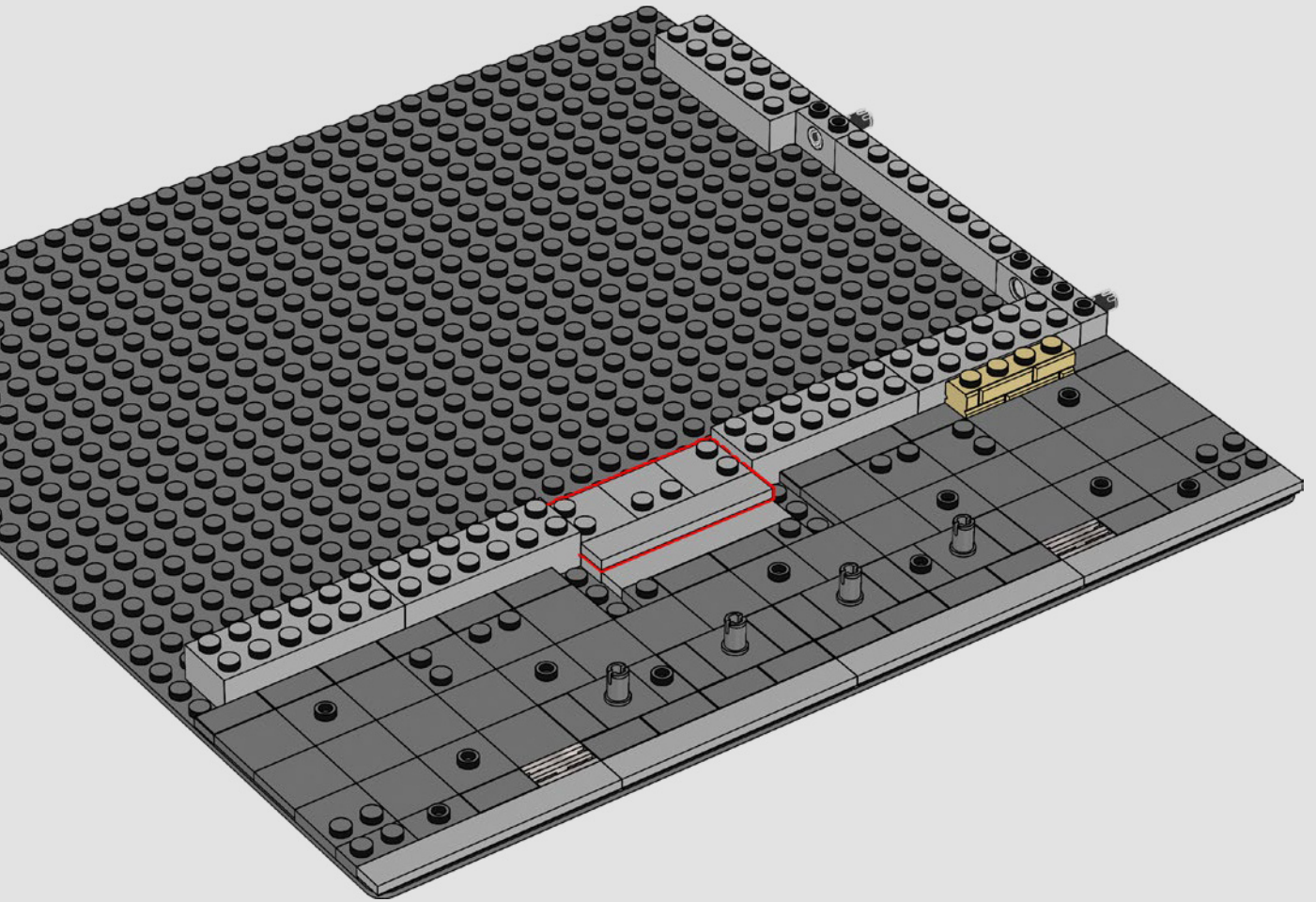

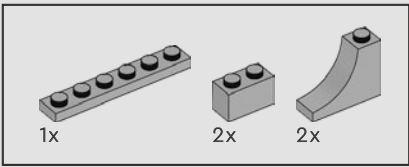

8

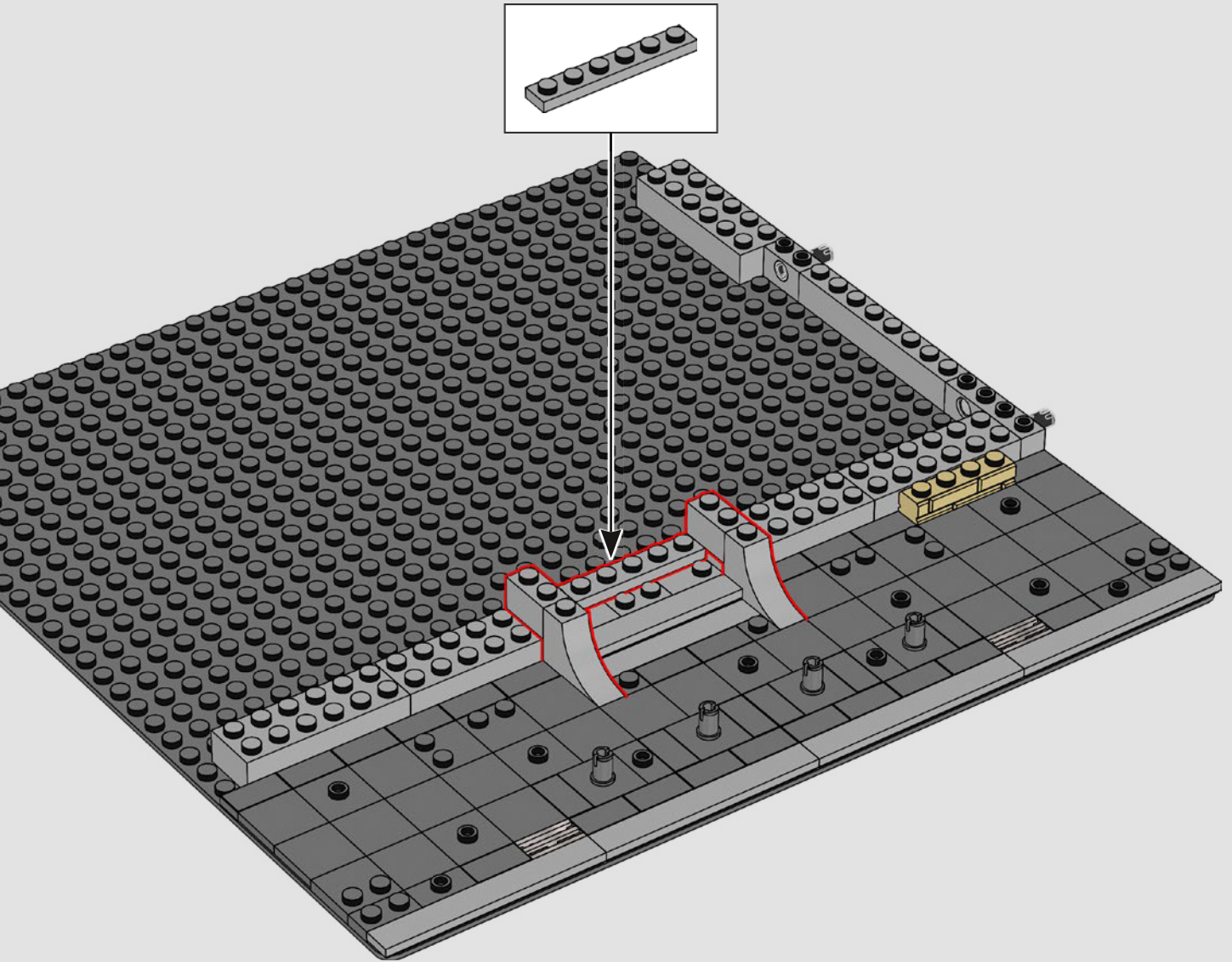

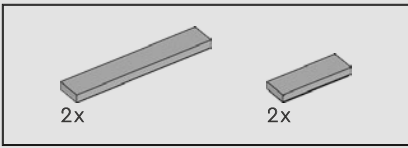

9

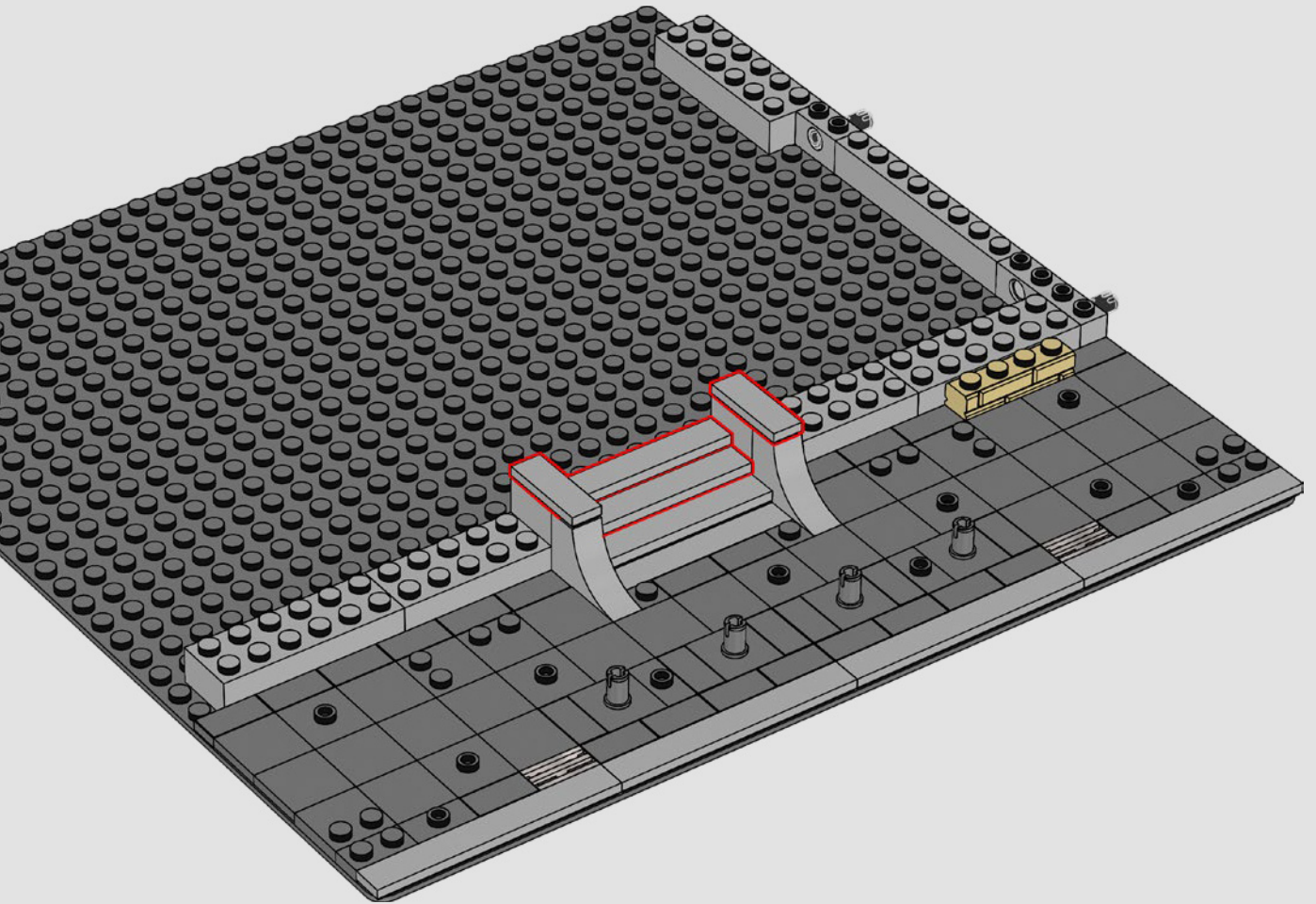

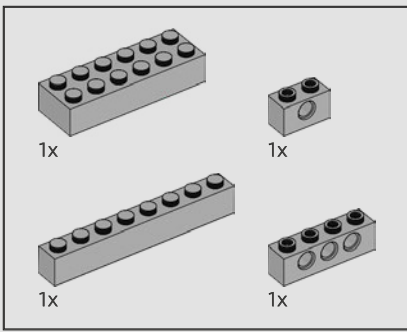

10

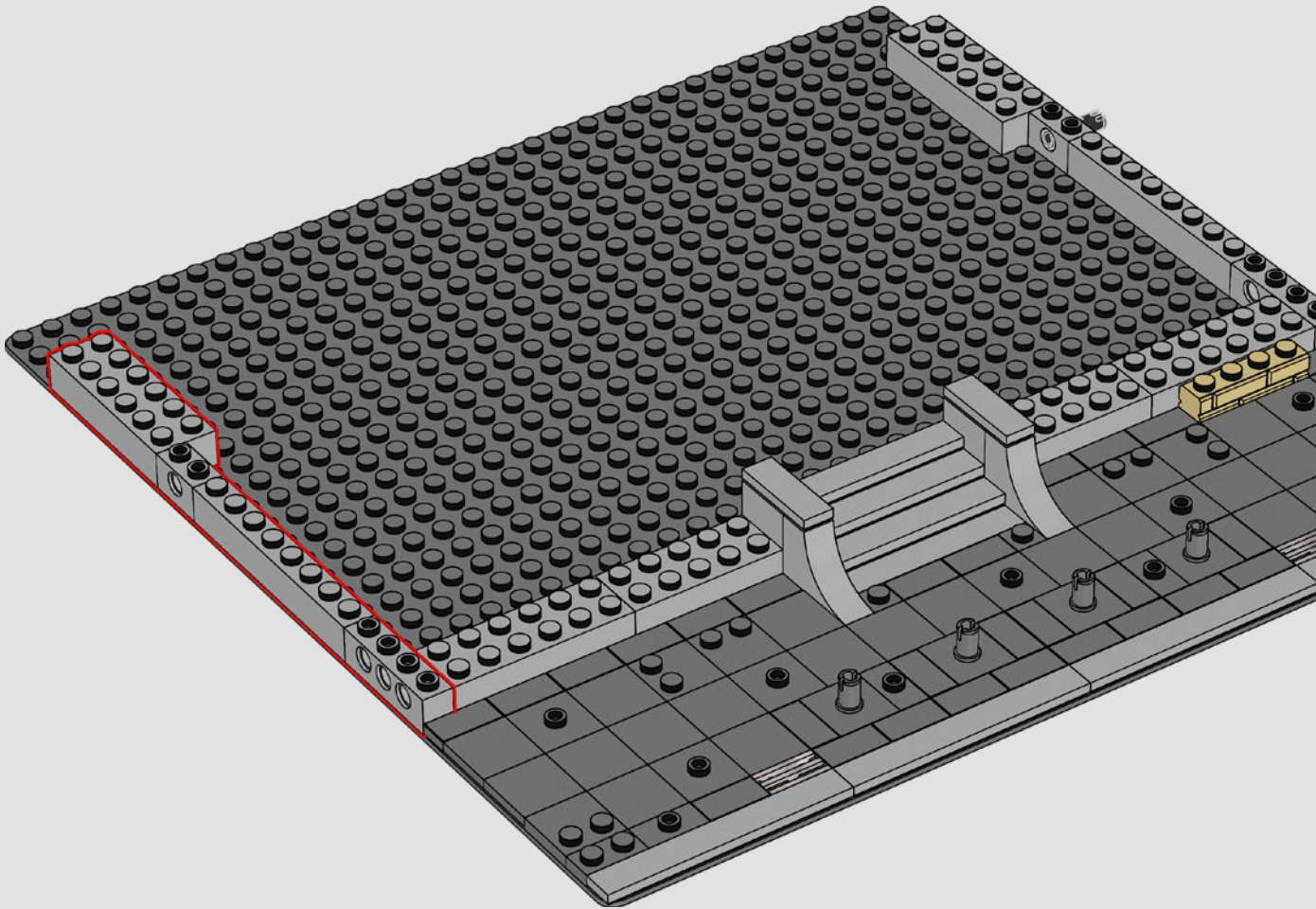

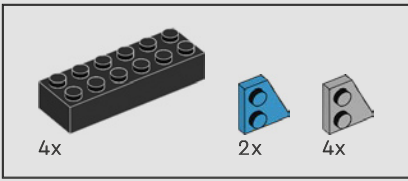

11

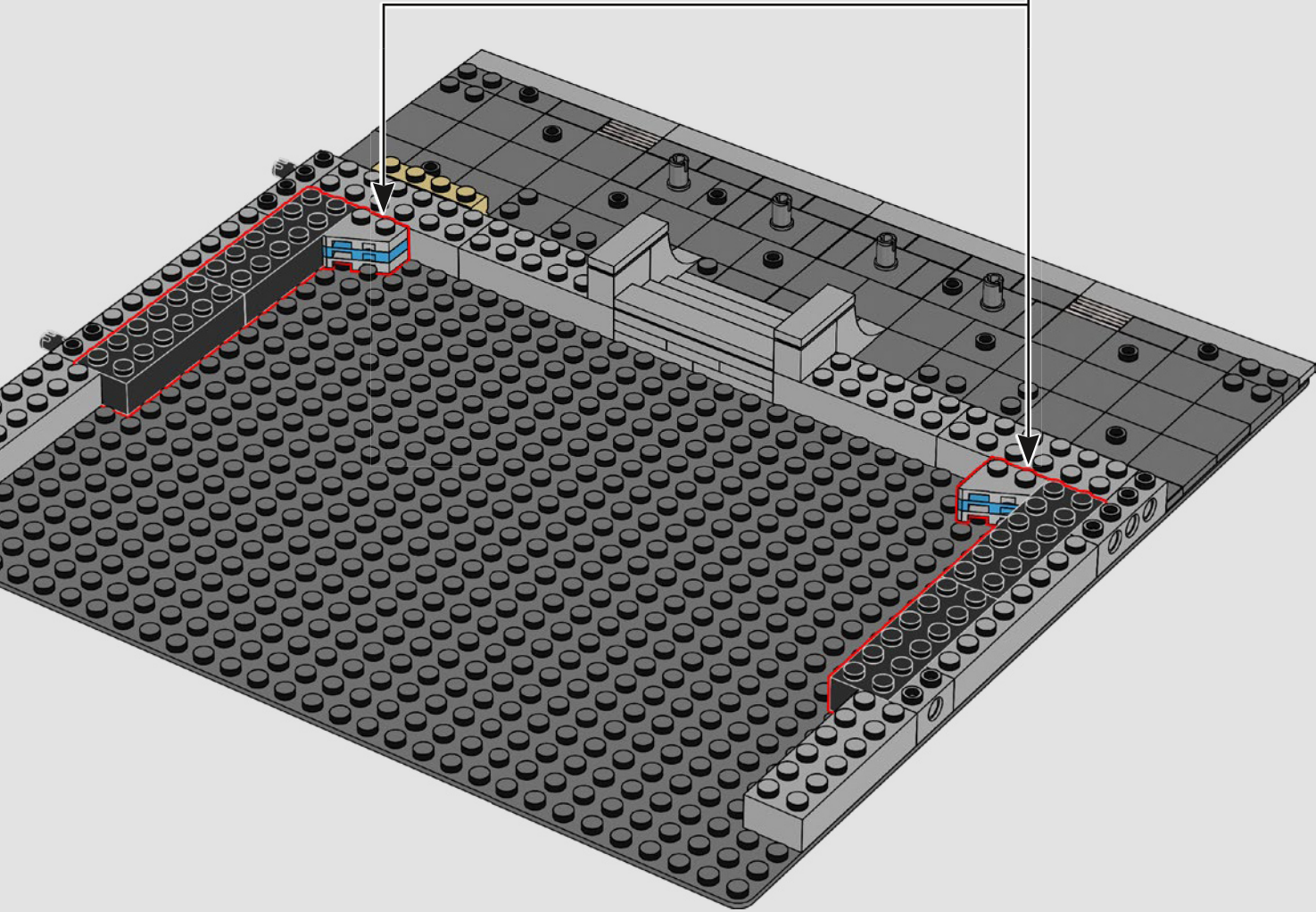
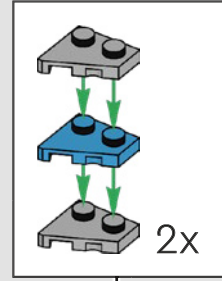

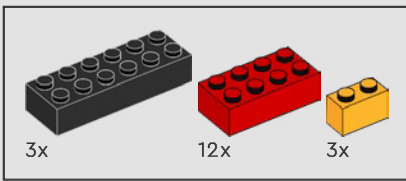

12

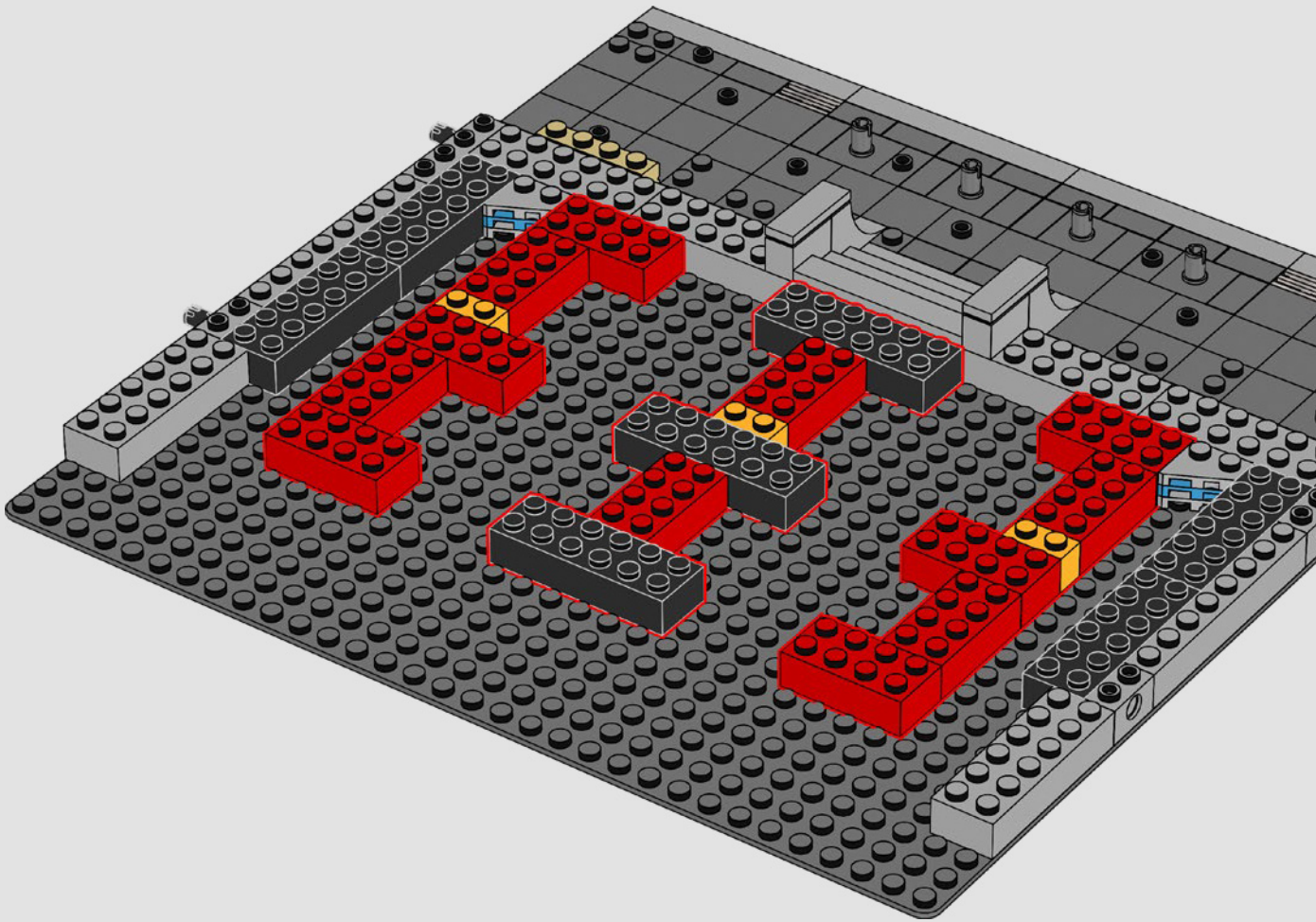

As we added supporting spacing bricks under the floor, we heard Tony Stark in *Iron Man* on repeat in our heads: "Tell you what, throw a little hot rod in there." So, we did.

Alors que nous ajoutons des briques d'espacement sous le plancher, nous entendions Tony Stark dans *Iron Man* répéter en boucle : « Ajoute un peu de rouge carrosserie. » Et c'est ce qu'on a fait.

Mientras agregábamos bricks separadores de soporte debajo del suelo, casi podíamos oír constantemente lo que decía Tony Stark en *Iron Man: El Hombre de Hierro*: "¿Sabes qué? Ponle un poco de rojo metálico". Así que lo hicimos.

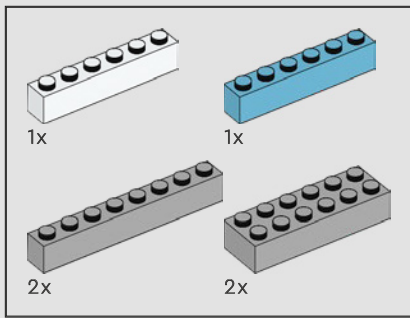

13

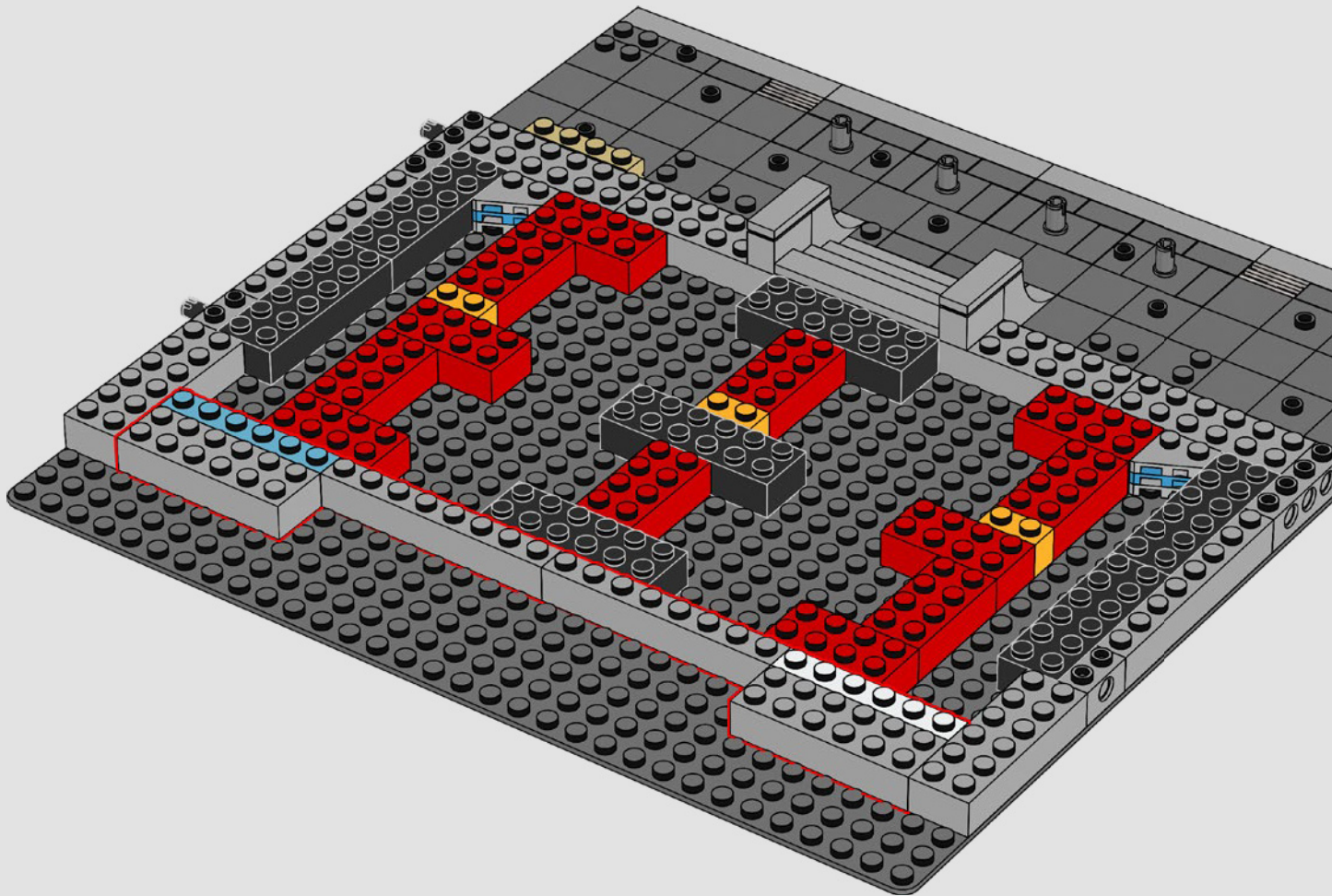

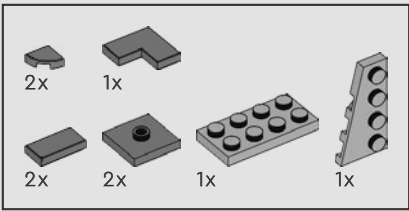

14

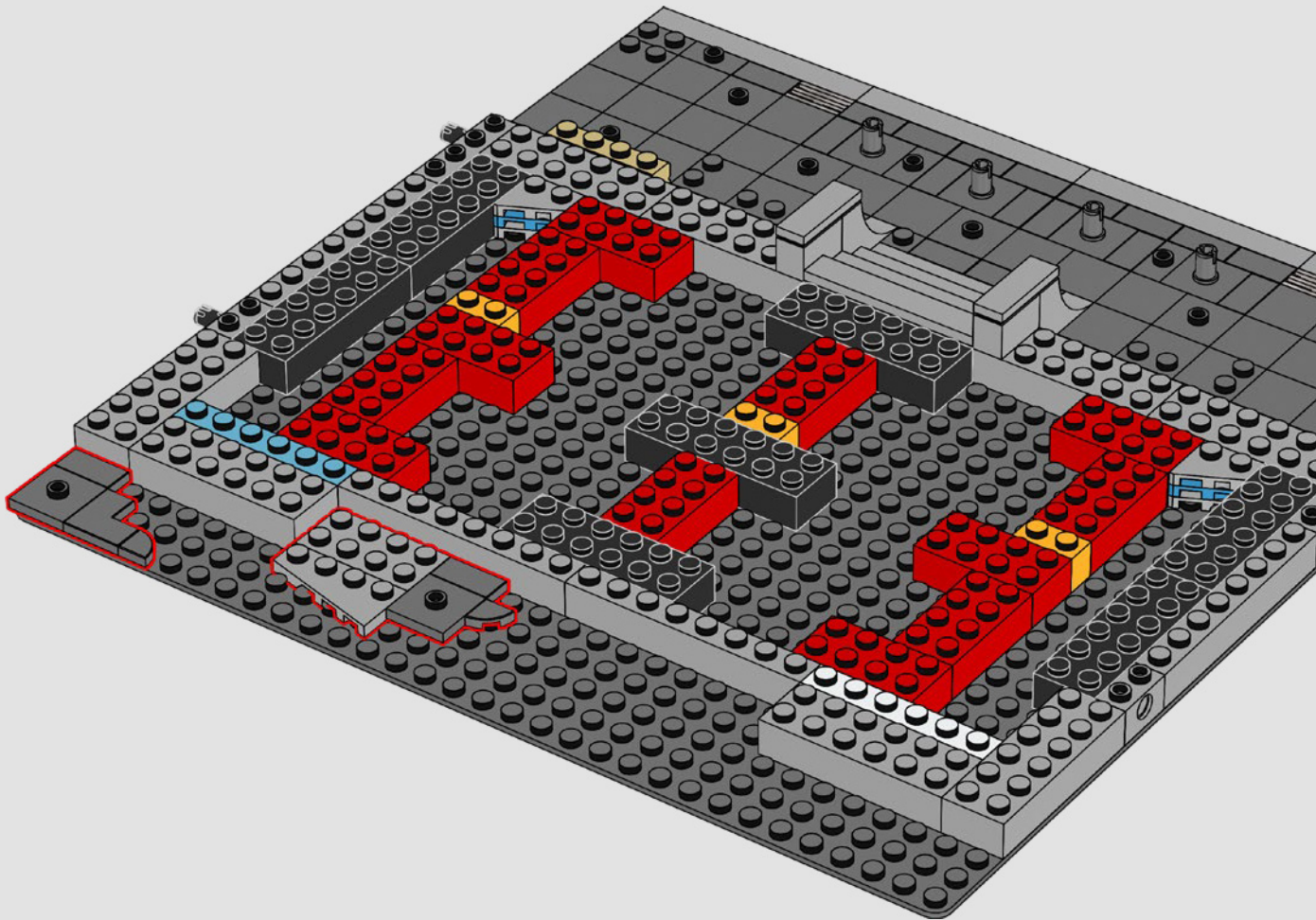

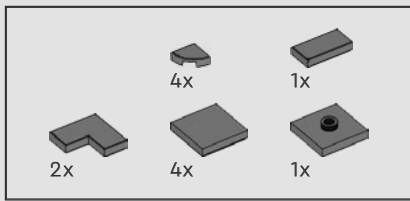

15

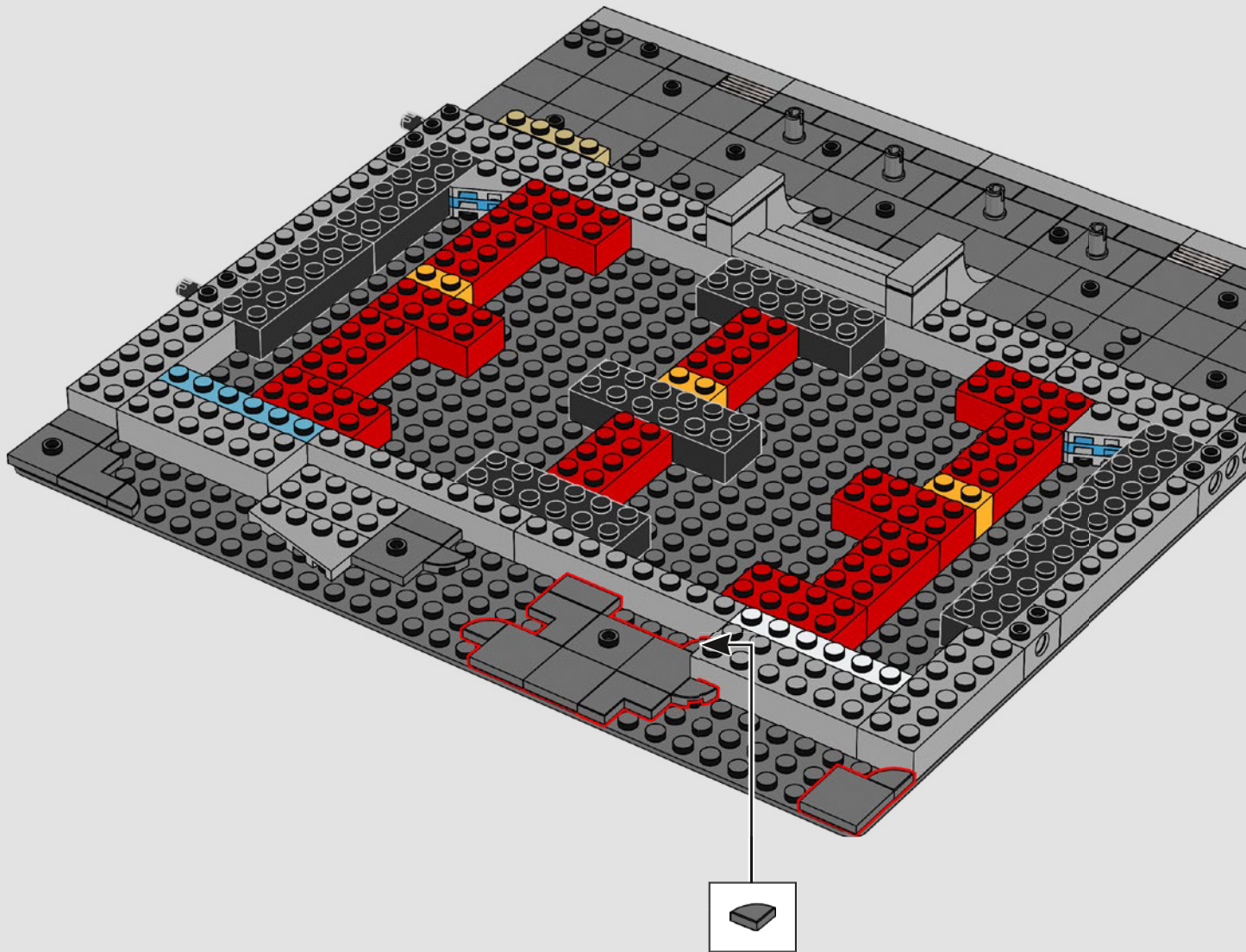

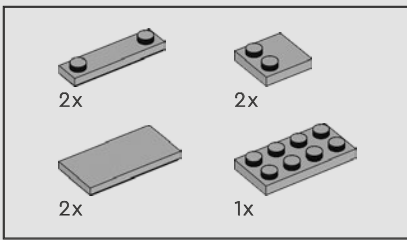

16

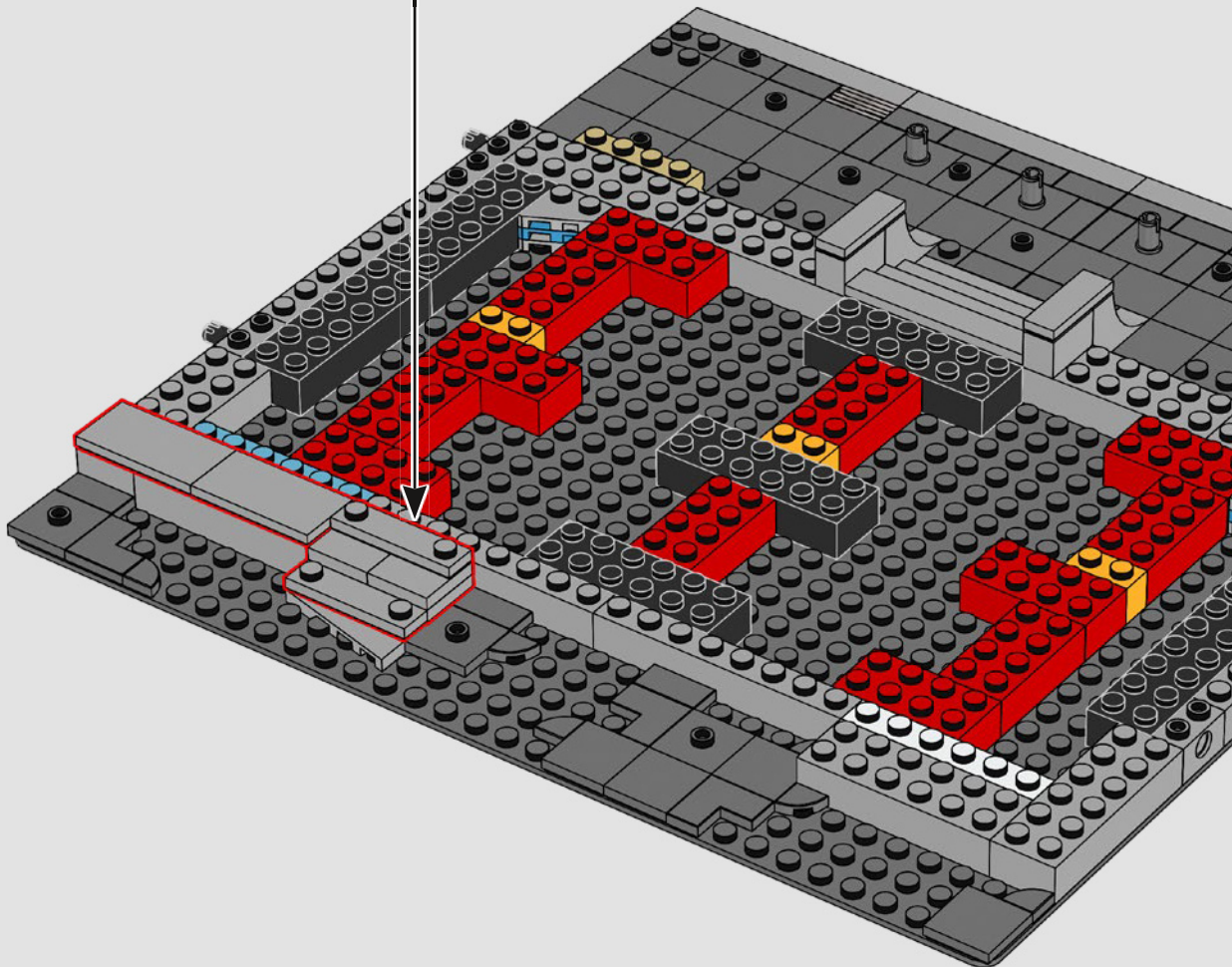
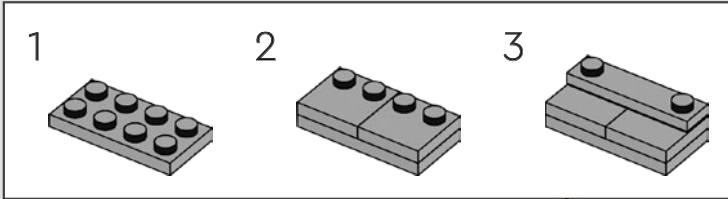

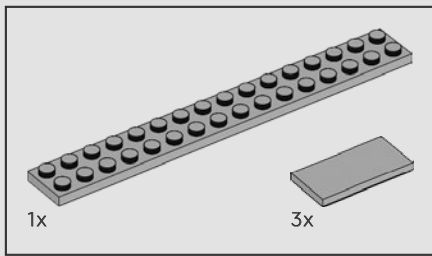

17

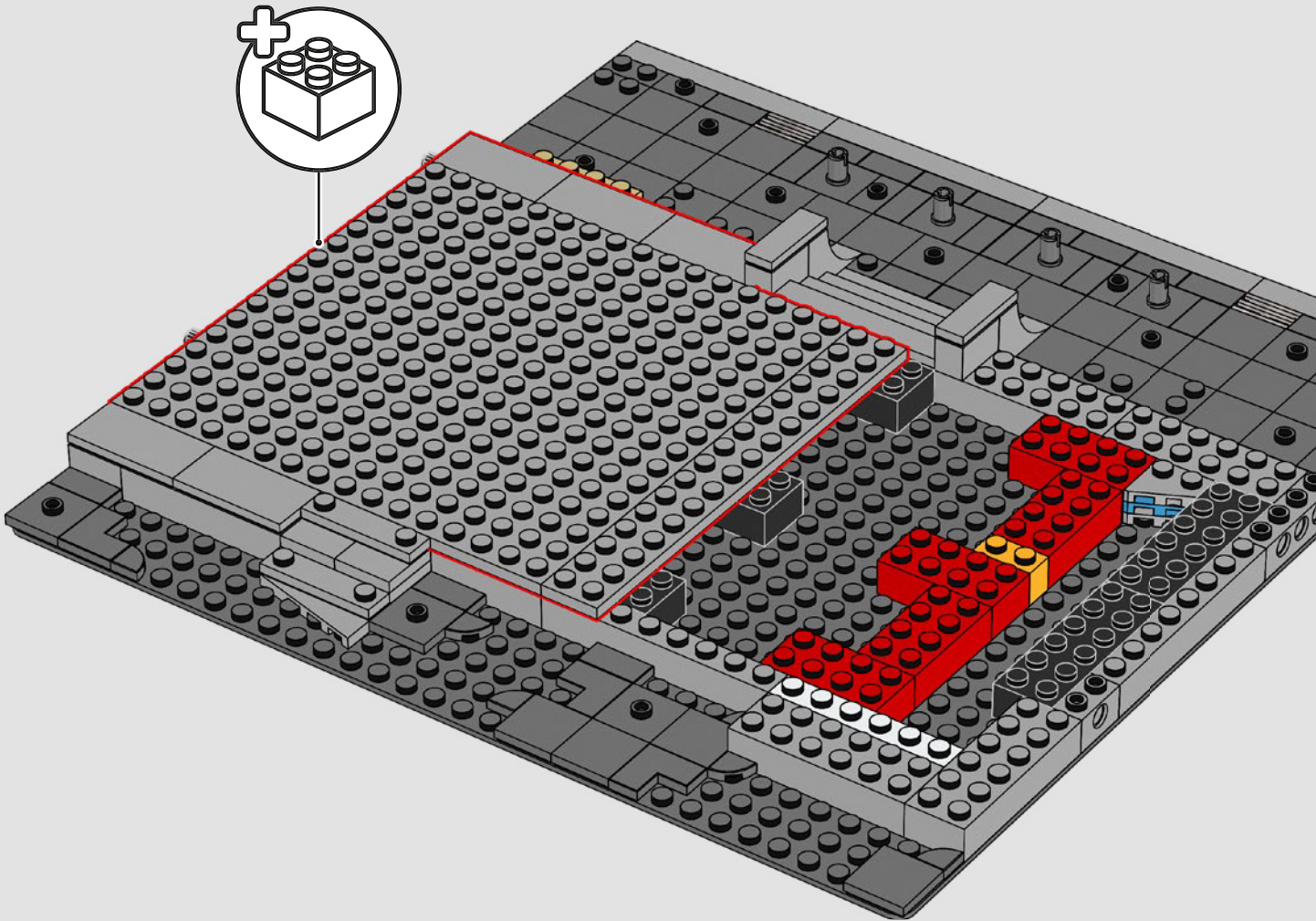

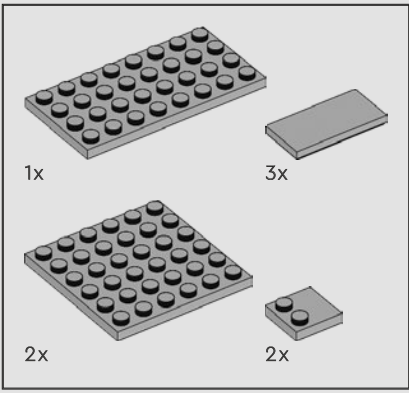

18

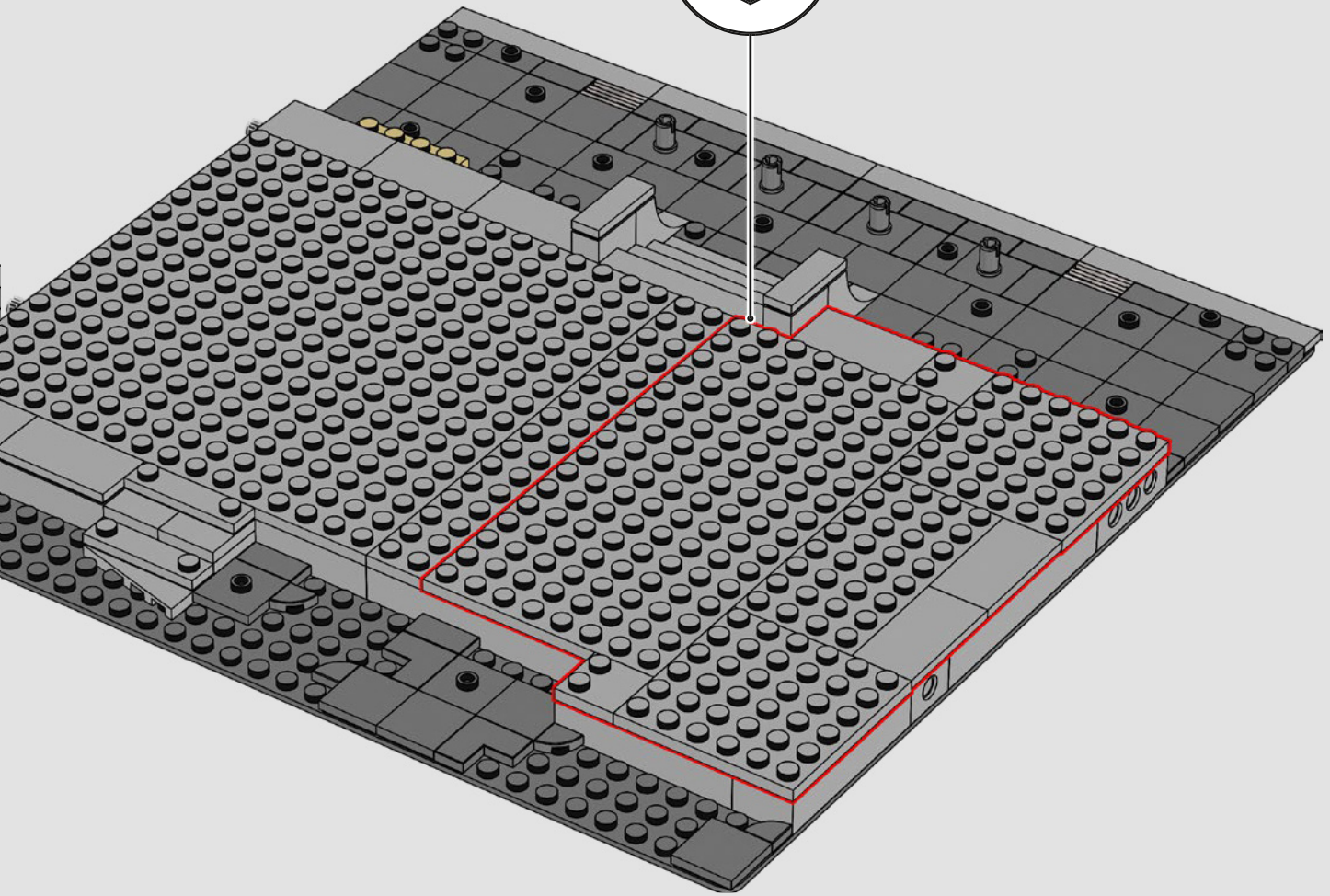
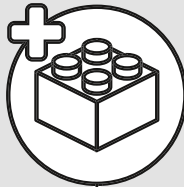

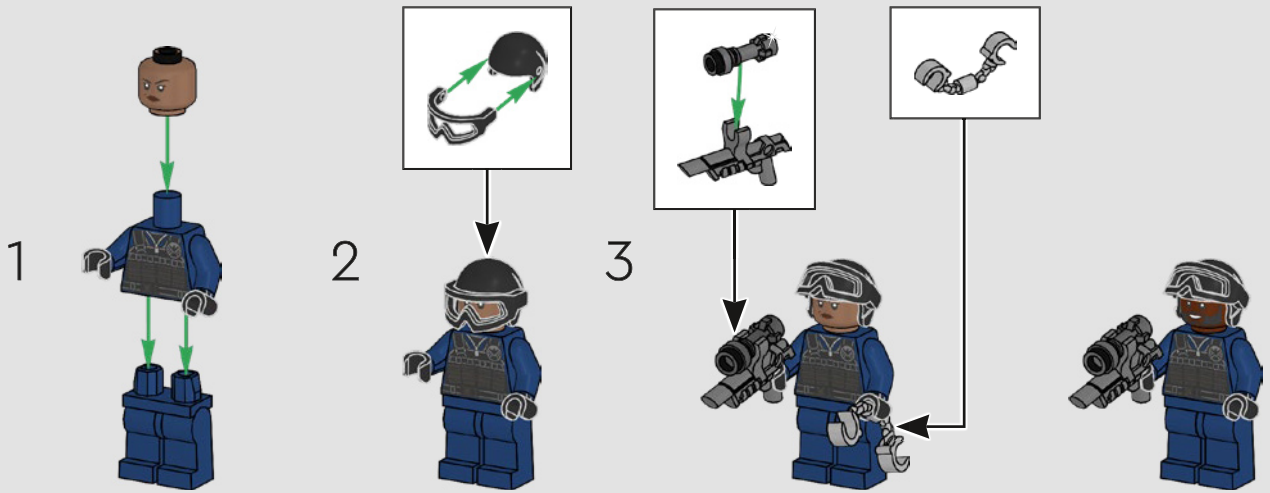

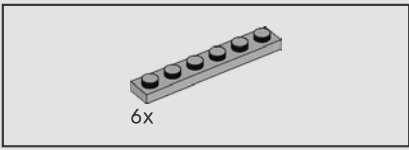

19

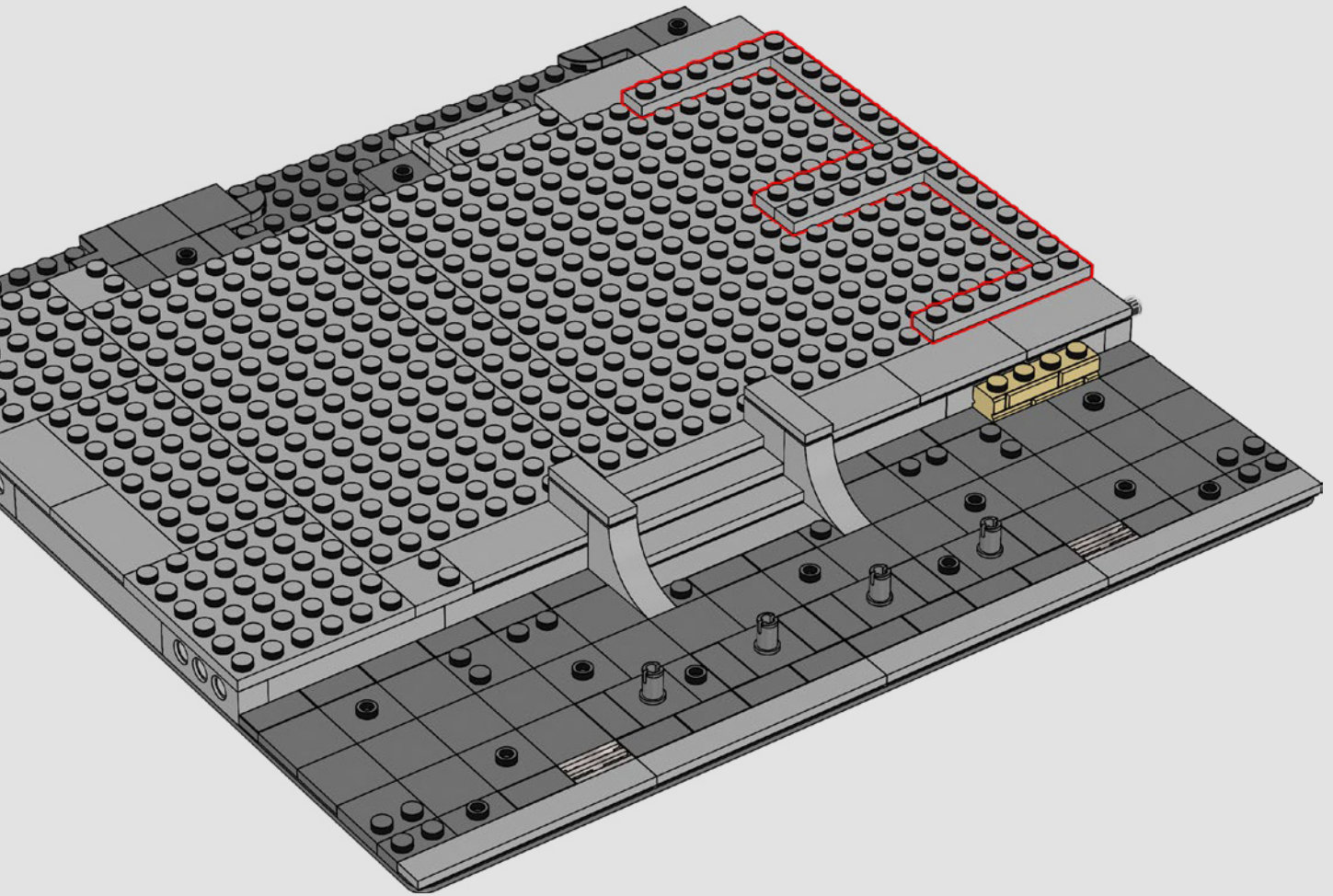

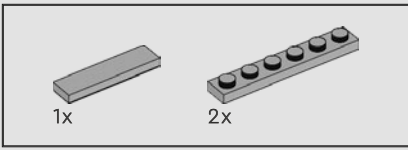

20

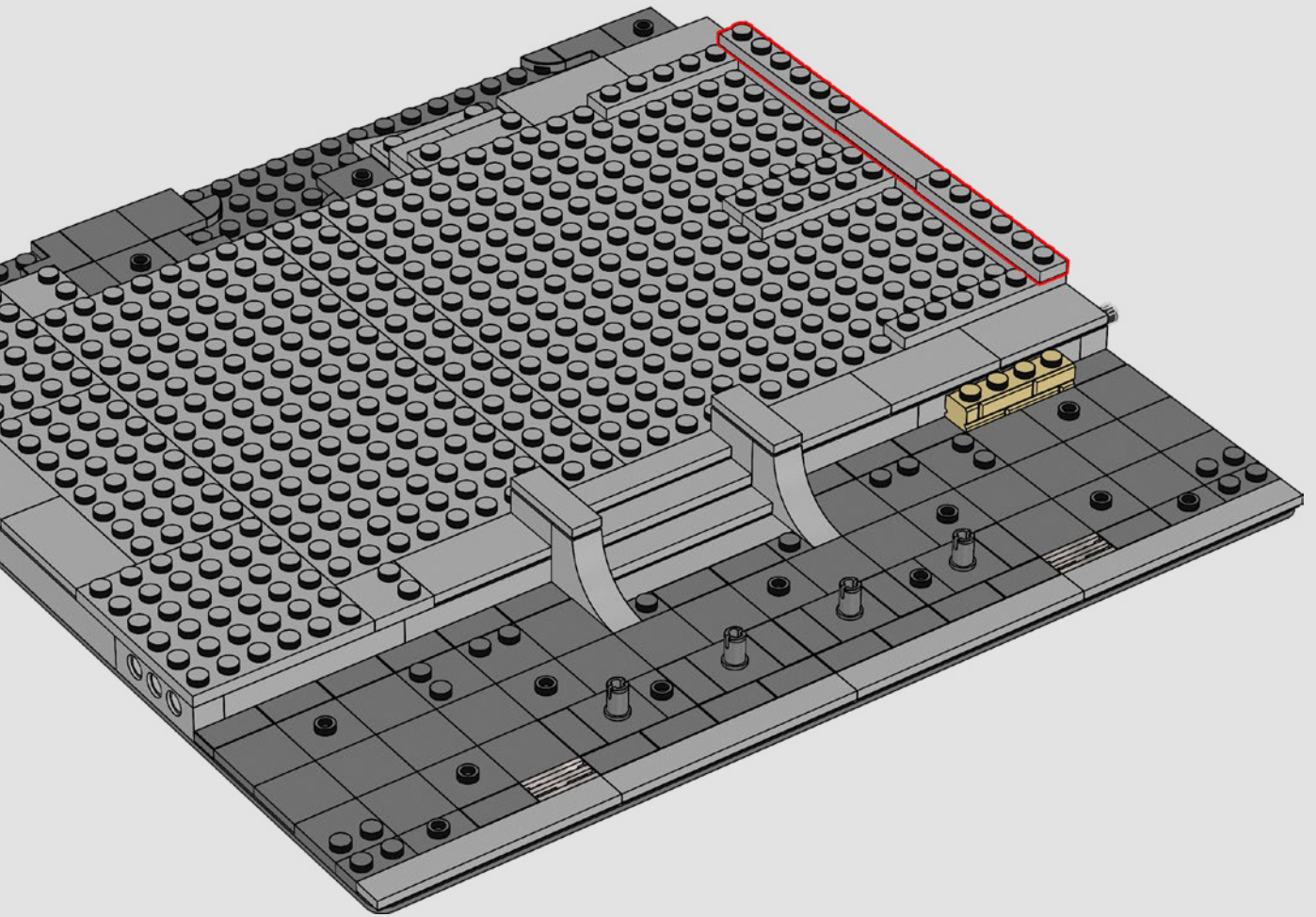

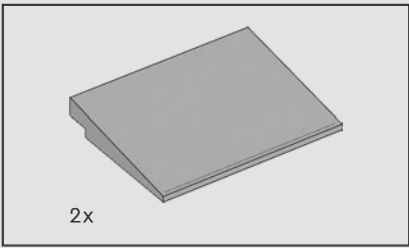

21

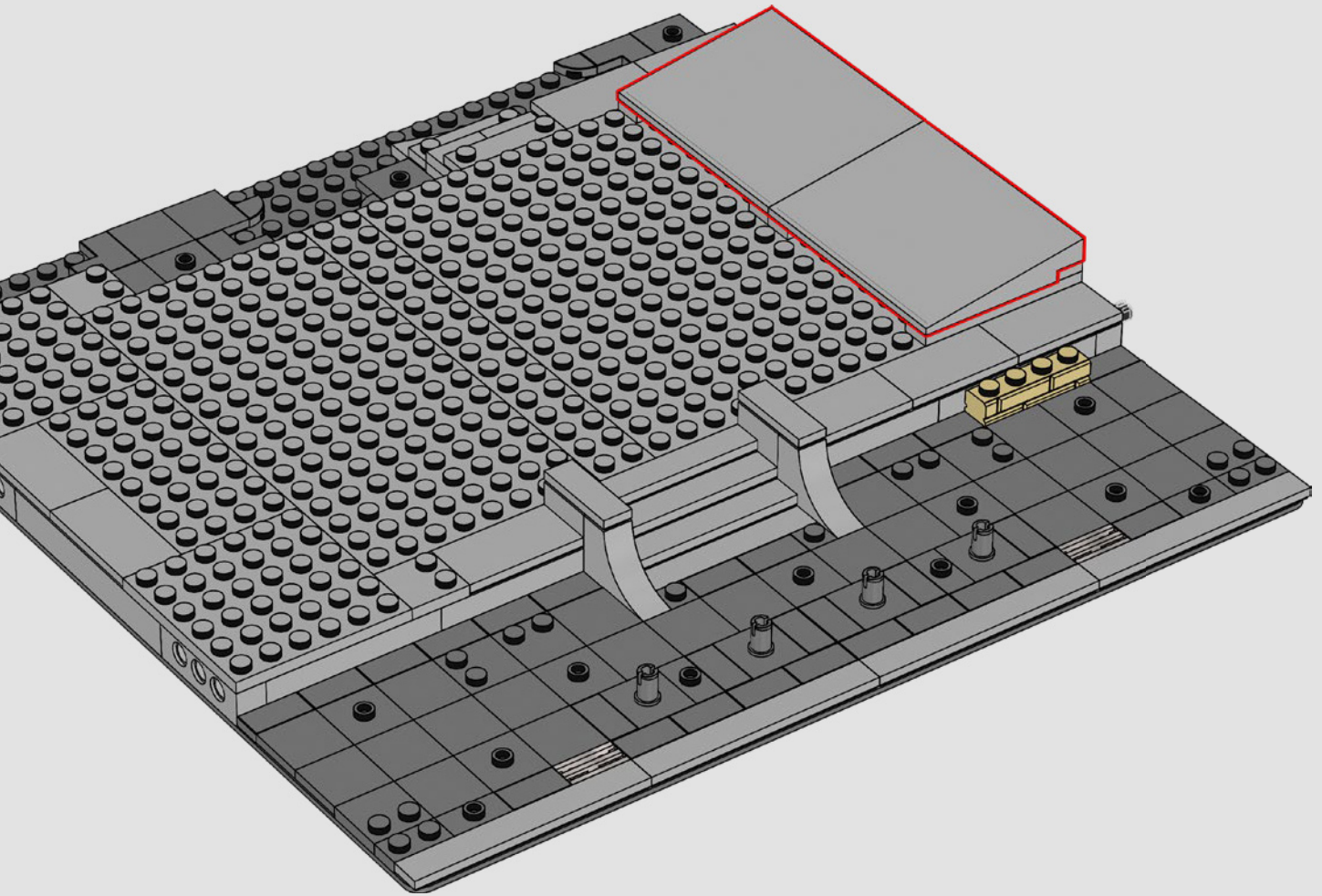

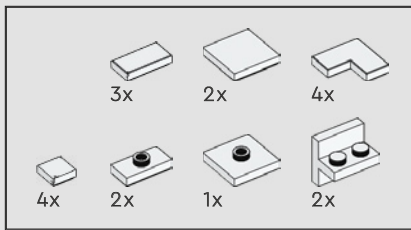

22

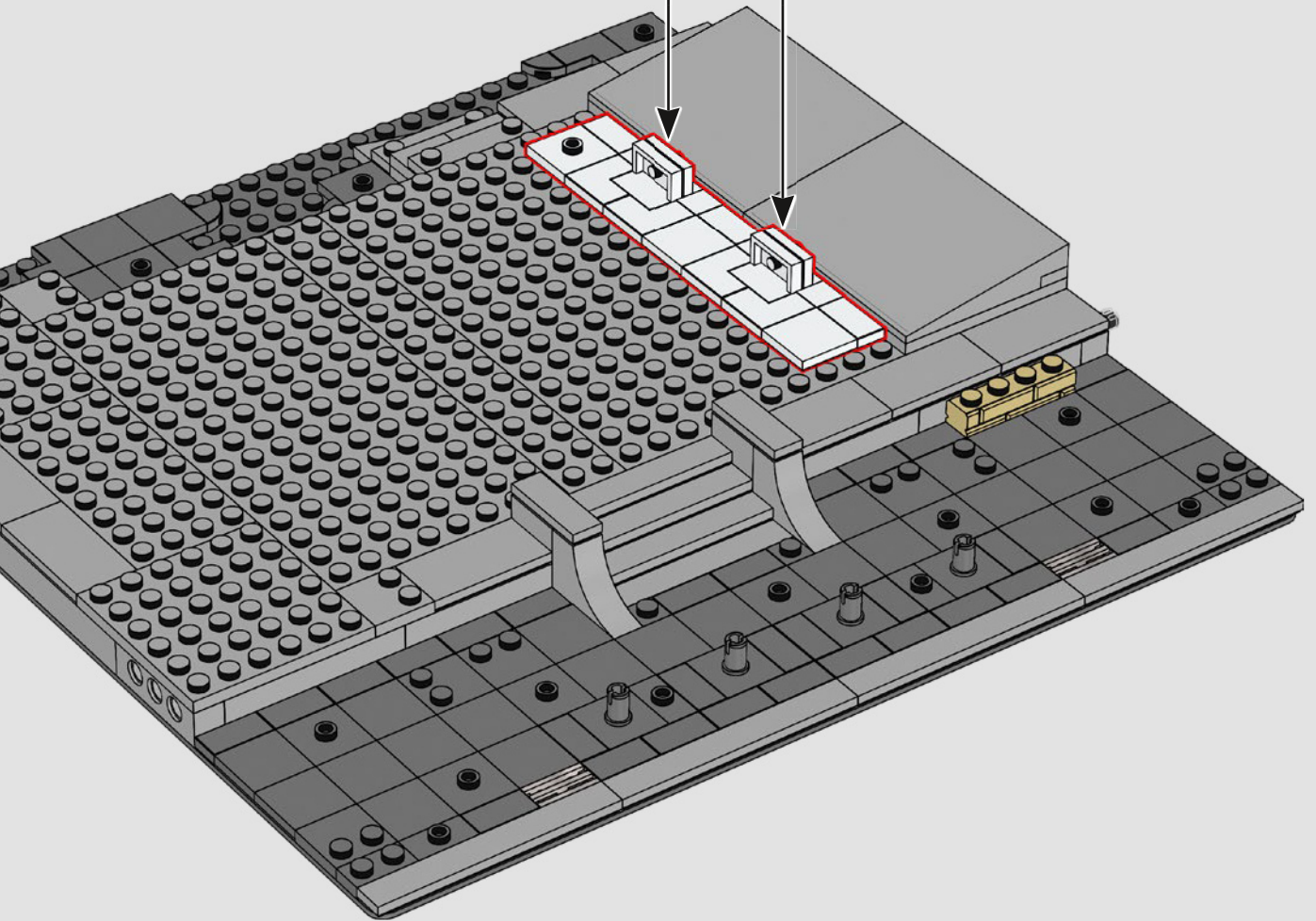
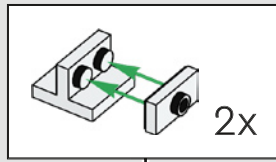

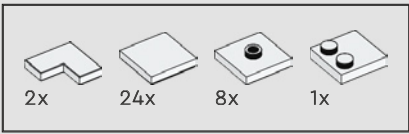

23

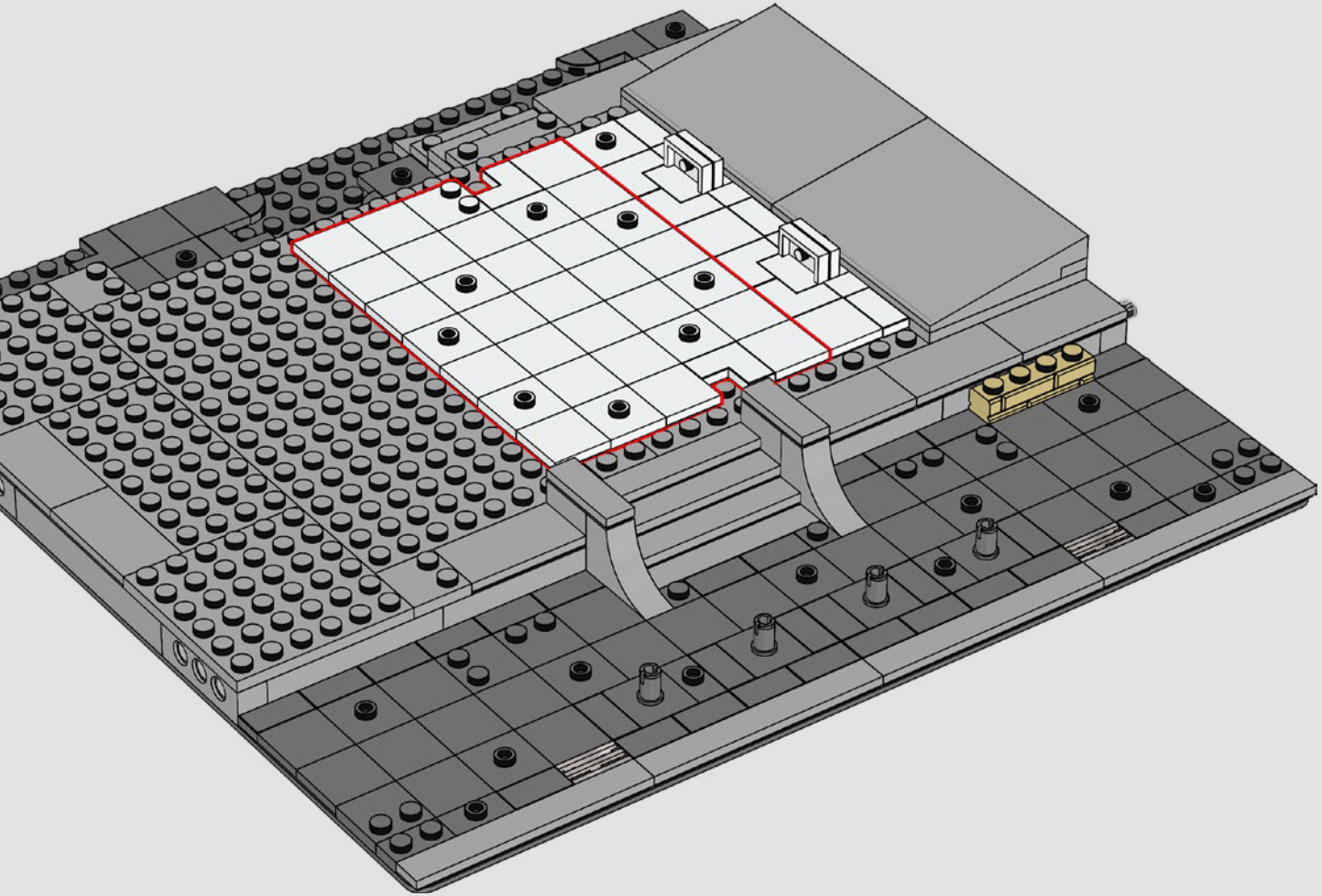

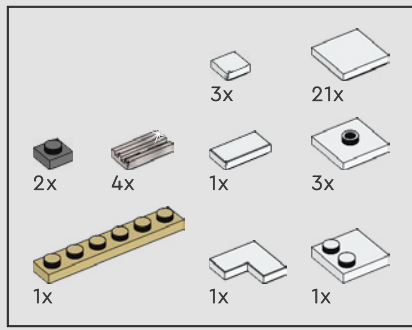

24

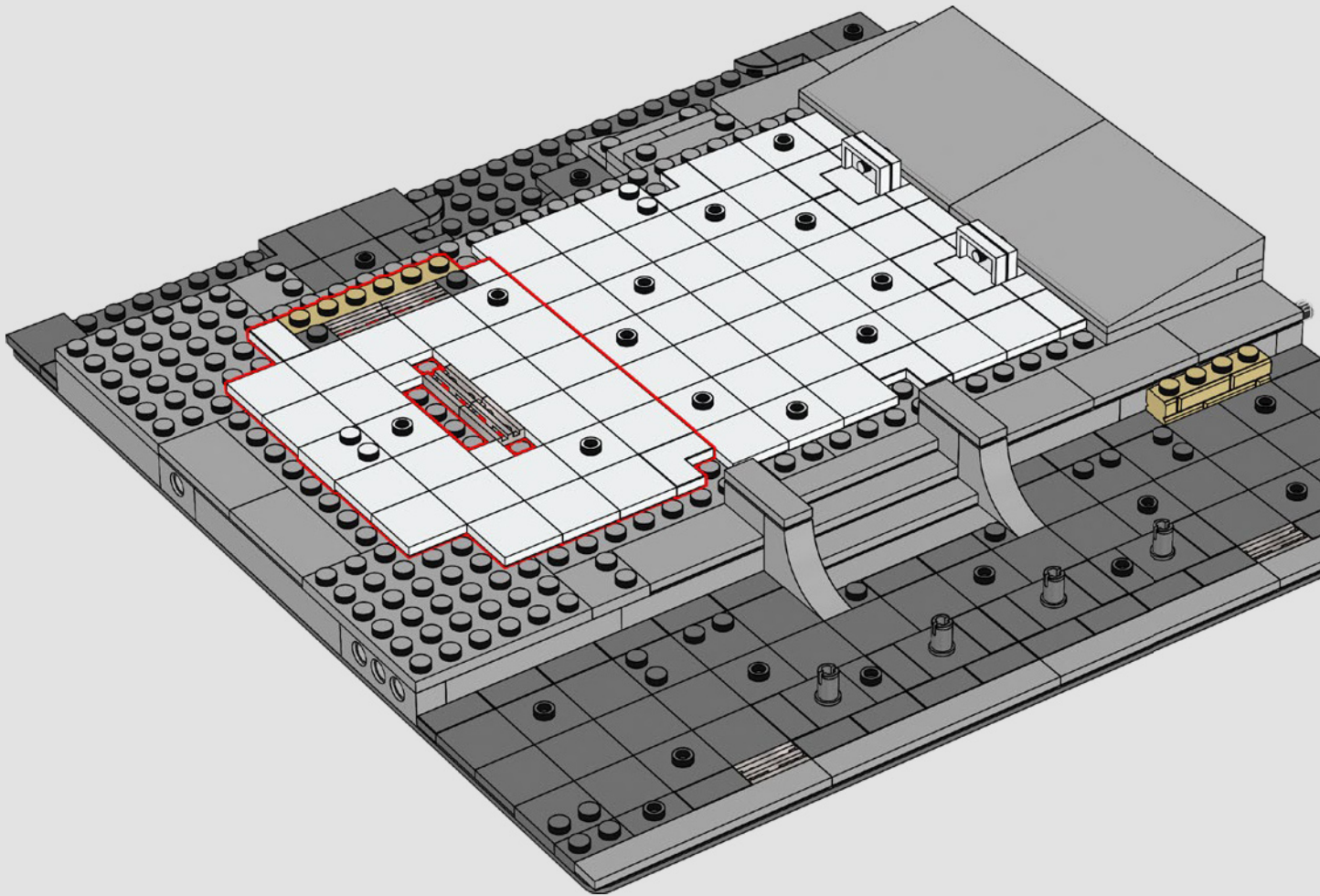

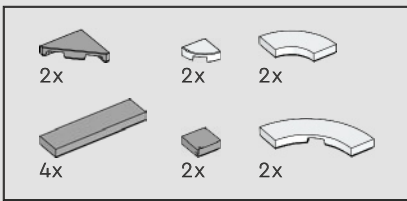

25

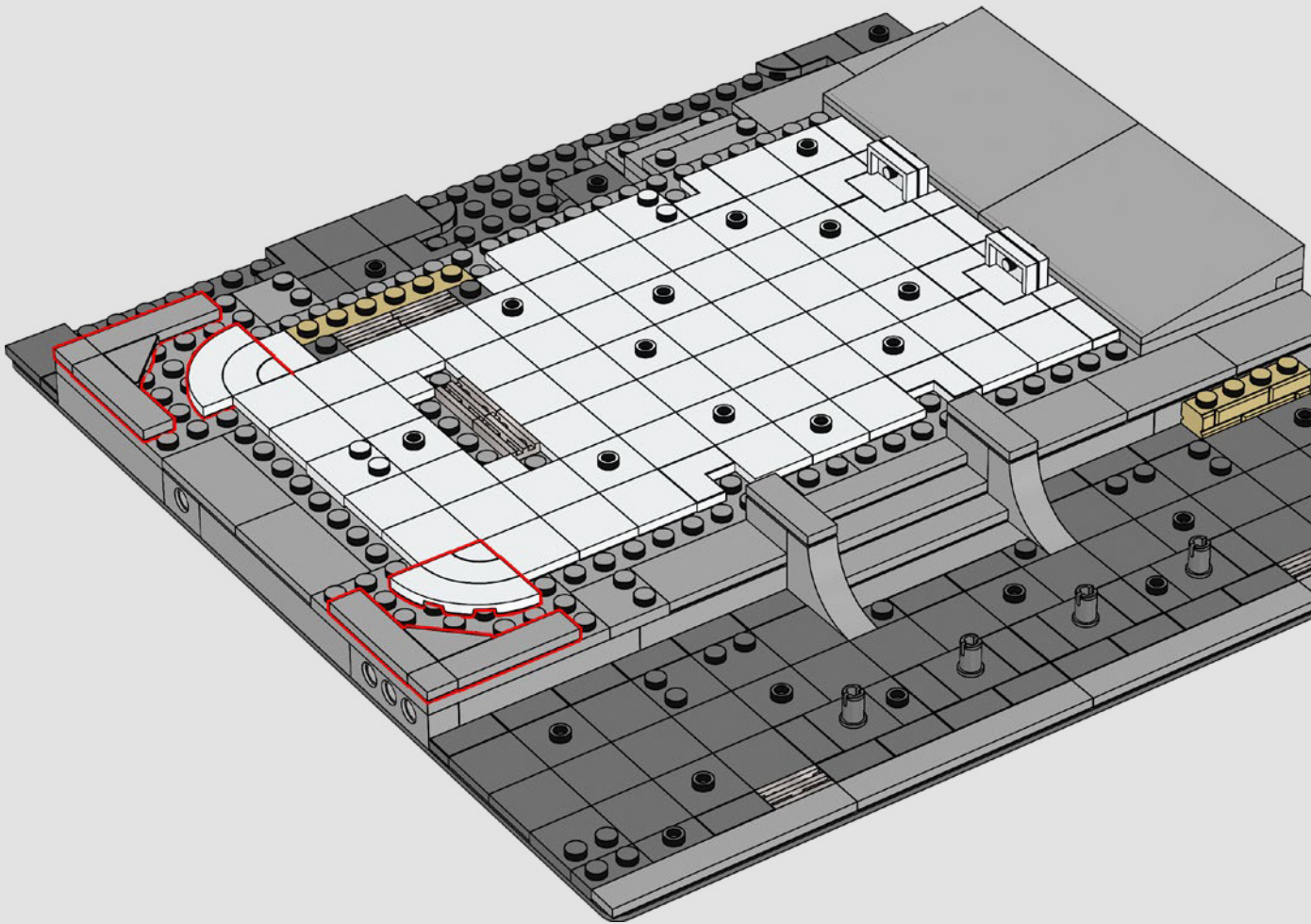



26

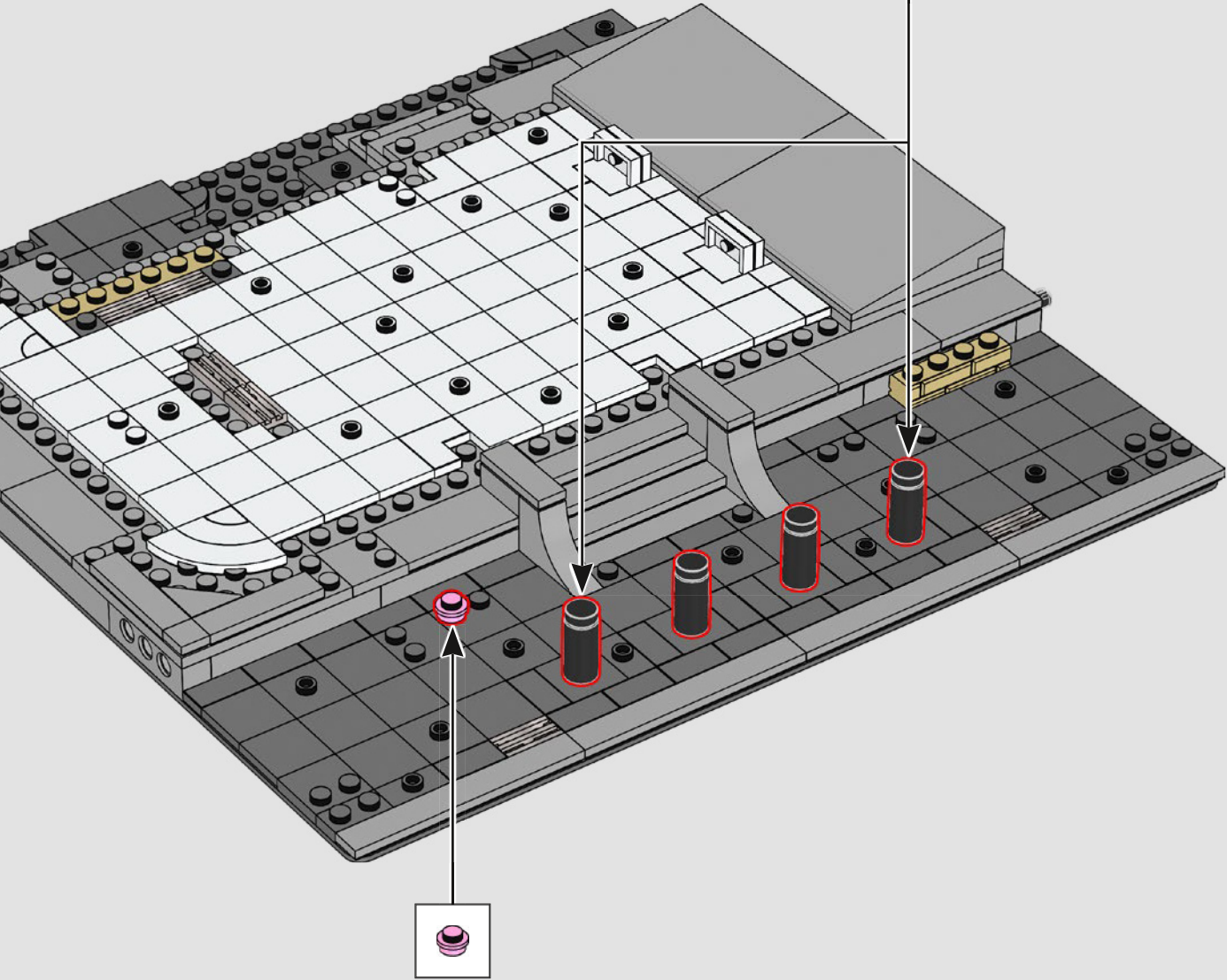
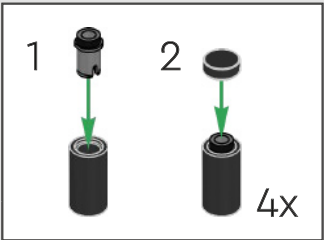

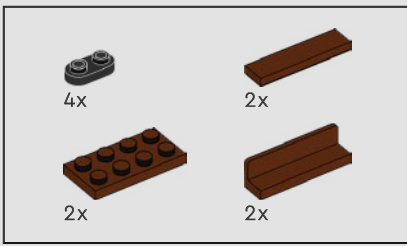

27

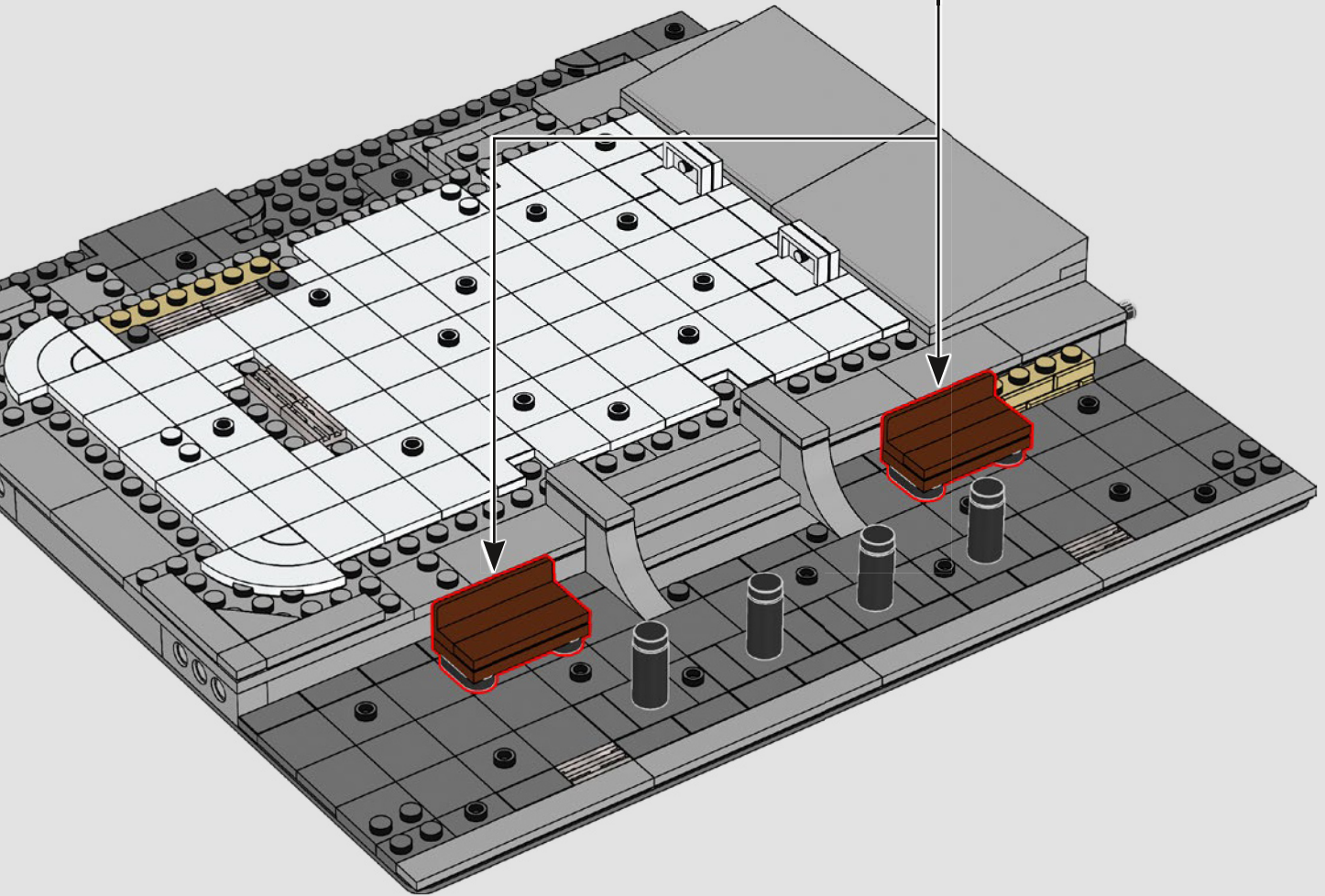
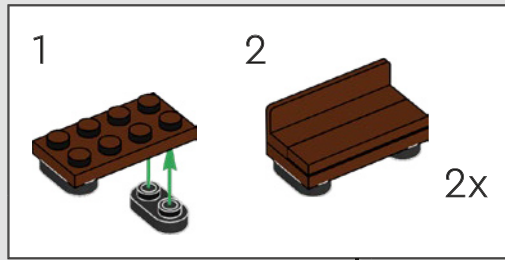

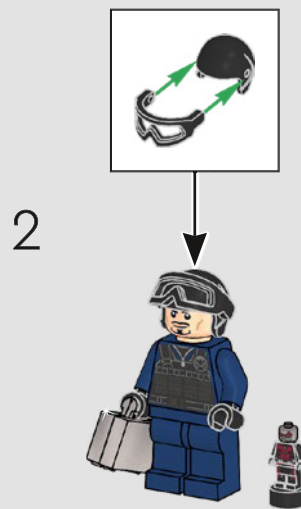
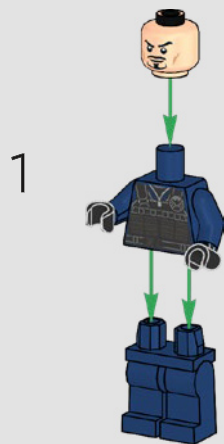
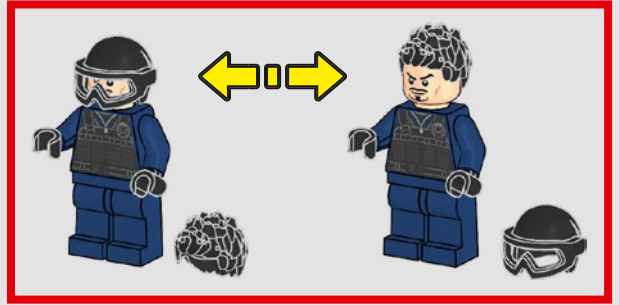



28

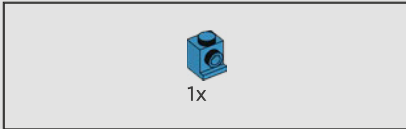
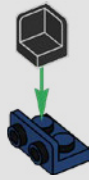

29

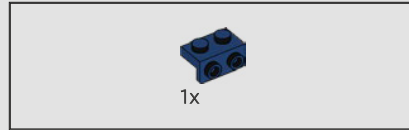

30

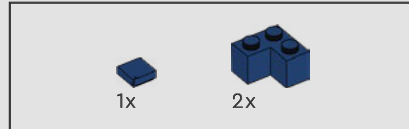
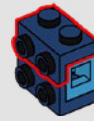

31

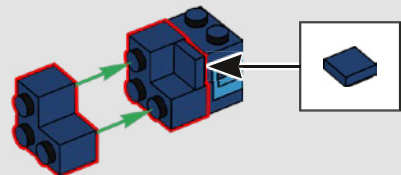

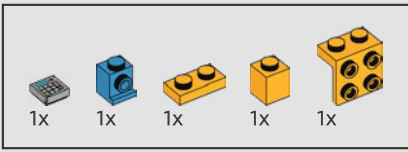

32

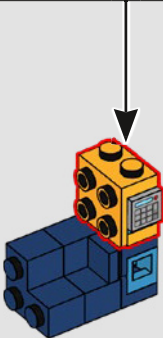
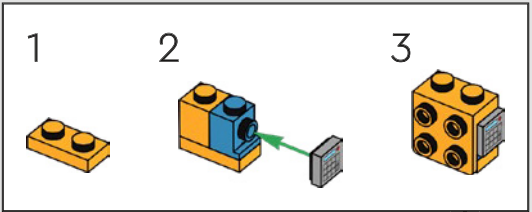

33

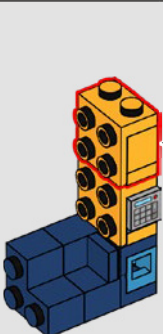
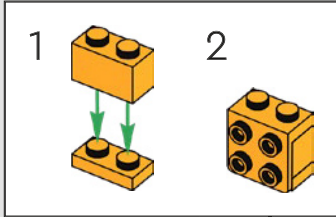

34

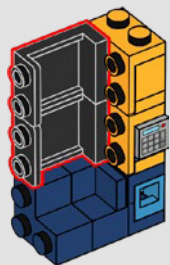

35

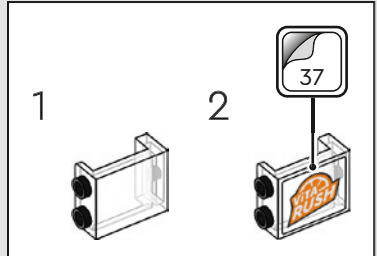

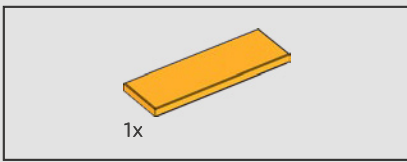

36

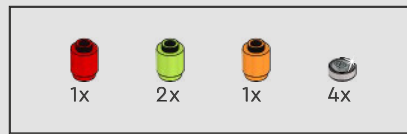
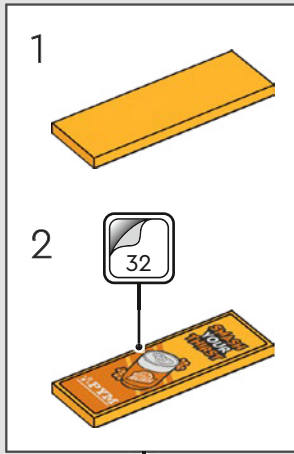

37

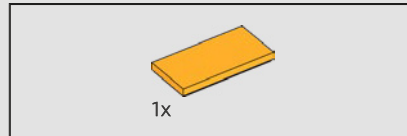
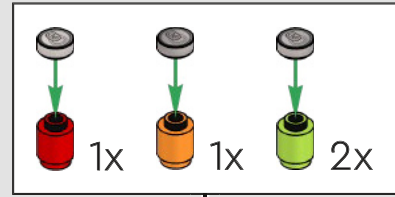

38



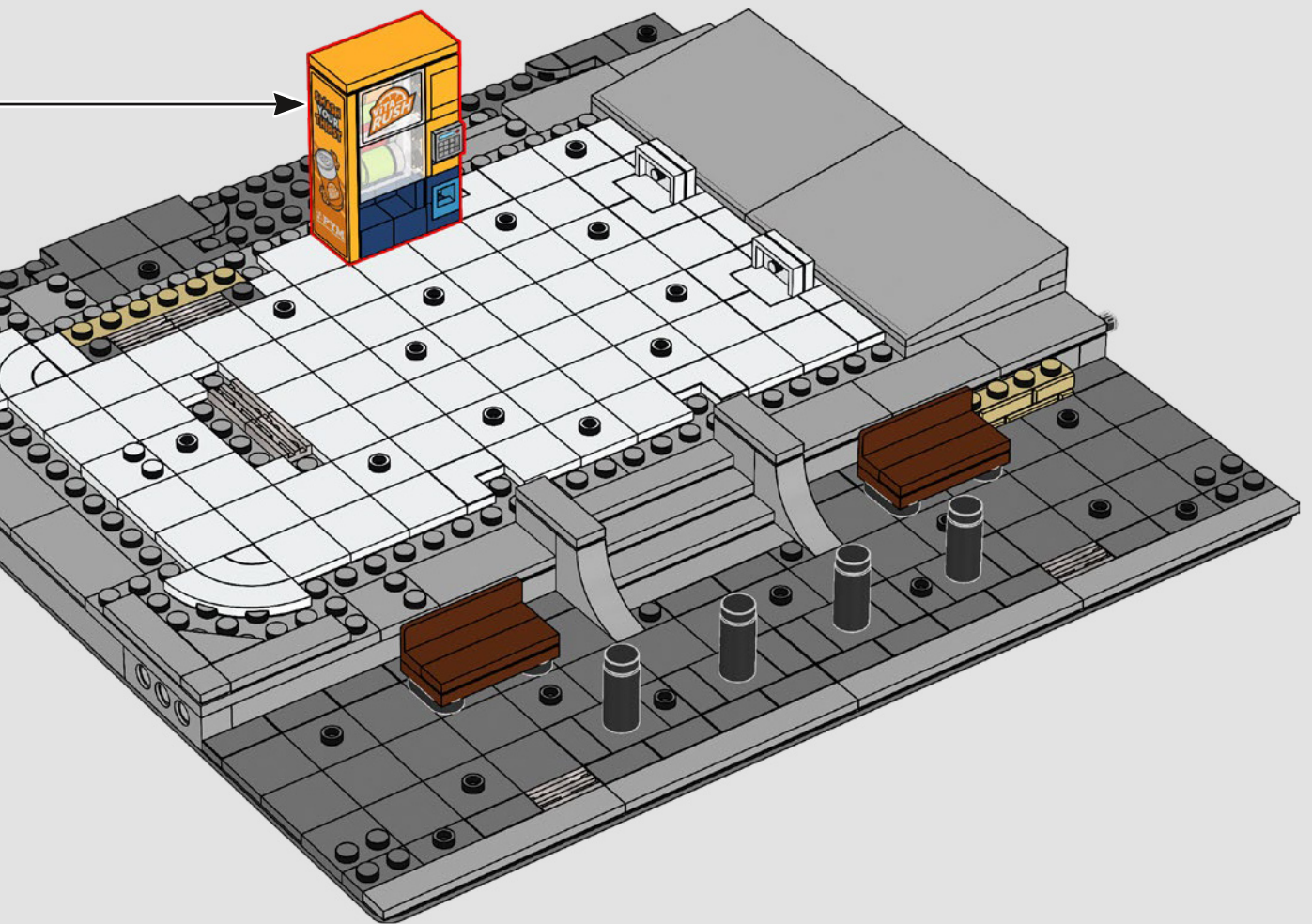

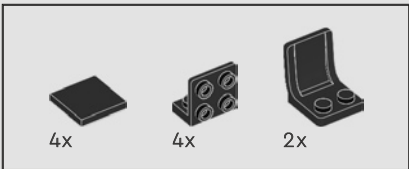

40

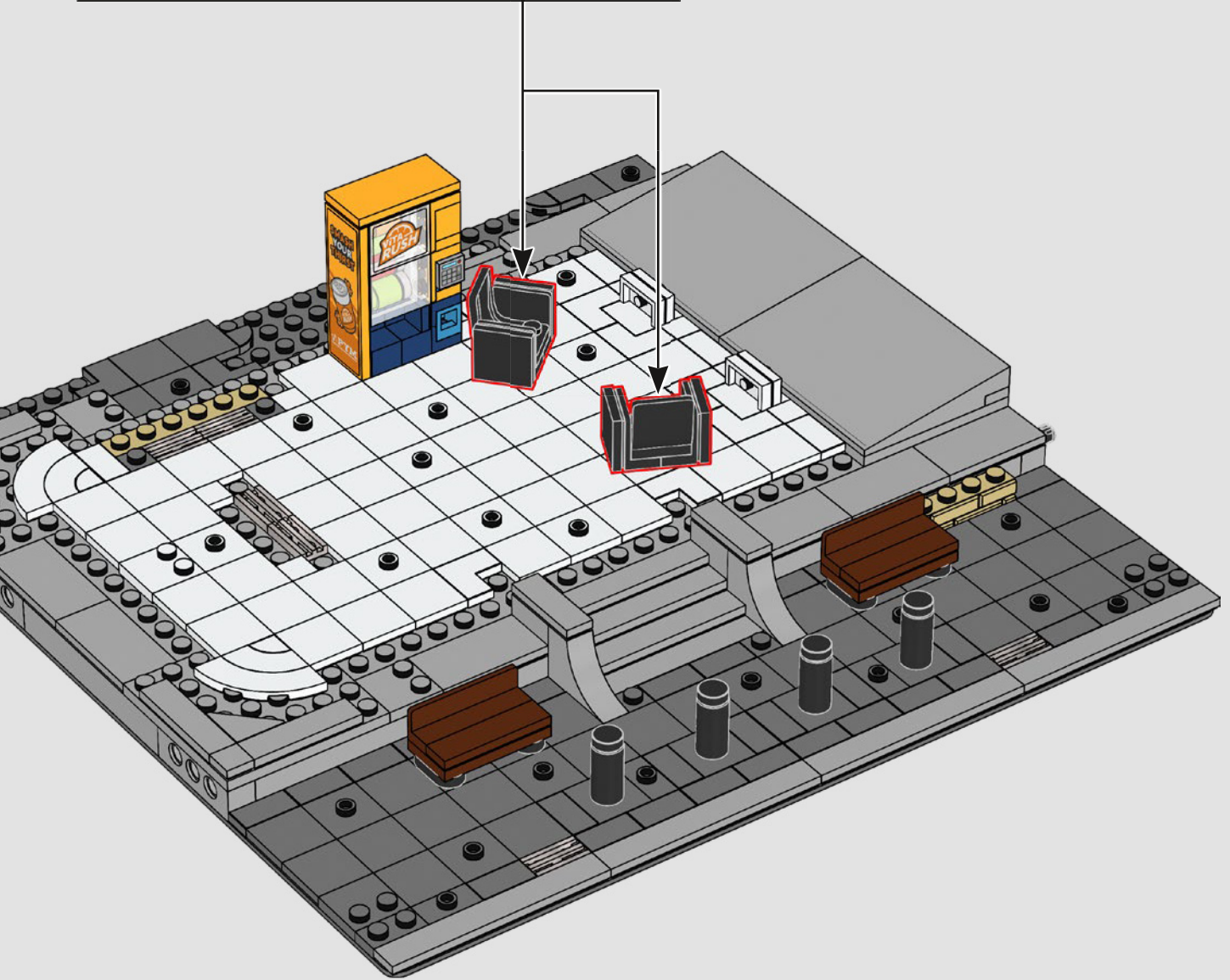
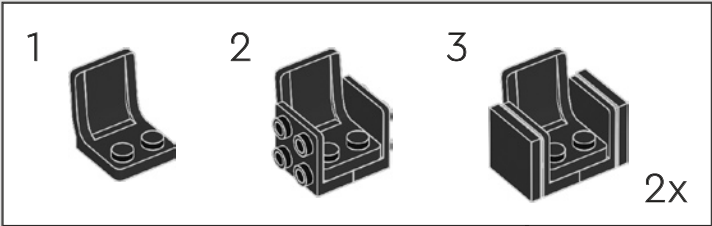

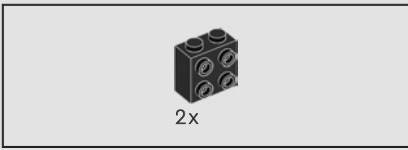

41

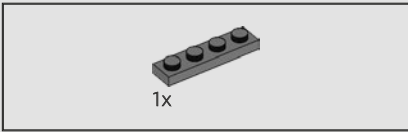
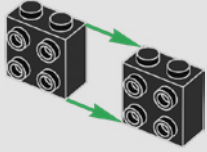

42

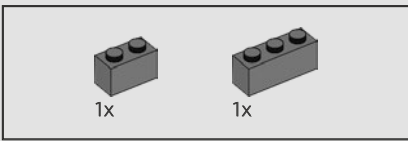

43

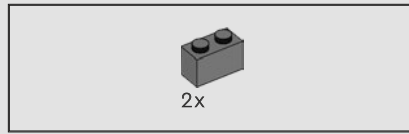
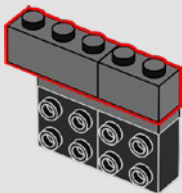

44

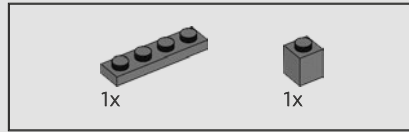
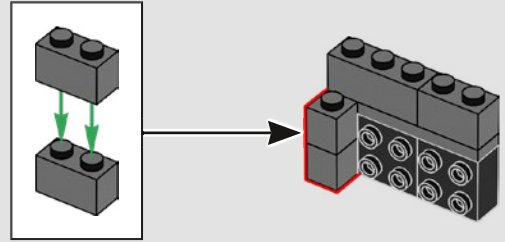

45

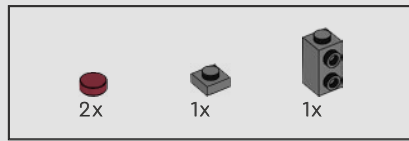
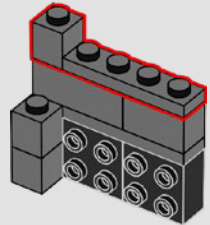

46

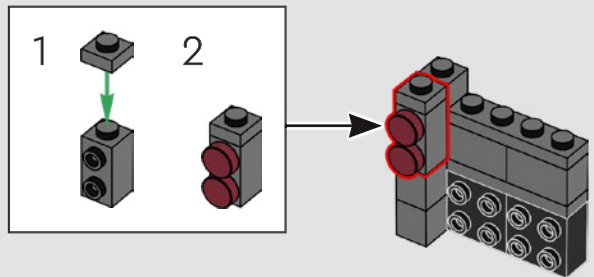

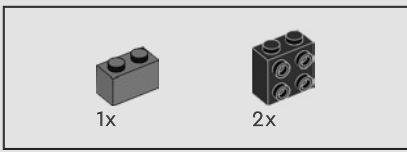

47

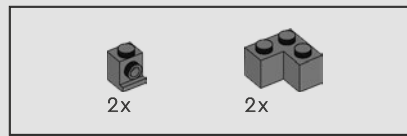
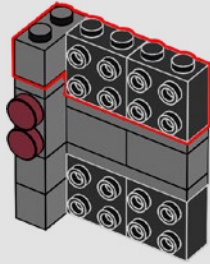

50

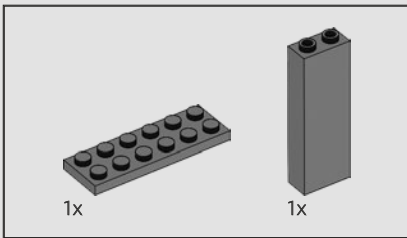
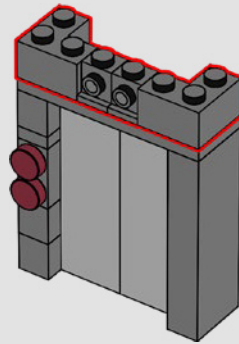

48

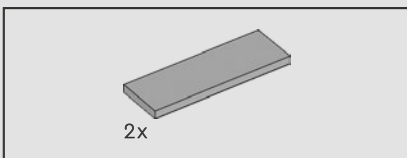
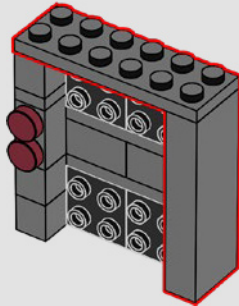

49

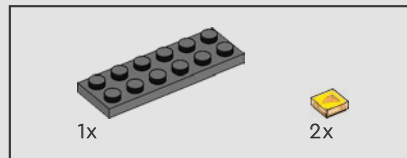
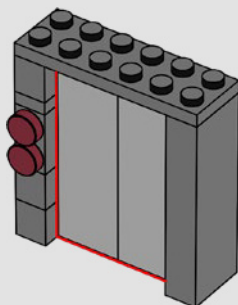

51

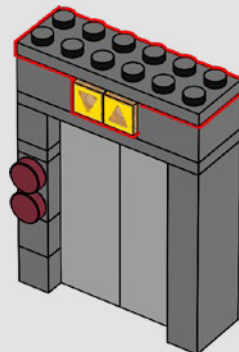

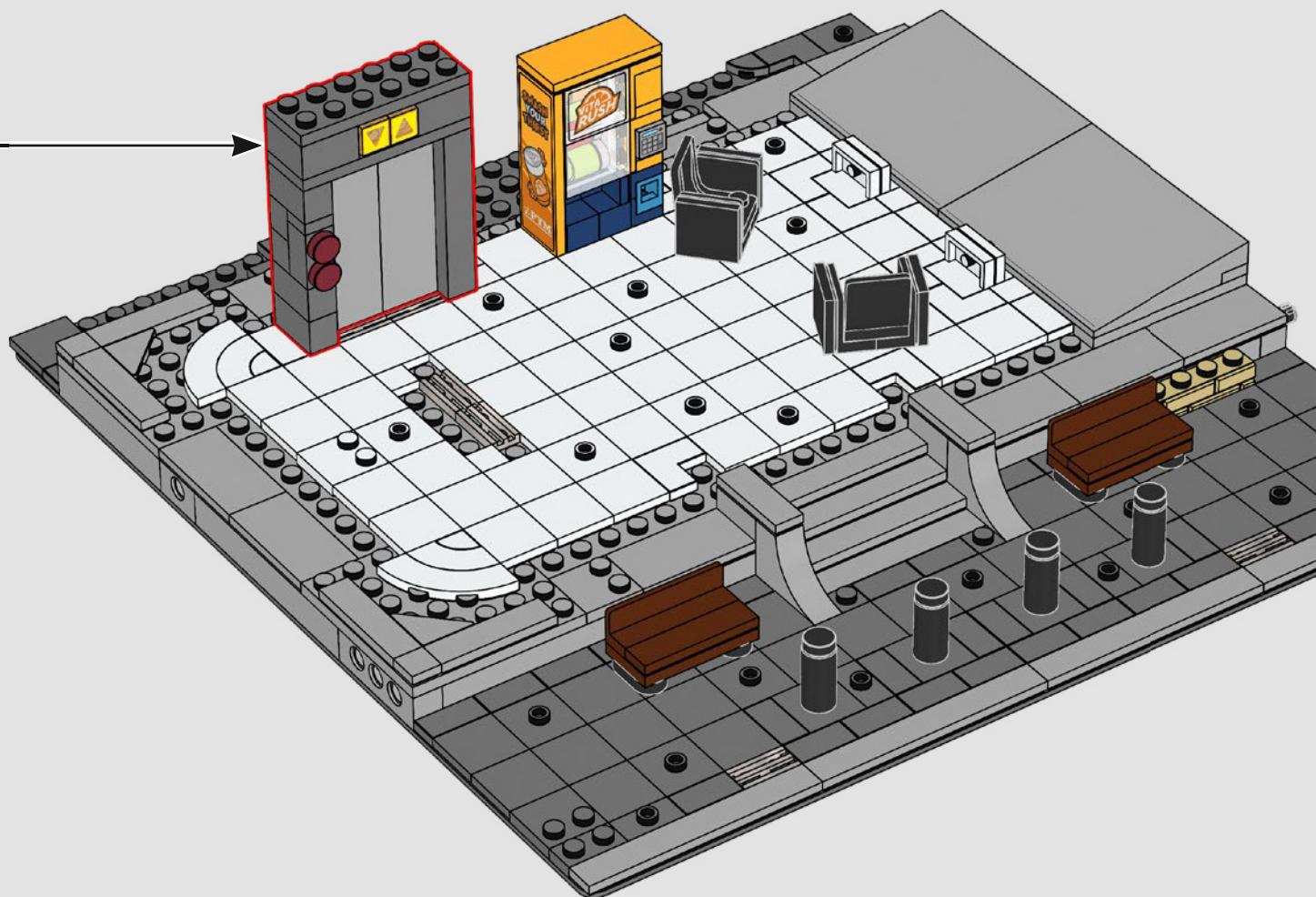



53

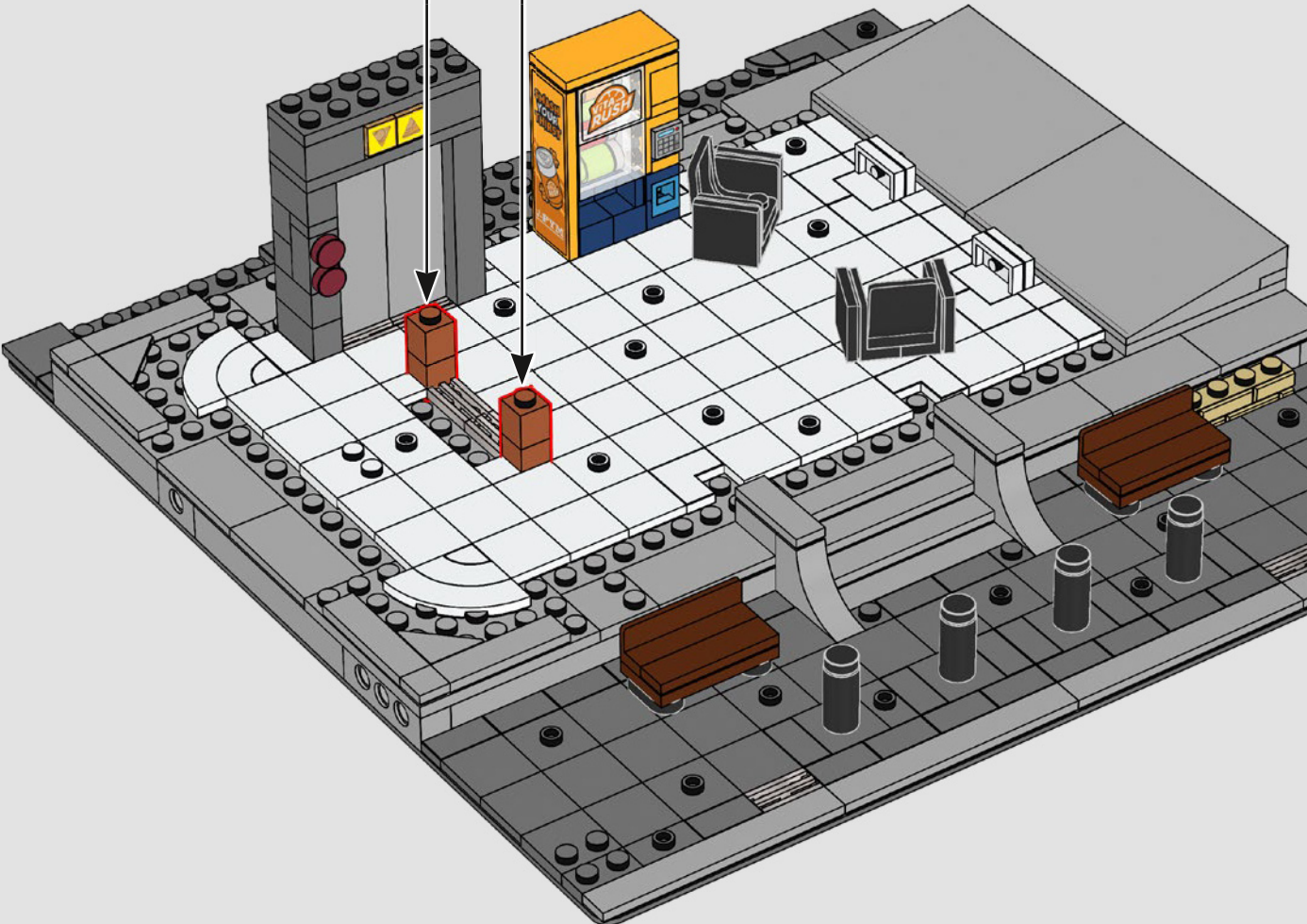
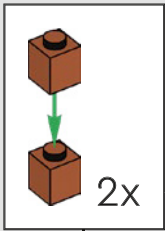

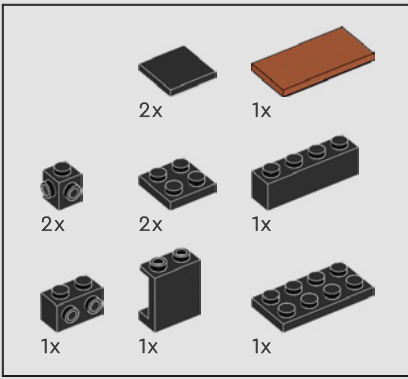

54

1

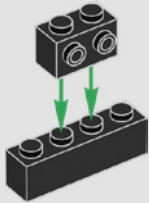

2

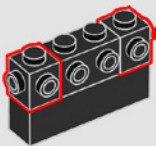

3

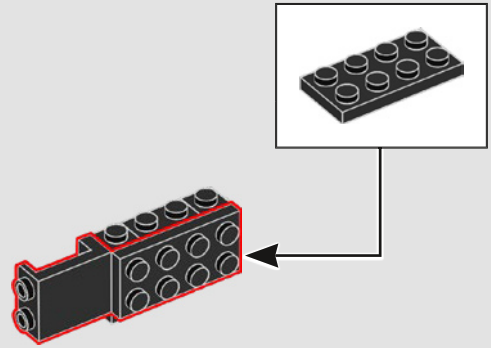

4

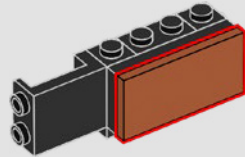

5

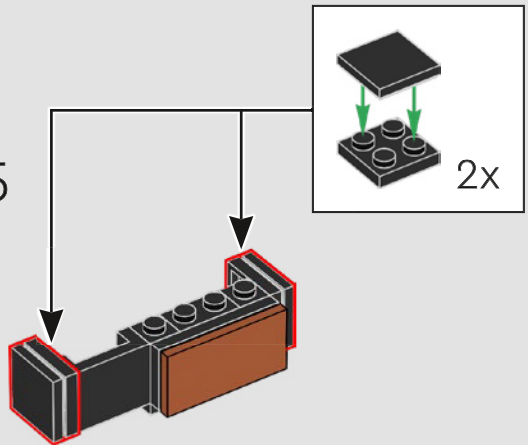

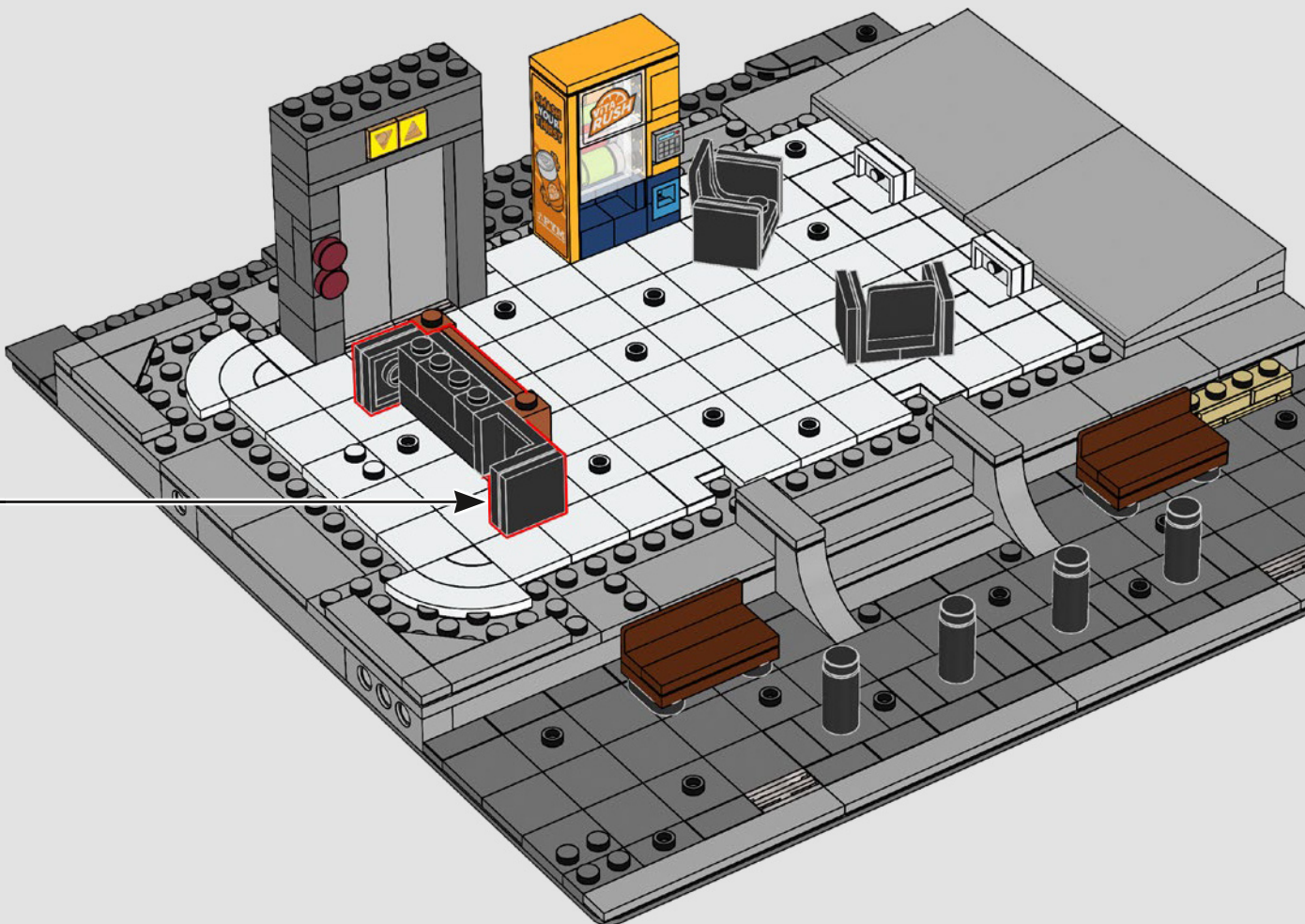



55

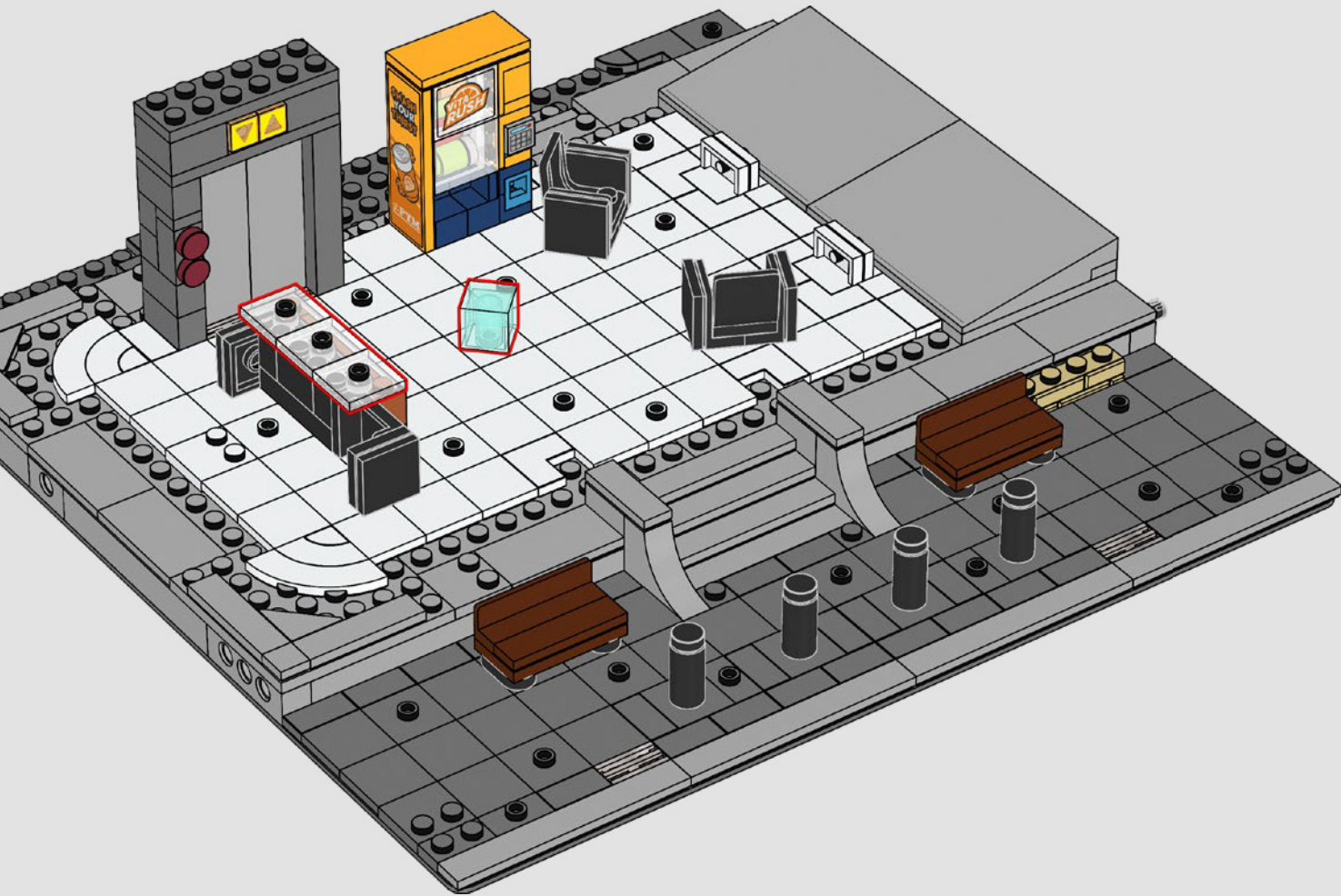

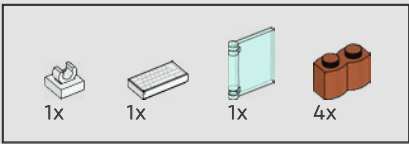

56

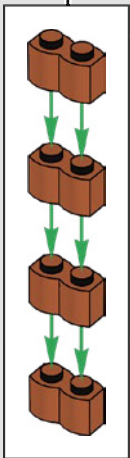
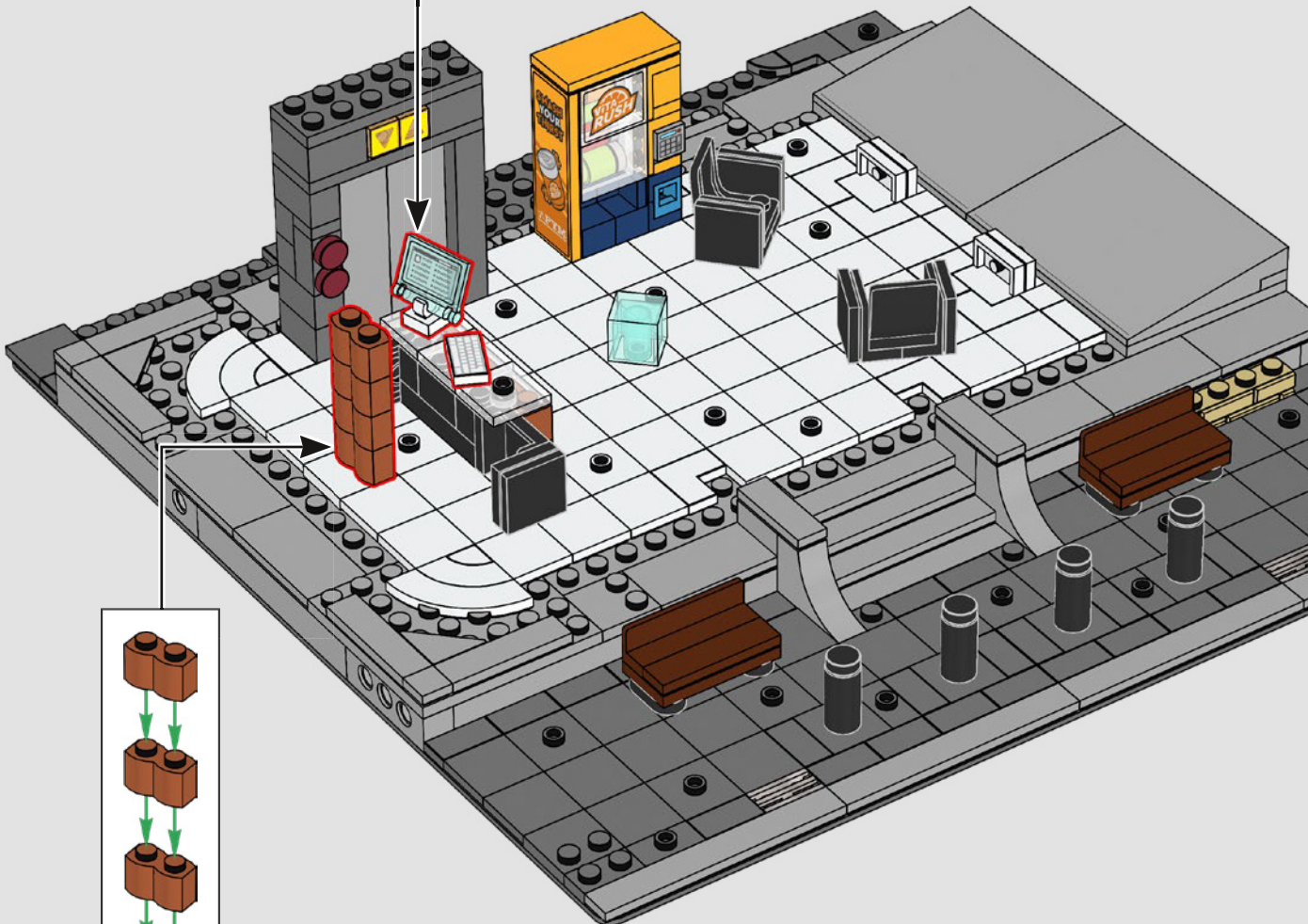
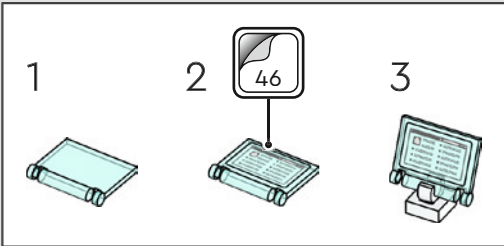

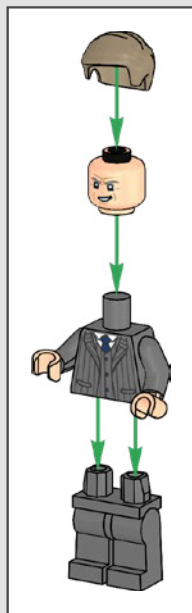

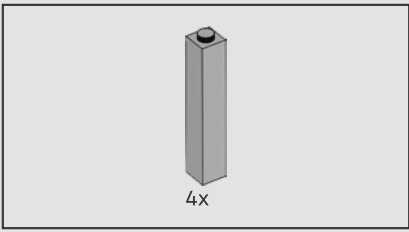

57

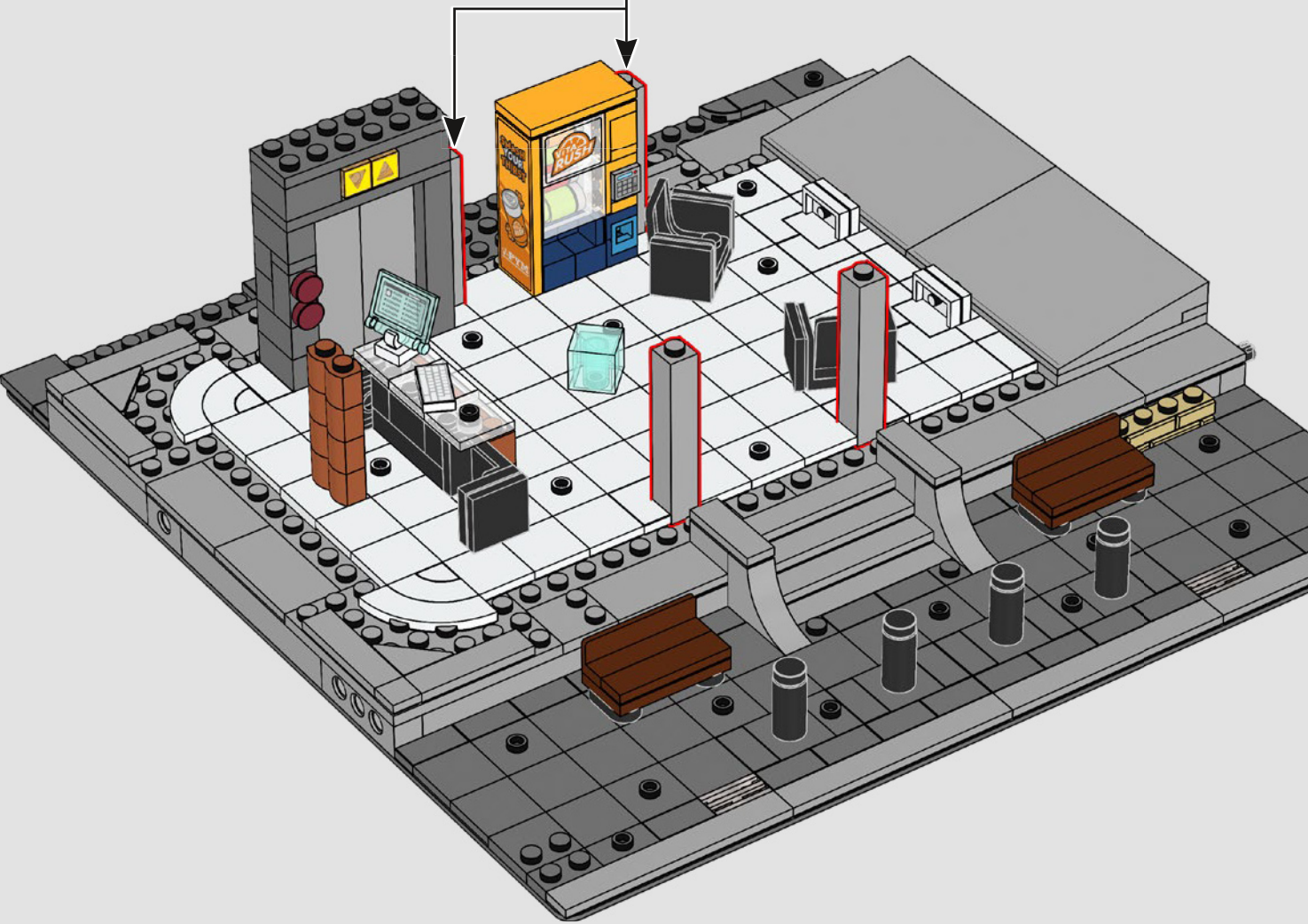
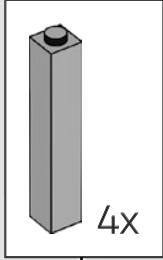

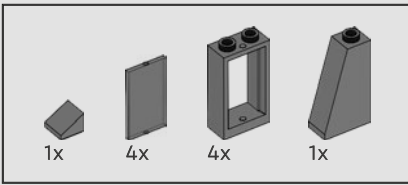

58

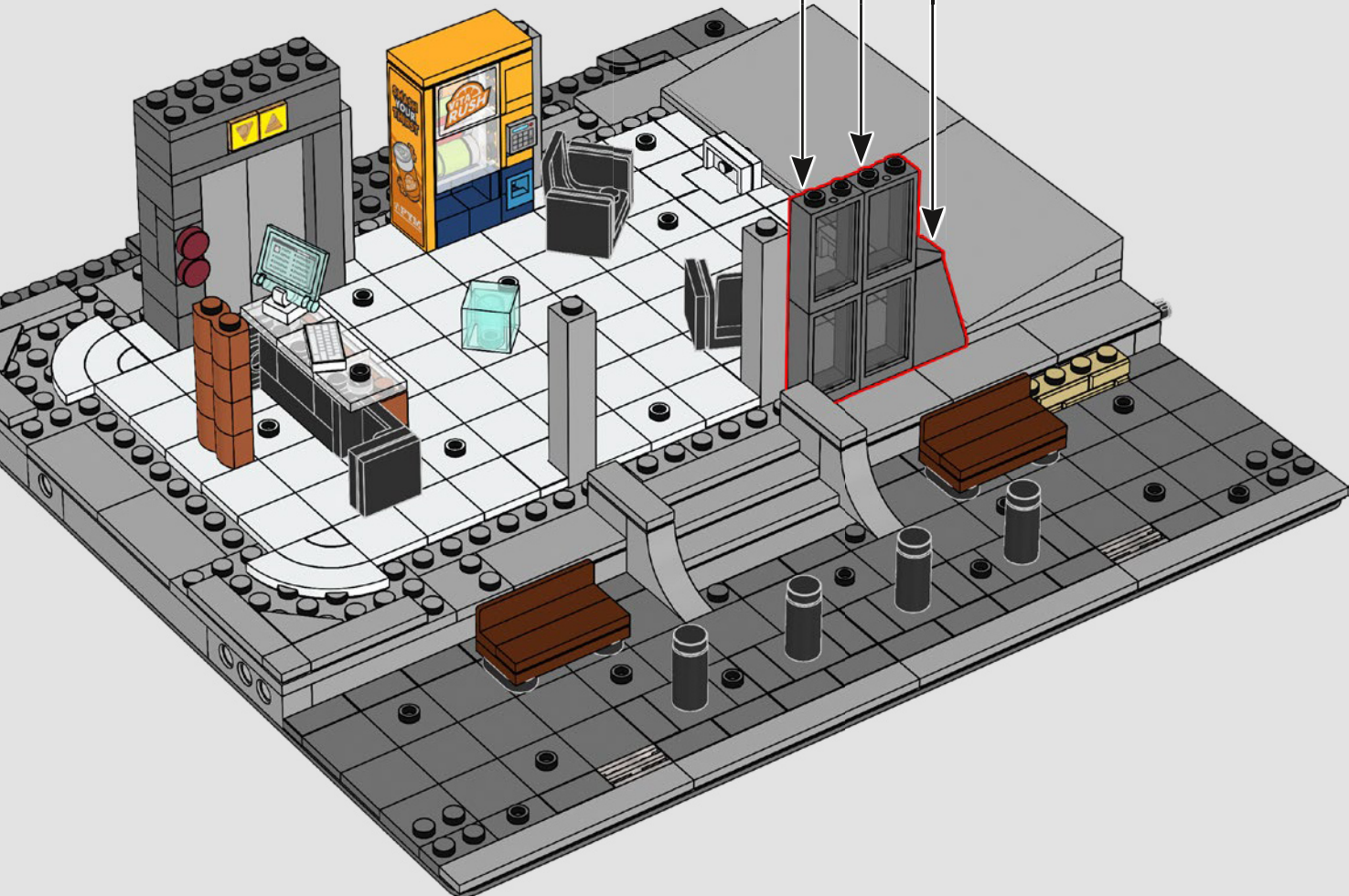
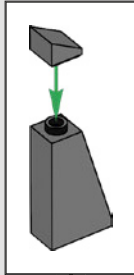
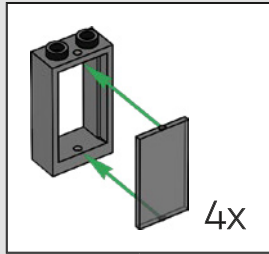

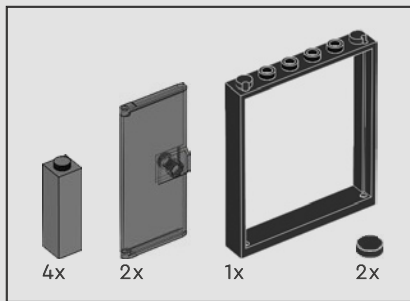

59

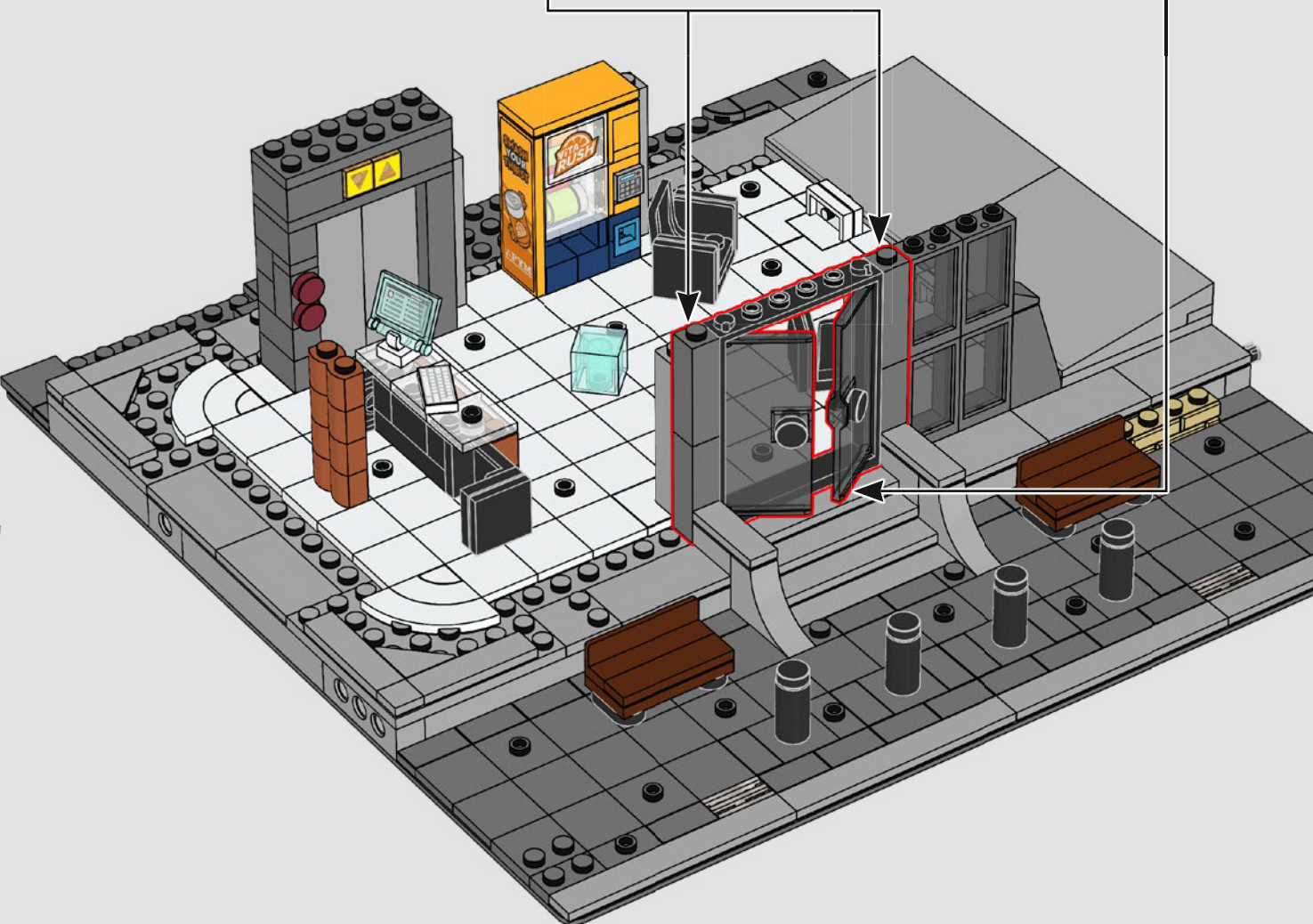
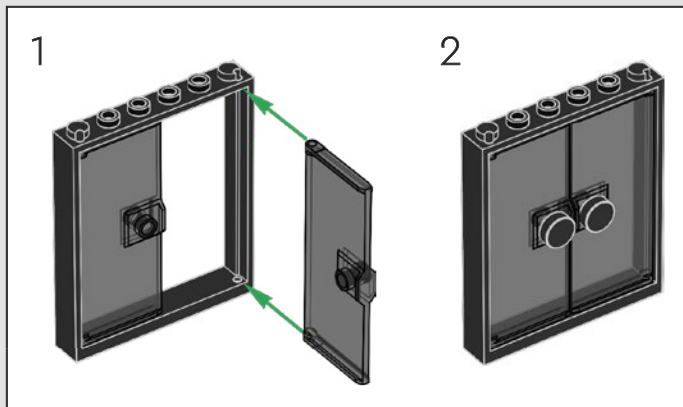
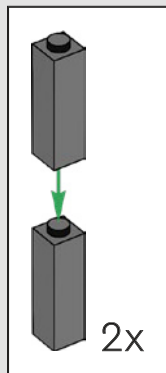

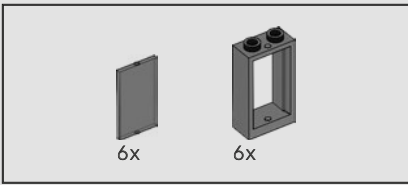

60

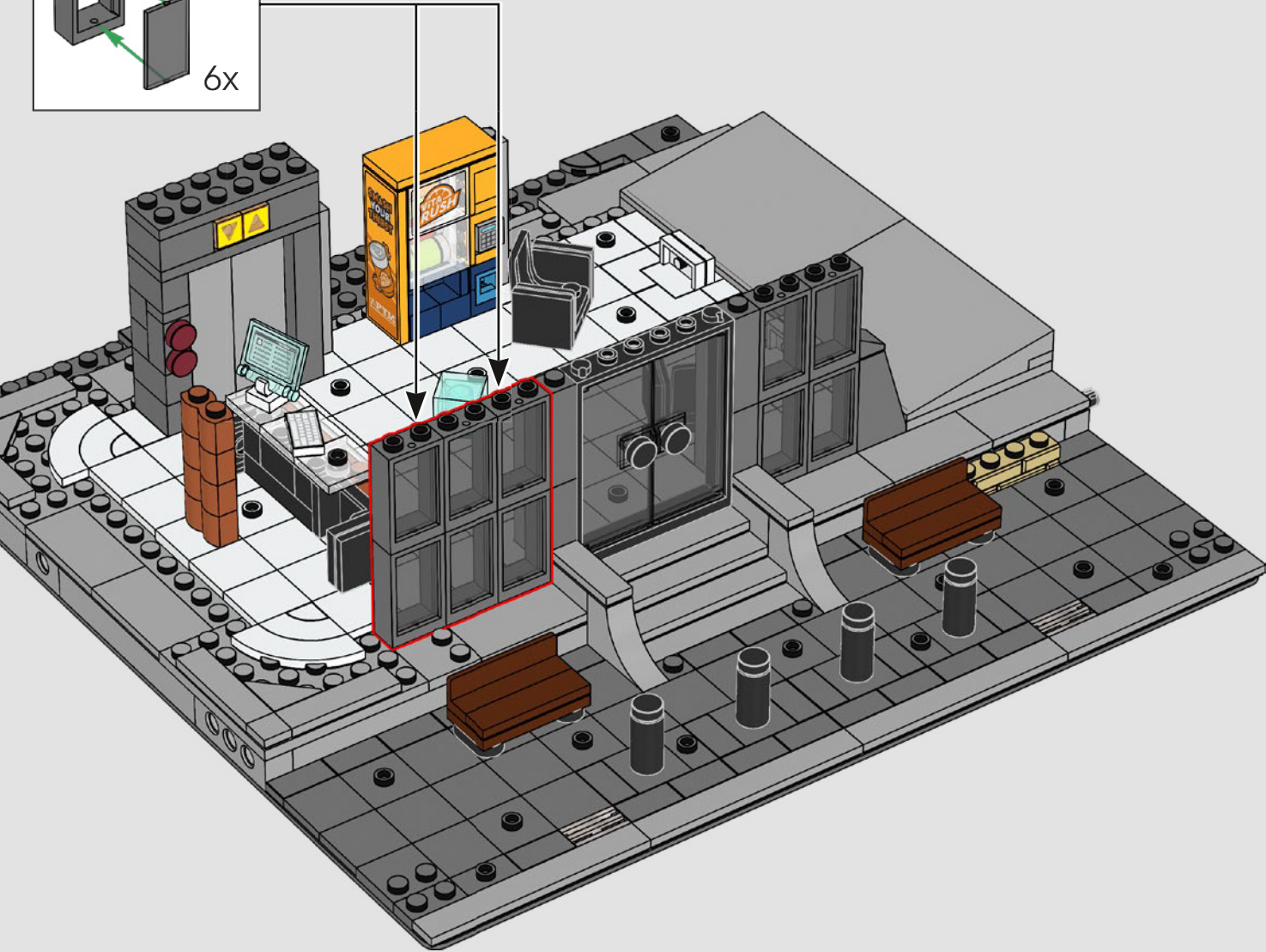
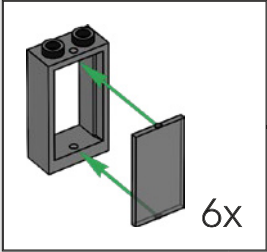

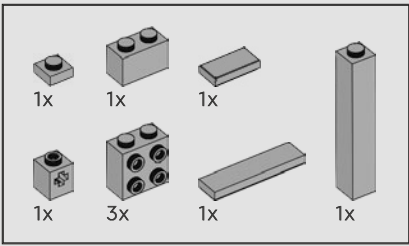

61

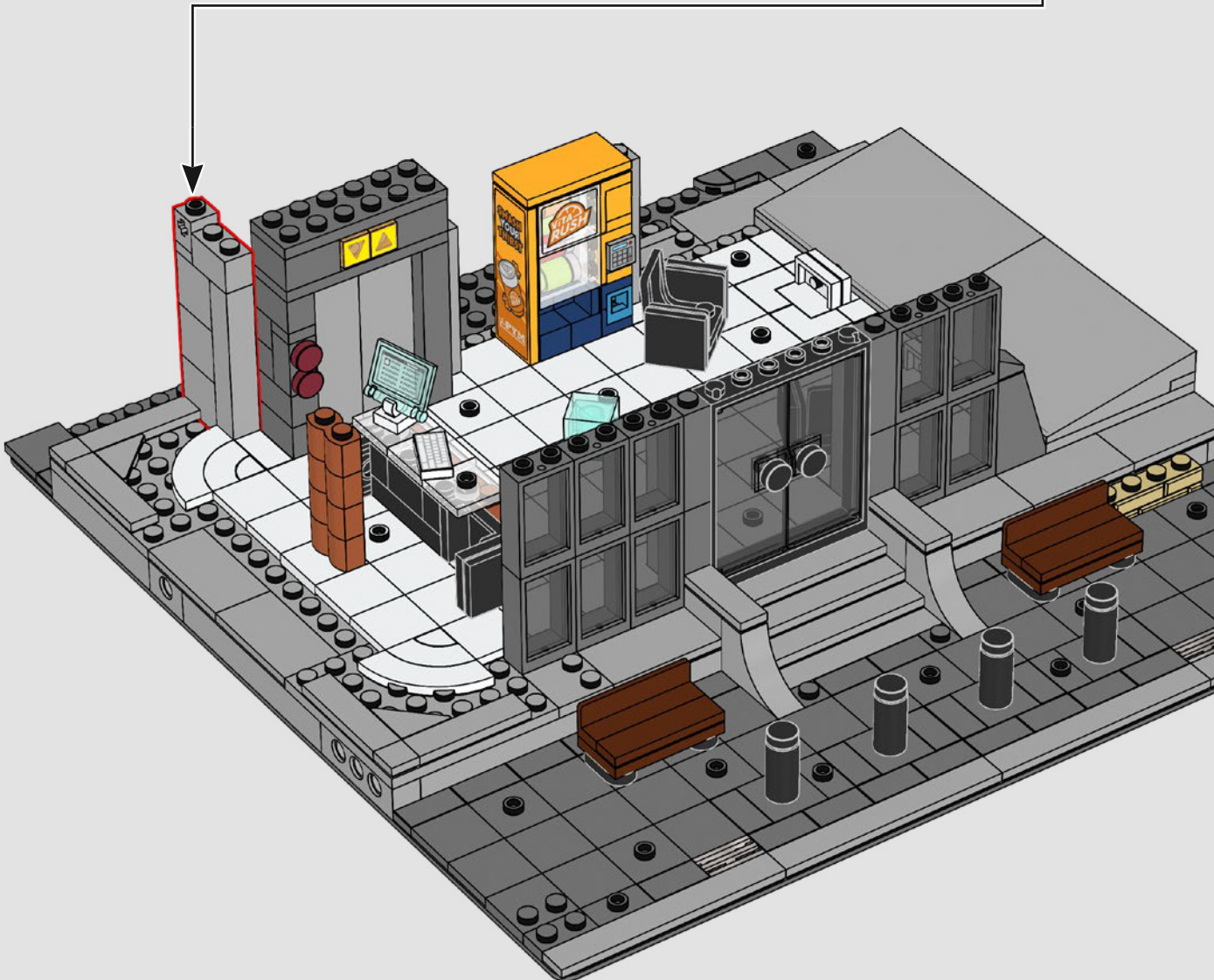
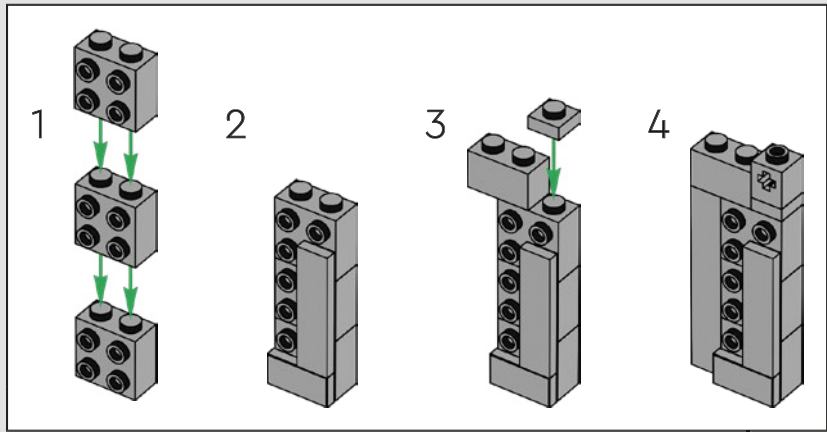

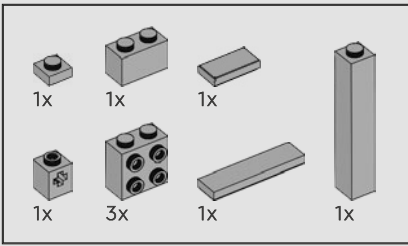

62

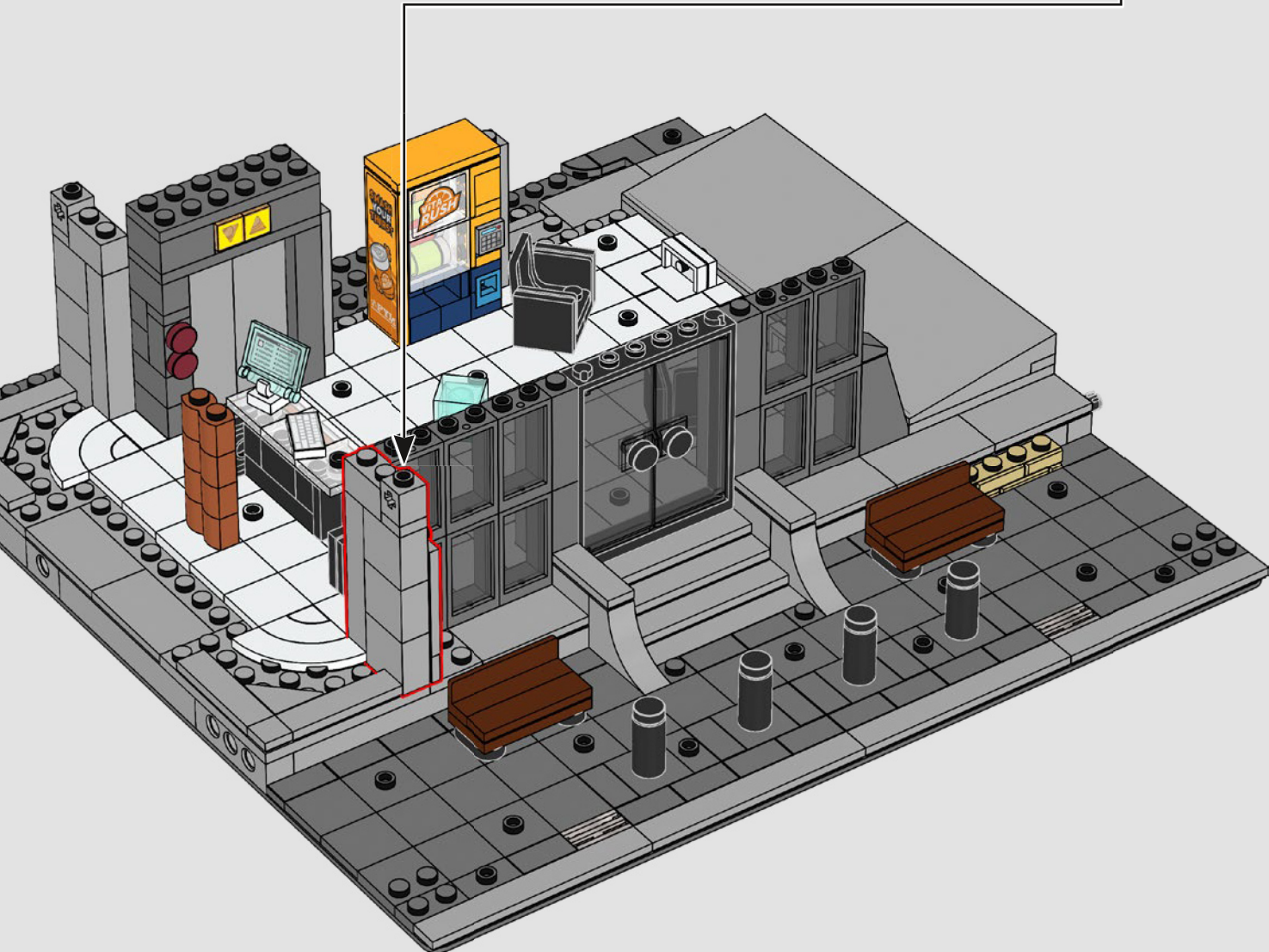
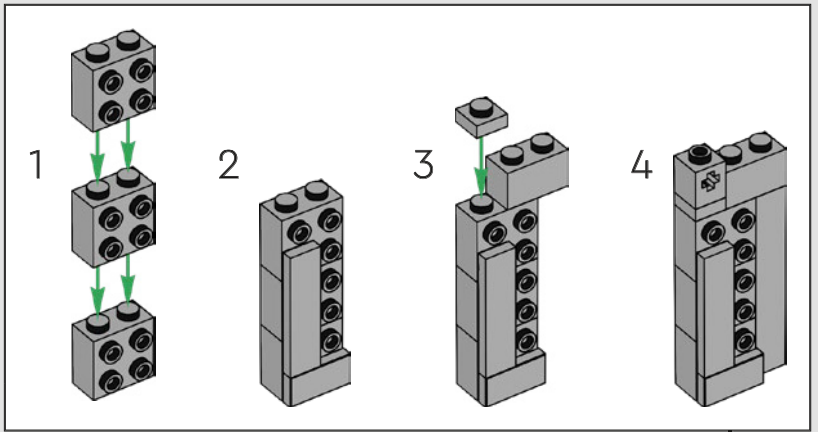

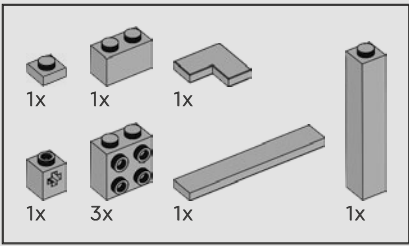

63

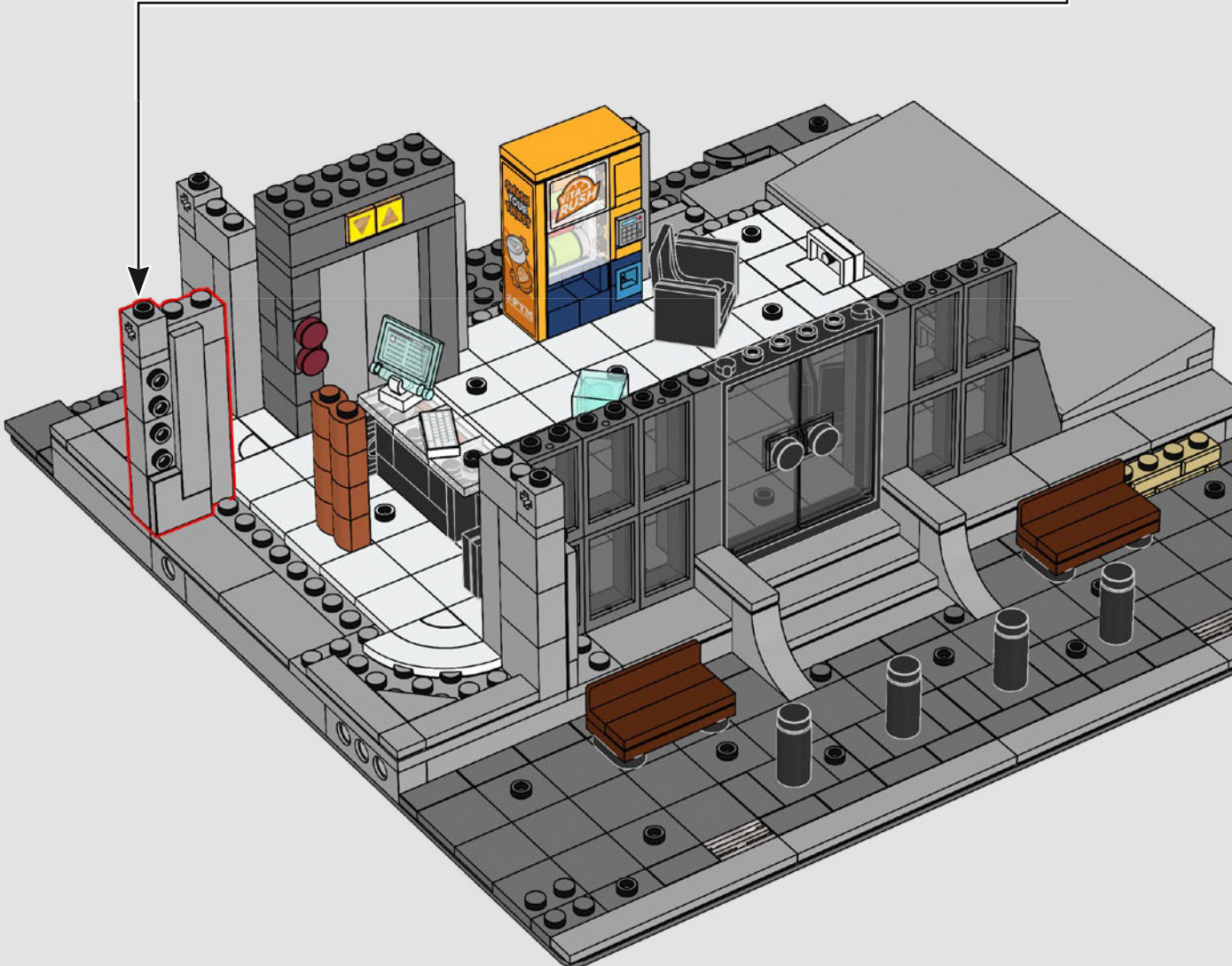
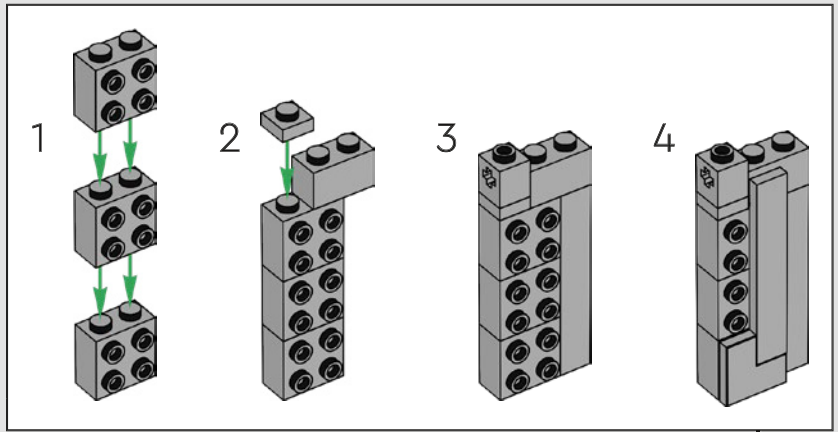

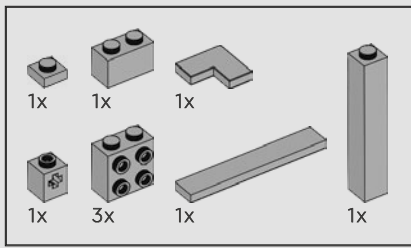

64

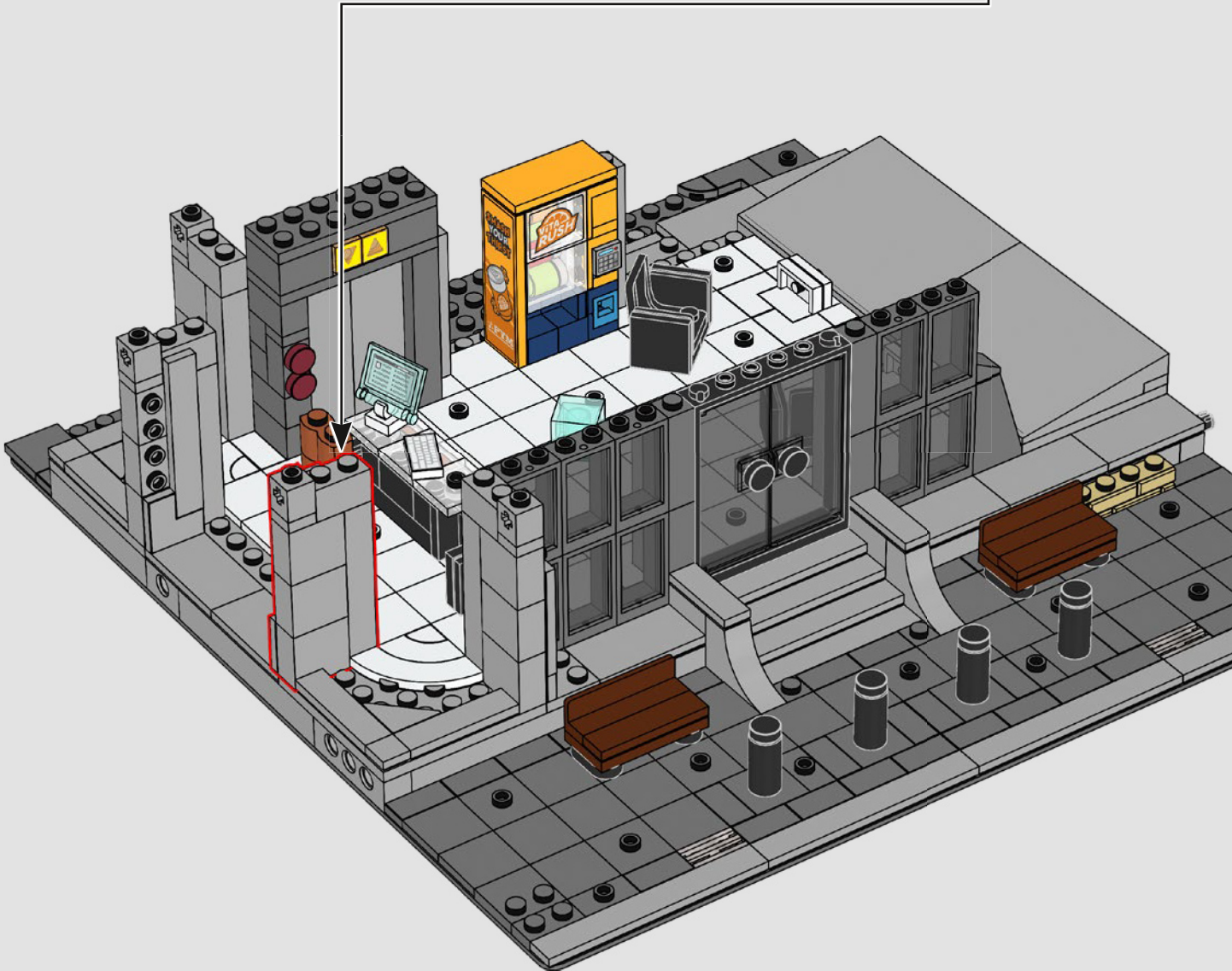
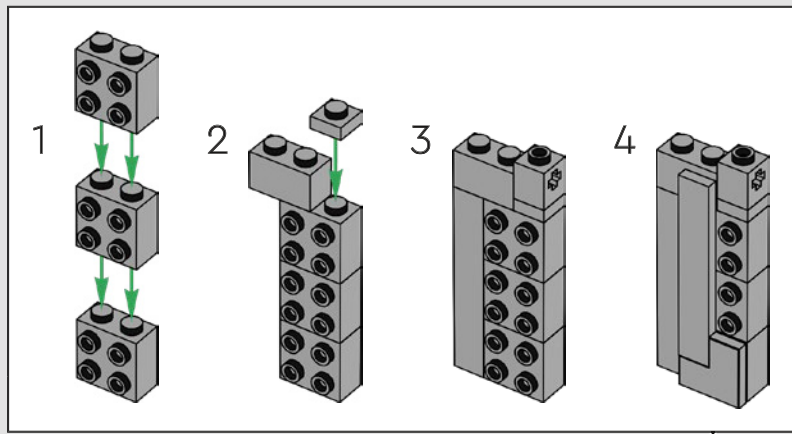

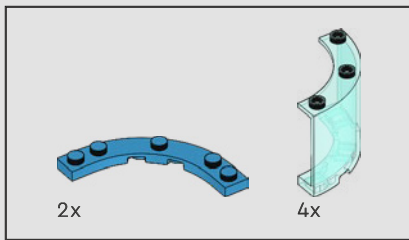

65

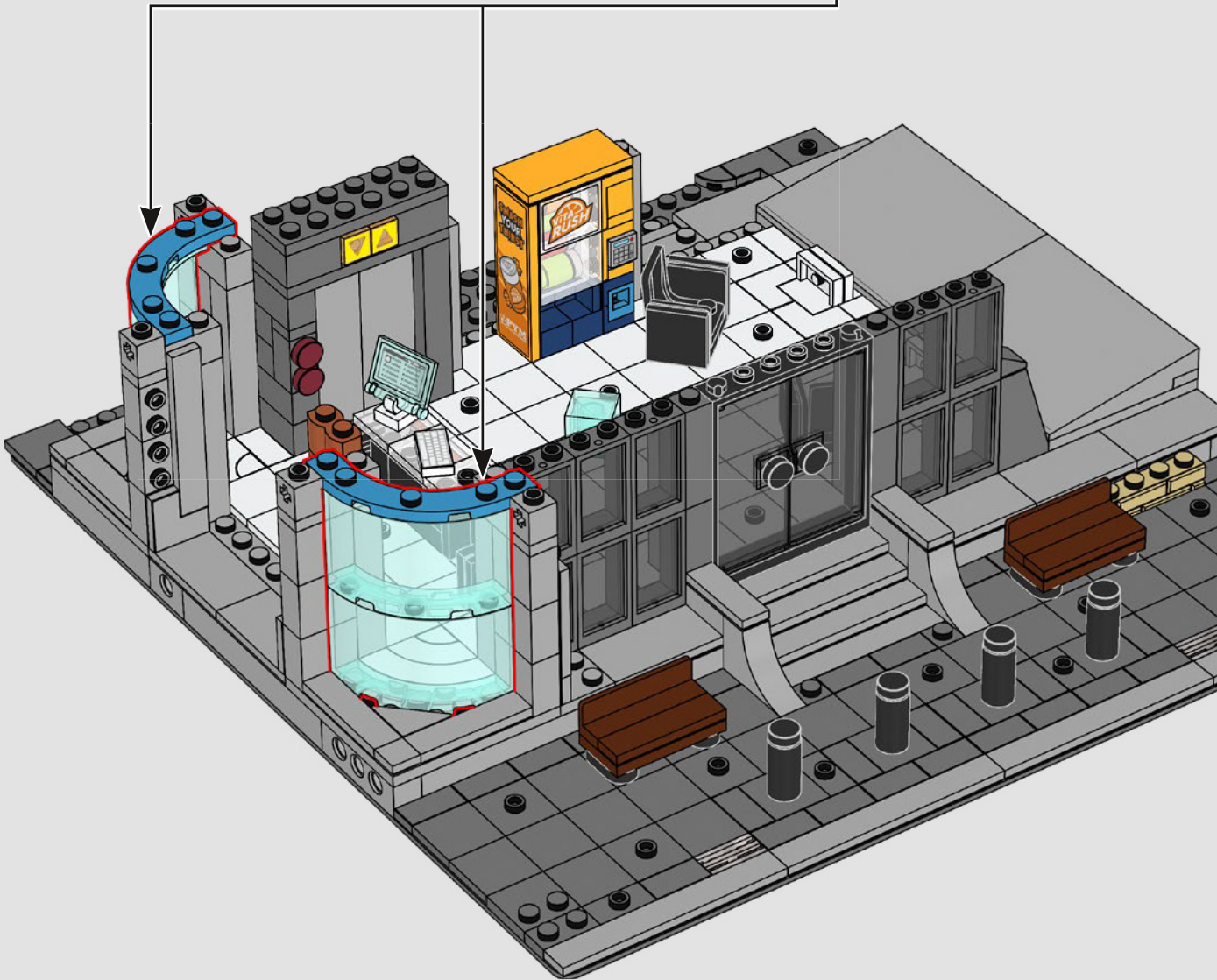
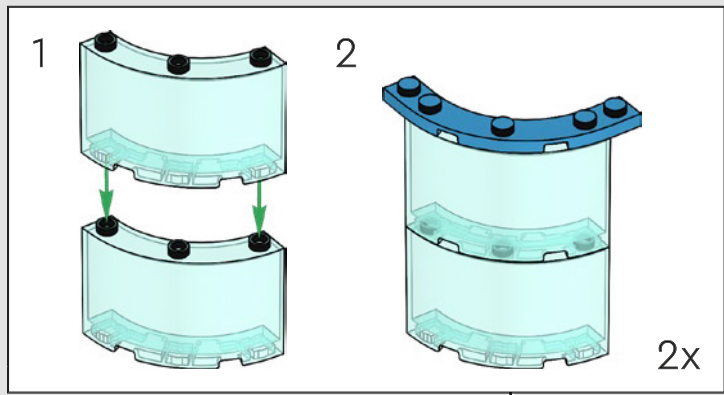

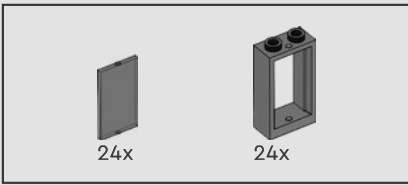

66

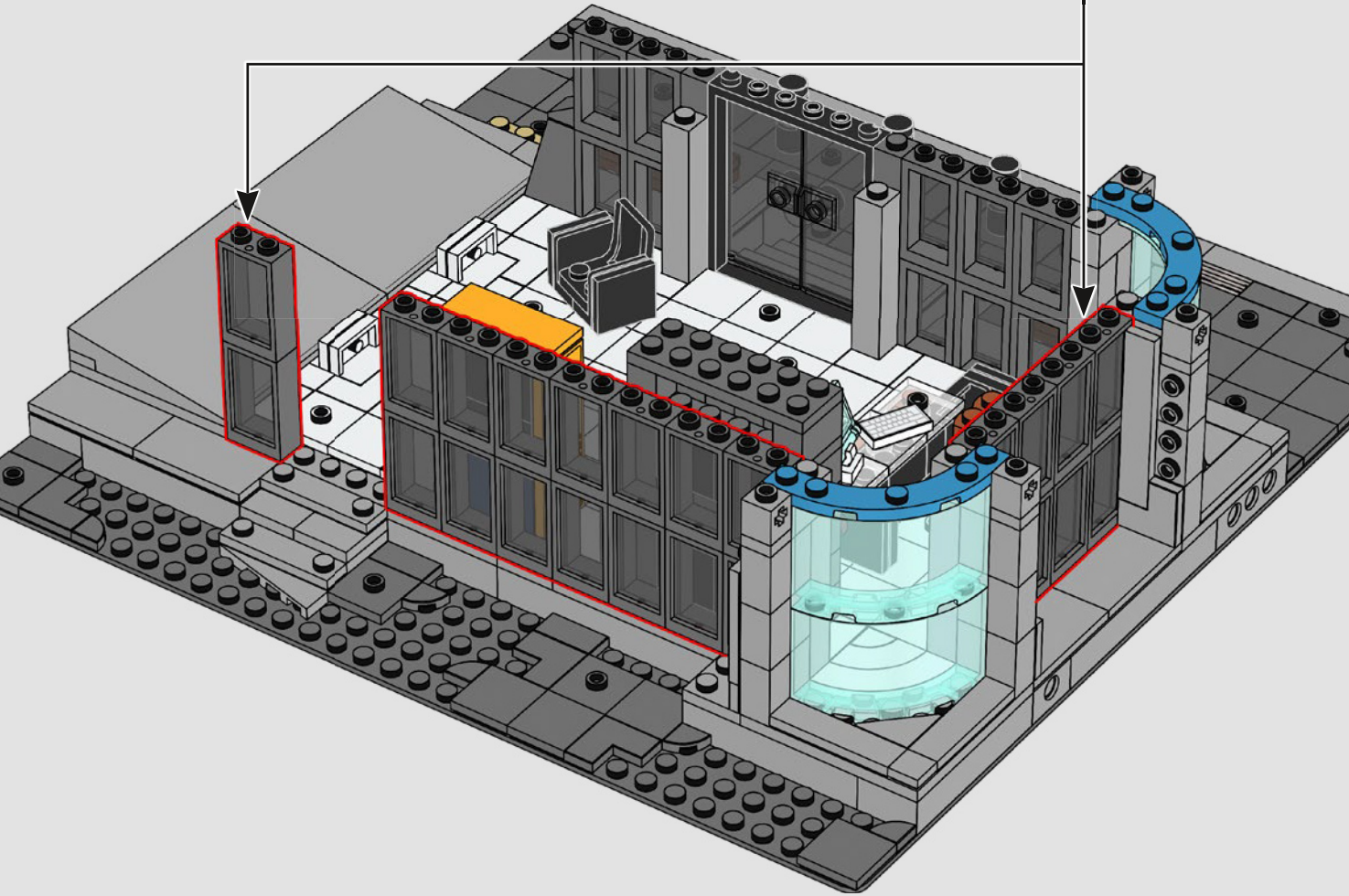
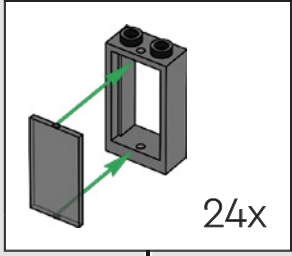

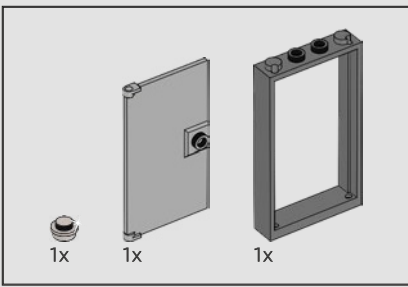

67

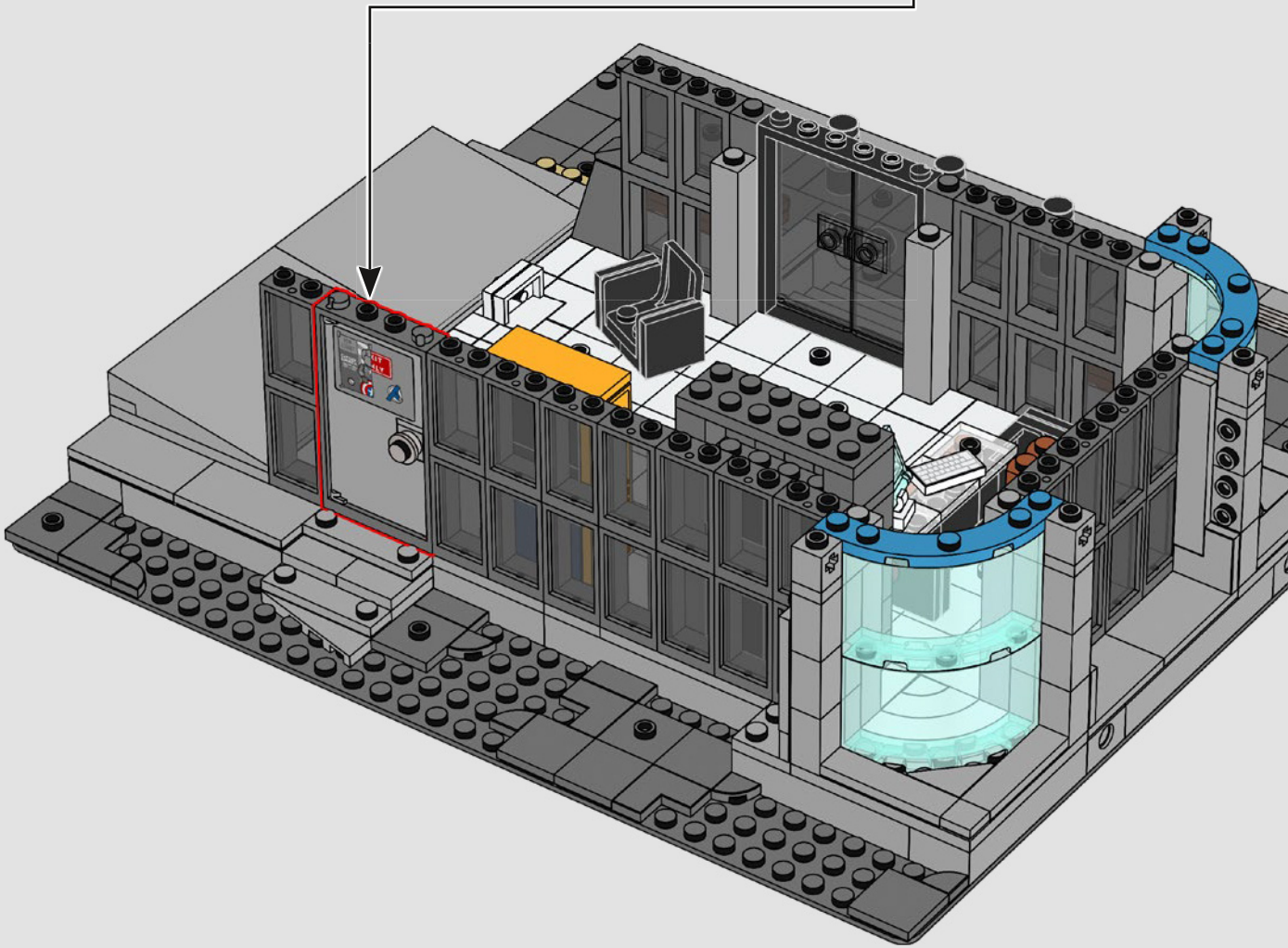
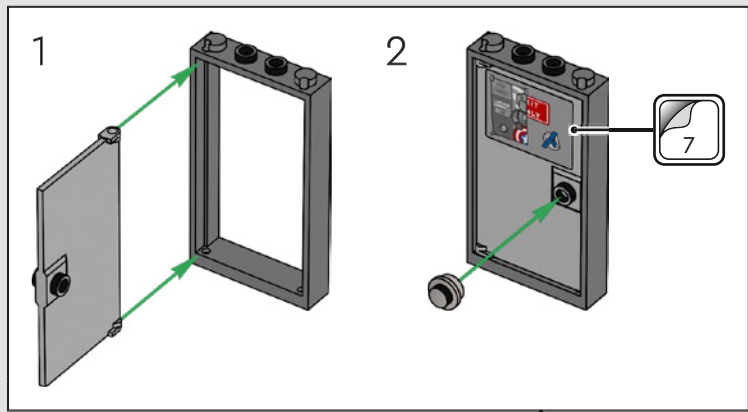

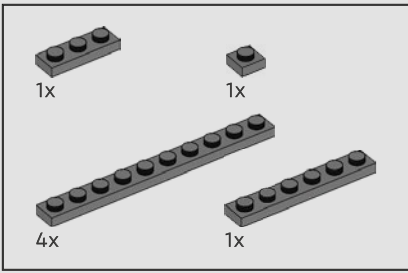

68

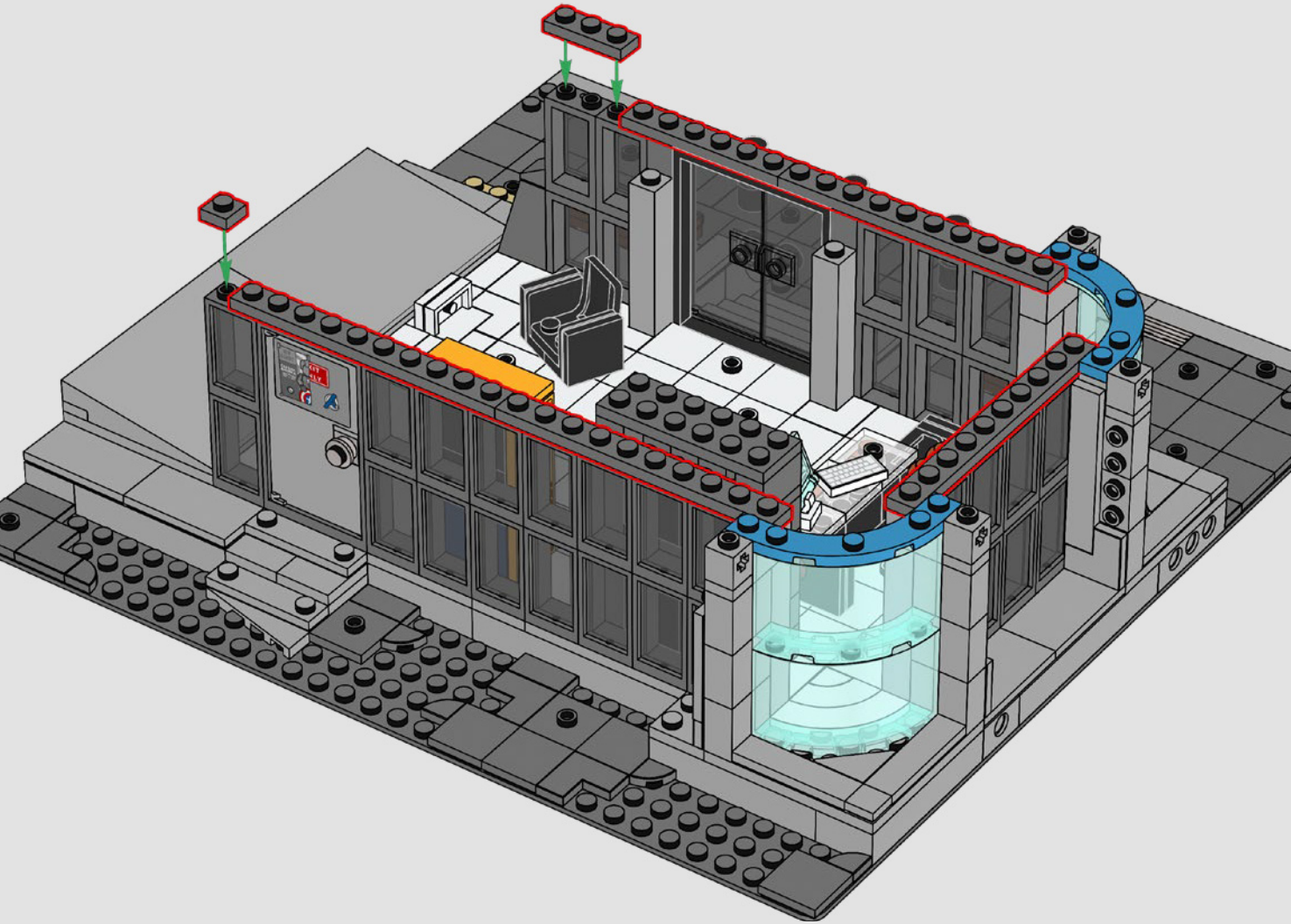

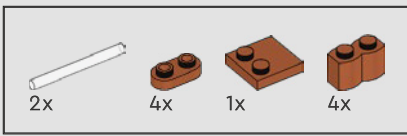

69

1



2

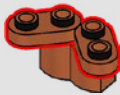

3

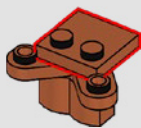

4

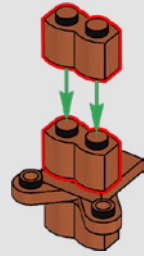

1



2



2x

5

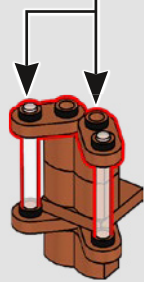

6

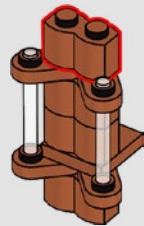

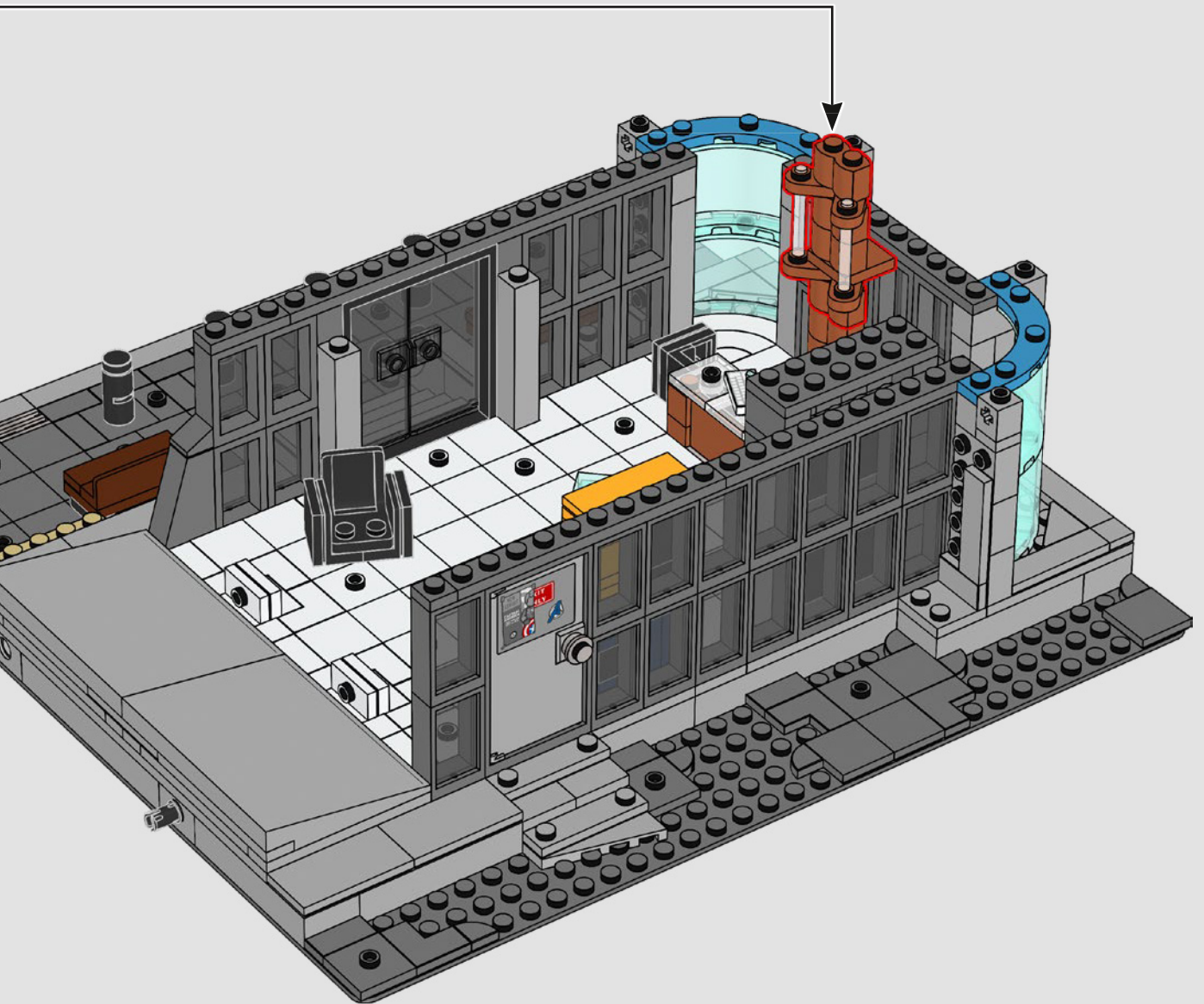



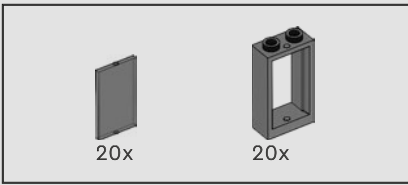

70

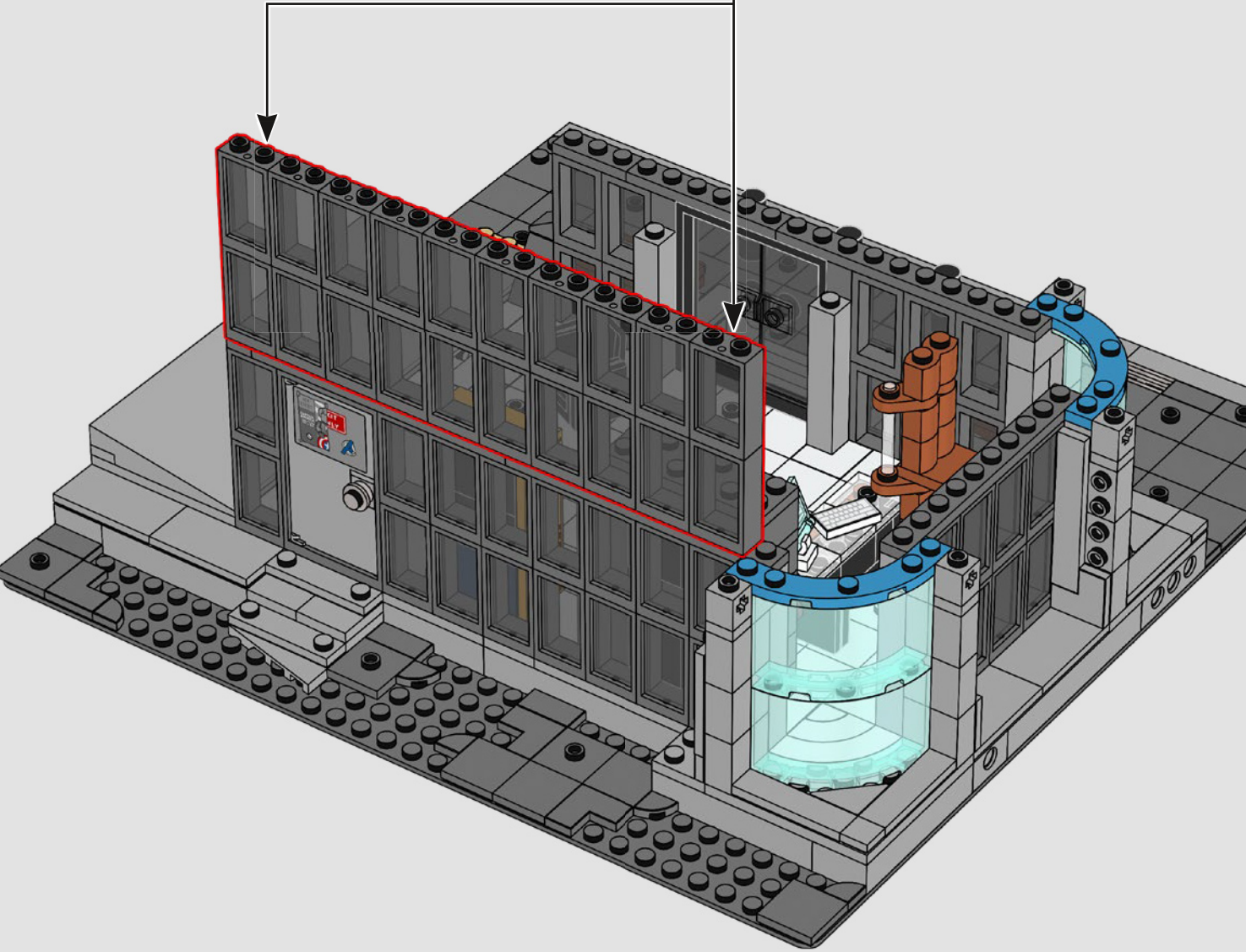
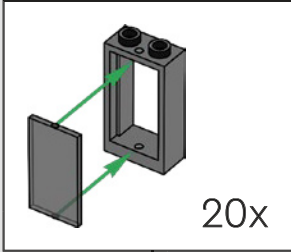

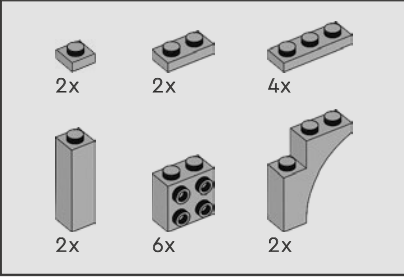
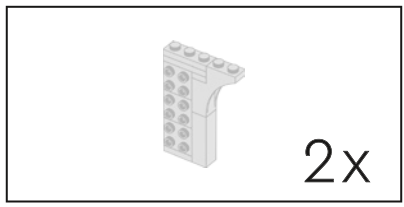

71

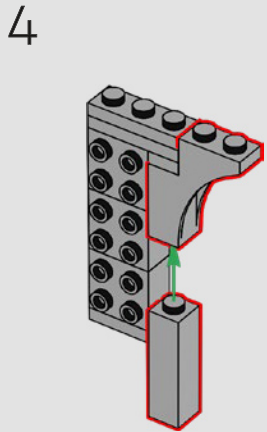
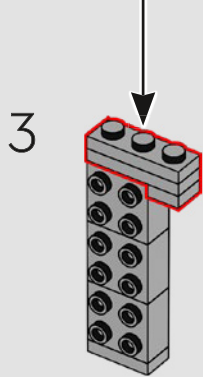
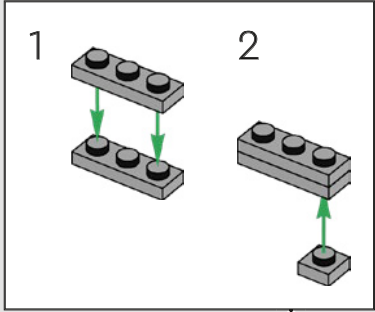
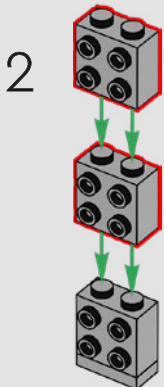
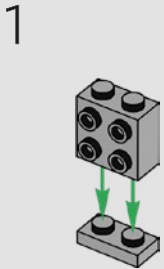

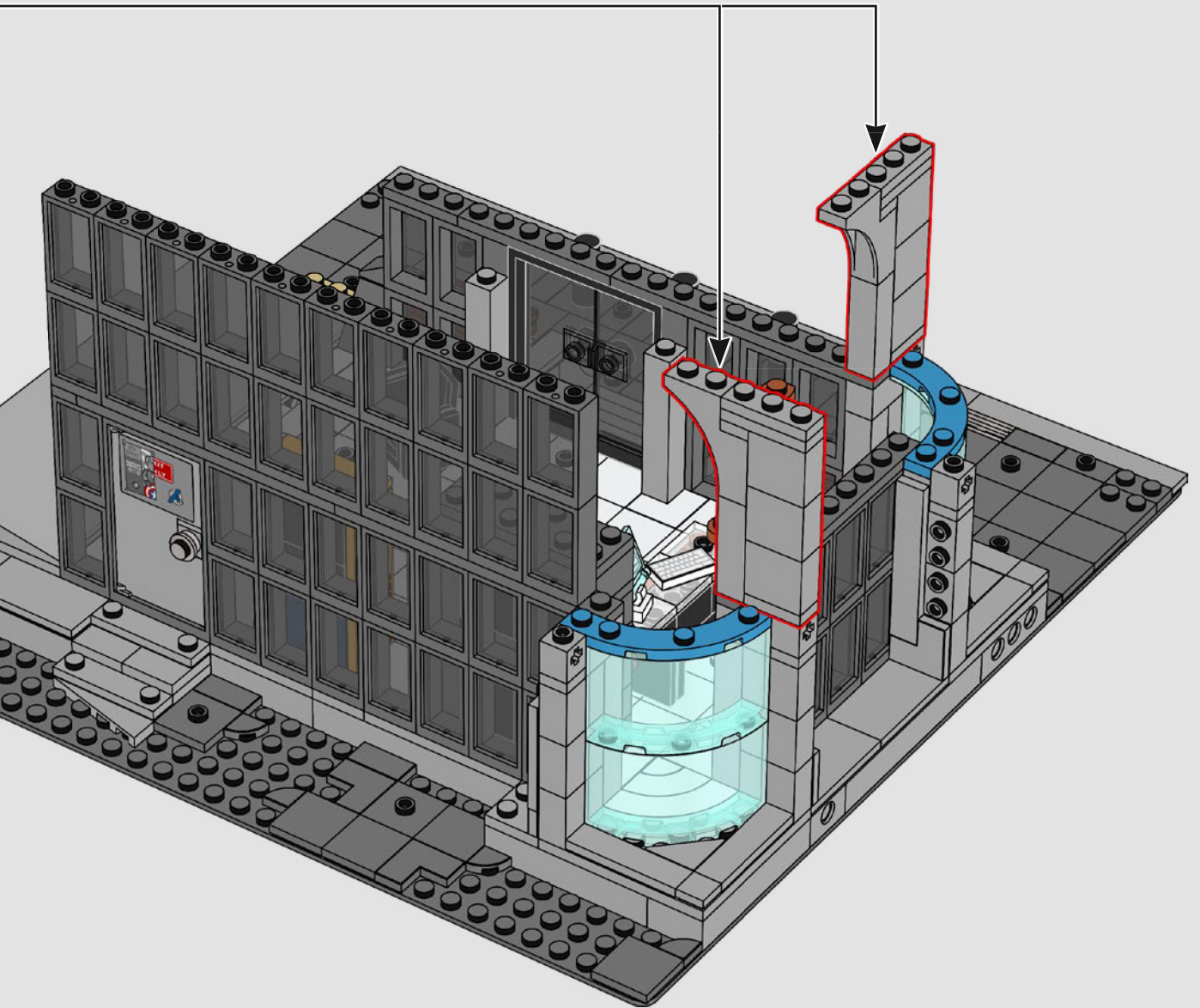

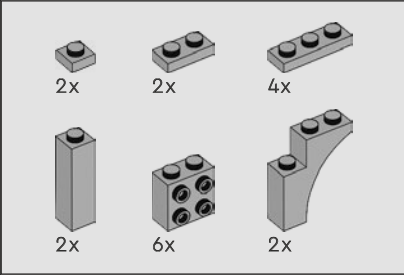
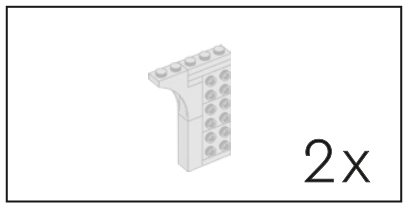

72

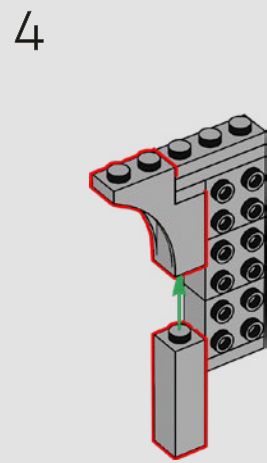
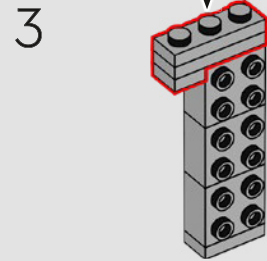
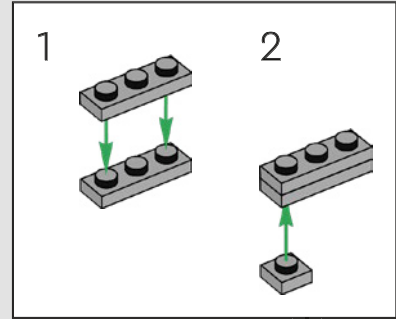
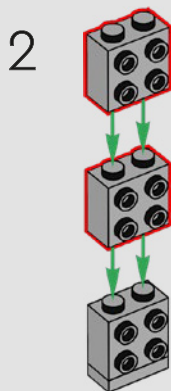
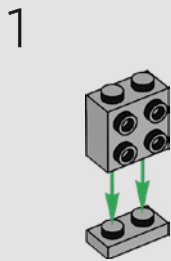

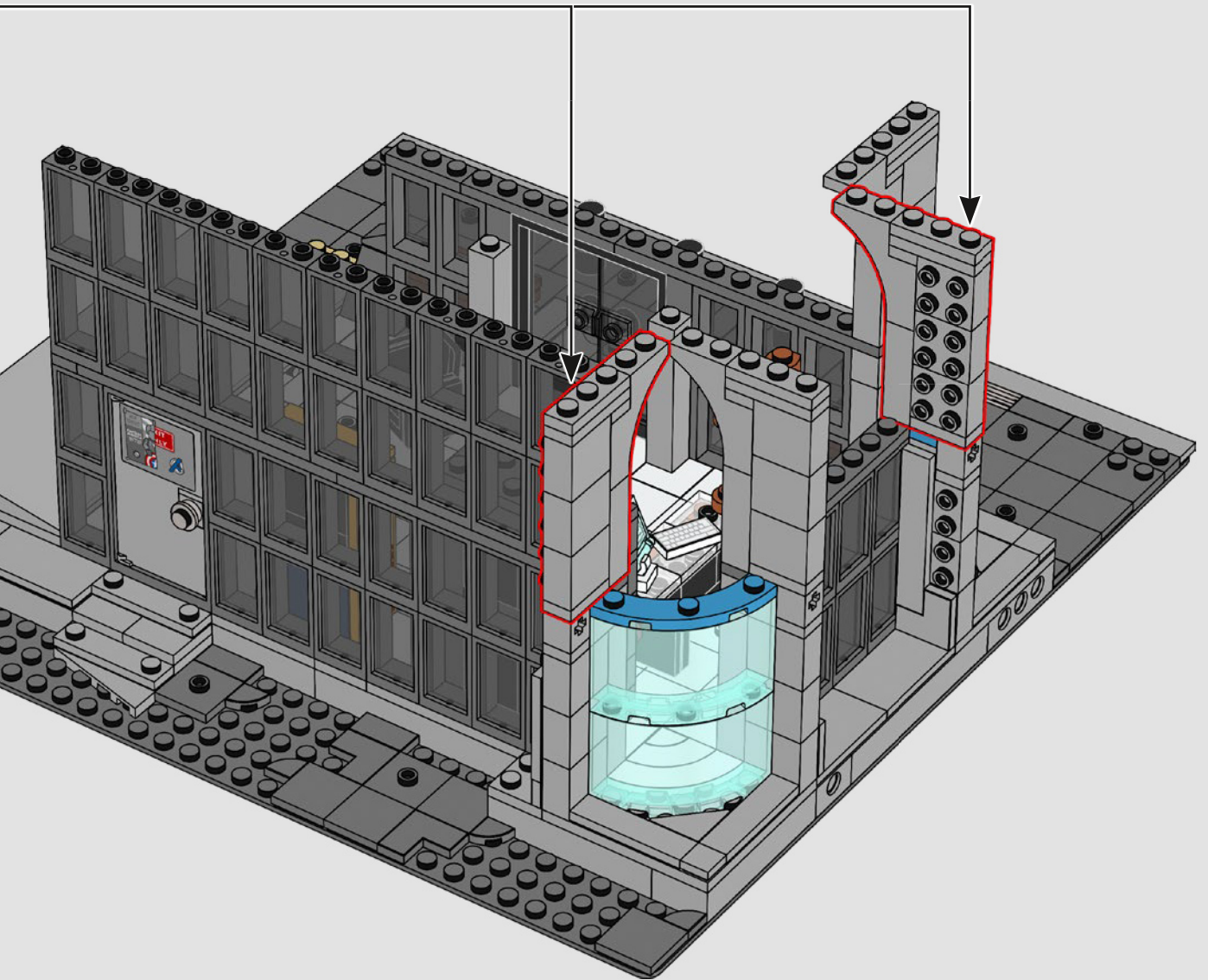

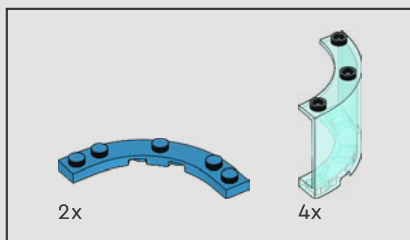

73

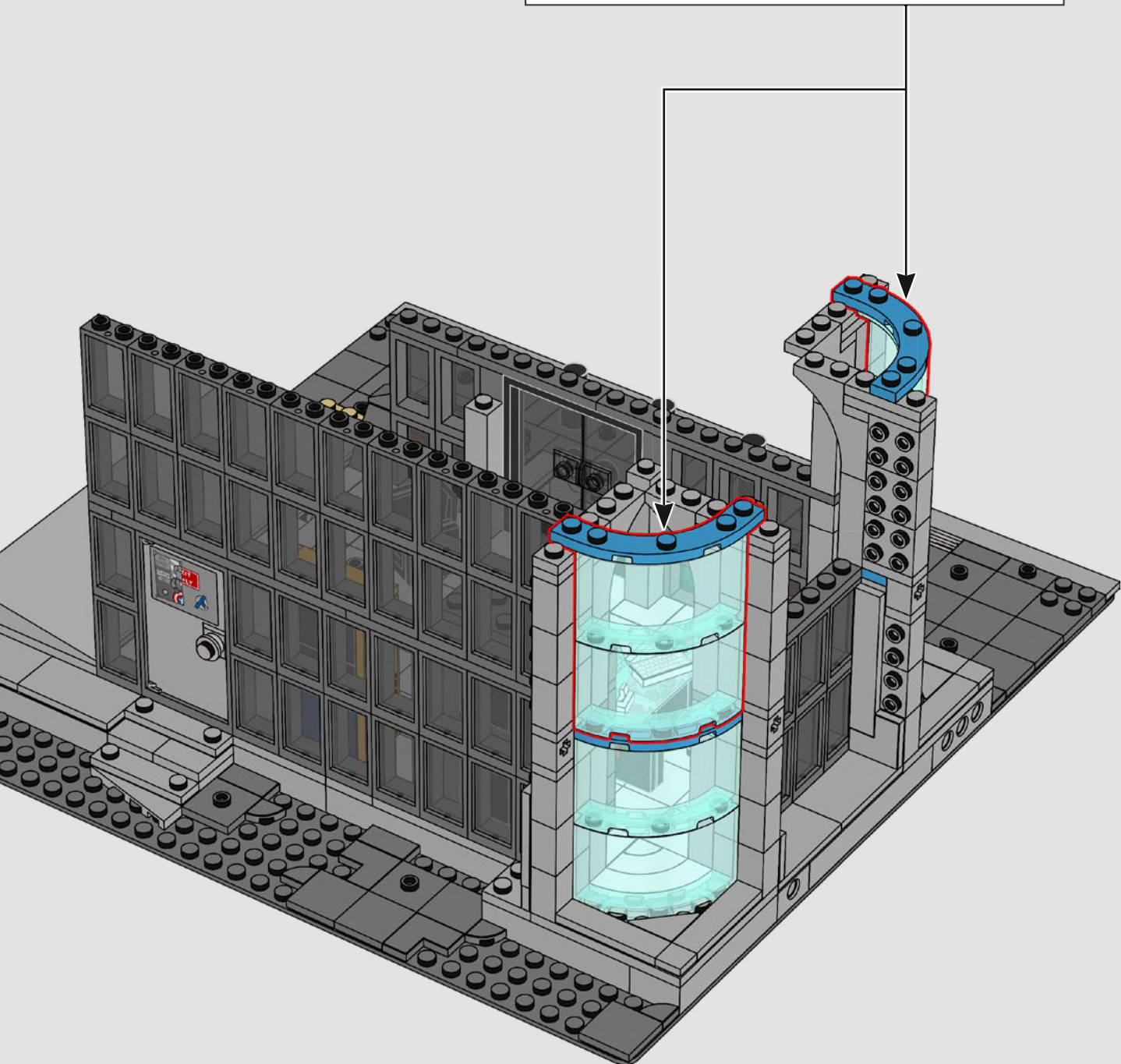
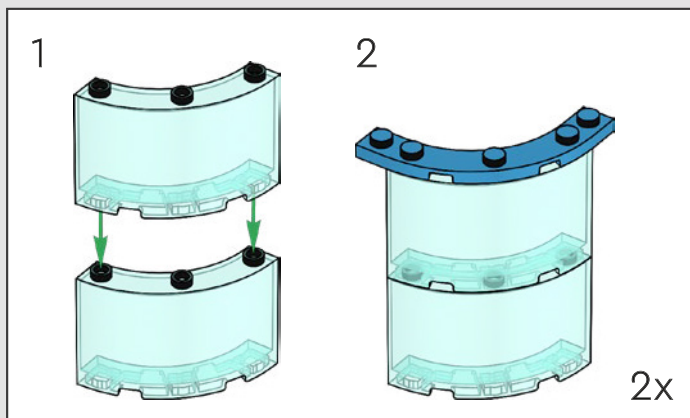

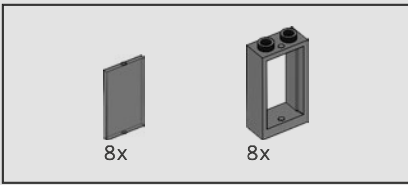

74

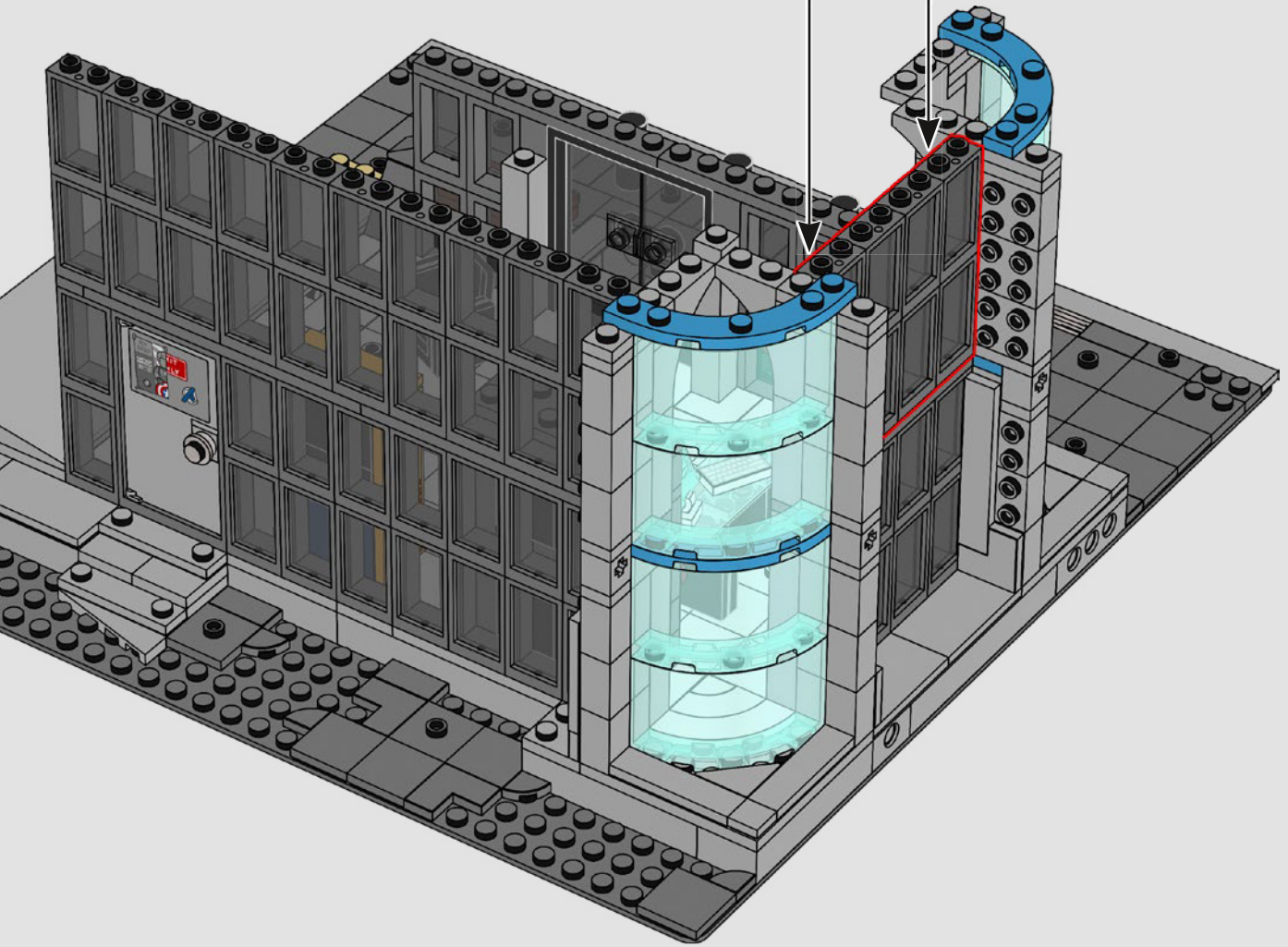
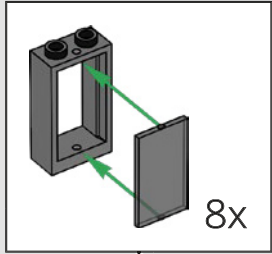

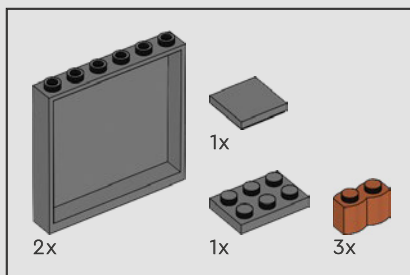

75

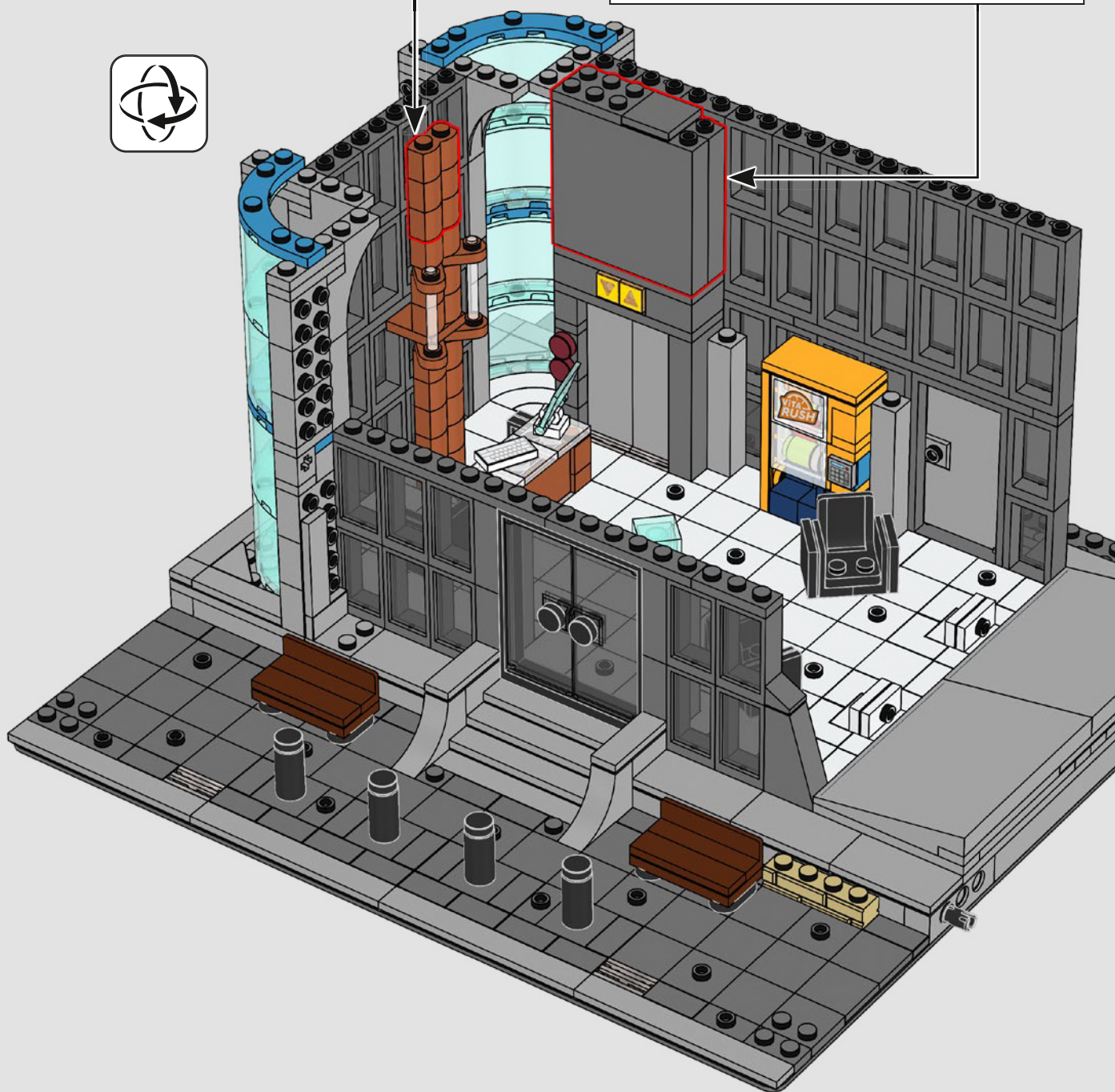
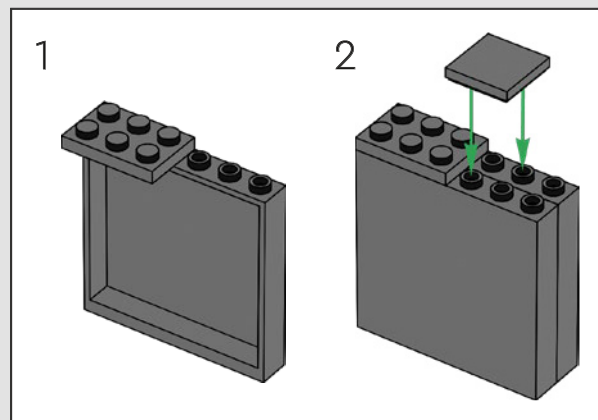
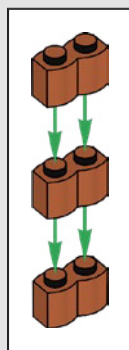

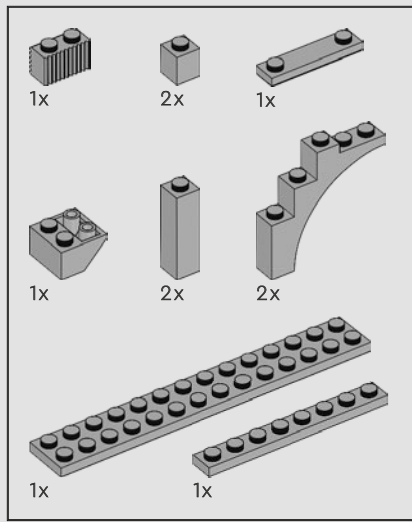

76

1

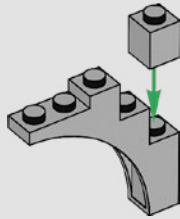

2

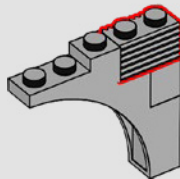

3

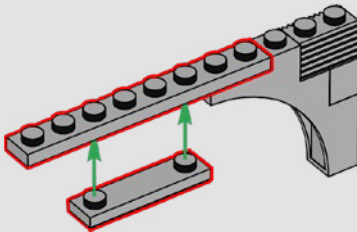

4

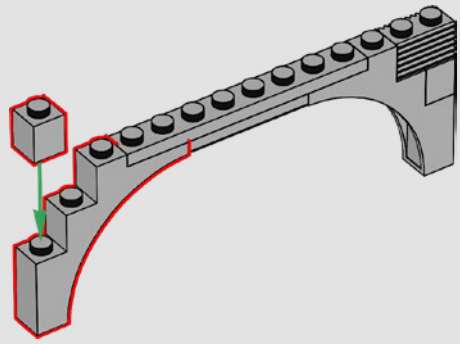

5

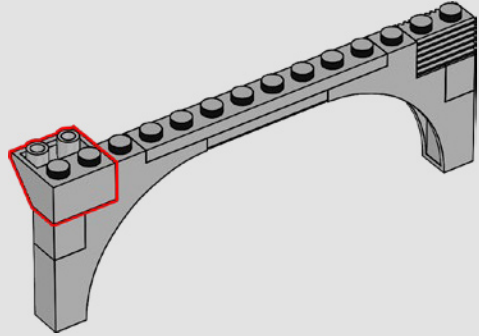

6

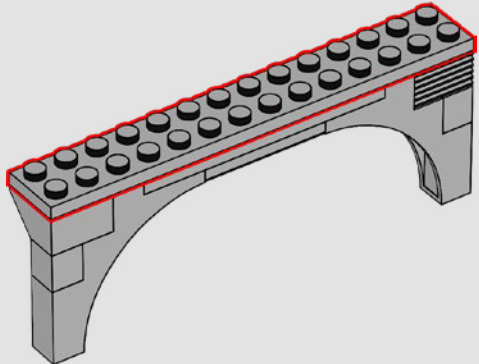

7

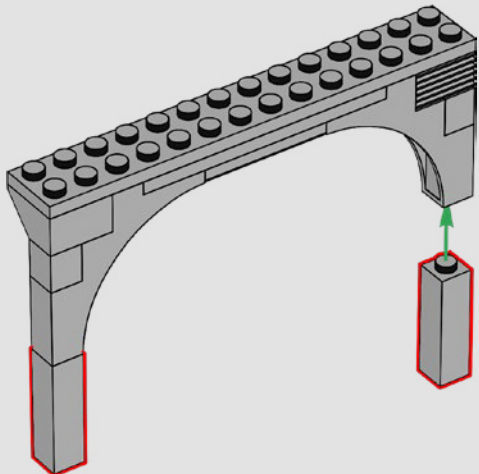

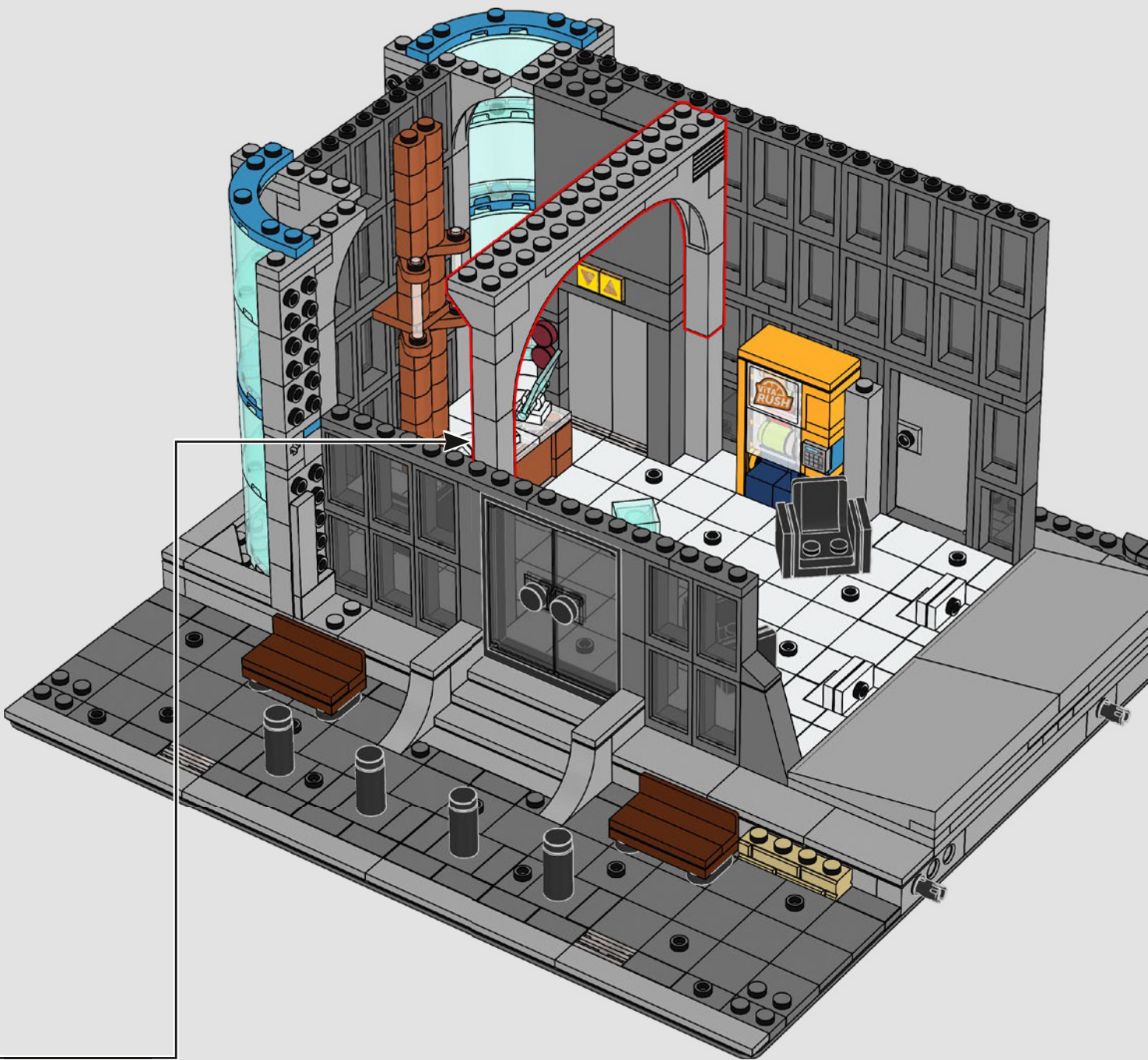

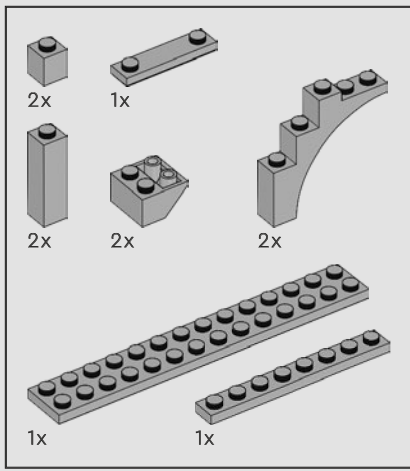

77

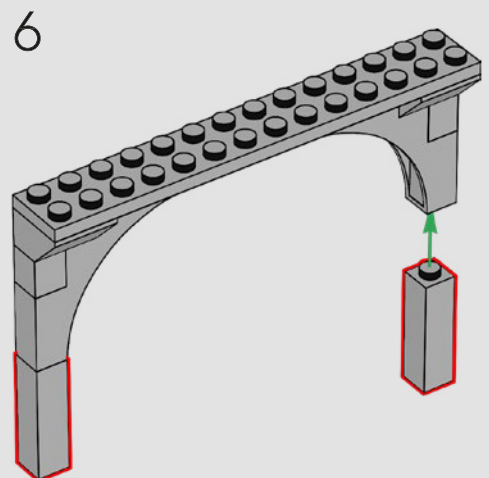
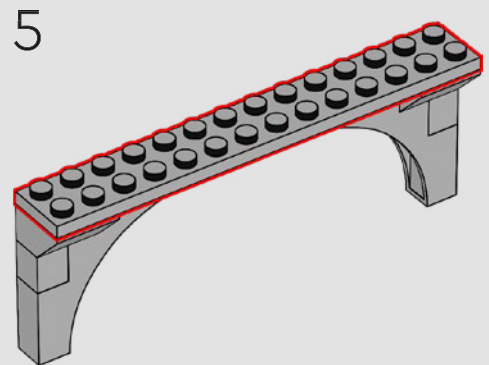
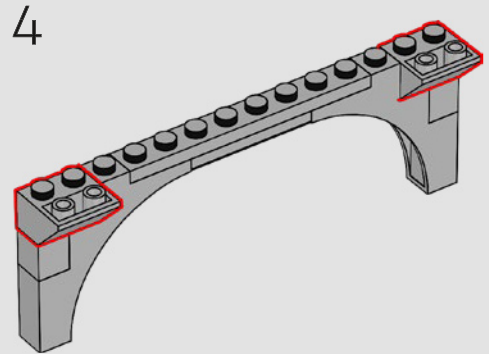
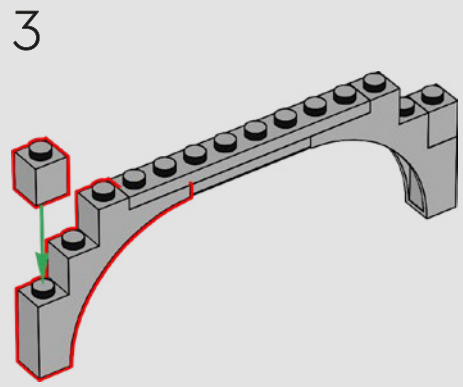
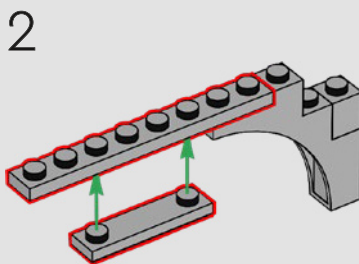
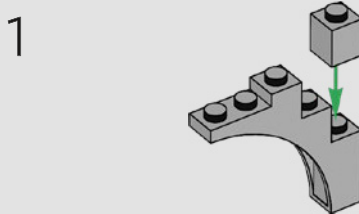

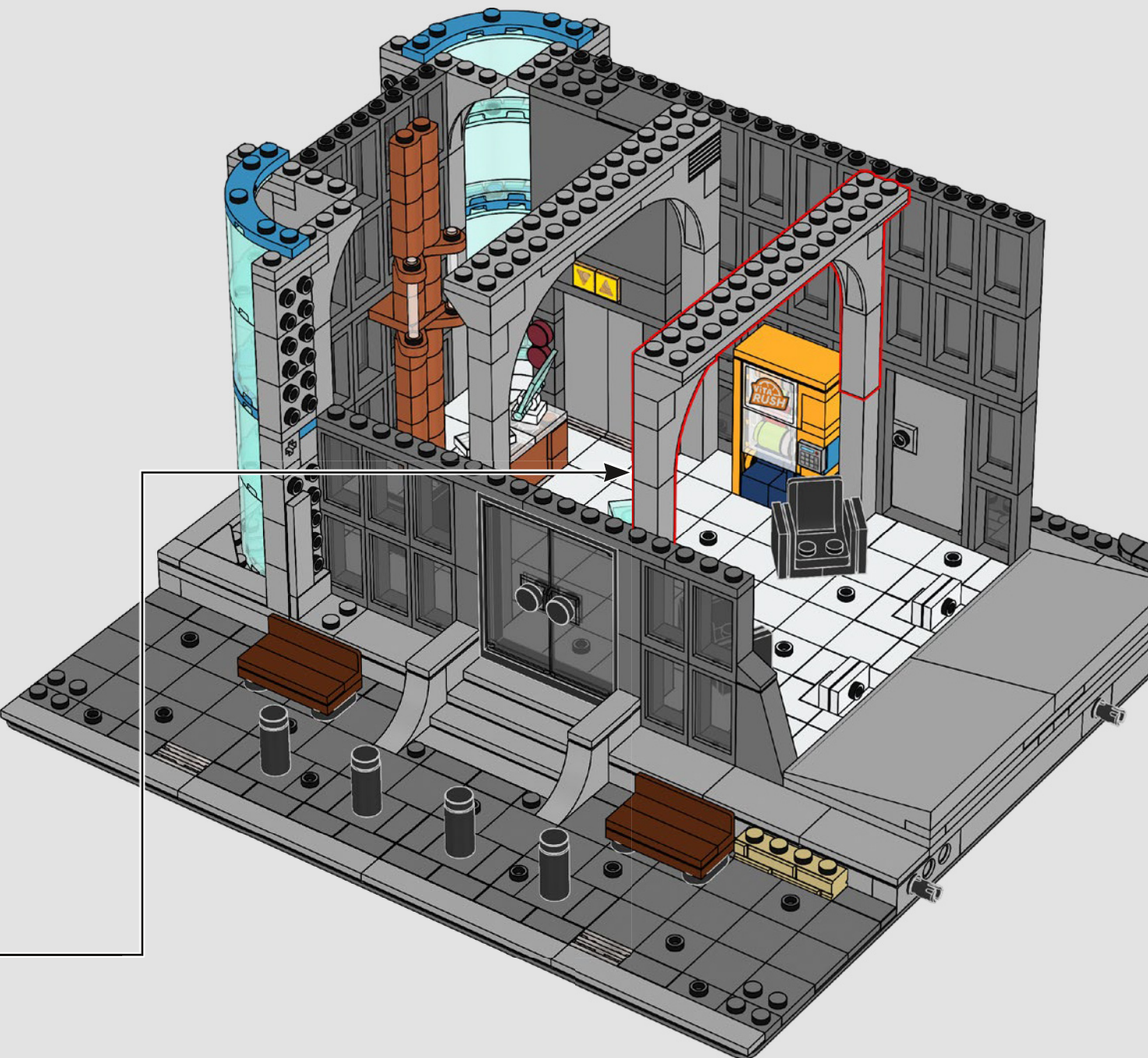

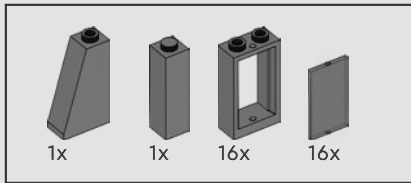

78

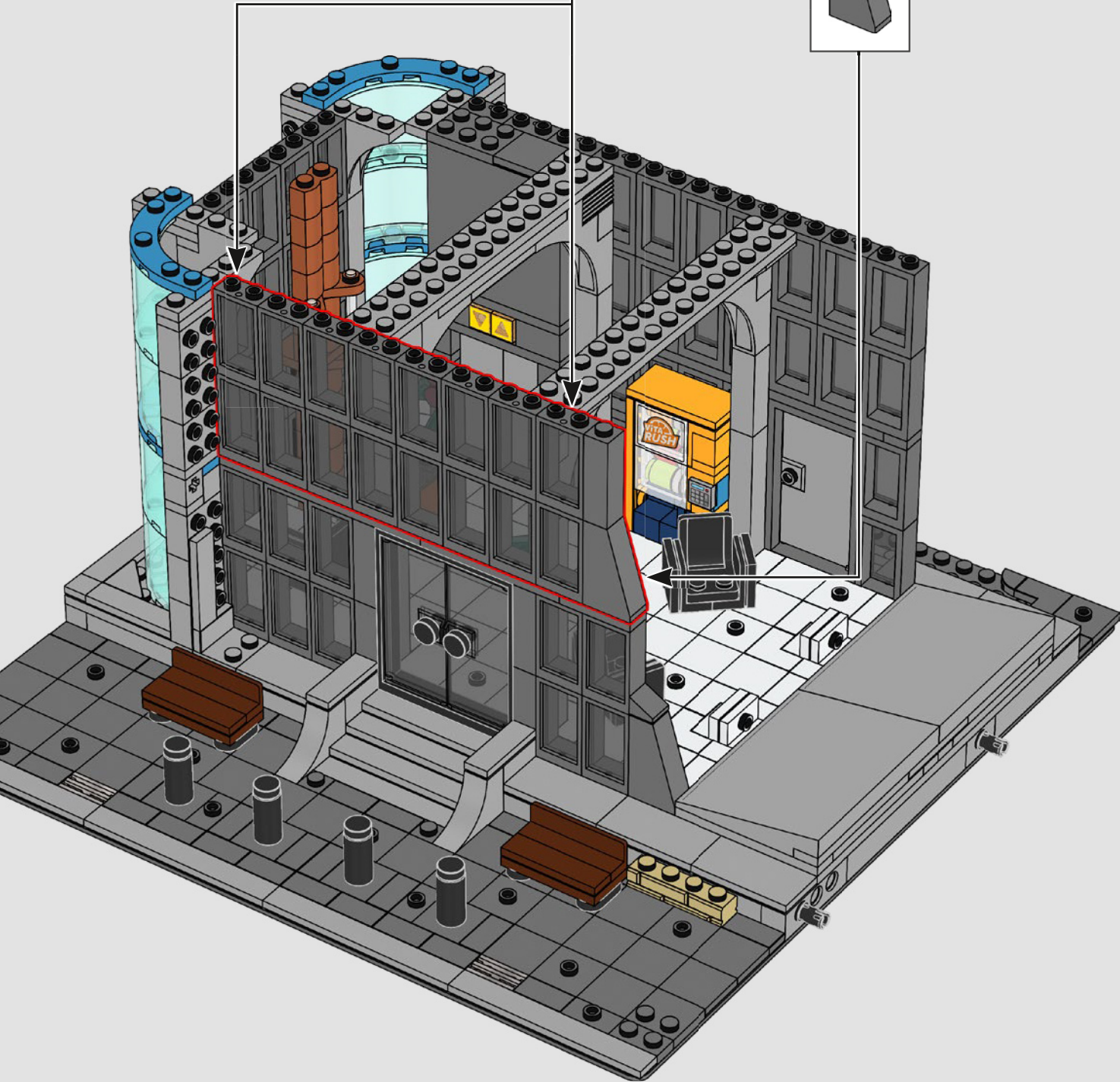
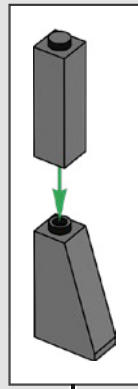
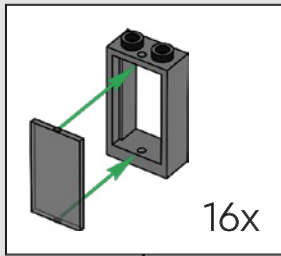

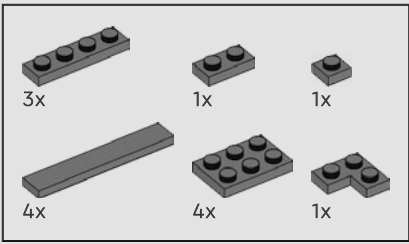

79

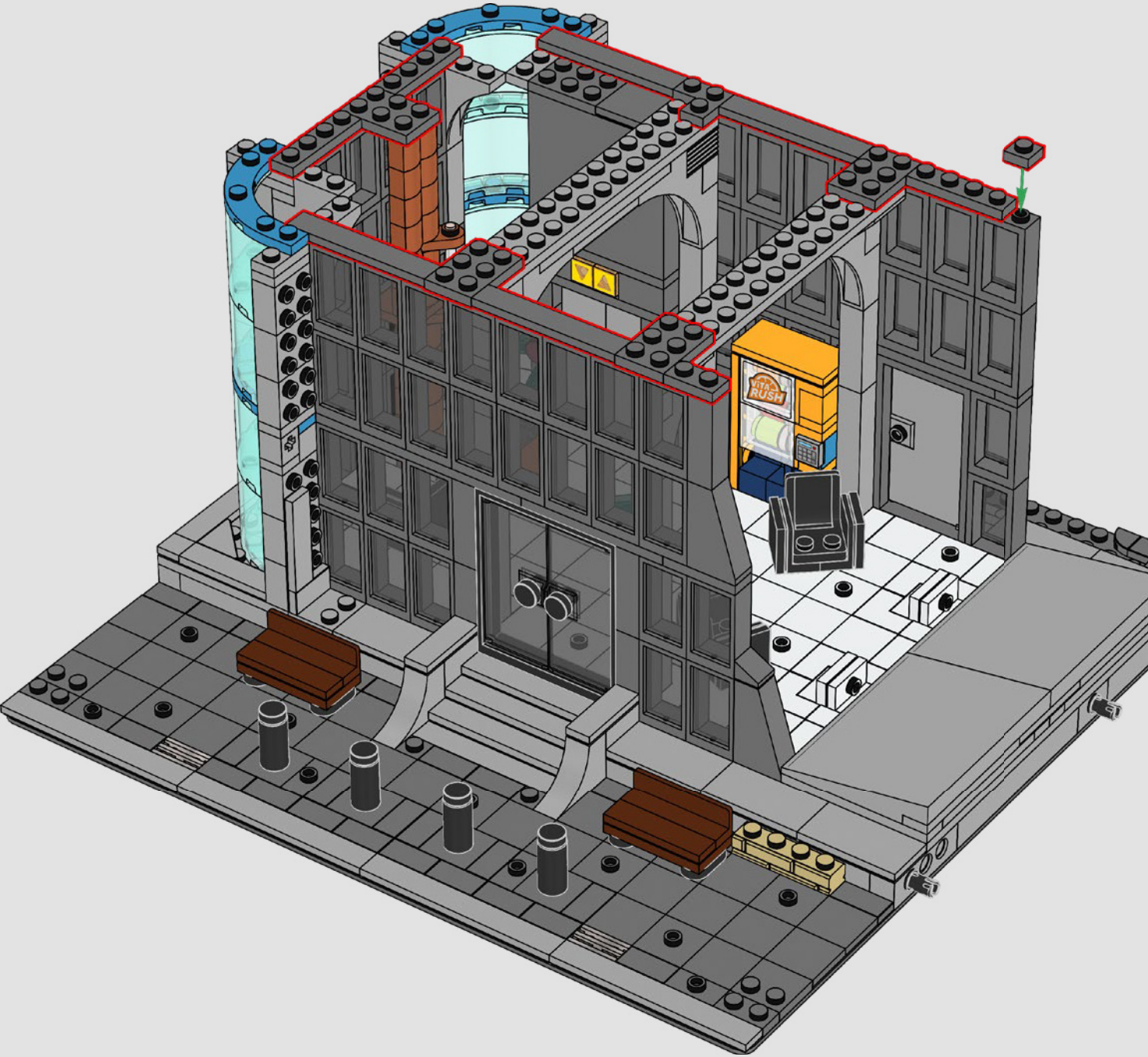

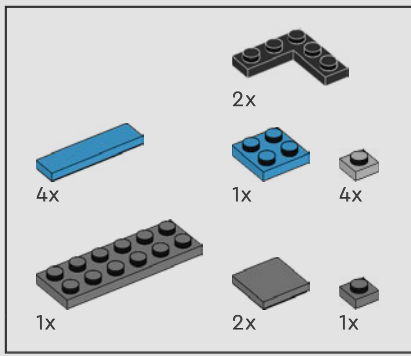

80

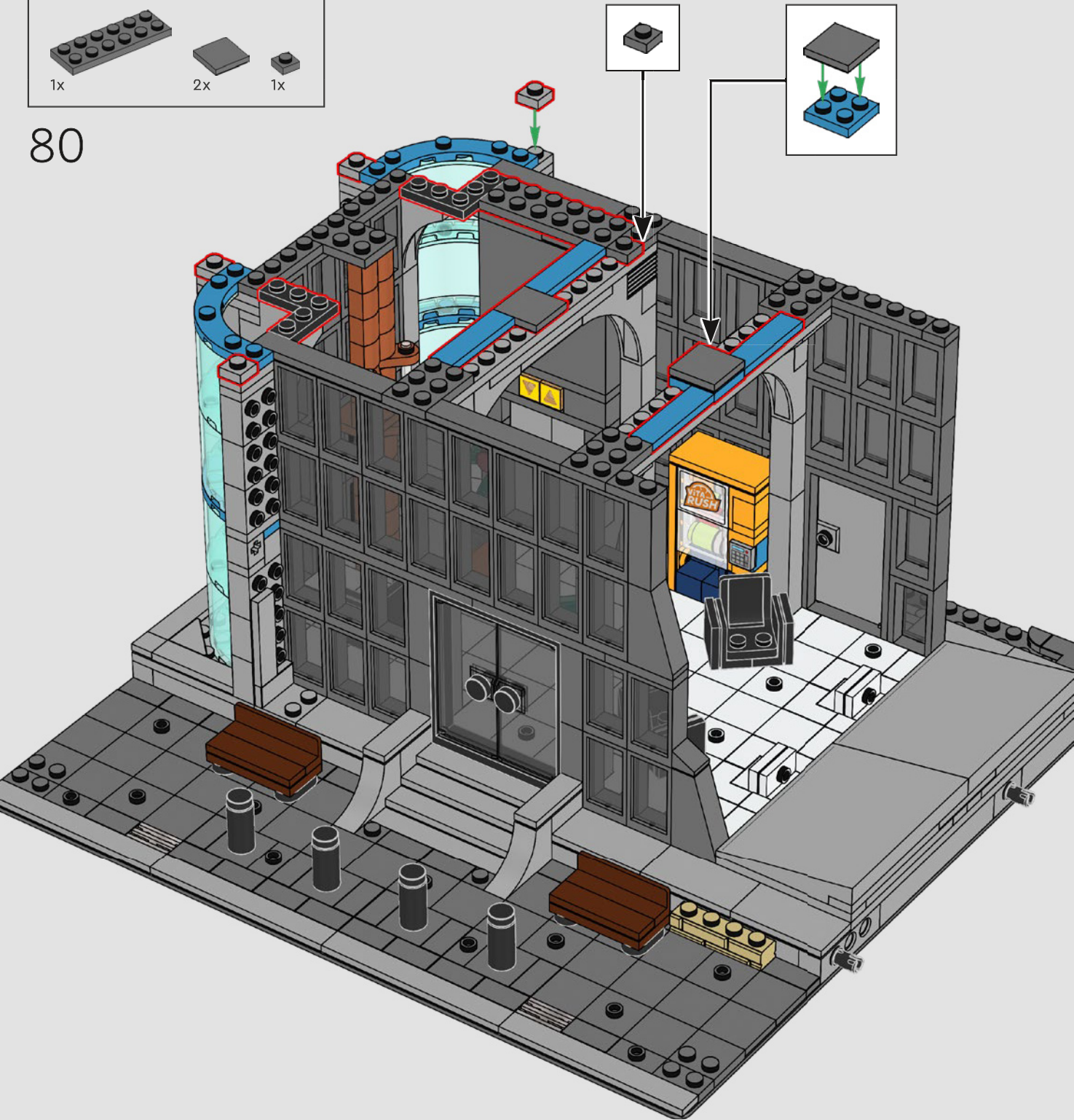

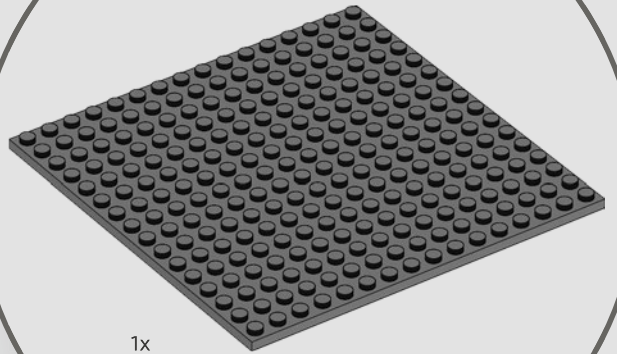
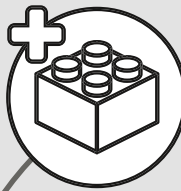

1x

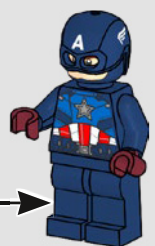
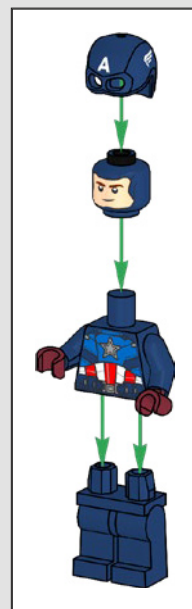
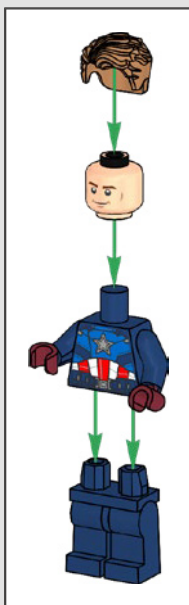
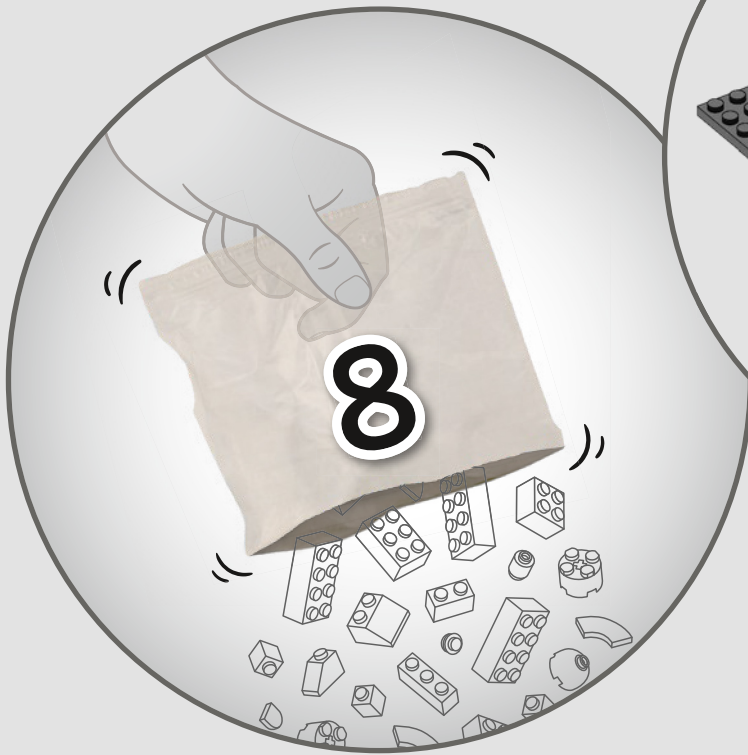

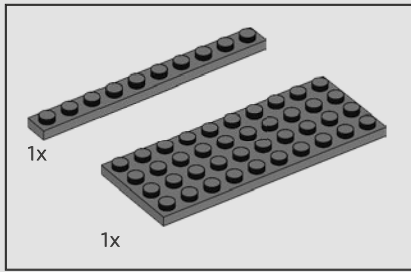
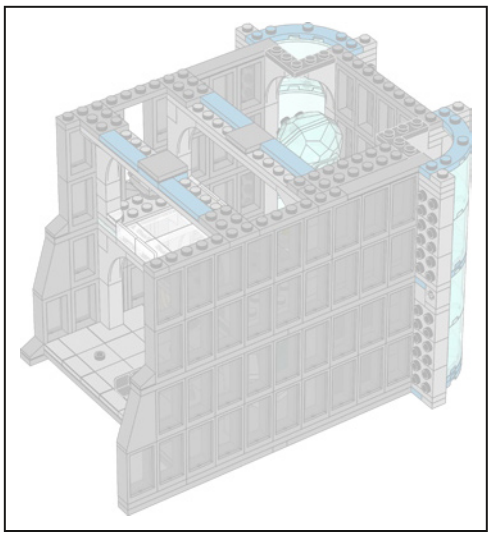

81

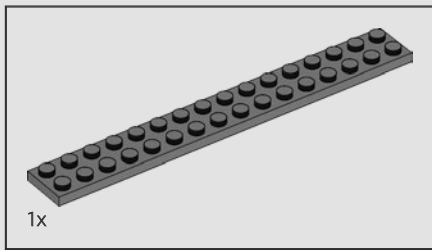
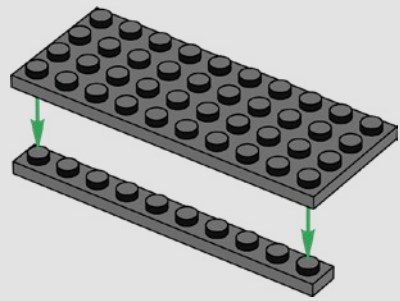

82

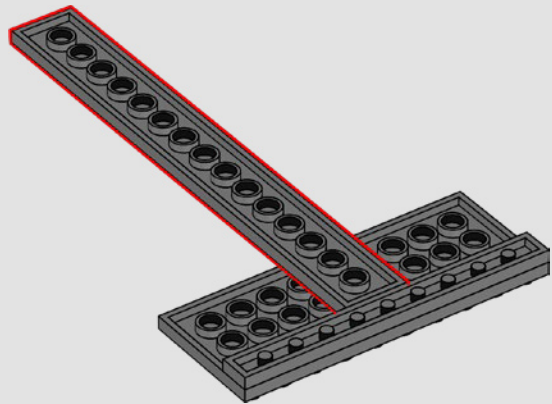

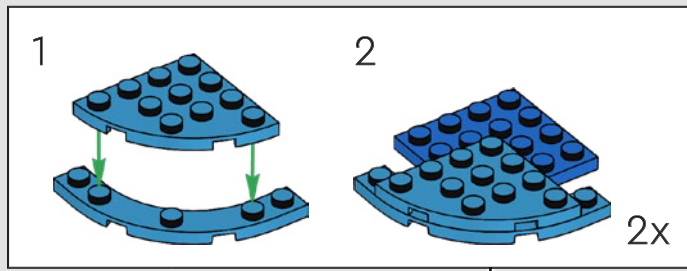
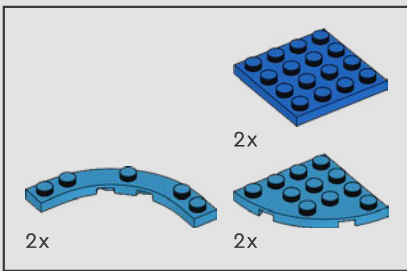

83

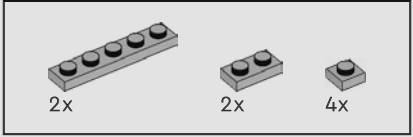
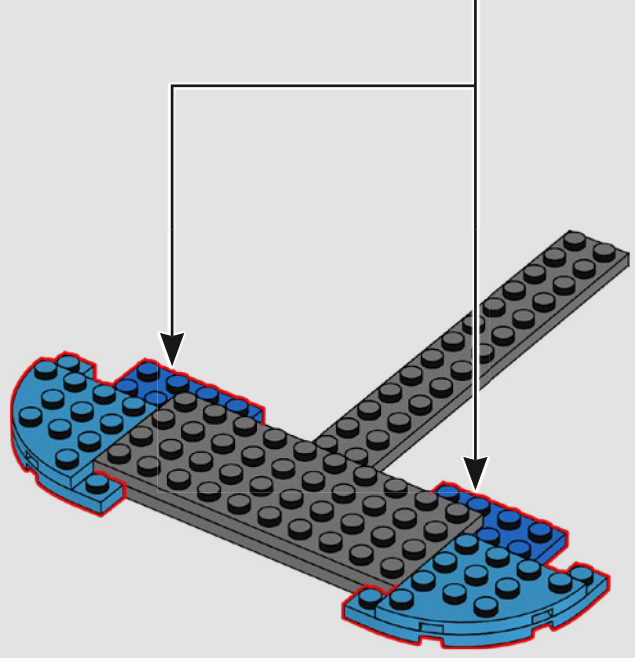

84

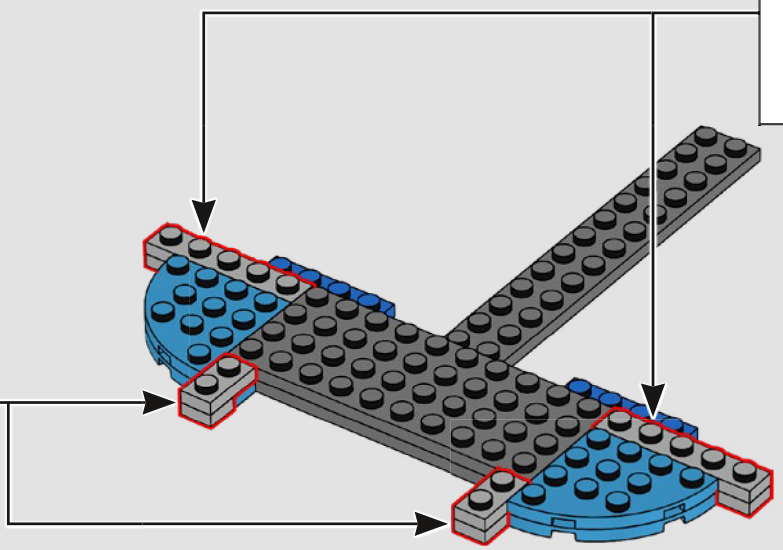
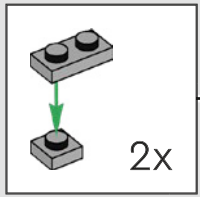
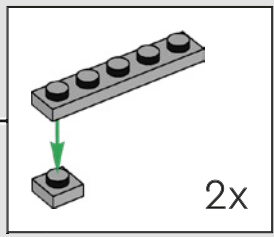

85

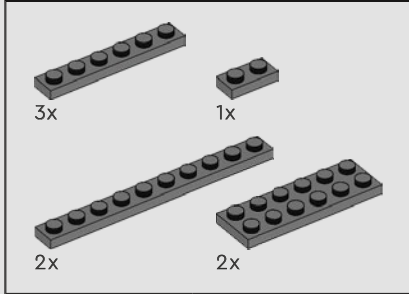
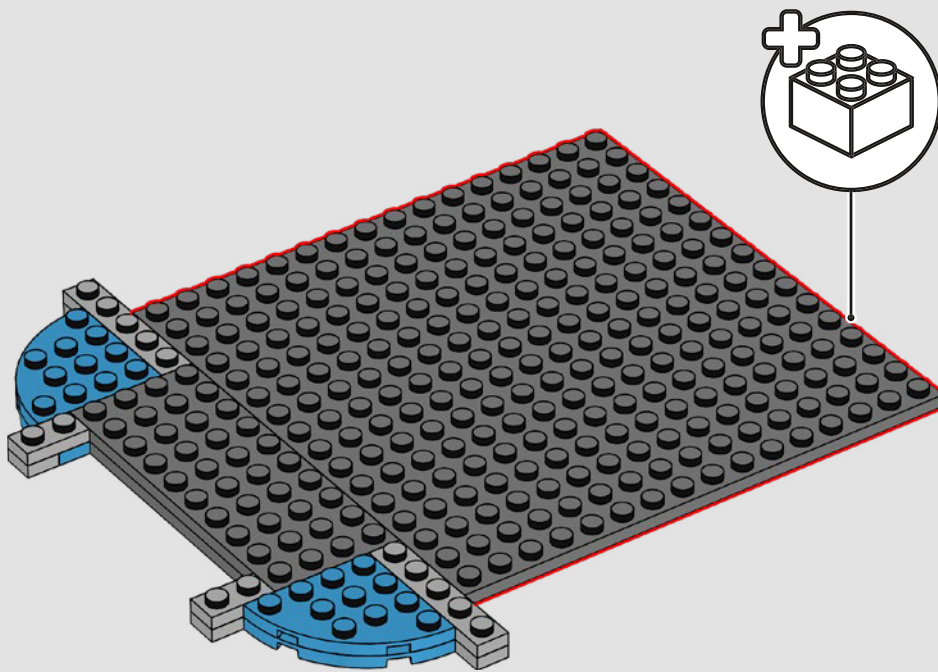

86

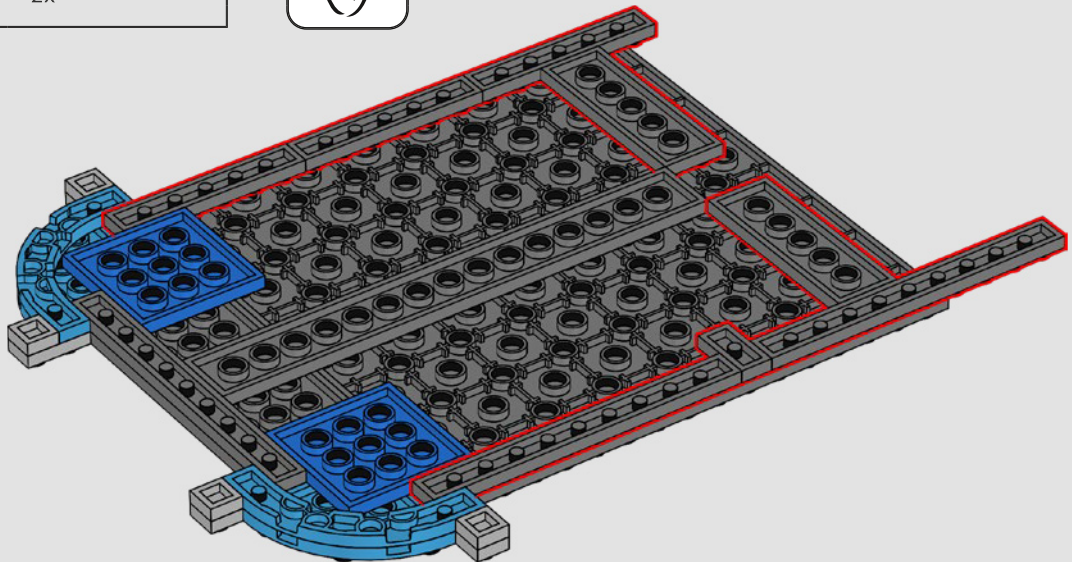

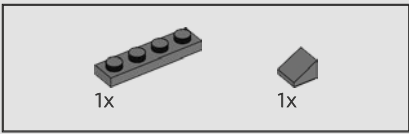

87

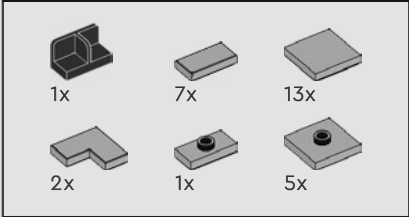
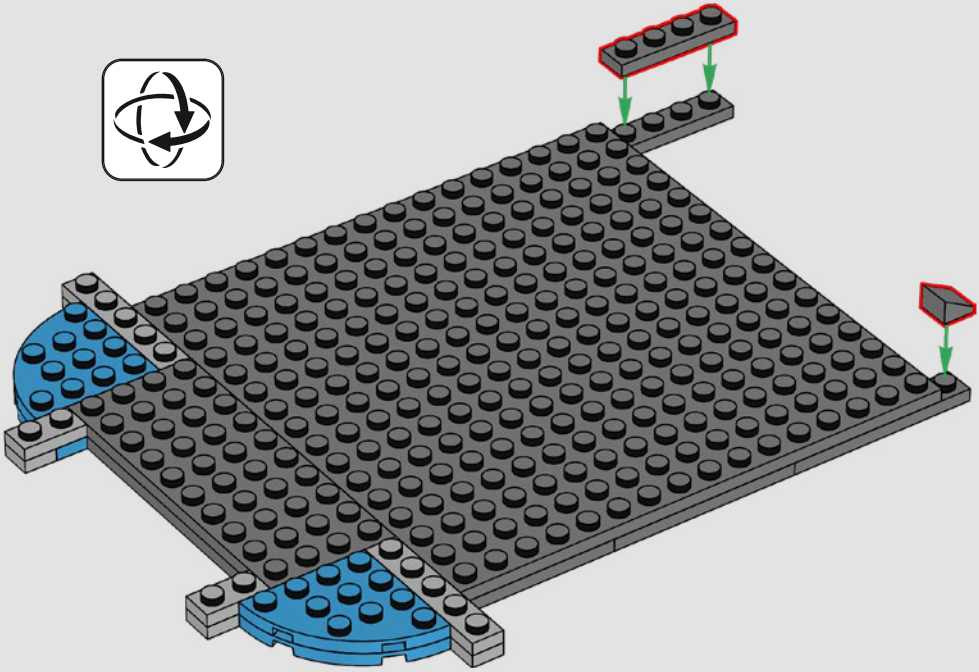

88

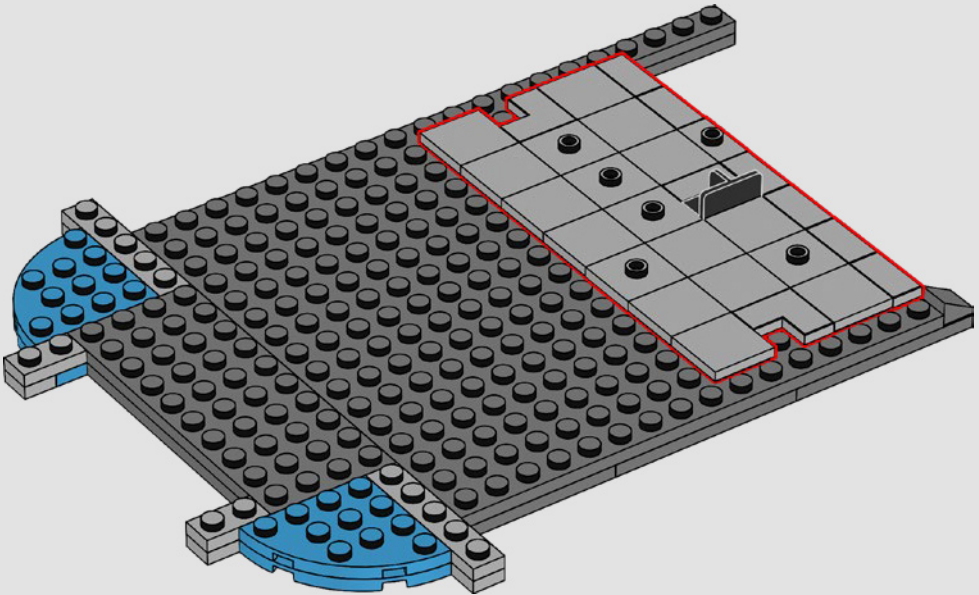

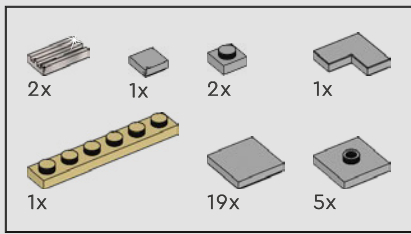

89

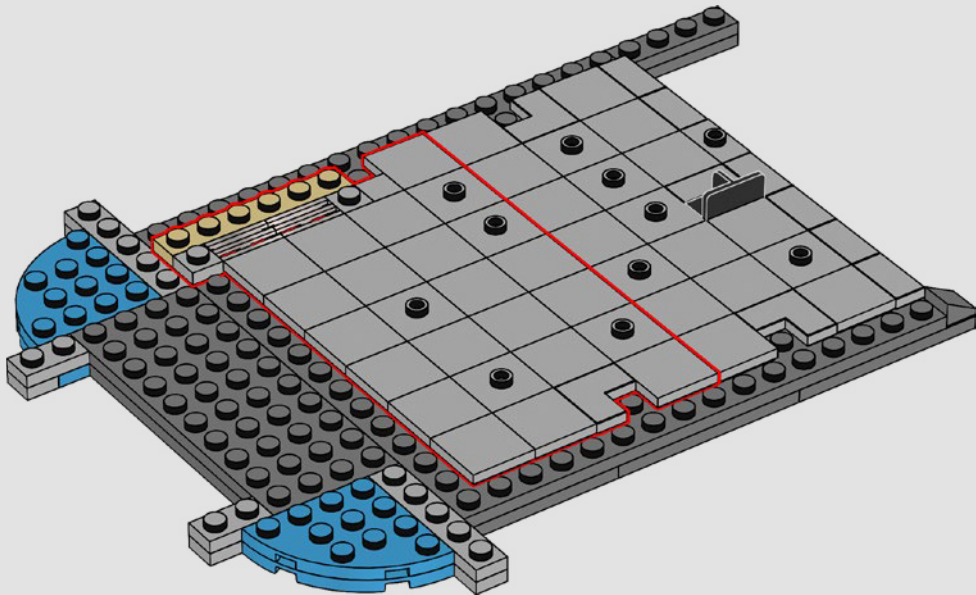

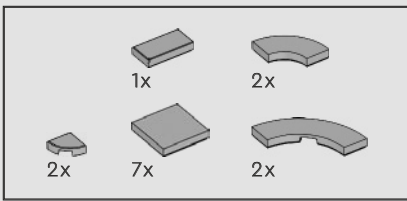

90

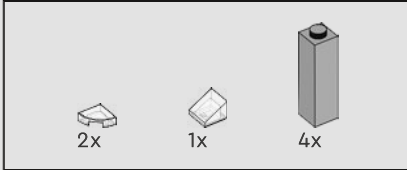
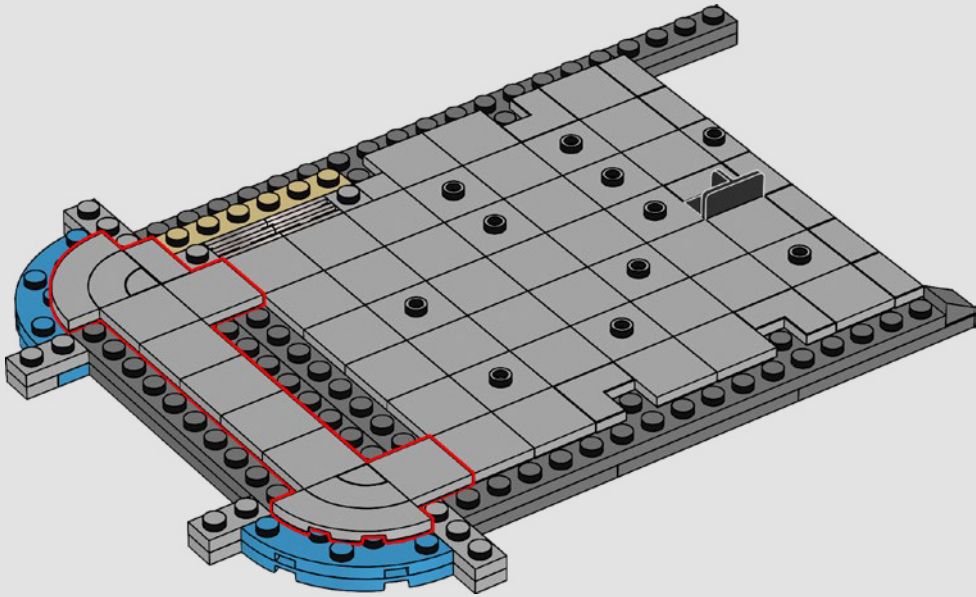

91

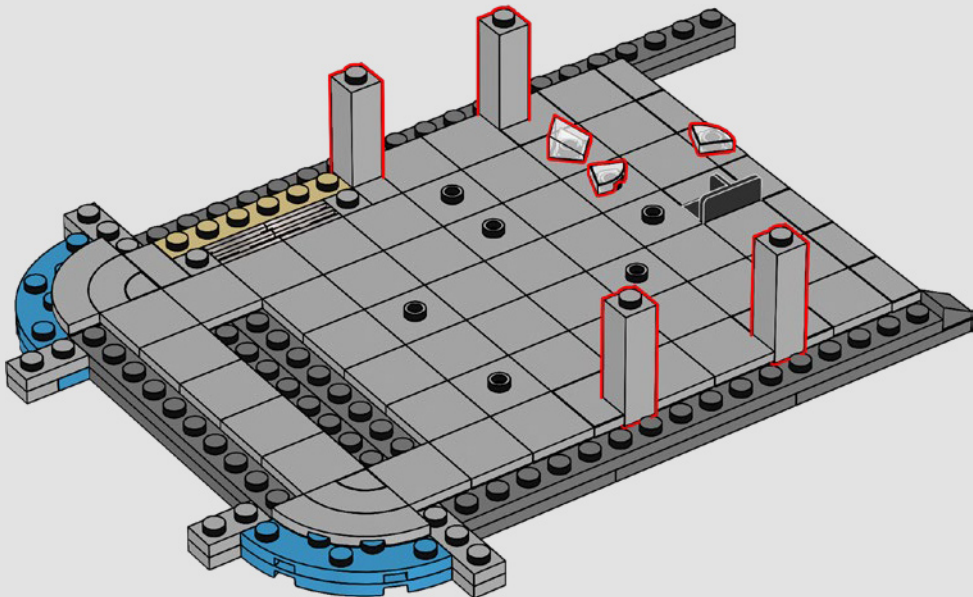

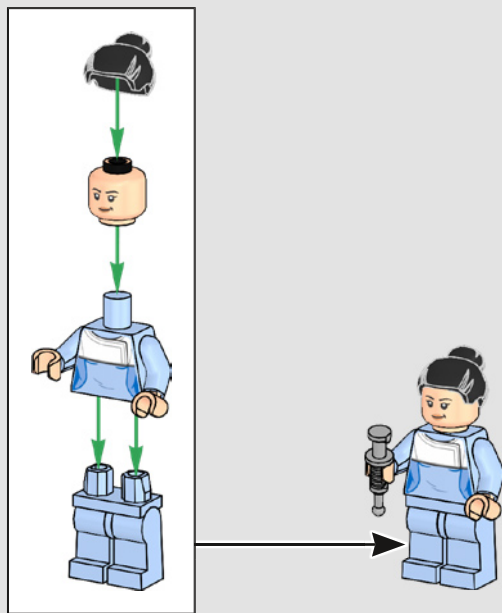

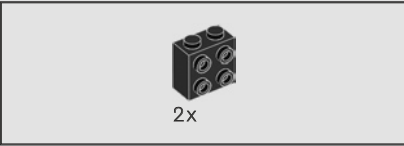
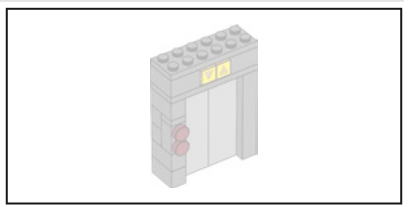

92

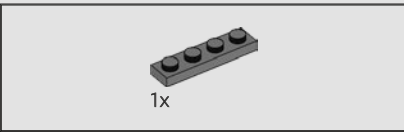
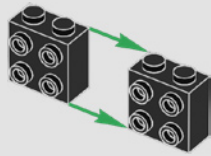

93

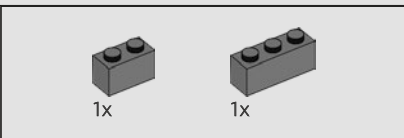

94

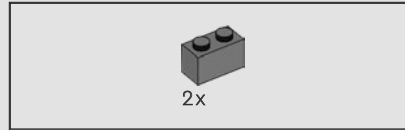
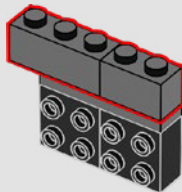

95

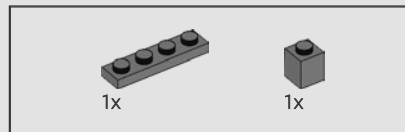
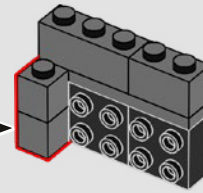
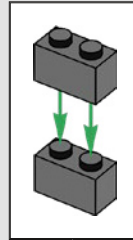

96

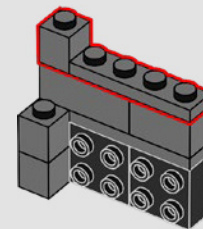

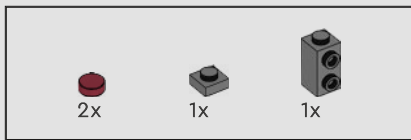

97

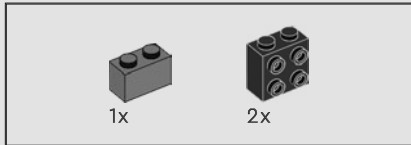
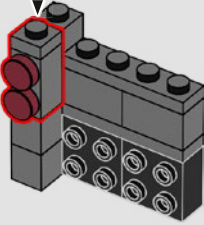
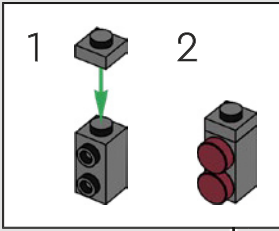

98

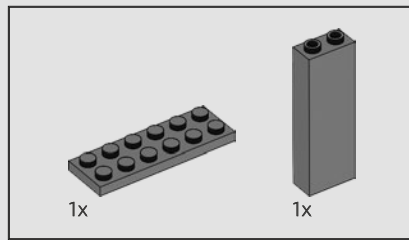
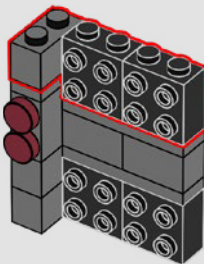

99

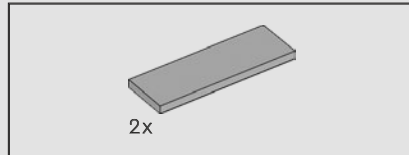
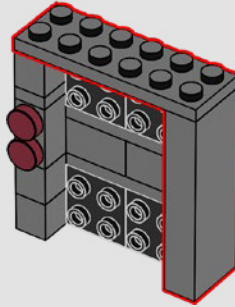

100

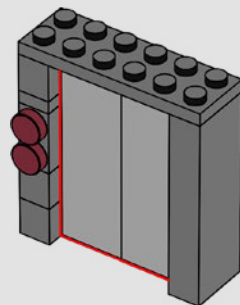

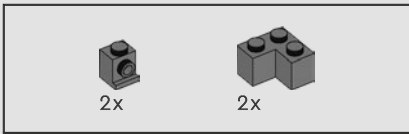

101

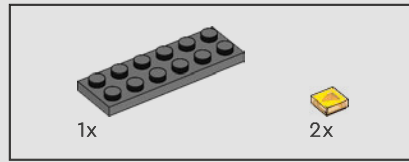
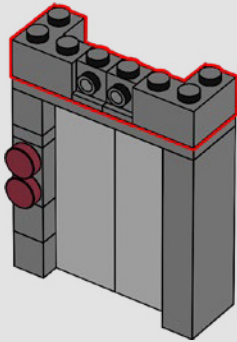

102

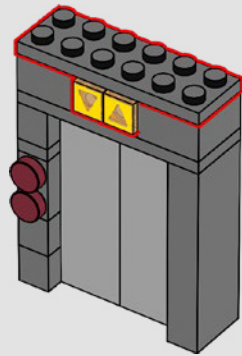

103

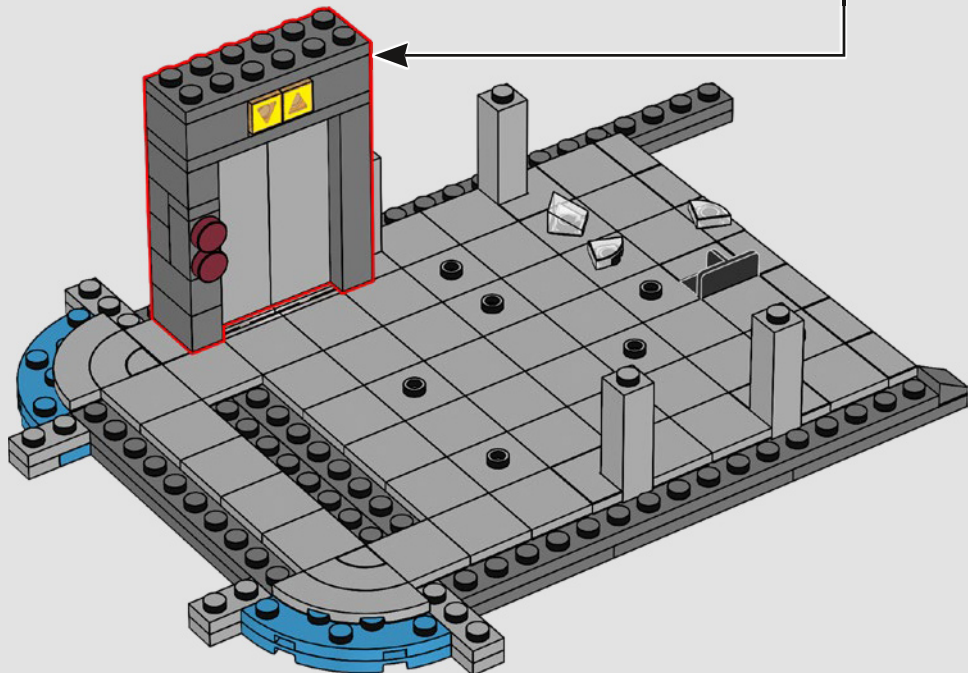

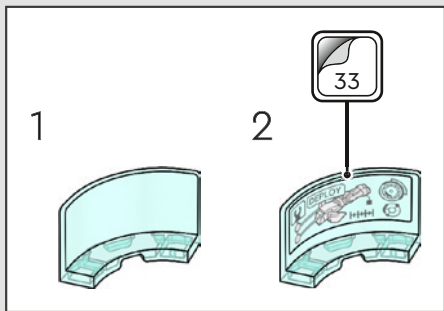
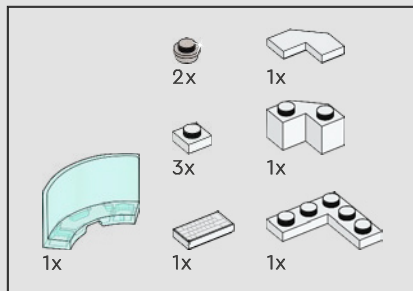

104

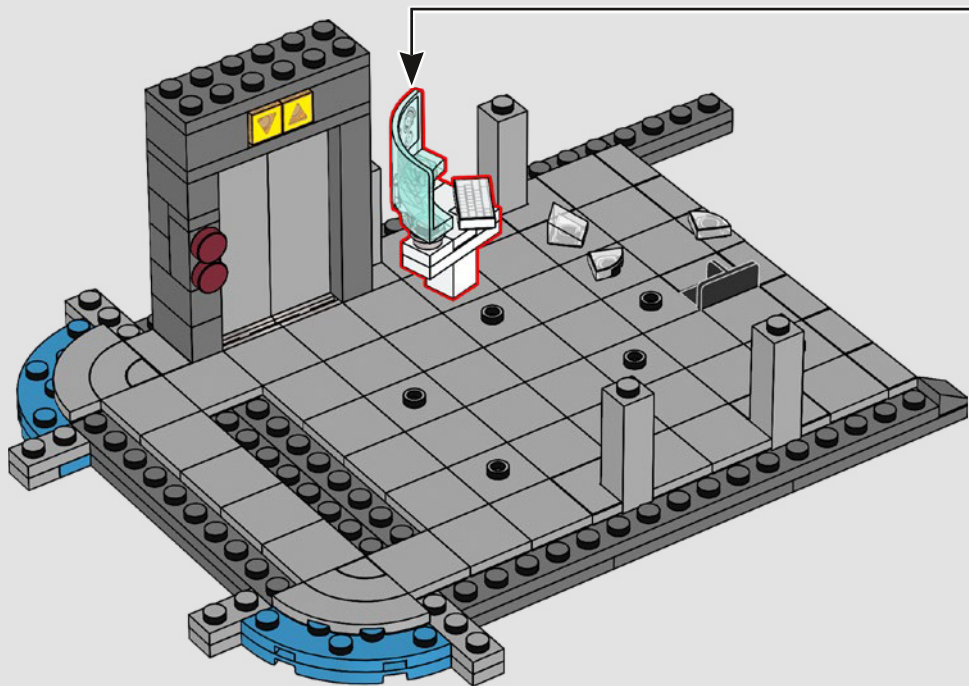
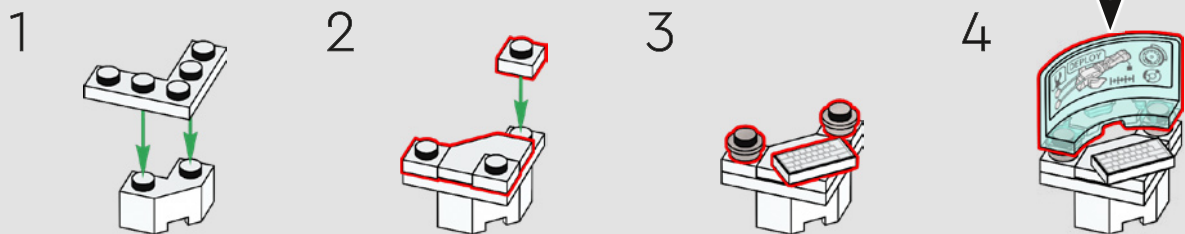

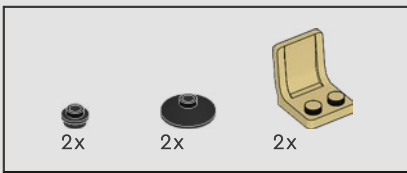

105

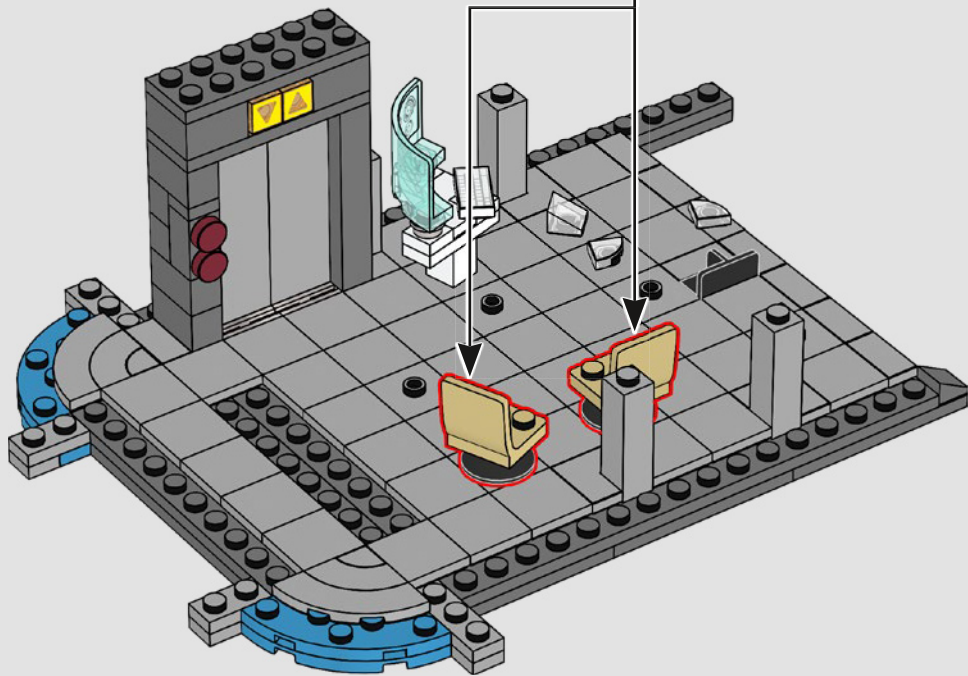
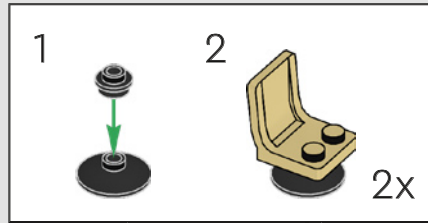

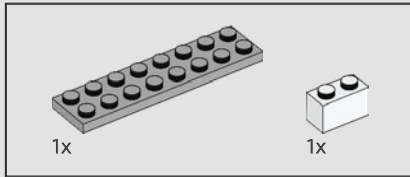
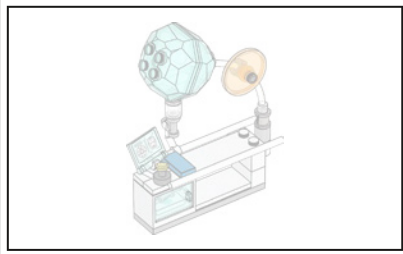

106

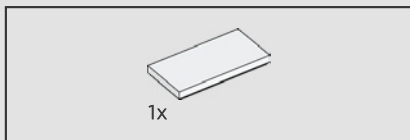
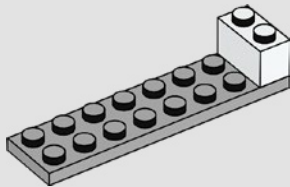

107

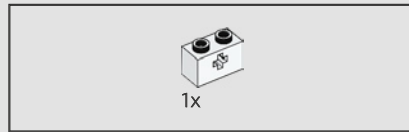
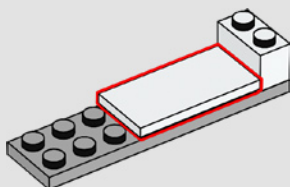

108

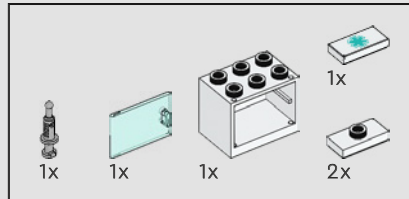
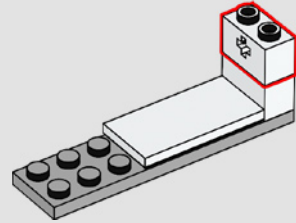

109

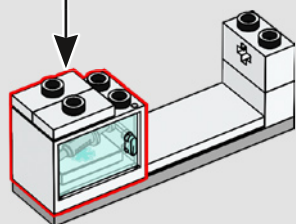
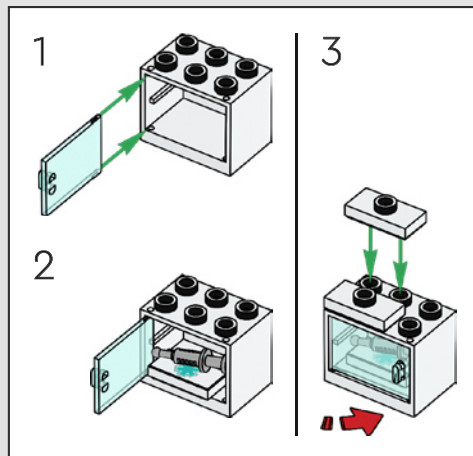

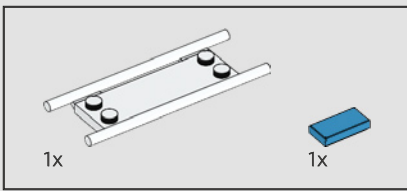

110

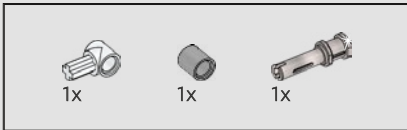
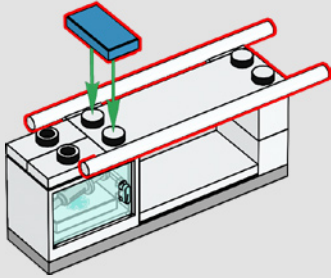

111

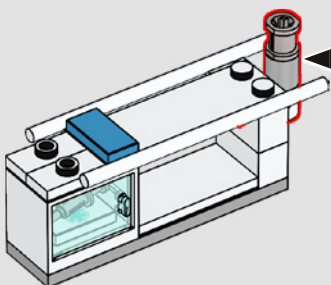
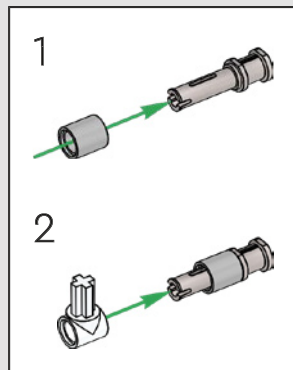

112

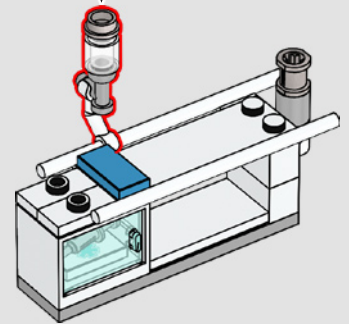
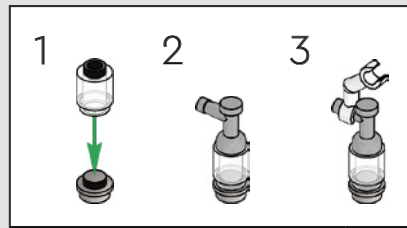

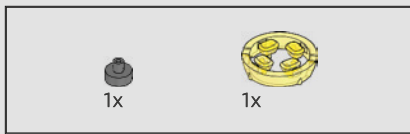

113

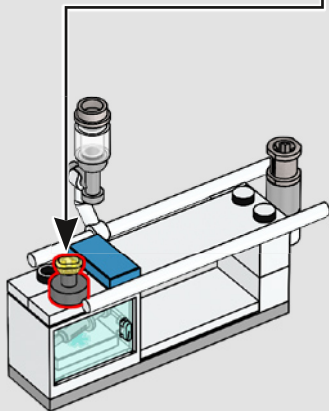
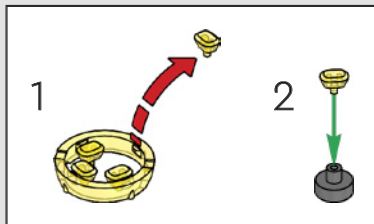

114

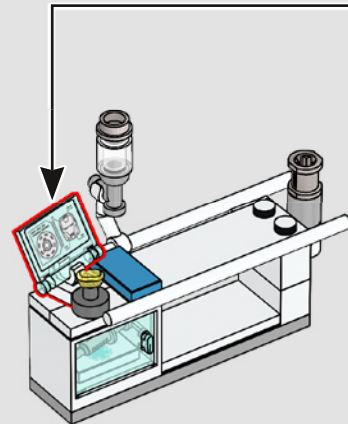
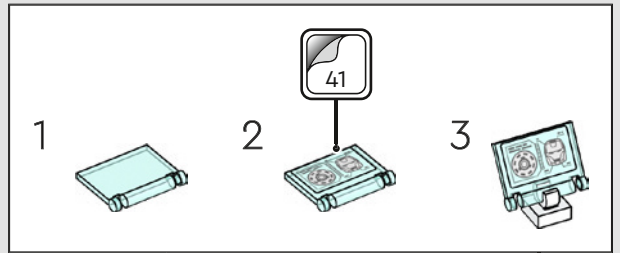

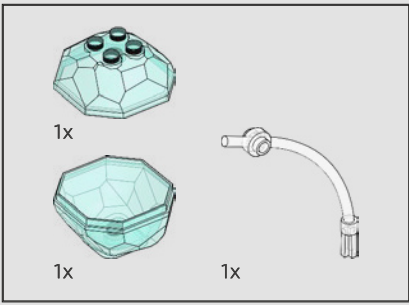

115

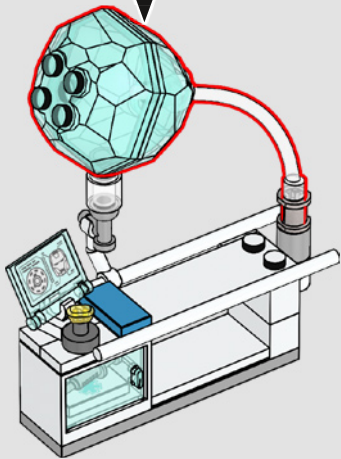
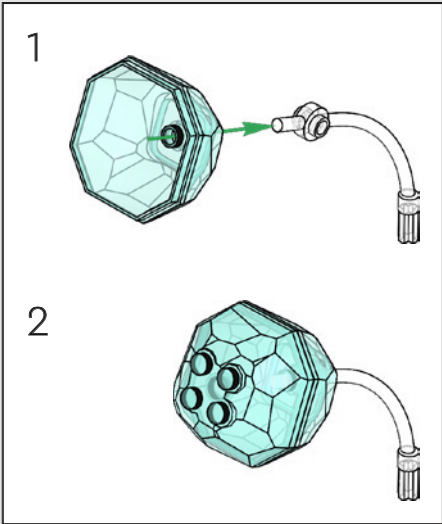

116

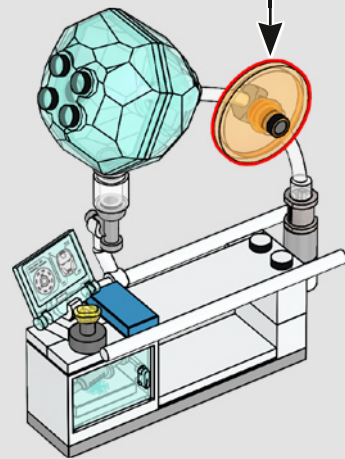
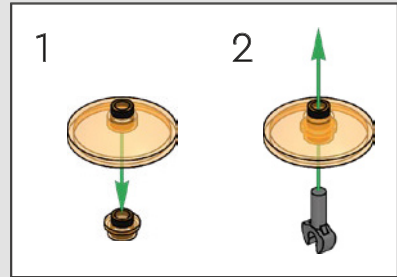

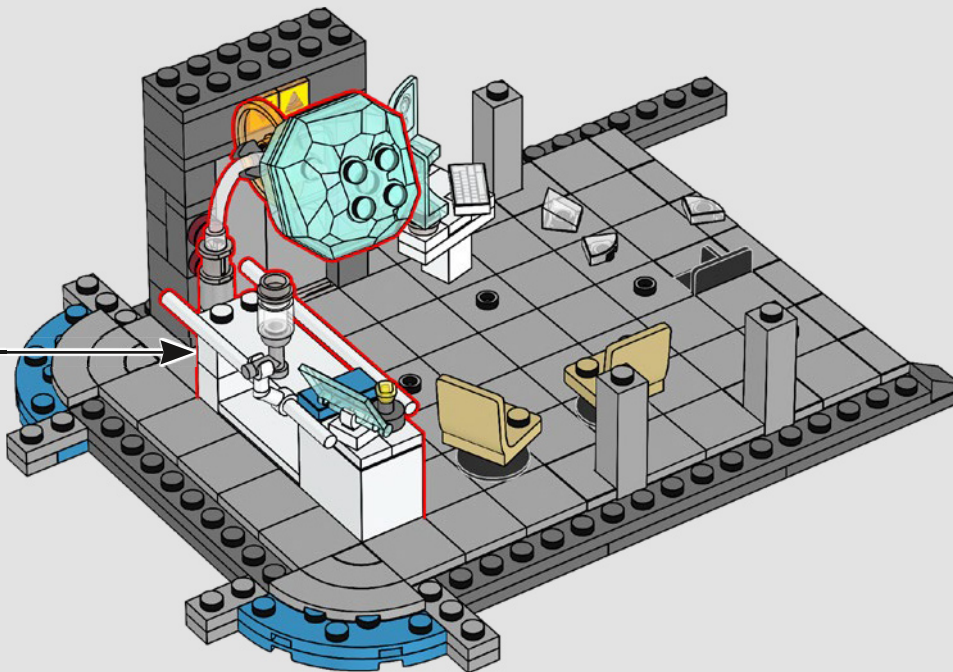

"I am a program. I am without form."
As Ultron and J.A.R.V.I.S. battle over
how to achieve peace in our time,
Dr. Cho's scientific inventions will
result in dire consequences.

« Je suis un programme. Je suis sans forme. »
Comme Ultron et J.A.R.V.I.S. ne s'entendent
pas sur la façon d'instaurer la paix à notre
époque, les inventions scientifiques du
Dr Cho auront des conséquences
désastreuses.

"Soy un programa. No tengo forma física".
Mientras Ultrón y J.A.R.V.I.S. debatían
sobre cómo alcanzar la paz en nuestro
tiempo, los inventos científicos de la
Dra. Cho daban lugar a consecuencias
nefastas.

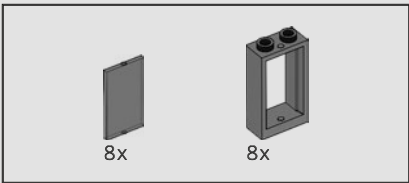

118

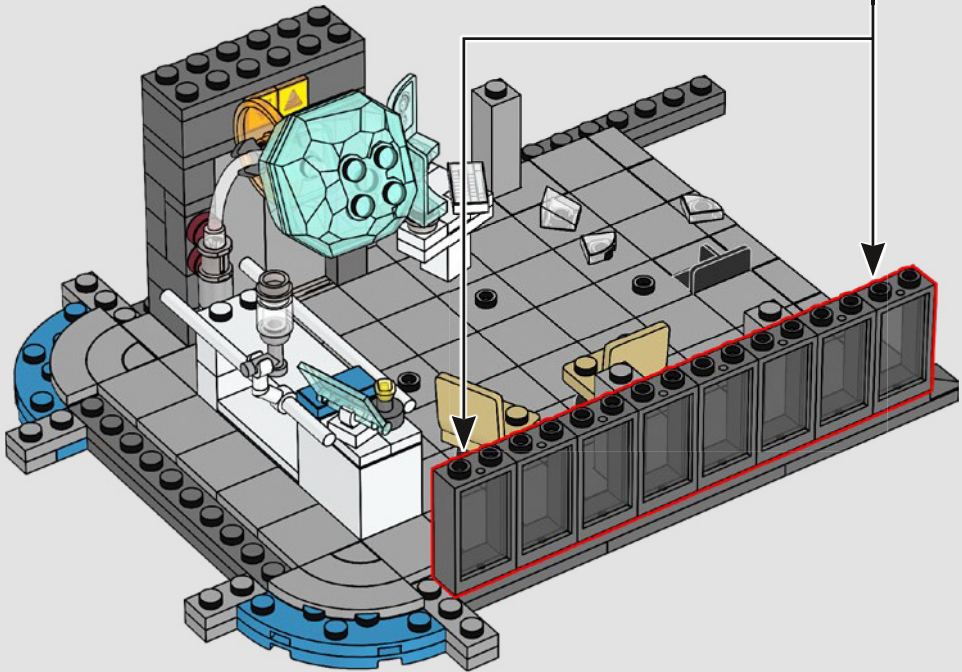
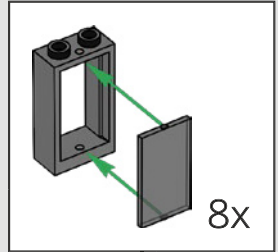

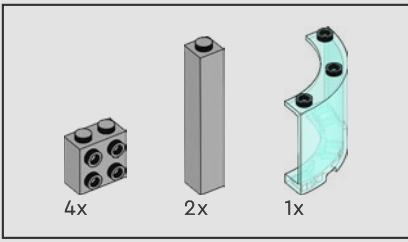

119

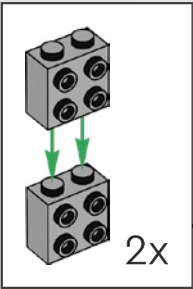
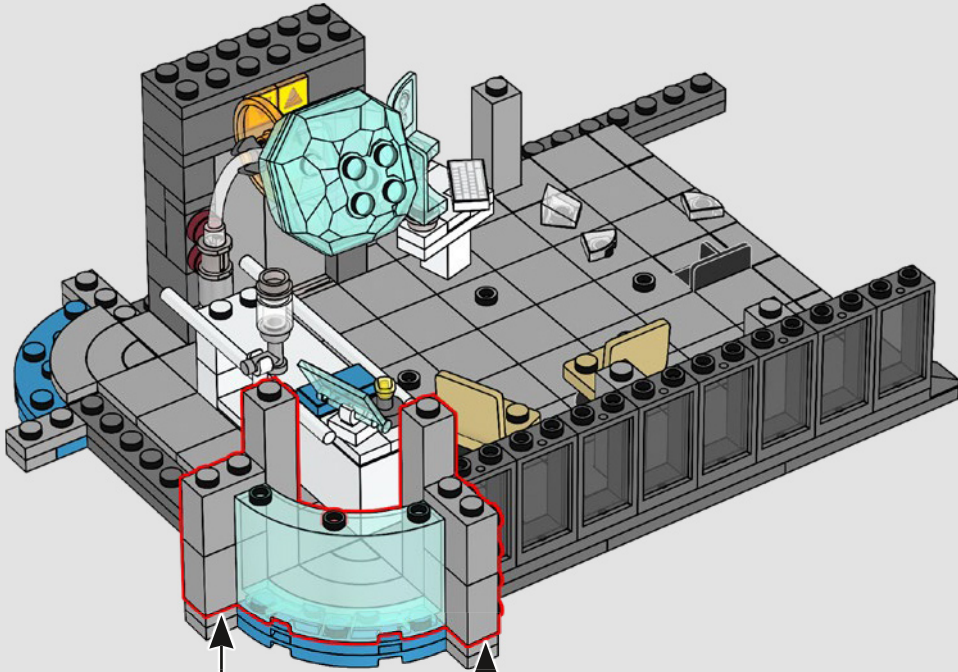

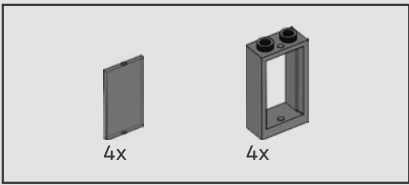

120

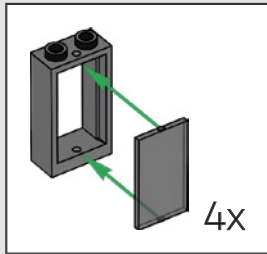
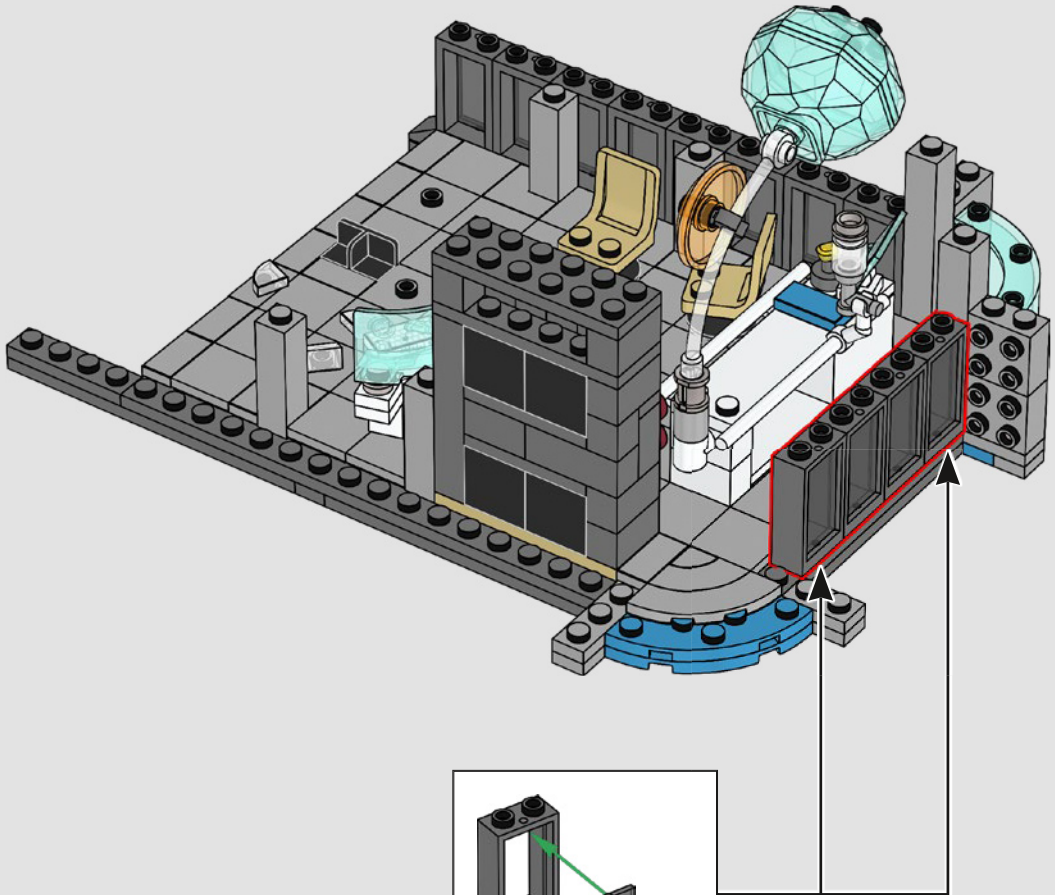

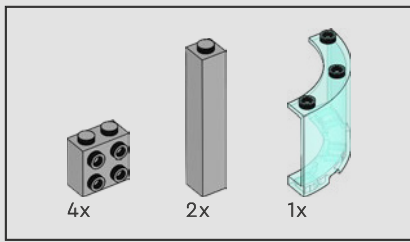

121

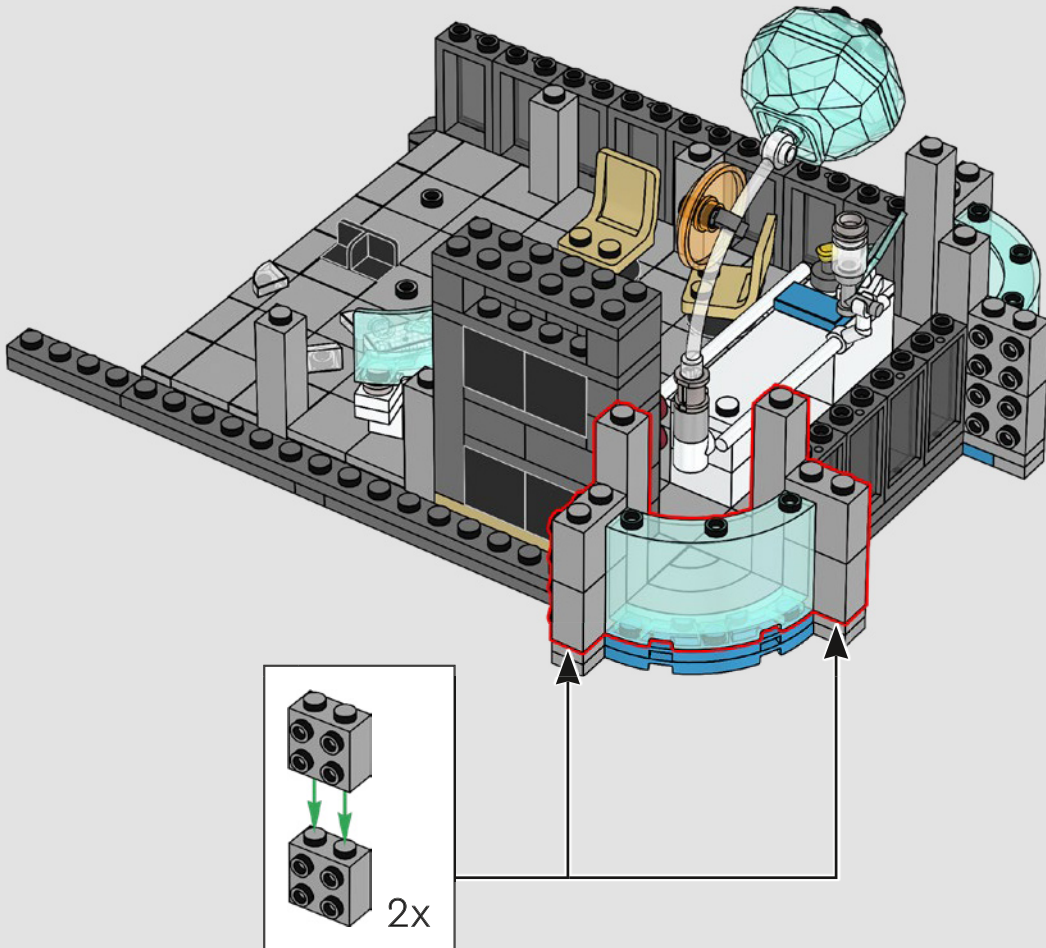

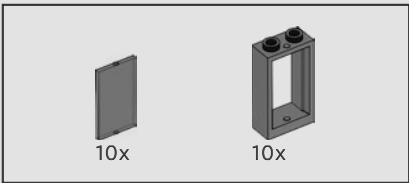

122

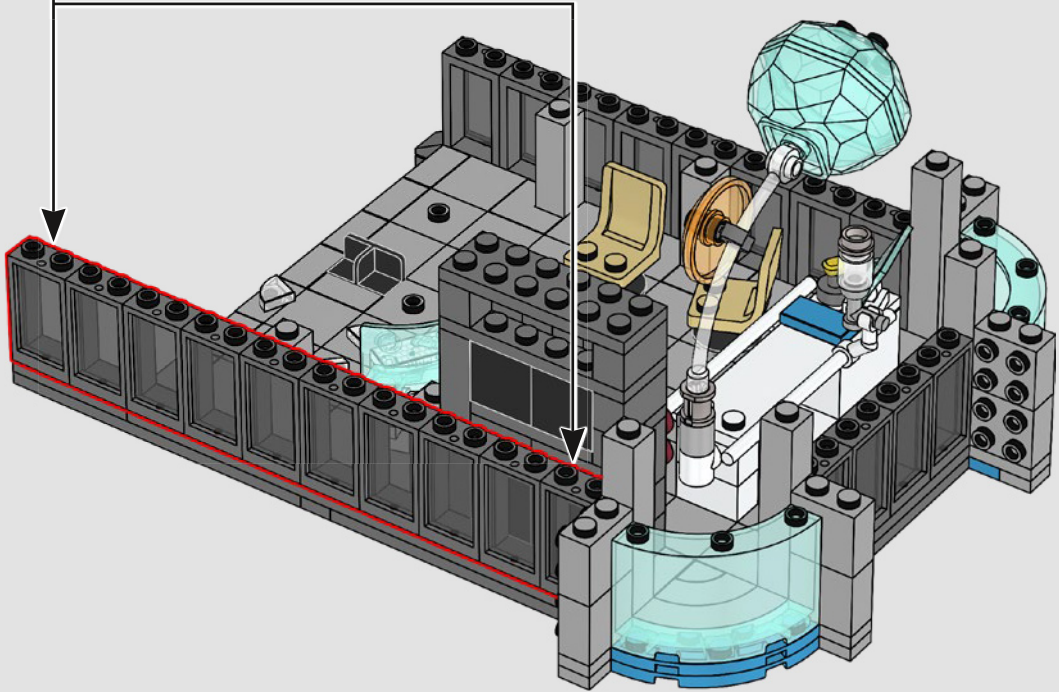
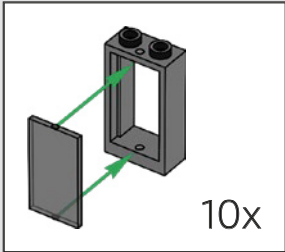

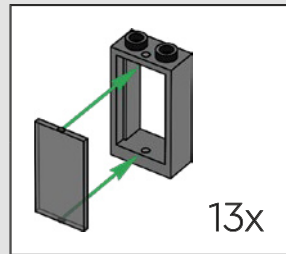
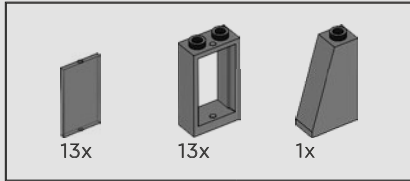

123

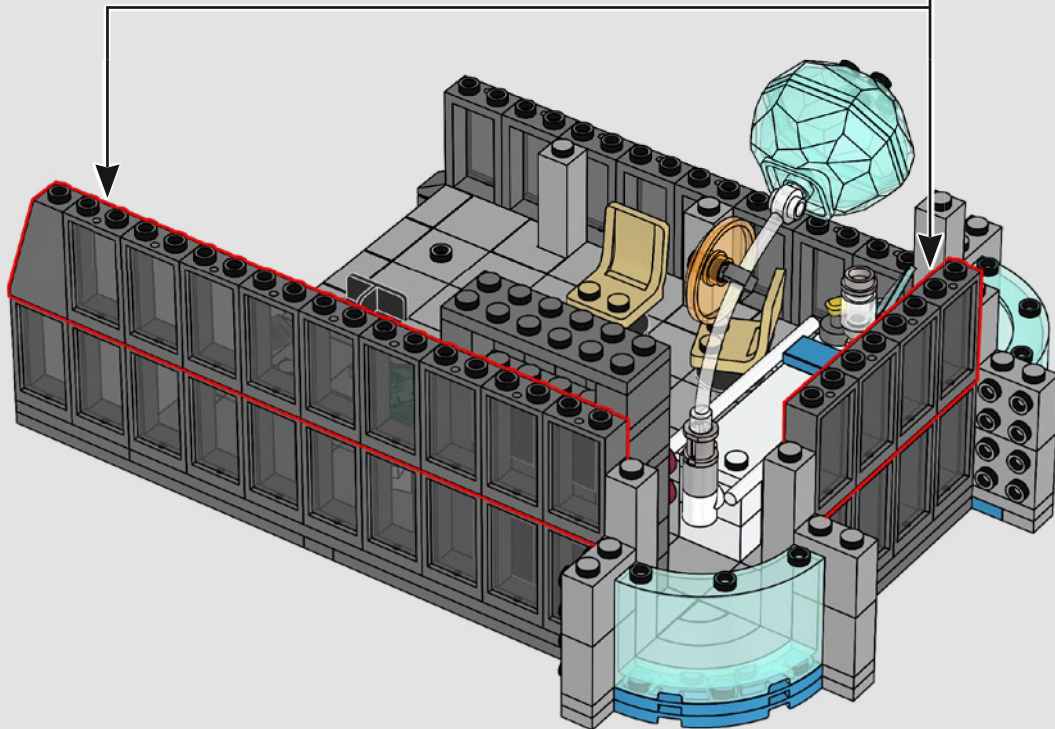

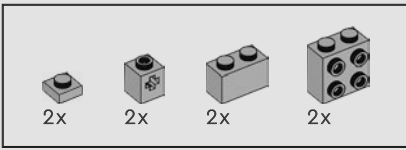

124

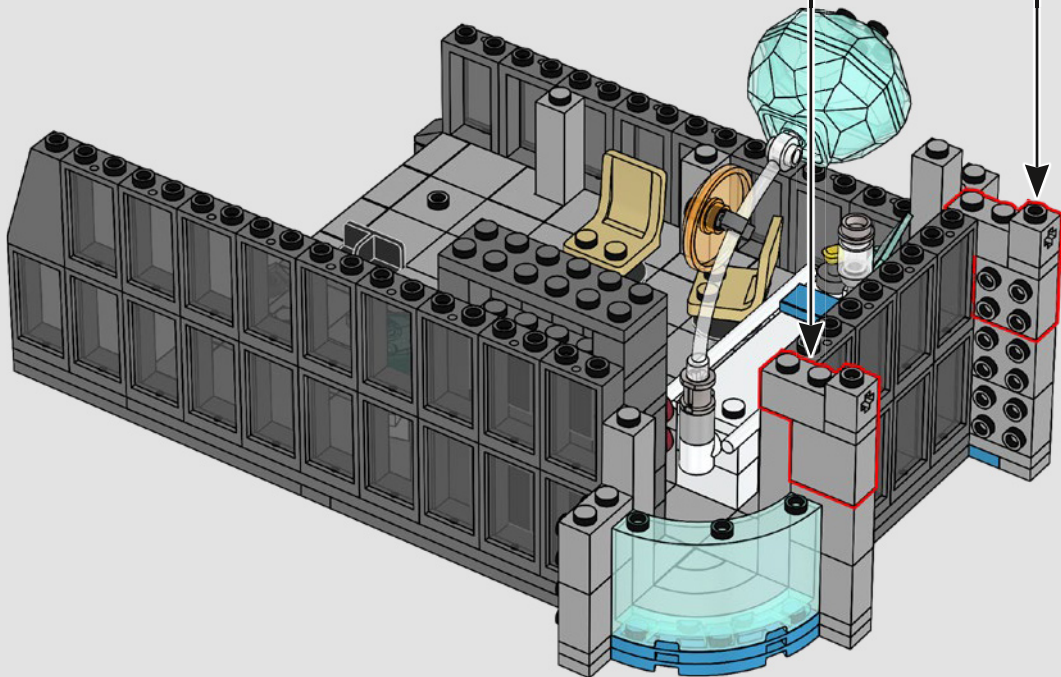
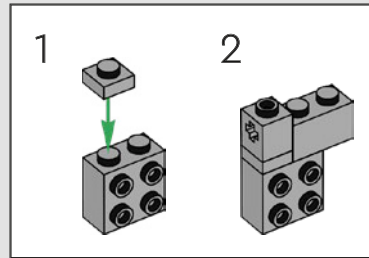
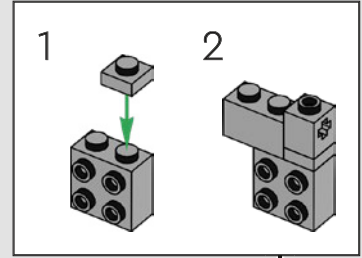

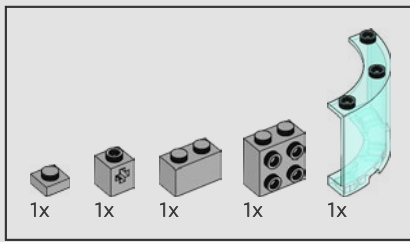

125

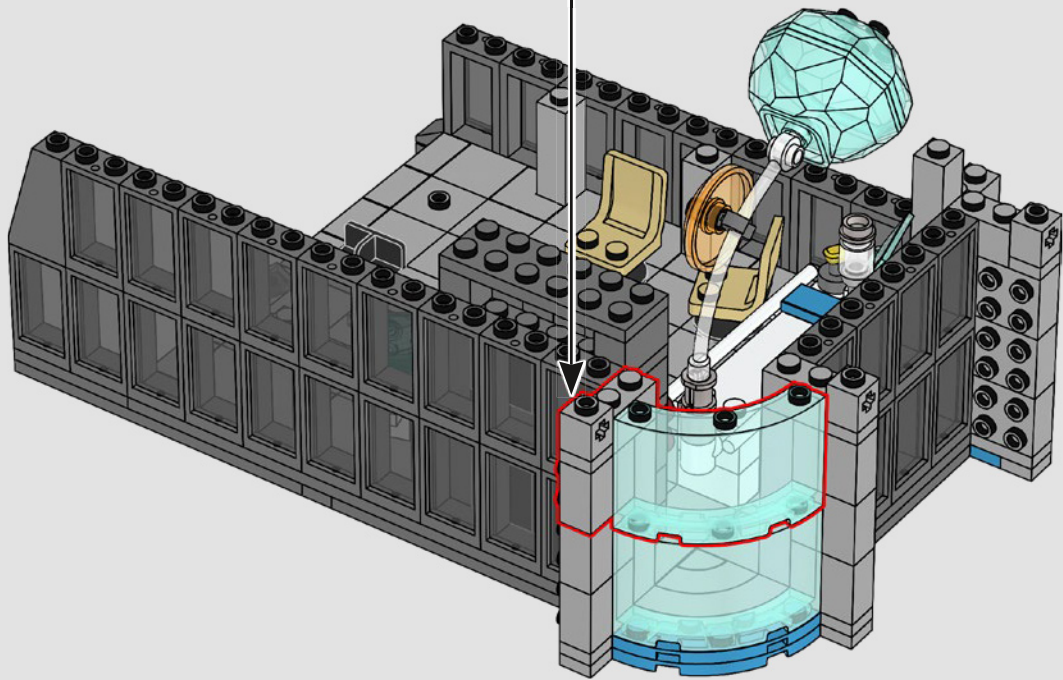
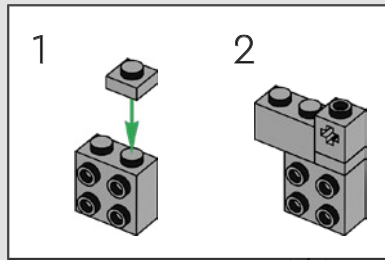

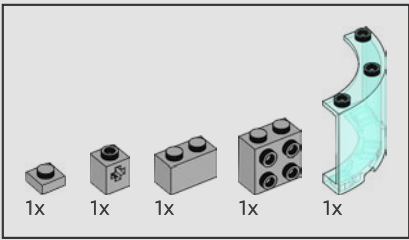

126

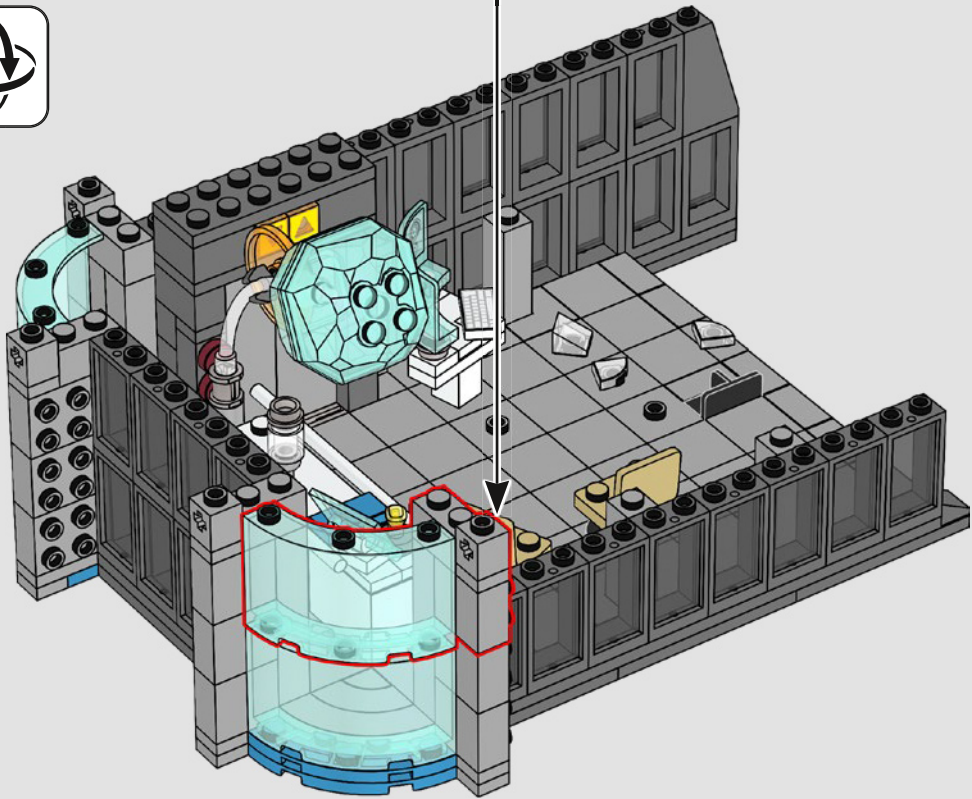
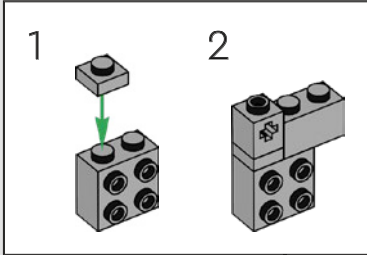

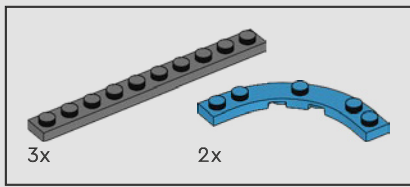

127

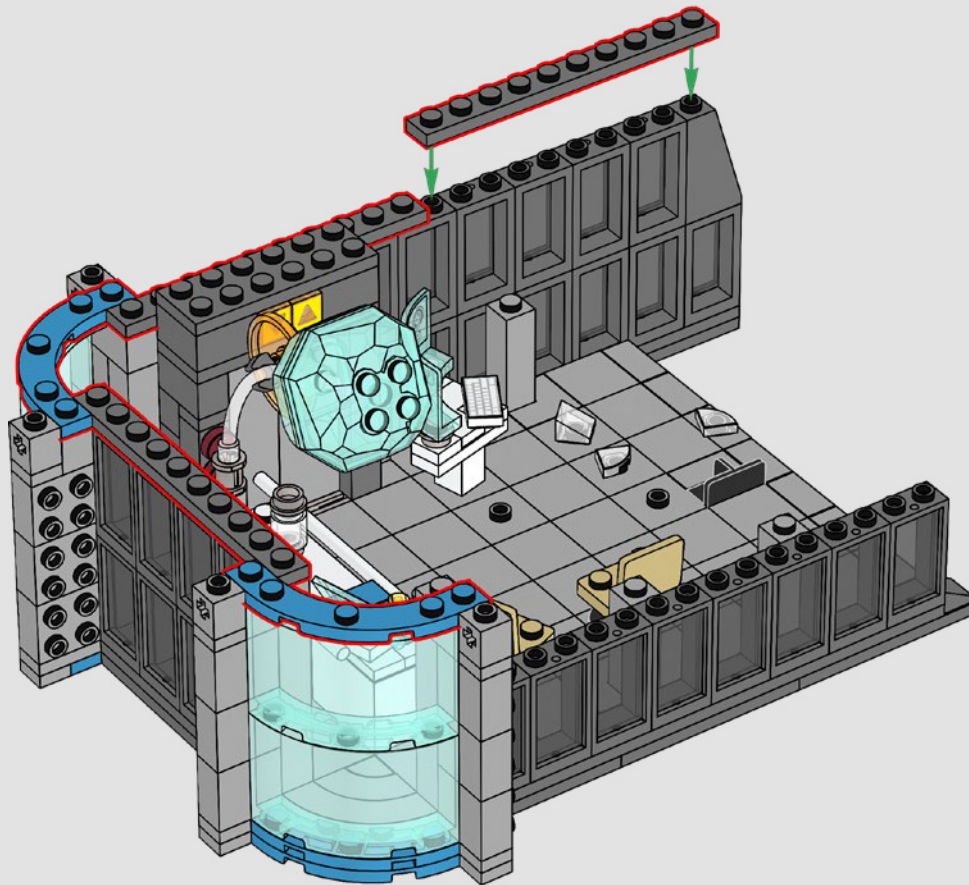

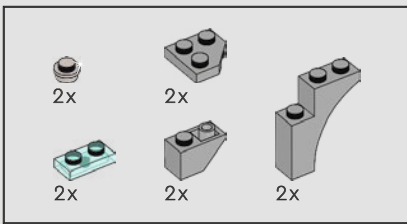

128

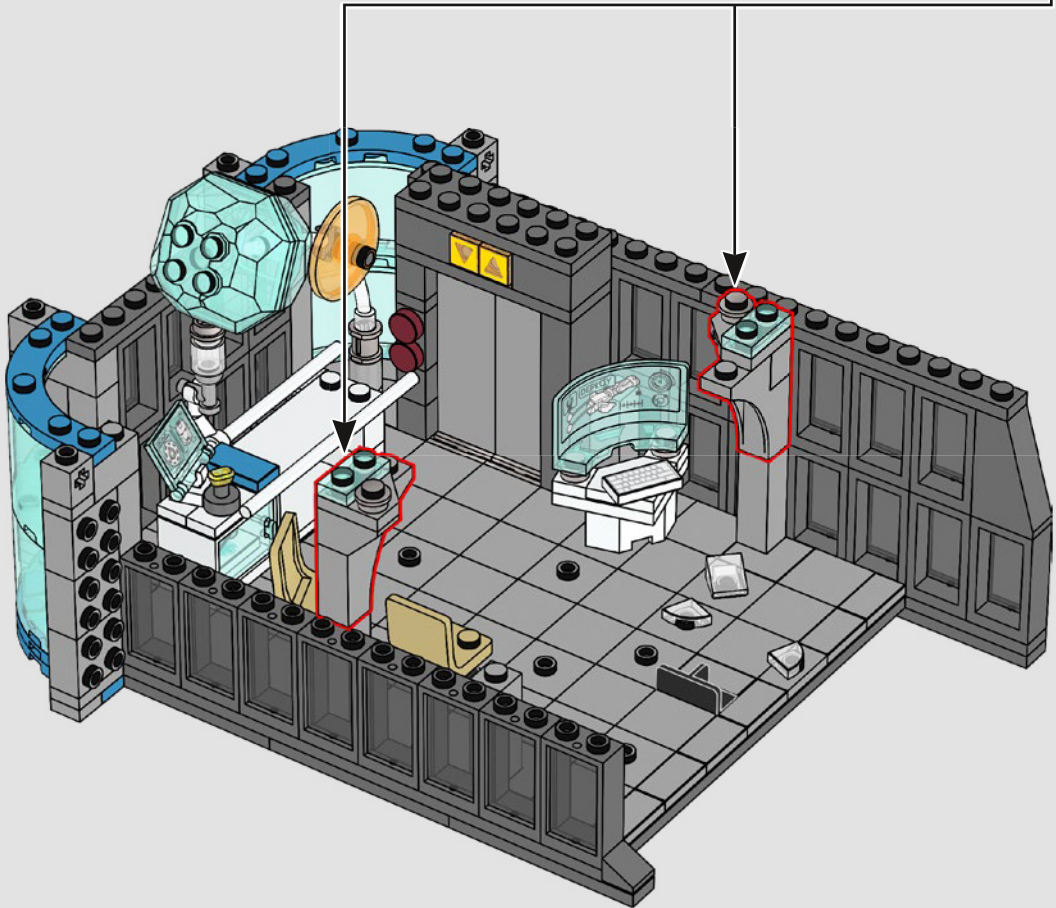
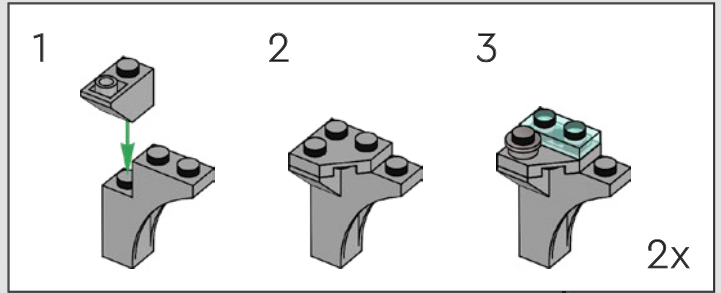

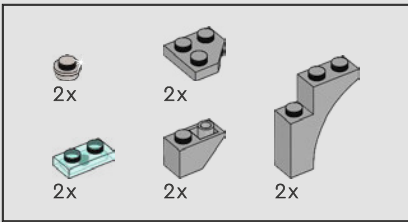

129

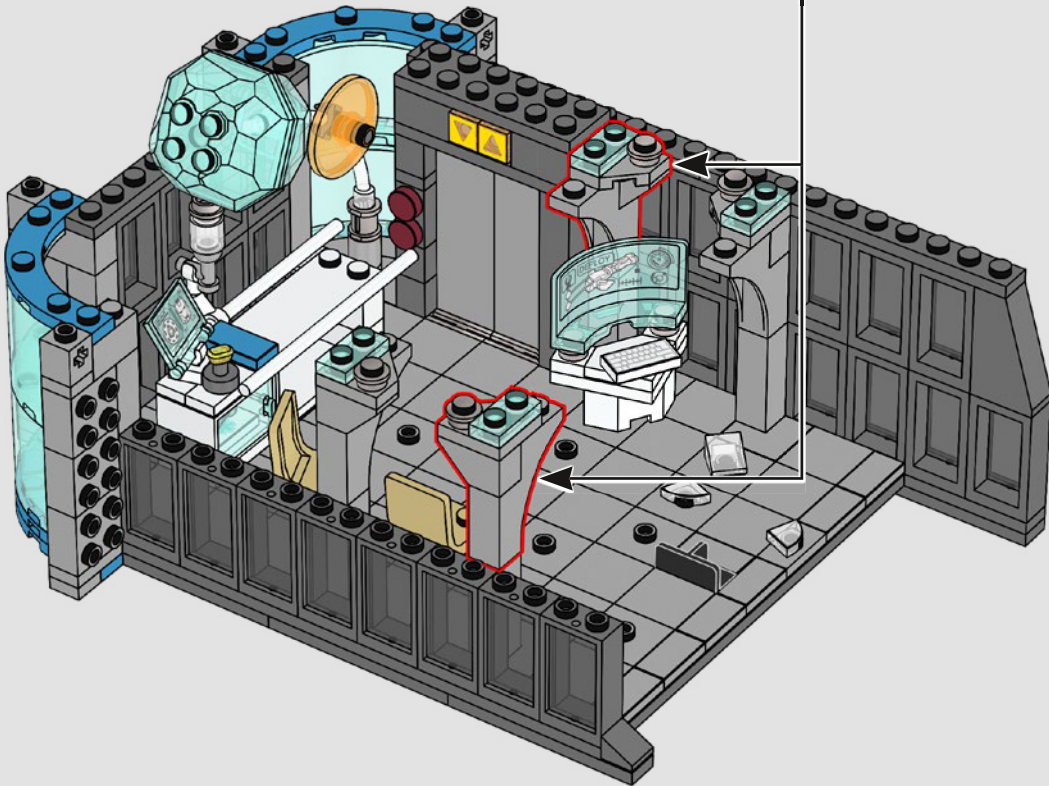
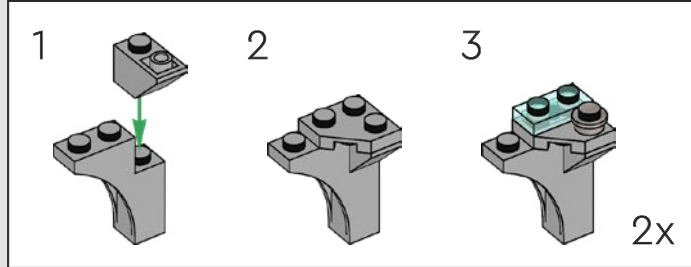

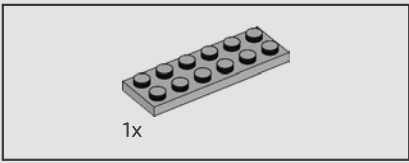

130

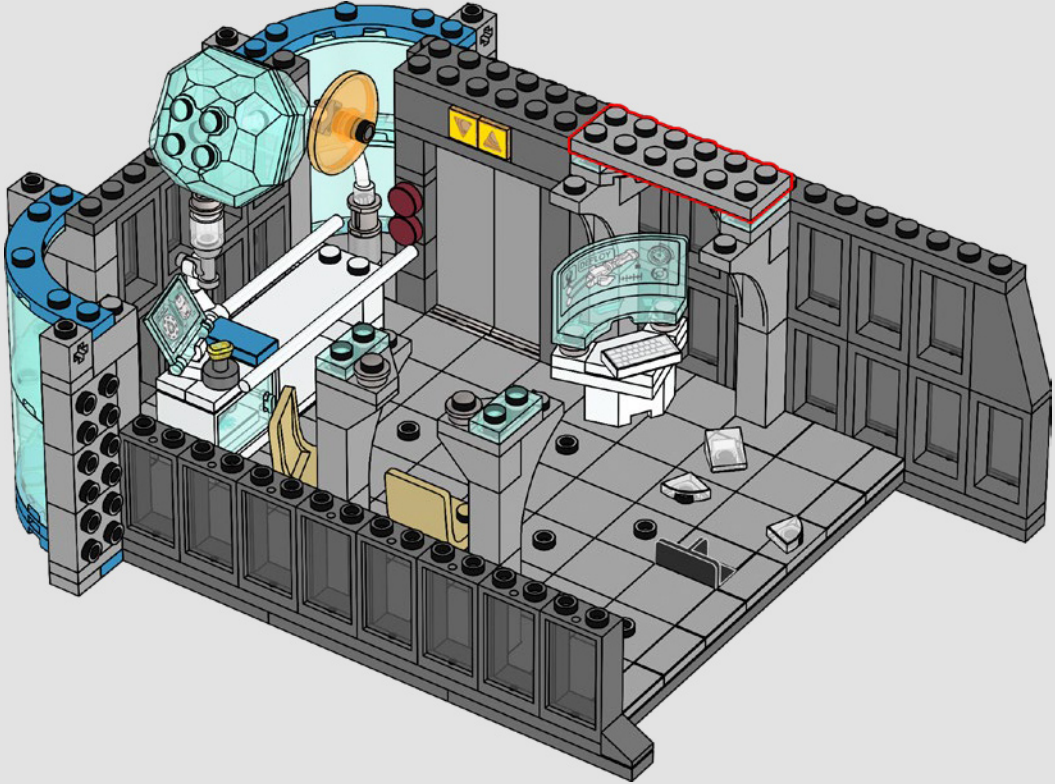

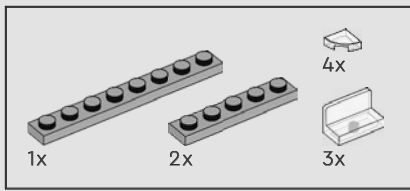

131

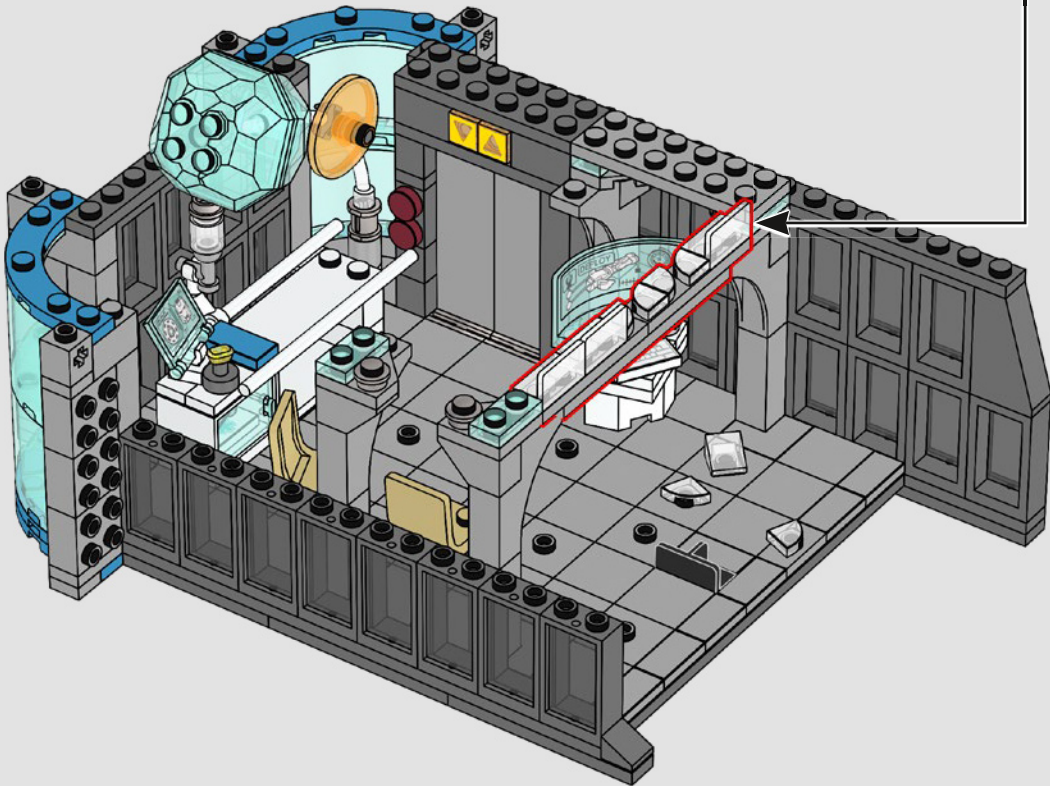
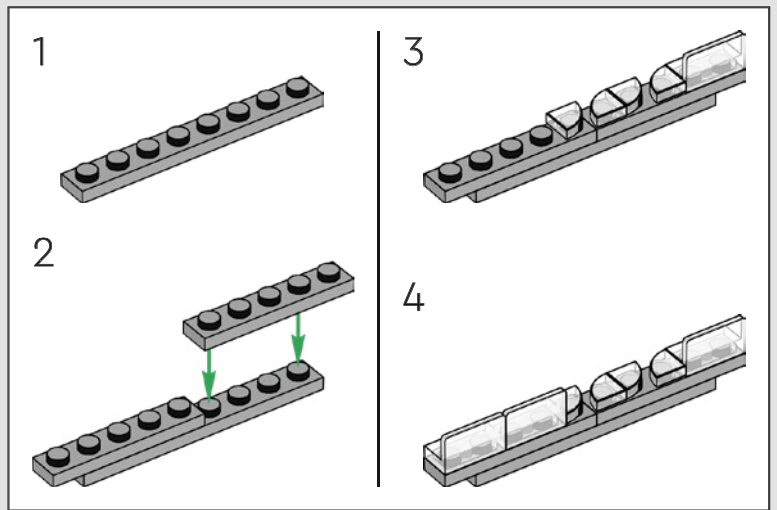

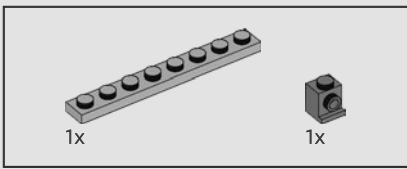

132

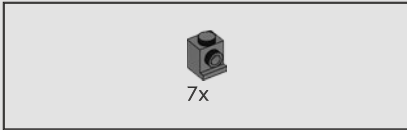
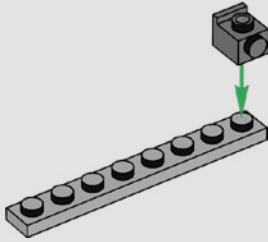

133

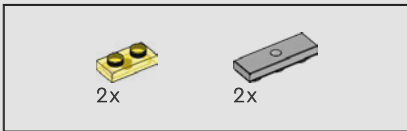
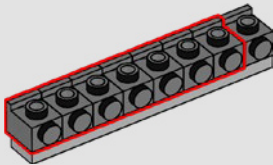

134

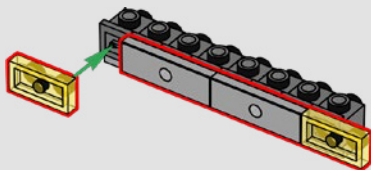

135

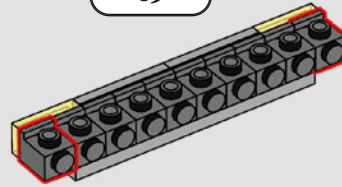

136

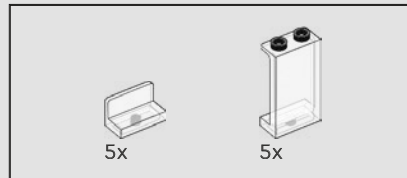
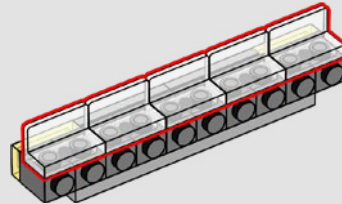

137

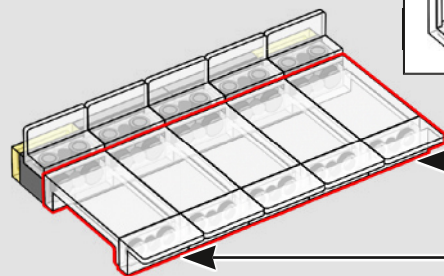
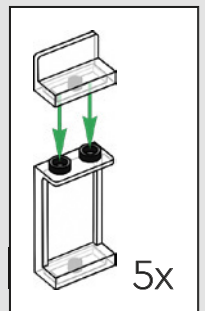

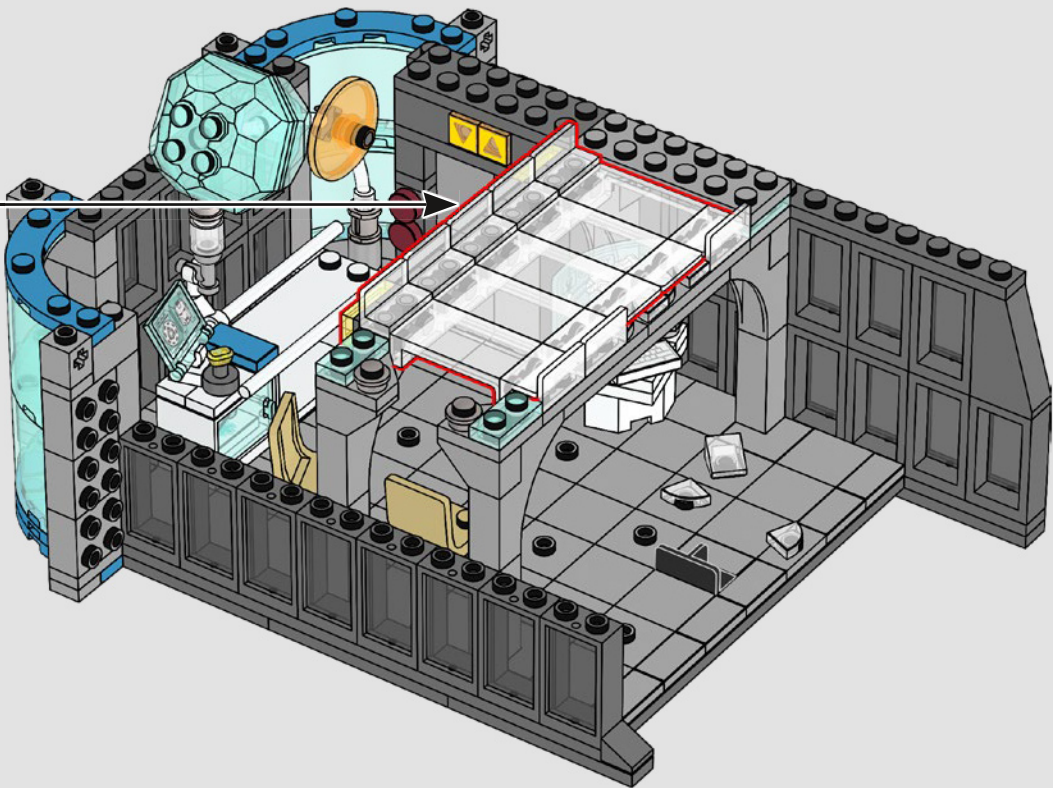

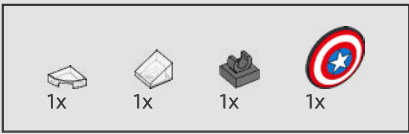

139

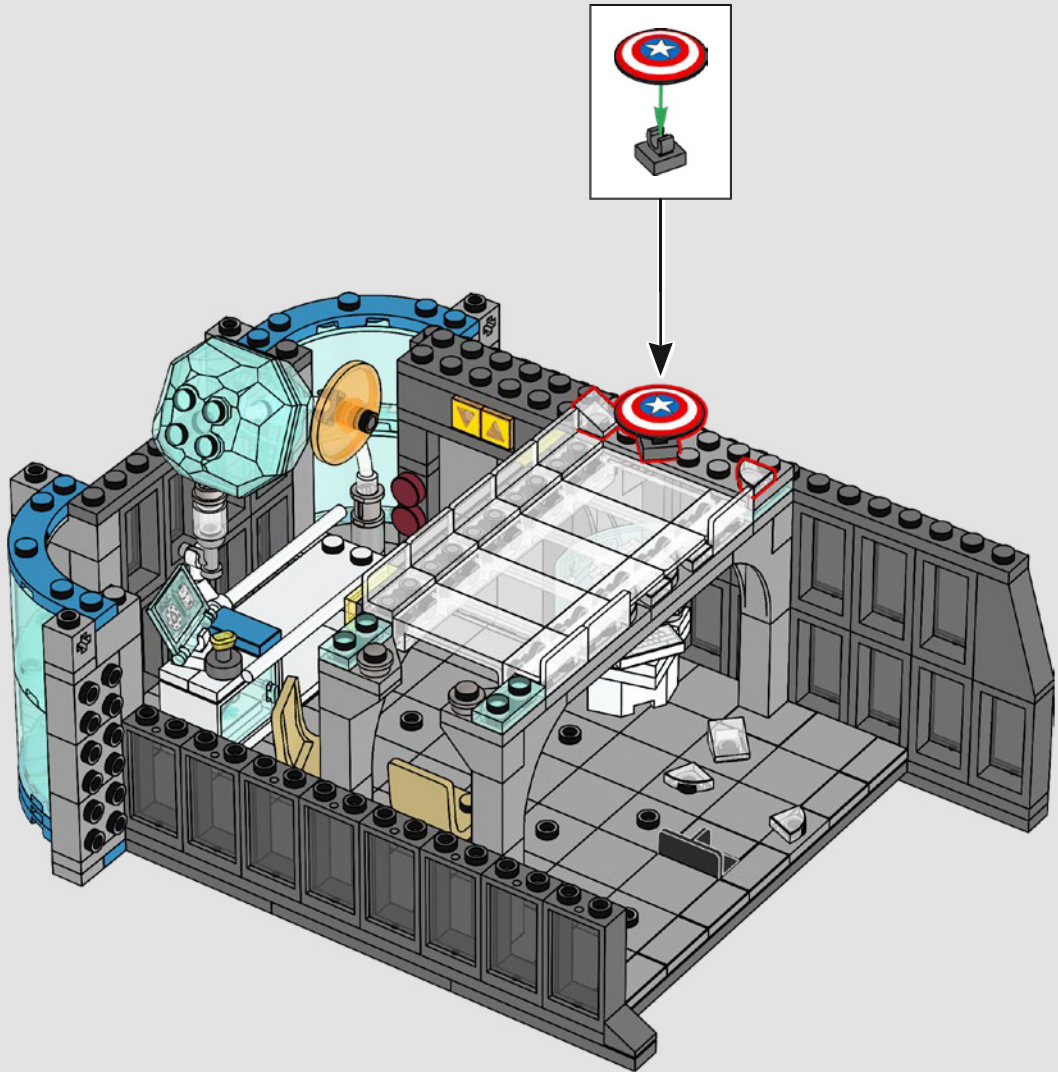

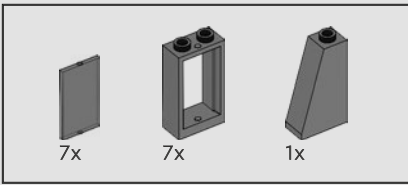

140

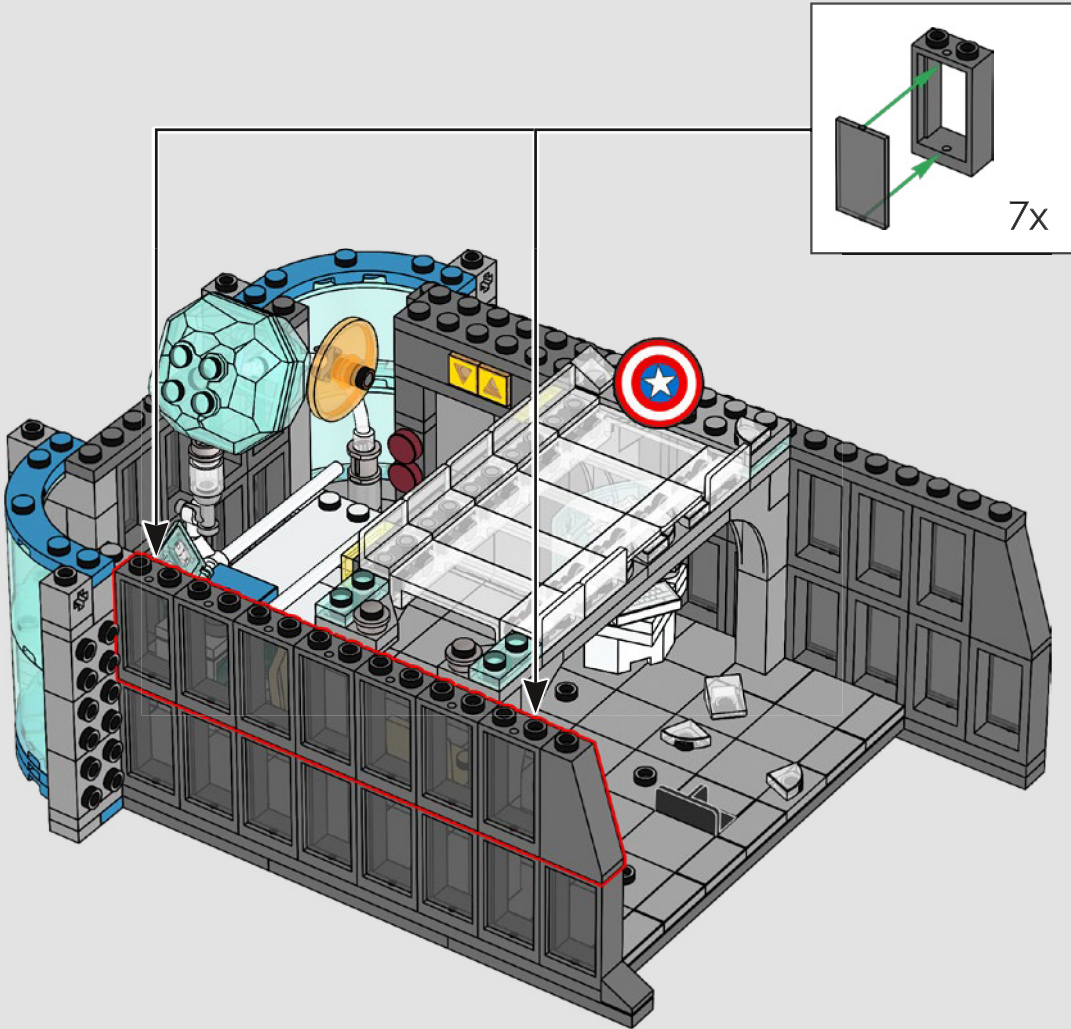

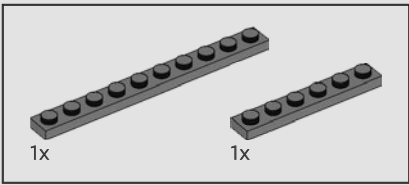

141

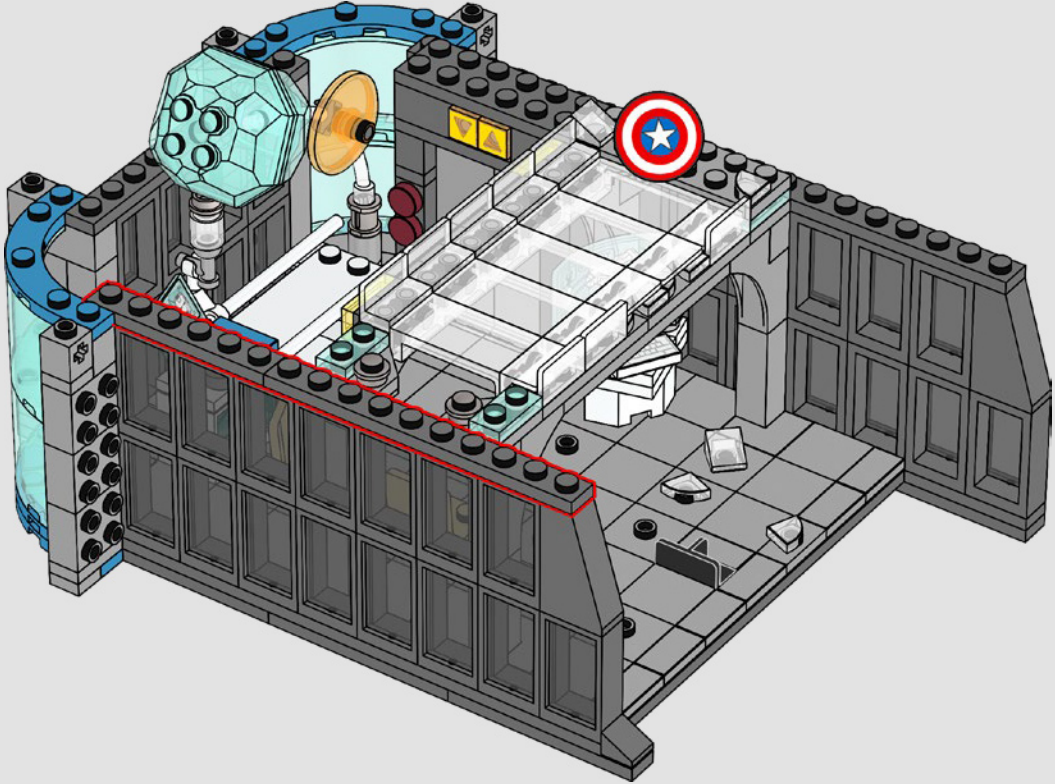

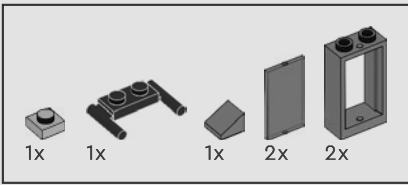

142

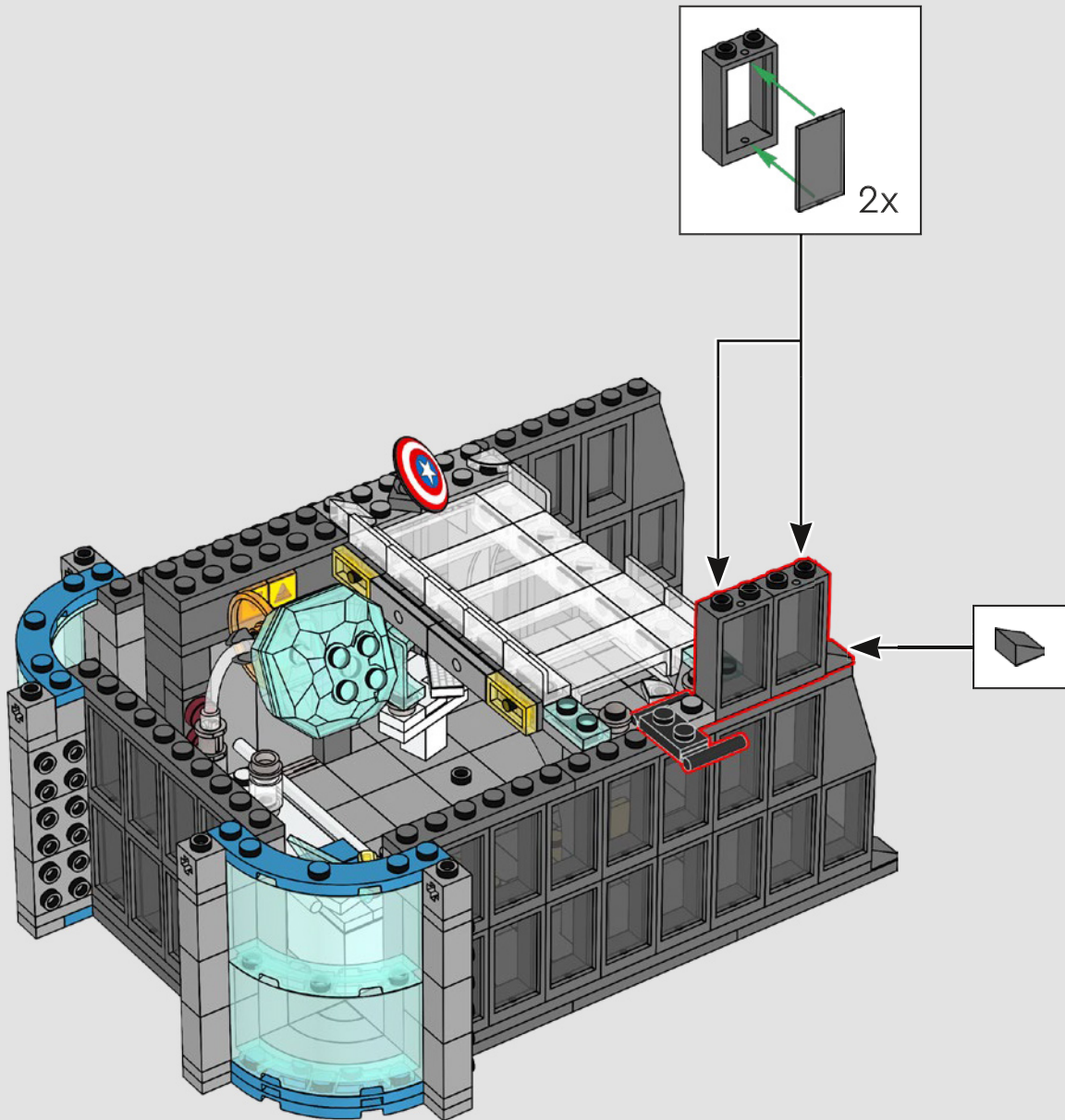

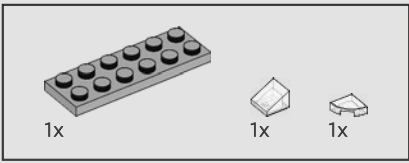

143

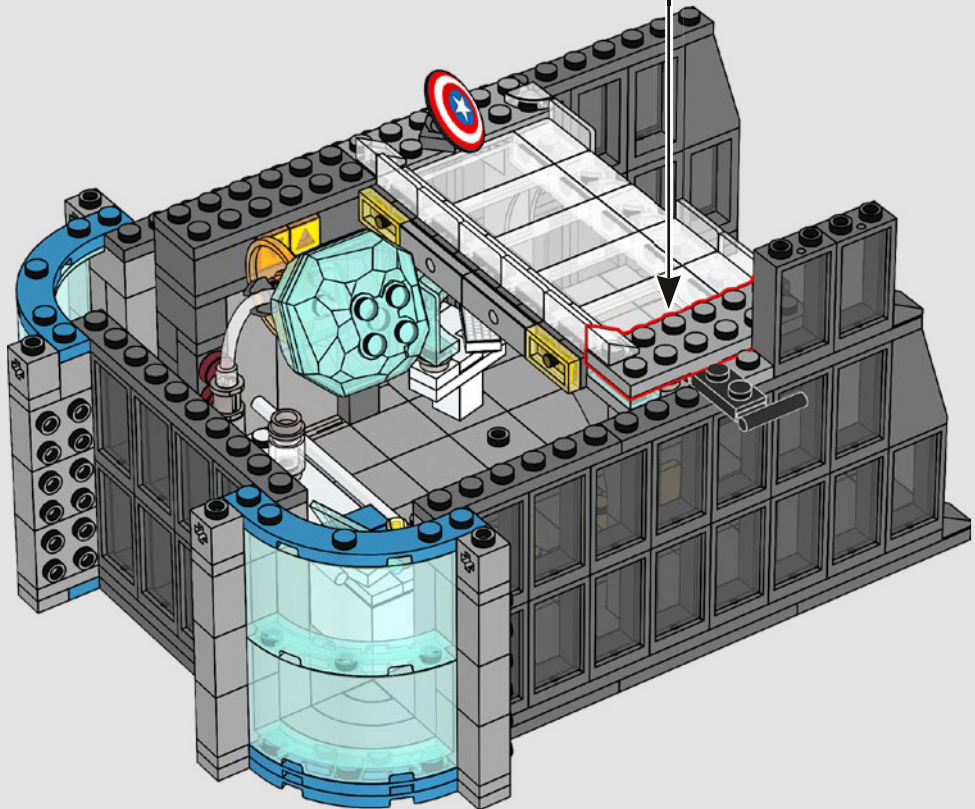
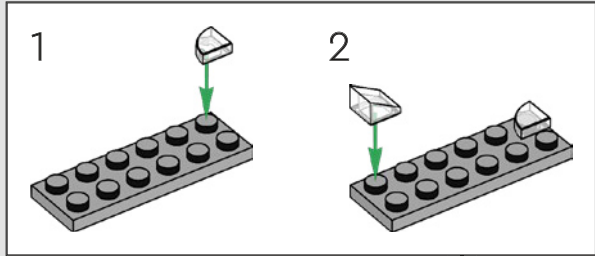



144

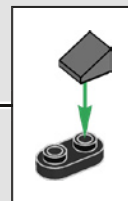
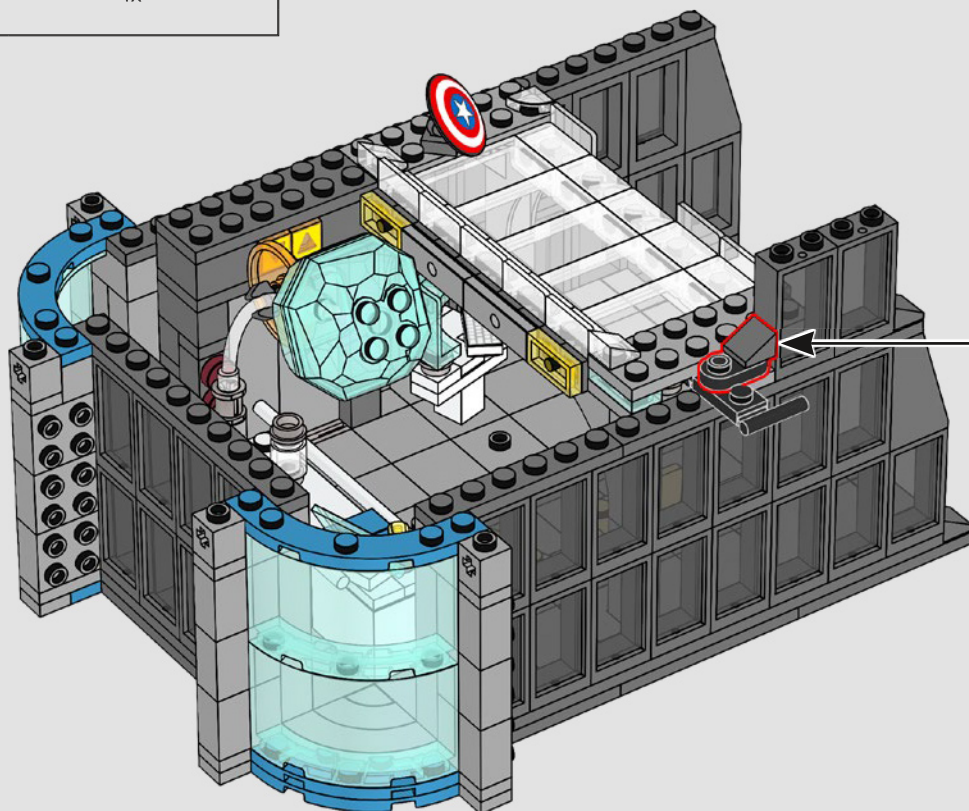



145

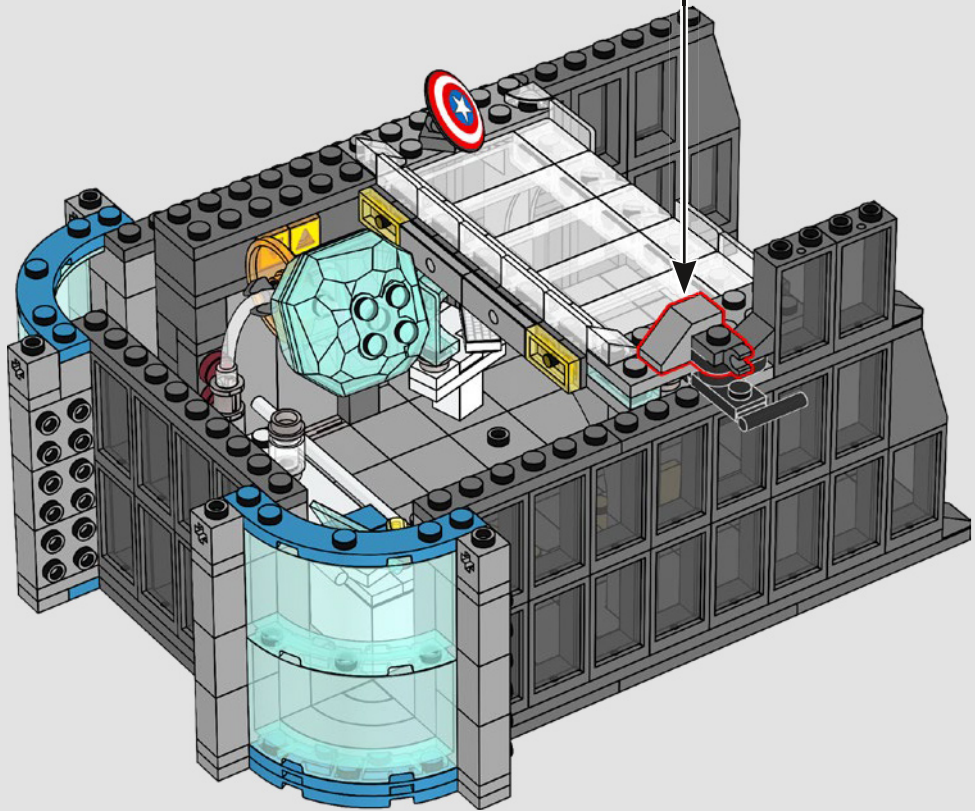
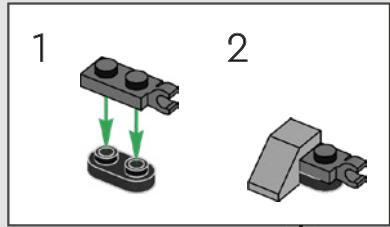

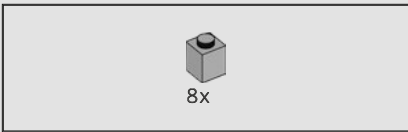

146

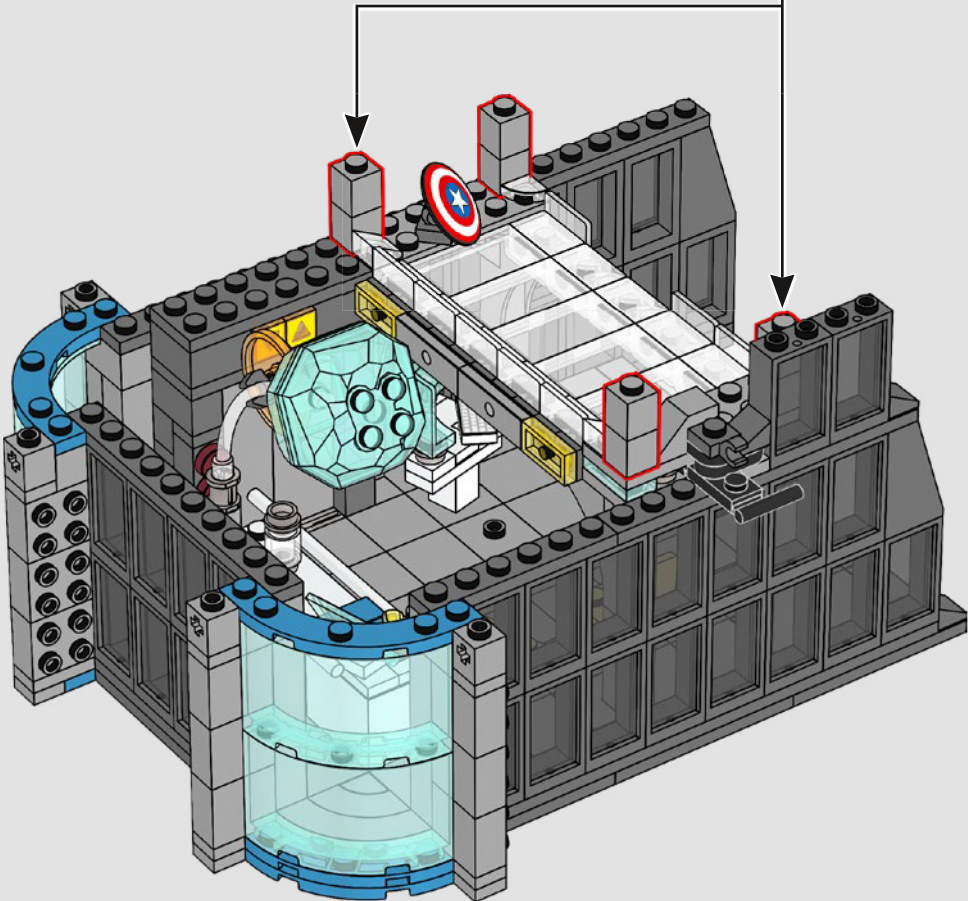
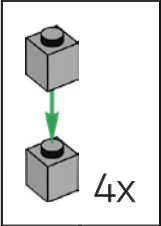

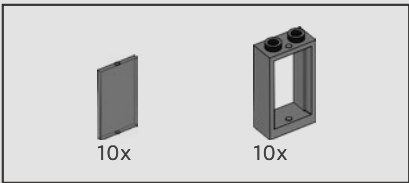

147

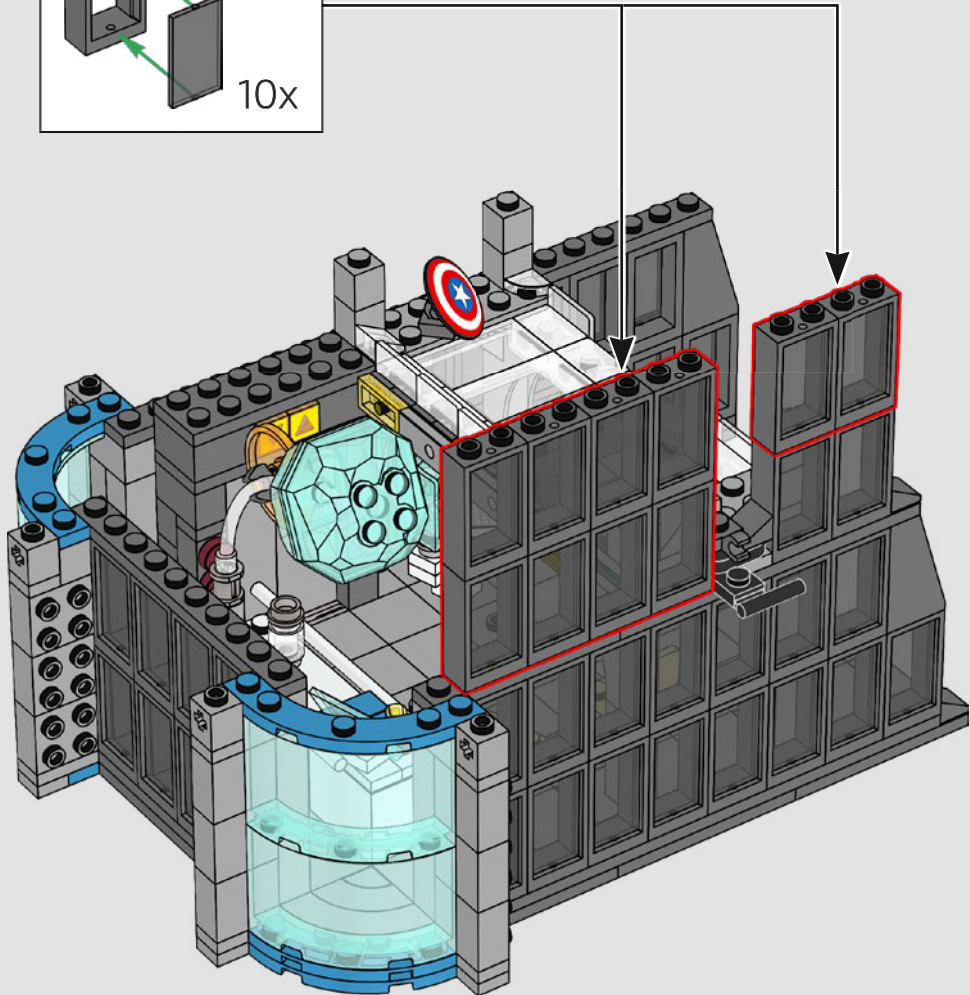
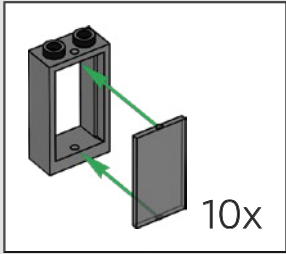

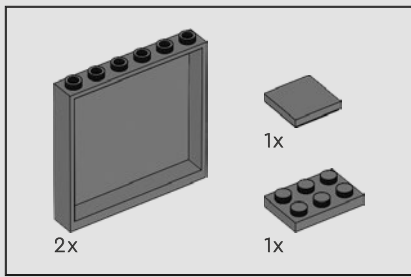

148

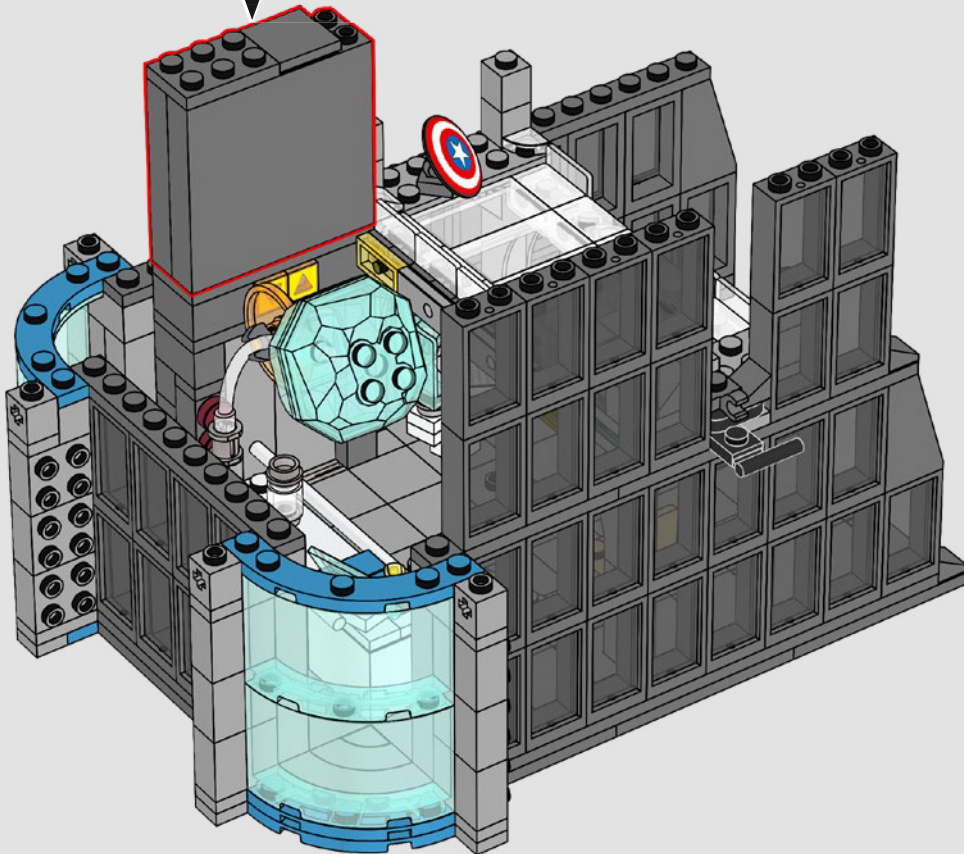
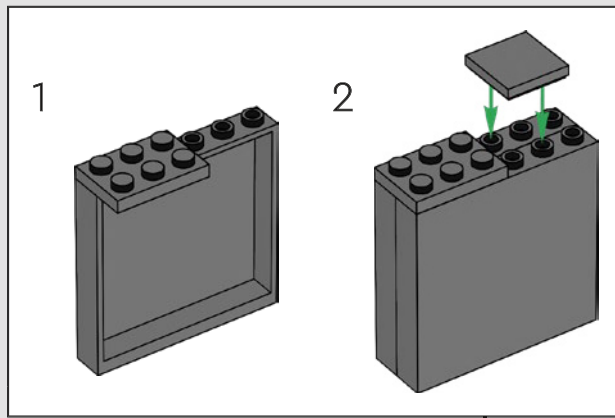

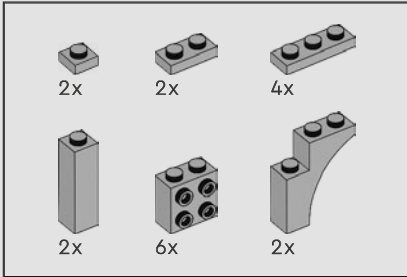
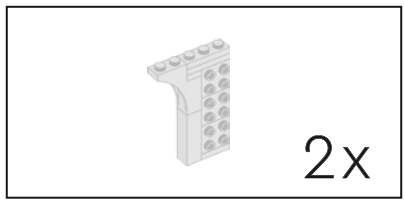

149

1

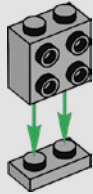

2

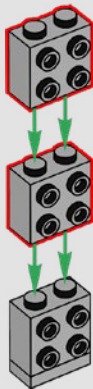

1

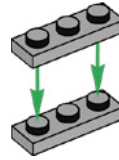

2

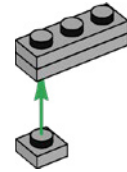

3

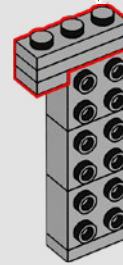

4

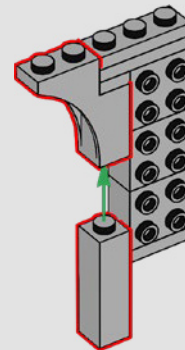

2x



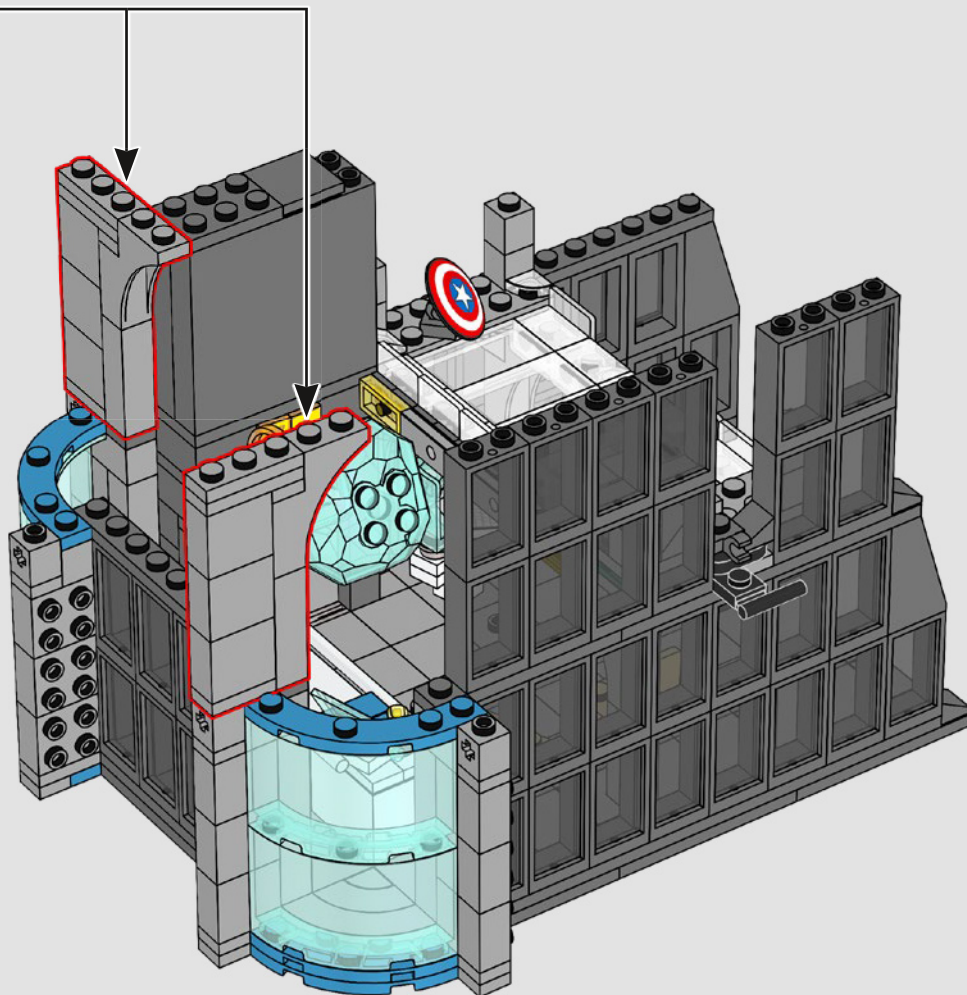

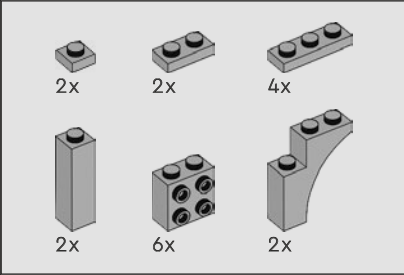
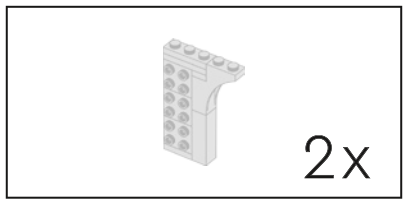

150

1

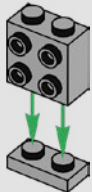

2

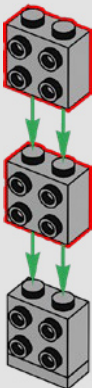

3

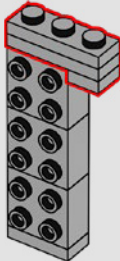

4

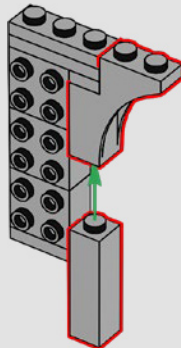

2x



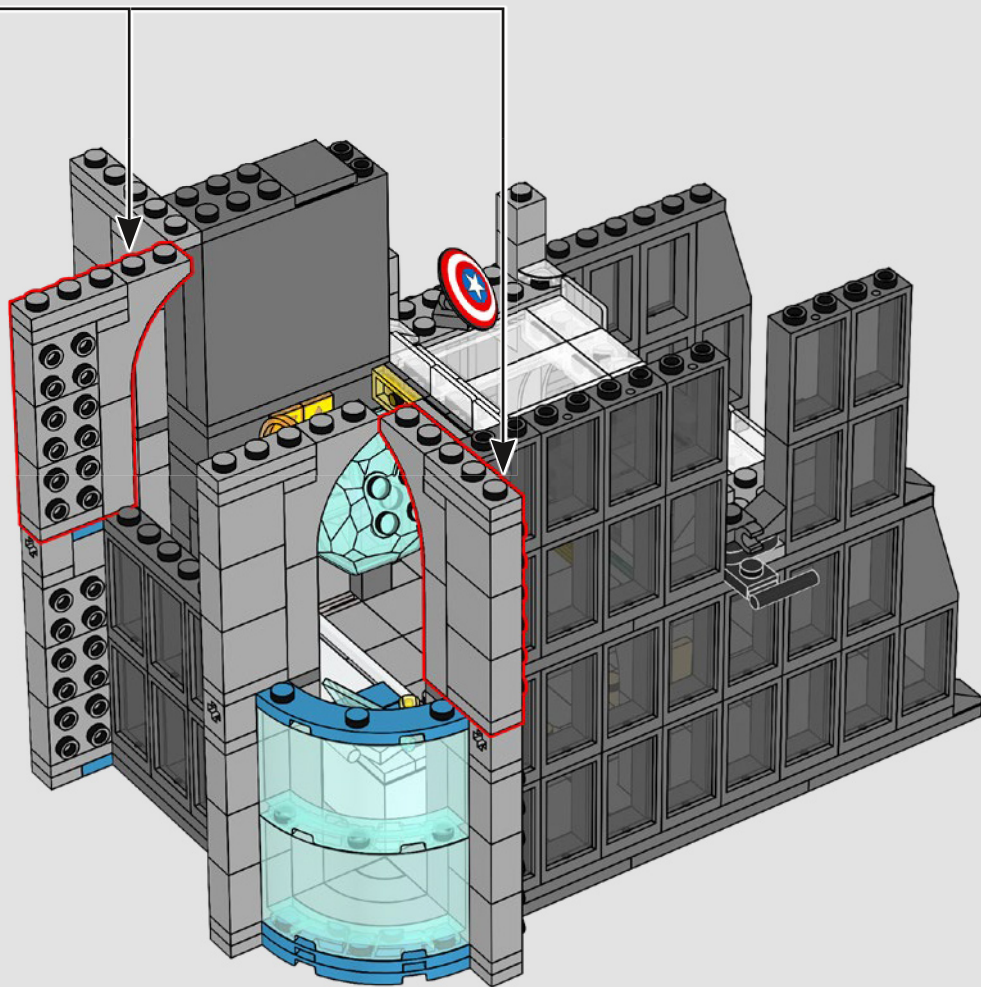

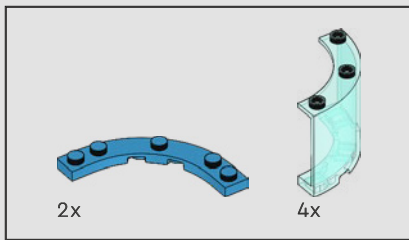

151

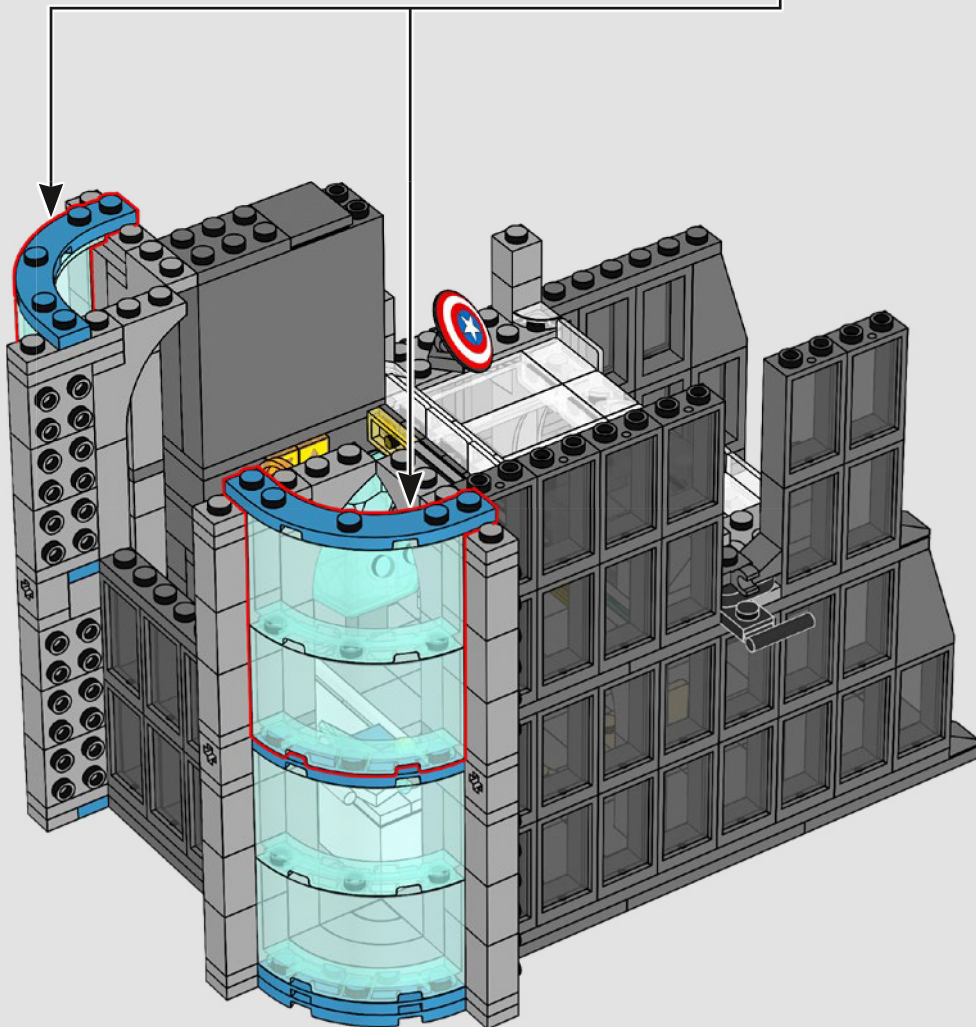
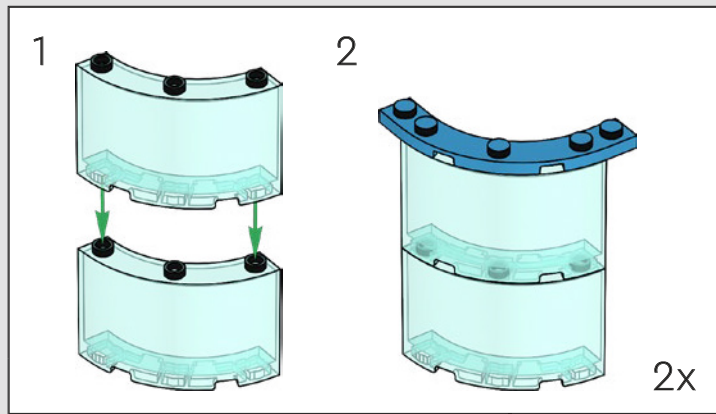

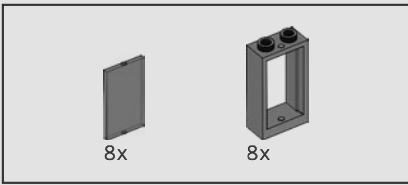

152

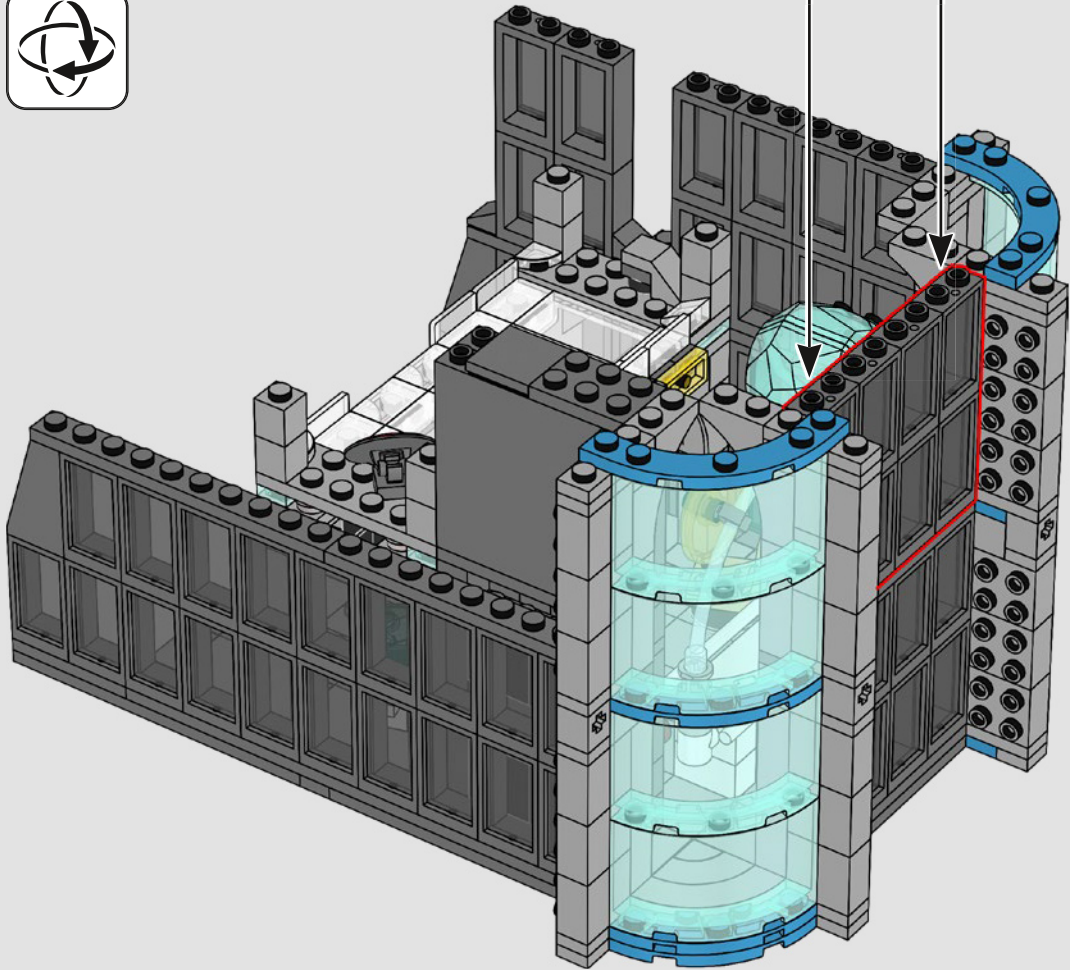
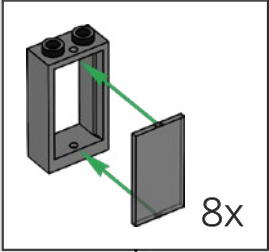

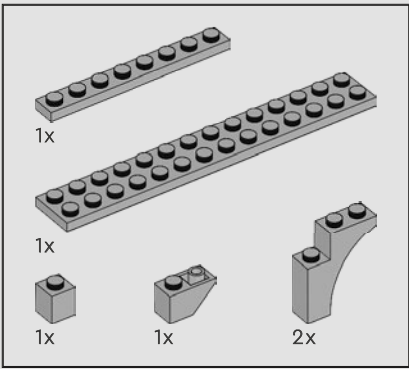

153

1

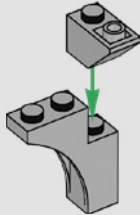

2

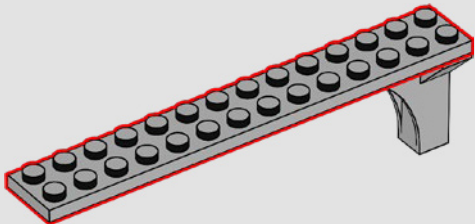

3

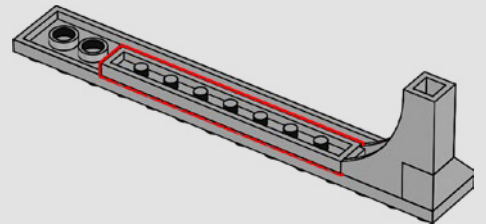

4

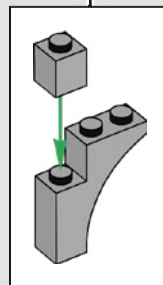
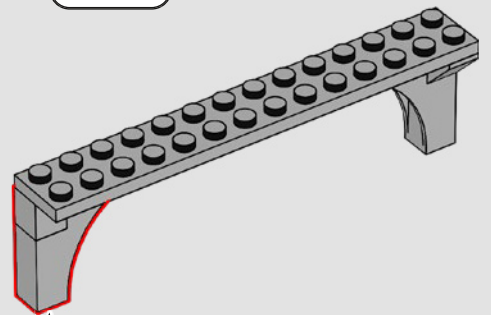

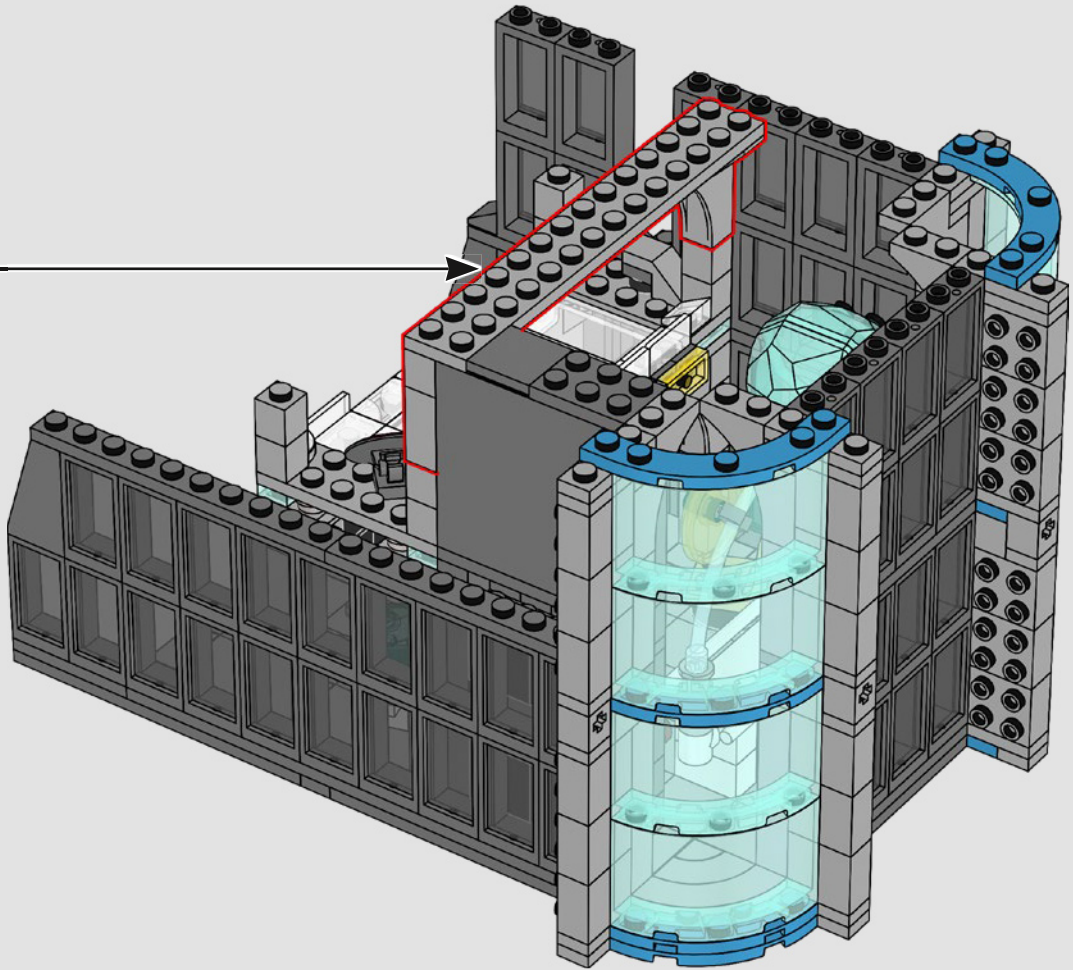

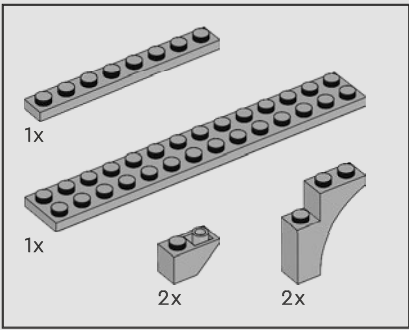

154

1

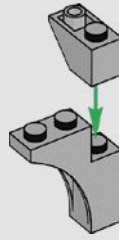

2

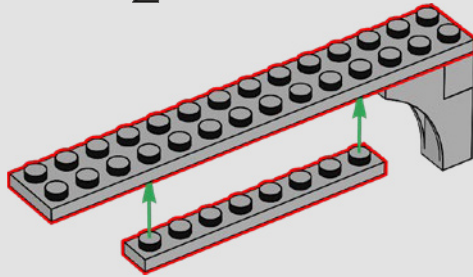

3

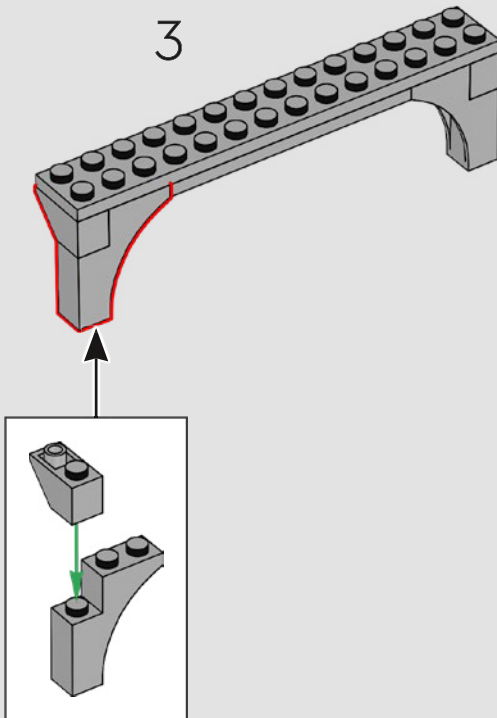

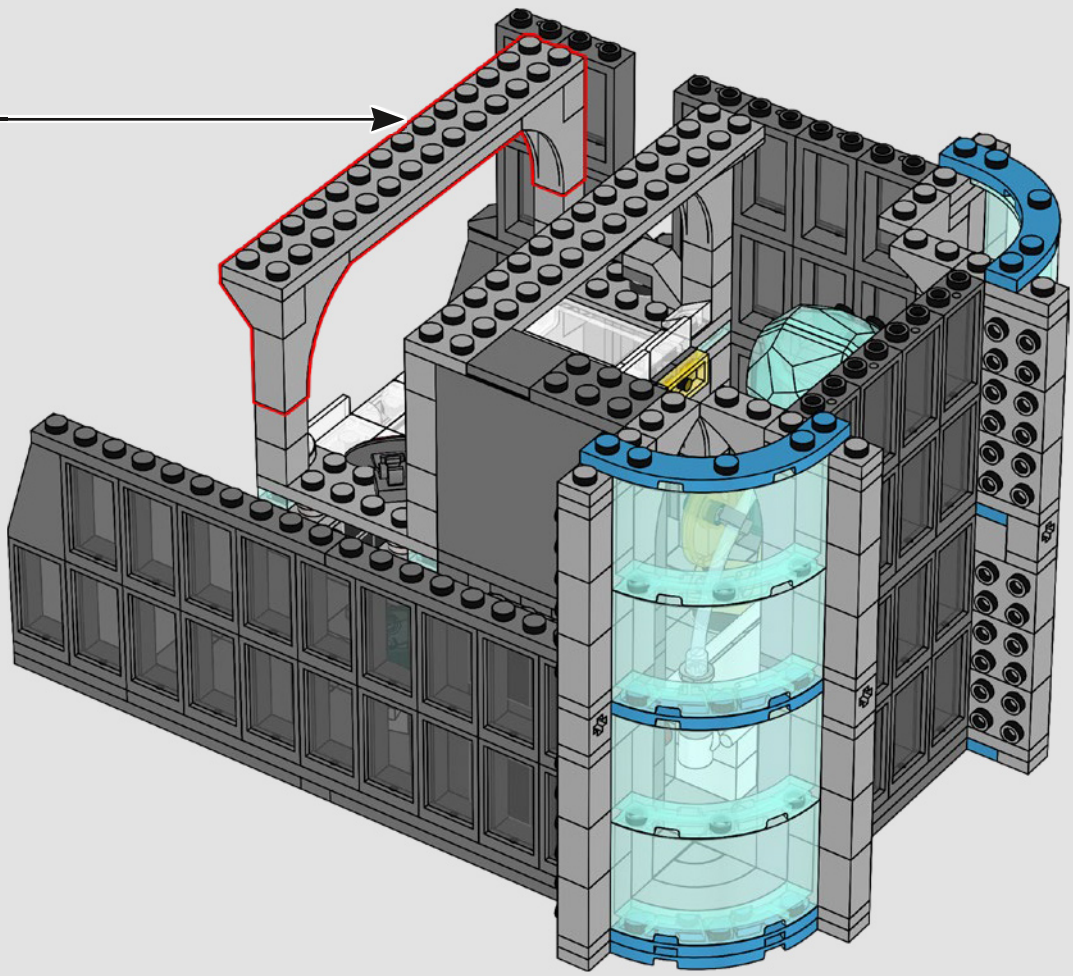

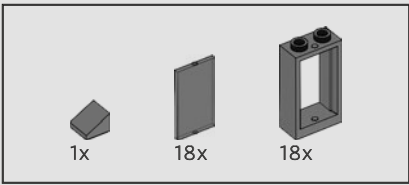

155

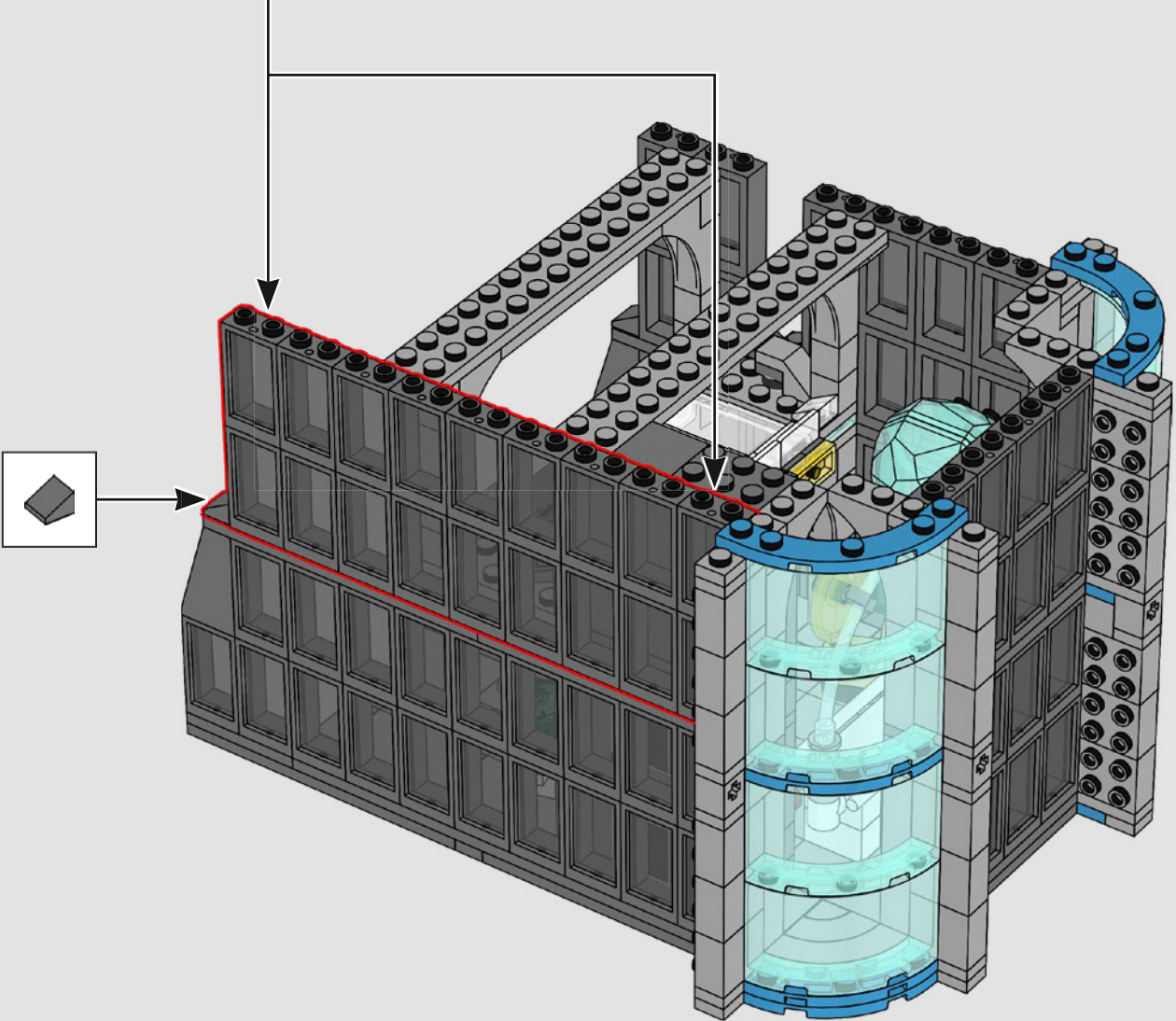
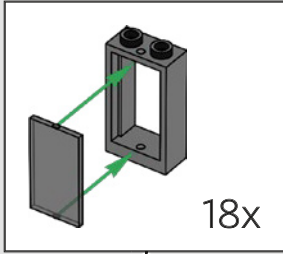

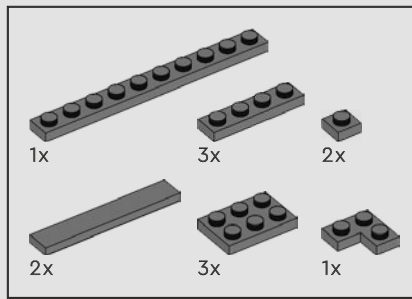

156

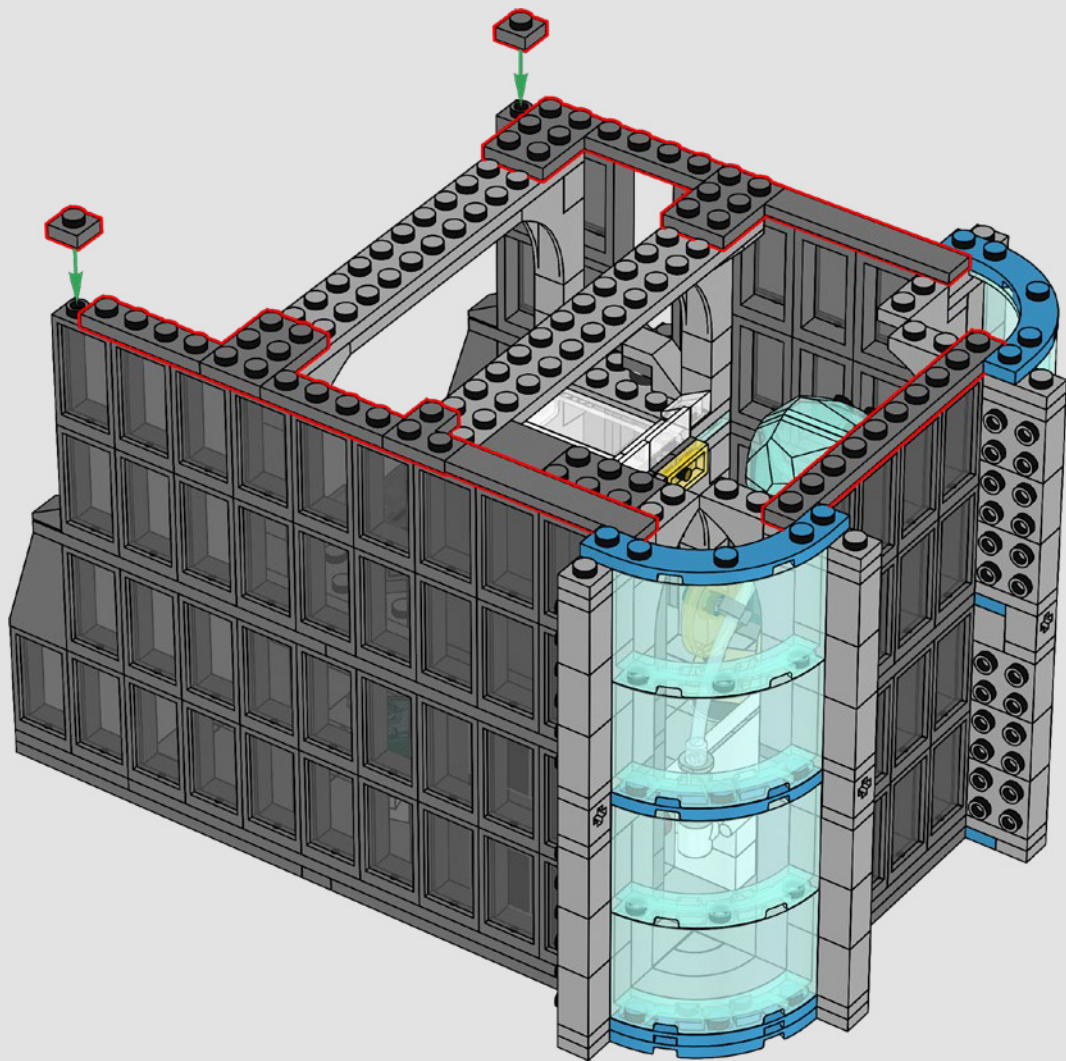

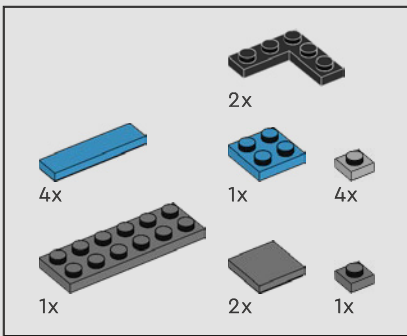

157

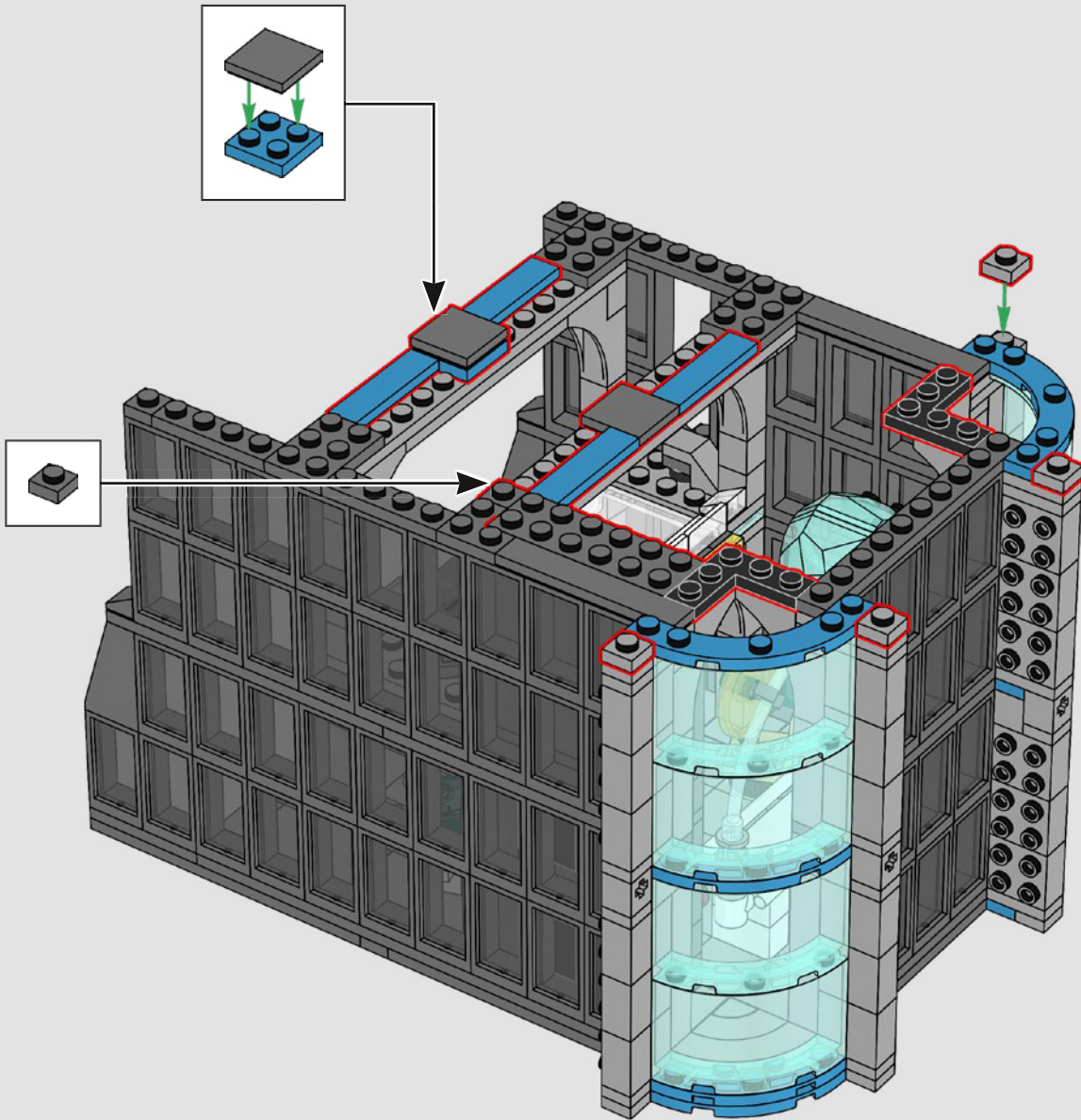

158

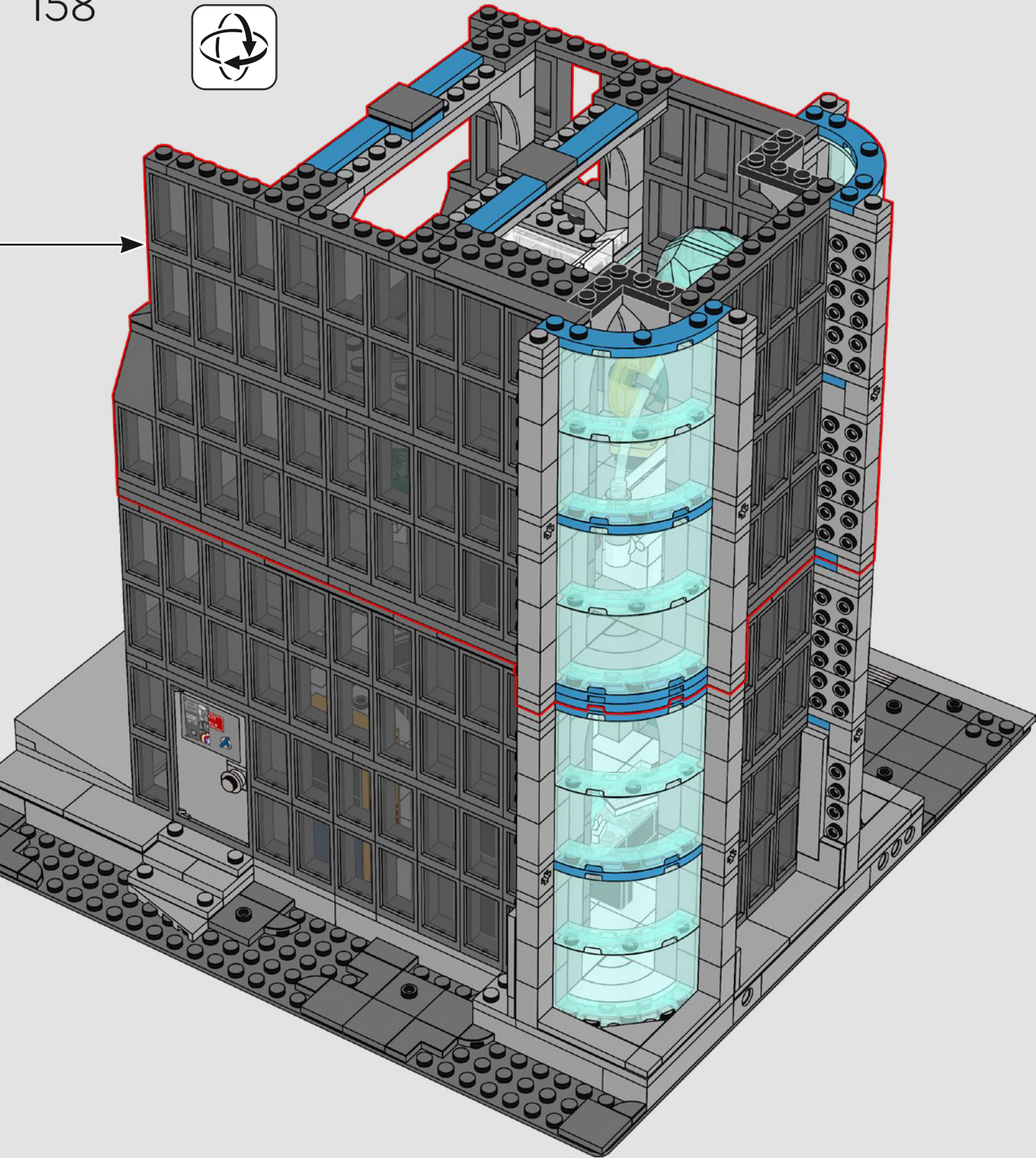

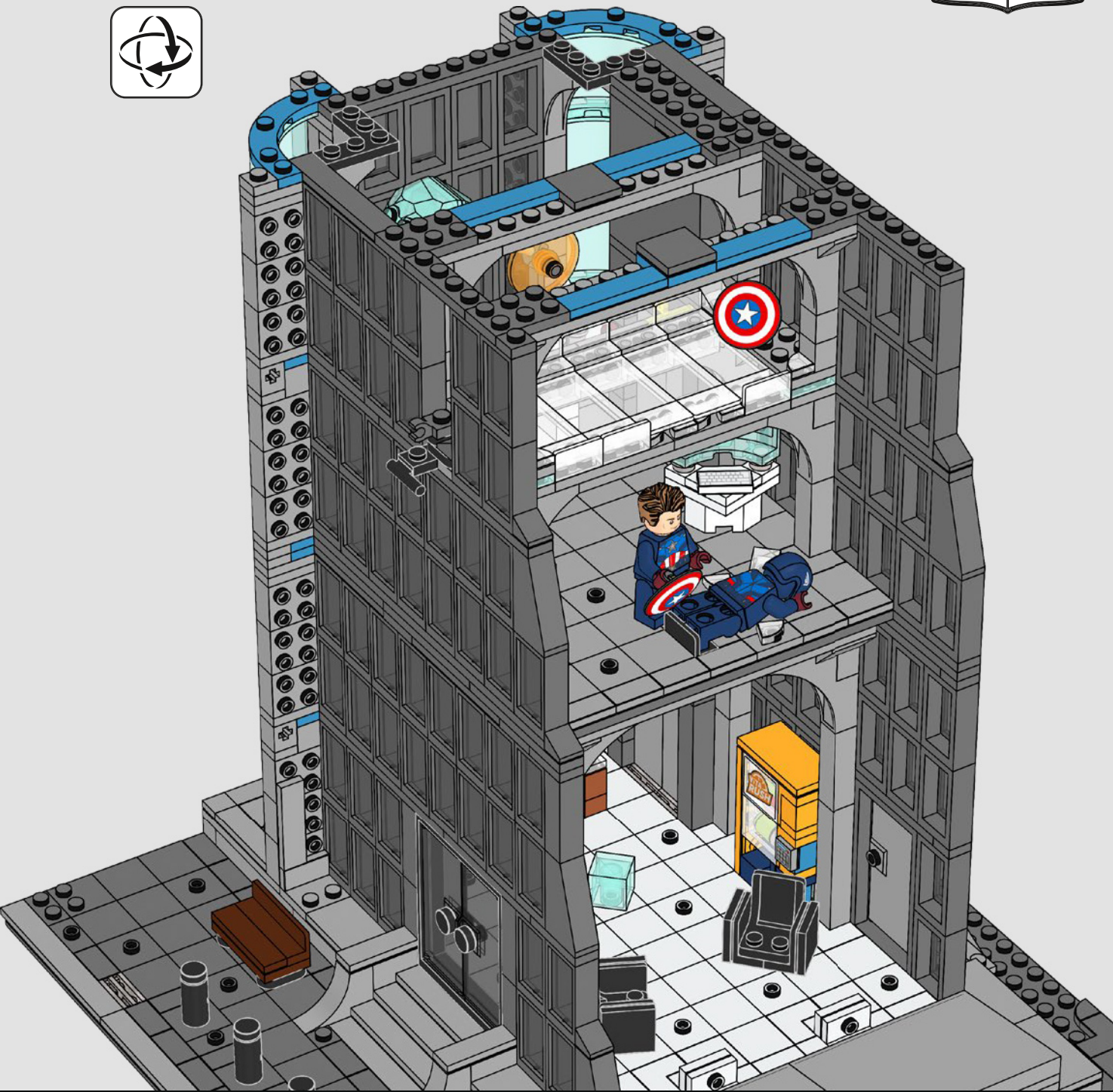

We think that second figure looks great, Cap. As far as we're concerned, that's America's tube-side.

Cette deuxième figurine est superbe, Capitaine. À notre avis, c'est le plus beau côté tubes de l'Amérique.

Creemos que esa segunda figura se ve genial, Cap. En lo que a nosotros respecta, ese es el lado tubular de América.

STARBUCK