

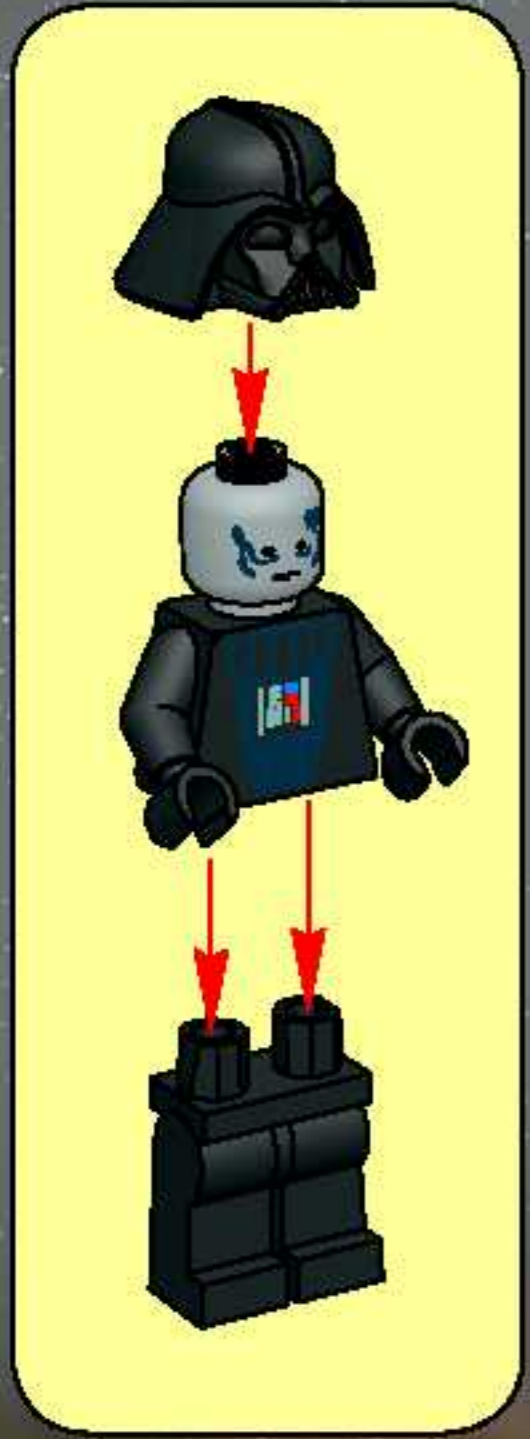

STAR WARS

7251







1



2



3



4



5



6

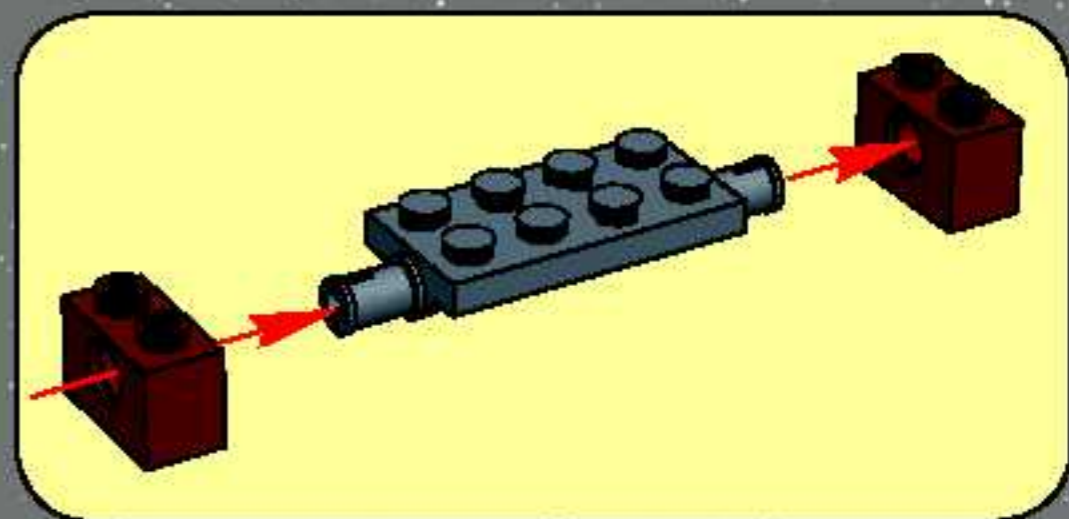
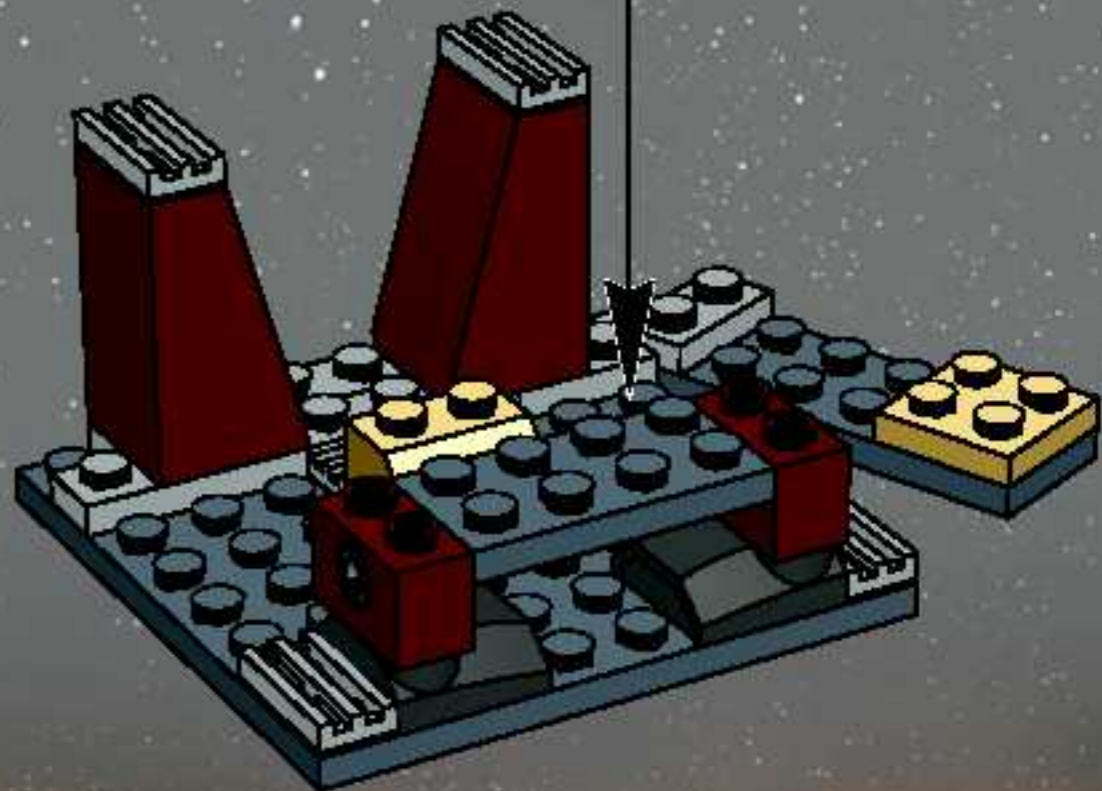

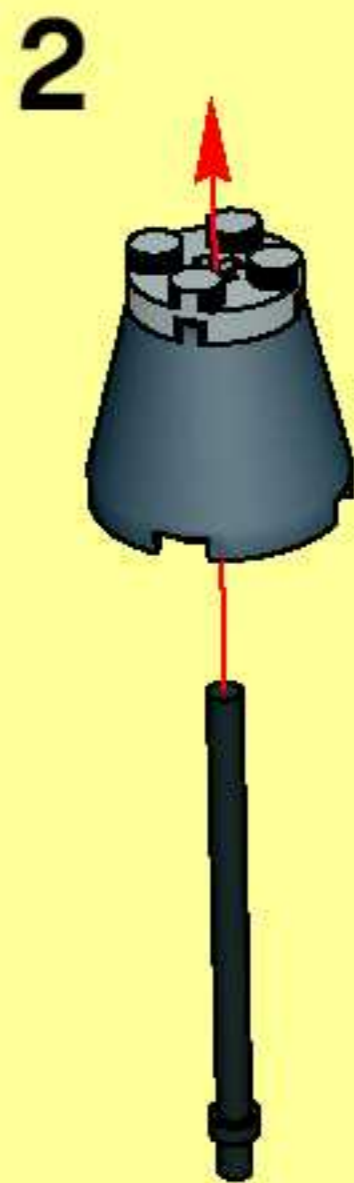
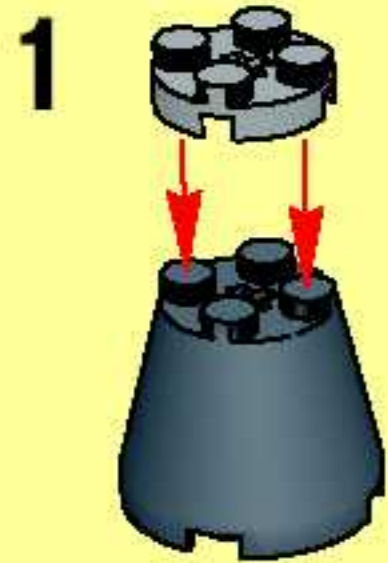

7



1



3



5



2



4



6



7



8



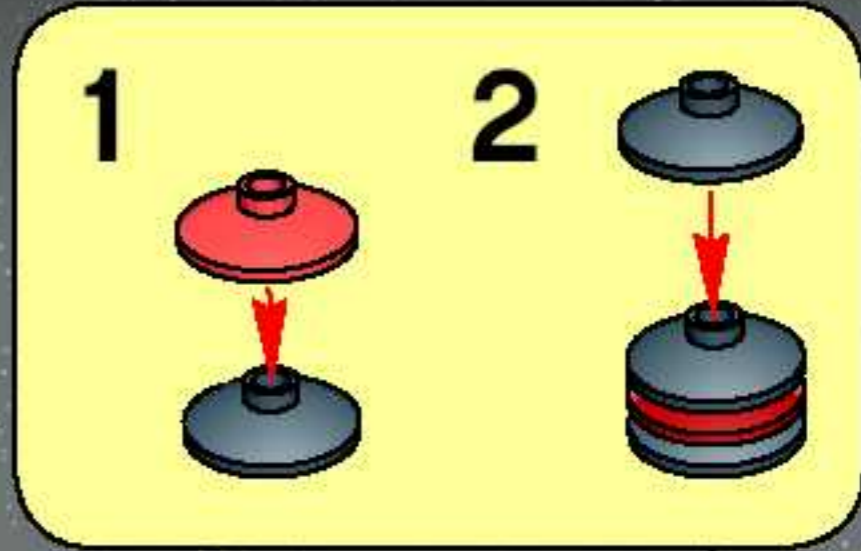
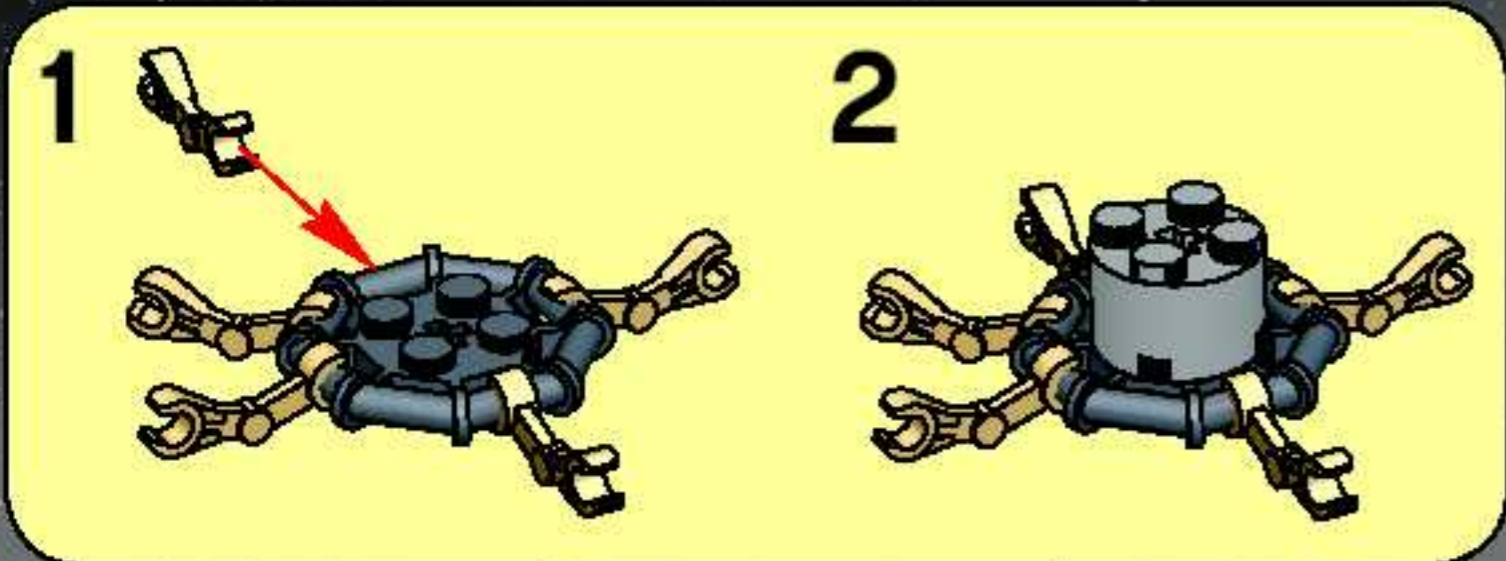

11



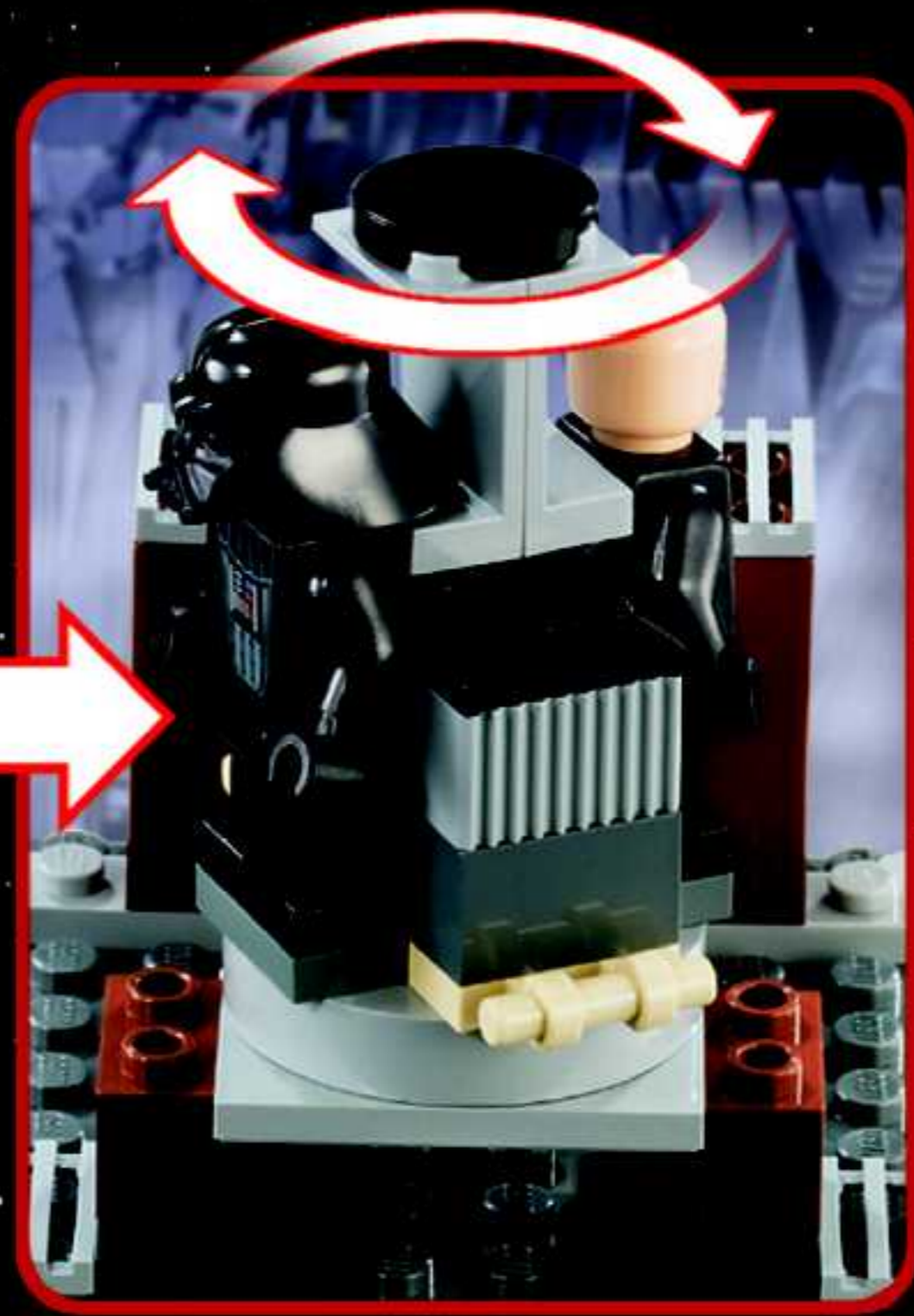





7251
Darth Vader™
Transformation



7256
Jedi Starfighter™
and Vulture Droid™



7259
Arc-170 Starfighter™



7261 Clone Turbo Tank™



7250
Clone
Scout
Walker™



7257 Ultimate Lightsaber™ Duel



7252 Droid Tri-fighter™



7255 General Grievous™ Chase



7260 Wookiee Catamaran™



7258 Wookiee™ Attack



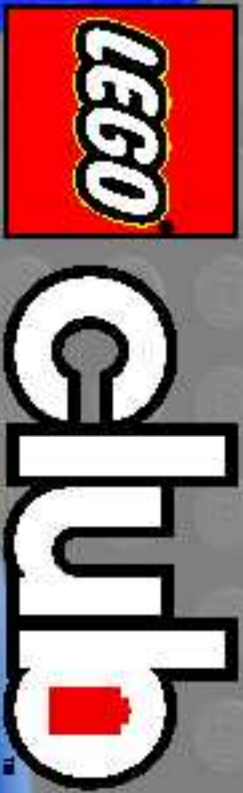

Win!

Gagne!

WIN LEGO® PRODUCTS

Log on to www.acnielsen.dk/LEGO for further instructions.

GAGNE DES PRODUITS LEGO®

Visite www.acnielsen.dk/LEGO pour plus d'informations.

ESTIMADO USARIO LEGO®

Al contestar algunas preguntas en Ingles, frances, aleman o Japones en el sitio www.acnielsen.dk/LEGO,

podras participar en el sorteo de algunas valiosos premios LEGO®.

www.acnielsen.dk/LEGO



FREE!

Each LEGO Magazine Features...

- Awesome creations by Kids like you!
- Cool Comics & Stories
- Building Tips & Ideas
- Special Offers & Contest to WIN Prizes!

GRATUIT!

Chaque Magazine LEGO offre...

- Des créations épatantes par des jeunes comme toi!
- Des bandes dessinées et des récits super cool
- Des idées de construction
- Des offres spéciales et des concours pour gagner des prix!



Join Today!

Abonne-toi dès aujourd'hui!

1-866-534-6258

www.LEGOclub.com



LEGO, the LEGO logo are trademarks of/sonr des marques de commerce de/The LEGO Group. ©2005 The LEGO Group.

YES! I WANT TO JOIN THE LEGO® CLUB!

This coupon is good for 1 FREE 2-year Club membership. Additional kids may sign up for \$7.95 in the US, and in Canada 10.70 (including taxes).

PLEASE PRINT IN ALL CAPITAL LETTERS

OUI! JOIGNEZ-MOI AU CLUB LEGO®!

Ce coupon est valide pour 1 abonnement GRATUIT de 2 ans. Enfants additionnels peuvent s'inscrire pour 10,70 \$ (taxes incluses).

S.V.P. IMPRIMER EN LETTRES MAJUSCULES.

B125

Name/Nom _____ Age _____

Français English

Address/Adresse _____

Girl/Fille Boy/Garçon

City/Ville _____ State/Prov. _____

Postal Code Code Postal _____

E-mail Address/Courriel _____ Date of Birth Date de Naissance ____/____/____

Parent's Signature/Signature d'un parent _____



Mail to/Poster à: LEGO Club
P. O. 1157
Enfield, CT 06083-1157

Offer limited to residents of US and Canada. No photocopies will be accepted. Offer limited to two free memberships per family, group or organization. Please allow 4-6 weeks for delivery of your first mailing.
Offre limitée pour résidents du US et Canada. Photocopies ne seront pas acceptées. Offre limitée à deux abonnements gratuits par famille, groupe, ou organisation. Attendez 4-6 semaines pour la première livraison.



SHOP at HOME

The World's Biggest LEGO® Shop!



**For a Free Catalog
in the U.S. and Canada,
call toll-free:
1-800-446-8107
Or go online:
www.LEGOshop.com/catalog**

**Pour obtenir un Catalogue
GRATUIT aux États-Unis
et au Canada,
téléphonez sans frais au :
1-800-267-5346
Ou venez en ligne sur :
www.LEGOshop.com/catalog**

LEGO, the LEGO logo are trademarks of the LEGO Group.
©2005 The LEGO Group.

FREE LEGO® Catalog!

Please print with a pen in capital letters.

First Name
Prénom _____

Last Name
Nom _____

Address
Adresse _____

City
Ville _____

Phone (optional)
No de téléphone
(optionnel) _____

Email (optional)
Courriel (optionnel) _____

Check Below / Indiquez ci-bas

I speak English

Je parle Français

Boy/Garçon

Girl/Fille

State
Prov _____

Zip Code
Code Postal _____



U.S. and Canada only
E.-U. et Canada seulement



Mail to/Poster à:



SHOP at HOME

**P. O. Box 1221
Enfield, CT 06083-1221**

Please allow 2-4 weeks for delivery.

veuillez s.v.p. allouer 2 à 4 semaines pour l'expédition.

Catalogue LEGO® Gratuit! CRBPØ5

S.V.P. Écrire en lettres majuscules avec un stylo à bille noir.

LEGO STAR WARS™

THE VIDEO GAME



4276596

©2005 The LEGO Group.



LEGO, the LEGO logo and the Minifigure are trademarks of The LEGO Group. © 2004 The LEGO Group. © 2004 Lucasfilm Entertainment Company Ltd. or Lucasfilm Ltd. & ® or TM as indicated. All rights reserved. Microsoft, Xbox and the Xbox logos are either registered trademarks or trademarks of Microsoft Corporation in the U.S. and/or in other countries and are used under license from Microsoft. All rights reserved. "PS" and "PlayStation" are registered trademarks of Sony Computer Entertainment Inc. All rights reserved. GAME BOY ADVANCE IS A TRADEMARK OF NINTENDO. The NVIDIA logo and "The way it's meant to be played" logo are registered trademarks or trademarks of NVIDIA Corporation.