



NEXO KNIGHTS



72005





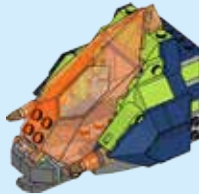
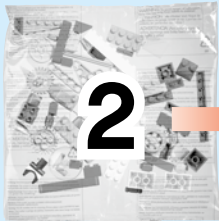



1x



1x



1x



1x

1





1x



1x

2



1x



1x

3



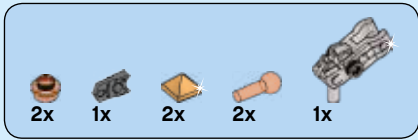

4

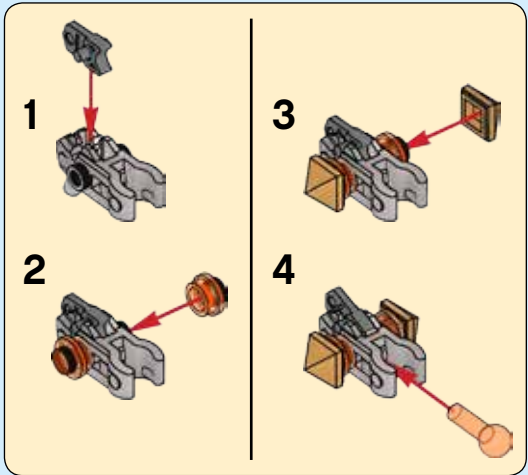

6

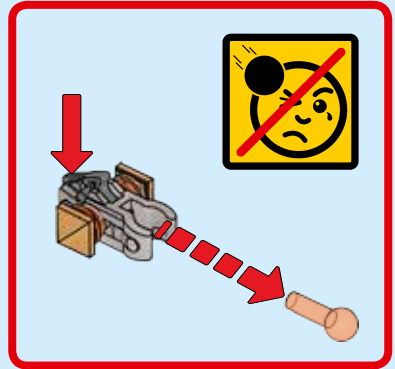

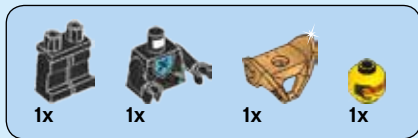

1

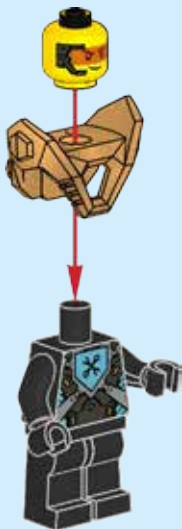

2

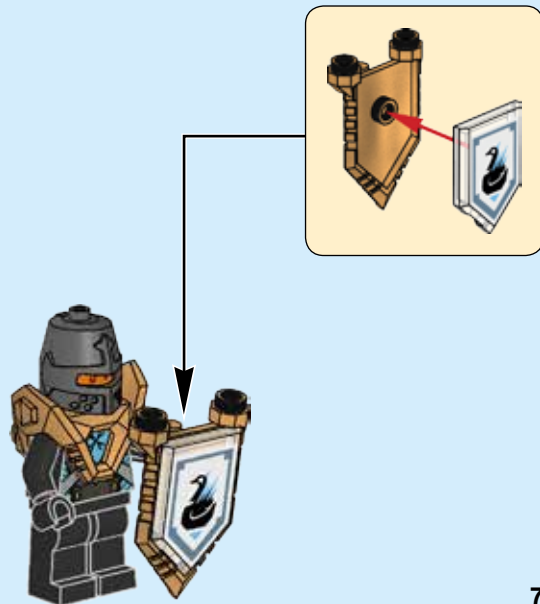

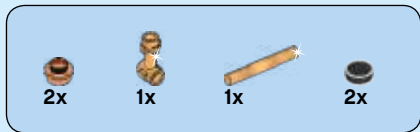

3

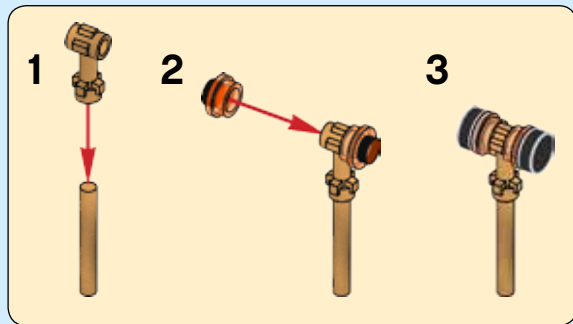

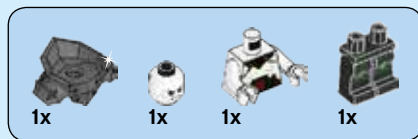

1

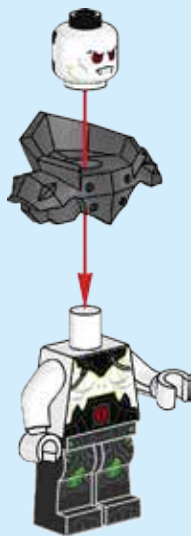

2

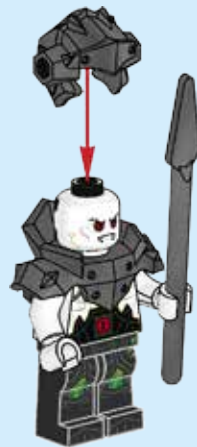

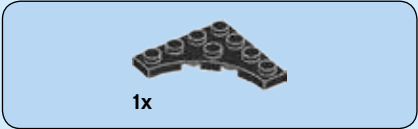

3

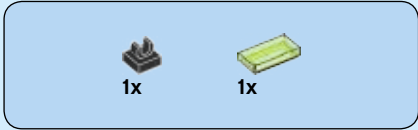

4

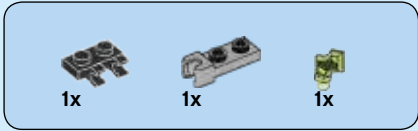
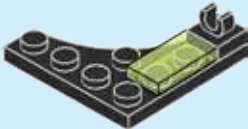

5

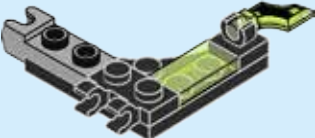



6

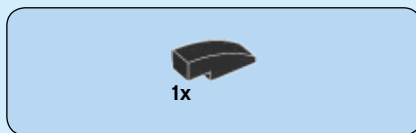
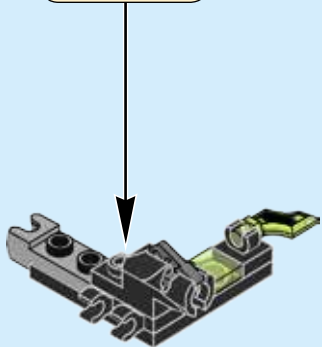
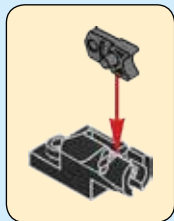

7

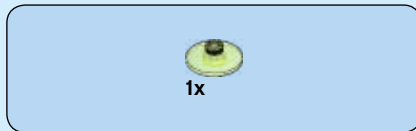
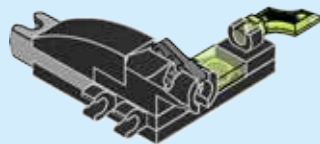

8

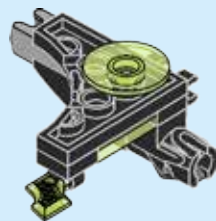
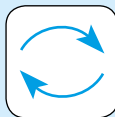

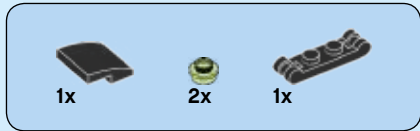

9

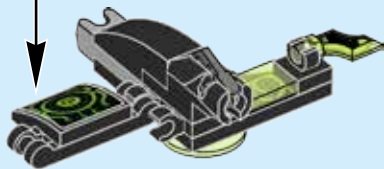
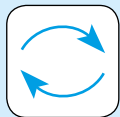
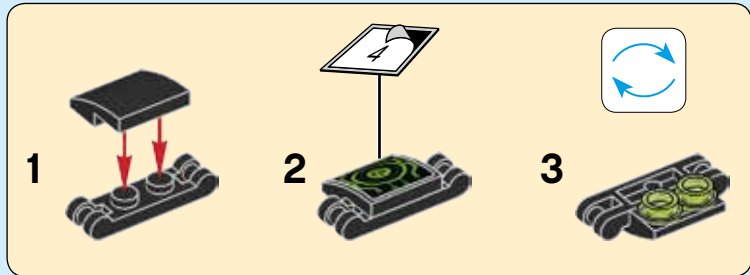



1x

10

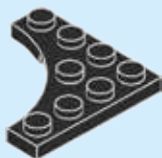

1x



1x

11

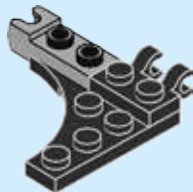

1x



1x

12

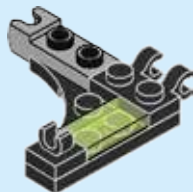

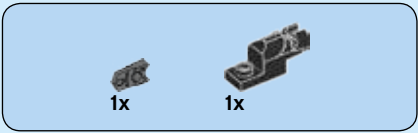

13

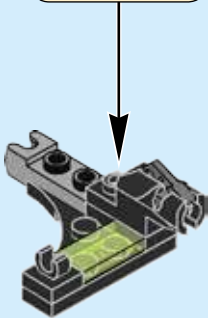

14

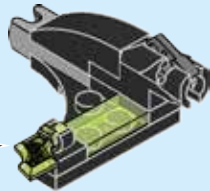

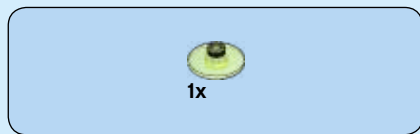

15

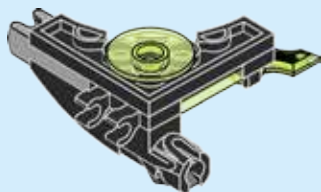
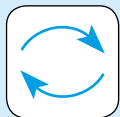

16

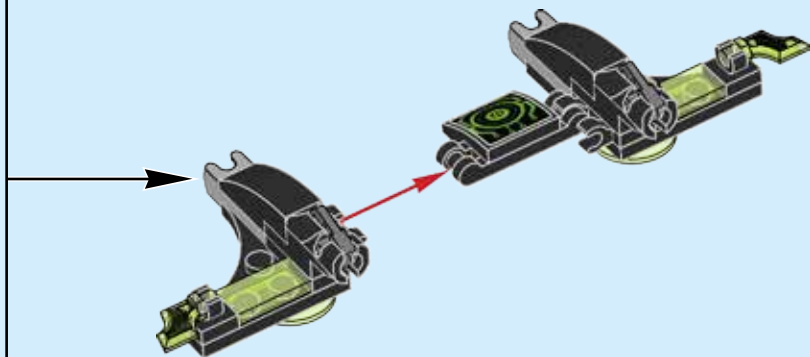



2x

17

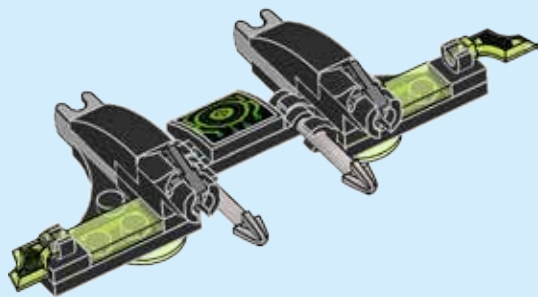

16



3x



3x

18

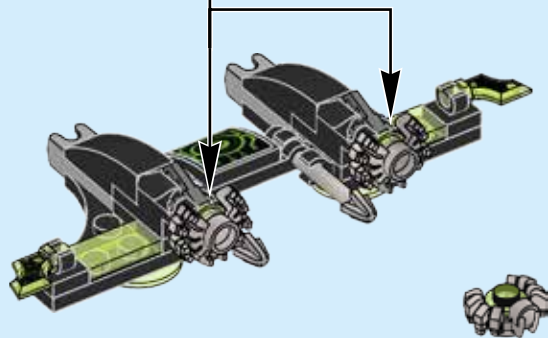
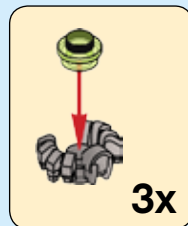

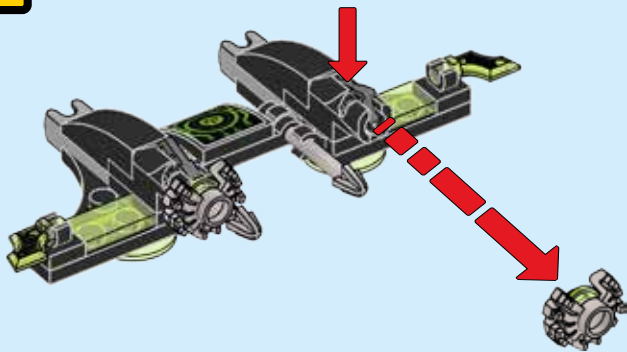

19

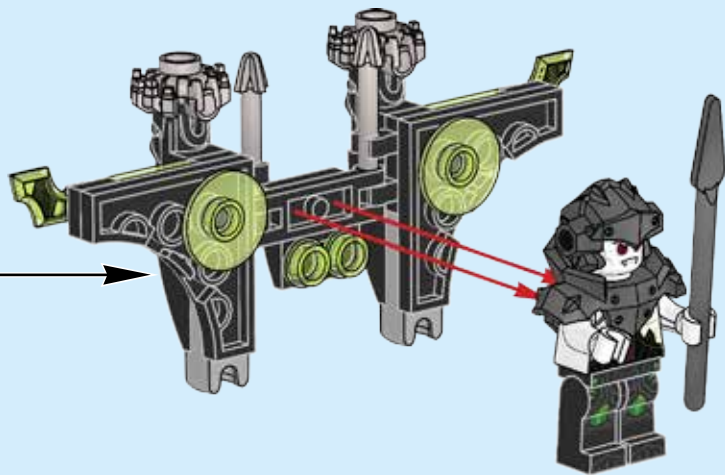

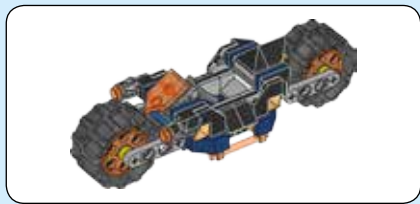

1

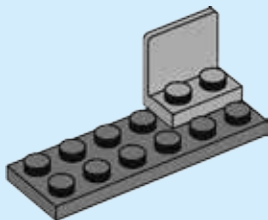

2

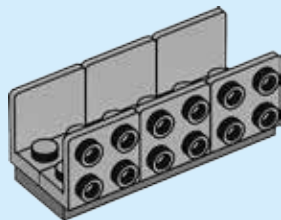



1x

3

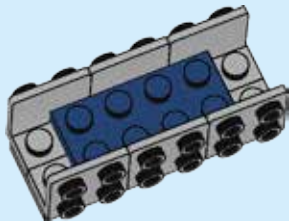

2x

4

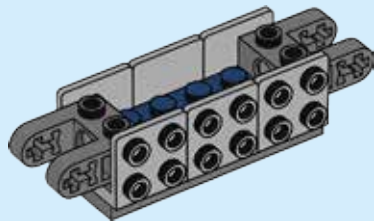

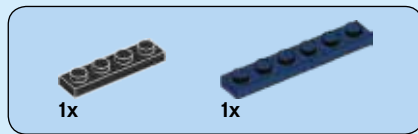

5

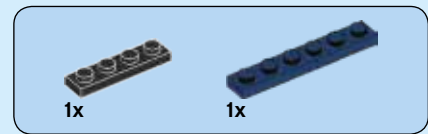
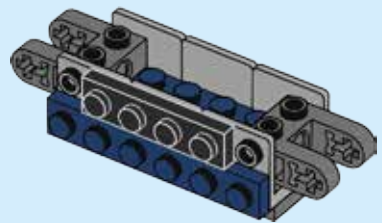
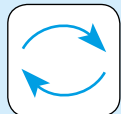

6

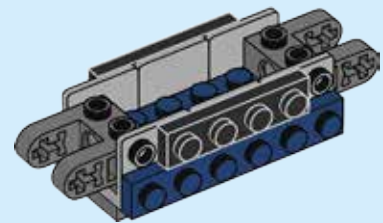
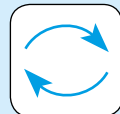

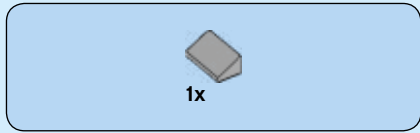

7

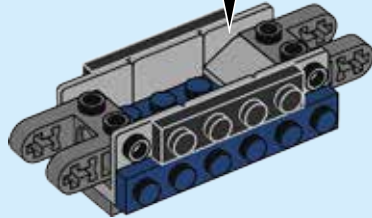
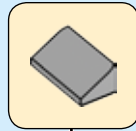

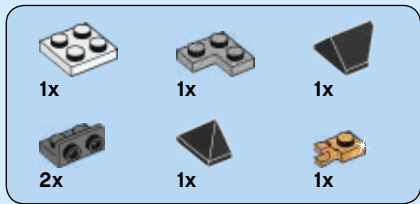

8

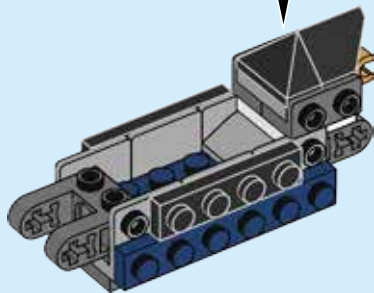
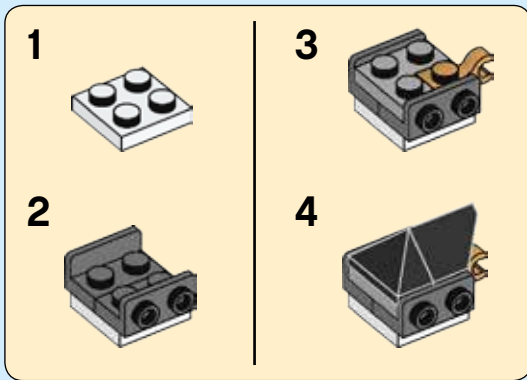

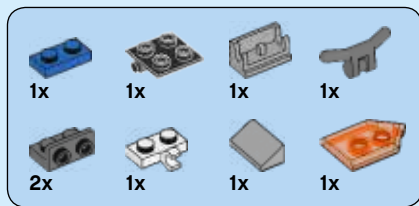

9

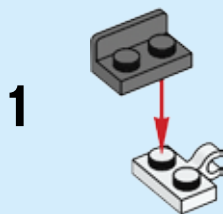

2



3

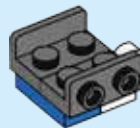

4

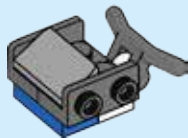

5

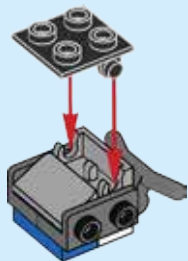

6

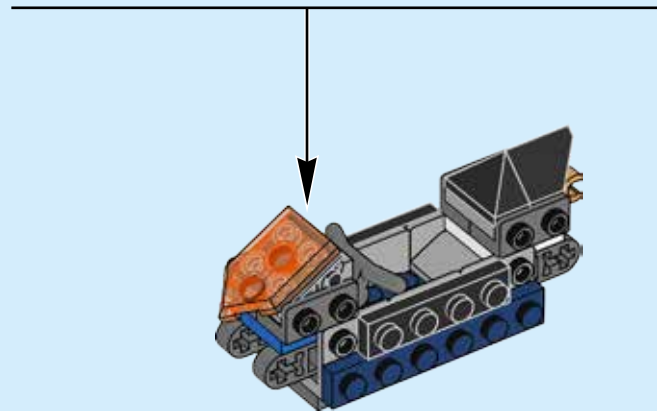



2x



2x

10

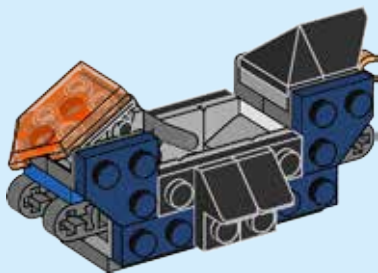

2x



1x

11

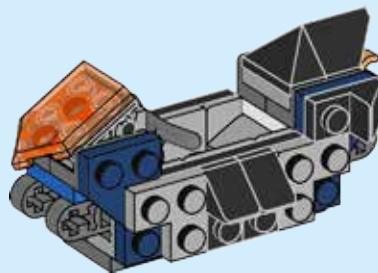



12

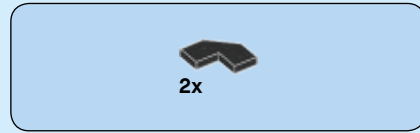
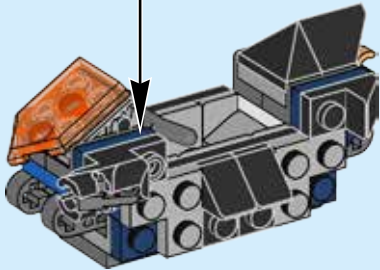
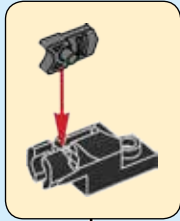

13

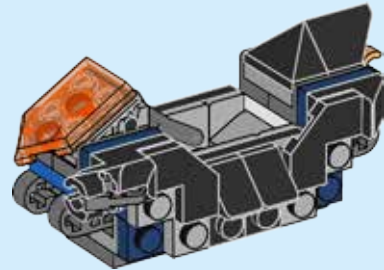



2x



2x

14

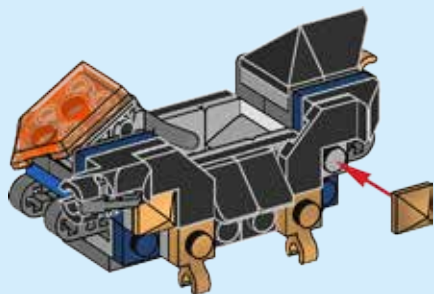

2x

15

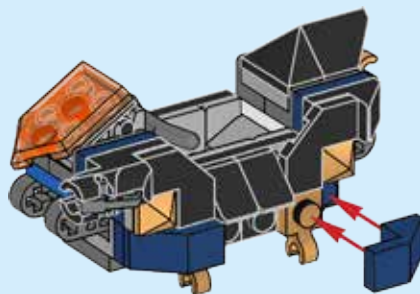

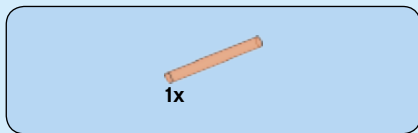

16

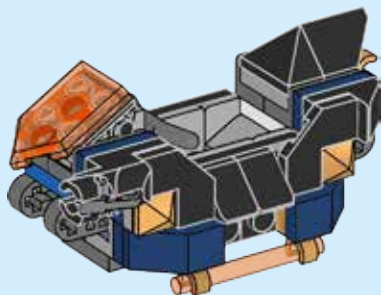

17

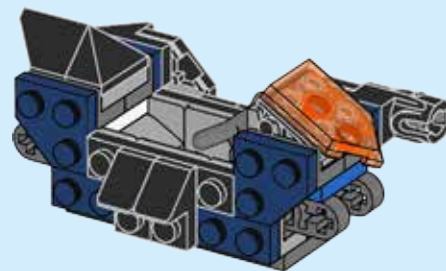
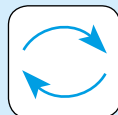



2x



1x

18

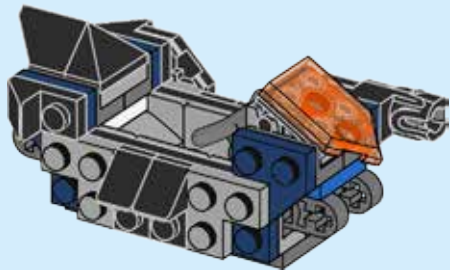

1x



1x

19

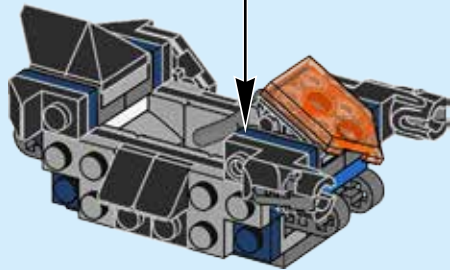
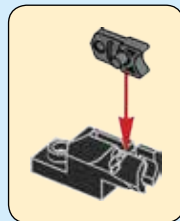



2x

20

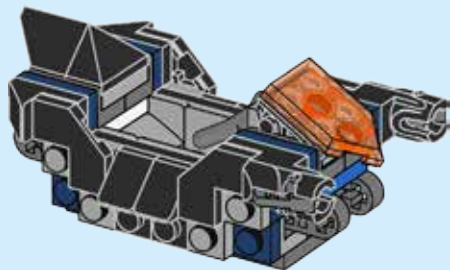

2x



2x

21

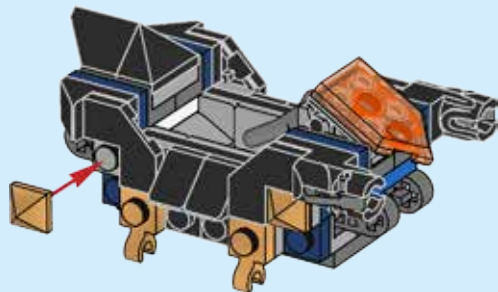



2x

22

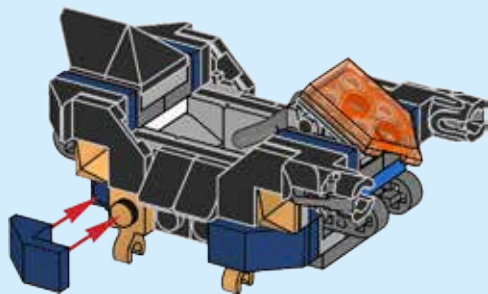

1x

23

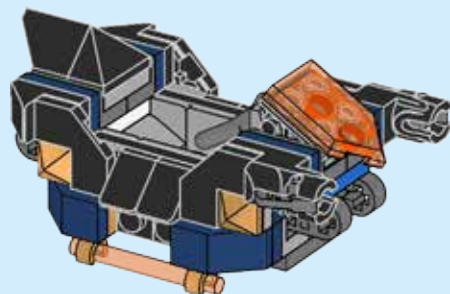

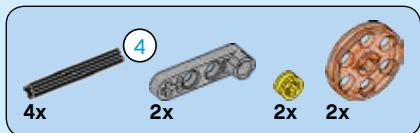

24

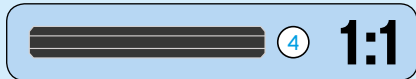
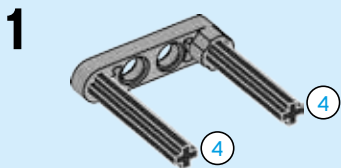

2

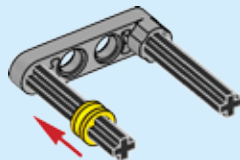

3

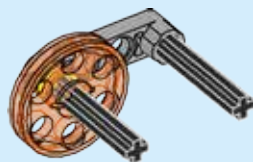

2x

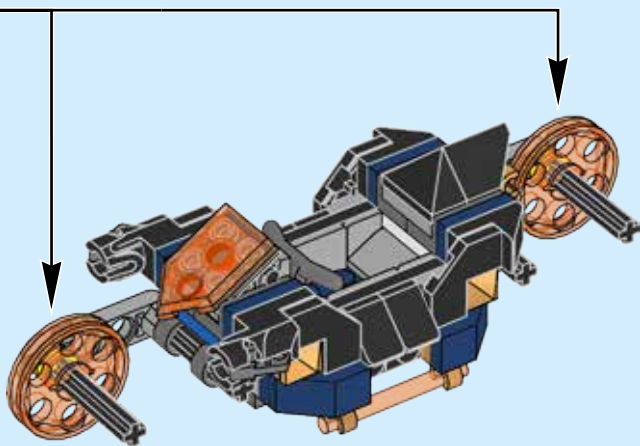
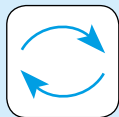



25

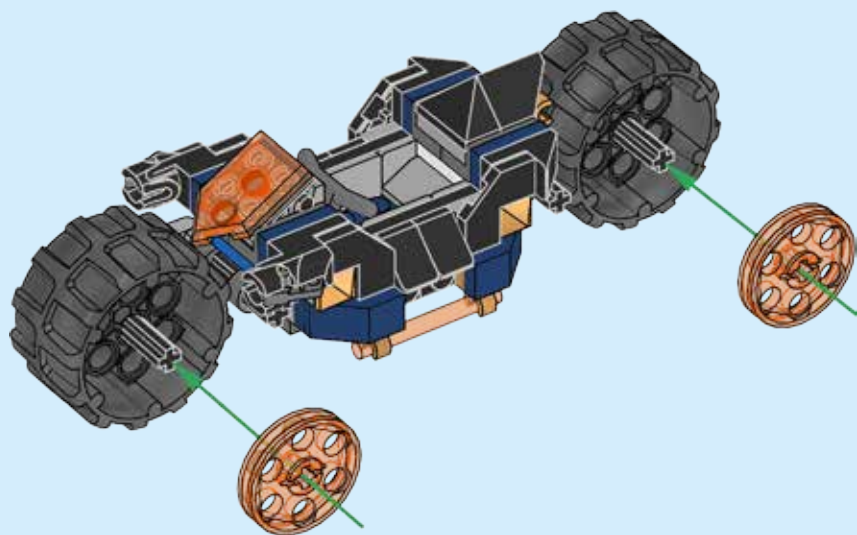



2x

26

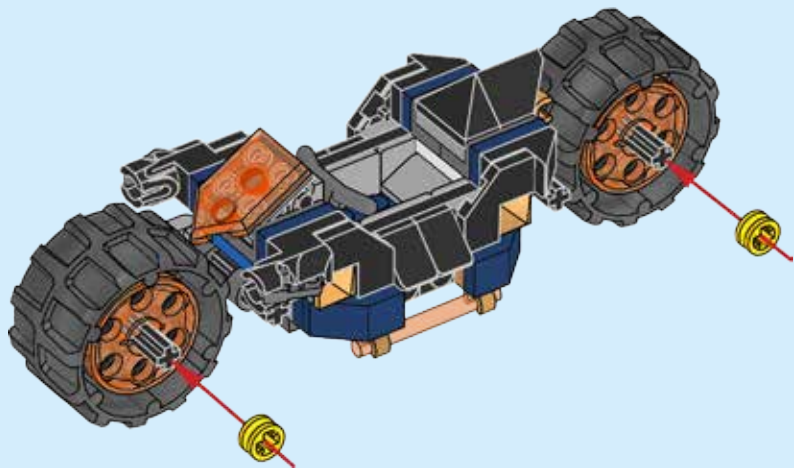



2x

27

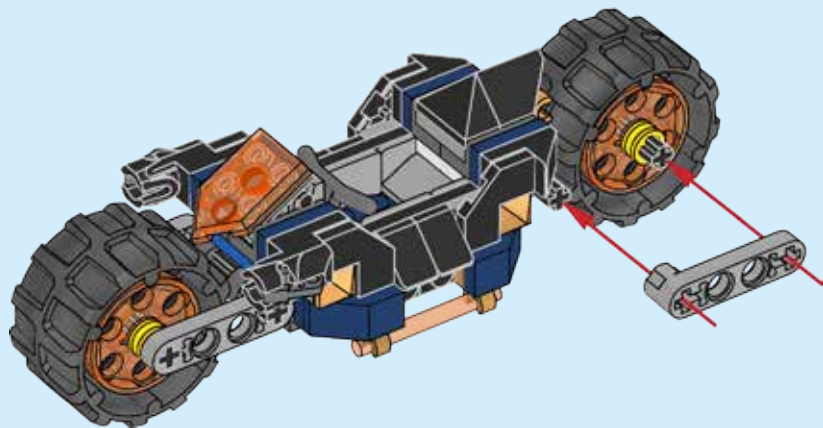



4x

28

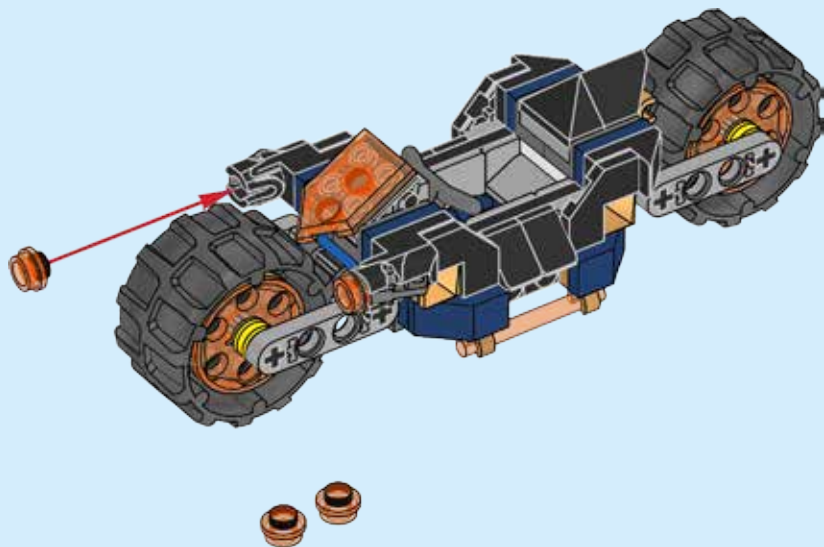

38

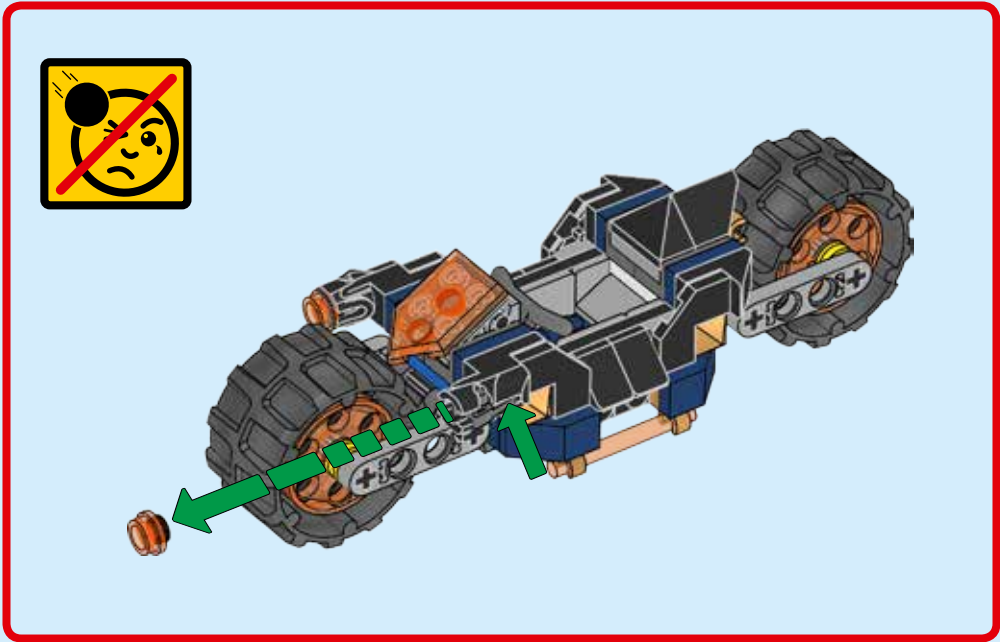

29

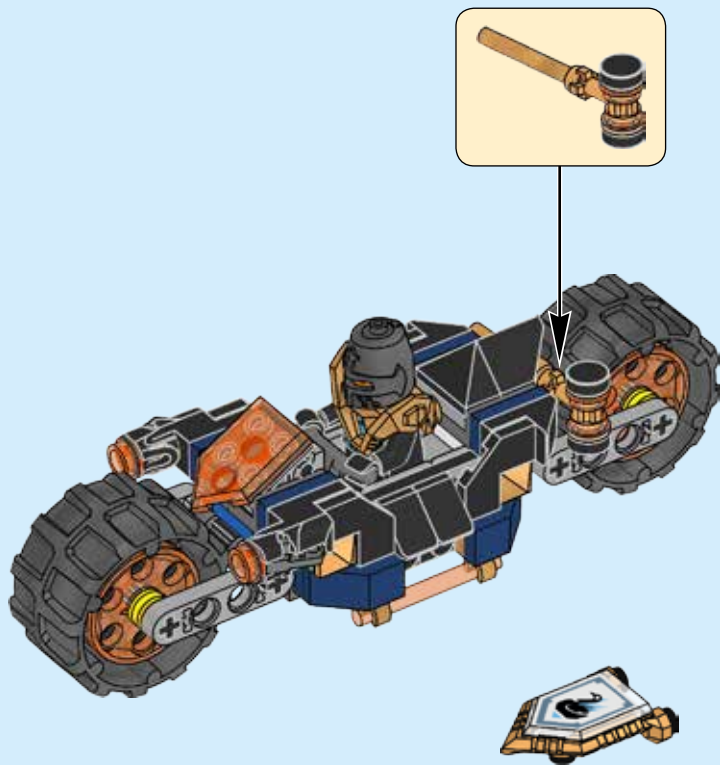

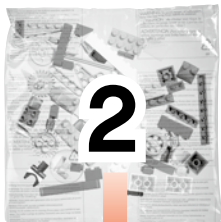

2x



1x

1





1x



1x

2



2x



2x

3

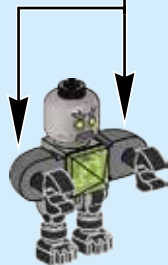
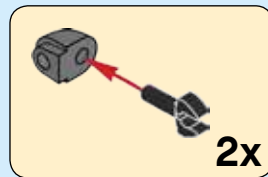

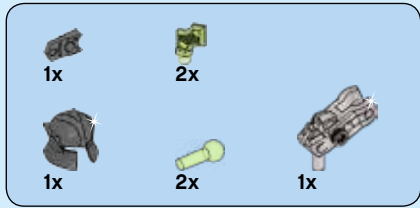

4

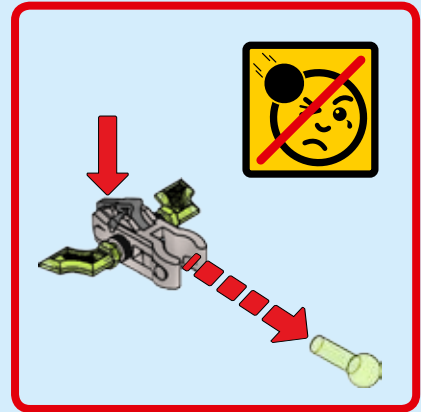
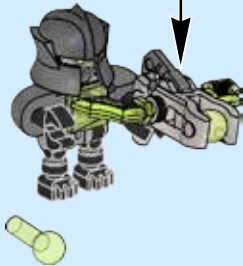
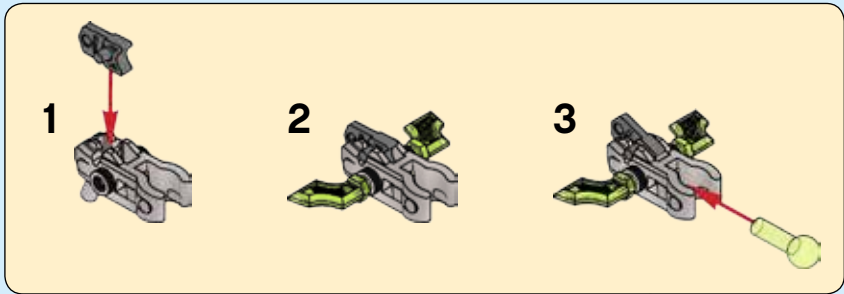



1

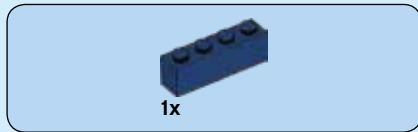

2

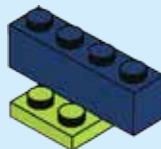



2x

3

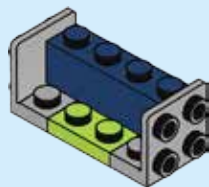

1x

4

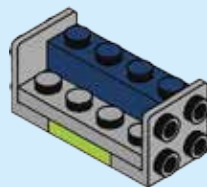



2x

5

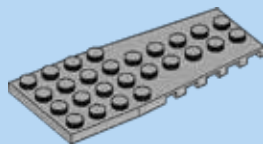
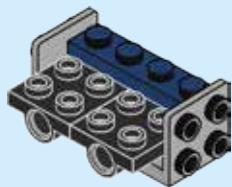

1x

6

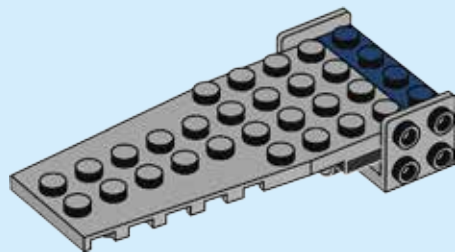

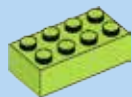

1x

7

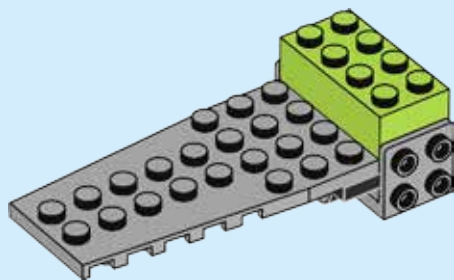

2x

8

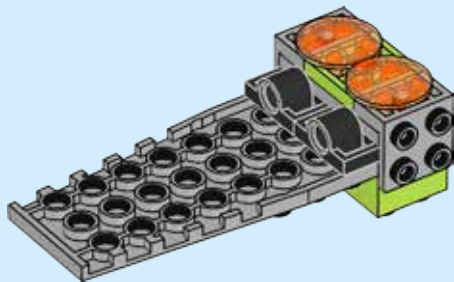
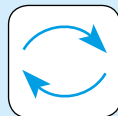



9

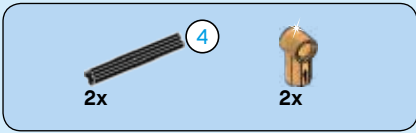
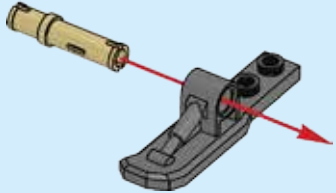

10

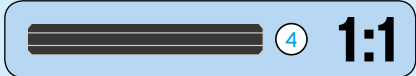
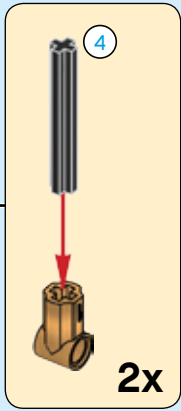
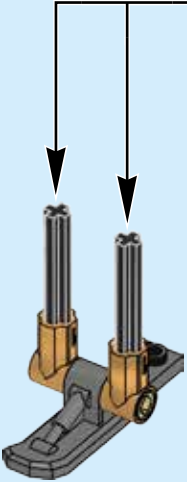



1x

11

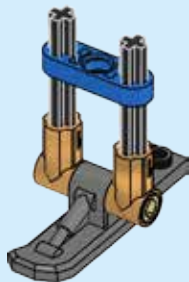

2x

12

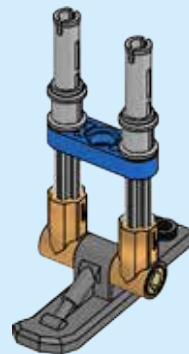

13

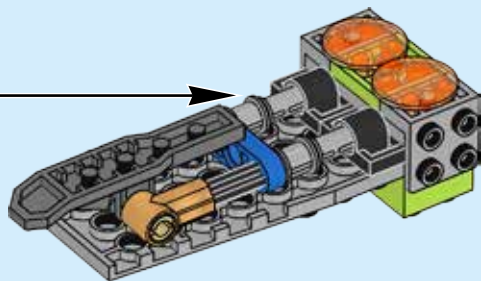

14

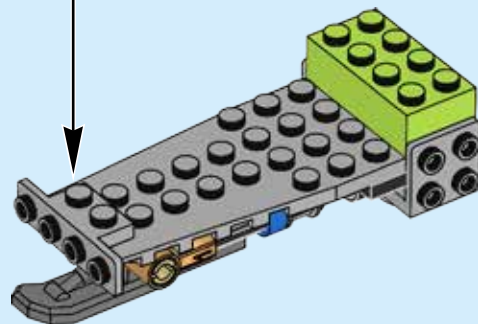
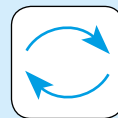
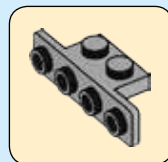
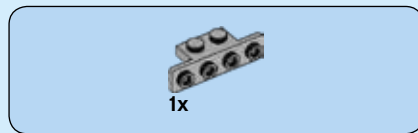

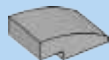

1x

15

1

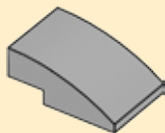

2

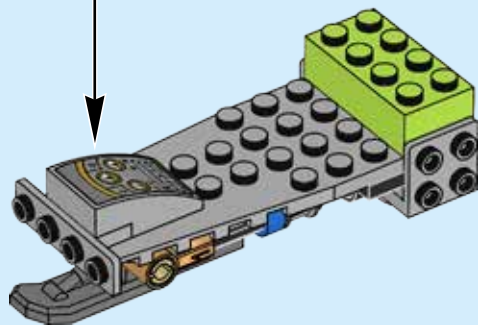

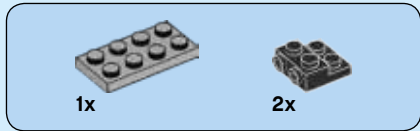

16

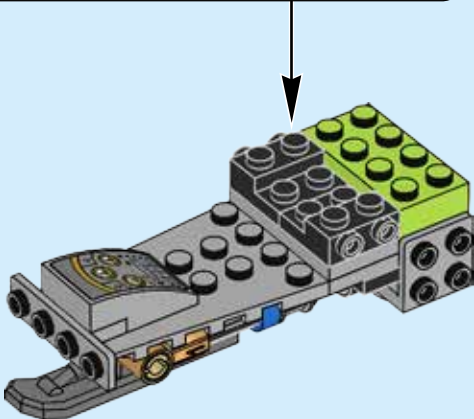
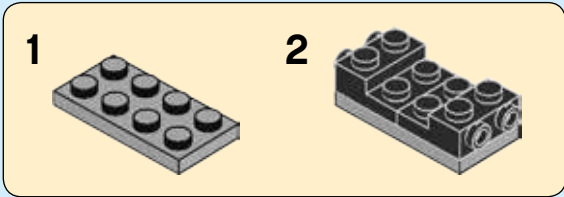



17

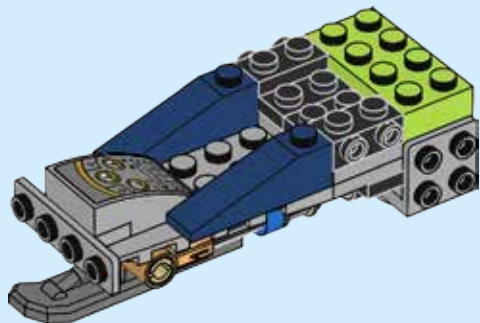

18

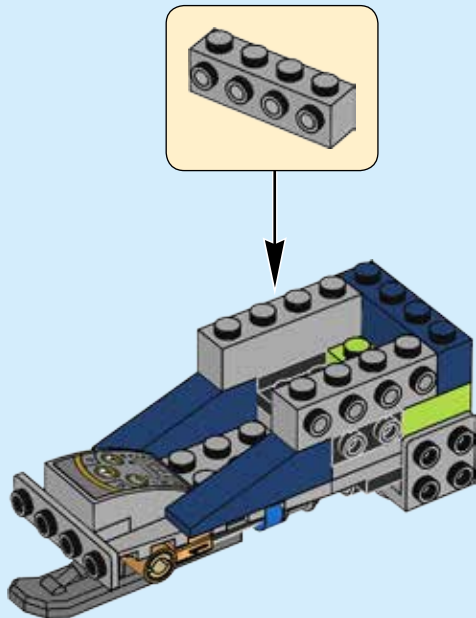

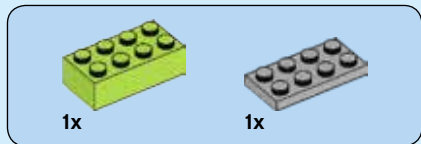

19

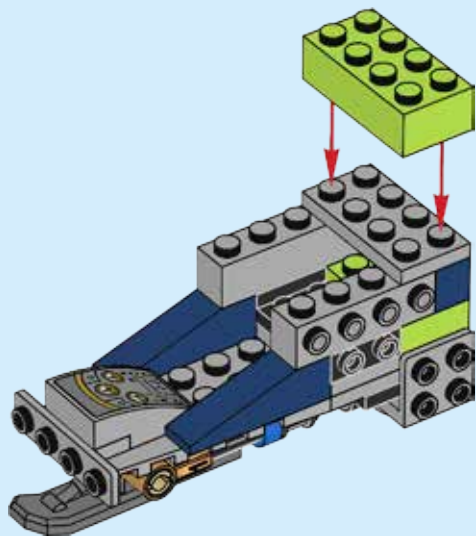

20

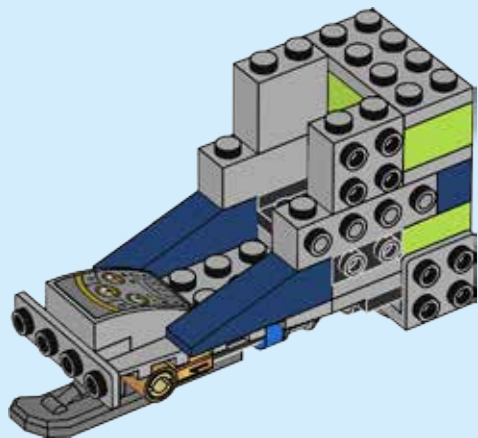

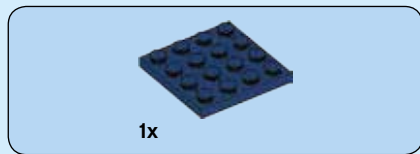

21

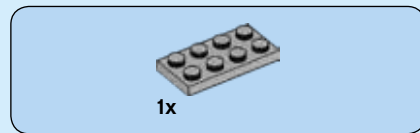
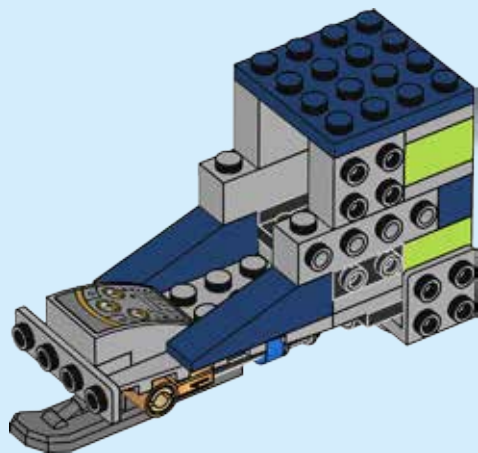

22

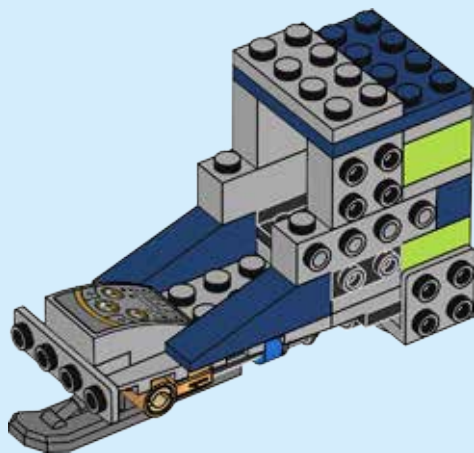



2x

23

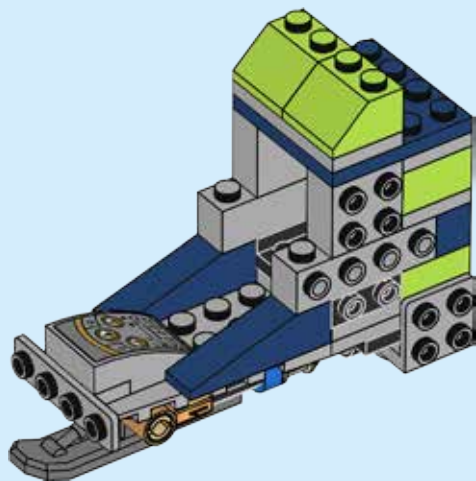

1x

24

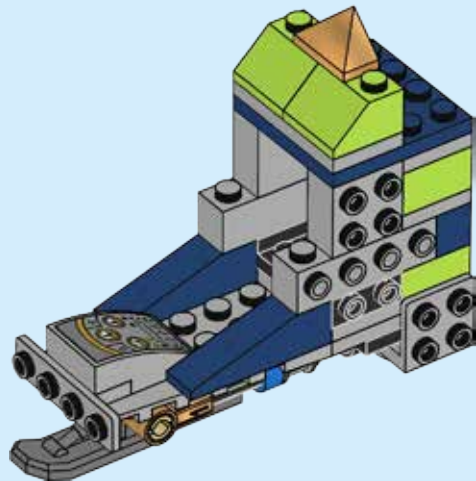

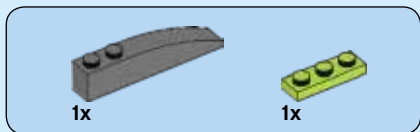

25

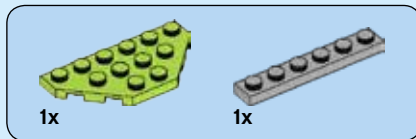
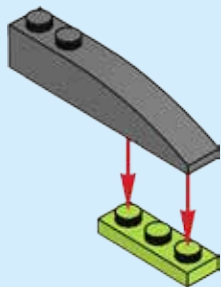

26

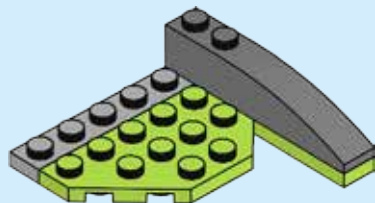

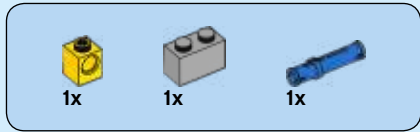

27

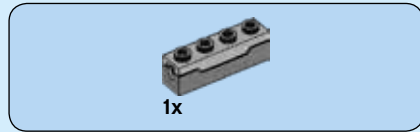
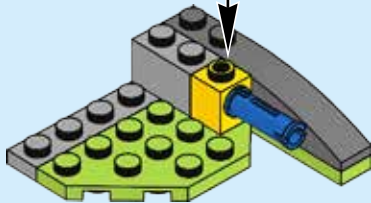
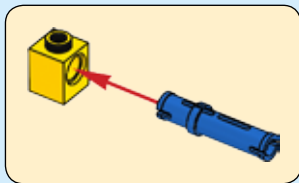

28

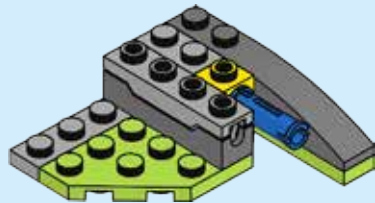

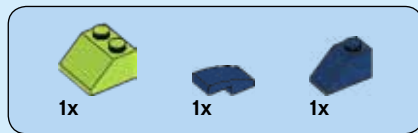

29

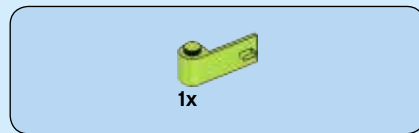
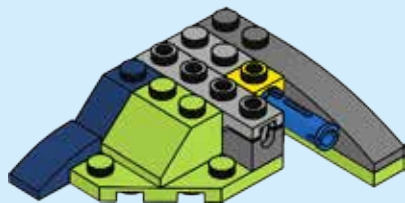

30

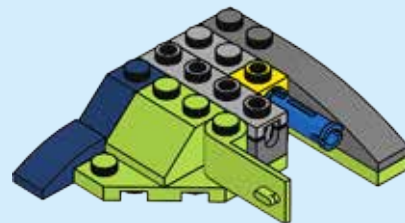

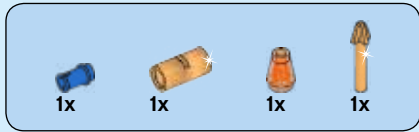

31

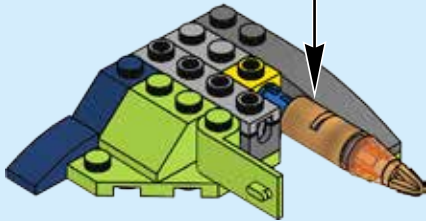
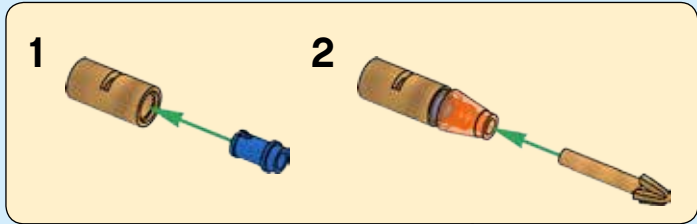

32

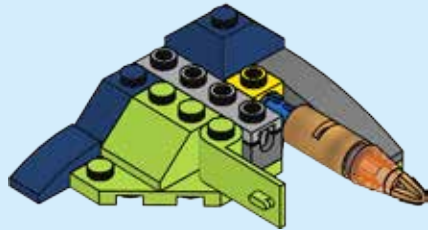



1x



1x

33

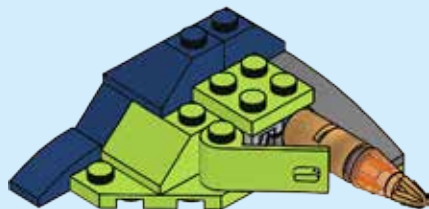

1x

34

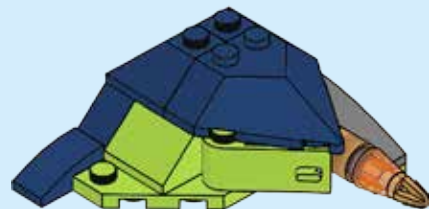



1x

35

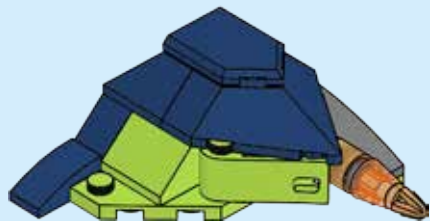

36

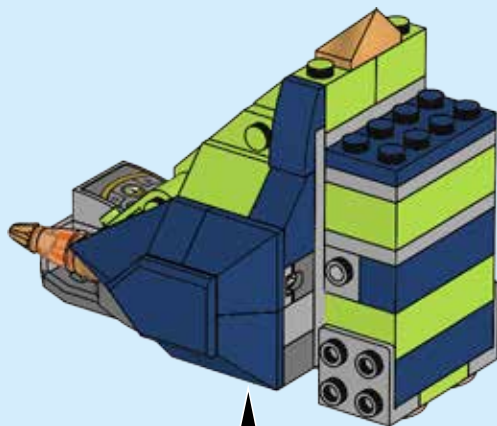

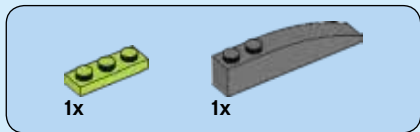

37

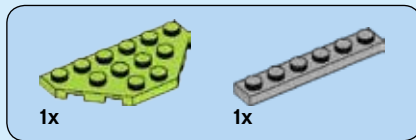
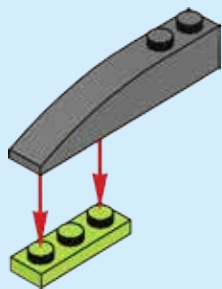

38

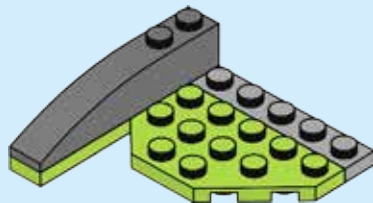

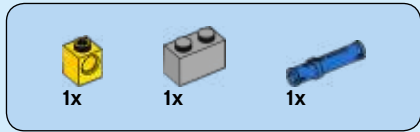

39

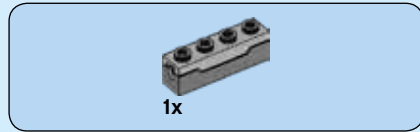
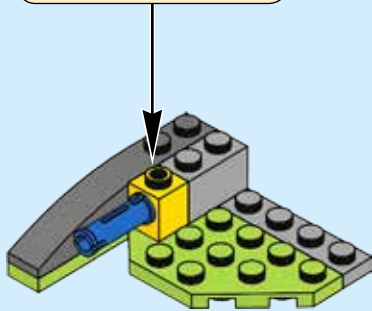
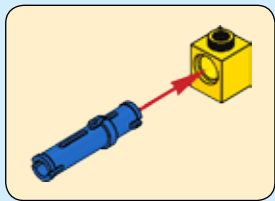

40

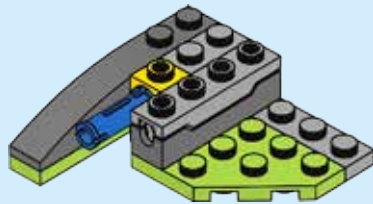

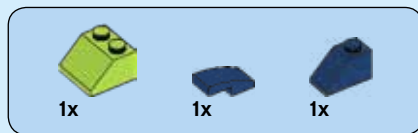

41

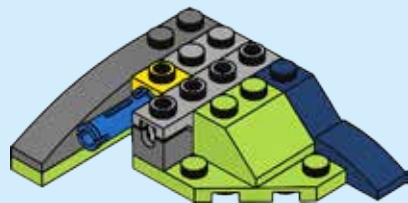

42

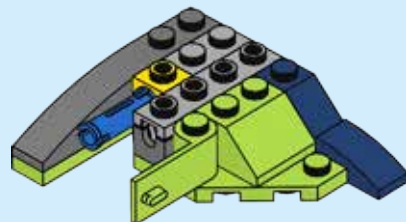



43

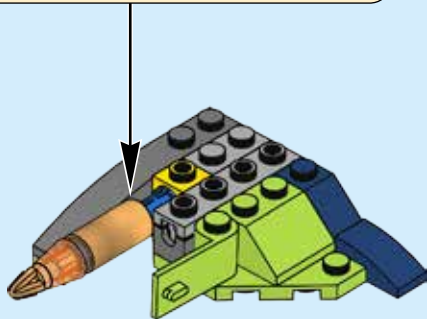
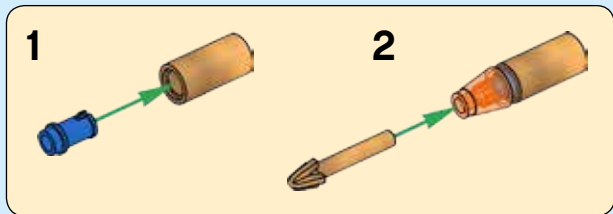

44

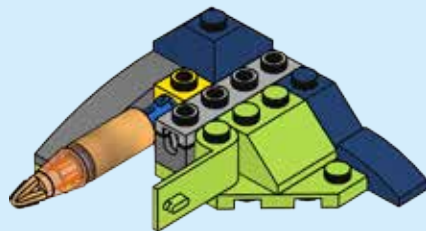



1x



1x

45

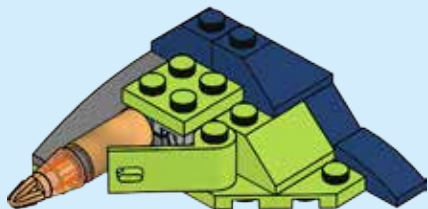

1x

46

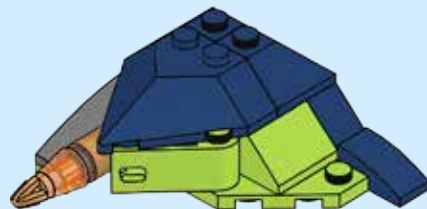



47

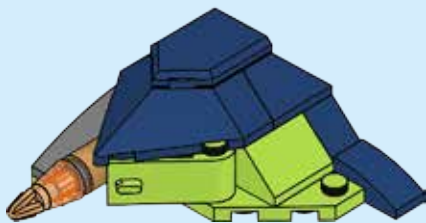

48

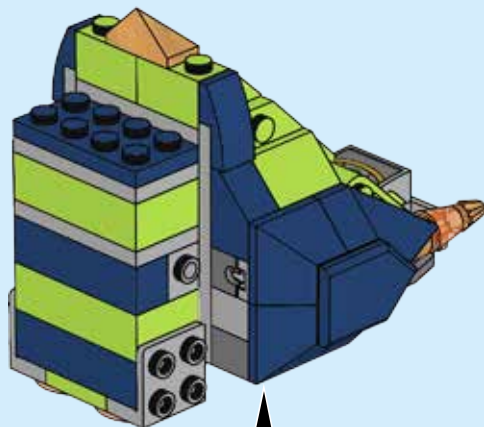
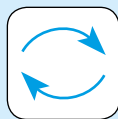

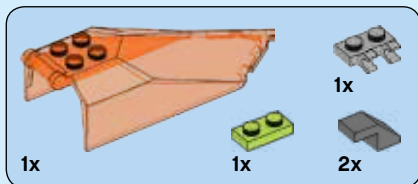

49

1

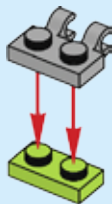

2

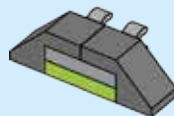

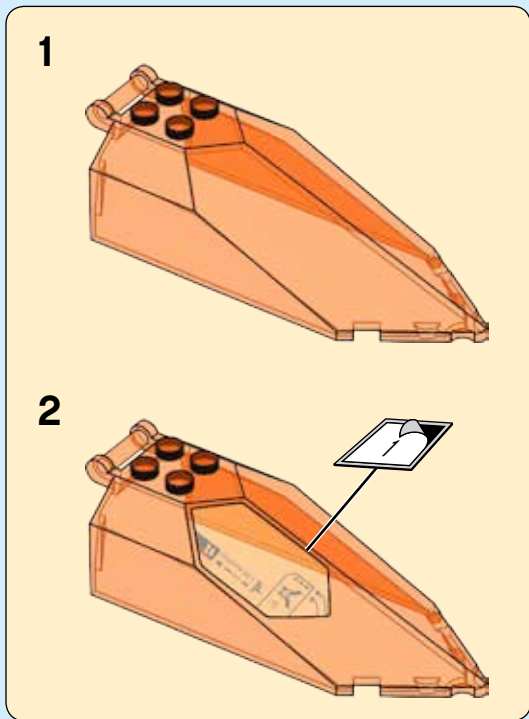

3

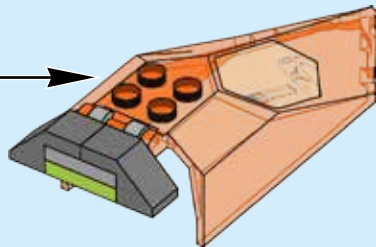

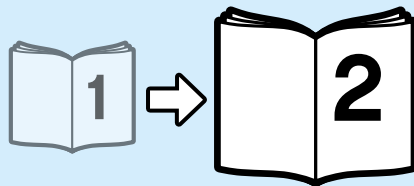
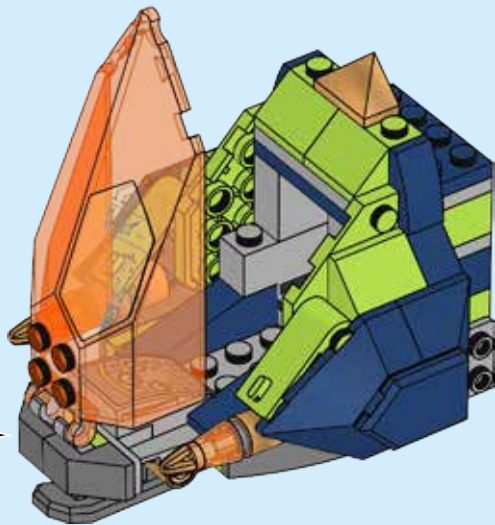
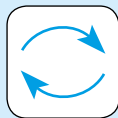

WIN

GO TO WWW.LEGO.COM/PRODUCTFEEDBACK AND
GIVE US YOUR SHORT **FEEDBACK** ABOUT THIS
LEGO® SET FOR A CHANCE TO WIN
A COOL LEGO PRIZE.

Terms & Conditions apply

LEGO.com/productfeedback



GEWINNE

Erzähle uns auf
www.LEGO.com/productfeedback

etwas über die Erfahrungen, die du mit
diesem LEGO® Set gemacht hast, und
sichere dir die Chance auf einen coolen
LEGO Preis!

Es gelten die Teilnahmebedingungen

GAGNE

Rends-toi sur
www.LEGO.com/productfeedback

et donne-nous quelques commentaires sur
ce produit LEGO® pour avoir une chance
de gagner un prix LEGO !

Voir Conditions Générales

GANAN

Visita
www.LEGO.com/productfeedback

y envíanos tu opinión acerca de este set
LEGO®. ¡Participarás en el sorteo de un
premio LEGO!

Términos y Condiciones aplicables

获取奖品

登录
www.LEGO.com/productfeedback

给出关于此乐高®套装的简短反馈，
就有机会获得炫酷乐高奖品

《条款及条件》适用

LEGO, the LEGO logo and NEXO KNIGHTS are trademarks of the LEGO Group. ©2018 The LEGO Group.