



# SUPER MARIO

71432





LEGO.com/sustainable-packaging



FR  
**DONNEZ**  
OU  
**RECYCLEZ**



ASSOCIATION

OU



MAGASIN

OU



DÉCHÈTERIE

Adresses sur [quefairedemesdechets.fr](http://quefairedemesdechets.fr)

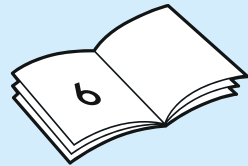
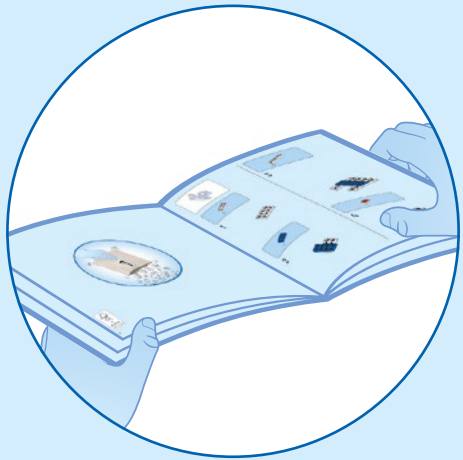
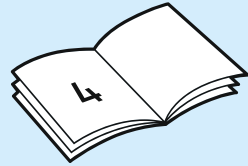



LEGO® Super Mario™ app

## 1. Scan QR code to build from digital building instruction



1. Scan QR code to build from digital building instruction
2. Open digital building instruction
3. Start building

1. Escanea el código QR para construir con instrucciones de construcción digitales
2. Abre las instrucciones de construcción digitales
3. Empieza a construir

1. Für digitale Bauanleitung den QR-Code scannen
2. Digitale Bauanleitung öffnen
3. Der Bauspaß kann beginnen

1. Lê o código QR para construir utilizando as Instruções de Construção digitais
2. Abrir as instruções de construção digitais
3. Começar a construir

1. Scanne le code QR pour construire avec les instructions de montage numériques
2. Ouvre les instructions de montage numériques
3. Commence à construire

1. 扫描二维码, 在数字拼搭说明的协助下拼搭
2. 打开数字拼搭说明
3. 开始拼搭

1. Scansiona il codice QR per scaricare le istruzioni digitali per costruire
2. Apri le istruzioni digitali per costruire
3. Inizia a costruire

1. Zeskanuj kod QR, aby budować dzięki cyfrowym instrukcjom budowania
2. Otwórz cyfrową instrukcję budowania
3. Rozpocznij budowanie

## 2. Open digital building instruction

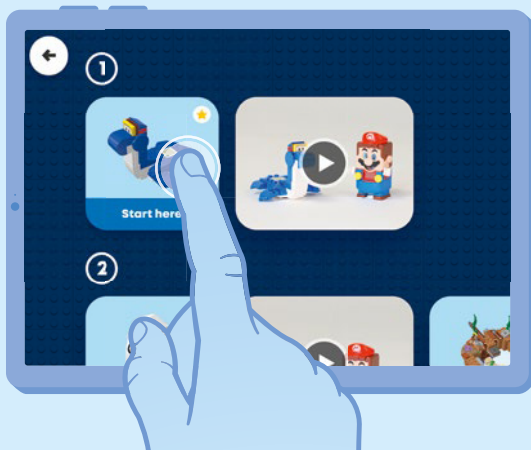

1. Naskenujte QR kód a stavte podle digitálního návodu
2. Otevřete digitální návod na stavění
3. Pusťte se do stavění

1. Сканирайте QR кода, за да започнете строите с цифрови инструкции за построяване
2. Отворете цифровите инструкции за построяване
3. Започнете да строите

1. Naskenujte QR kód a stavajte podľa digitálneho návodu
2. Otvorte digitálny návod na stavanie
3. Pusťte sa do stavania

1. Skenē QR kodu, lai būvētu, izmantojot digitālas būvēšanas instrukcijas
2. Atver digitālo būvēšanas instrukciju
3. Sākt būvēt

## 3. Start building

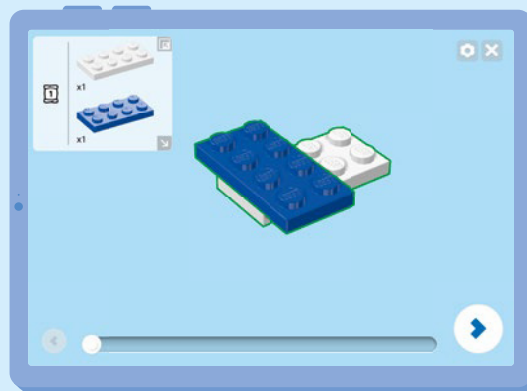

1. Olvasd be a QR-kódot a digitális építési útmutató használatához!
2. Digitális építési útmutató megnyitása
3. Kezdődjön az építés!

1. Skanni QR-kood, et ehitada digitaalsete ehitusjuhisteiga
2. Ava digitaalsed ehitusjuhised
3. Alusta ehitamist

1. Scanează codul QR pentru a construi pe baza instrucțiunilor digitale
2. Deschide instrucțiunile de construcție digitale
3. Începe să construiești

1. Nuskaitykite QR kodą ir konstruokite naudodamiesi instrukcijomis
2. Atidarykite skaitmenines instrukcijas
3. Konstruokite



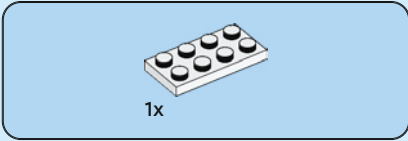
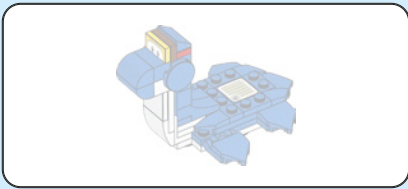

1

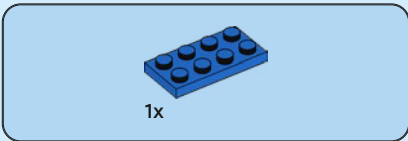
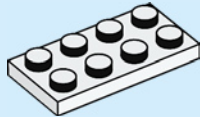

2

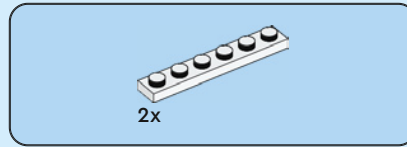
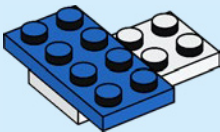

3

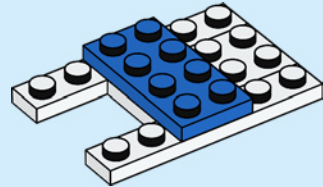

4

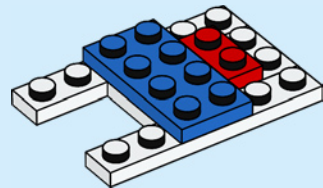

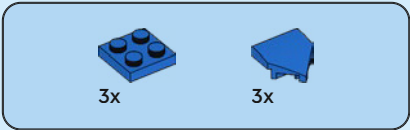

5

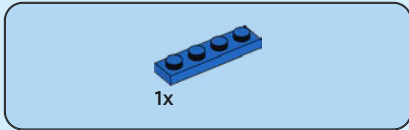
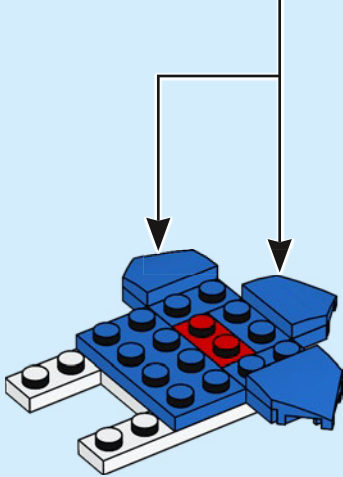
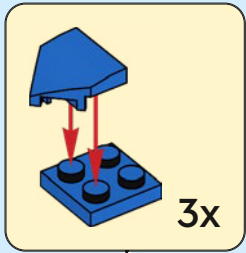

6

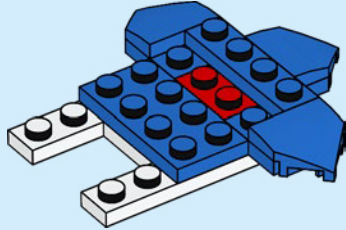

7

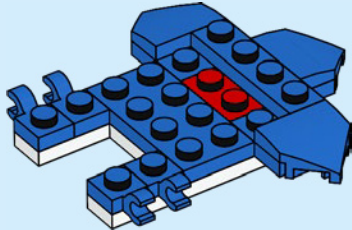



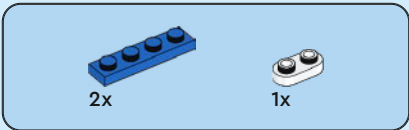

8

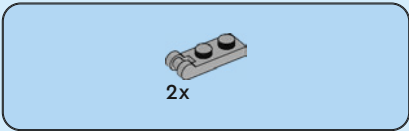
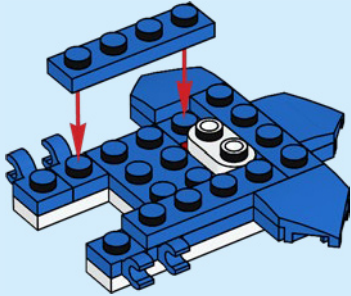

9

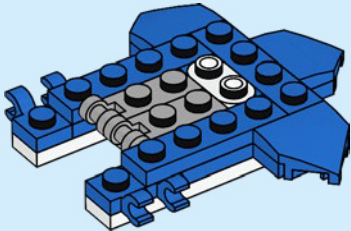

10

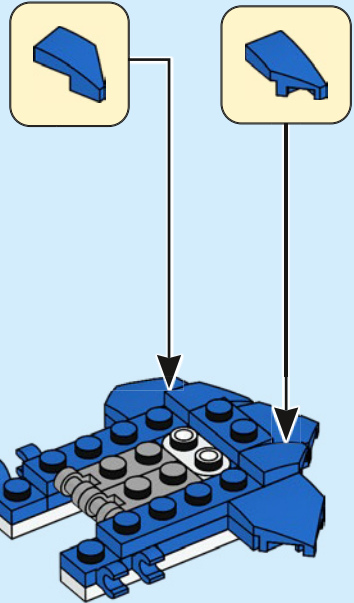

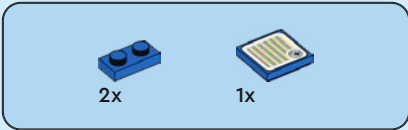

11

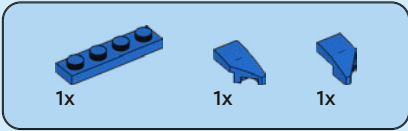
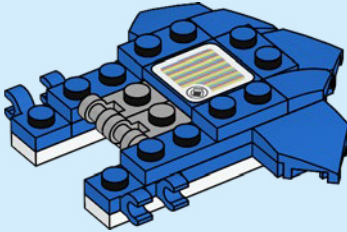

12

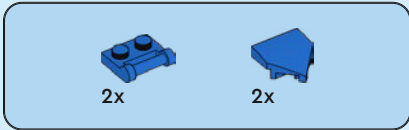
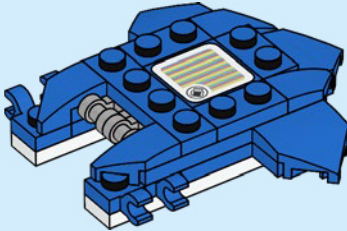

13

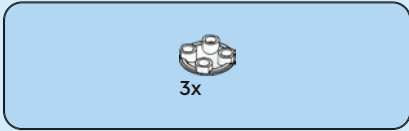
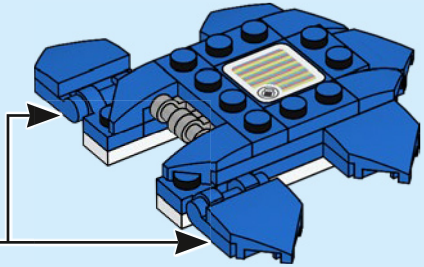
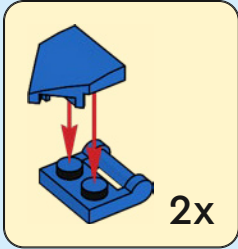

14

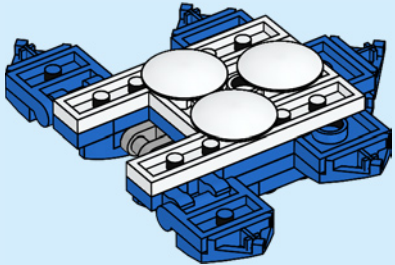

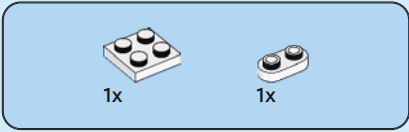

15

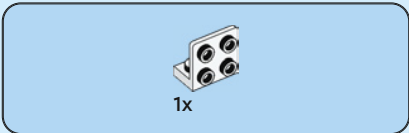
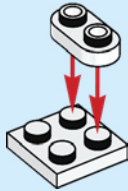

16

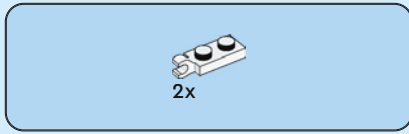
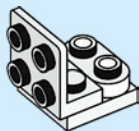

17

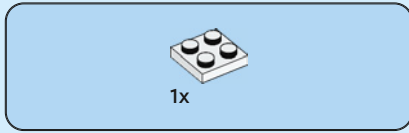
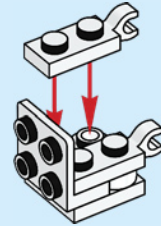

18

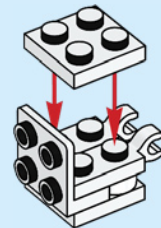



1x

19

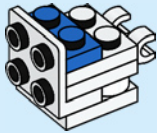

2x

20

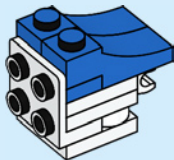

1x

21

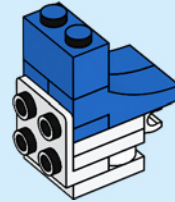

1x

22

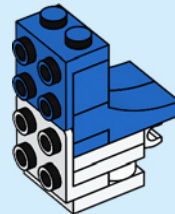

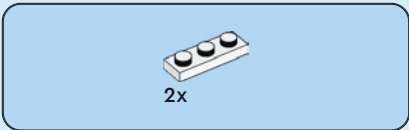

23

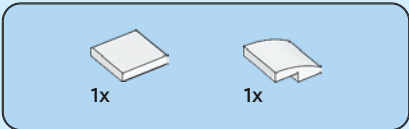
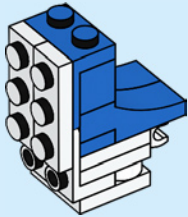

24

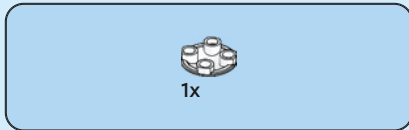
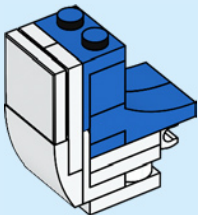

25

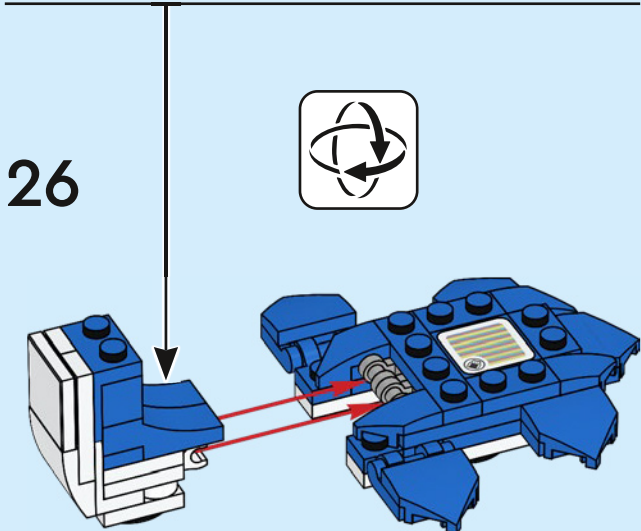
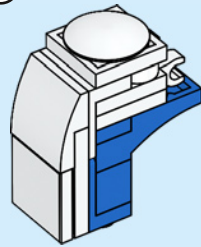
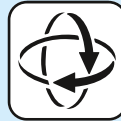



27

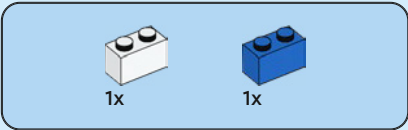
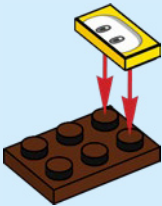

28

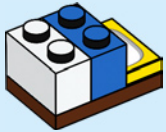

29

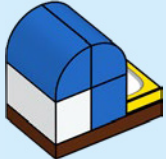

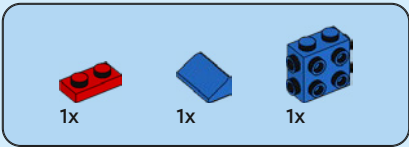

30

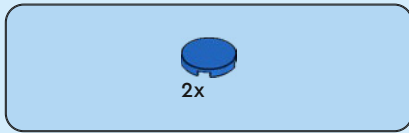
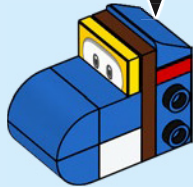
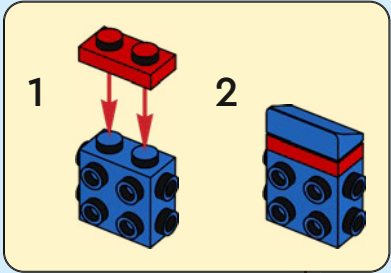

31

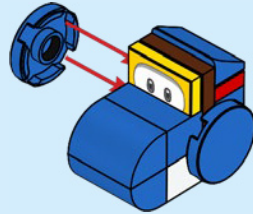

32

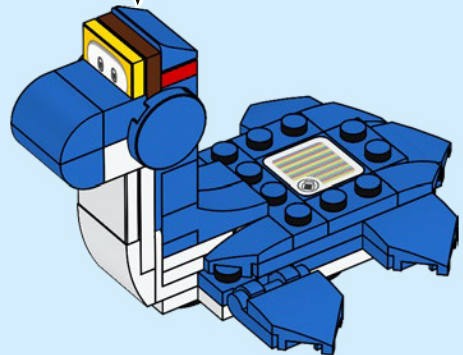

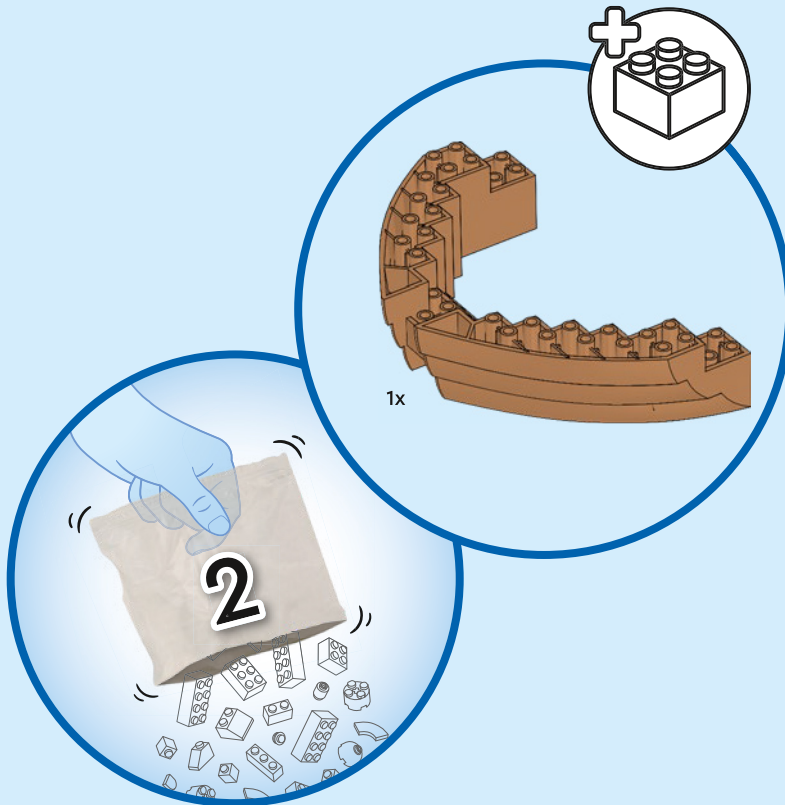





1x

1

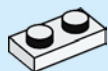

2x

2

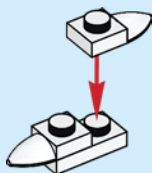

1x

3

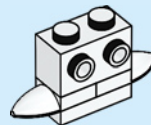

2x

4

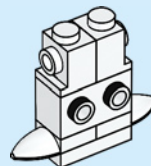

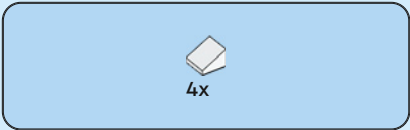

5

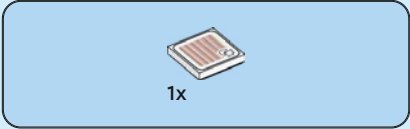

6

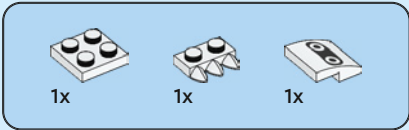
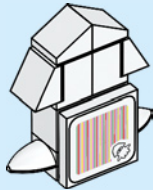

7

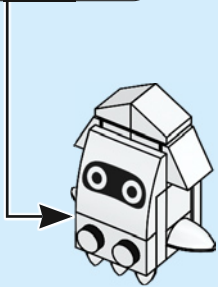
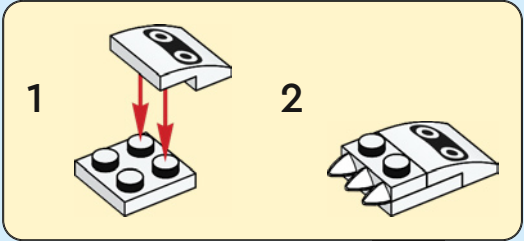

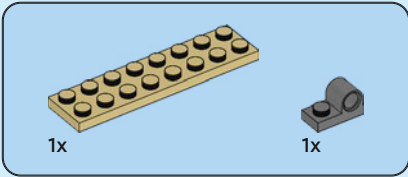
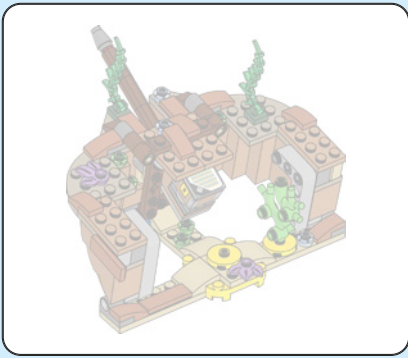

1

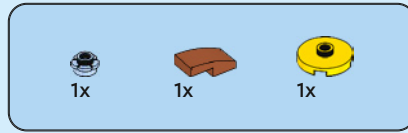
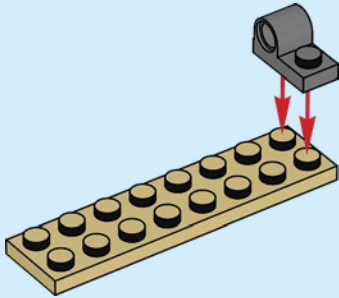

2

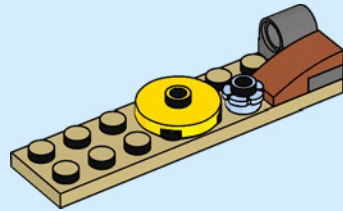

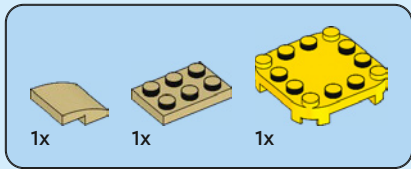

3

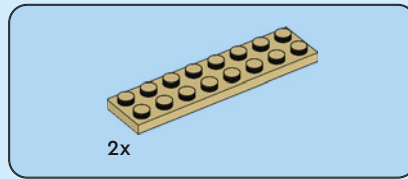
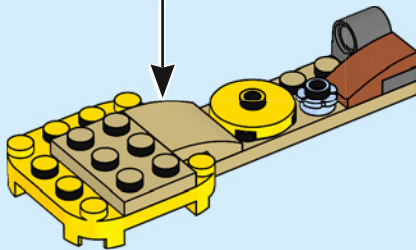
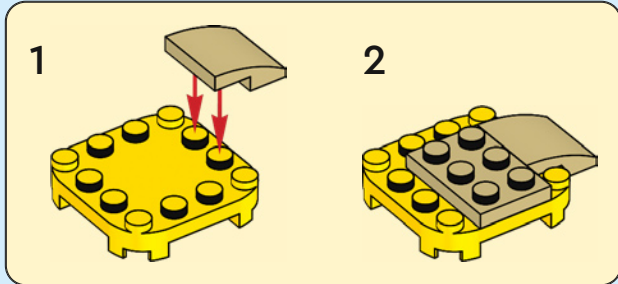

4

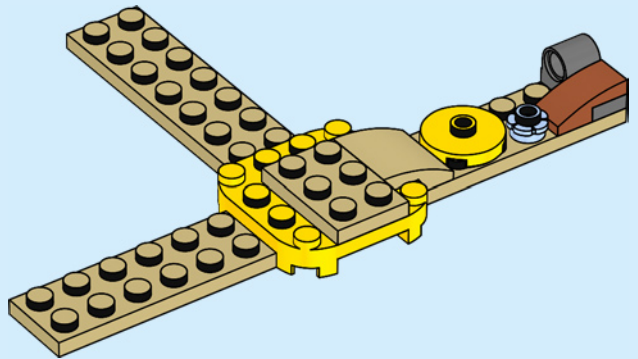



5

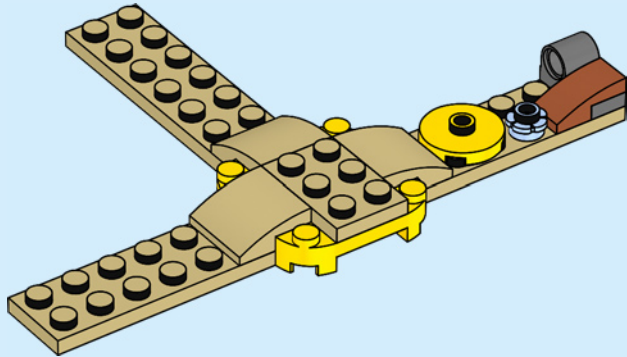

6

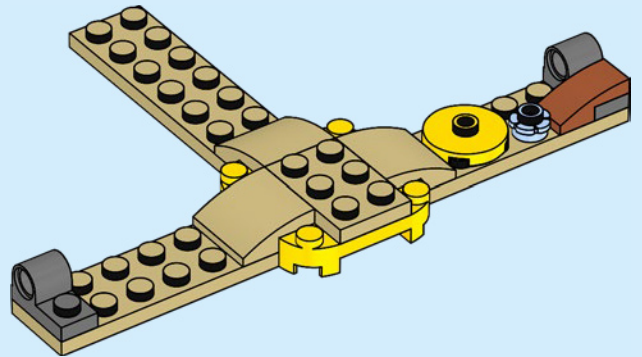

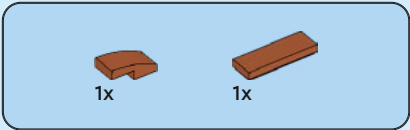

7

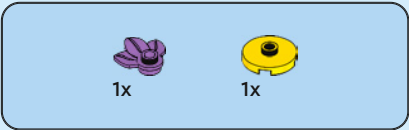
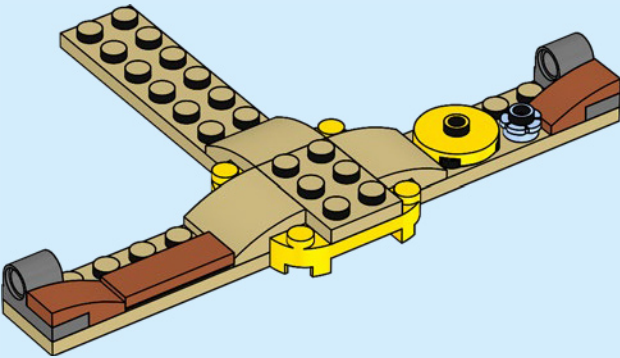

8

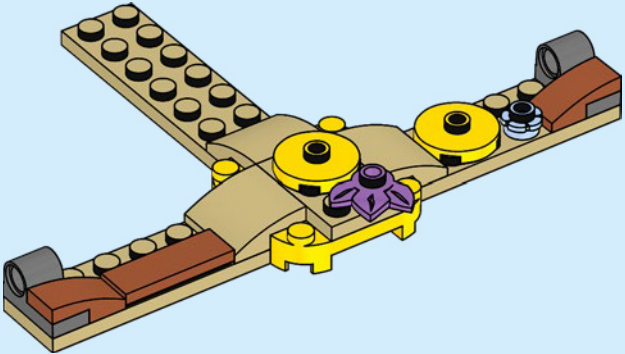

9

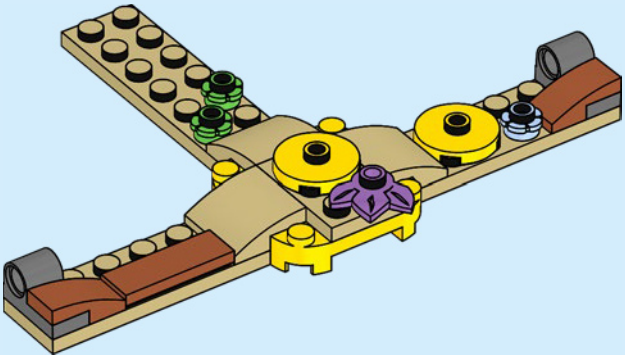

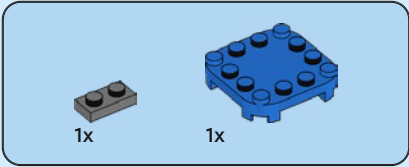

10

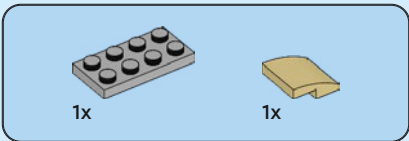
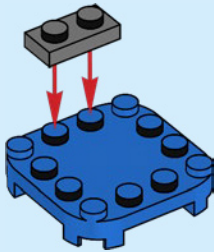

11

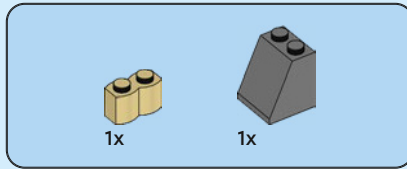
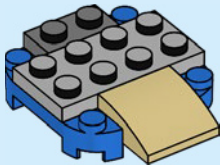

12

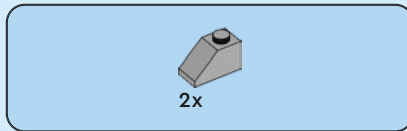
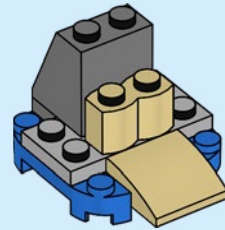

13

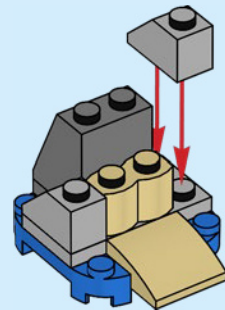

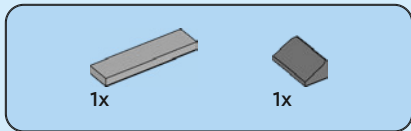

14

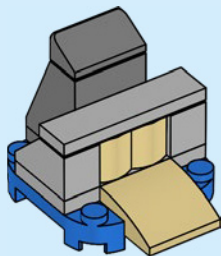

15

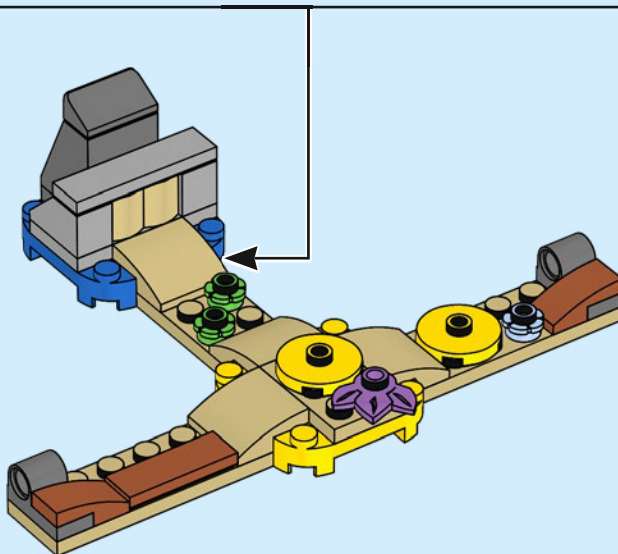



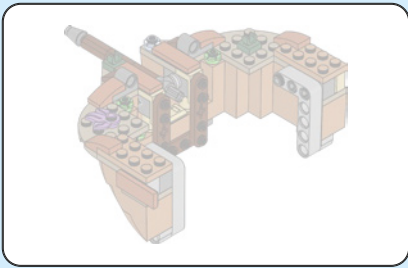

16

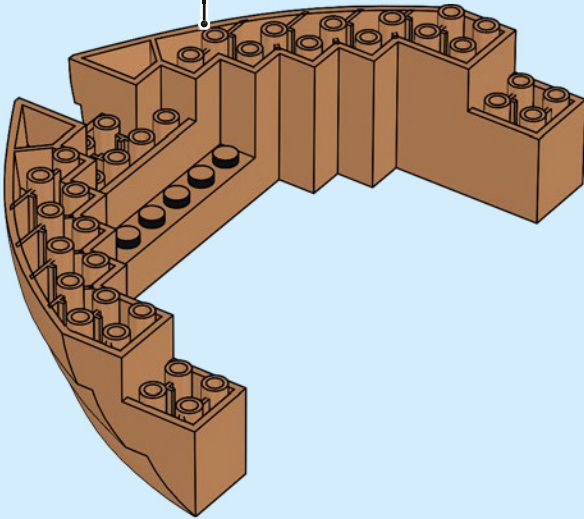
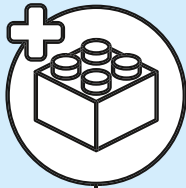

4x

17

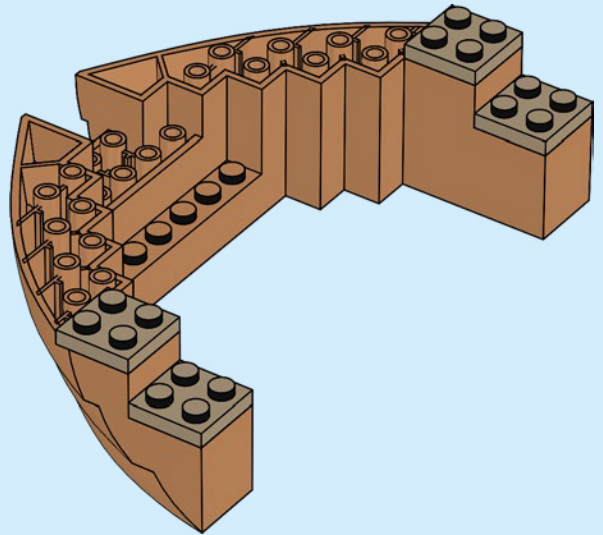

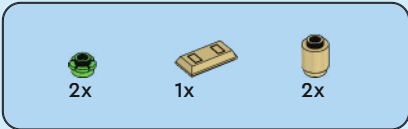

18

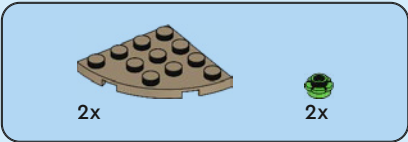
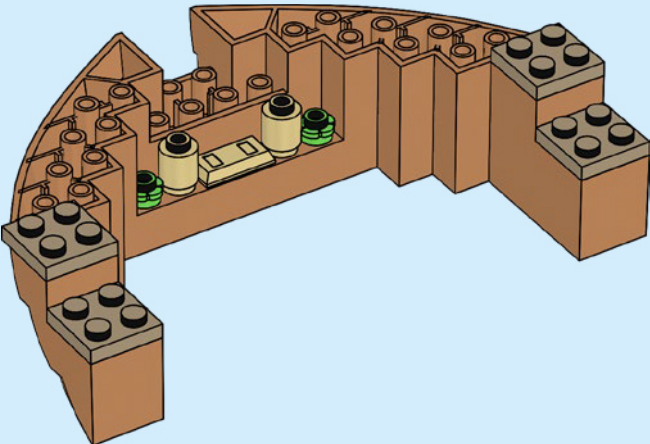

19

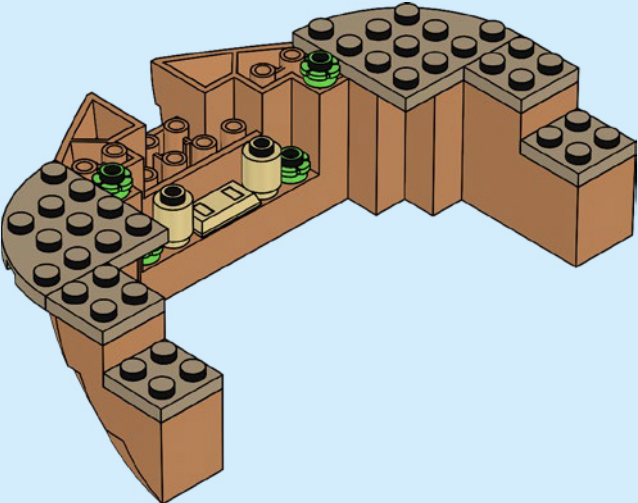

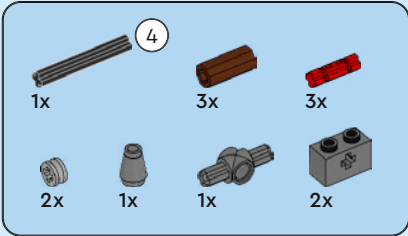
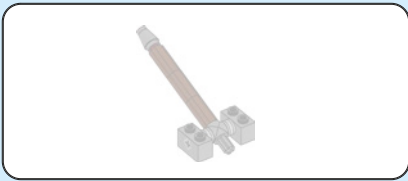

20

1

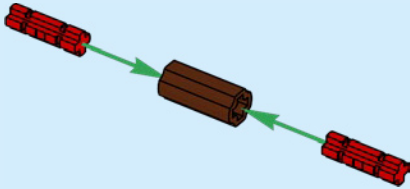

2

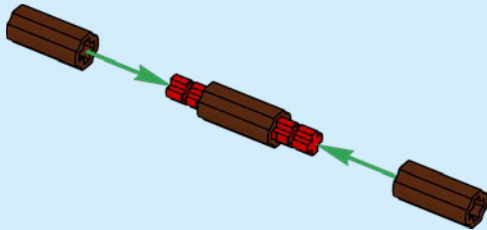

3

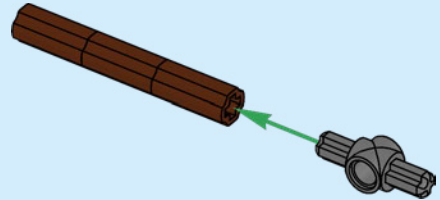

4

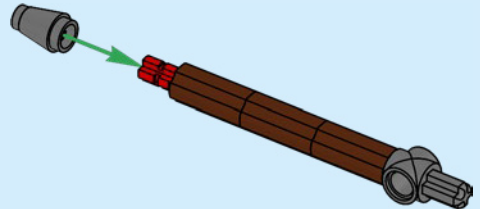

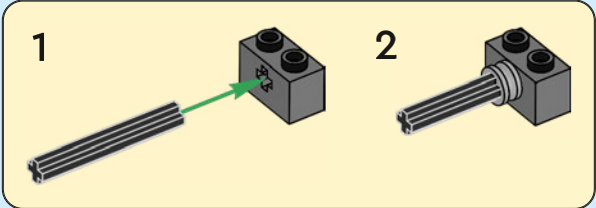

5

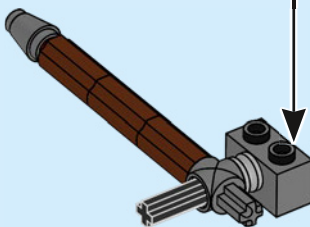

6

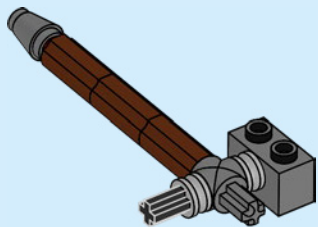

7

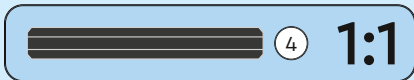
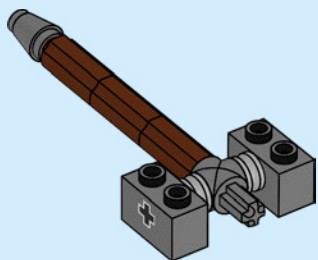

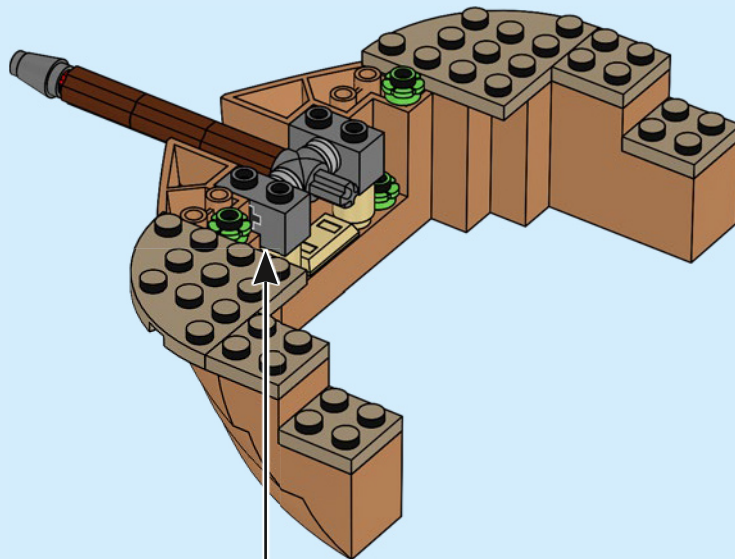

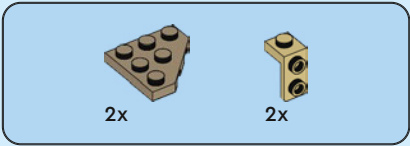

21

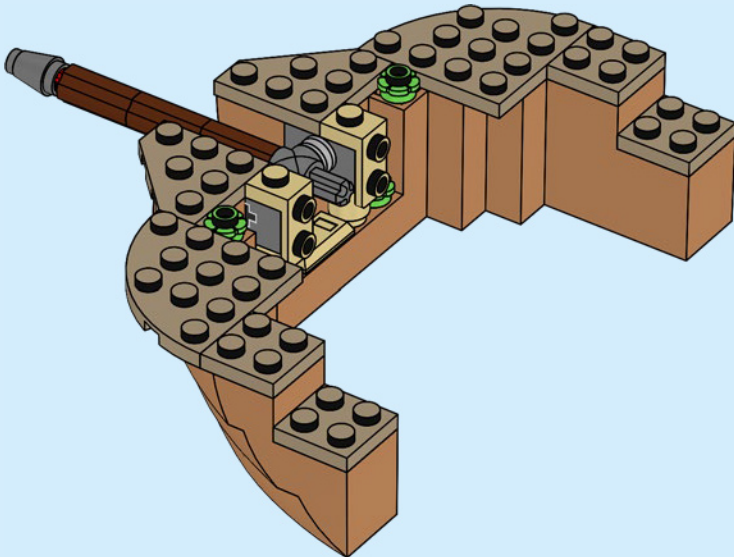



22

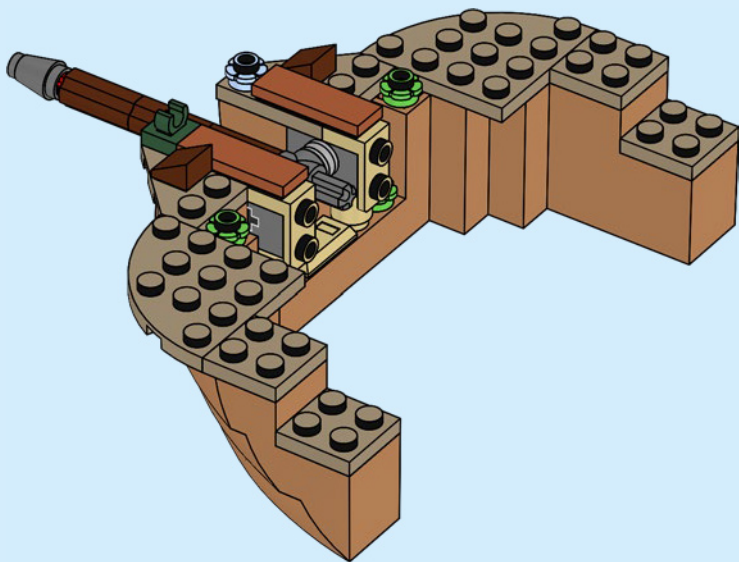



2x

23

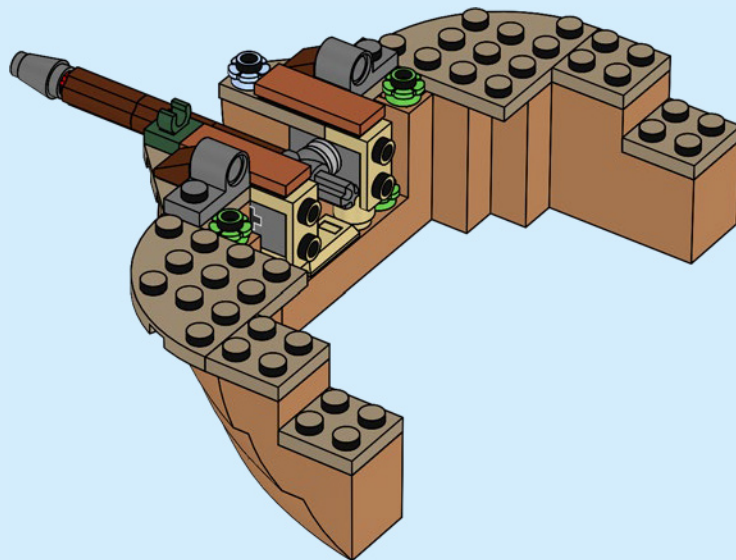





2x

24

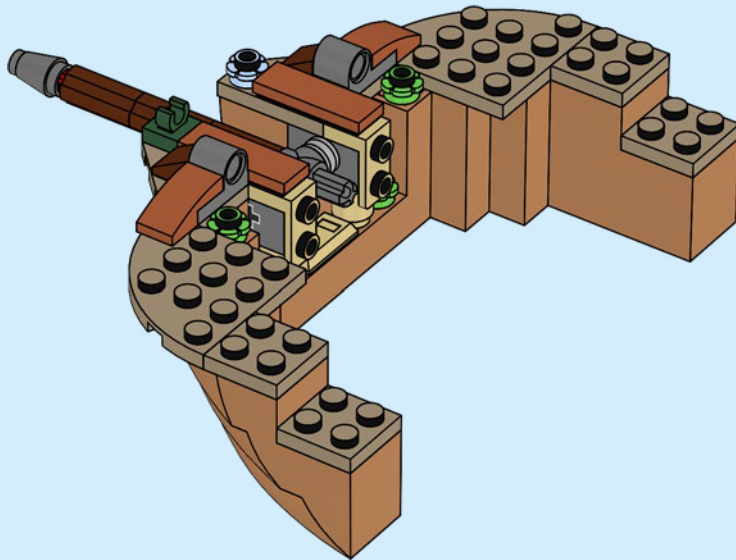



1x



1x

25

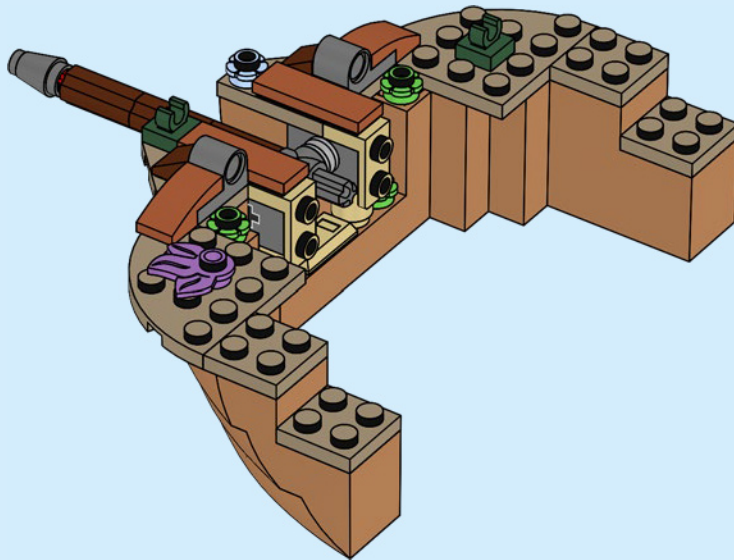

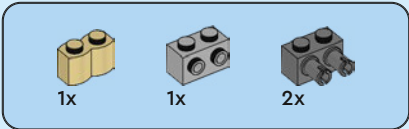

26

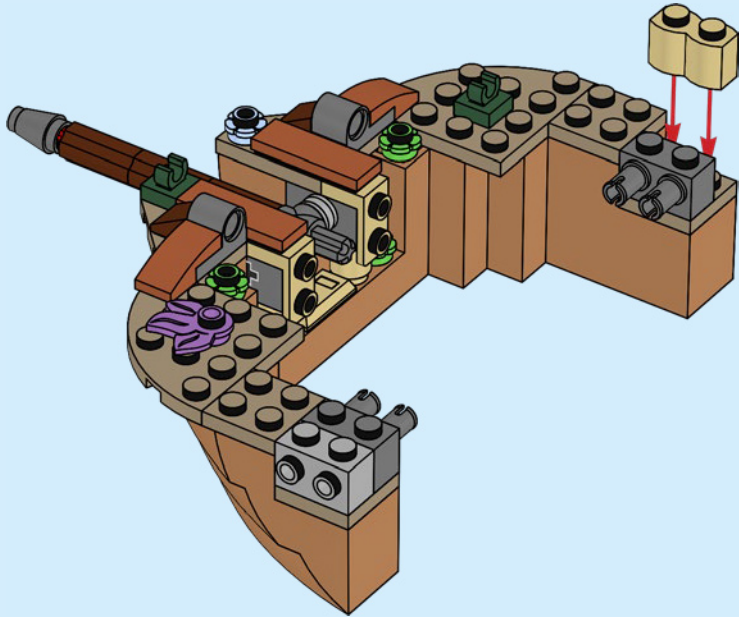



2x

27

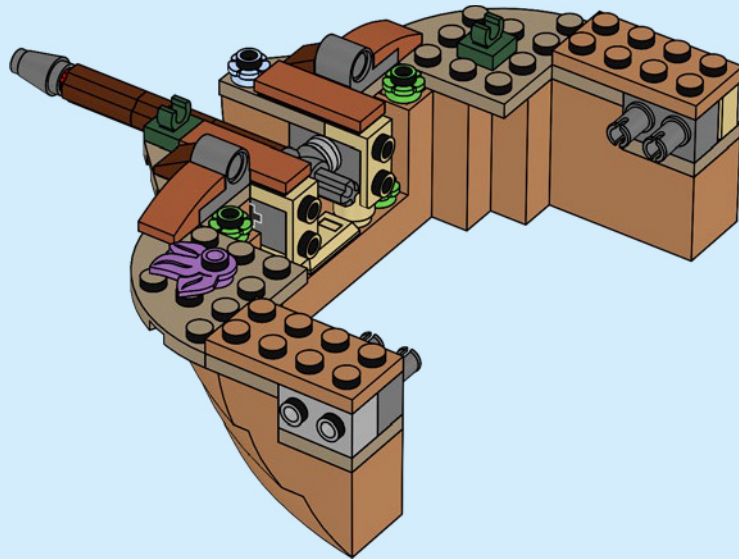



2x

28

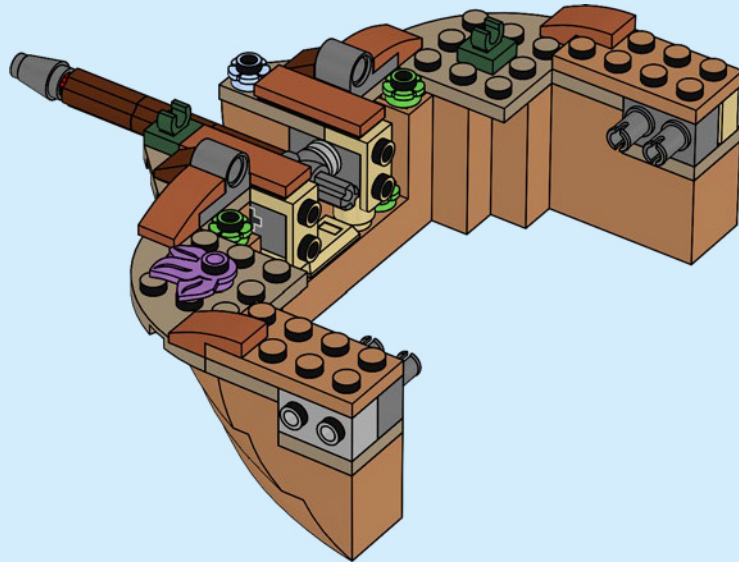



2x

29

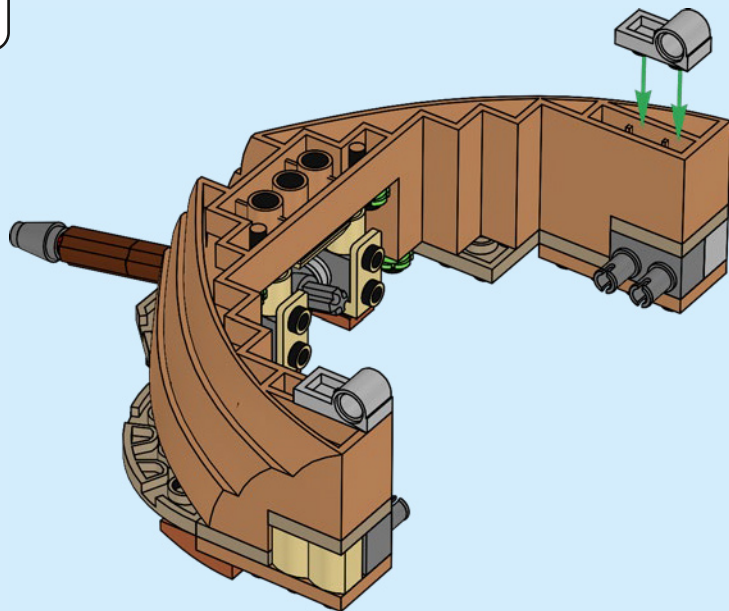

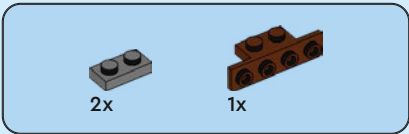

30

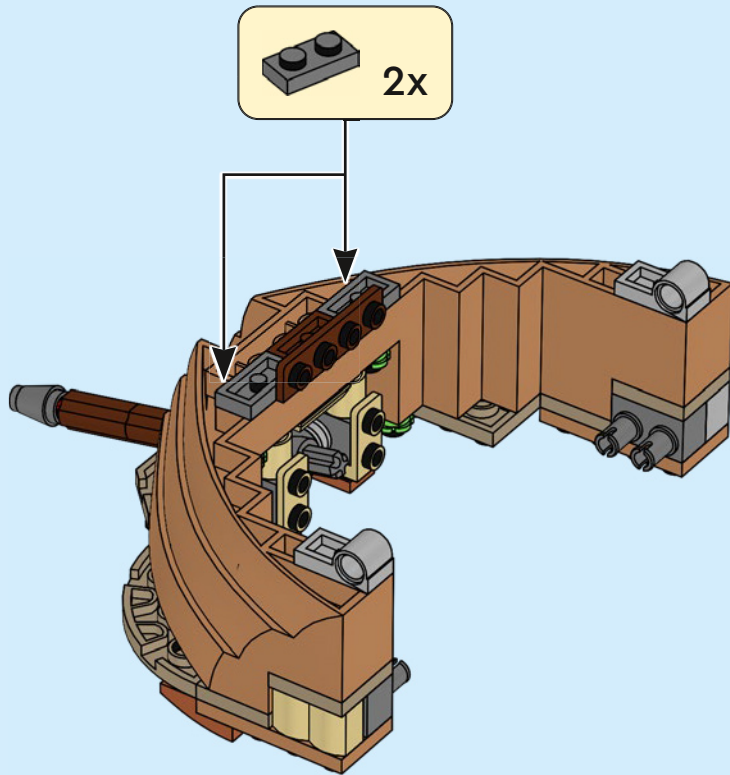

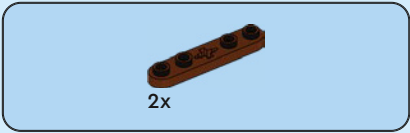

31

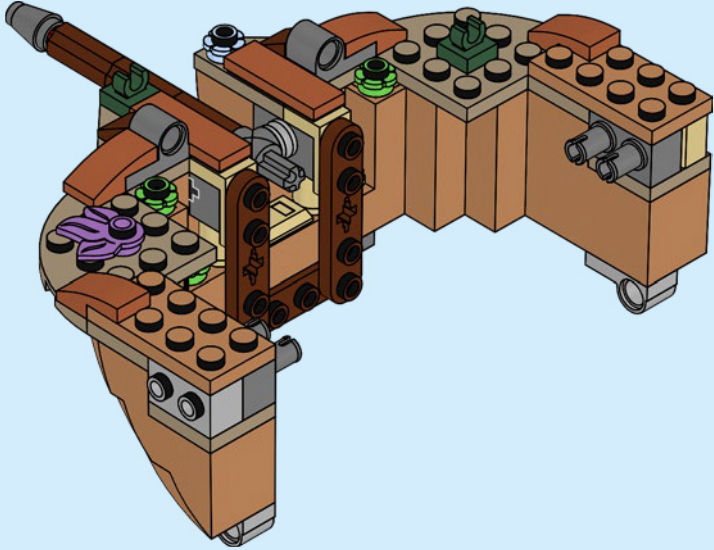



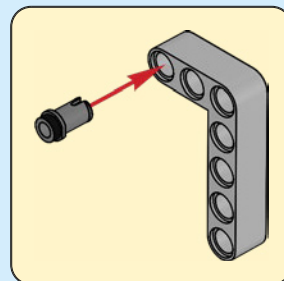
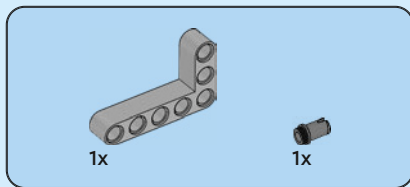

32

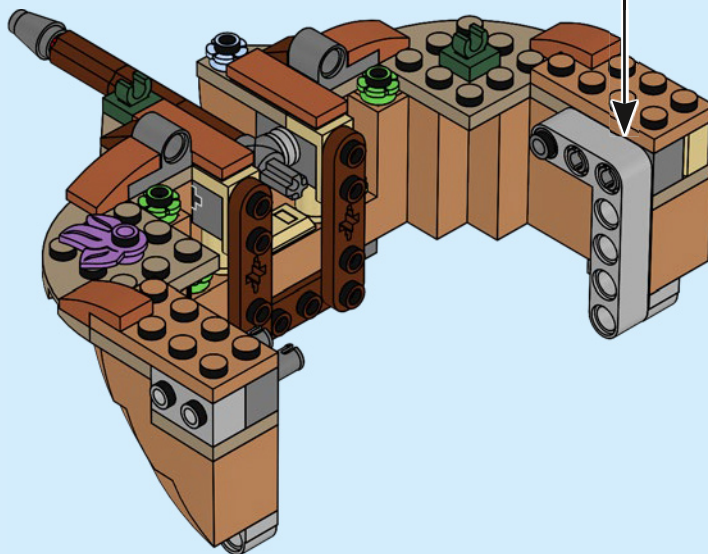

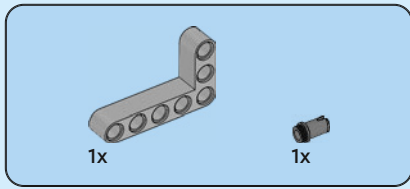

33

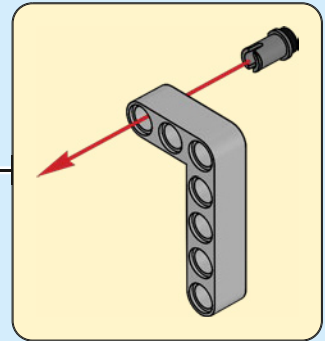
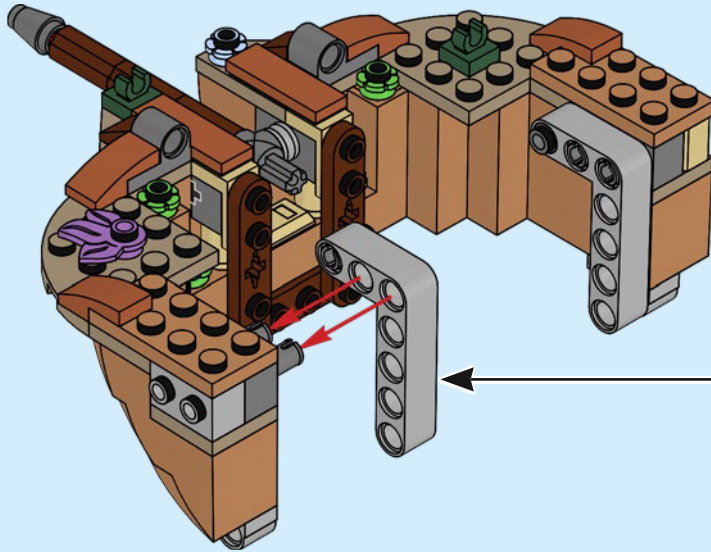



1x

34

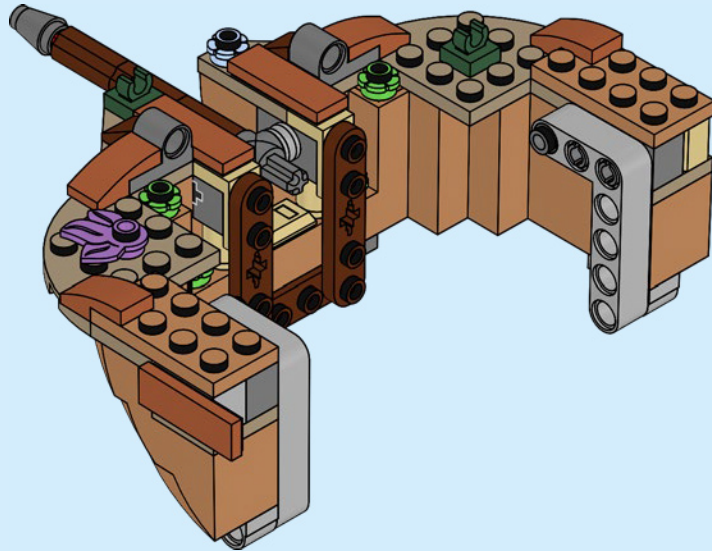



1x

35

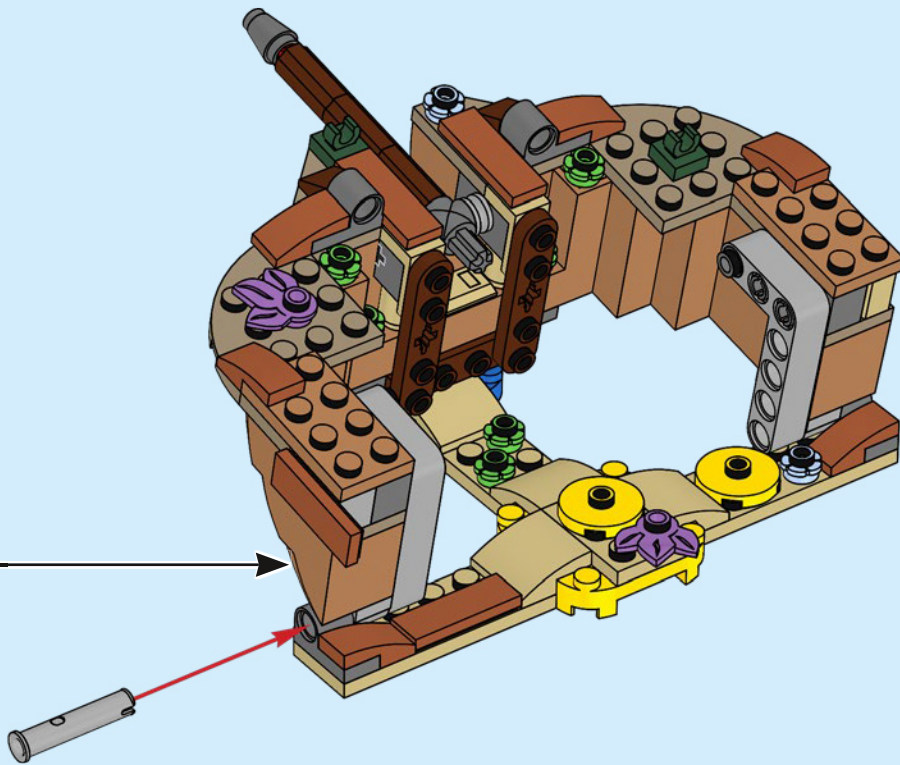

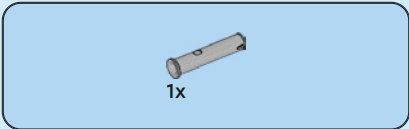

36

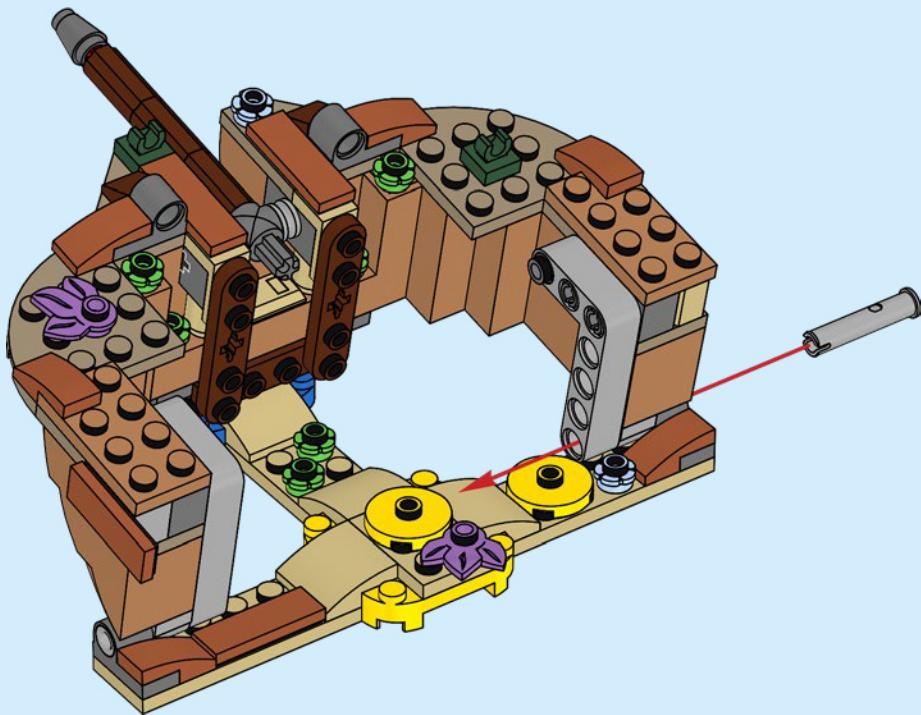

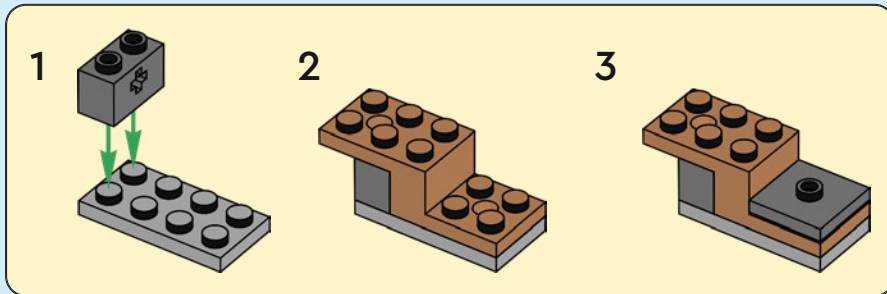
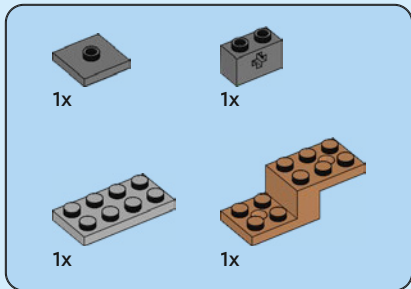

37

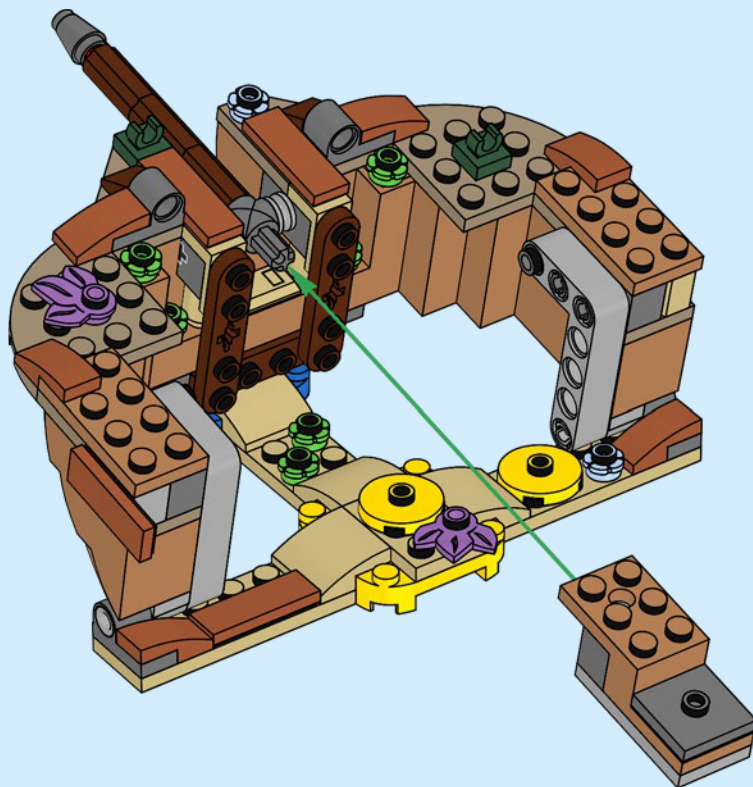

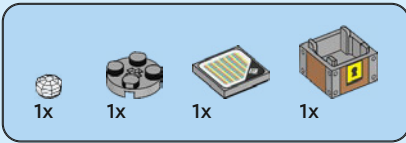

38

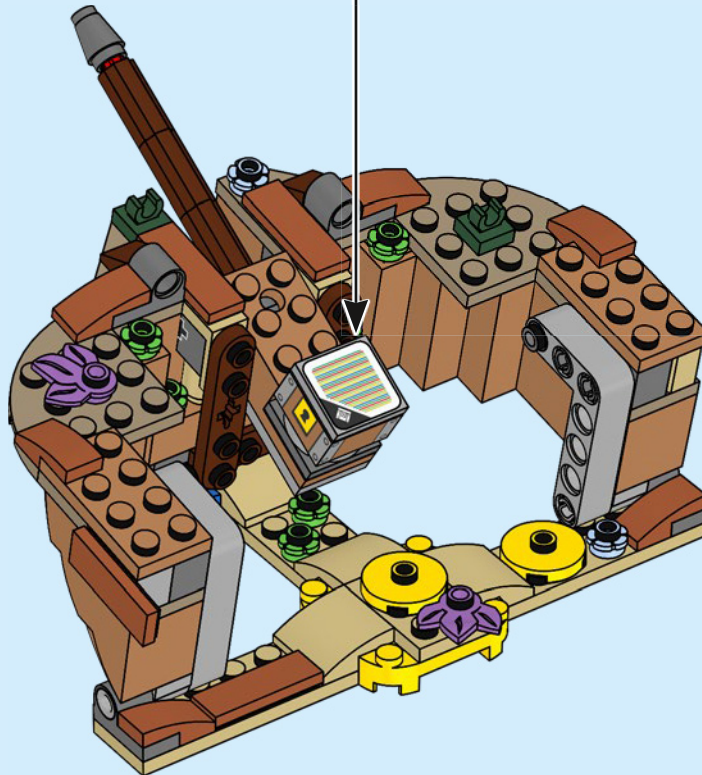
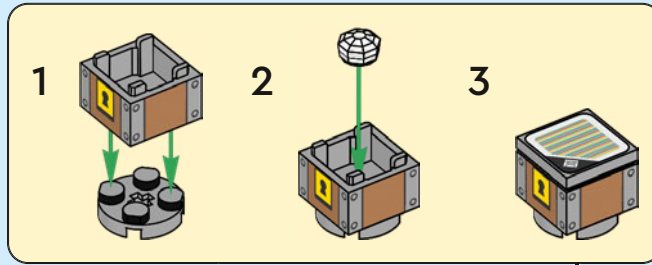

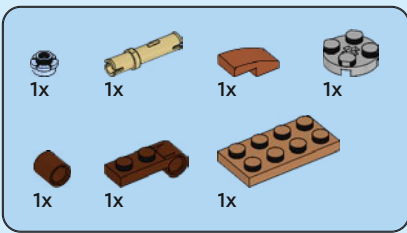

39

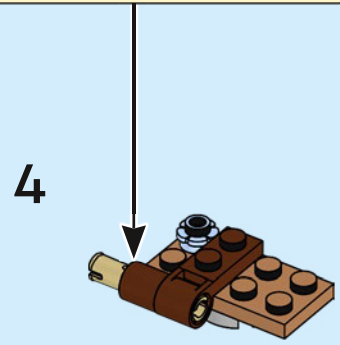
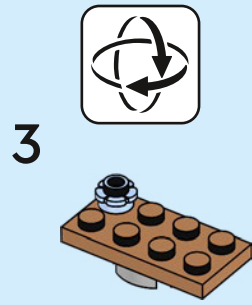
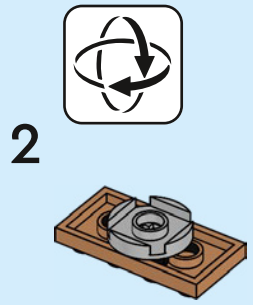
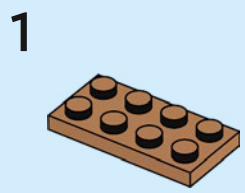
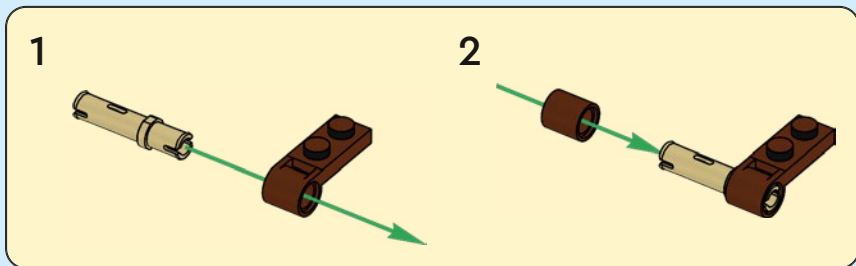



5

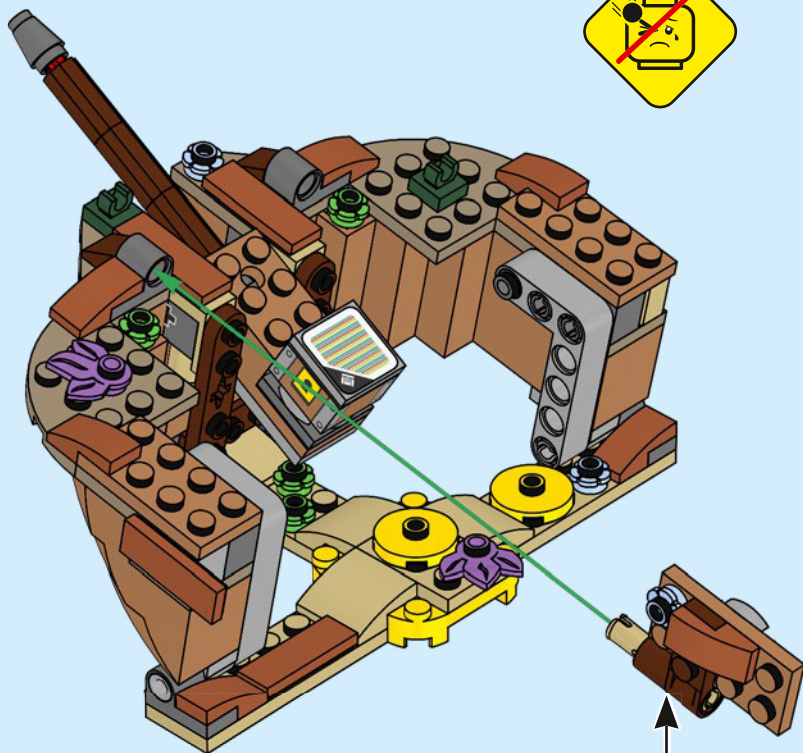

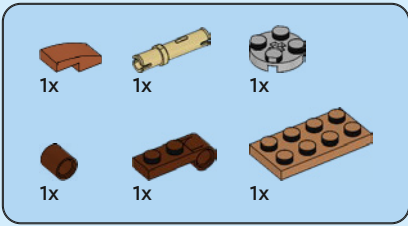

40

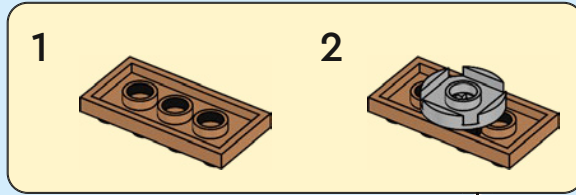

1

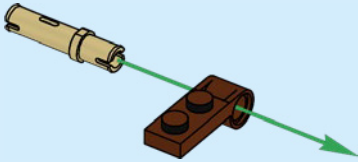

2

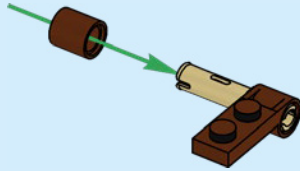

3

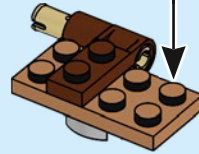

4

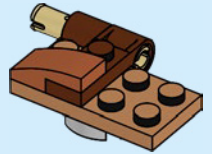

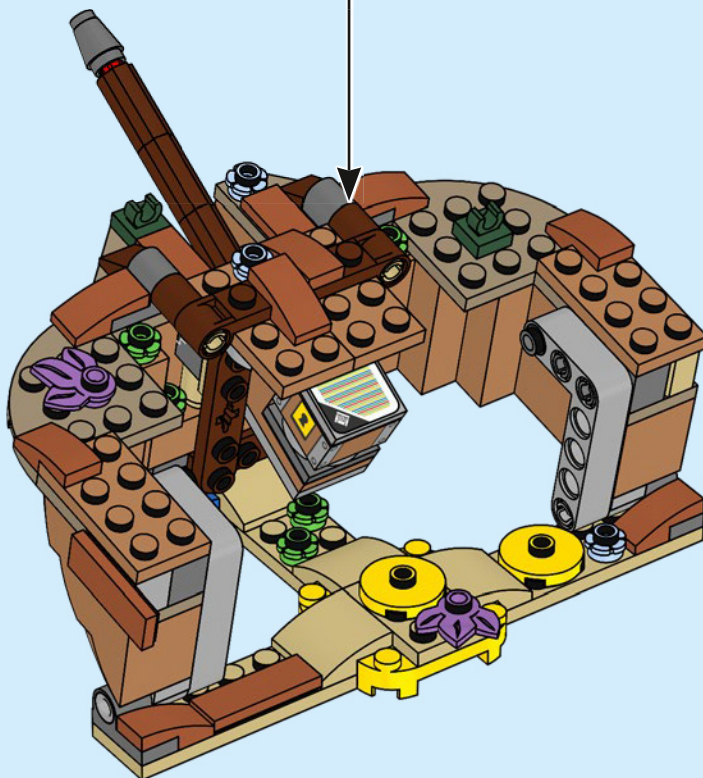



2x



1x

41

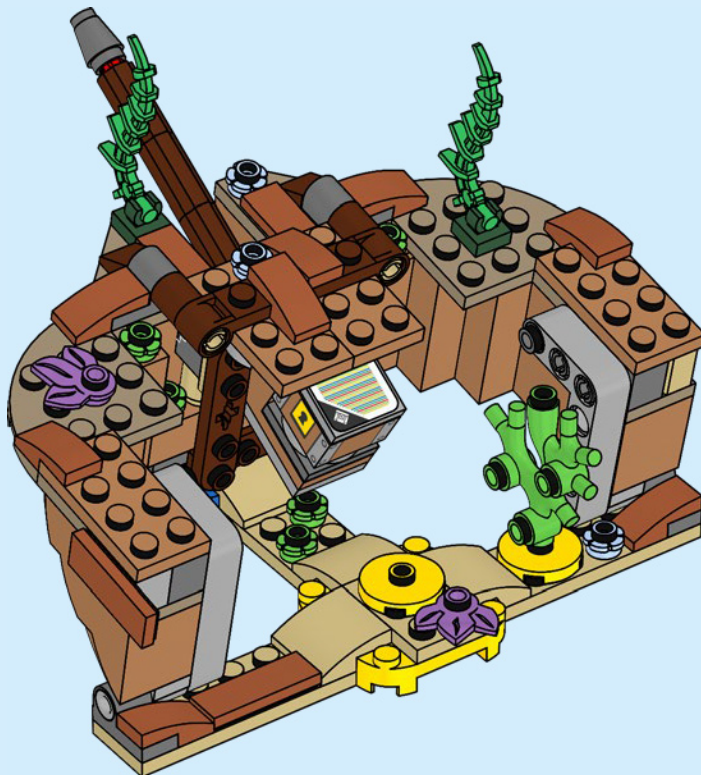

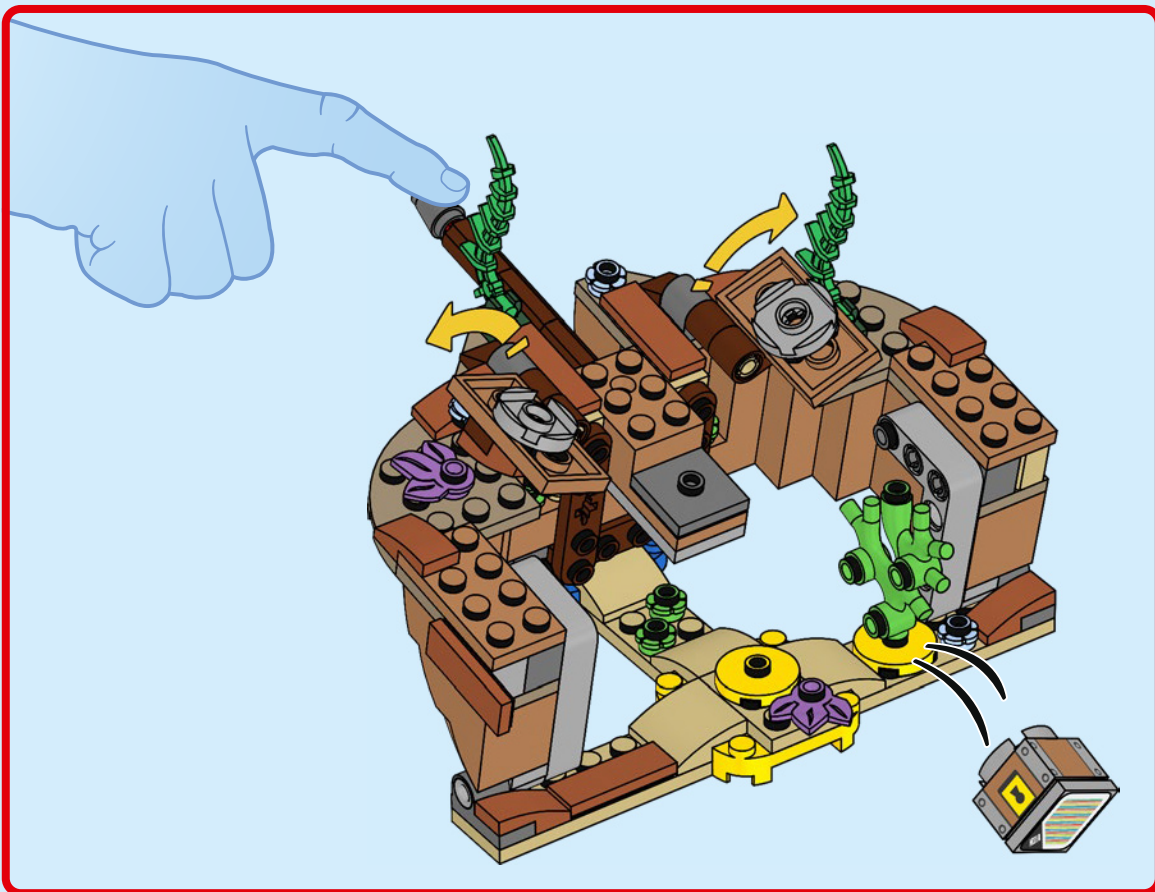

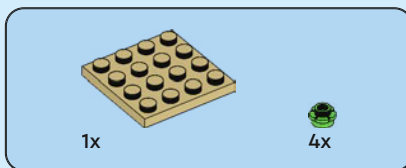
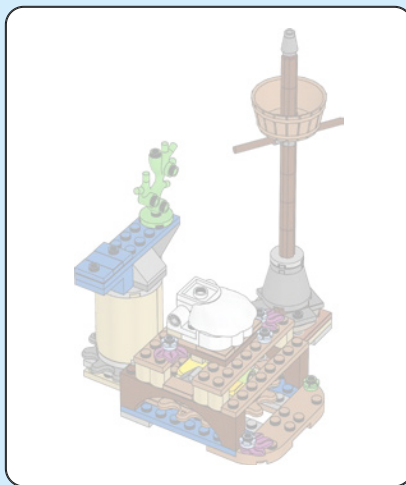

1

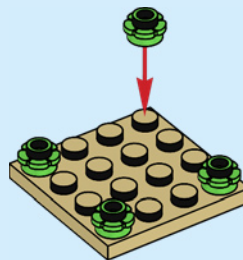

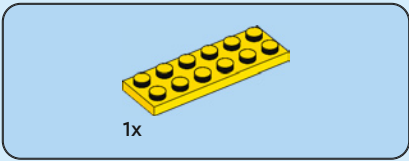

2

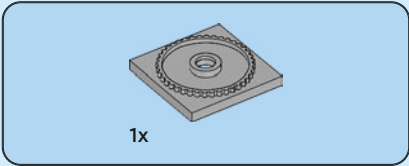
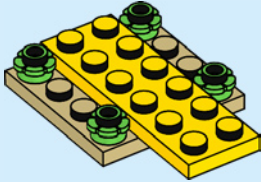

3

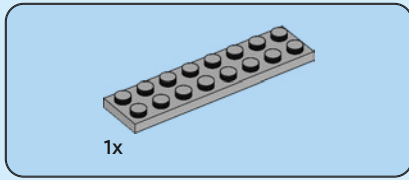
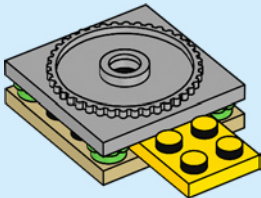

4

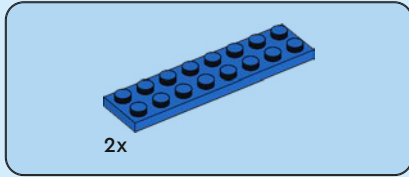
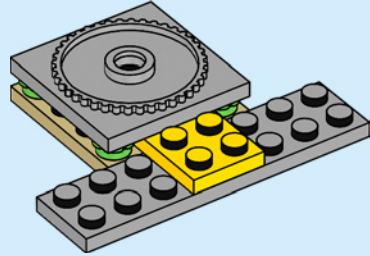

5

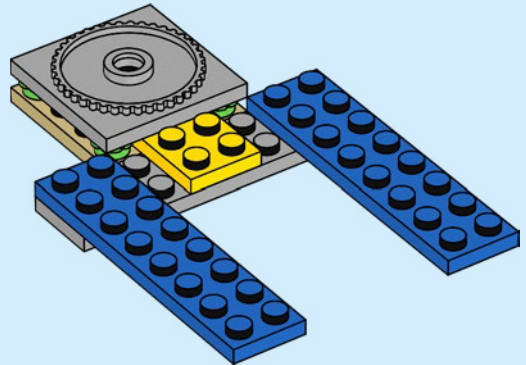

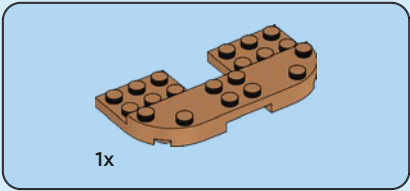

6

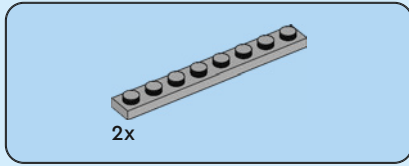
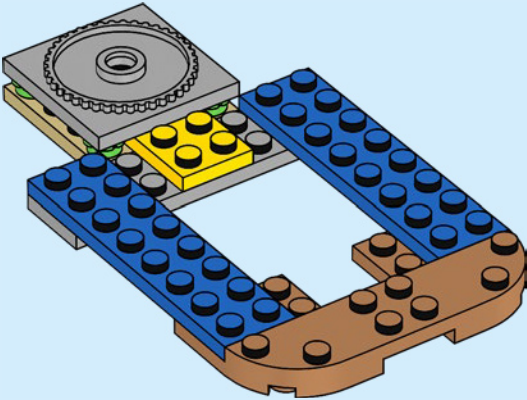

7

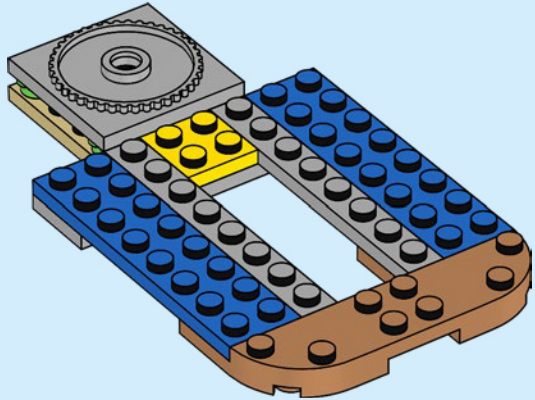



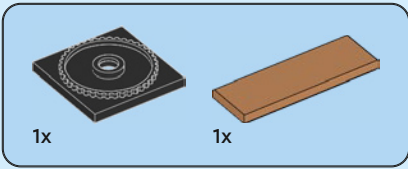

8

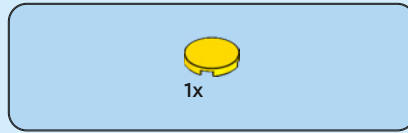
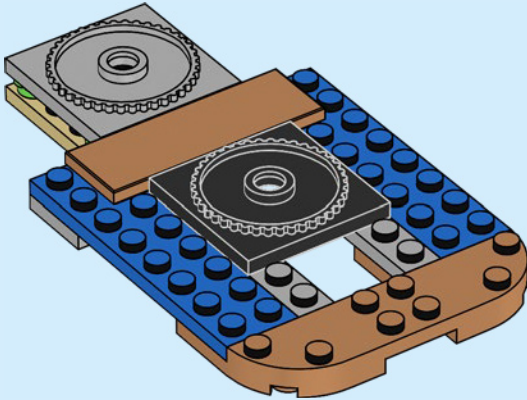

9

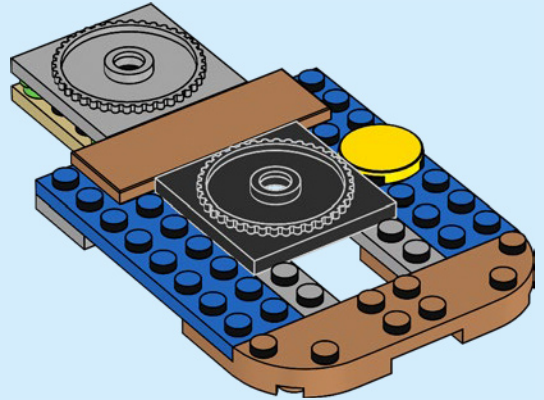

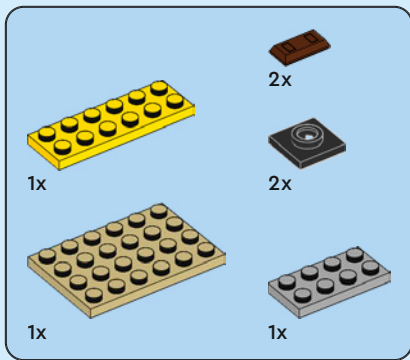

10

1

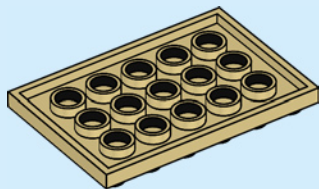

2

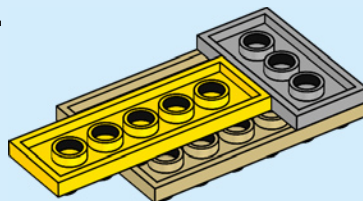

3

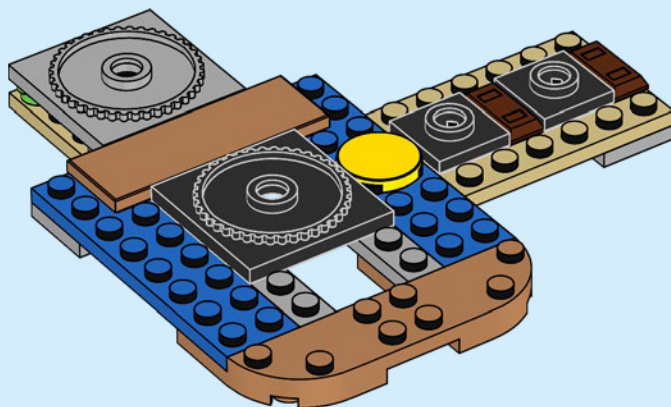
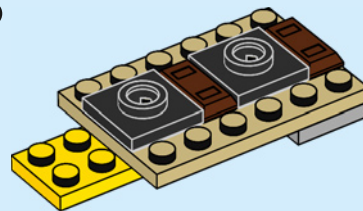

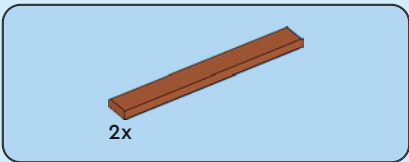

11

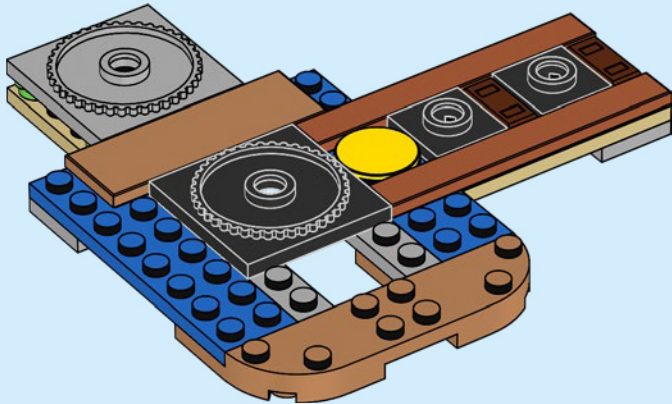

12

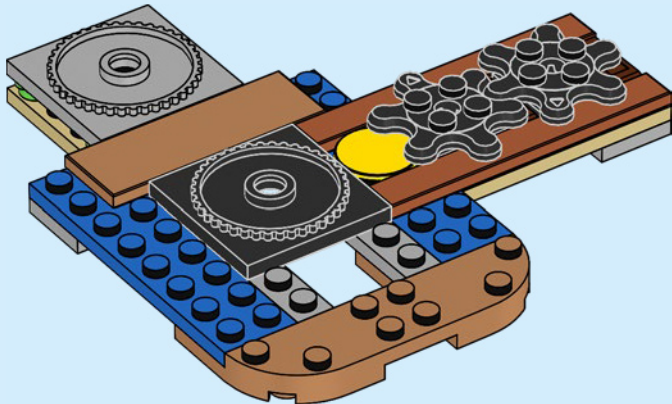

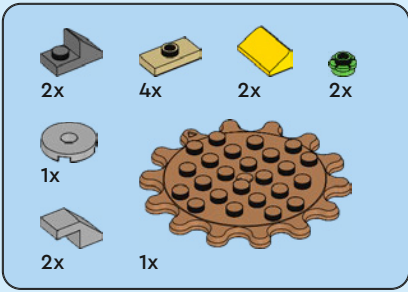

13

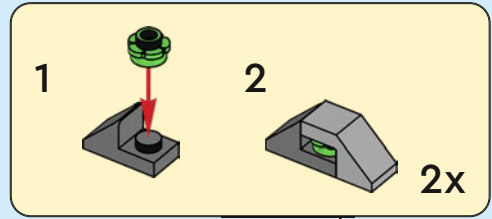

1

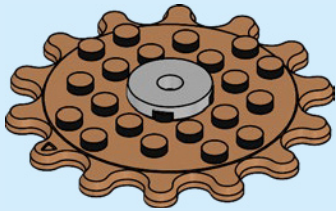

2

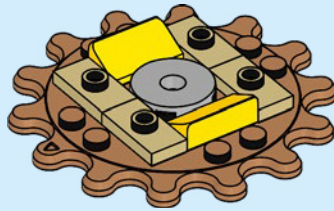

3

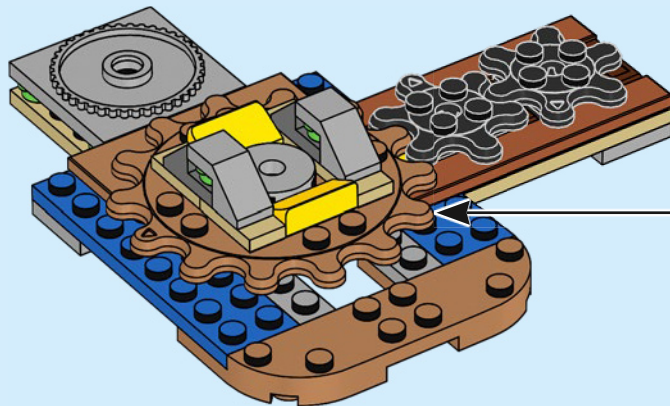
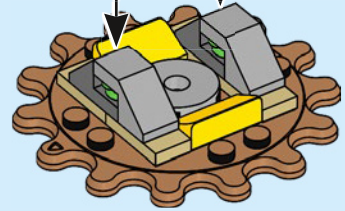

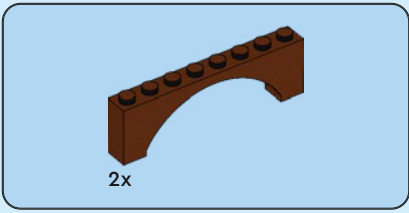

14

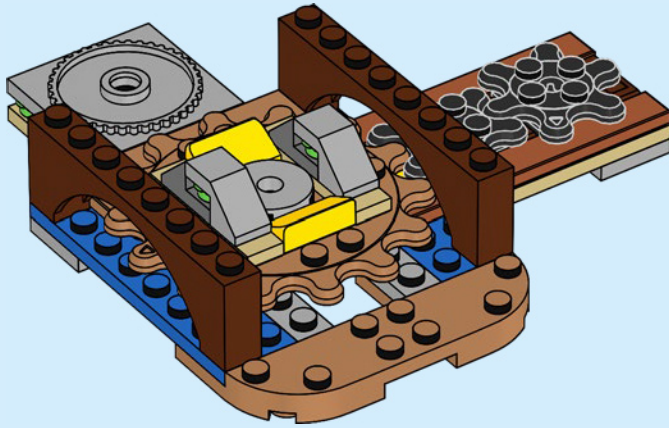

15

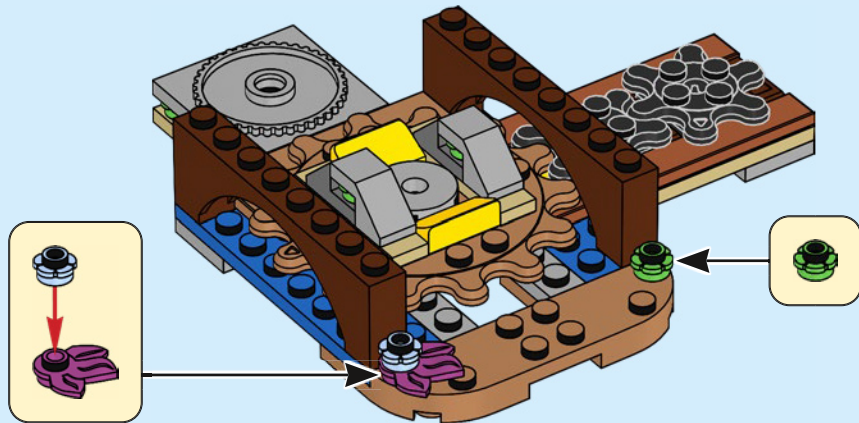

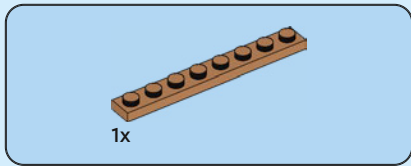

16

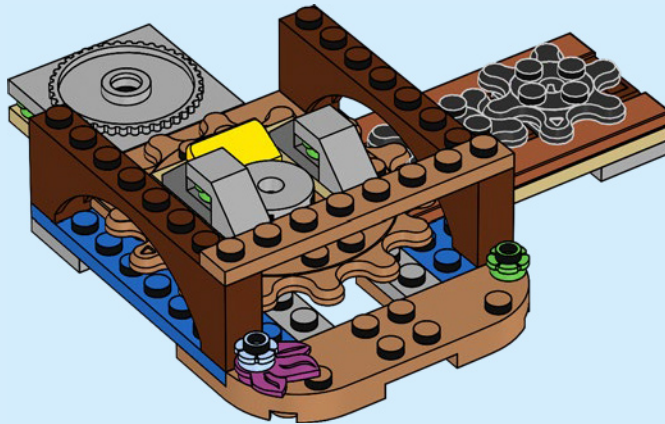



4x



2x

17

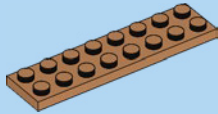
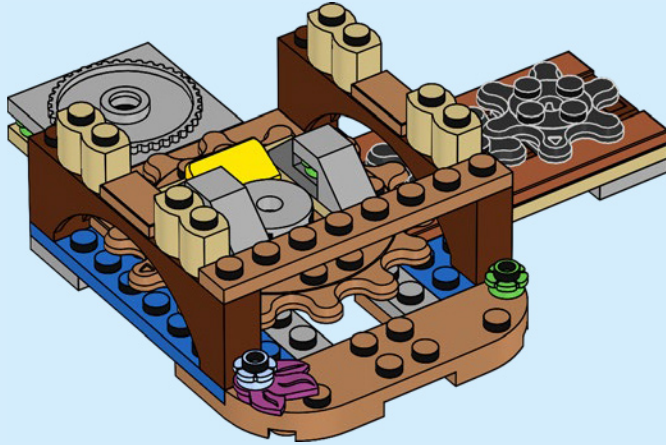

1x

18

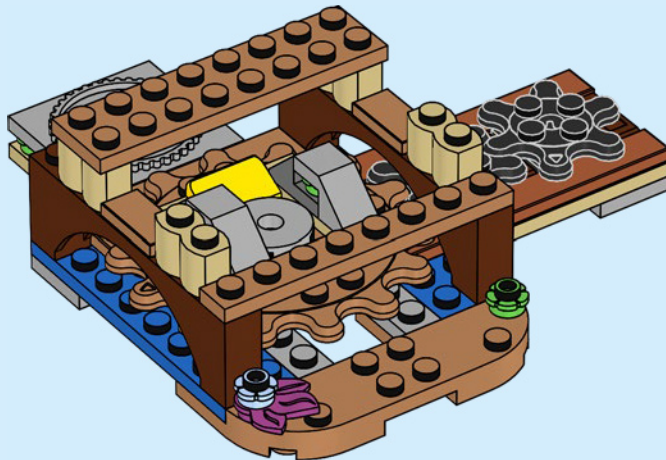

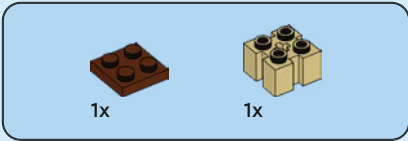

19

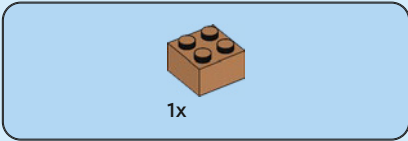
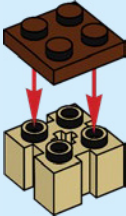

20

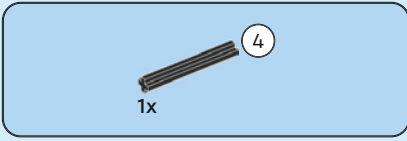
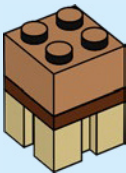

21

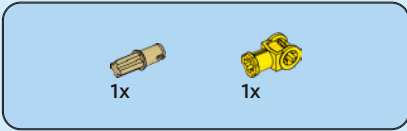
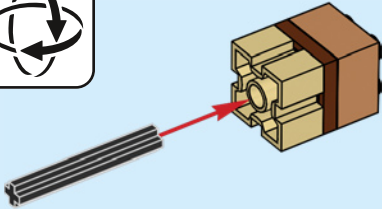
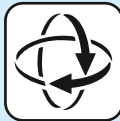

22

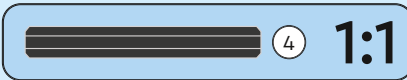
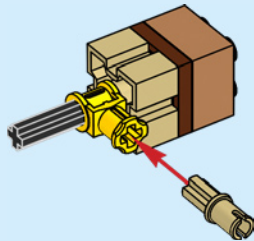





1x

23

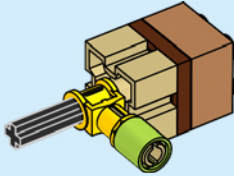

1x

24

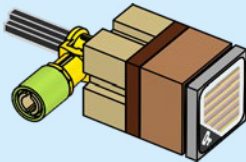

25

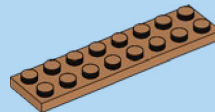

1x

26



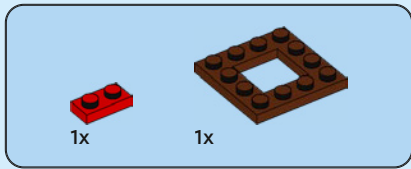

27

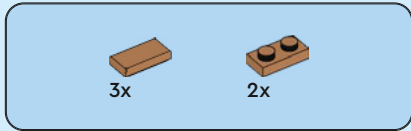
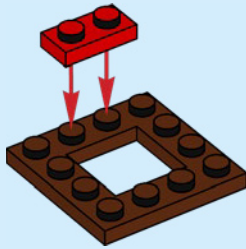

28

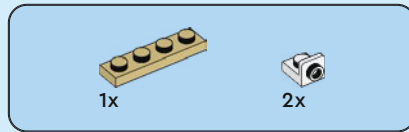
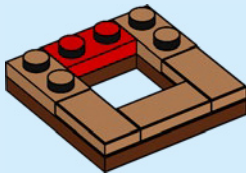

29

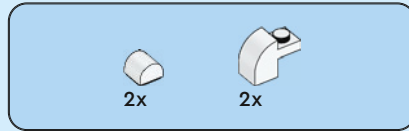
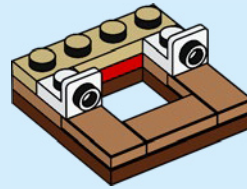

30

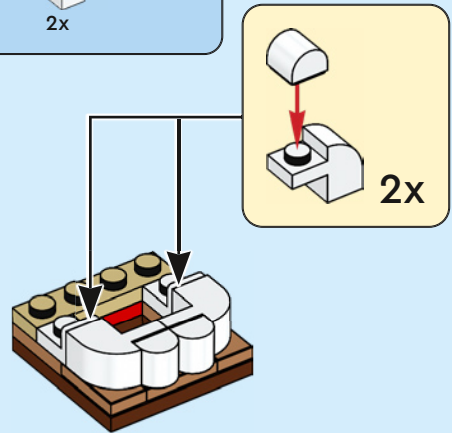

31



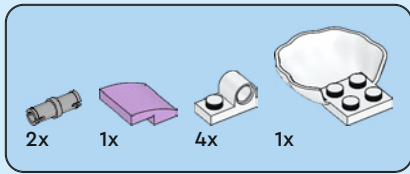

32

1



2

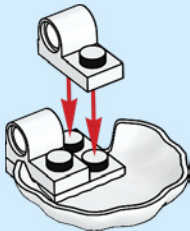

3



4

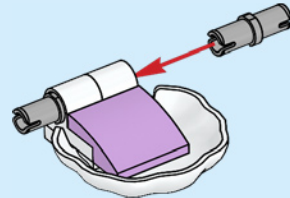

5

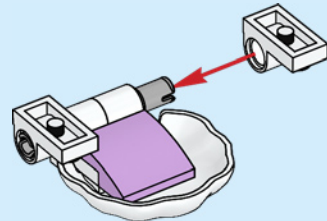

3x      2x

# 33

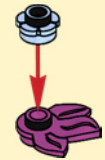

2x



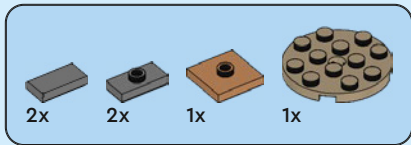

34

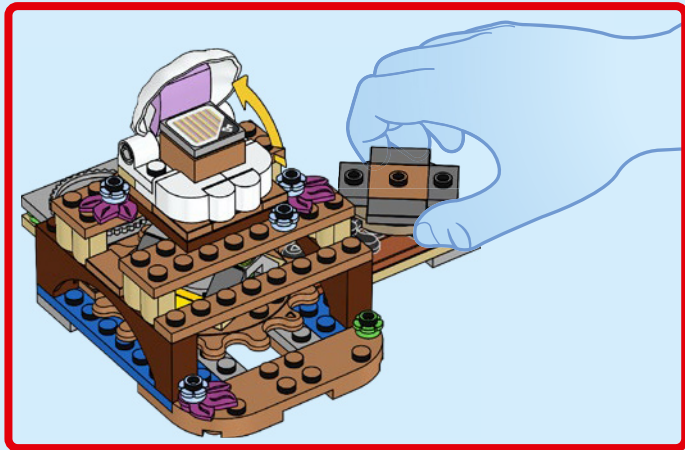
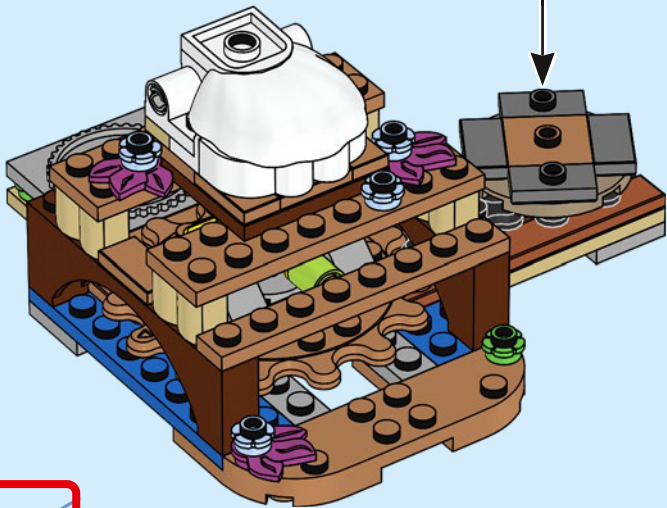
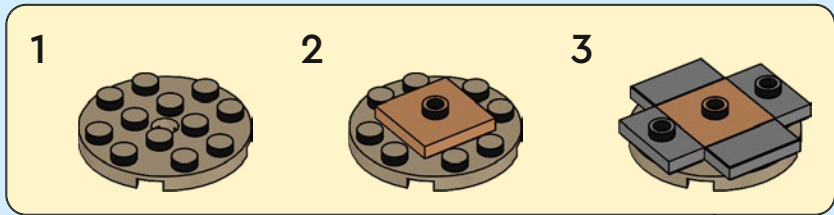

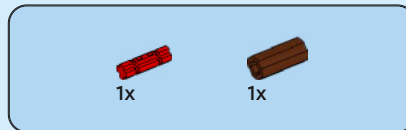
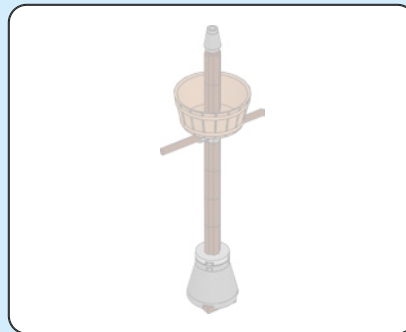

35

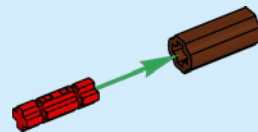

36

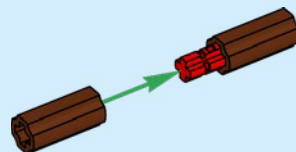

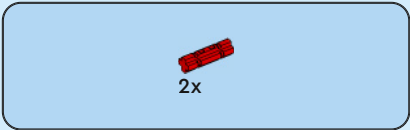

37

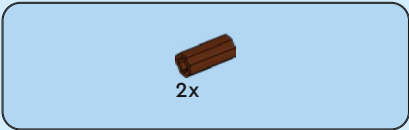
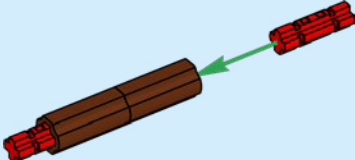

38

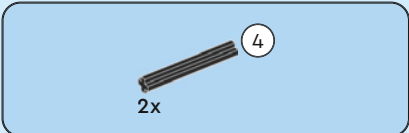
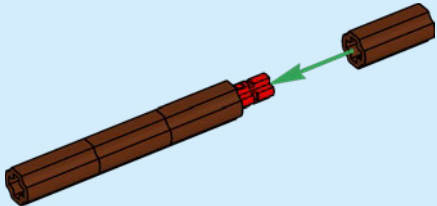

39

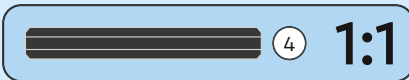
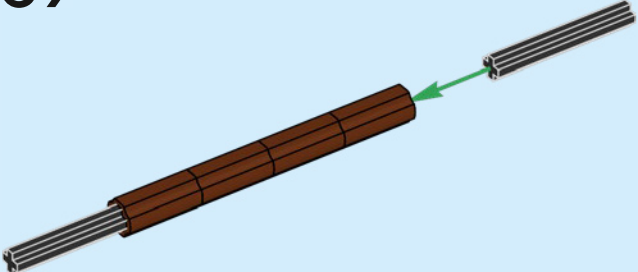



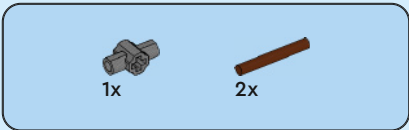

40

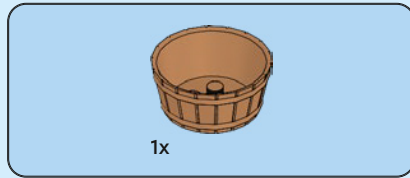
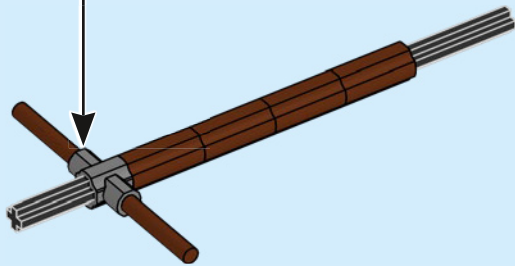
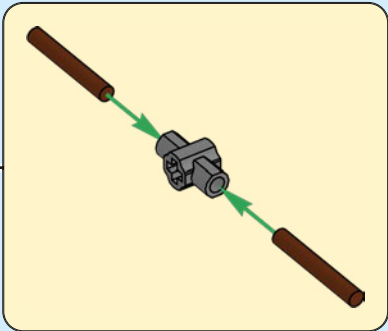

41

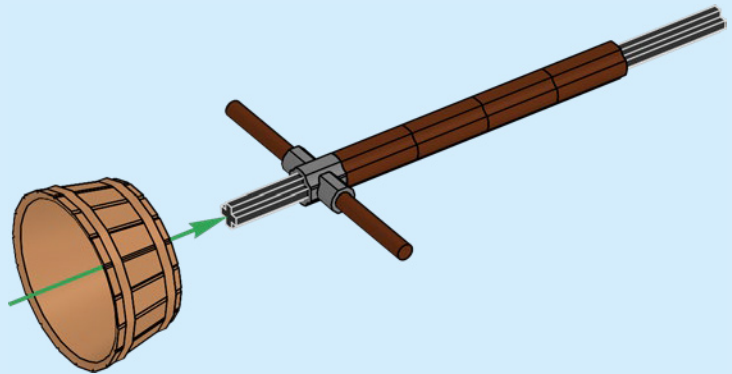

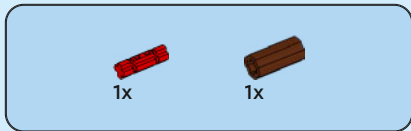

42

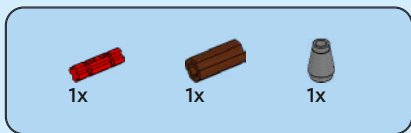
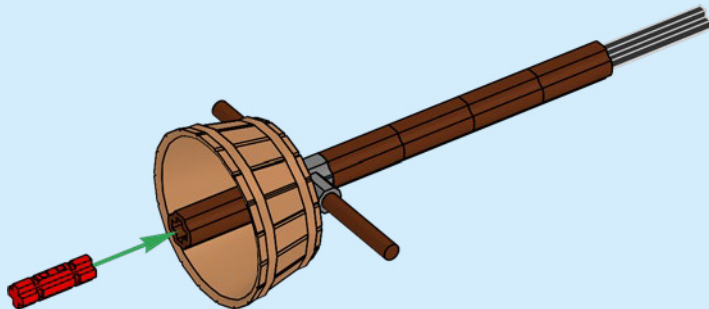

43

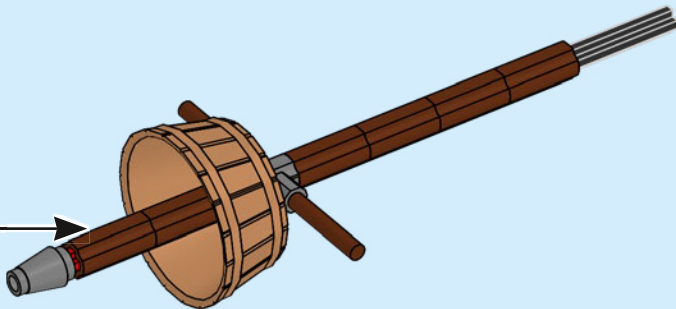
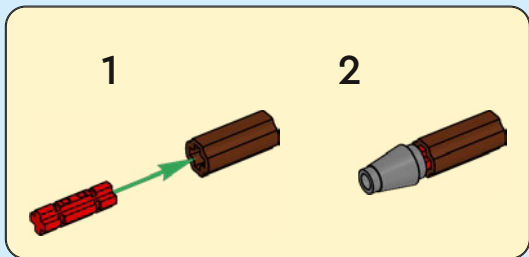

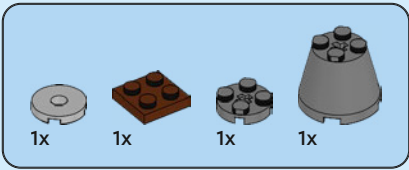

44

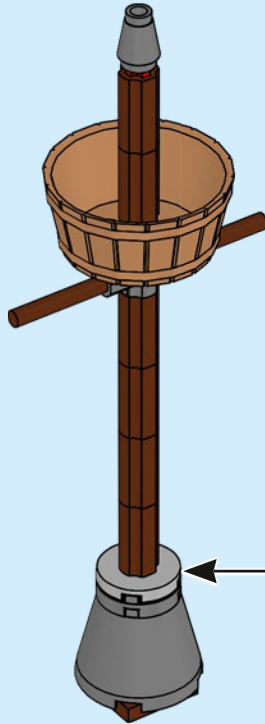
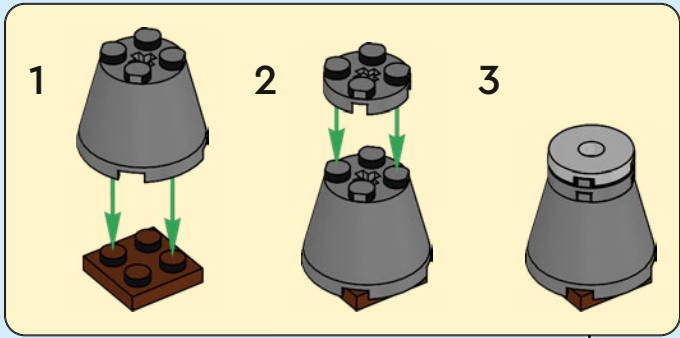

45

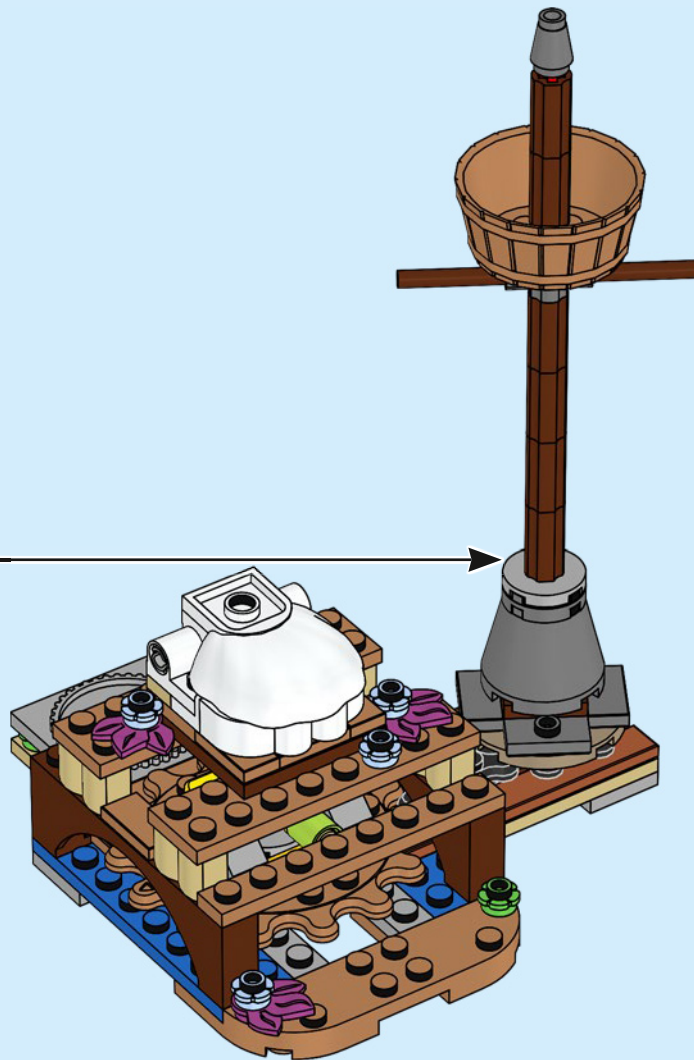

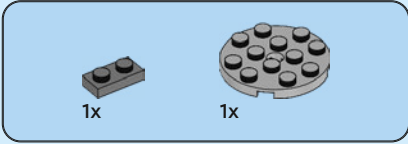
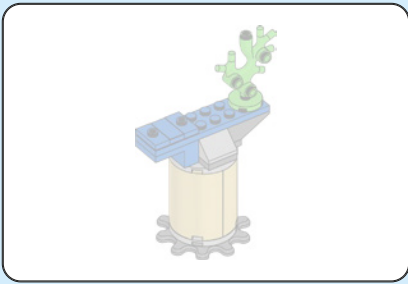

46

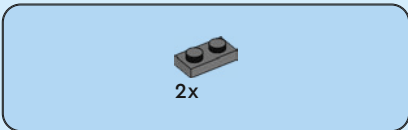
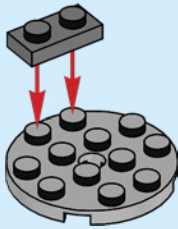

47

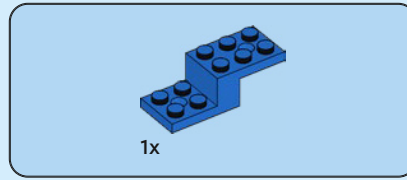
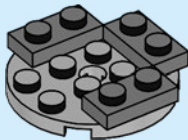

48

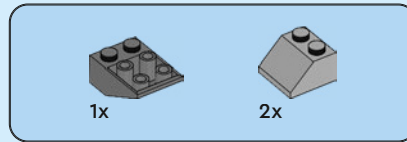
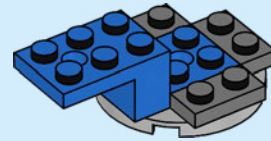

49

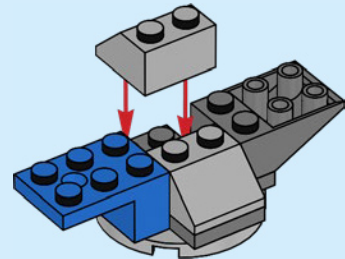

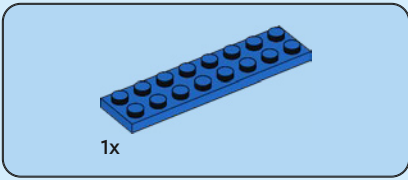

50

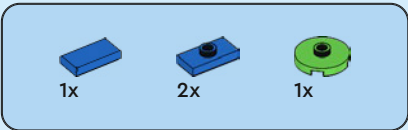
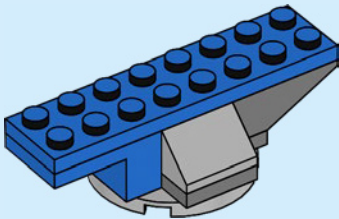

51

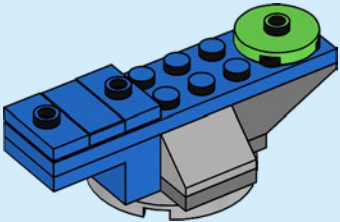

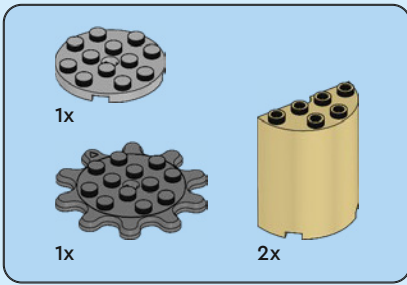

52

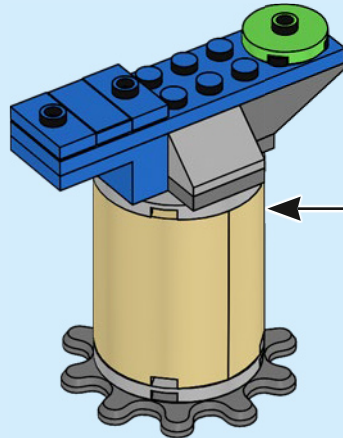
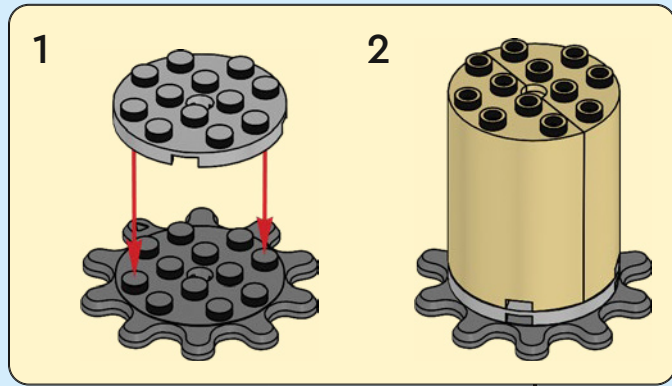

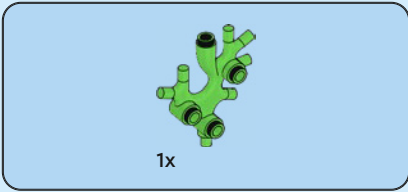

53

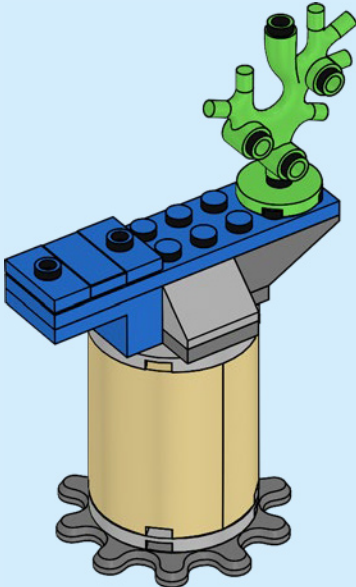

54

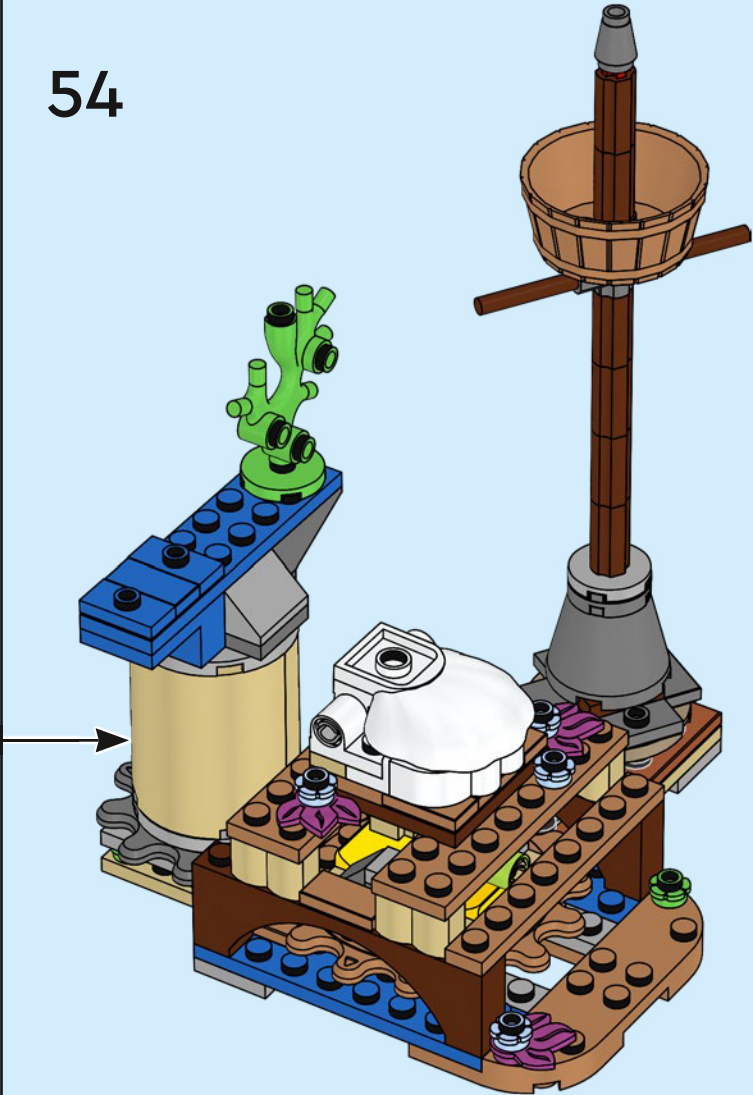



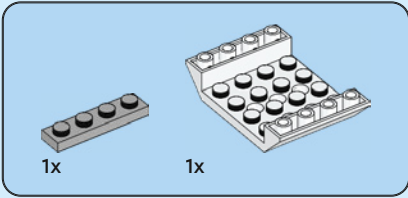
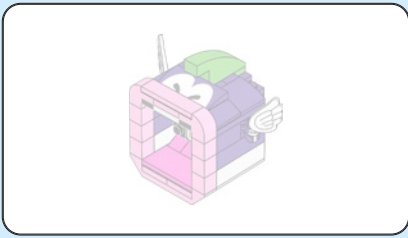

1

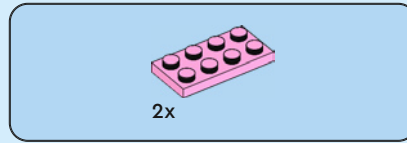
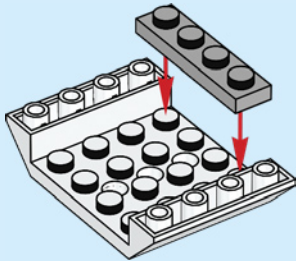

2

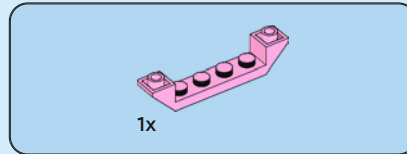
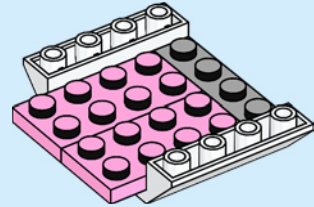

3

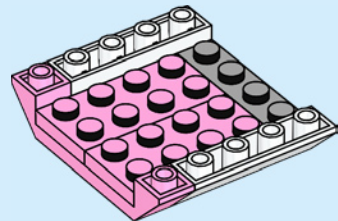

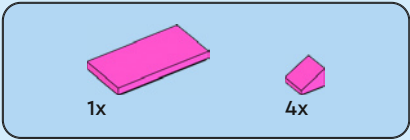

4

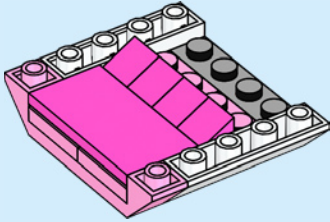

5

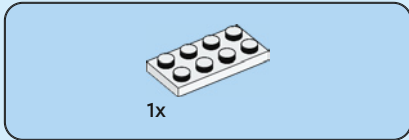
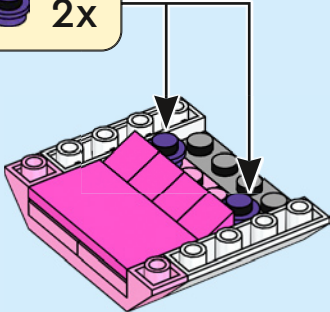

6

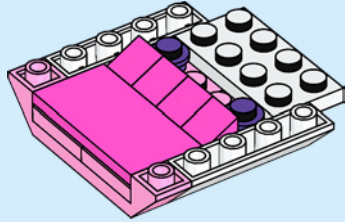

7

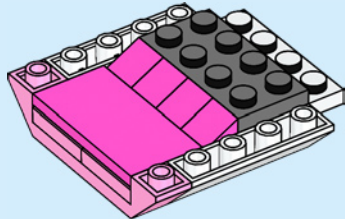

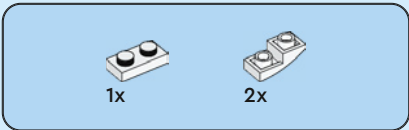

8

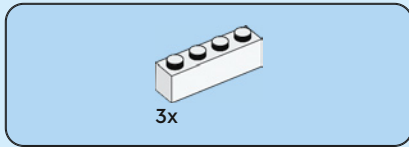
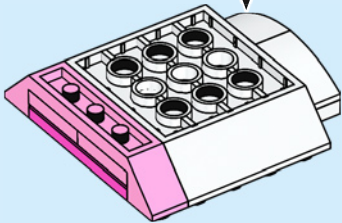
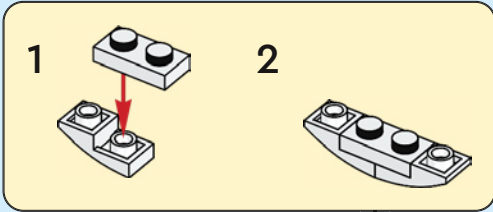

9

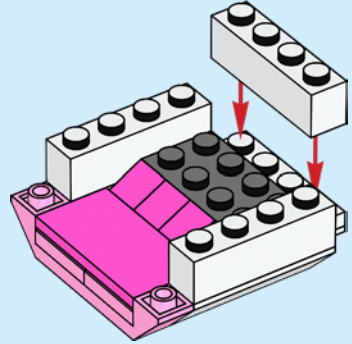

10

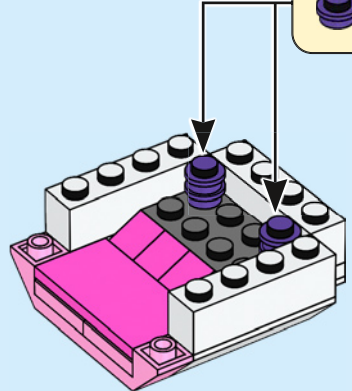
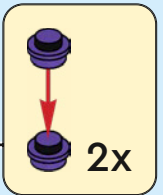

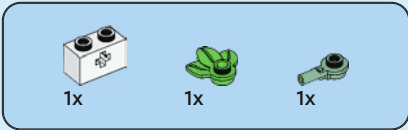

11

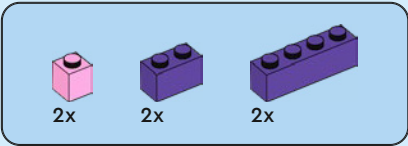
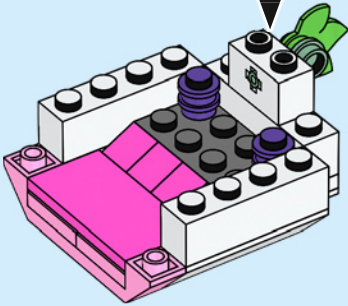
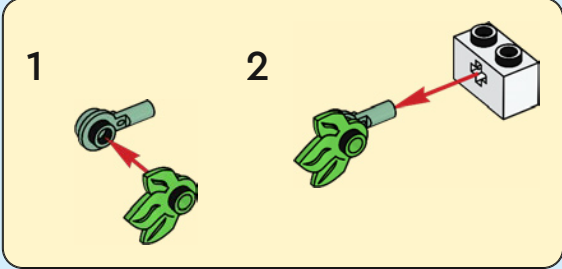

12

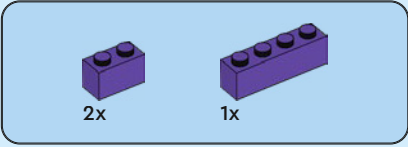
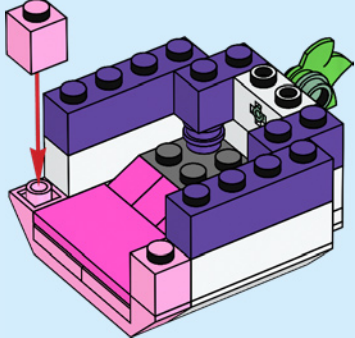

13

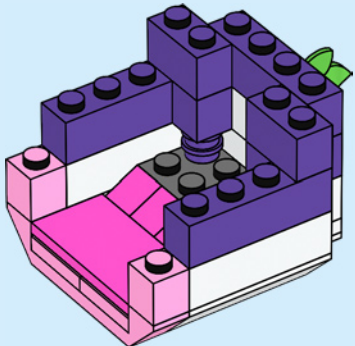

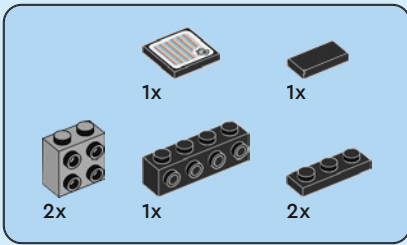

14

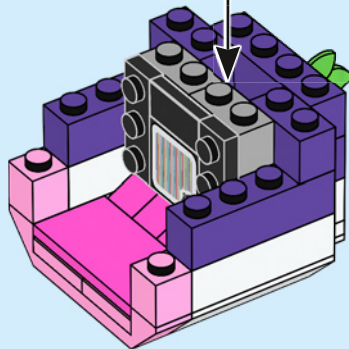
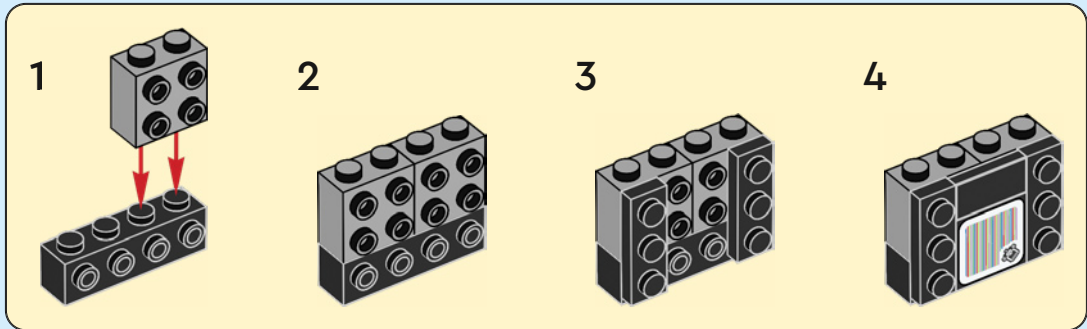

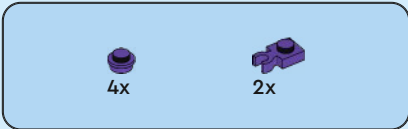

15

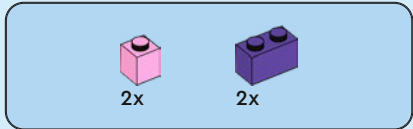
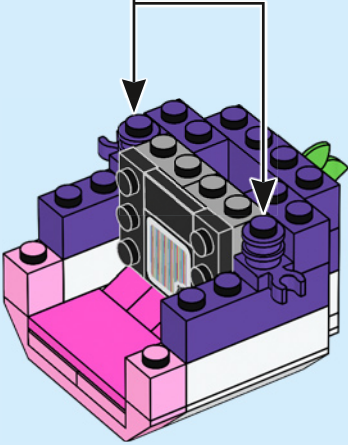
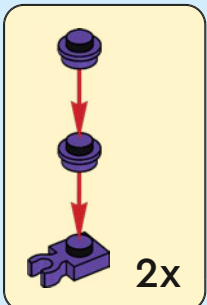

16

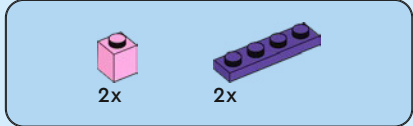
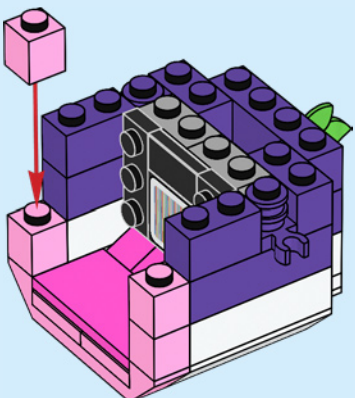

17

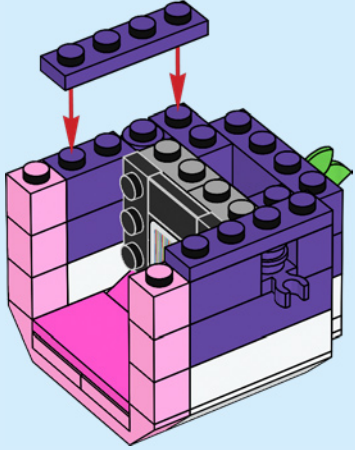

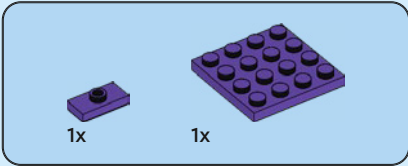

18

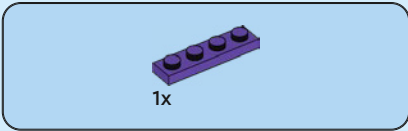
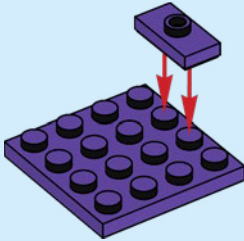

19

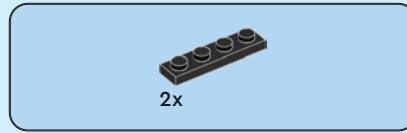
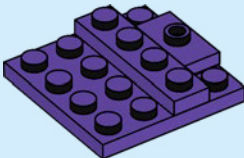

20

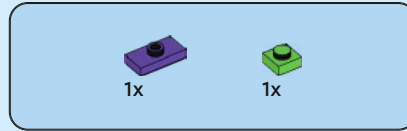
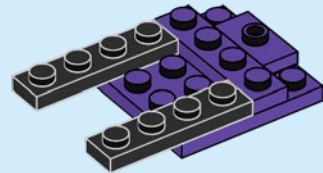

21

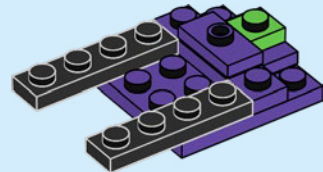



22

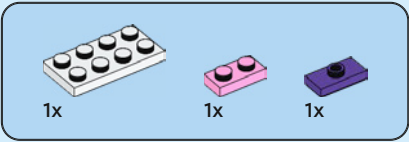
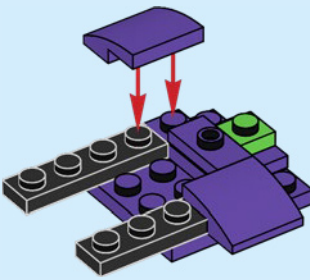

23

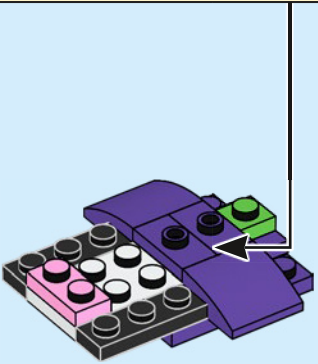
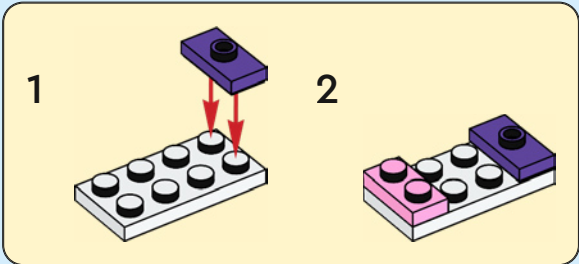





24

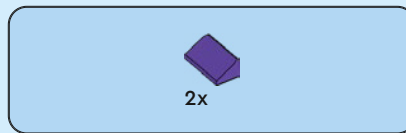
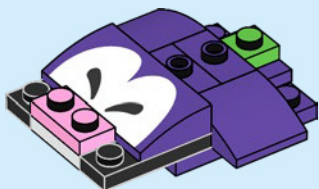

26

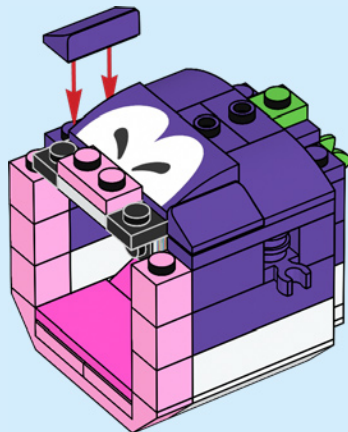

27

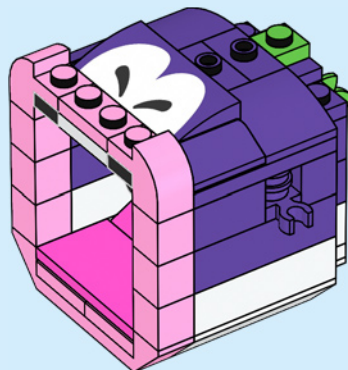

25

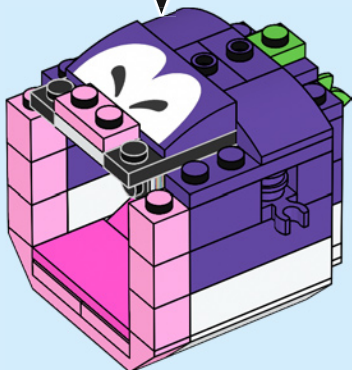

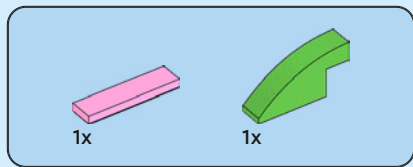

28

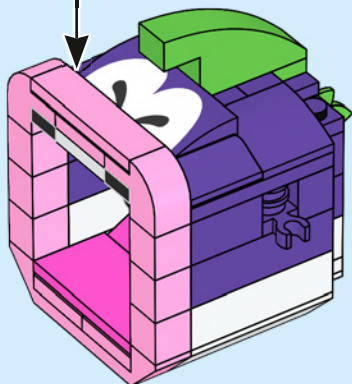
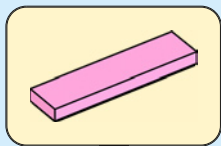

29

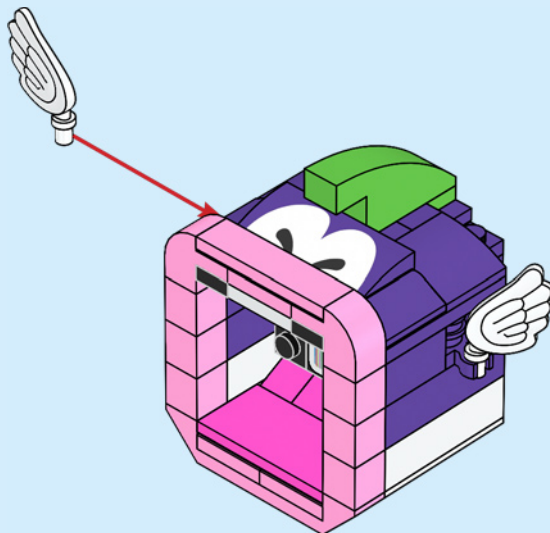

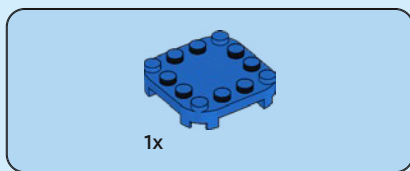
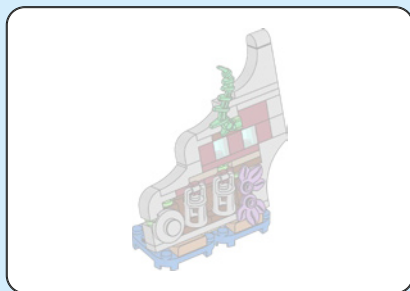

1

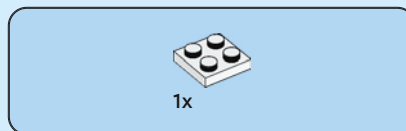
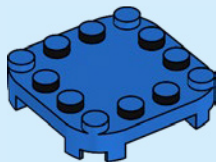

2

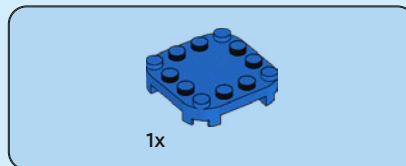
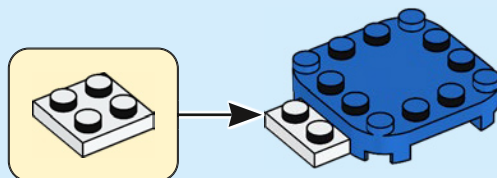

3

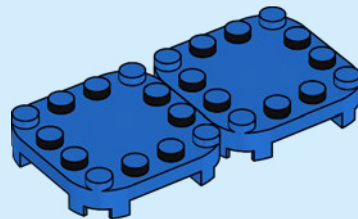



4

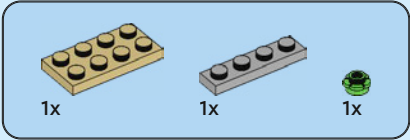
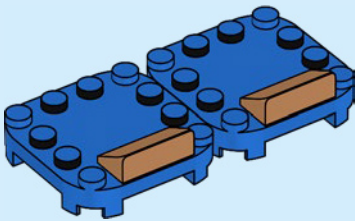

5

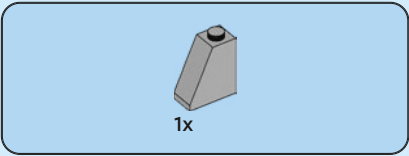
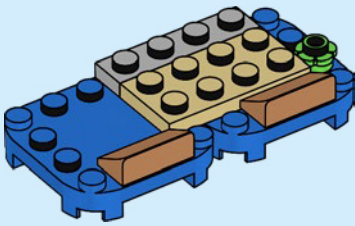

6

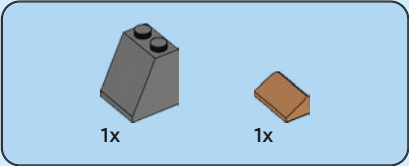
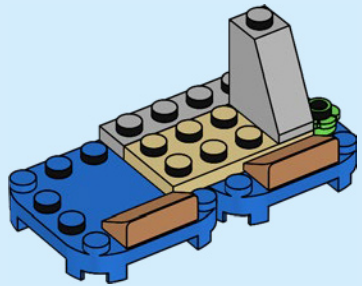

7

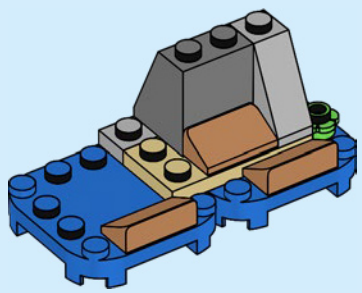

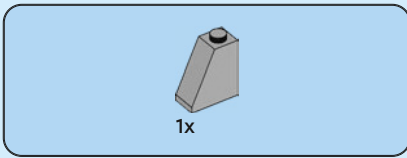

8

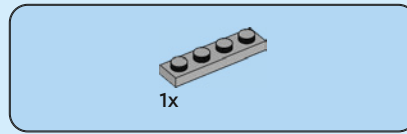
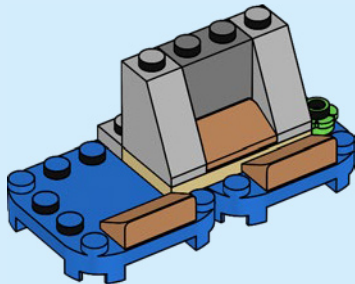

9

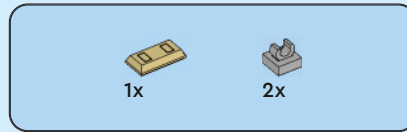
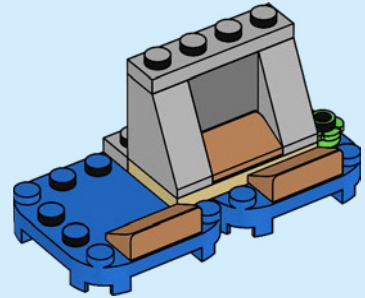

10

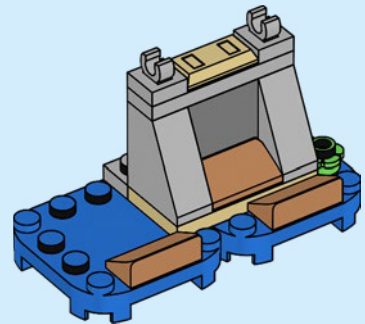

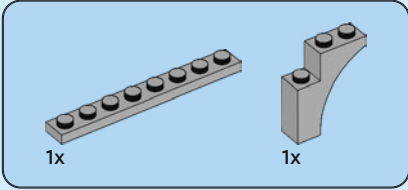
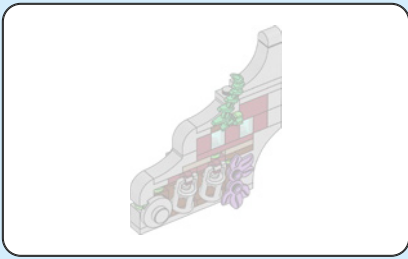

11

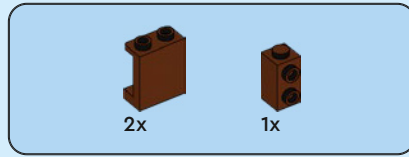
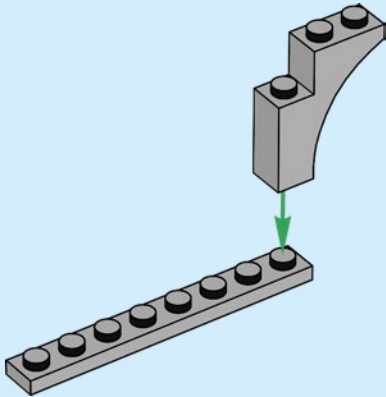

12

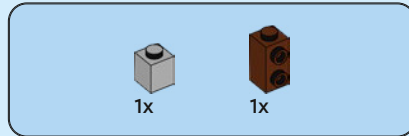
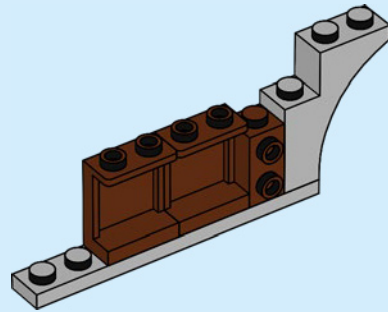

13

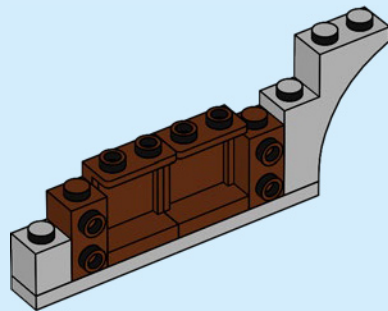



3x

14

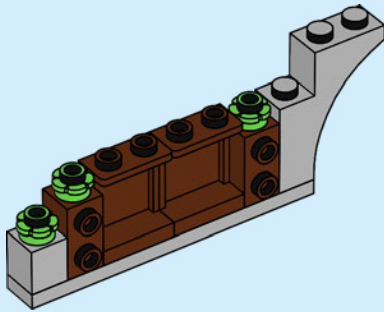

1x



1x



2x

15

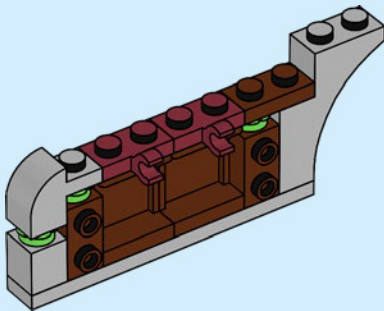

1x



2x

16

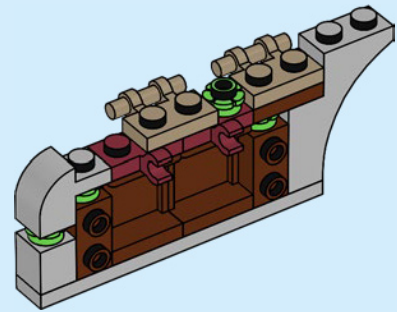

1x



1x

17

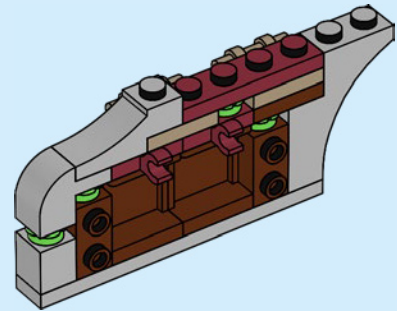



18

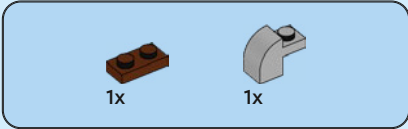
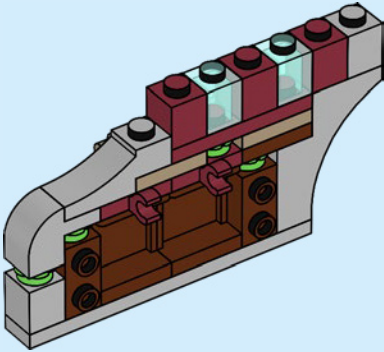

19

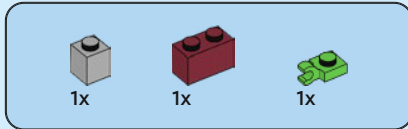
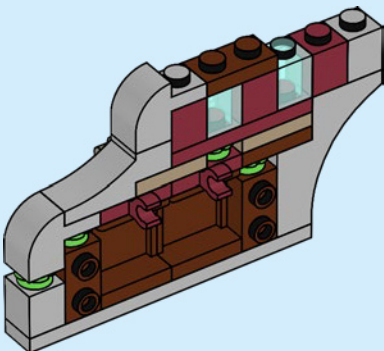

20

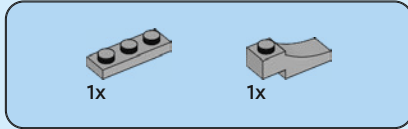
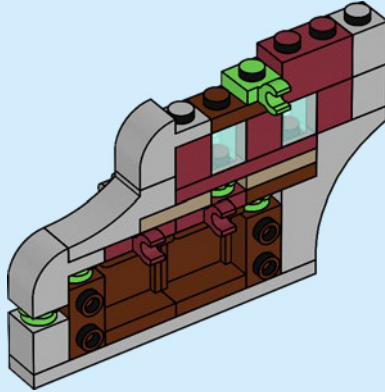

21

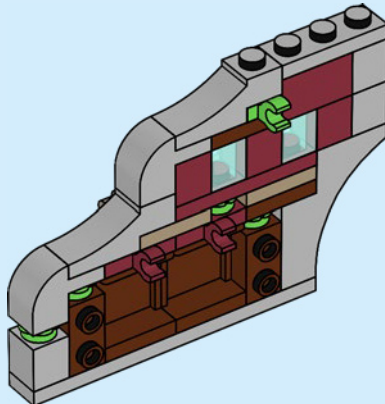



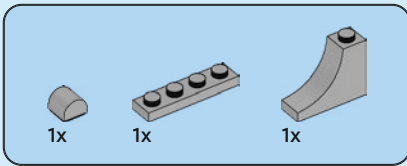

22

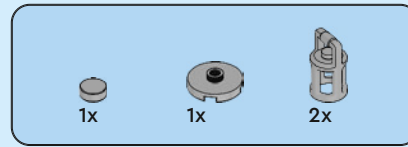
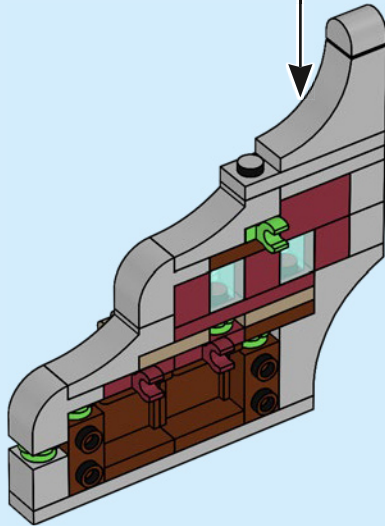
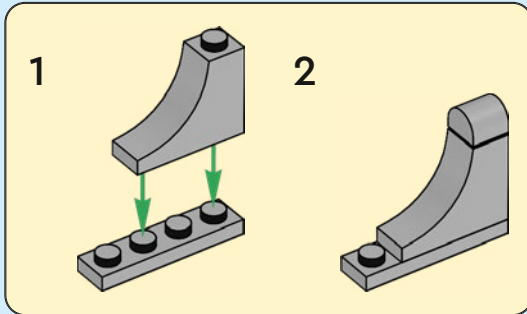

23

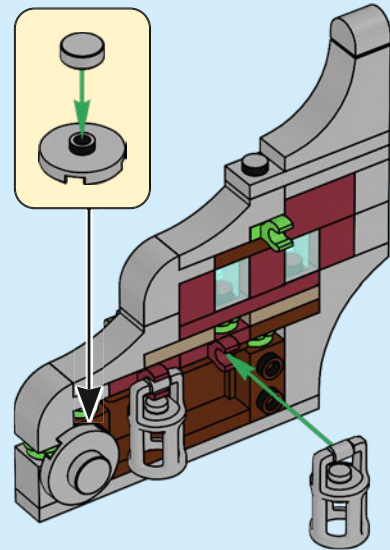

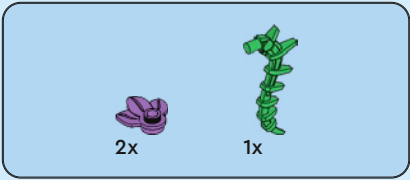

24

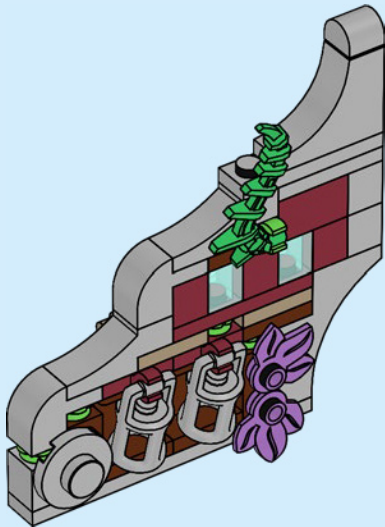

25

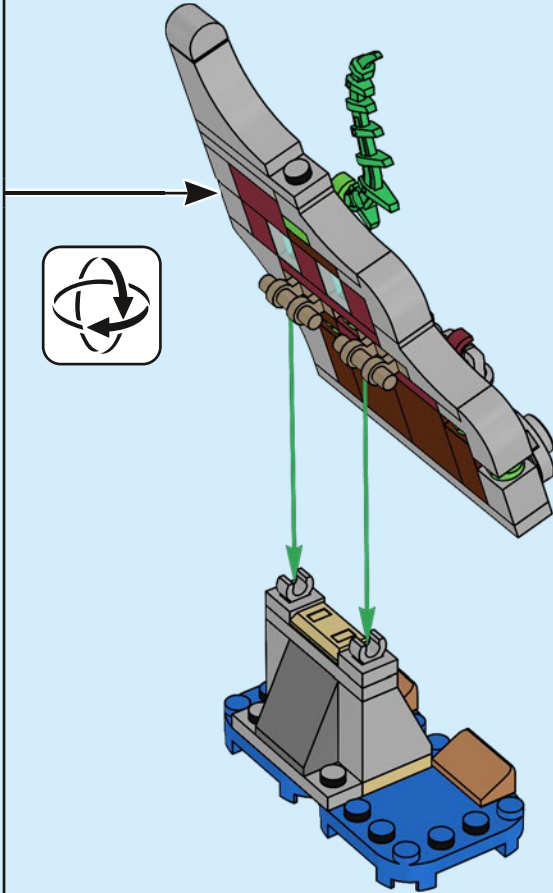

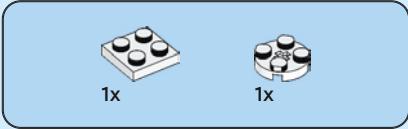
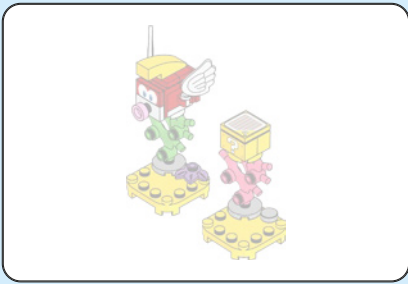

1

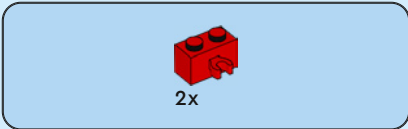
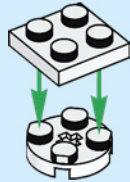

2

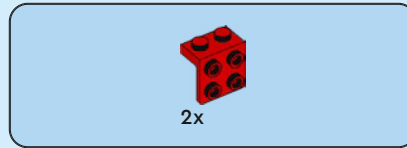
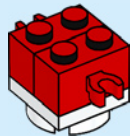

3

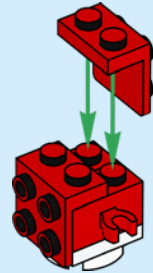

4

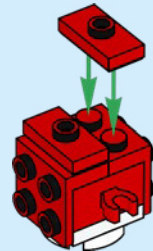



1x

5

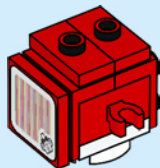

1x



1x



1x

6

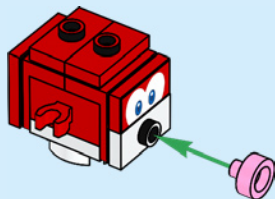

2x

7

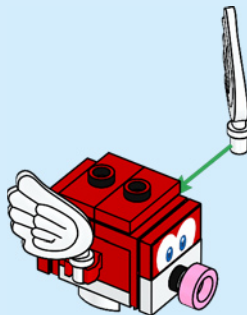

1x

8

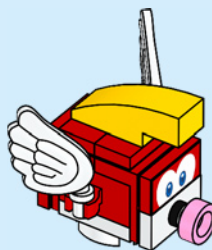

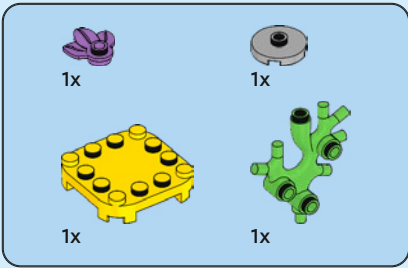

9

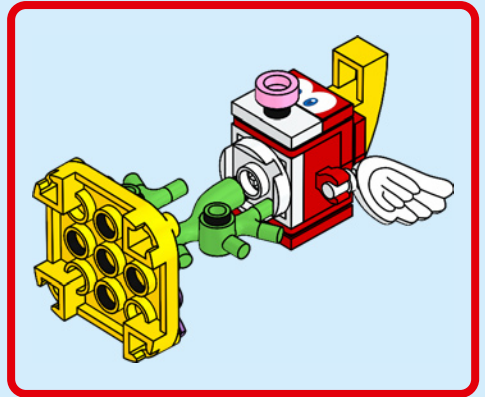
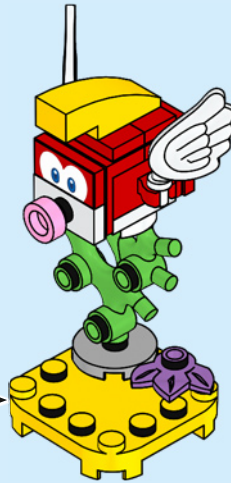
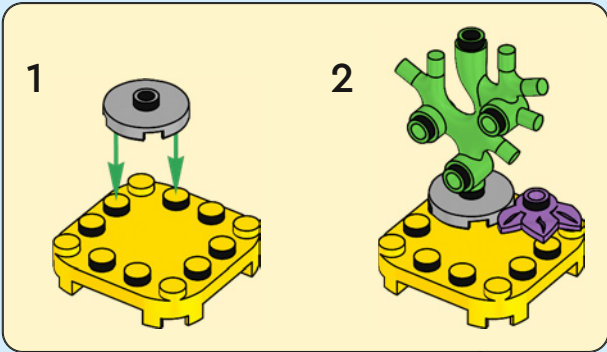

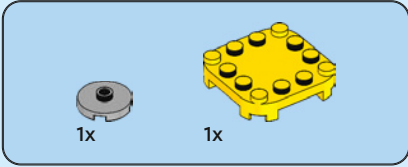
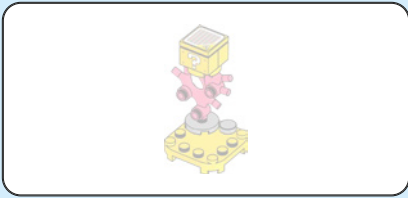

10

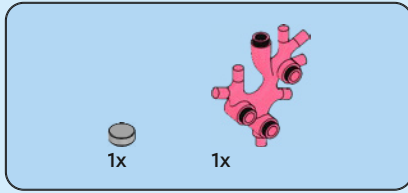
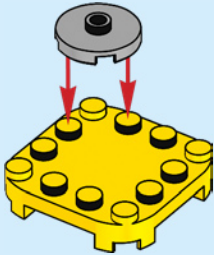

11

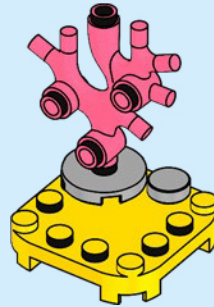



12

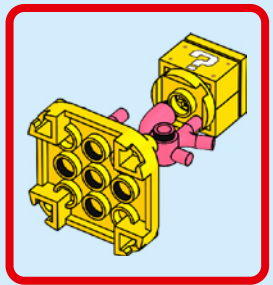
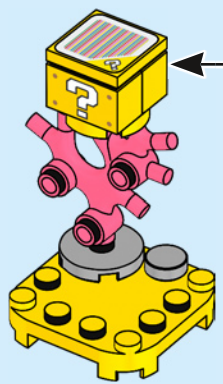
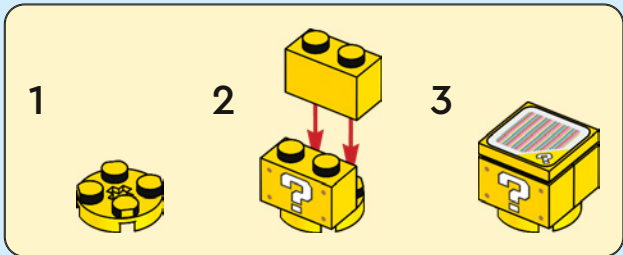

13

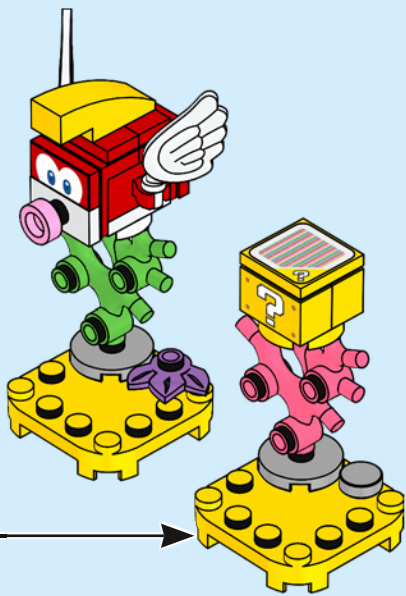





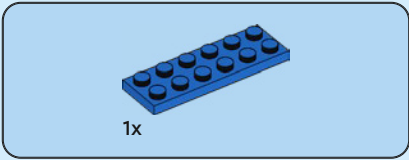

1

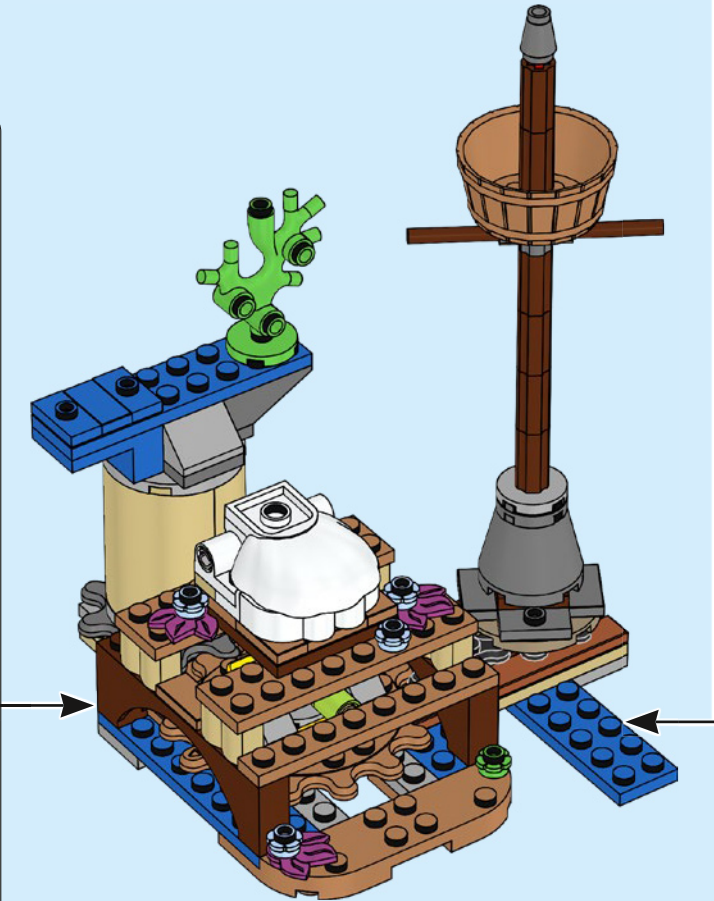
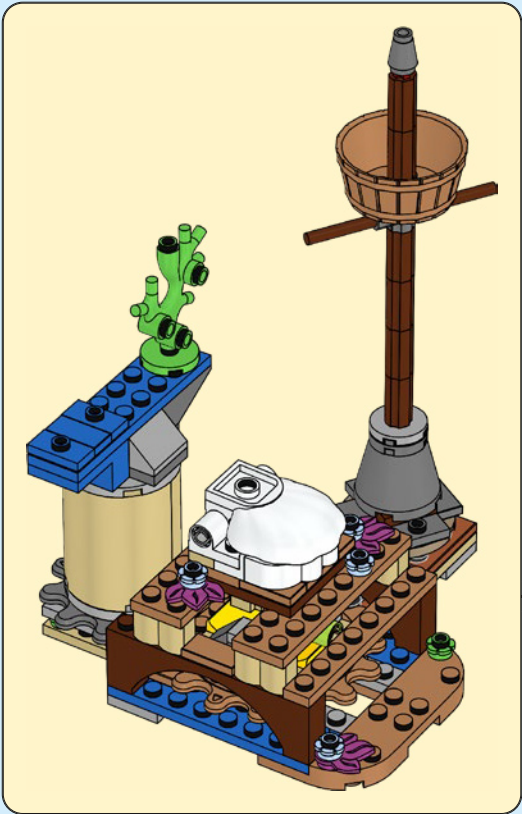
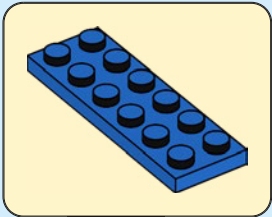

2

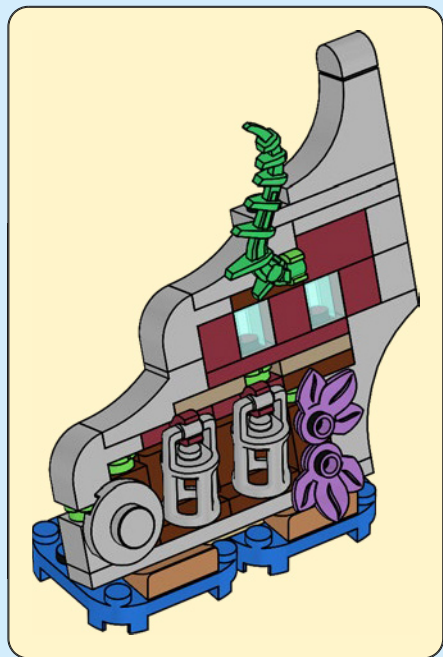



1x

3



4

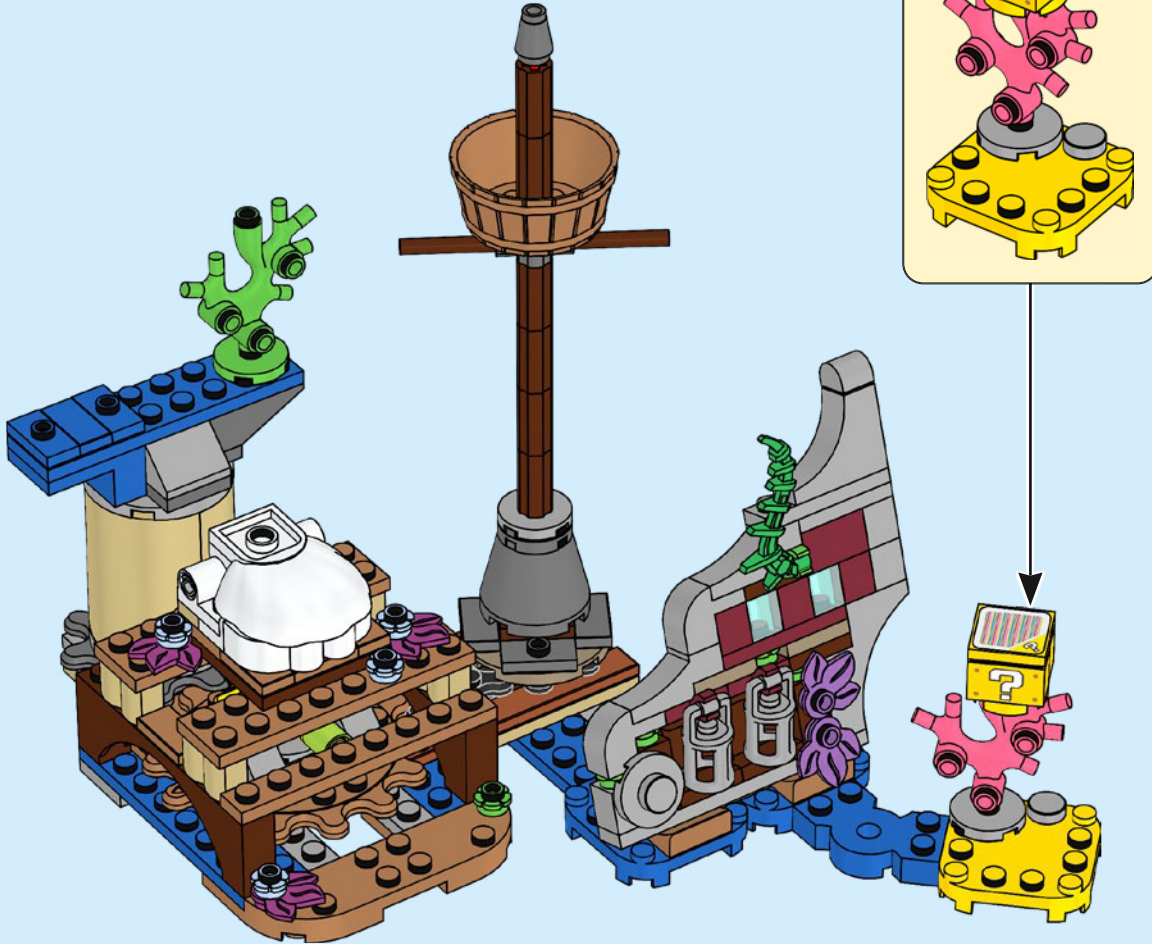

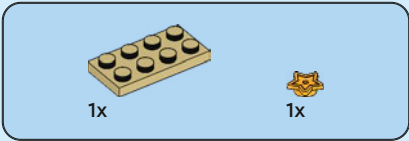

5

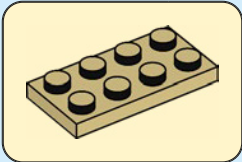



6

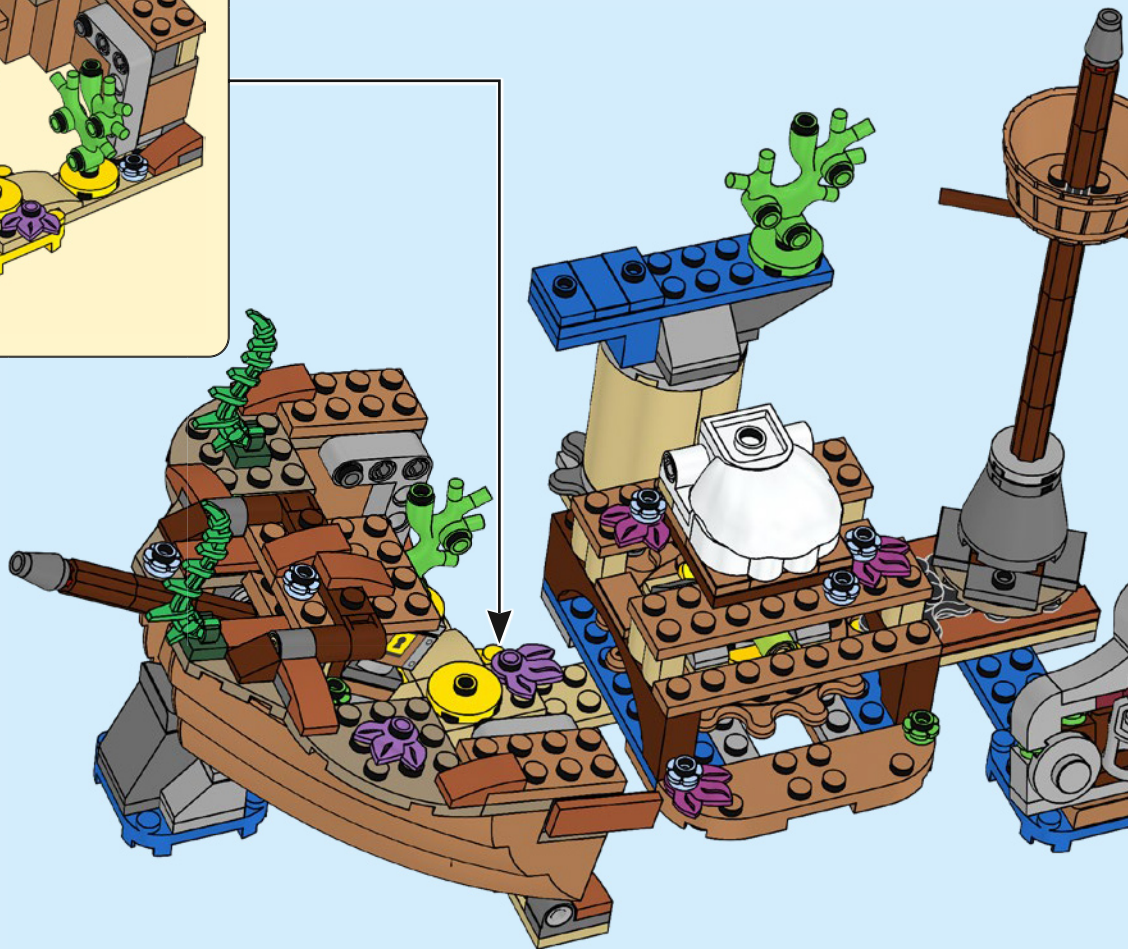

7

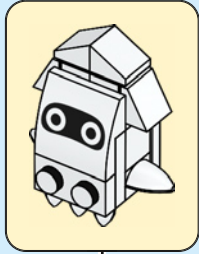



1x

8





9

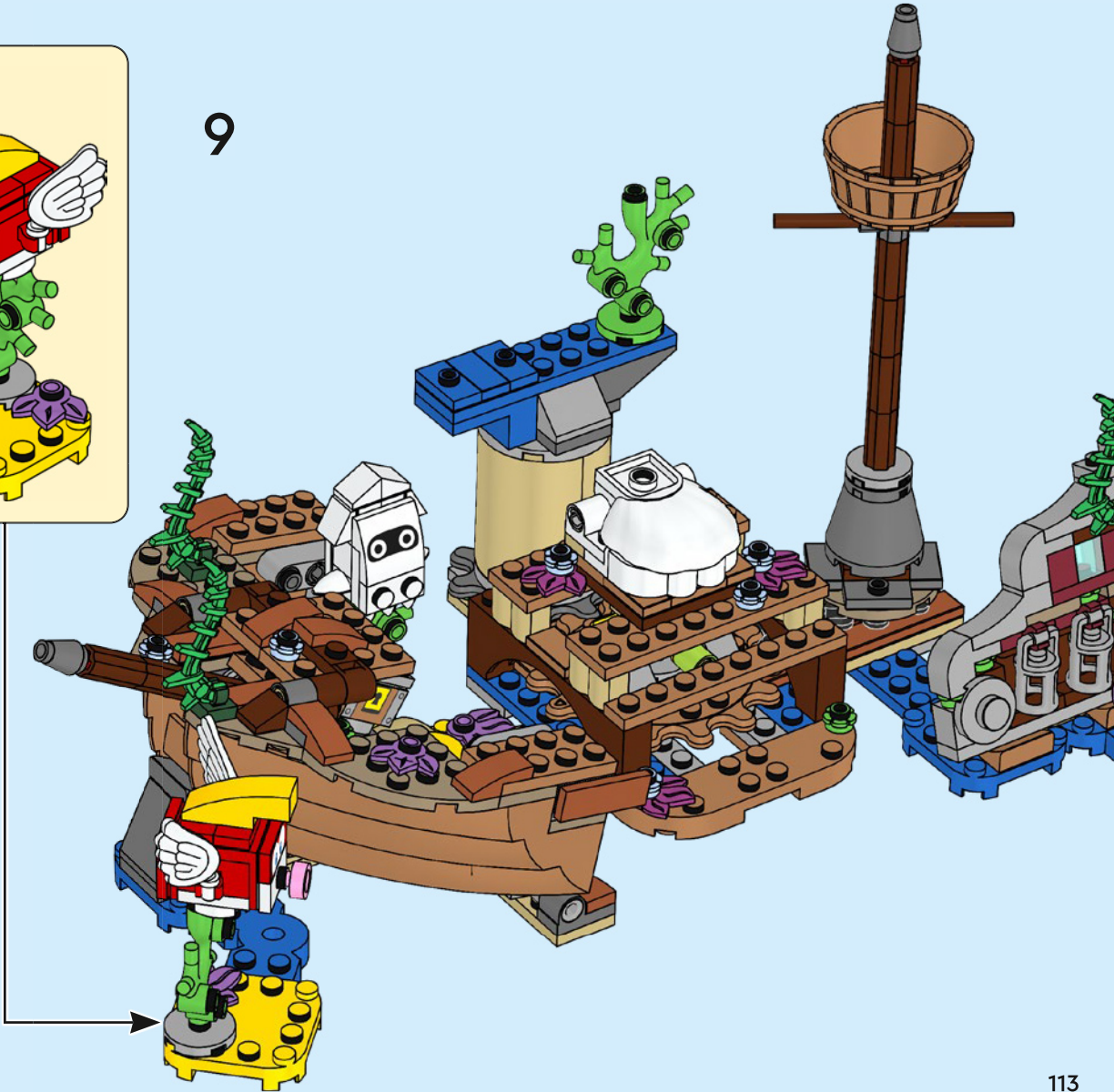
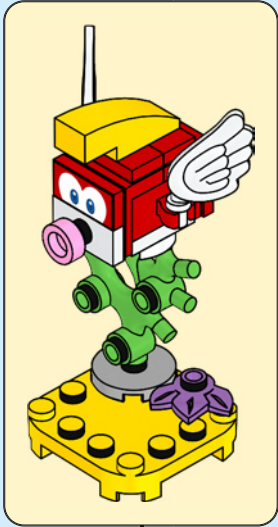

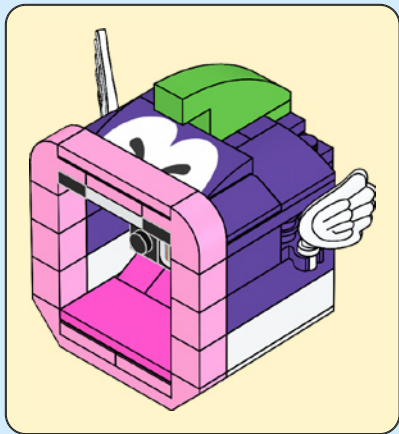

10



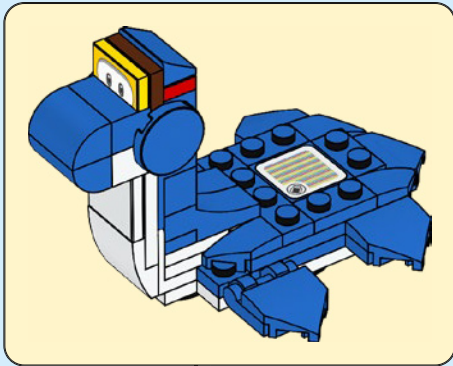

11

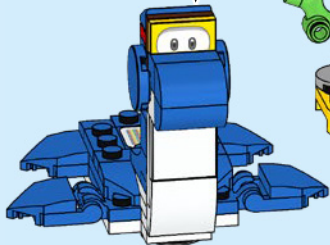

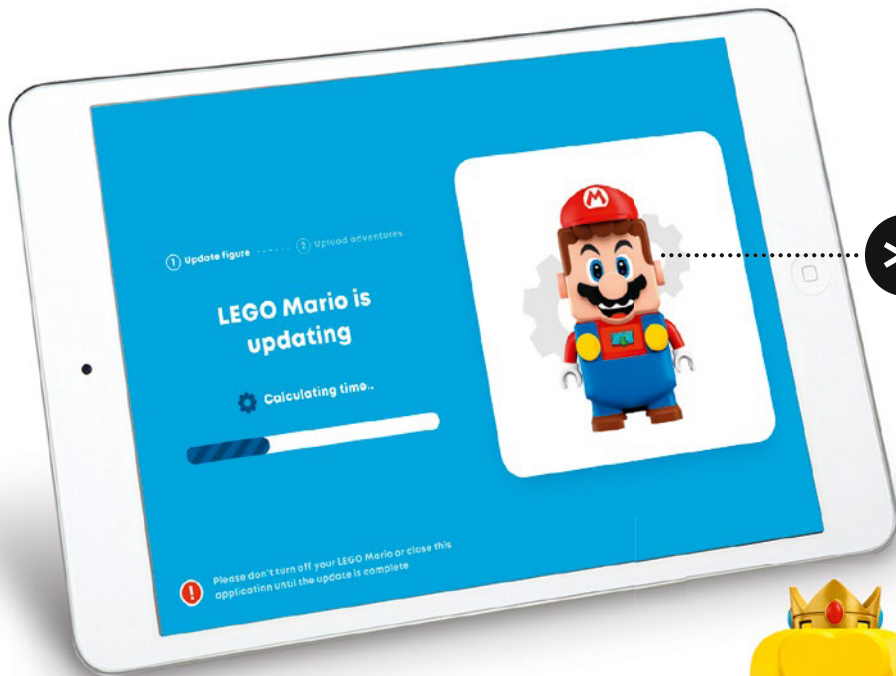

**UPDATE YOUR  
INTERACTIVE FIGURE  
IN THE LEGO®  
SUPER MARIO™ APP TO  
BE READY TO PLAY**

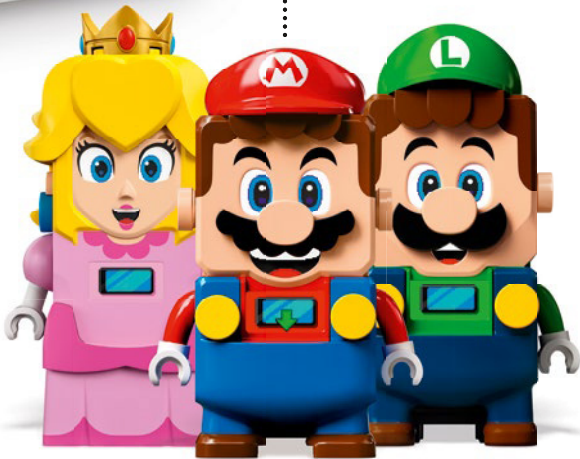

Update your interactive figure in the LEGO® Super Mario™ app to be ready to play

Aktualisiere deine interaktive Figur in der LEGO® Super Mario™ App und das Spiel kann beginnen

Mets à jour ta figurine interactive dans l'appli LEGO® Super Mario™ avant de jouer

Aggiorna il tuo personaggio interattivo nell'app LEGO® Super Mario™ perché sia pronto per giocare

Actualiza tu figura interactiva en la app LEGO® Super Mario™ y prepárate para jugar

Atualiza a tua figura interativa na aplicação LEGO® Super Mario™ para começar a jogar

在乐高®超级马力欧应用程序中更新你的交互式人偶，为玩乐做好准备

Zaktualizuj swoją interaktywną figurkę w aplikacji LEGO® Super Mario™, aby przygotować ją do zabawy

Aktualizujte interaktivní figurku v aplikaci LEGO® Super Mario™, abyste se mohli pustit do hraní

Aktualizujte interaktivnú figúrku v aplikácii LEGO® Super Mario™, aby ste mohli pustiť do hrania

Frissítsd interaktív figurád a LEGO® Super Mario™ alkalmazásban és készülj fel a játékra!

Actualizează-ți figurina interactivă în aplicația LEGO® Super Mario™ pentru a fi gata de joacă

Актуализирайте интерактивната фигура в приложението LEGO® Super Mario™, за да сте готови за игра

Atjaunini savu interaktīvo figūru LEGO® Super Mario™ lietotnē, lai būtu gatavs rotaļāties

Värskenda oma interaktiivset figuuri rakenduses LEGO® Super Mario™, et olla mängimiseks valmis

Atnaujinkite interaktyvią figūrėlę programėlėje „LEGO® Super Mario™“ ir pasiruoškite žaisti



## LEGO® Super Mario™ app

LEGO® Super Mario™ App  
Appli LEGO® Super Mario™  
App LEGO® Super Mario™  
App LEGO® Super Mario™  
Aplicação LEGO® Super Mario™  
乐高®超级马力欧®应用程序  
Aplikacija LEGO® Super Mario™  
Aplikace LEGO® Super Mario™  
Aplikácia LEGO® Super Mario™  
LEGO® Super Mario™ alkalmazás  
Aplicația LEGO® Super Mario™  
Приложение LEGO® Super Mario™  
LEGO® Super Mario™ lietotne  
LEGO® Super Mario™ rakendus  
Programélé „LEGO® Super Mario™“



[LEGO.com/super-mario-trouble-shooting-guide](https://www.lego.com/super-mario-trouble-shooting-guide)



71432

+



71360

OR



71387

OR



71403

OR / ODER / OU / OPPURE / O / 或 / LUB / NEBO / ALEBO / VAGY / SAU / ИЛИ / ВАИ  
/ VÕI / ARBA

**DISCOVER MORE  
ABOUT YOUR  
SET IN THE APP**



Discover more about your set in the app  
Entdecke in der App noch mehr über dein Set  
Découvre plus de détails sur ton set dans l'appli  
Scopri di più sul tuo set nell'app  
Descubre más acerca de tu set en la app  
Conhece melhor o teu set na aplicação  
可通过应用程序了解更多关于此套装的信息  
Dowiedz się więcej sprawdzając w aplikacji  
Zjistěte více o své stavebnici v aplikaci  
Zisti viac o svojej stavebnici v aplikácii  
Tudj meg többet a készletről az alkalmazásban!  
Descoperă mai multe despre setul tău în aplicație  
Откройте повече за комплекта в приложението  
Atklāj vairāk par komplektu lietotnē  
Avasta oma komplekti kohta lisateavet rakendusest  
Sužinokite daugiau apie rinkinį programėlėje

71429

71432

71360

71428







71430



71431



71360

Starter Course 71360 and/or 71387 and/or 71403 needed

Starterset 71360 und/oder 71387 und/oder 71403 wird benötigt

Pack(s) de démarrage 71360 et/ou 71387 et/ou 71403 nécessaire(s)

Starter Pack 71360 e/o 71387 e/o 71403 necessari

Se necesita el Pack Inicial 71360 y/o 71387 y/o 71403

Necessita do Pack Inicial 71360 e/ou 71387 e/ou 71403

スターセット (71360/71387/71403 のいずれか) が必要です

需要入门套组 71360 和/或 71387 和/或 71403

스타터팩 71360, 71387 또는 71403 이 필요합니다

Для игры необходимы Стартовые наборы (арт. 71360 и/или 71387, и/или 71403)

Potrzebne są zestawy startowe 71360, 71387 i/lub 71403

Je zapotřebí startovací set 71360 nebo 71387 nebo 71403

Je potrebný štartovací set 71360 a/alebo 71387 a/alebo 71403

A 71360-as és/vagy a 71387-es és/vagy a 71403-as Kezdőpálya szükséges

Este nevoie de Setul de bază 71360 și/sau 71387 și/sau 71403

Нужни са начална писта 71360 и/или 71387 и/или 71403

Nepieciešams sākuma maršruta komplekts 71360 un/vai 71387, un/vai 71403

Vaja on alustusrada 71360 ja/või 71387 ja/või 71403

Reikalingas pradinis rinkinys 71360 ir (arba) 71387 ir (arba) 71403



Rebuild  
the  
world™





Rebuild  
the  
world™



2x  
6258135

4x  
4504369

2x  
407001

2x  
6242241

2x  
4224792

4x  
6412850

2x  
6210272

1x  
403201

4x  
4278271

1x  
4667575

1x  
6178921

2x  
302301

2x  
6172927

2x  
6285777

4x  
6057414

1x  
6051511

1x  
300401

1x  
6046381

1x  
6097637

2x  
6361170

5x  
302201

1x  
6429481

1x  
6424428

1x  
306801

1x  
6047220

2x  
362301

3x  
301001

1x  
6097097

3x  
302001

2x  
366601

1x  
6345204

2x  
4117070

2x  
6374151

1x  
4666579

6x  
4218749

4x  
6092587

2x  
6271228

4x  
6046924

2x  
6321305

3x  
6454937

1x  
4118790

2x  
6232142

1x  
4113233

2x  
4114309

1x  
4243824

1x  
4114001

3x  
4113988

8x  
4142865

3x  
302321

2x  
6092565

2x  
6330198

2x  
6117974

1x  
6465230

1x  
6475287

2x  
6172414

4x  
6347291

2x  
6172411

1x  
4651236

2x  
6133844

1x  
306923

2x  
6092582

4x  
302323

5x  
6378794

2x  
300423

2x  
6290532

1x  
6117968



1x  
6378789



2x  
4514398



3x  
302223



2x  
6439891



2x  
6472926



1x  
6475331



4x  
371023

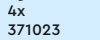

1x  
302023



3x  
6308879



1x  
6033353



1x  
379523



3x  
303423



2x  
4550348



1x  
6078279



1x  
403224



2x  
6299764



1x  
6375678



2x  
6353866



2x  
6315656



1x  
4247771



1x  
6465231



1x  
6314197



3x  
379524



2x  
379524



2x  
379524



2x  
379524



2x  
379524



1x  
306926



2x  
6310981



2x  
362326



1x  
6475322



4x  
370526



2x  
6306064



1x  
4162443



2x  
371026



1x  
4517986



8x  
6186009



4x  
6340118



2x  
6351291



2x  
6351291



2x  
6351291



2x  
6351291



18x  
6206150



3x  
6270055



1x  
6401817



1x  
6347296



1x  
6182261



1x  
6380676



3x  
6336855



1x  
6462436



2x  
6240551



1x  
6302741



3x  
6375929



2x  
6210495



2x  
6210495



2x  
6210495



2x  
6210495



4x  
6047415



2x  
6038637



1x  
6232138



2x  
4570451



3x  
4541376



2x  
6348061



2x  
6313126



1x  
6357616



1x  
4539102



1x  
4539061



1x  
6432033



2x  
6170813



2x  
4504376



9x  
4531751



2x  
6313665

4

2x 6201911	2x 6271165	2x 4211410	2x 4515351	2x 4529240
2x 6261744	2x 6284071	1x 6456617	3x 4211395	2x 6395635
2x 4211150	2x 6357262	1x 6456618	2x 4211713	1x 4567887
2x 6064188	2x 6308012	1x 6438694	1x 6045718	1x 4211042
1x 6168623	3x 4211389	2x 6338962	1x 6310174	1x 6310174
2x 6428805	1x 6262085	1x 6129340	3x 4211425	6x 4211063
1x 4211189	3x 4211475	1x 4211429	1x 4211406	2x 6069164
2x 6280388	2x 6179186	1x 6225228	2x 4211807	4x 6019987
1x 6070442	2x 4515369	2x 6329117	3x 6183782	2x 4211052
2x 4216695	2x 4211614	4x 4211445	2x 6123809	3x 6178919
2x 6415991	2x 4515374	1x 4211356	2x 6213378	2x 6276873
	1x 6015344			1x 6167281
	2x 6168633			
	2x 6285778			

2x  
6092572



2x  
4234534



1x  
6126083



1x  
6201630



1x  
4211064



1x  
4211065



1x  
6252371



7x  
6209683



4x  
6127601



1x  
6056261



1x  
6230579



6x  
4286050



2x  
6204515



1x  
4621552

1x  
4654128



2x  
6204535



1x  
6470204



10x  
4566522



2x  
6352224



2x  
4566607



3x  
6092604



6x  
6104154



2x  
6182217



3x  
6167464



3x  
6185995



1x  
6465233



1x  
6109819



1x  
6112964



5x  
6210460



1x  
6287309



1x  
6292823



3x  
6218358



2x  
6218360



1x  
6102994



1x  
6058085



1x  
6143217



4x  
6093494



1x  
6175943



1x  
6347603



5x  
6021997



2x  
6226644



1x  
6338455



1x  
6353587



1x  
6381921



1x  
6470206



1x  
6470206

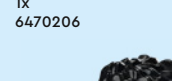

1x  
6470206



1x  
6470206



1x  
6470206



1x  
6470206

1x  
6470206



 [LEGO.com/service](https://www.LEGO.com/service)

YOU COULD **WIN**



Scan this QR code or go to  
**LEGO.COM/PRODUCTFEEDBACK** and give us  
your short feedback about this LEGO® set for a  
chance to win a cool LEGO prize.

Terms and Conditions apply\*

**EN: YOU COULD WIN.** Terms and Conditions apply\* **DE: Du könntest GEWINNEN.** Es gelten die Teilnahmebedingungen\* **FR: Tu pourrais GAGNER.** Des conditions s'appliquent\* **IT: Potresti VINCERE tu.** Termini e condizioni sono applicabili\* **ES: Puedes GANAR.** Aplican términos y condiciones\* **PT: Poderá GANHAR.** Aplicam-se termos e condições\* **ZH: 轻松获奖. 条款和条件适用\*** **PL: Szansa na WYGRANĄ.** Obowiązują warunki korzystania\* **CS: Máte šanci VYHRÁT.** Platí všeobecné smluvní podmínky\* **SK: Máte šancu VYHRAŤ.** Platia všeobecné zmluvné podmienky\* **HU: TE IS NYERHETSZ.** Felhasználási feltételek érvényesek\* **RO: Ai putea CÂȘTIGA.** Se aplică termeni și condiții\* **BG: Можете да СПЕЧЕЛИТЕ.** Има определени правила и условия\* **LV: Tu vari LAIMĒT.** Ir spēkā noteikumi un nosacījumi.\* **ET: Sul on võimalus VÕITA.** Kehtivad tingimused\* **LT: Jūs galite LAIMĖTI.** Taikomos sąlygos\*

\*[LEGO.com/productfeedback-terms](https://www.lego.com/productfeedback-terms)

LEGO, the LEGO logo and the Brick and Knob configurations are trademarks and/or copyrights of the LEGO Group. ©2024 The LEGO Group.

TM & © 2024 Nintendo.

6497691