



BIONICLE®

71301



 [LEGO.com/bionicle](https://www.LEGO.com/bionicle)



WARNING: CHOKING HAZARD.
Toy contains small parts and a small ball.
Not for children under 3 years.





AVERTISSEMENT : RISQUE D'ÉTOUFFEMENT.

Le jouet contient des petites pièces ainsi qu'une petite boule.
Il ne convient pas aux enfants de moins de 3 ans.



ADVERTENCIA: PELIGRO DE ASFIXIA.

Juguete que contiene partes pequeñas y una pelota pequeña.
No recomendado para niños menores de 3 años.

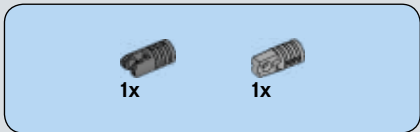
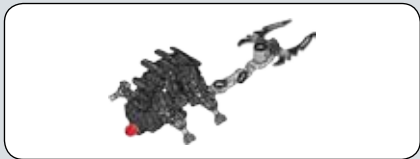

1

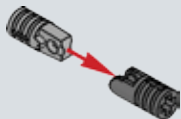

4



2

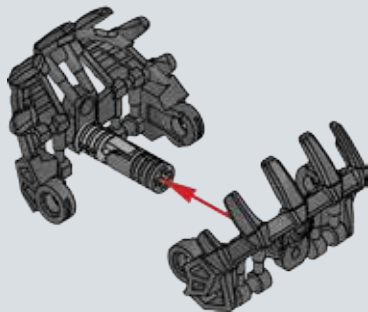



3

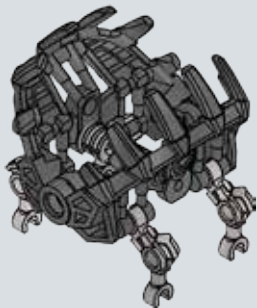

4

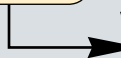

5



1x



4x

5

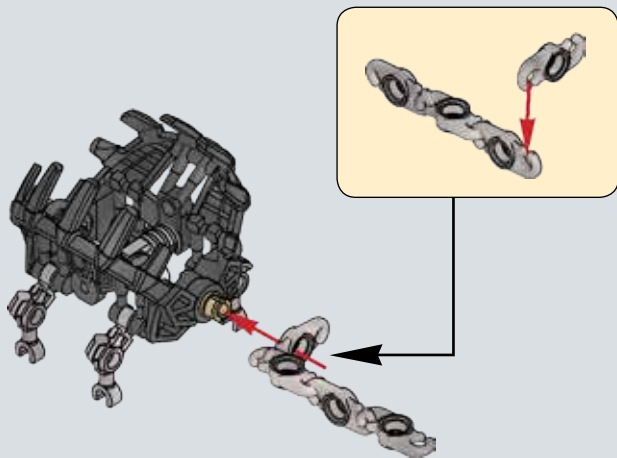

6

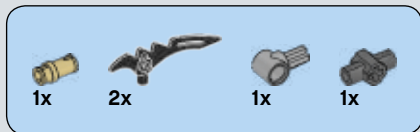

6

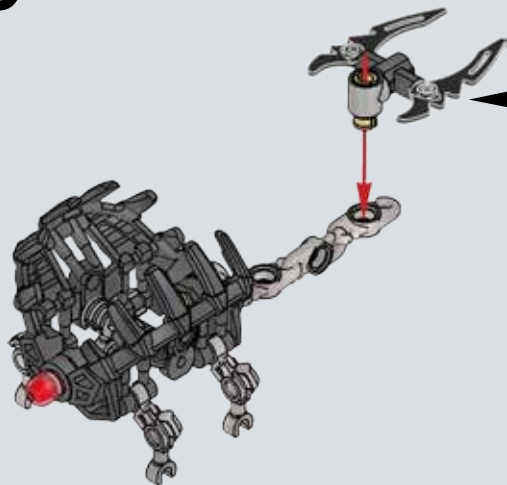

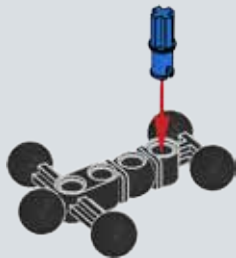
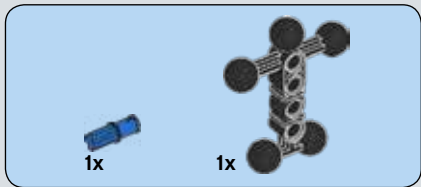

1

8



1x



1x

2

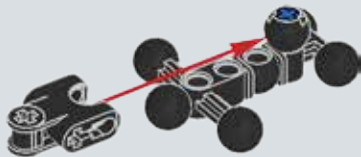

1x

3

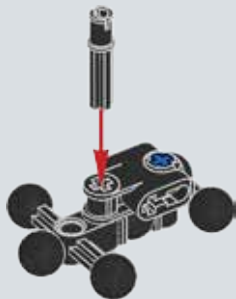



1x

4

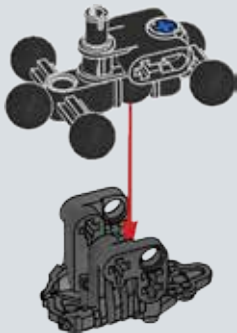

10



2x

5

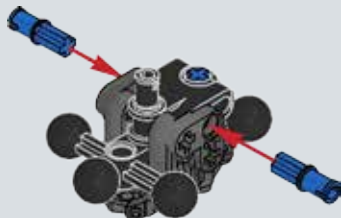

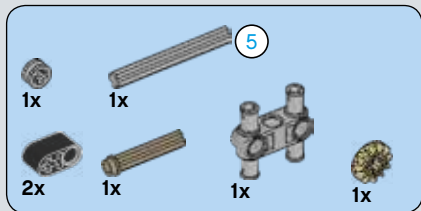

6

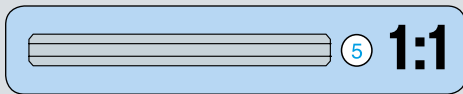
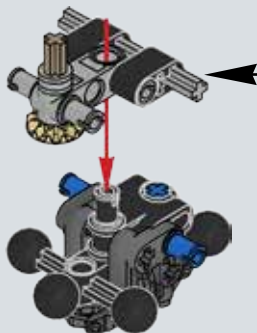
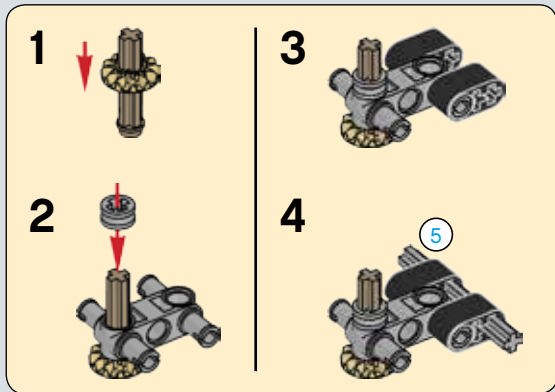



1x

7

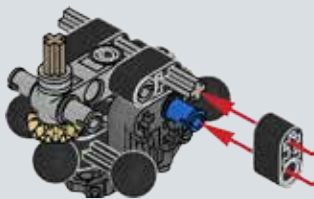

12



1x

8

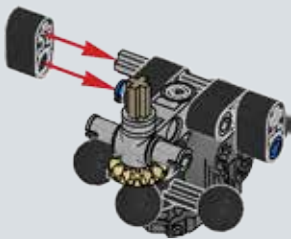



2x

9

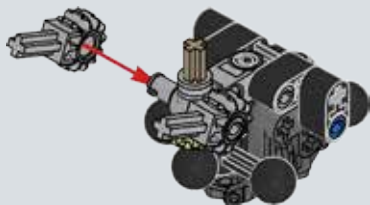

1x

10

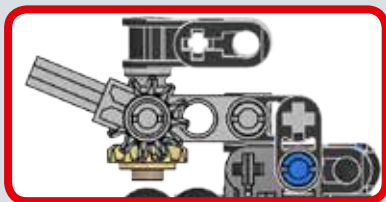
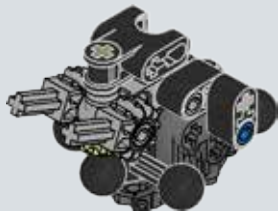

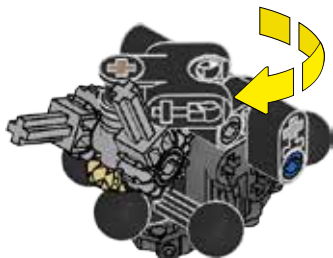
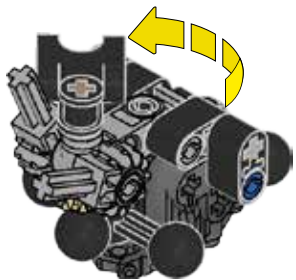



1x

11

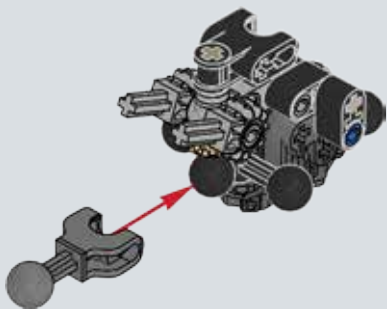



12

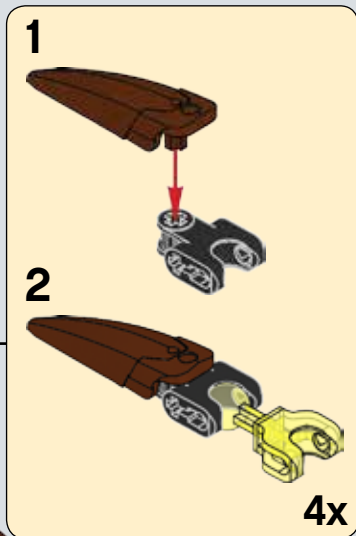
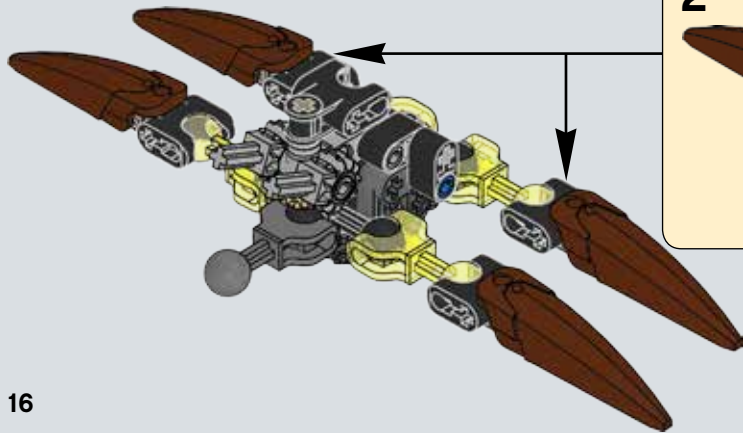

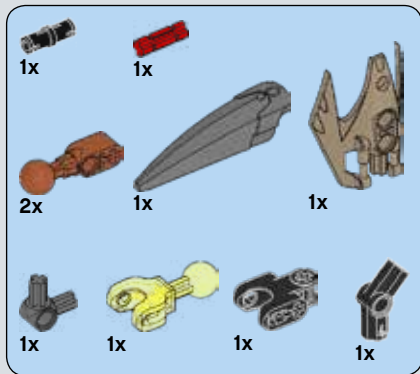

13

1

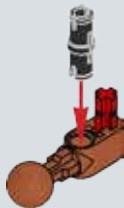

2



3

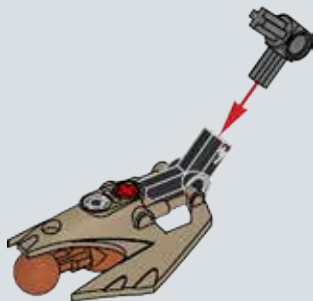

4

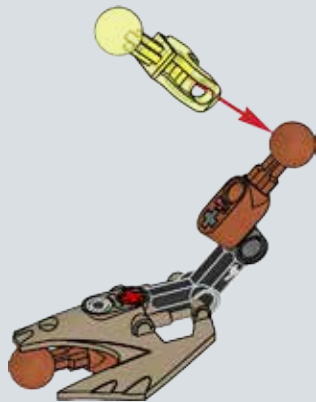

5

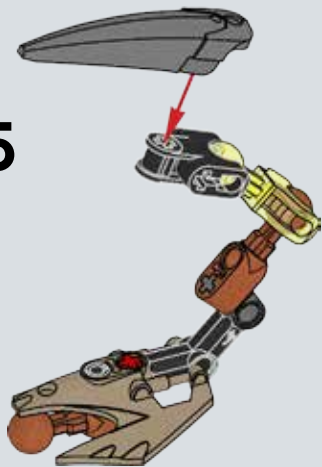

14

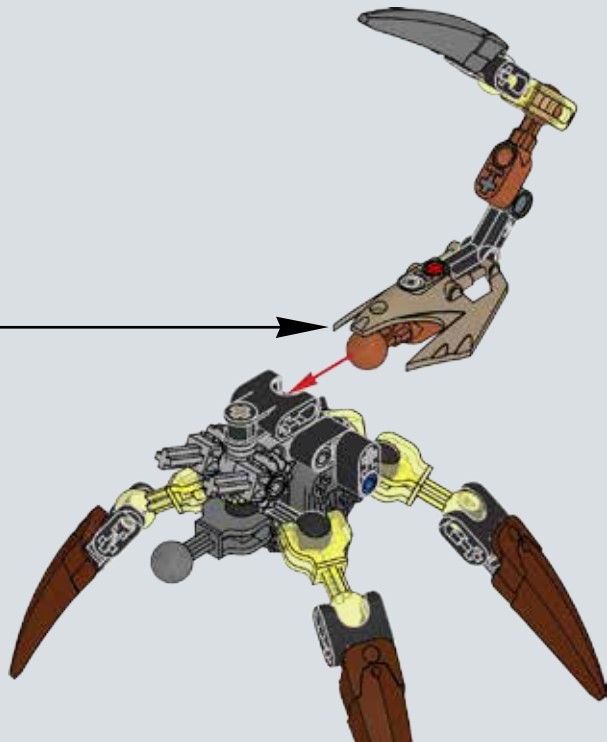

1x

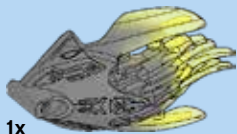

15

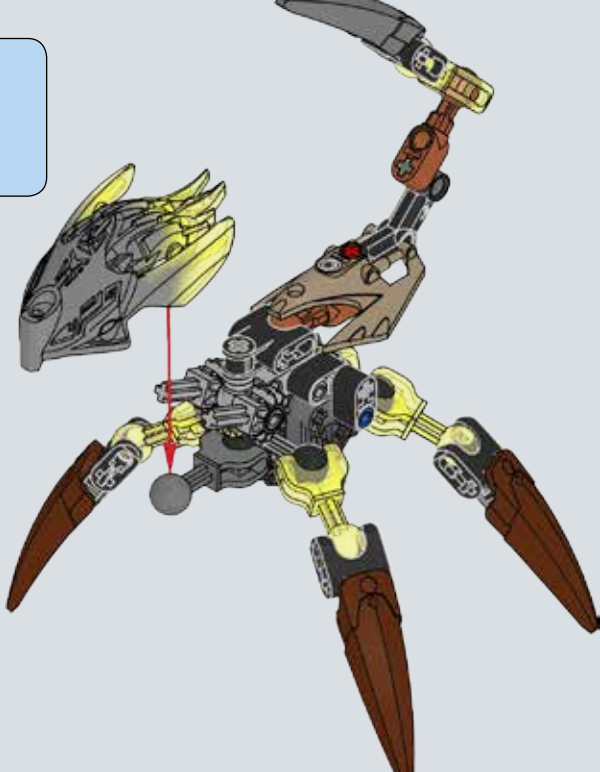

20

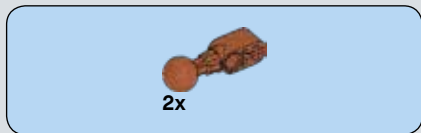

16

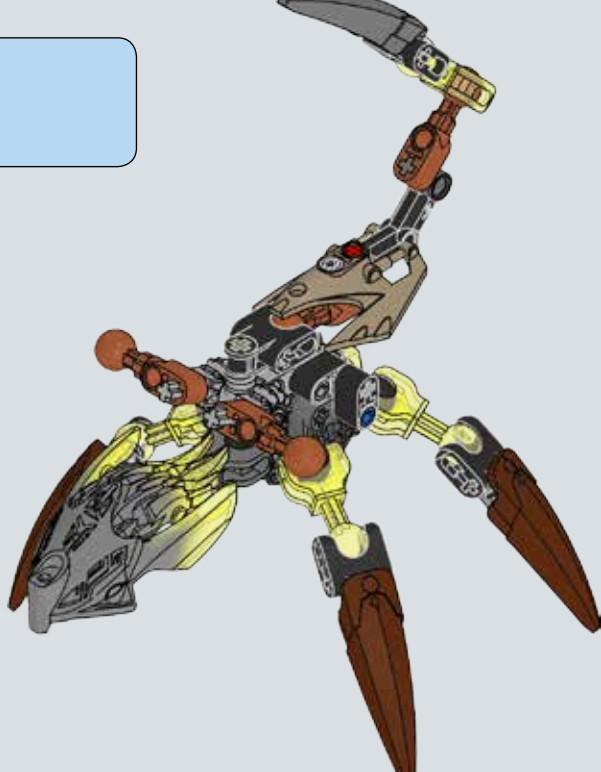



2x



2x



2x

17

1

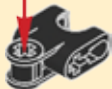

2



2x

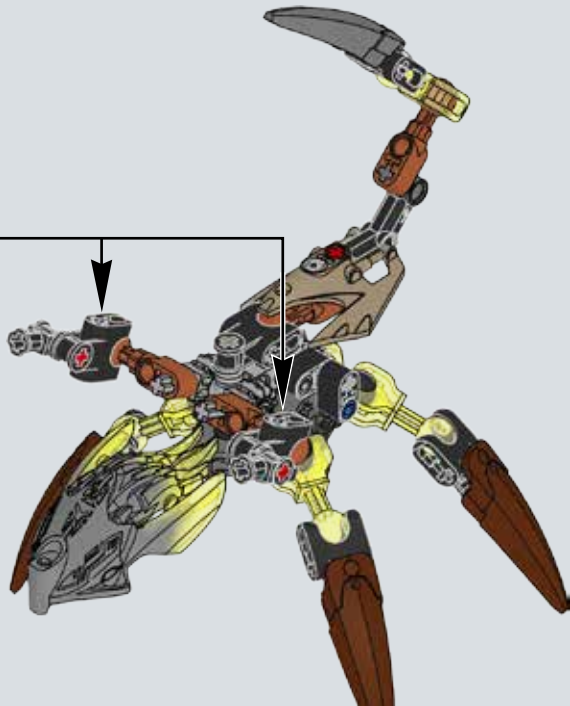

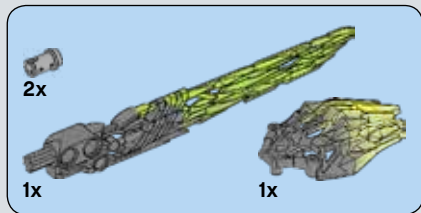

18

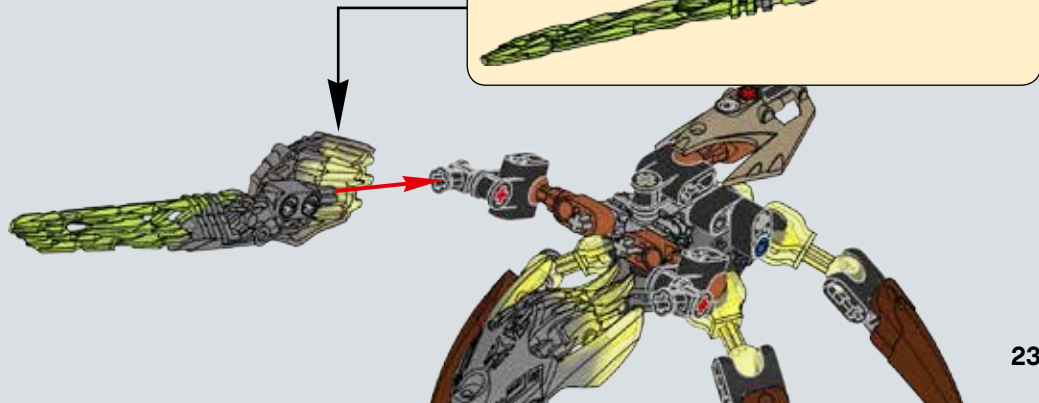
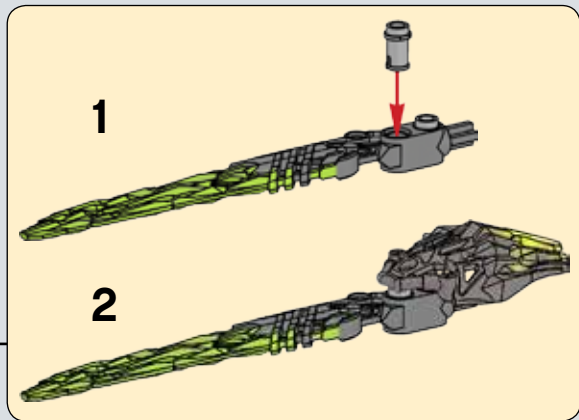

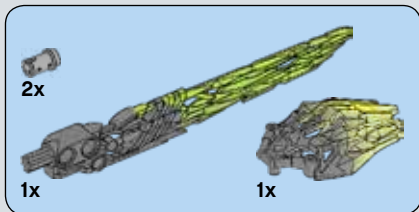

19

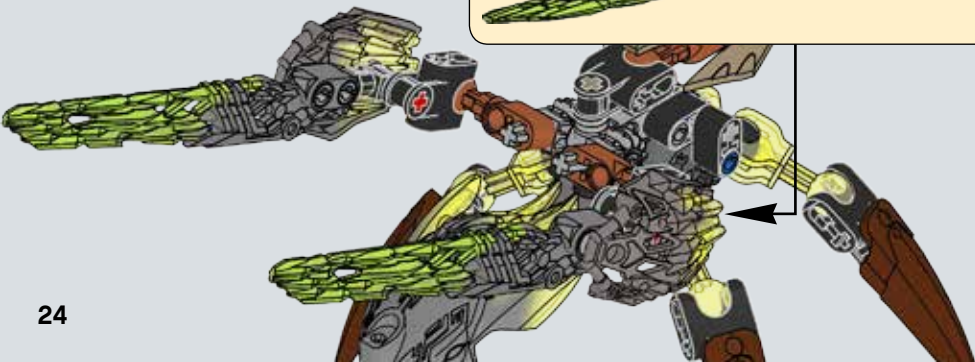
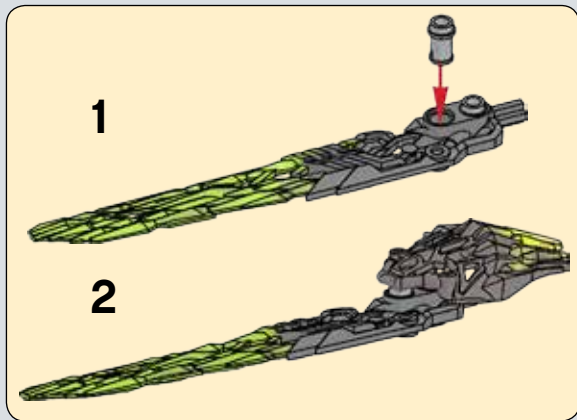

24

20

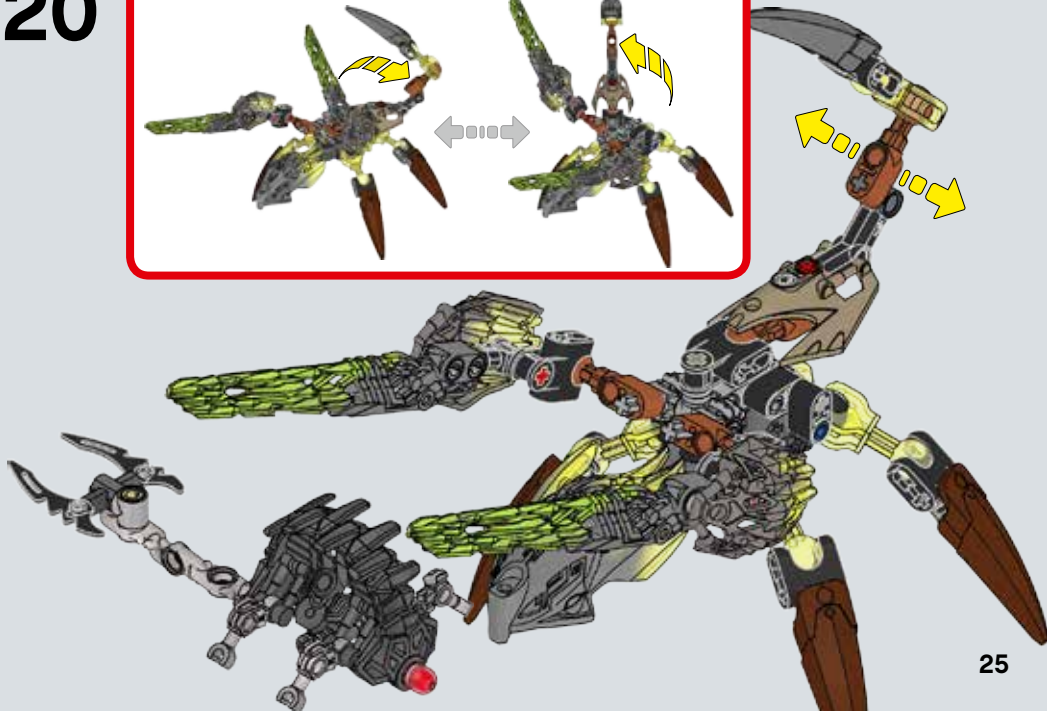
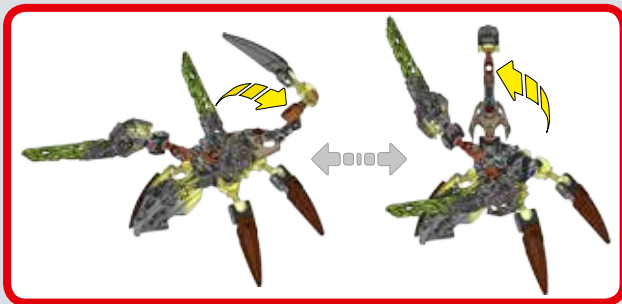

25

1x
6089119

1x
4286267

1x
4121610

1x
4121715

2x
4107081

4x
6006140

9x
4610948

2x
6039203

1x
4667277

4x
6124042

4x
6069076

1x
4565452

2x
6013938

3x
4142865

4x
6139208

1x
4497943

3x
4206482

1x
6031821

1x
6139207

1x
4211573

5x
4211483

2x
6134848

1x
4211679

1x
6123815

1x
4225033

1x
4211639

4x
6068078

2x
6135094

1x
6056934

1x
6133824

1x
6135050

2x
6150660

5x
6078390

1x
4210695

1x
6005331

1x
6135325

1x
6138237

2x
6135124



Customer Service

Kundenservice

Service Consommateurs

Servicio Al Consumidor

LEGO.com/service or dial



00800 5346 5555 :

1-800-422-5346 :





BIONICLE

71310



 LEGO.com/bionicle

Download App
Télécharger
l'application
Descarga la App



 Download on the
App Store

GET IT ON
 **Google play**

Apple, the Apple logo, iPad, iPhone and iPod touch are trademarks of Apple Inc.

Apple, le logo Apple, iPad, iPhone et iPod touch sont des marques de commerce d'Apple Inc.

Apple, el logotipo de Apple, iPad, iPhone e iPod touch son marcas comerciales de Apple Inc.

Google Play is a trademark of Google Inc.

Google Play est une marque de commerce de Google Inc.

Google Play es una marca comercial de Google Inc.



UNITE for battle



71301+71306

UNIS-LES pour le combat • Sólo podemos luchar UNIDOS



71300



71305



71303



71308



71301



71306



71304



71309



71302



71307



71311



71311



71311

71302

71301

71311

71307

71306



71303



71300



71304



71308



71305



71309