

LEGO[®]

Harry Potter

71043



[LEGO.com/harrypotter](https://www.LEGO.com/harrypotter)

WIZARDING
WORLD

Welcome back to Hogwarts™
Bienvenue à Poudlard
Te damos la bienvenida de regreso a Hogwarts™



“Help will always be given
at Hogwarts to those who ask for it.”

Albus Dumbledore™

Begin a magical journey with this detailed replica
of the iconic Hogwarts™ Castle.

Explore the prestigious school of witchcraft and wizardry. Experience a microscale LEGO® model built from over 6,000 pieces and packed with authentic details for a rewarding building experience. Discover the intricately designed chambers, towers, classrooms and many other hidden features depicting scenes from the Harry Potter™ series and recreate the movies' pivotal moments of magic and adventure. The set also contains 27 microfigures including Harry, Hermione and Ron, in addition to a spellbinding assortment of iconic accessories and artifacts.

There's magic in the details...

« Vous vous apercevrez qu'à Poudlard, une aide sera
toujours apportée à ceux qui en feront la demande. »

Albus Dumbledore™

Commencez un voyage magique avec cette
réplique détaillée du célèbre château de Poudlard.

Explorez la prestigieuse école de sorcellerie et de magie. Découvrez un modèle LEGO® à microéchelle construit à partir de plus de 6 000 pièces et regorgeant de détails authentiques pour vivre une expérience de construction enrichissante. Examinez la conception complexe des pièces, des tours, des salles de classe et des nombreuses autres caractéristiques cachées représentant des scènes de la série Harry Potter™, et recréez les plus grands moments de magie et d'aventure des films. L'ensemble contient aussi 27 microfigurines, dont Harry, Hermione et Ron, en plus d'un assortiment envoûtant d'accessoires et d'objets emblématiques.

Il y a de la magie dans les détails...

“Siempre se brindará ayuda en
Hogwarts a quienes la soliciten”.

Albus Dumbledore™

Embárcate en un mágico viaje con esta detallada
réplica del famoso Castillo de Hogwarts™.

Explora el prestigioso colegio de magia y hechicería. Este modelo LEGO® a microescala se compone de más de 6.000 elementos y está repleto de detalles de gran realismo que proporcionan una gratificante experiencia de construcción. Descubre el elaborado diseño de las cámaras, las torres y las aulas, y sorpréndete con los muchos rasgos ocultos basados en diferentes escenas de la saga de Harry Potter™ mientras recreas los mejores momentos de magia y aventura de las películas. El set contiene también 27 microfiguras (incluidos Harry, Hermione y Ron), además de un fascinante surtido de accesorios y artefactos memorables.

La magia está en los detalles...

Transforming Movie Moments into LEGO® Scenes Transformer des moments de films en scènes LEGO® Acerca de la transformación de los momentos cinematográficos en escenas LEGO®

Translating the magical onscreen locations into a LEGO® model in microscale was an exciting design challenge. To represent the key architectural structures, iconic silhouettes and details in tiny bricks, while retaining the unforgettable look and feel of the movies, was not an easy task.

Transposer les lieux magiques de l'écran à un modèle LEGO® à microéchelle a été un défi de conception passionnant. Représenter les structures architecturales clés, les silhouettes iconiques et les détails en minuscules briques, tout en recréant fidèlement les inoubliables images des films, n'était pas une tâche facile.

Reunir en un modelo LEGO® a microescala los mágicos lugares que aparecen en la pantalla resultó ser un extraordinario desafío de diseño. Representar las principales estructuras arquitectónicas, las siluetas más representativas y los detalles más importantes con pequeños bricks, sin perder ni una pizca del inolvidable aspecto de las películas y las sensaciones que evocan, no fue tarea fácil.

In the Great Hall, many elements including the tables, fire pits and house banners had to be scaled to fit into the model.

Dans la Grande Salle, de nombreux éléments dont les tables, les foyers et les bannières des maisons ont dû être réduits de façon à s'adapter à la taille du modèle.

En el Gran Comedor, fue necesario reflejar a escala muchos de los elementos, como las mesas, las chimeneas y los estandartes de las casas, para que cupieran en el modelo.

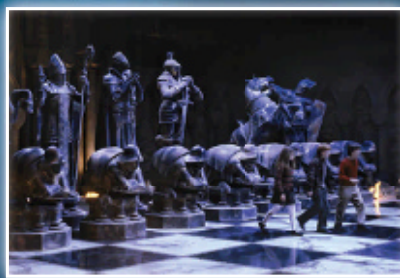

Recreating the iconic Wizard's Chess game in the small space available in the model meant halving the proportions of the chessboard. By making this compromise, there was also room to have the base of another tower in the model.

Pour recréer le célèbre jeu d'échecs version sorcier dans le petit espace disponible du modèle, les proportions de l'échiquier ont dû être réduites de moitié. En faisant ce compromis, il y avait aussi de la place pour ajouter la base d'une autre tour au modèle.

Recrear el conocido Ajedrez de los Magos en el poco espacio disponible en el modelo supuso dividir por la mitad las proporciones del tablero. Aceptar dicho compromiso dejó espacio también para la base de otra de las torres del modelo.

In the movie series, Professor Snape™ says that students in his Potions class were there to 'learn the subtle science and exact art of potion making'. Therefore, our version of the classroom had to be filled with all the equipment that witches and wizards would need, including multiple shelves of potions, classroom desks featuring small cauldrons and gold scripture detailing on the walls.

Dans la série de films, le professeur Rogue dit que les élèves fréquentent son cours de potions pour « apprendre la science subtile et l'art rigoureux de la préparation des potions ». Par conséquent, notre version de la salle de classe devait comprendre tout l'équipement dont les sorciers et magiciens auraient besoin, y compris les multiples étagères de potions, les pupitres dotés de petits chaudrons et l'écriture d'or ornant les murs.

En la saga cinematográfica, el Profesor Snape dice a los alumnos de su clase de Pociones que están allí para "aprender la sutil ciencia y el arte exacto de hacer pociones". Nuestra versión del aula, por tanto, tenía que contener todo lo que un mago o bruja pudiera necesitar: estantes de pociones, pupitres con pequeñas ollas y detalles que representarían inscripciones doradas en las paredes, entre otras cosas.

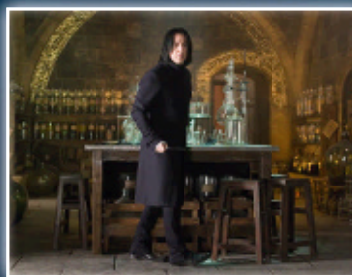

We hope fans enjoy building their Hogwarts™ moments and that these small details bring the model to life and help the story live on.

Nous espérons que les adeptes s'amuseront à construire leurs scènes préférées à Poudlard, et que ces petits détails donneront vie au modèle et aideront l'histoire à perdurer.

Esperamos que los fans disfruten construyendo sus propios momentos en Hogwarts™ y que estos pequeños detalles hagan cobrar vida al modelo y den continuidad a la historia.



The Four Founders

Hogwarts™ School of Witchcraft and Wizardry was founded by Godric Gryffindor, Helga Hufflepuff, Salazar Slytherin and Rowena Ravenclaw in the 10th Century. Each of the four founders then created their own house at the school. For many years, all was well amongst the founders. However, a rift appeared when Salazar Slytherin suggested that only pupils from 'pureblood', magical families were eligible to attend Hogwarts.

Godric Gryffindor

Godric valued courage and was known for his own bravery and skills as an accomplished dueler. Godric was the original owner of the Sorting Hat and also The Sword of Gryffindor that would present itself to any true Gryffindor™ in a moment of need.

Helga Hufflepuff

Helga strongly believed in justice and loyalty, values on which the Hufflepuff™ house stands. She was particularly gifted at food-related charms and was the talent behind many traditional Hogwarts recipes. Helga's portrait can be seen in the Hufflepuff common room, toasting her students with her golden cup that was passed down to her descendants for centuries.

Salazar Slytherin

Salazar was a highly talented wizard as one of the first recorded Parselmouths and an accomplished Legilimens. He was also a notorious champion of pureblood supremacy and his hostile nature to Muggle-borns created a great divide and led to his departure from the school. Before he left, he built a secret room inside the castle with a great statue of himself and a monster inside that only he could control.

Rowena Ravenclaw

Above all else, Rowena Ravenclaw valued intelligence and was regarded as one of the greatest witches of her age. Rowena also wore a diadem that was said to grant wisdom to the wearer. Legend has it that a broken heart contributed to her early demise. Her daughter Helena (the Grey Lady) became the Ravenclaw house ghost.

Les quatre fondateurs

L'école de sorcellerie et de magie Poudlard a été fondée par Godric Gryffondor, Helga Poufsouffle, Salazar Serpentard et Rowena Serdaigle au X^e siècle. Chacun des quatre fondateurs a ensuite créé sa propre maison à l'école. Pendant de nombreuses années, tout allait bien entre les fondateurs. Cependant, un désaccord est survenu lorsque Salazar Serpentard a suggéré que seuls les élèves de familles magiques de « sang pur » pouvaient fréquenter Poudlard.

Godric Gryffondor

Godric estimait le courage et était reconnu pour sa bravoure et ses compétences de duelliste accompli. Godric était le premier propriétaire du Choixpeau magique et de l'épée de Gryffondor, qui se révèle à tout vrai Gryffondor au moment où il en a besoin.

Helga Poufsouffle

Helga croyait fermement en la justice et la loyauté, valeurs sur lesquelles repose la maison Poufsouffle. Elle était particulièrement douée pour les sortilèges culinaires et a créé de nombreuses recettes traditionnelles de Poudlard. Dans la salle commune de Poufsouffle, on peut voir un portrait de Helga portant un toast à ses élèves avec sa coupe d'or transmise de génération en génération depuis des siècles.

Salazar Serpentard

Salazar était un magicien très talentueux, l'une des premières personnes recensées à parler le fourchelang et un Legilimens accompli. Il a également été un célèbre défenseur de la suprématie des sang-purs. Sa nature hostile aux né-Moldus a créé une grande fracture et a entraîné son départ de l'école. Avant de partir, il a construit une pièce secrète à l'intérieur du château avec une grande statue de lui-même et un monstre à l'intérieur que lui seul pouvait contrôler.

Rowena Serdaigle

Par-dessus tout, Rowena Serdaigle valorisait l'intelligence et était considérée comme l'une des plus grandes sorcières de son époque. Rowena portait un diadème qui, croyait-on, accordait la sagesse à la personne qui le portait. Selon la légende, un cœur brisé aurait contribué à sa disparition prématurée. Sa fille Helena (la Dame Grise) devint le fantôme de la maison Serdaigle.

Los Cuatro Fundadores

El Colegio Hogwarts™ de Magia y Hechicería fue fundado por Godric Gryffindor, Helga Hufflepuff, Salazar Slytherin y Rowena Ravenclaw en el siglo X. Cada uno de los Cuatro Fundadores creó después su propia casa dentro del colegio. Durante muchos años, todo fue bien entre ellos. Sin embargo, las rencillas hicieron su aparición cuando Salazar Slytherin sugirió que sólo pudieran asistir a Hogwarts alumnos de "sangre pura" y familias mágicas.

Godric Gryffindor

Godric valoraba el coraje y era conocido por su gran valentía y su habilidad en los duelos de magos. Fue el propietario original del Sombrero Seleccionador y también de la Espada de Gryffindor, que se presenta por decisión propia ante los verdaderos miembros de Gryffindor™ en caso de necesidad.

Helga Hufflepuff

Helga creía fervientemente en la justicia y la lealtad, valores fundamentales de la casa Hufflepuff™. Tenía un don especial para los encantamientos relacionados con la cocina y de ella proceden muchas de las recetas tradicionales de Hogwarts. El retrato de Helga está colgado en la sala común de Hufflepuff, donde brinda por sus estudiantes con una copa dorada que sus descendientes han heredado durante siglos.

Salazar Slytherin

Salazar fue un mago de gran talento; uno de los primeros hablantes de Pársel conocidos y un experto Legilimante. También fue el más notorio representante de la supremacía de los magos de sangre pura y su hostilidad hacia los nacidos de Muggles dio lugar a una gran división que acabó con su salida del colegio. Antes de irse, no obstante, construyó una cámara secreta dentro del castillo con una gran estatua de sí mismo y un monstruo adentro que sólo él podía controlar.

Rowena Ravenclaw

Rowena Ravenclaw valoraba la inteligencia por encima de todo y fue una de las brujas más extraordinarias de su época. También llevaba una diadema que, según se dice, concedía el don de la sabiduría a quien la portara. Cuenta la leyenda que un desengaño amoroso fue el principal motivo de su temprano fallecimiento. Su hija Helena (la Dama Gris) se convirtió en el fantasma de la casa Ravenclaw.



Microfigurines

Harry Potter™, Ron Weasley™, Hermione Granger™, Draco Malfoy™, Albus Dumbledore™, Professor McGonagall™, Severus Snape™, Remus Lupin, Professor Dolores Umbridge™, Argus Filch, Gryffindor students, Hufflepuff students, Slytherin students, Ravenclaw students, Lord Voldemort™, Bellatrix Lestrange, Chess pieces, Statue of the Hogwarts Architect, Dementors.

Microfigurines

Harry Potter™, Ron Weasley™, Hermione Granger™, Drago Malefoy™, Albus Dumbledore™, Professeur McGonagall™, Severus Rogue, Remus Lupin, professeur Dolores Ombrage, Argus Rusard, des élèves de Gryffondor, des élèves de Poufsouffle, des élèves de Serpentard, des élèves de Serdaigle, Lord Voldemort™, Bellatrix Lestrange, des pièces d'échecs, une statue de l'architecte de Poudlard et des Détraqueurs.

Microfigurinas

Harry Potter™, Ron Weasley™, Hermione Granger™, Draco Malfoy™, Albus Dumbledore™, Profesora McGonagall, Severus Snape™, Remus Lupin, Profesora Dolores Umbridge, Argus Filch, alumnos de Gryffindor, alumnos de Hufflepuff, alumnos de Slytherin, alumnos de Ravenclaw, Lord Voldemort™, Bellatrix Lestrange, piezas de ajedrez, estatua del arquitecto de Hogwarts y Dementores.

About the LEGO® Design Team

The project team for this model consisted of Model Designers, Graphic Designers, Element Designers, the Marketing Team, Building Instructions Developers, a Model Coach (who assessed if the model was designed correctly) and a Design Lead (who has the overview of the full project), among others.

From left to right/top-down:

Charlotte Fey - Project Manager

Hélène Desprets - Marketing Manager

Pia Elisabeth Jungdal - Master Data Specialist

Susan Due - Building Instruction Specialist

Connie Bork - Model Coach

Joel Baker - Concept Designer

Justin Ramsden – Model Designer

Andrew Hugh Seenan - Design Manager

Michael Vibede Vanting

- Senior Marketing Manager

Crystal Marie Fontan - Graphic Designer



Justin Ramsden – LEGO® Model Designer:

“It has been a few years since the last LEGO® Hogwarts™ Castle was released. Even at its microscale, this is the eighth and largest Hogwarts Castle LEGO model to date. Another LEGO designer, Joel Baker designed a sketch model of the castle, so this was the starting point. I took over with the challenge of making that sketch into a model for fans. My design approach focused on capturing the essence of Hogwarts; its iconic silhouette, the exciting feeling of going back to school and starting a new adventure. I wanted to recreate all the iconic locations from the castle and moments from the movie series in ‘micro-detail’, including the moving staircases, the Whomping Willow™, Professor Lupin’s Boggart lesson in the Defense Against the Dark Arts classroom and the Basilisk encounter in the Chamber of Secrets.



For this model, we also managed to develop three new LEGO building elements that helped to further capture the fantastic architectural detail of Hogwarts. I was very excited to include these two new window arch elements and a half cone piece into the model, as I am not only very eager to see how the fans will use the elements in new and exciting ways, but I can’t wait to see the new building opportunities that they bring to the LEGO building system.

As a LEGO® model designer, you can either work digitally or just get on your hands and knees and start building! The latter is how I approach it, making iteration after iteration until I get to the final product. During the design process, I tend to keep as many of the previous sketches of the castle as I can, so that I can see the physical progression from concept to finished model. Many of these sketch models have very unusual color schemes, as I tend to use interesting colors when I build with whatever bricks are closest to hand!

One detail that LEGO fans may not notice is that the piece count of the Hogwarts™ Castle is 6,020 elements. This is personally significant for me because it is the set number of a classic LEGO Castle model that I had when I was five years old - a small model that co-incidentally featured a wizard. It was this set, among others, which inspired me to become a LEGO designer.

Furthermore, as 2018 is the 60th anniversary of the LEGO brick, I hid the iconic 2x4 red brick in as many places as I could.”



Crystal Marie Fontan – LEGO Graphic Designer:

“I worked closely with Justin and fellow LEGO Graphic Designer Djordje Djordjevic (with support from other graphic designers), in creating all the characters for the model, as well as the stickers and decorated elements.

Generally, with the stickers for models, less is more. Stickers are also important to bring in that layer of magic and storytelling from the Harry Potter™ series. For example, small details such as depicting the door to the Room of Requirement or the keys in the flying key room can only be achieved via stickers at this scale. Stickers are also where all the magical secrets get embedded in the model!

This was a great project to work on because I am such a big fan of the Harry Potter series; it’s like working in a magical universe. I really want other fans to enjoy the models, stickers and decorations that we have created for them!”



À propos de l'équipe de conception LEGO®

L'équipe de projet de ce modèle se composait, entre autres, de concepteurs de modèles, de graphistes, de concepteurs d'éléments, de l'équipe de marketing, de créateurs d'instructions de montage, d'une responsable de modèles (qui évalue si le modèle est conçu correctement) et d'un concepteur en chef (qui supervise l'ensemble du projet).

De gauche à droite/de haut en bas :

Charlotte Fey, chef de projet

Hélène Desprets, responsable du marketing

Pia Elisabeth Jungdal, spécialiste des données de référence

Susan Due, spécialiste des instructions de montage

Connie Bork, responsable de modèles

Joel Baker, concepteur

Justin Ramsden, concepteur de modèles

Andrew Hugh Seenan, responsable de la conception

Michael Vibede Vanting, responsable principal du marketing



Justin Ramsden, concepteur de modèles LEGO® :

« Plusieurs années se sont écoulées depuis la mise en marché du dernier château de Poudlard LEGO®. Même à sa microéchelle, c'est le huitième et le plus grand modèle de château de Poudlard LEGO à ce jour. Un autre concepteur de LEGO, Joel Baker, a dessiné le croquis du modèle du château, qui a servi de point de départ. J'ai pris le flambeau avec la mission de transformer ce croquis en modèle pour les fans. Mon approche de conception s'est concentrée à saisir l'essence de Poudlard; sa silhouette emblématique, la fébrilité de retourner à l'école et de commencer une nouvelle aventure. Je voulais recréer tous les endroits caractéristiques du château et certains moments de la série de films en « microdétails », dont les escaliers en mouvement, le Saule cogneur, la leçon sur les épouvantards dans le cours de défense contre les forces du Mal du professeur Lupin et la rencontre avec le Basilic dans la Chambre des secrets.



Pour ce modèle, nous avons également réussi à créer trois nouveaux éléments de construction LEGO qui ont contribué à mieux reproduire les fantastiques détails architecturaux de Poudlard. J'étais très content d'ajouter ces deux nouveaux éléments de voûte aux fenêtres et un morceau de demi-cône au modèle. Je suis non seulement très impatient de voir comment les adeptes les utiliseront de nouvelles façons amusantes, mais j'ai aussi hâte de voir les nouvelles possibilités de construction qu'ils apporteront au système de construction de LEGO.

Un concepteur de modèles LEGO® a le choix de travailler de façon numérique ou de simplement se mettre à quatre pattes et de commencer à construire ! J'ai choisi la deuxième option, en multipliant les itérations jusqu'au produit final. Pendant le processus de conception, j'ai essayé de garder autant de croquis des versions précédentes du château que possible, de façon à voir la progression physique du concept jusqu'au modèle achevé. Beaucoup de ces croquis ont des palettes de couleurs très inhabituelles, puisque j'ai tendance à utiliser des couleurs intéressantes quand je construis avec les briques qui sont à portée de la main !

Un fait que les fans de LEGO ne remarqueront peut-être pas, c'est que le château de Poudlard compte 6 020 pièces. Ce chiffre est significatif pour moi parce que c'est le numéro d'ensemble d'un modèle classique de château LEGO que je possédais quand j'avais cinq ans; un petit modèle qui, incidemment, comportait un magicien. C'est cet ensemble, et quelques autres, qui m'a inspiré à devenir un concepteur LEGO.

De plus, comme 2018 marque le 60^e anniversaire de la brique LEGO, j'ai caché l'emblématique brique rouge 2x4 à autant d'endroits que je le pouvais. »



Crystal Marie Fontan, graphiste LEGO :

« J'ai travaillé en étroite collaboration avec Justin et son collègue graphiste LEGO Djordje Djordjevic (avec le soutien d'autres graphistes) pour créer tous les personnages du modèle, ainsi que les autocollants et les éléments décorés.

Généralement, il est préférable de mettre le moins d'autocollants possible sur les modèles. Les autocollants servent également à apporter la touche de magie et de narration de la série Harry Potter™. Par exemple, à cette échelle, seuls les autocollants peuvent bien représenter de petits détails, comme la porte de la Salle sur demande ou les clés de la salle des clés volantes. C'est aussi avec les autocollants que tous les secrets magiques s'intègrent dans le modèle !

Contribuer à ce projet était fantastique puisque je suis passionnée par la série Harry Potter; c'est comme travailler dans un univers magique. J'espère vraiment que d'autres adeptes aimeront les modèles, les autocollants et les décorations que nous avons créés pour eux ! »



Acerca del equipo de diseño de LEGO®

El equipo del proyecto que dio lugar a este modelo se compuso de diseñadores de modelos, diseñadores gráficos, diseñadores de elementos, miembros del equipo de mercadotecnia, desarrolladores de instrucciones de construcción, un orientador de modelos (responsable de evaluar si un modelo se está diseñando correctamente) y un jefe de diseño (que supervisa el proyecto completo), entre otros.

De izquierda a derecha y de arriba abajo:
Charlotte Fey, jefa del proyecto
Hélène Desprets, jefa de mercadotecnia
Pia Elisabeth Jungdal, experta en datos maestros
Susan Due, experta en instrucciones de construcción
Connie Bork, orientadora de modelos
Joel Baker, diseñador de prototipos
Justin Ramsden, diseñador de modelos
Andrew Hugh Seenan, jefe de diseño
Michael Vibede Vanting, jefe sénior de mercadotecnia
Crystal Marie Fontan, diseñadora gráfica



Justin Ramsden, diseñador de modelos LEGO®:

“Han pasado unos cuantos años desde que pusimos a la venta el último Castillo de Hogwarts™ LEGO®. Incluso tratándose de un modelo a microescala, este es el octavo y más grande set LEGO basado en el Castillo de Hogwarts hasta la fecha. Otro diseñador de LEGO, Joel Baker, diseñó un modelo preliminar del castillo que me sirvió como punto de partida. A partir de ahí, mi tarea consistió en afrontar el desafío de convertir ese modelo preliminar en un modelo para fanáticos. Mi idea al plantear el diseño era capturar la esencia de Hogwarts: su inconfundible silueta, la emocionante sensación de volver al colegio y el inicio de una nueva aventura. Quería recrear los lugares más conocidos del castillo y los mejores momentos de la saga cinematográfica al ‘microdetalle’, sin olvidar las escaleras móviles, el Sauce Boxeador, la lección sobre los Boggarts del Profesor Lupin en el aula de Defensa contra las Artes



Oscuras y el encuentro con el Basilisco en la Cámara de los Secretos.

Para este modelo, también desarrollamos tres nuevos elementos de construcción LEGO que nos permitieron capturar mejor los fantásticos detalles arquitectónicos de Hogwarts. Me entusiasmé cuando supe que incluiríamos las dos nuevas ventanas en arco y el semicírculo en el modelo. Ya quiero ver cómo usan los fans esos elementos de nuevas y sorprendentes maneras; además, estoy seguro de que aportarán nuevas oportunidades de construcción al sistema LEGO en general.

Cuando eres diseñador de modelos LEGO®, puedes trabajar digitalmente, ¡o sentarte en el suelo y ponerte a construir! El segundo es mi método preferido; construyo el modelo una y otra vez hasta que llego al producto final. Quise conservar el máximo número posible de modelos preliminares del castillo para poder contemplar su evolución física a lo largo del proceso de diseño desde el prototipo hasta la versión final. Muchos de esos modelos preliminares usan combinaciones de colores muy poco comunes porque prefiero construir con colores interesantes, ¡y siempre recorro a los bricks que tengo más a la mano!

Un detalle en el que quizá no se fijen los fans de LEGO es que el set Castillo de Hogwarts™ contiene 6.020 elementos. Es un número muy importante para mí porque coincide con la referencia de un clásico set LEGO Castle que tuve cuando tenía cinco años: un pequeño modelo que, casualmente, incluía un mago. Fue ese set, entre otros, el que me animó a convertirme en diseñador de LEGO.

Además, como el brick LEGO cumple 60 años en 2018, escondí el inconfundible brick rojo 2x4 en tantos lugares como pude”.



Crystal Marie Fontan, diseñadora gráfica de LEGO:

“Trabajé hombro con hombro con Justin y Djordje Djordjevic, otro diseñador gráfico de LEGO, además de otros diseñadores gráficos de los que recibí apoyo, en la creación de todos los personajes del modelo, así como en las calcomanías y los elementos decorados.

Por lo general, en lo que respecta a las calcomanías para modelos, menos es más. Fueron muy importantes para crear esa capa de magia y representar las características narrativas de la saga de Harry Potter™. Por ejemplo, detalles tan pequeños como los que decoran la puerta de la Sala de los Requerimientos o las llaves de la sala de las llaves voladoras sólo se pueden lograr a esta escala usando calcomanías. ¡En las calcomanías residen también muchos de los secretos mágicos del modelo!

Me encantó trabajar en este proyecto porque soy una gran fan de la saga de Harry Potter; fue como sumergirme en un universo mágico. ¡Espero que los fans disfruten mucho de los modelos, las calcomanías y las decoraciones que creamos para ellos!”.





Godric Gryffindor
Godric Gryffondor

Helga Hufflepuff
Helga Poufsouffle

Salazar Slytherin
Salazar Serpentard

Rowena Ravenclaw
Rowena Serdaigle



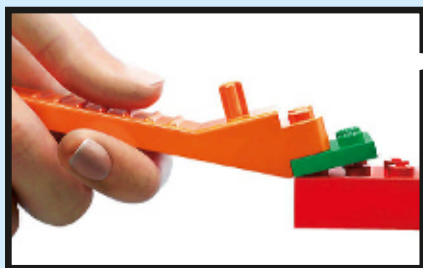
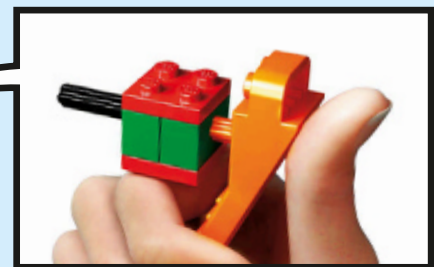
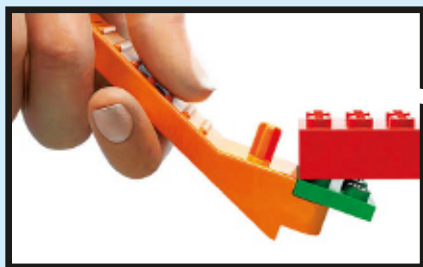
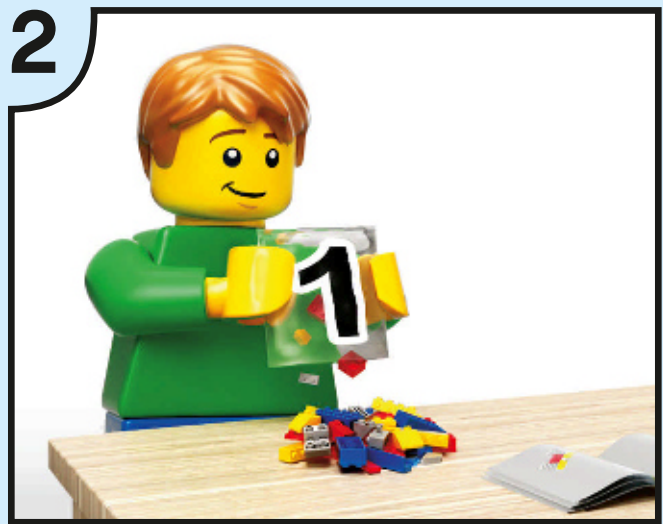

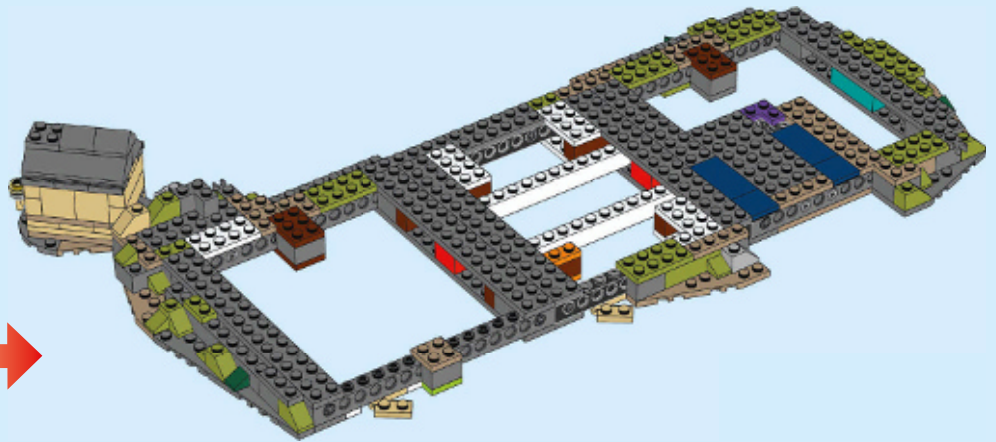
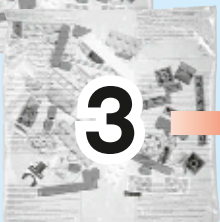
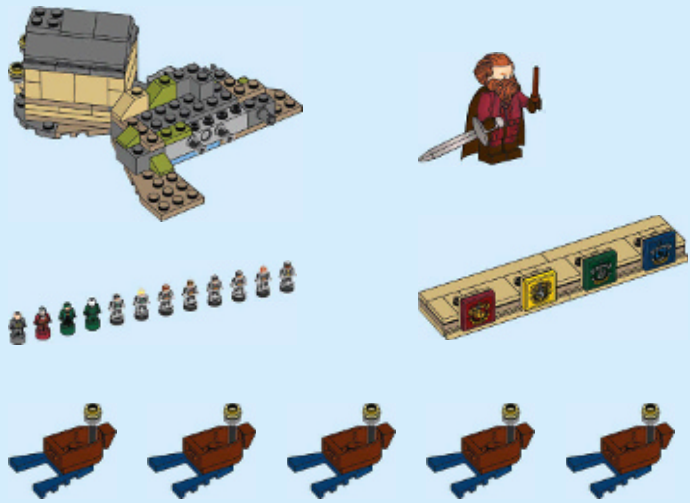

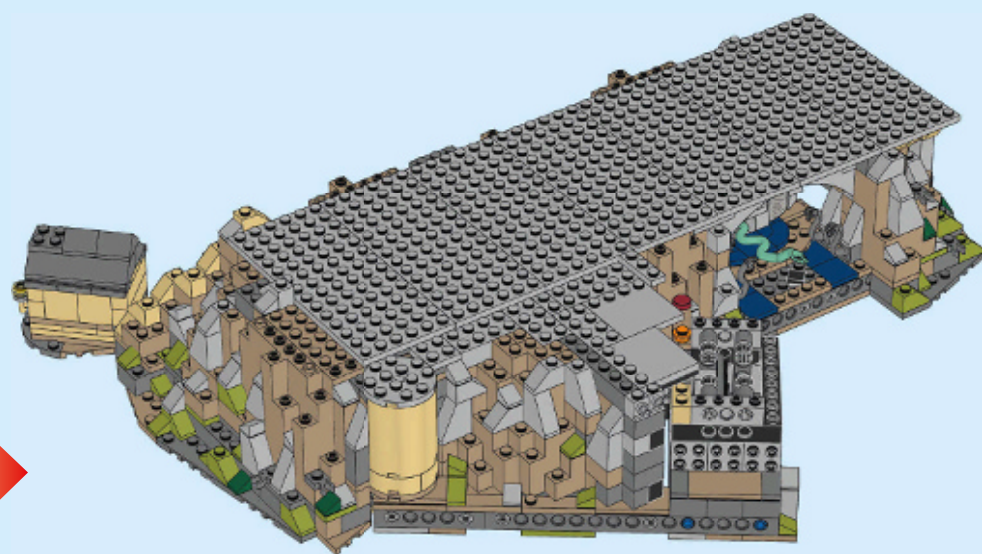
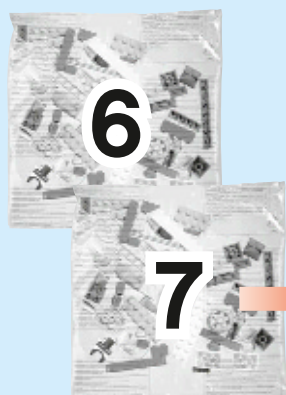
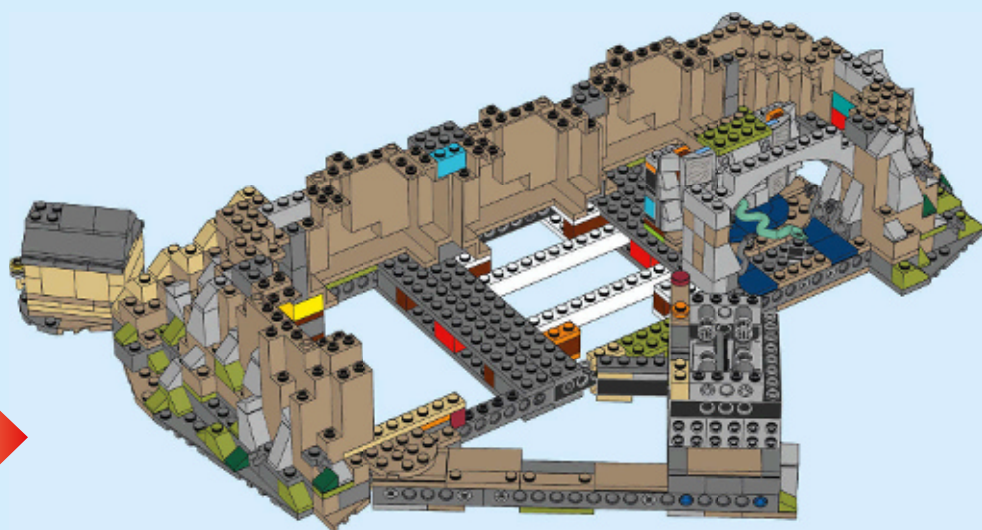

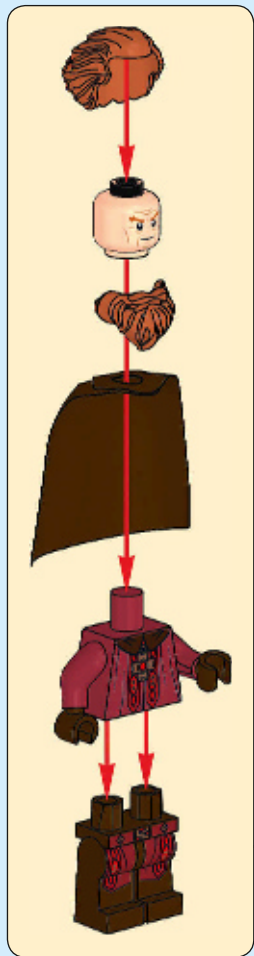
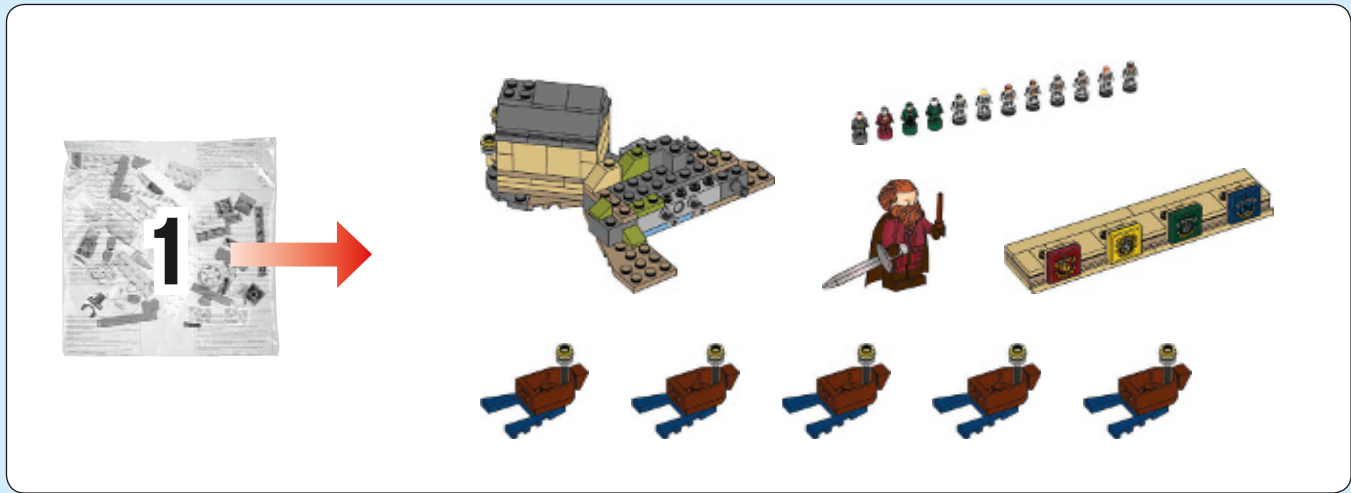

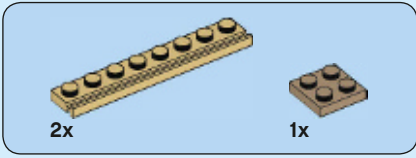
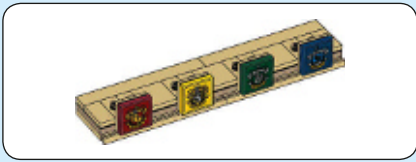

1

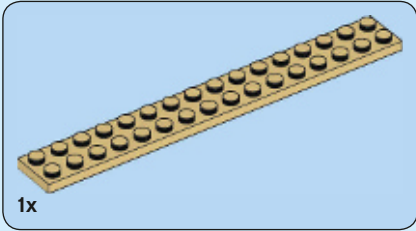
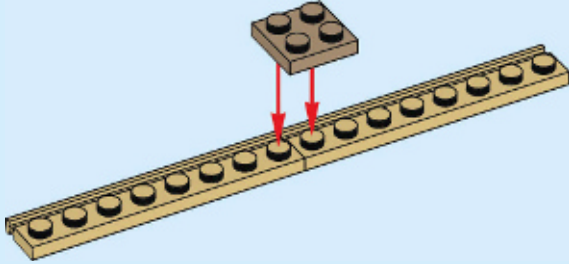

2

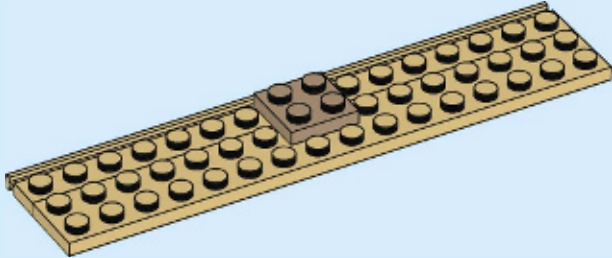

3

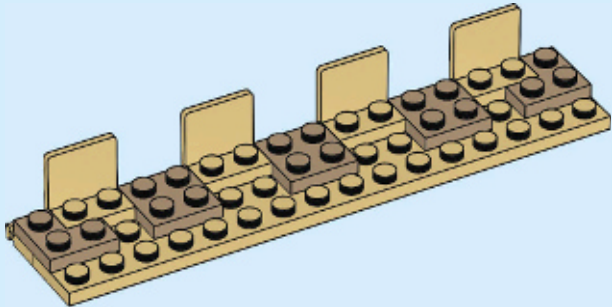



4

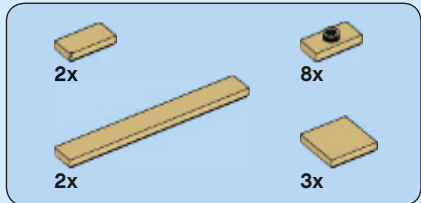
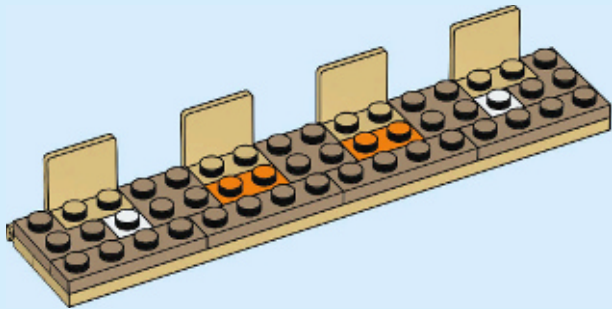

5

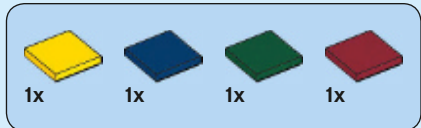
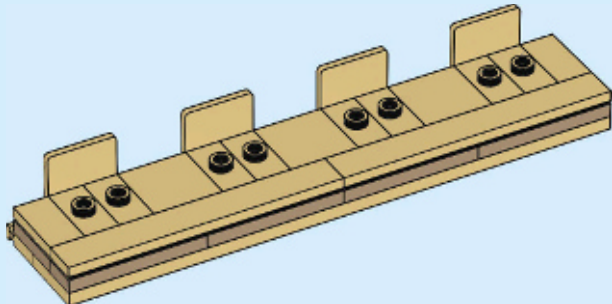

6

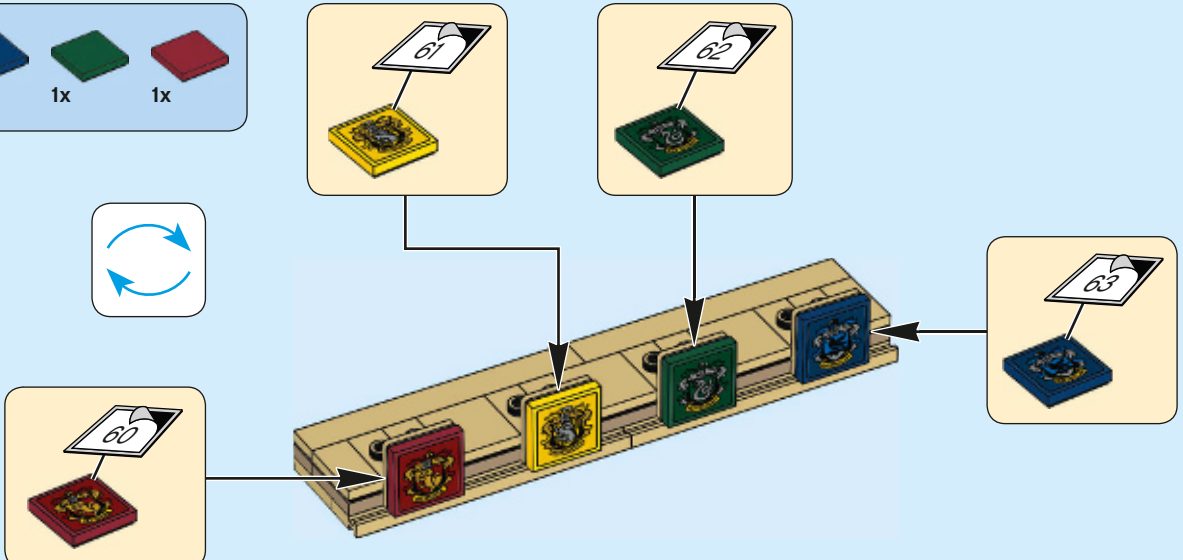

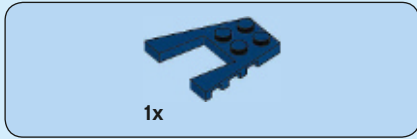

1

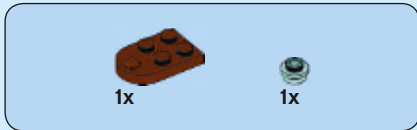

2

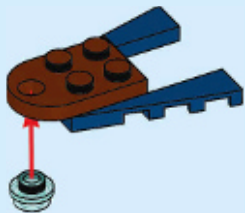

3

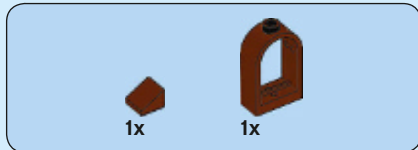
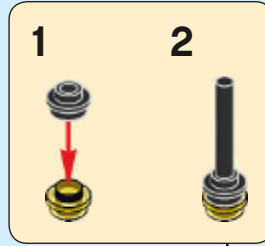

4

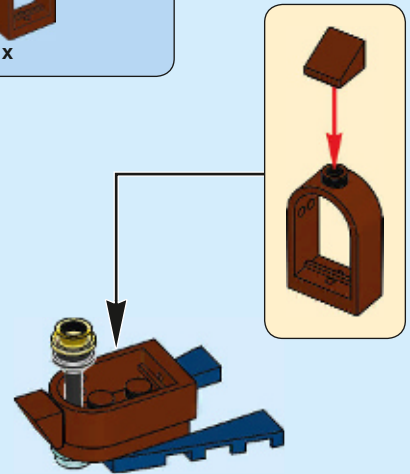

5x

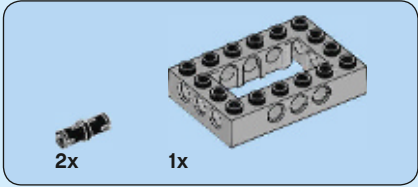
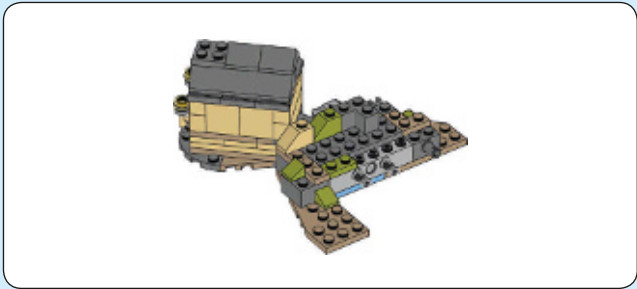

1

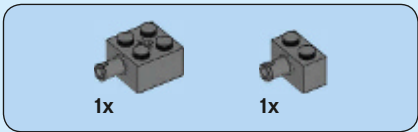
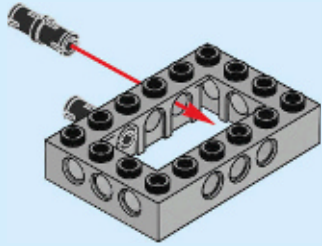

2

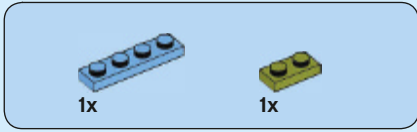
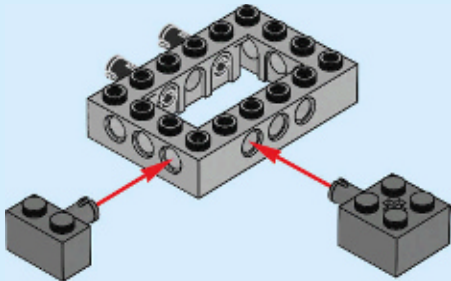

3

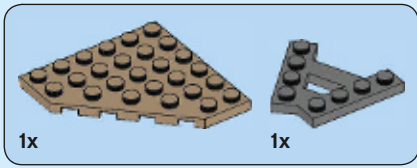
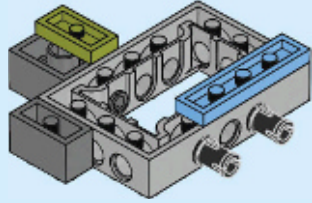
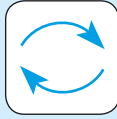

4

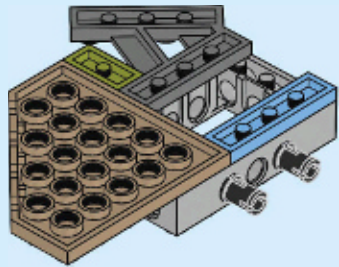



5

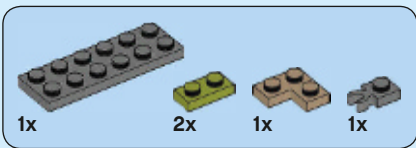
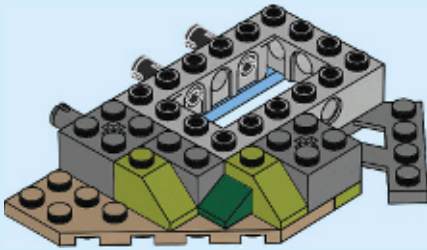

6

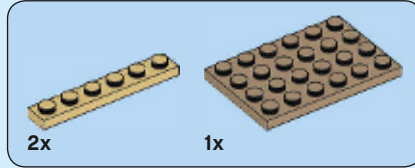
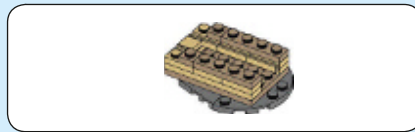
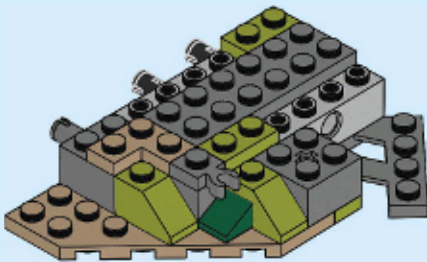

7

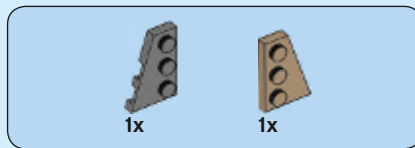
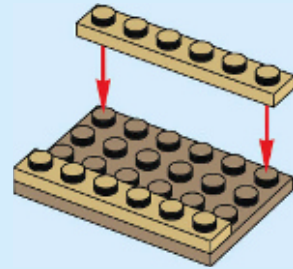

8

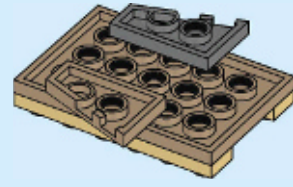
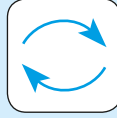

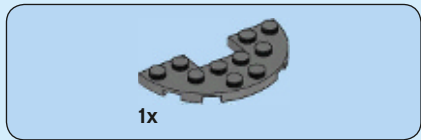

9

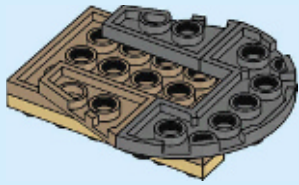

11

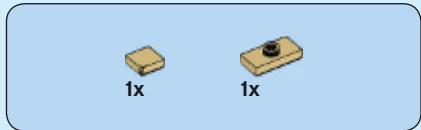
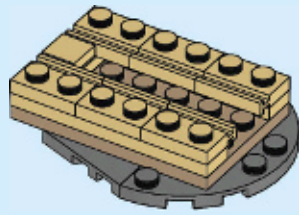

10

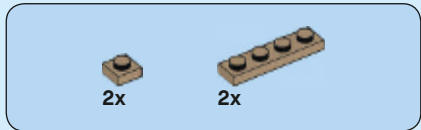
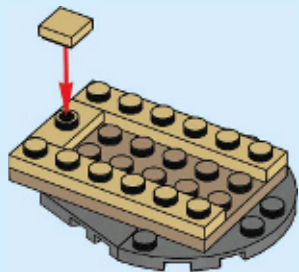
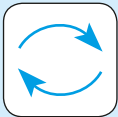

12

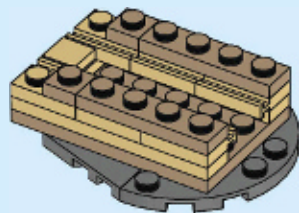

13

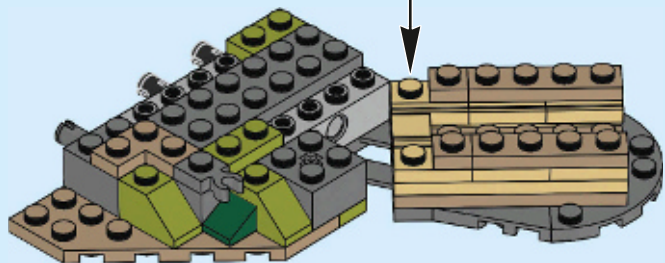

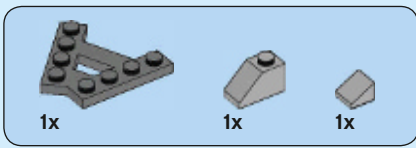

14

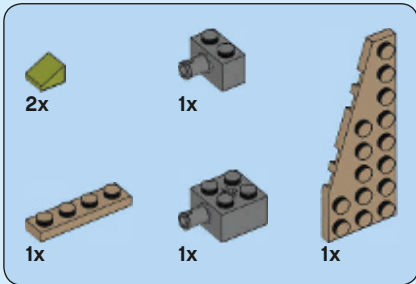
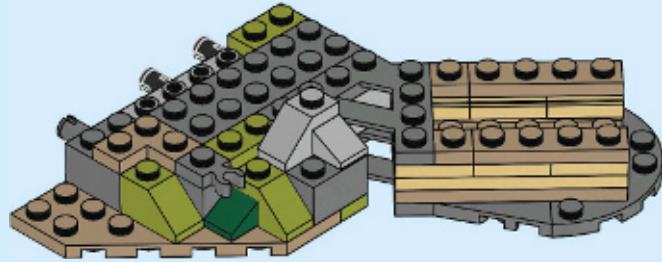

15

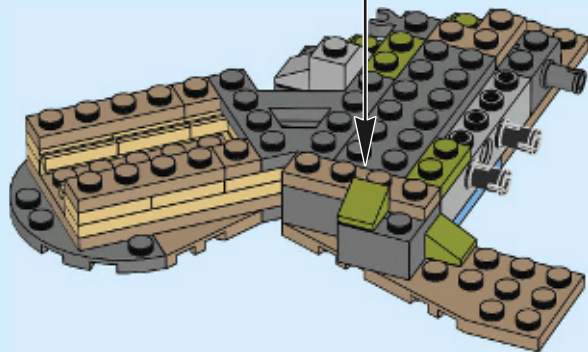
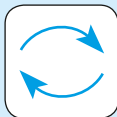
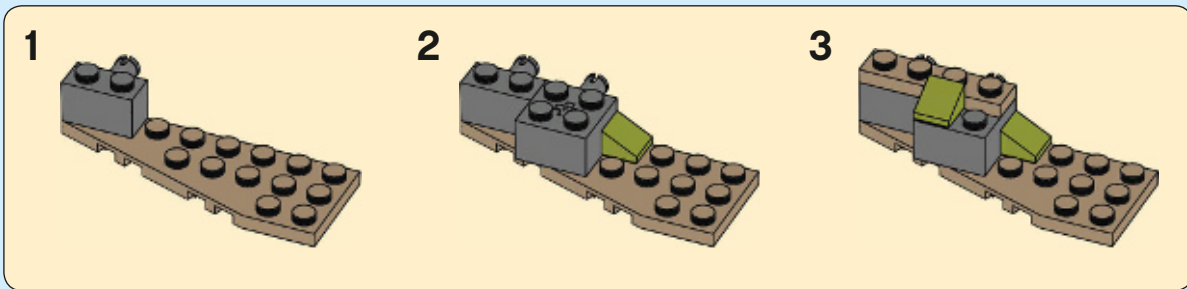

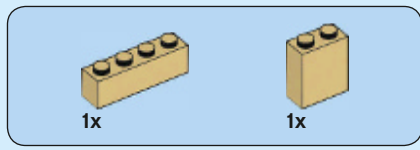

16

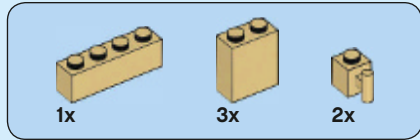
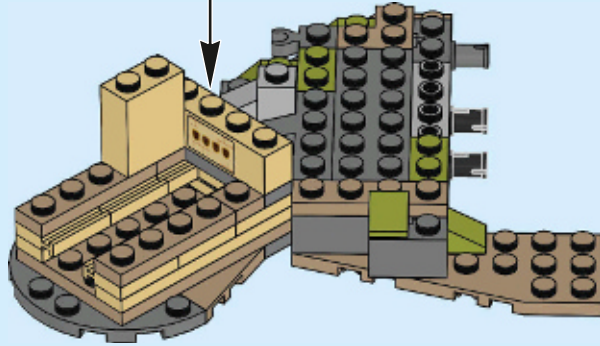
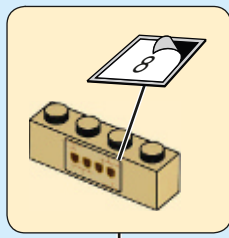

17

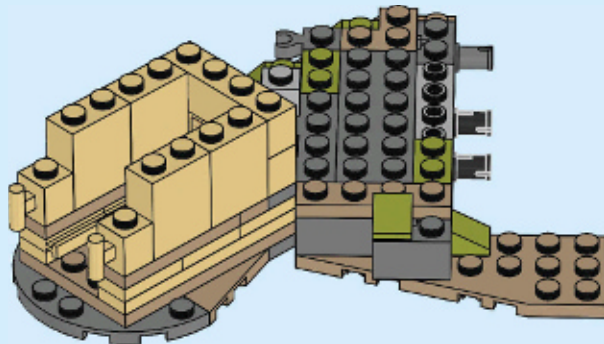

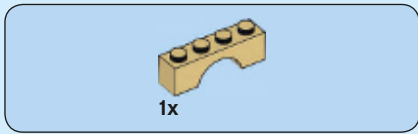

18

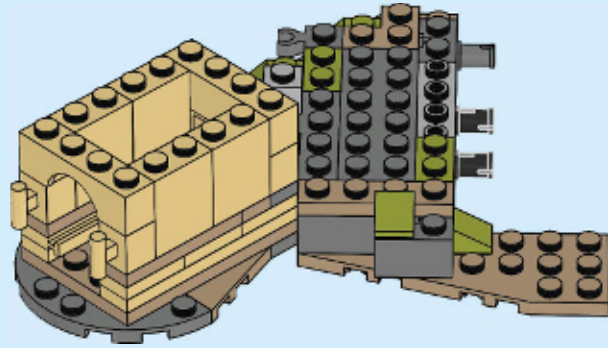

19

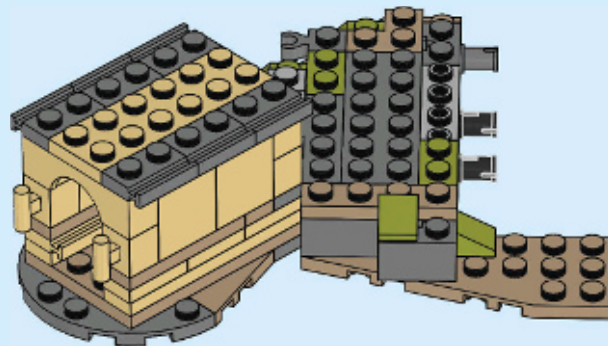

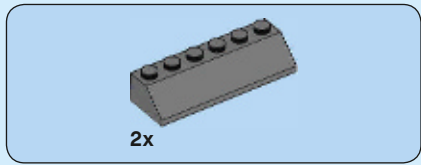

20

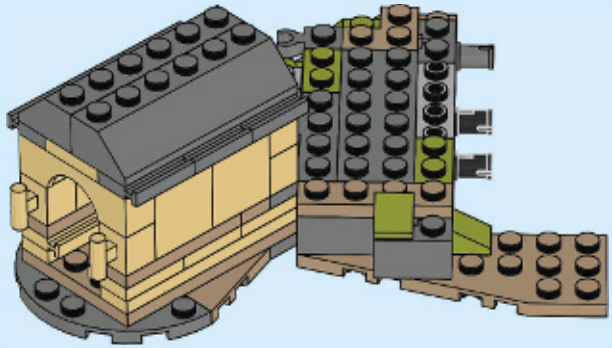

21

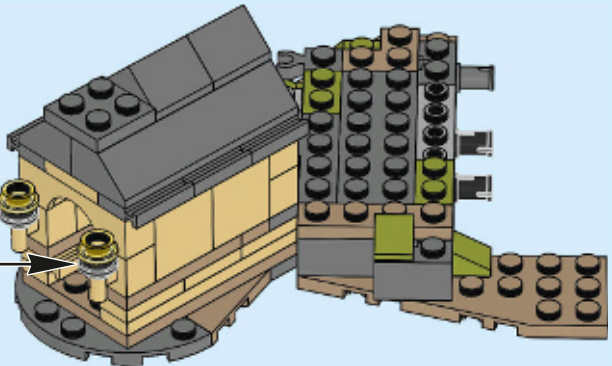
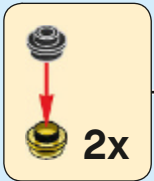

22

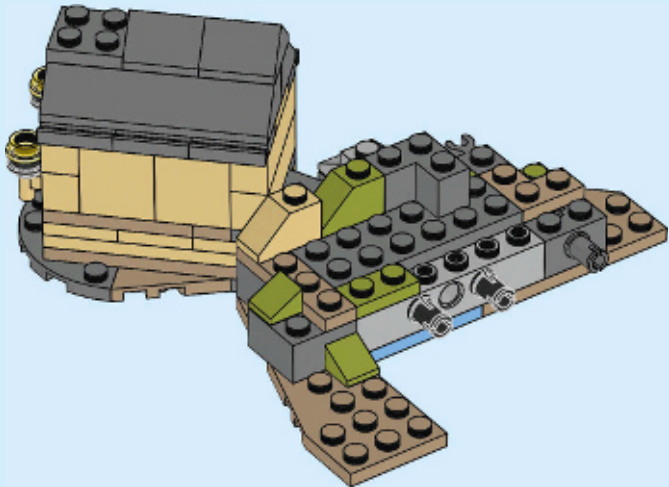

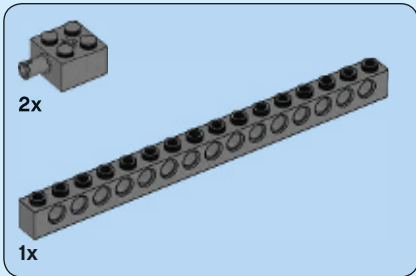
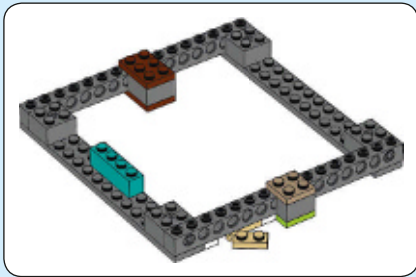
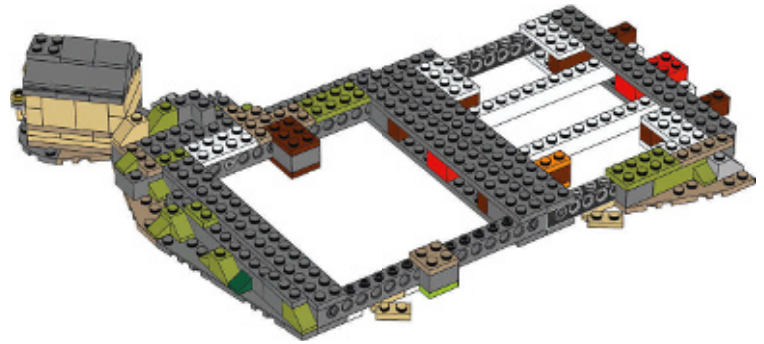

23

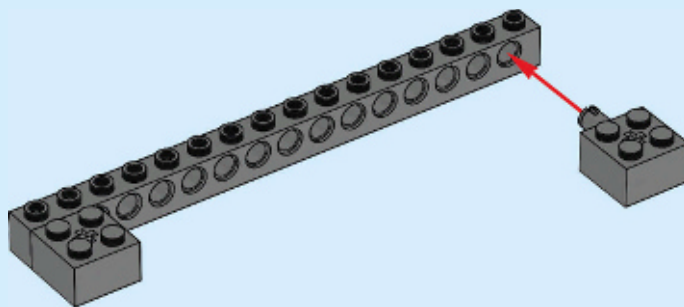

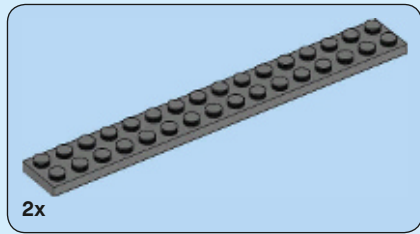

2x

24

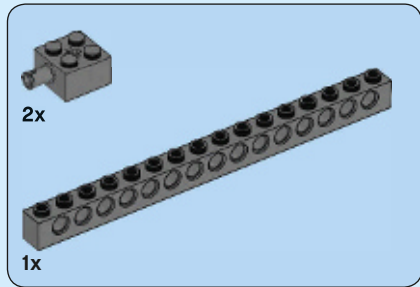
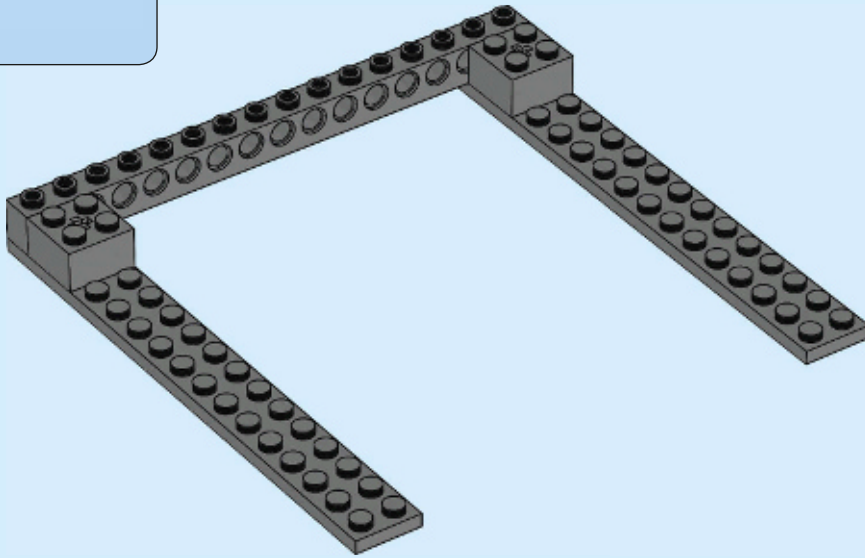

2x

1x

25

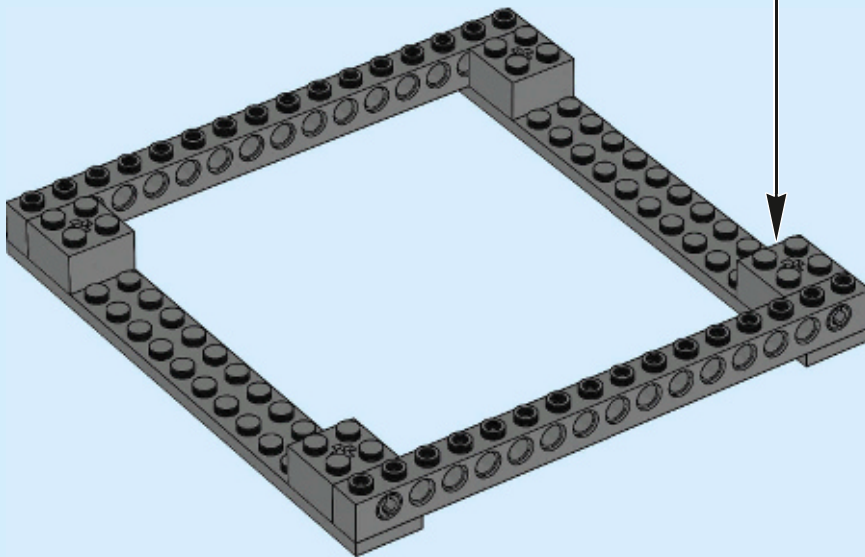
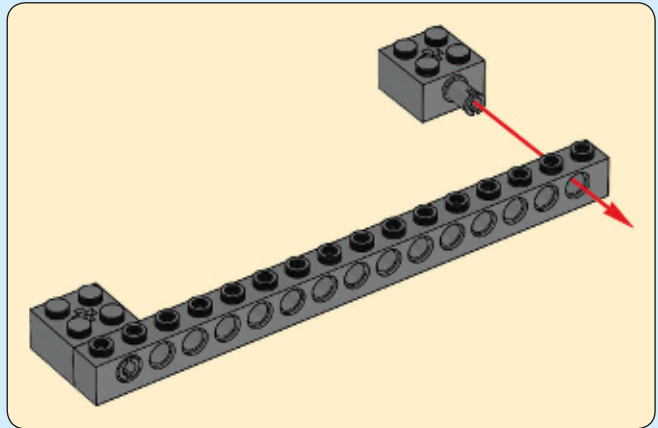

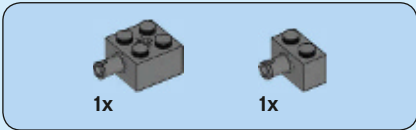

26

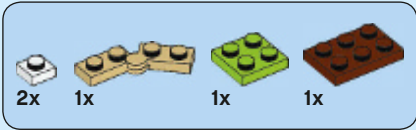
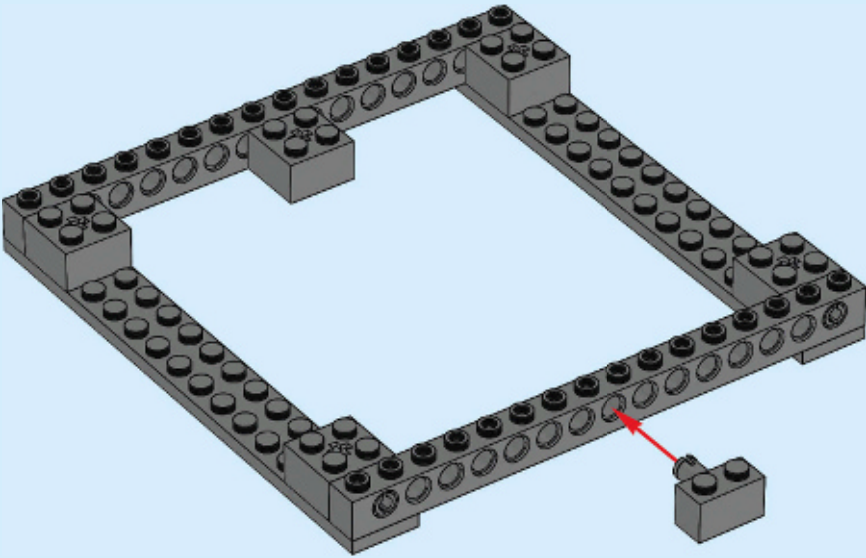

27

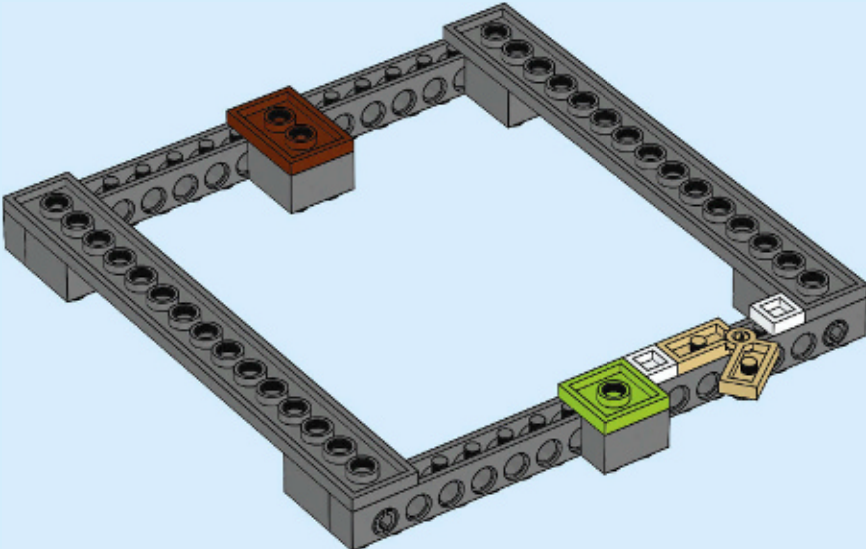
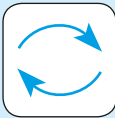

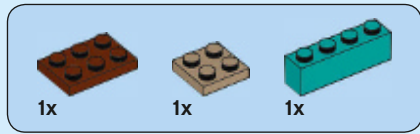

28

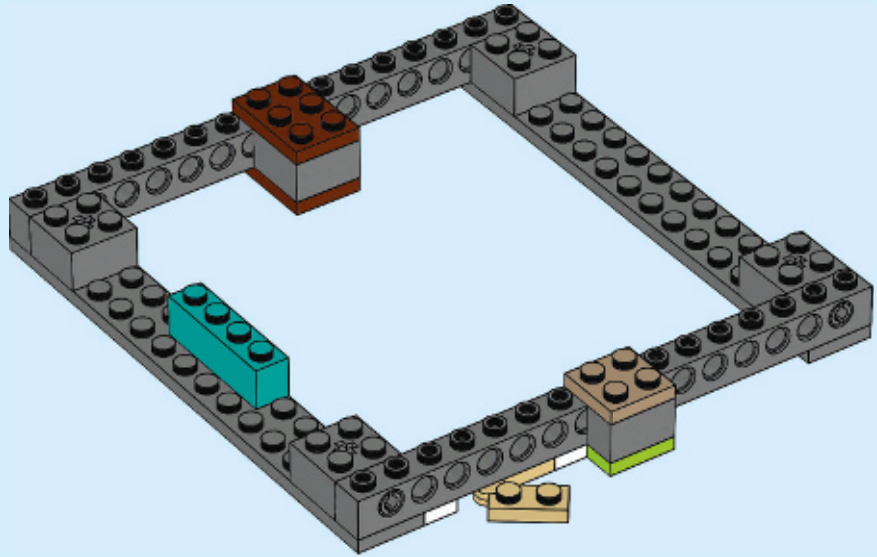
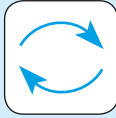

29

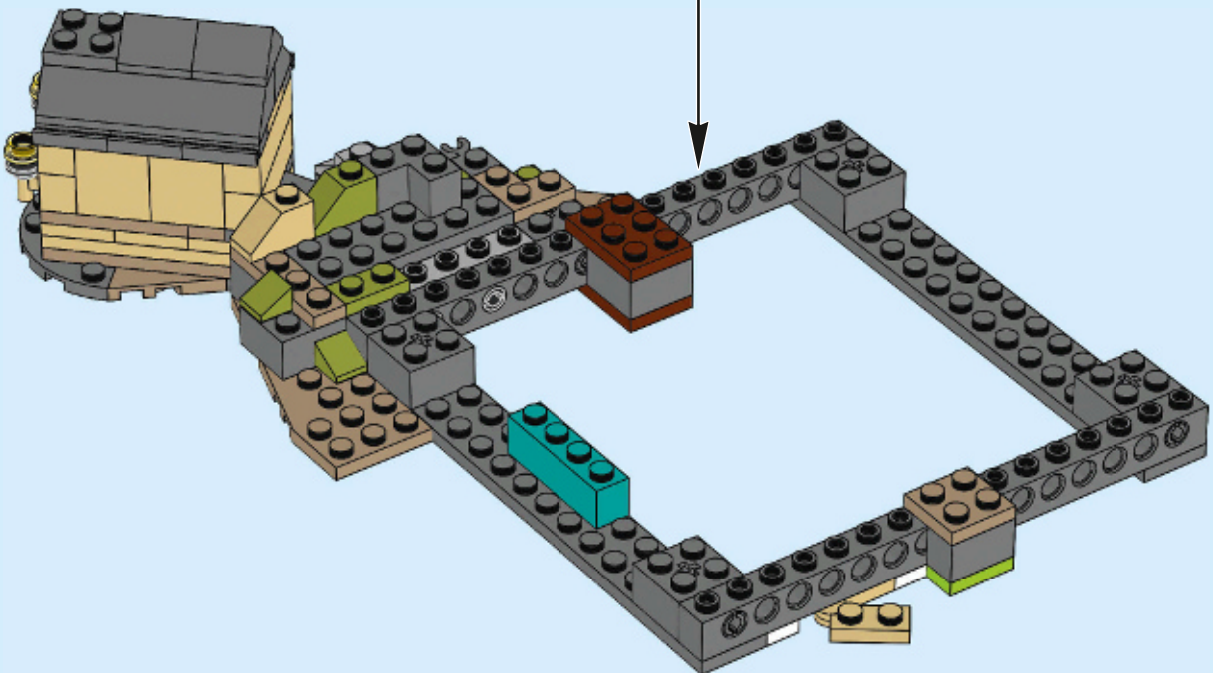



30

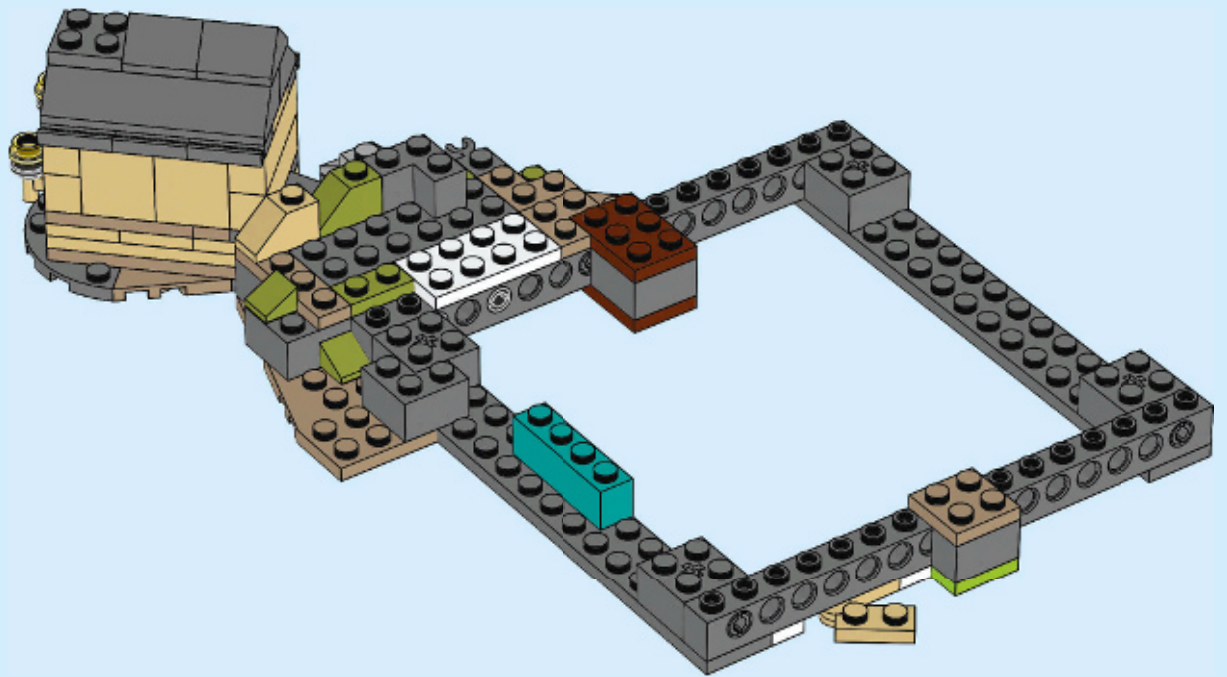

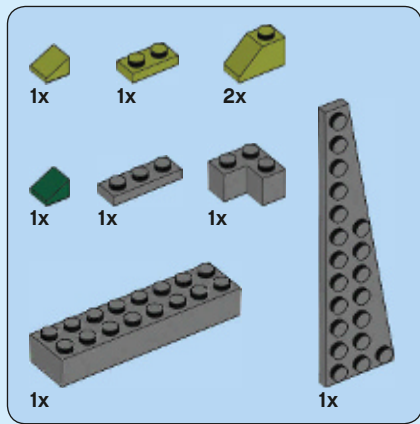

31

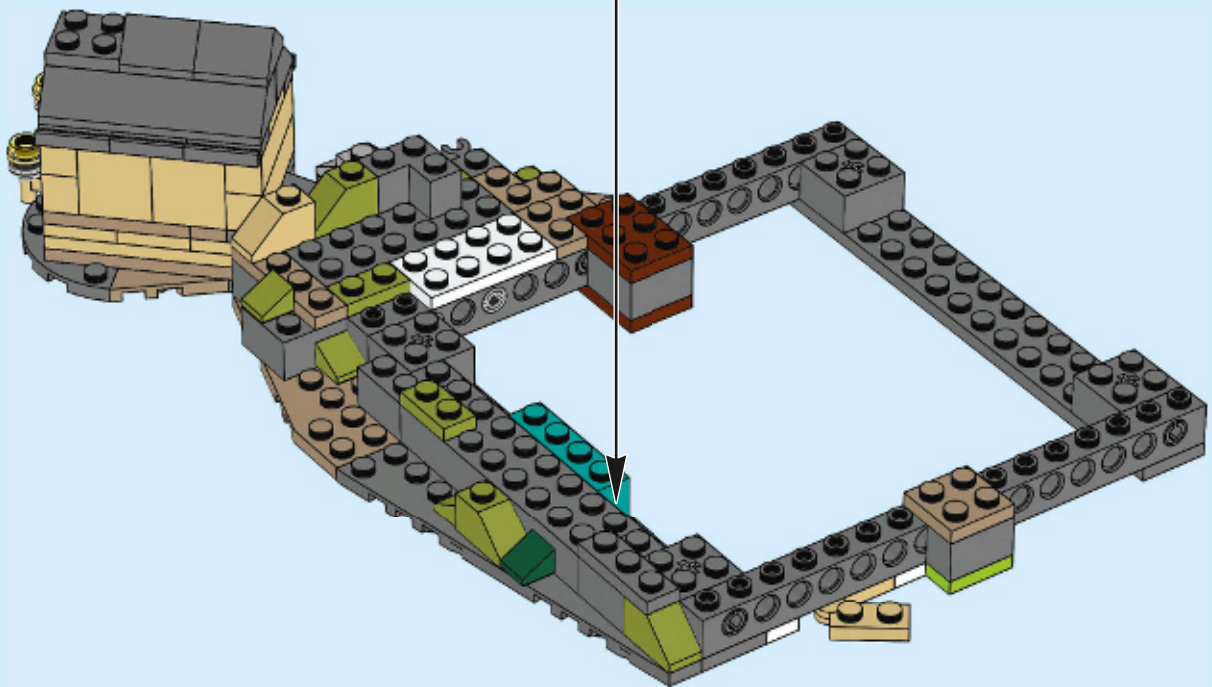
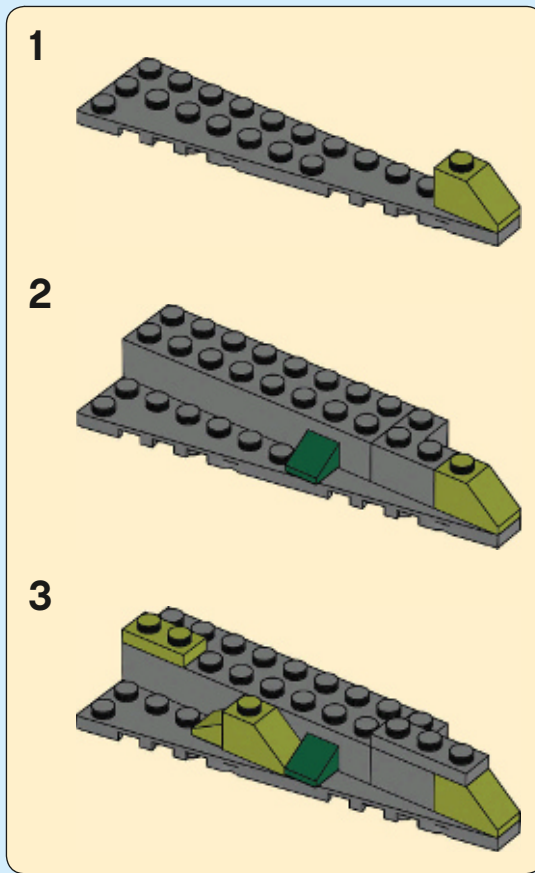

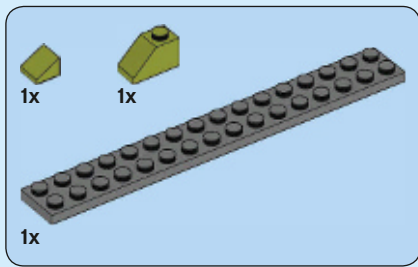

32

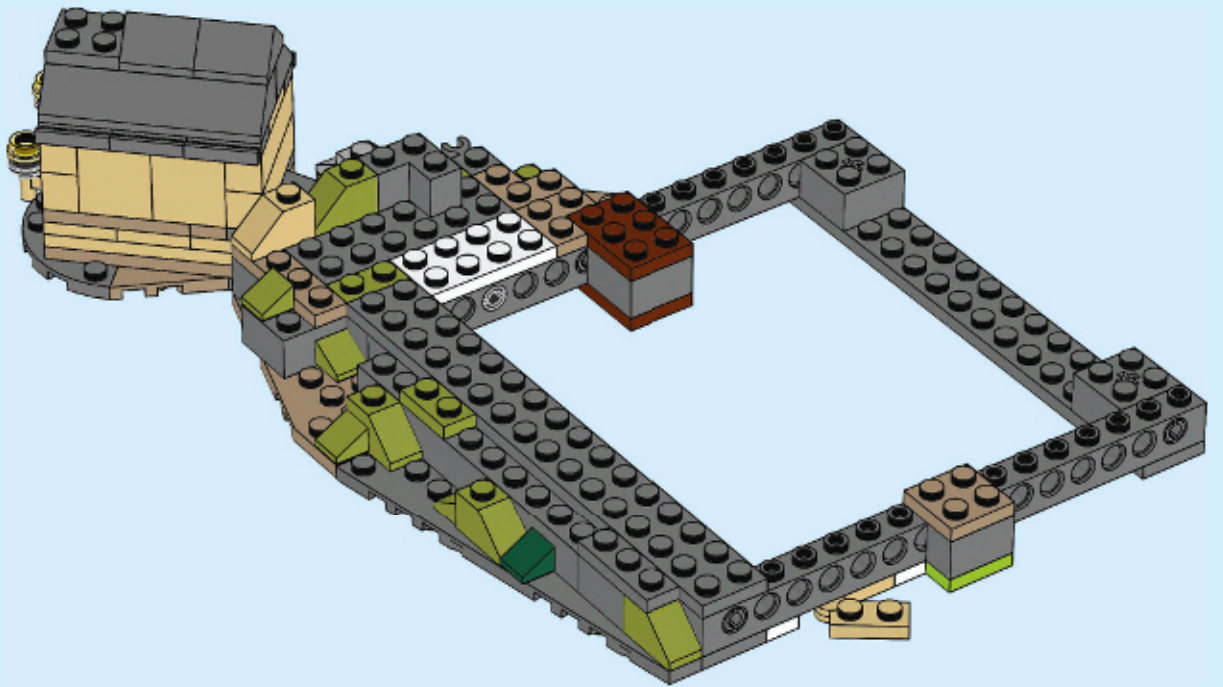

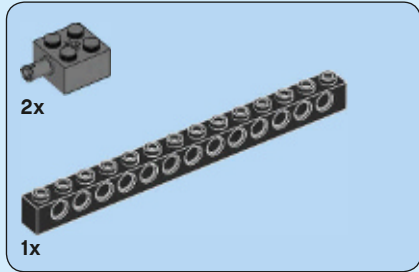
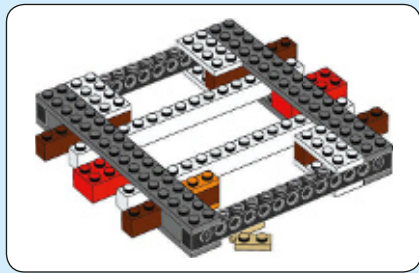

33

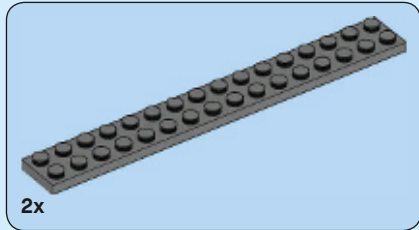
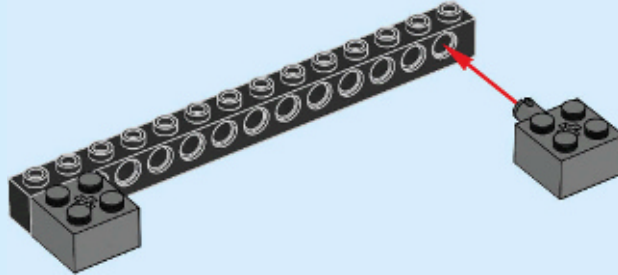

34

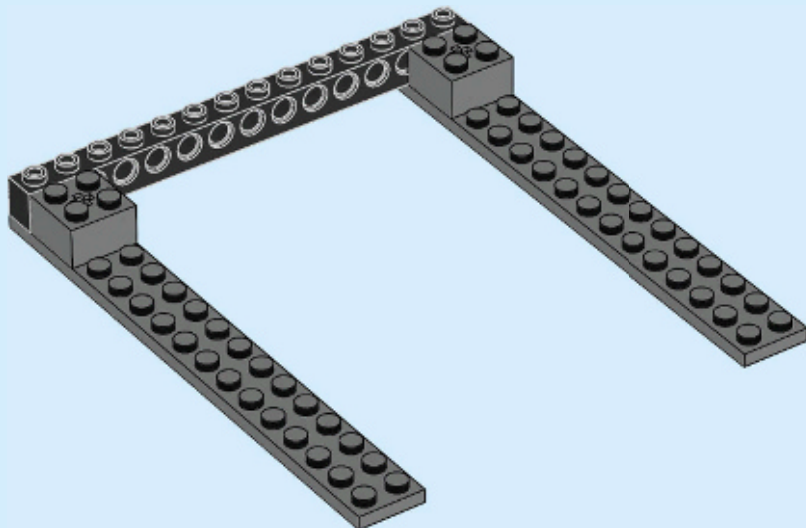

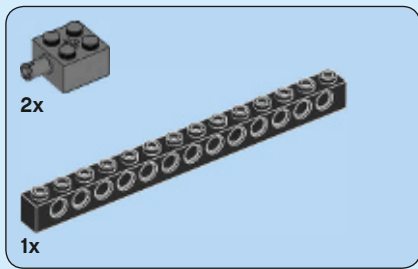

35

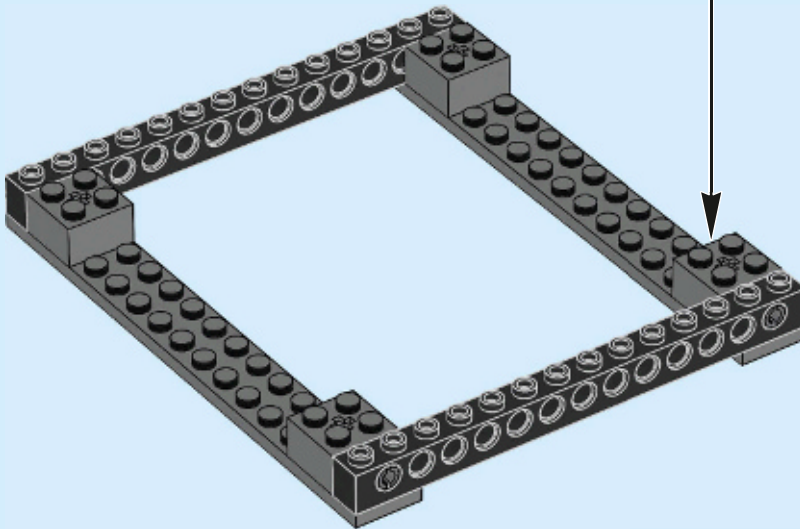
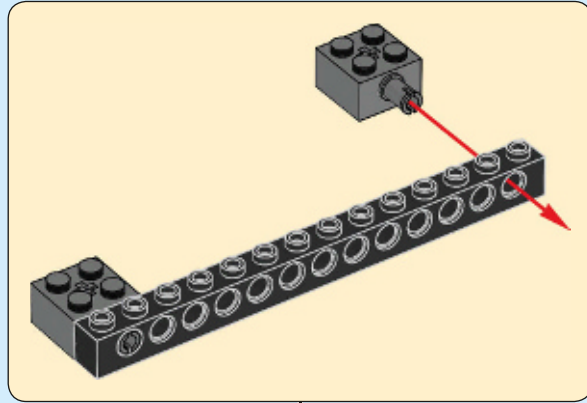

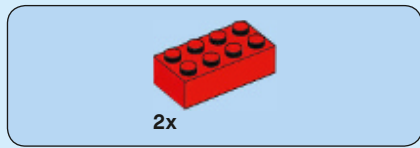

36

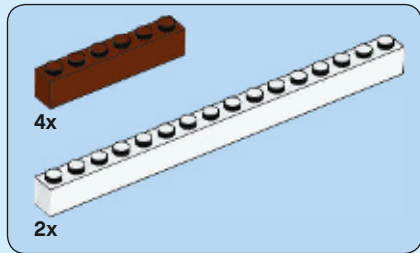
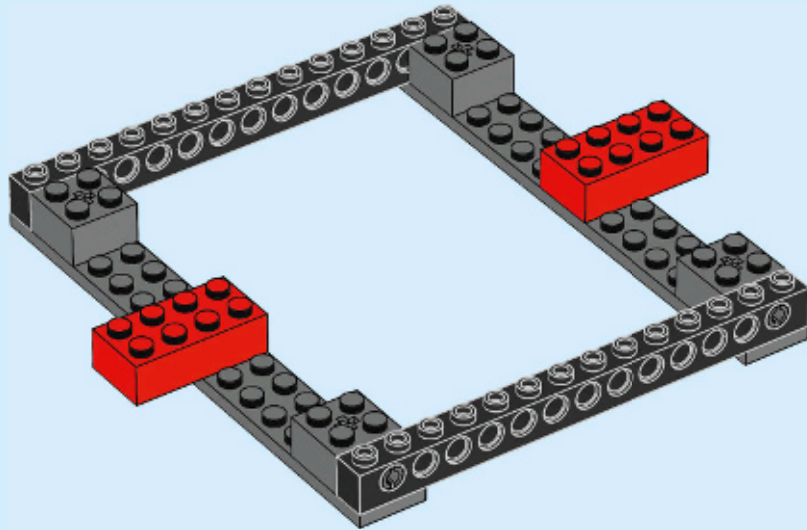

37

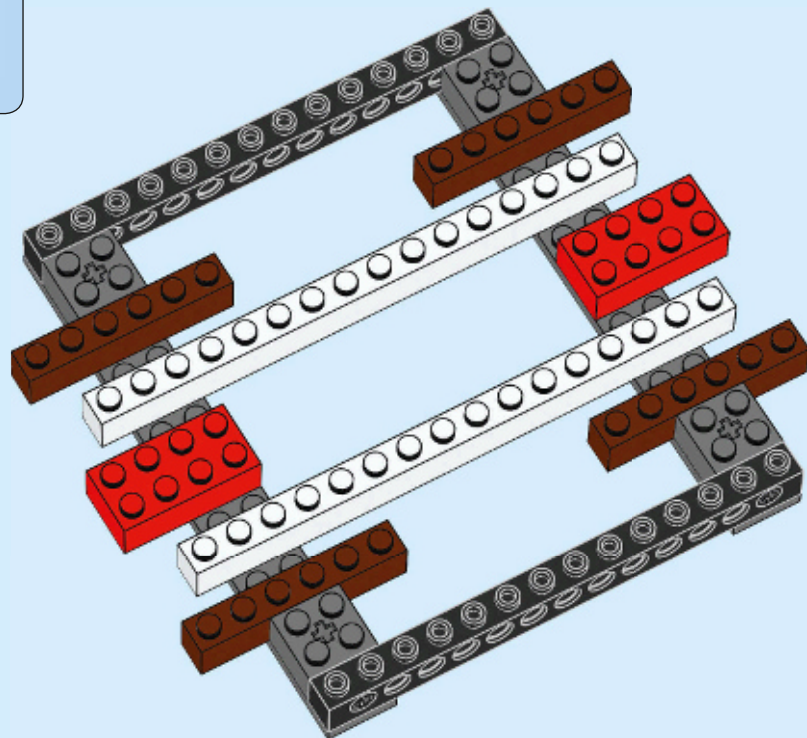

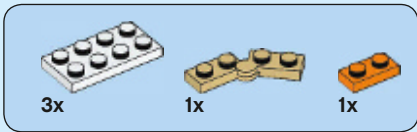

38

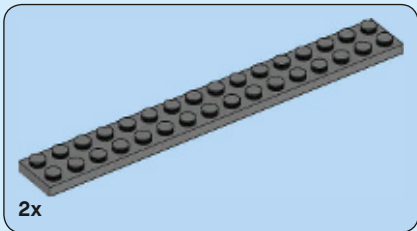
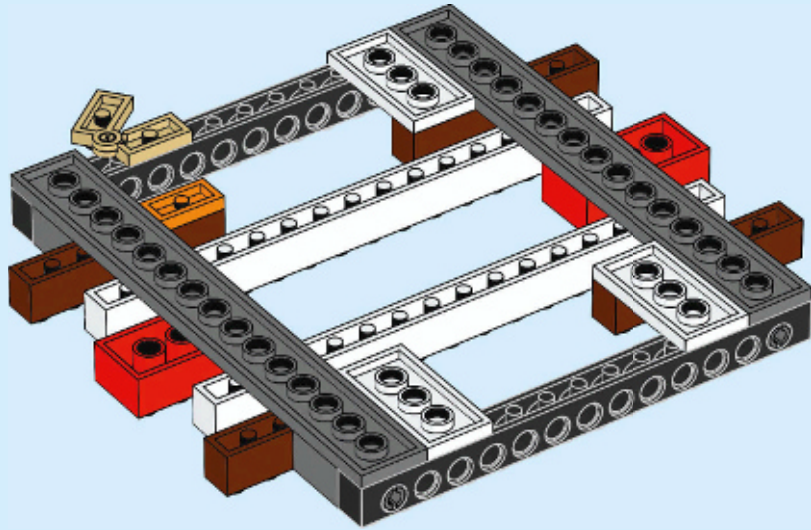
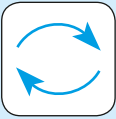

39

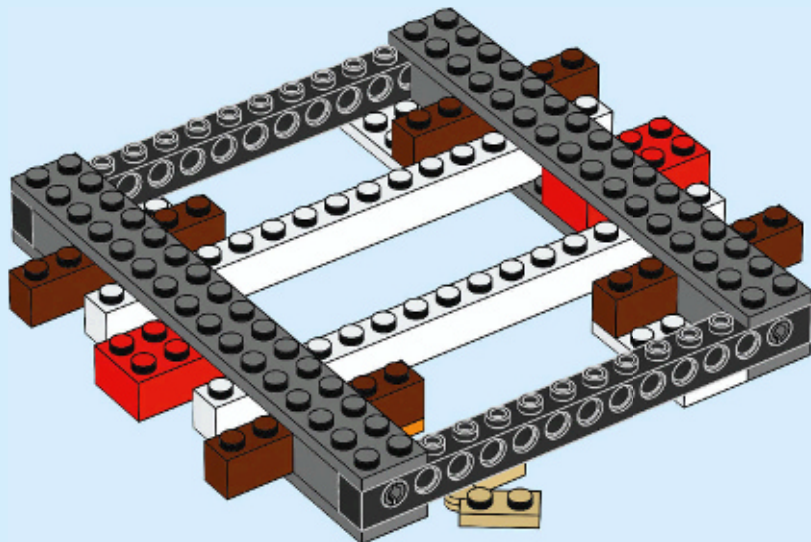



40

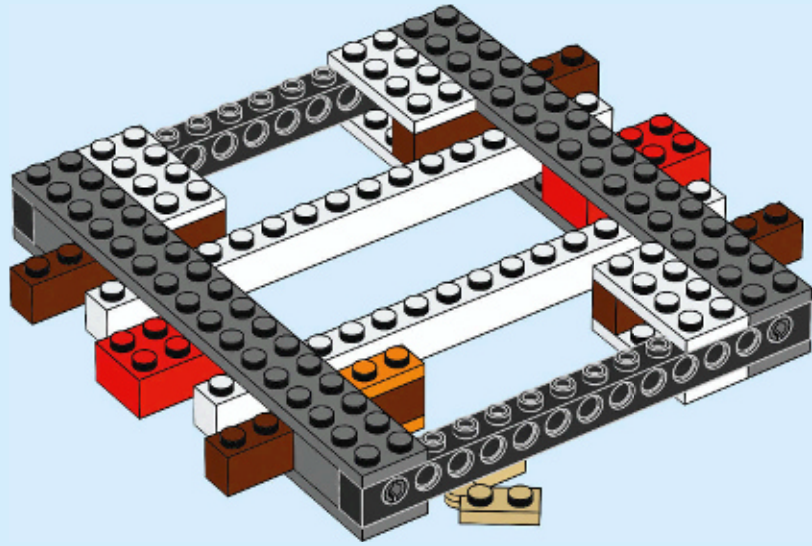

41

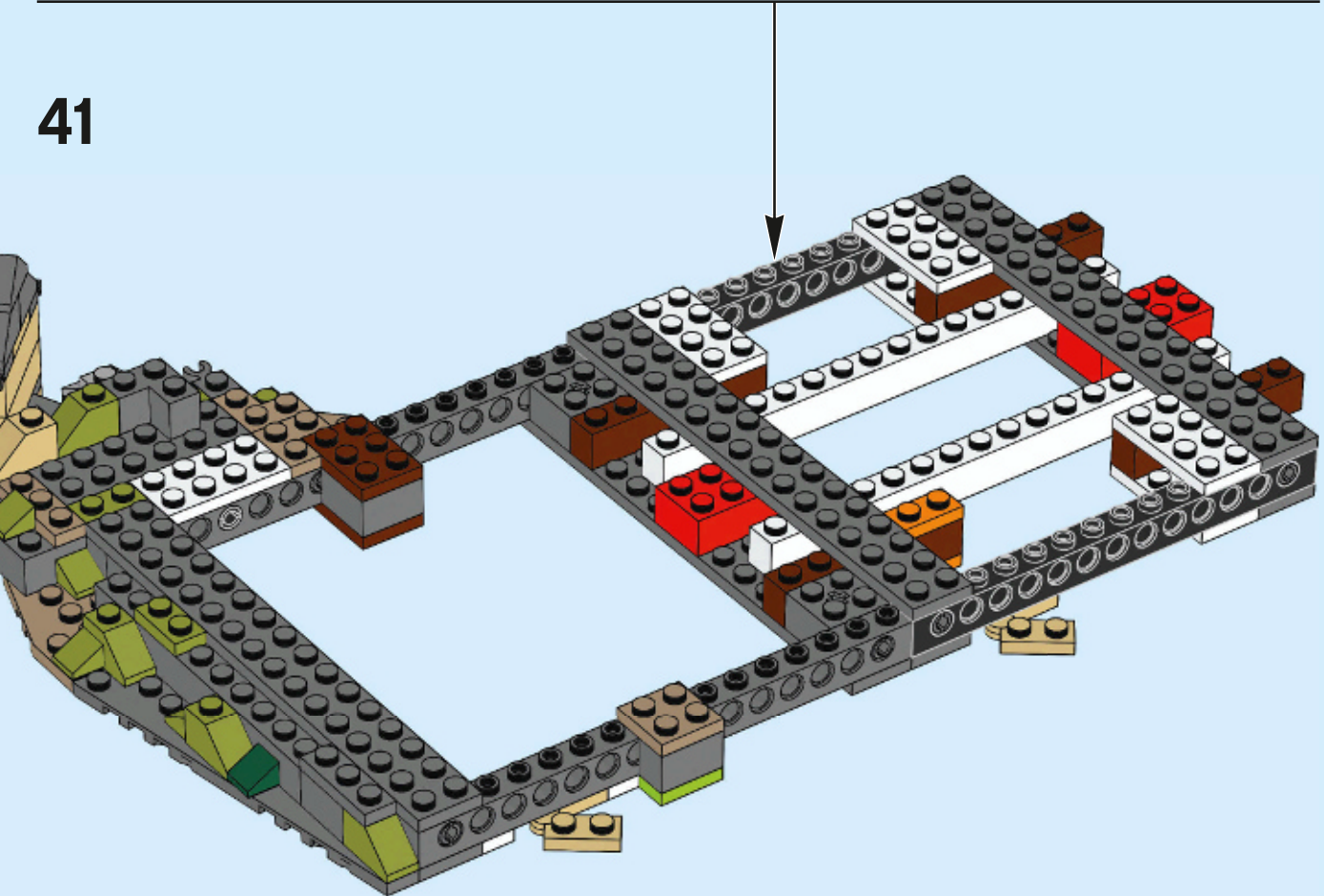

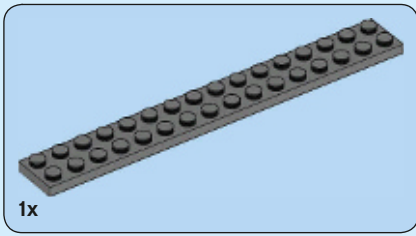

1x

42

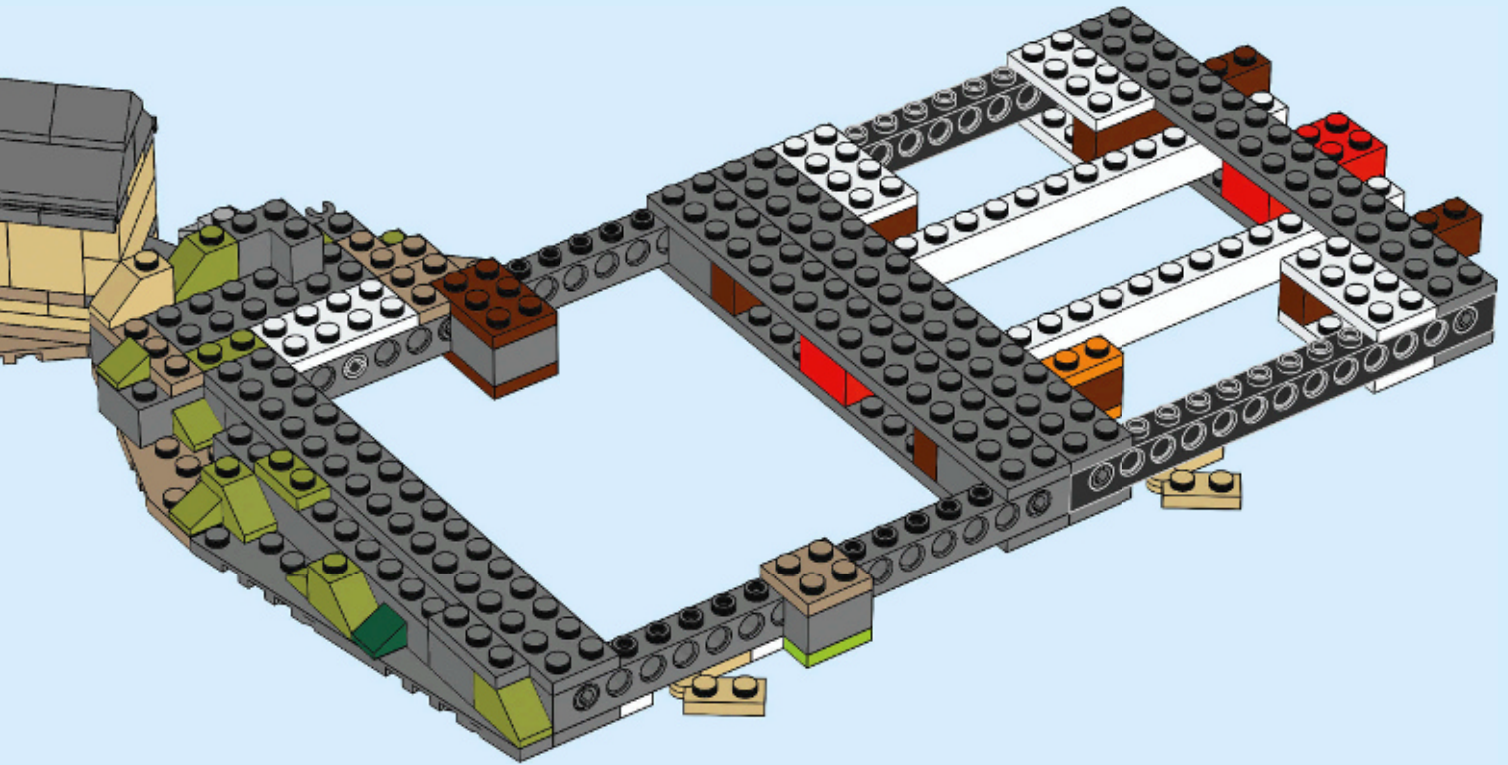

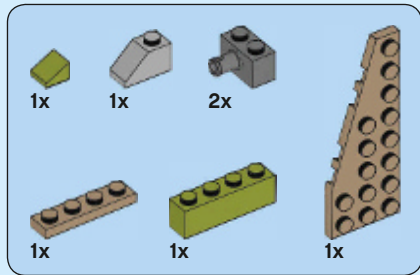

43

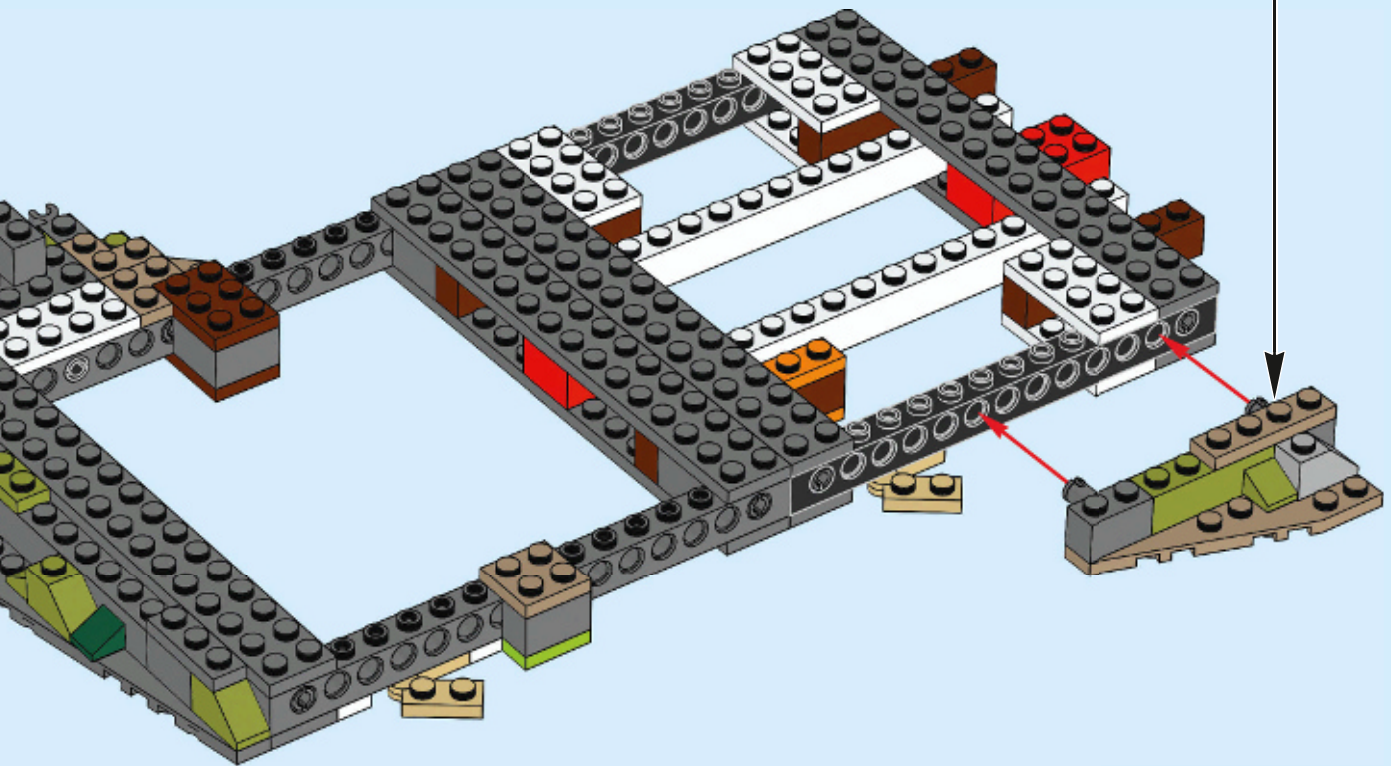
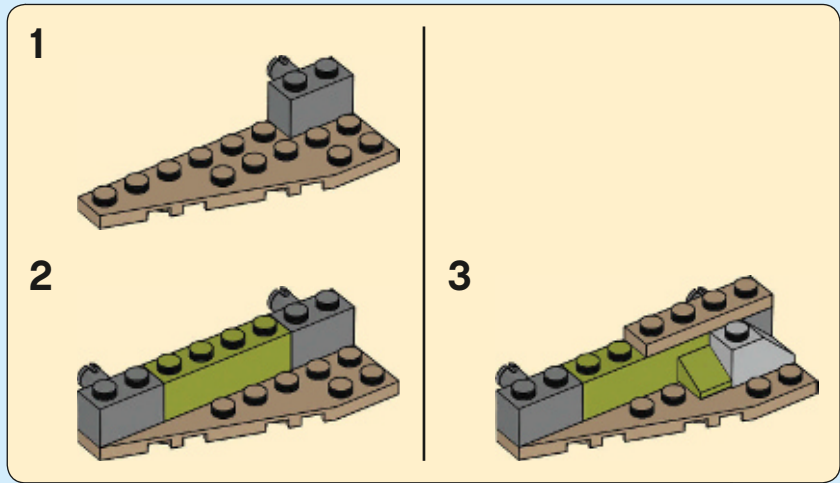

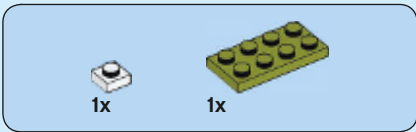

44

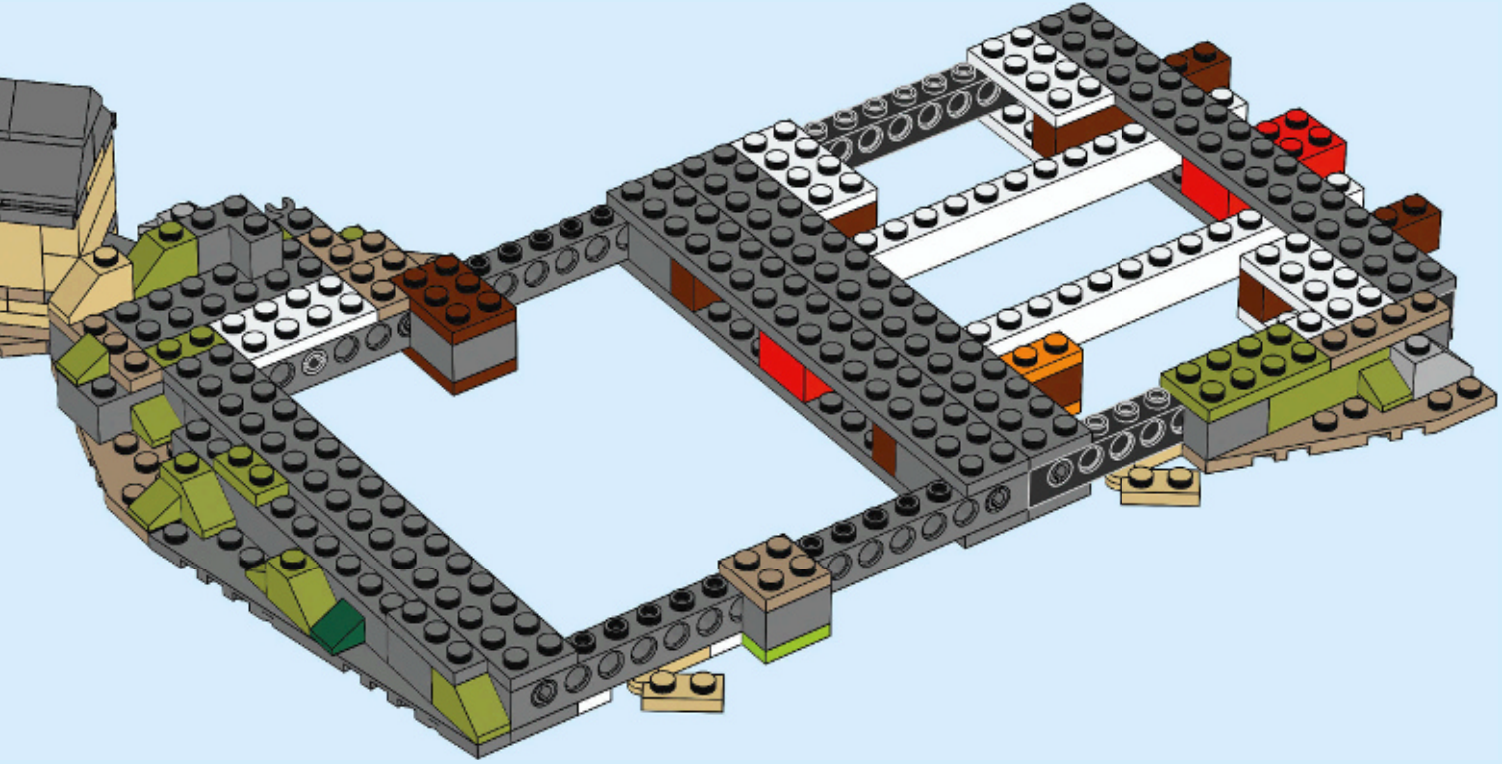

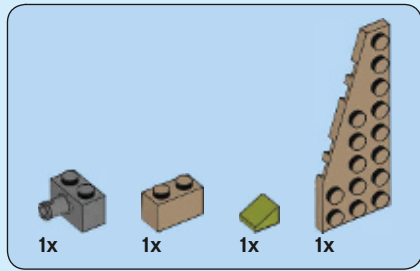

45

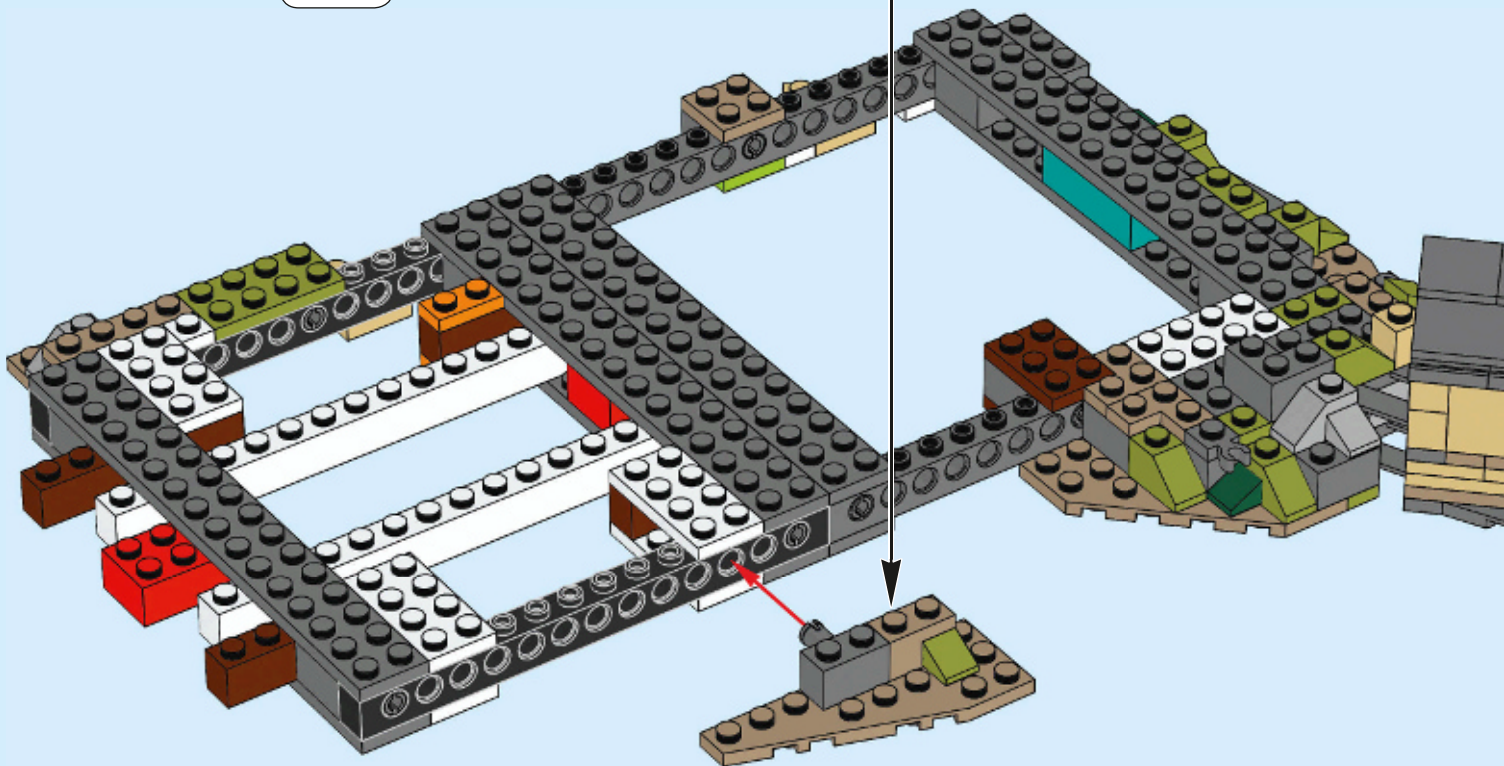
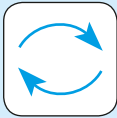
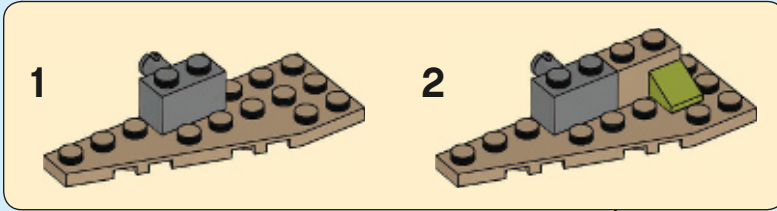

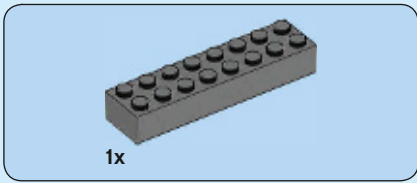

46

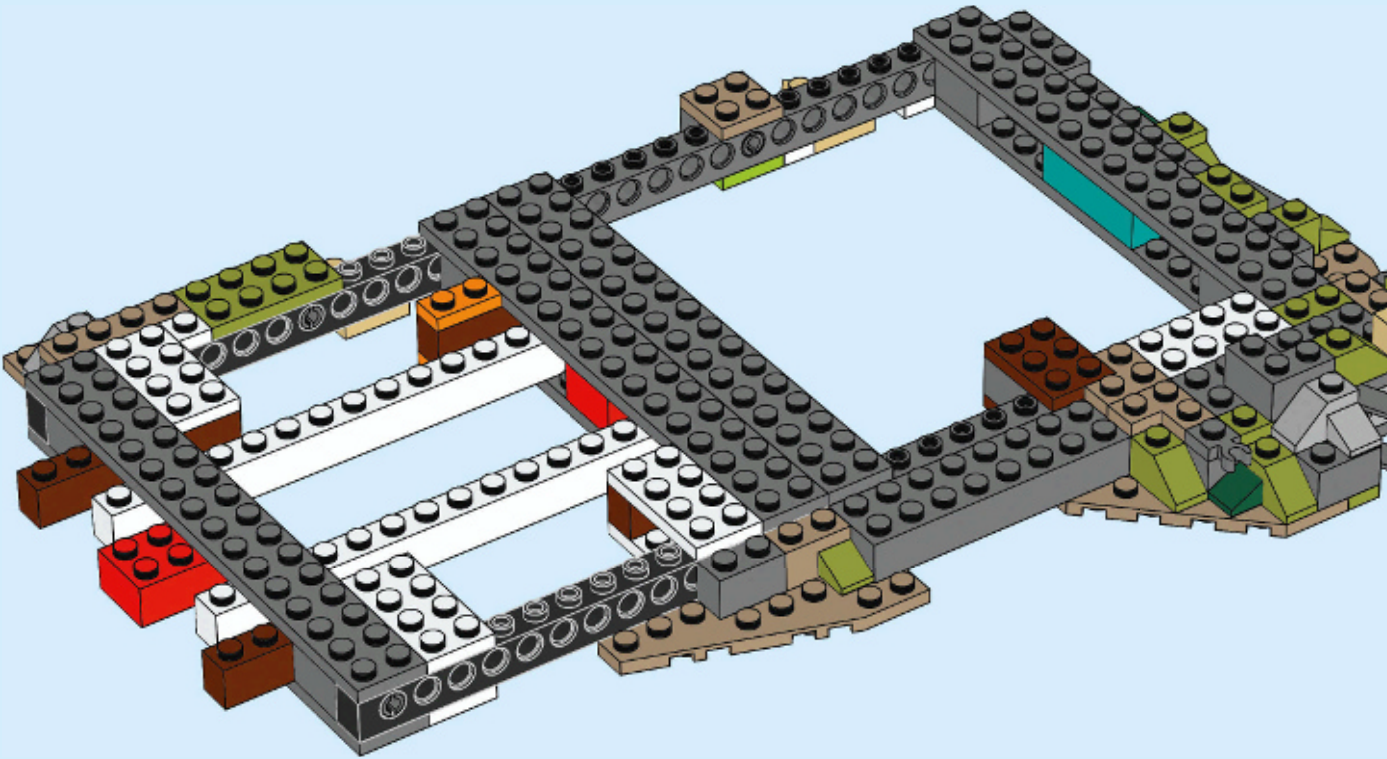



47

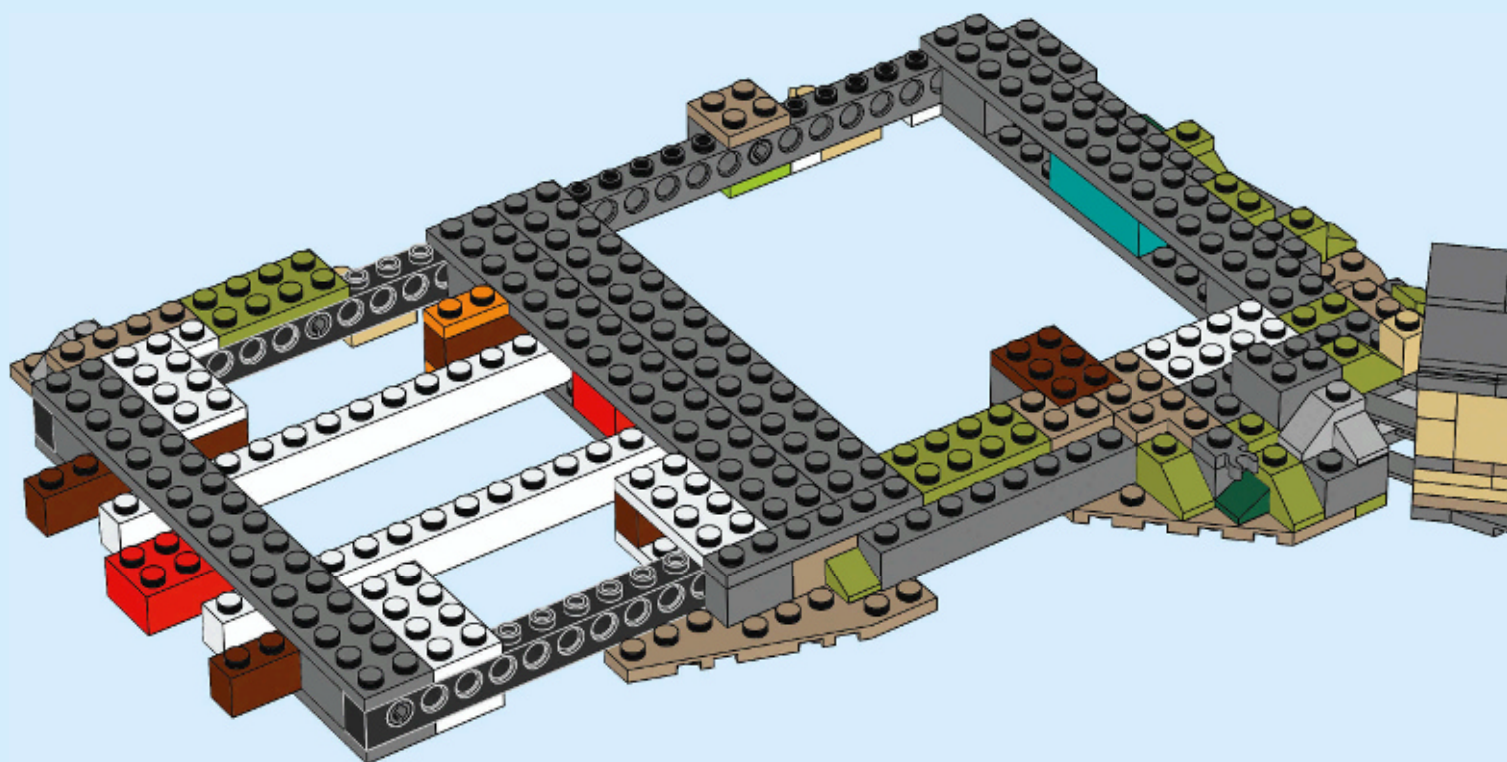

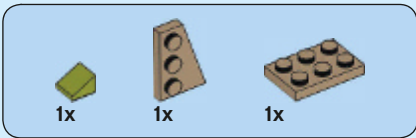

48

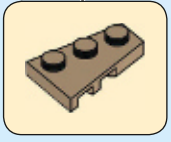
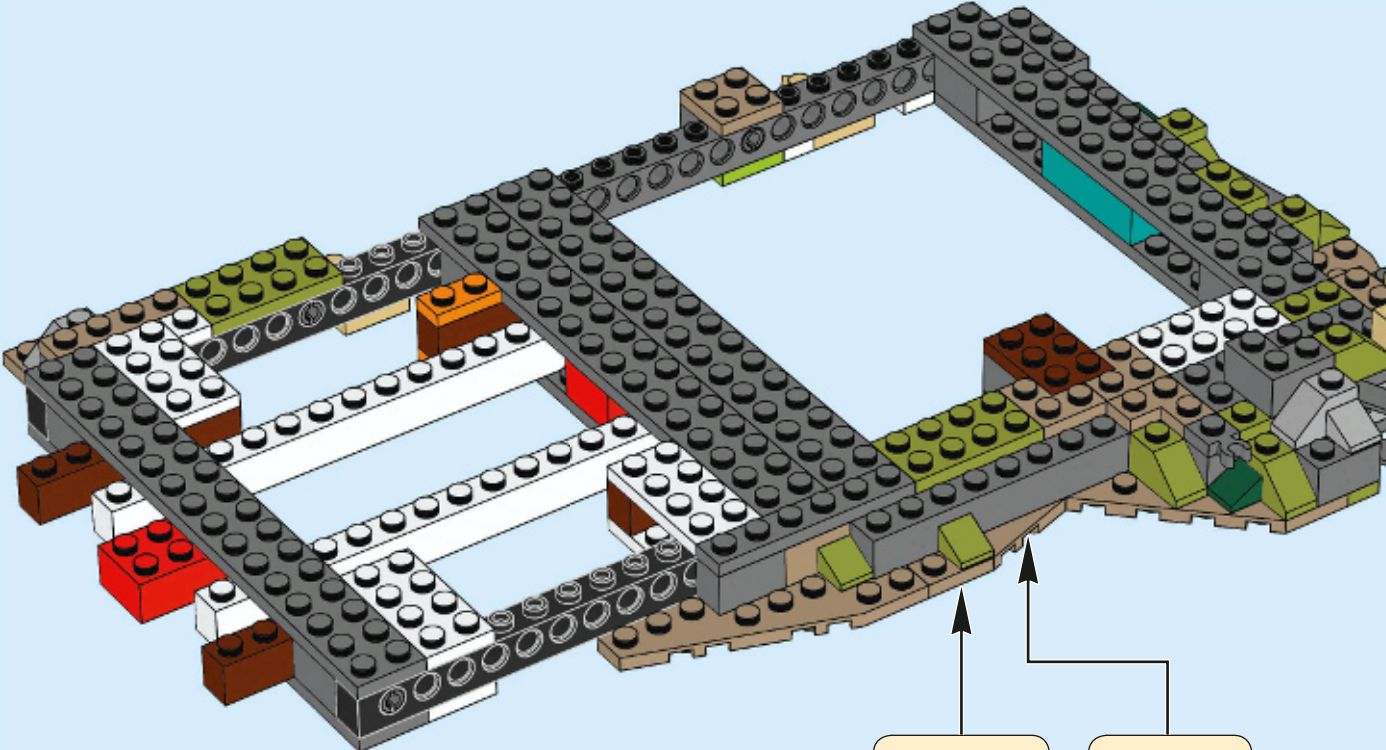

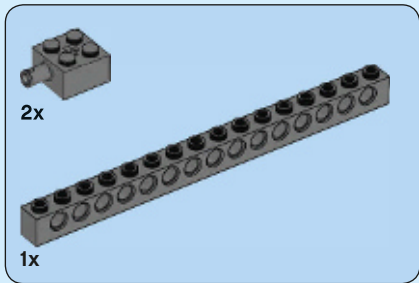
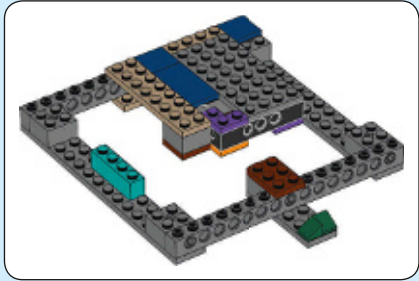
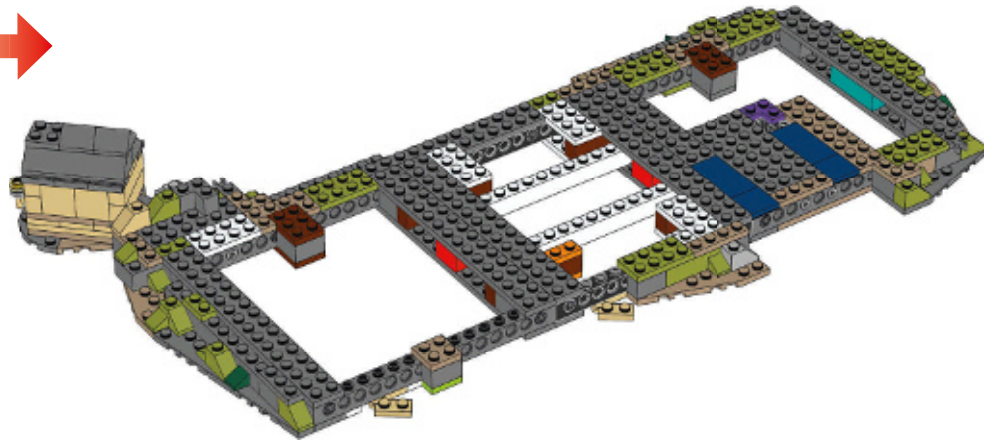

49

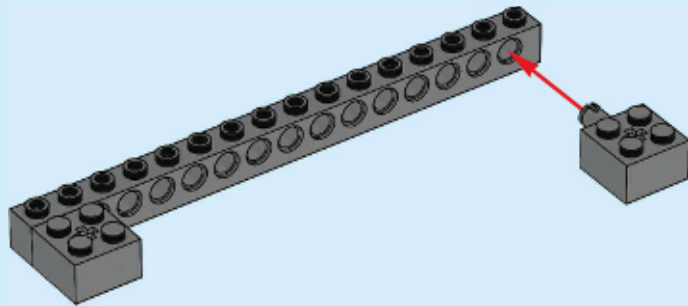

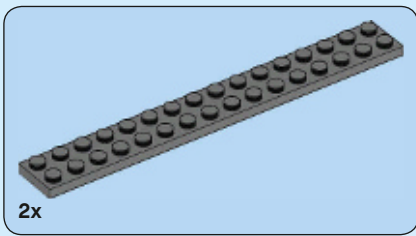

50

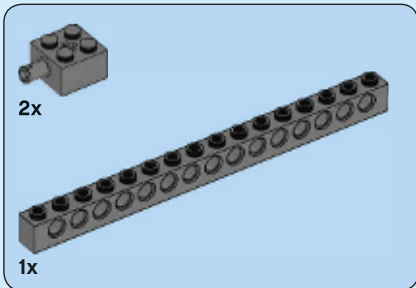
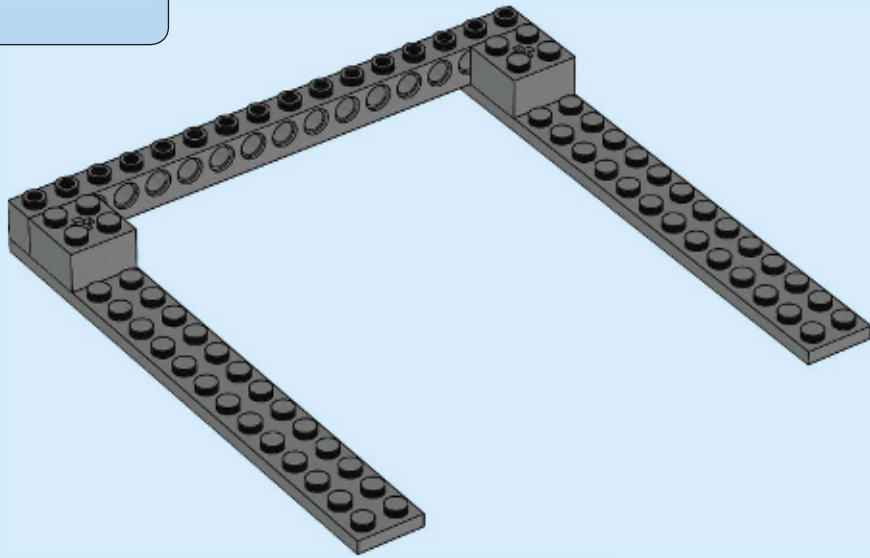

51

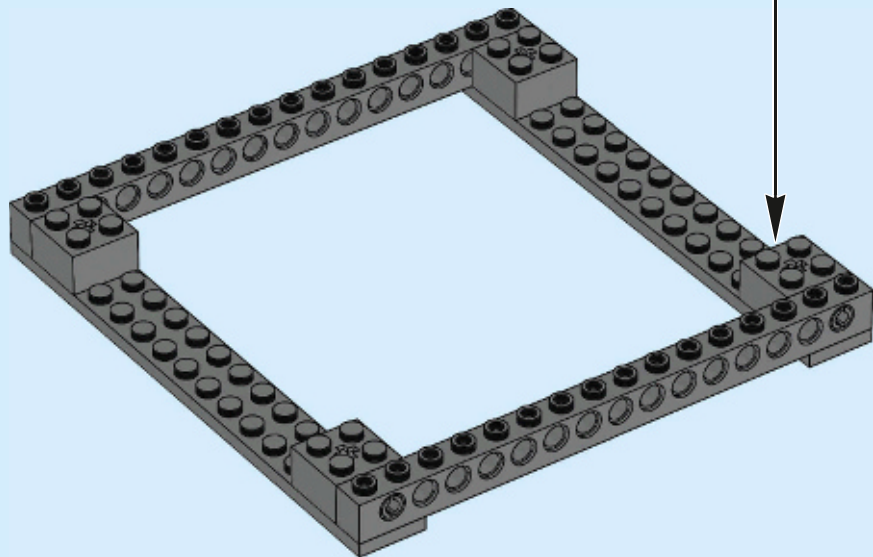
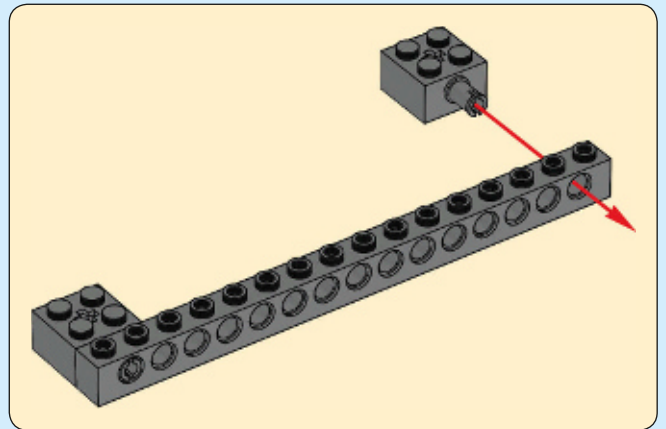

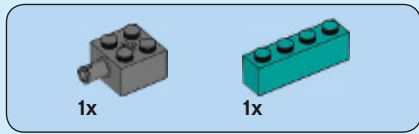

52

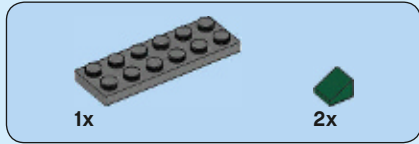
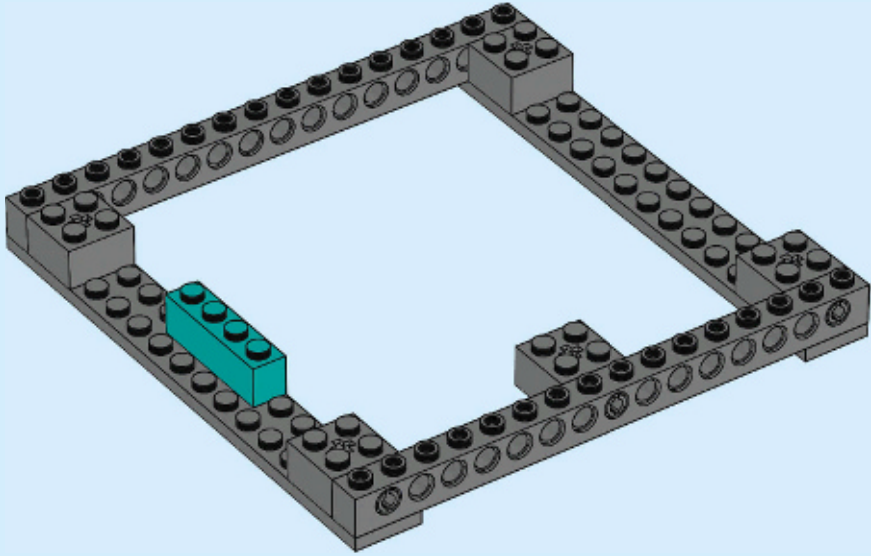

53

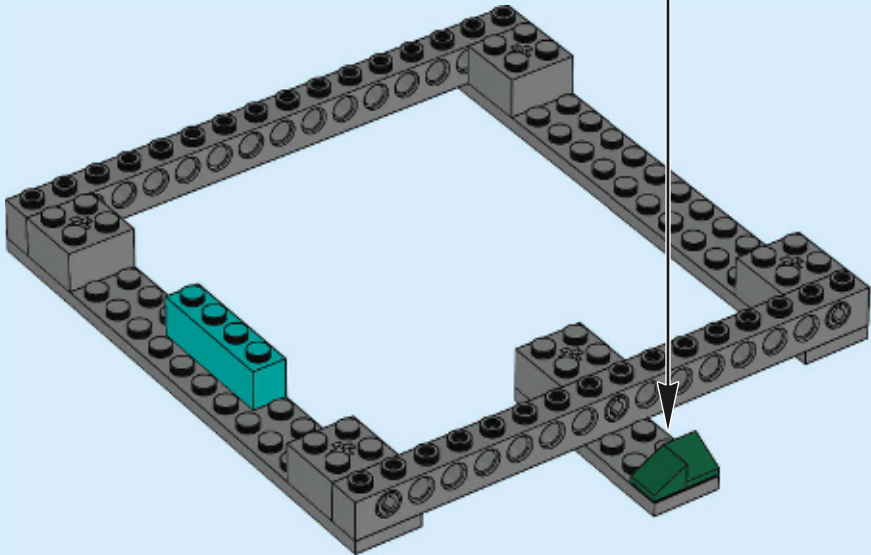
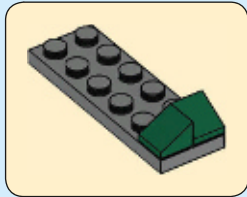

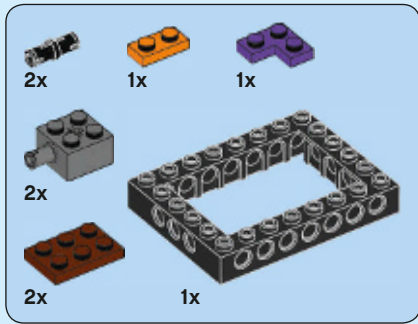

54

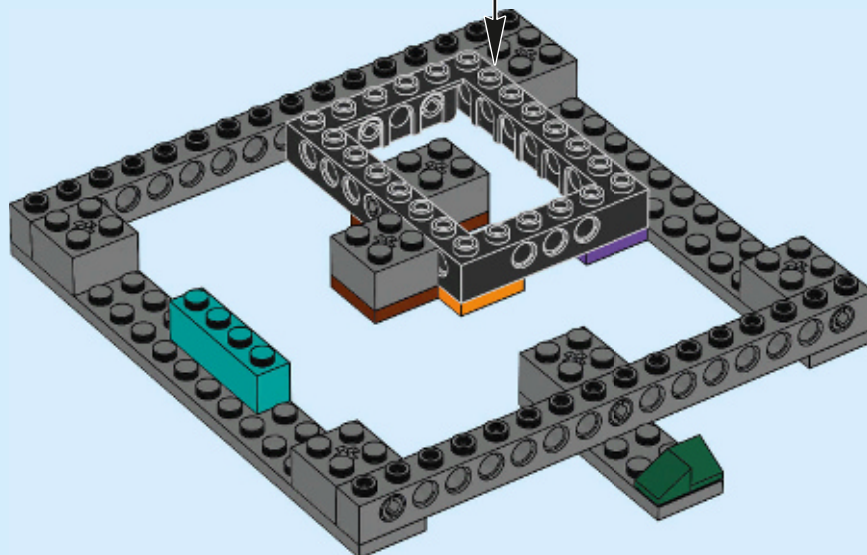
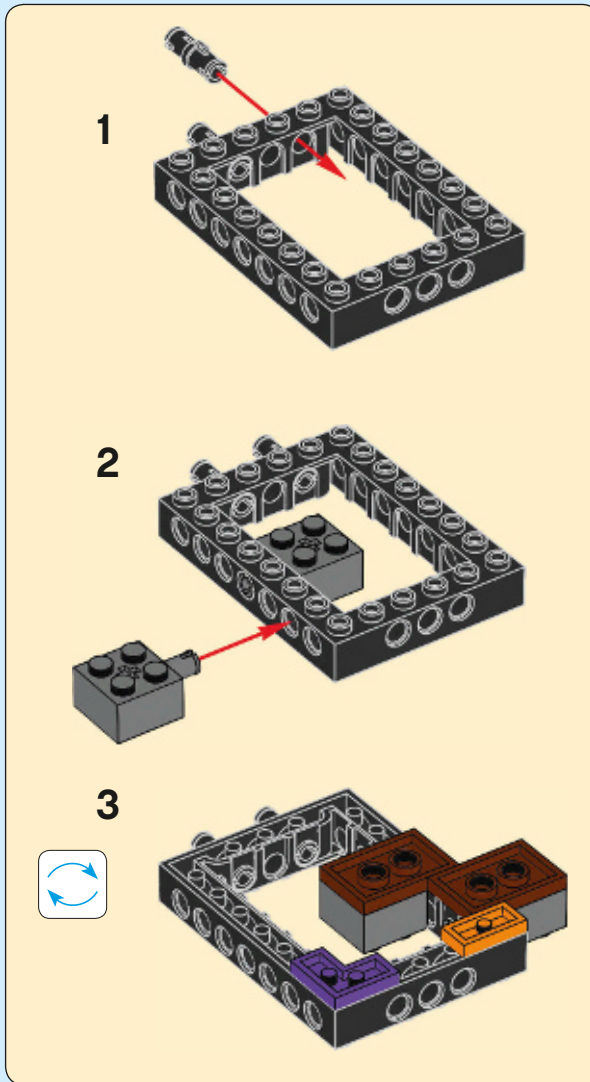

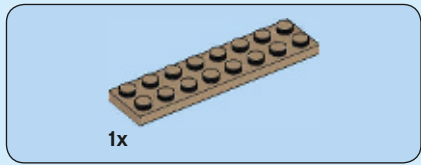

55

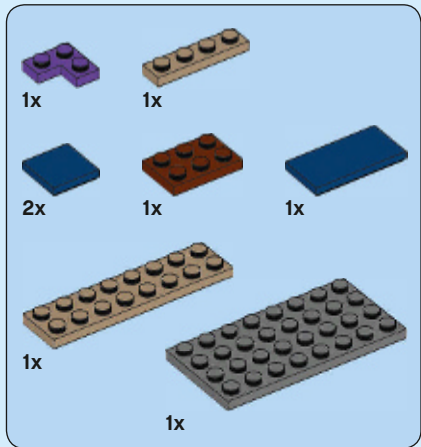
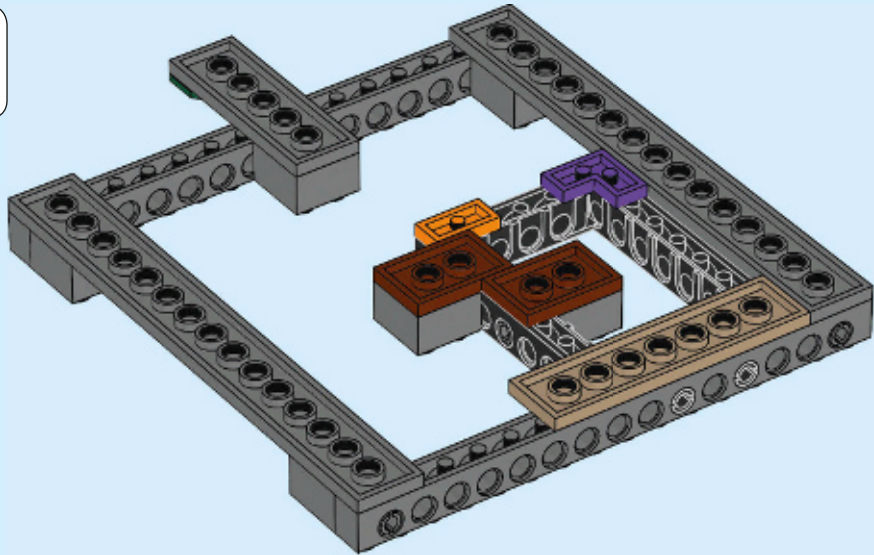
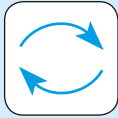

56

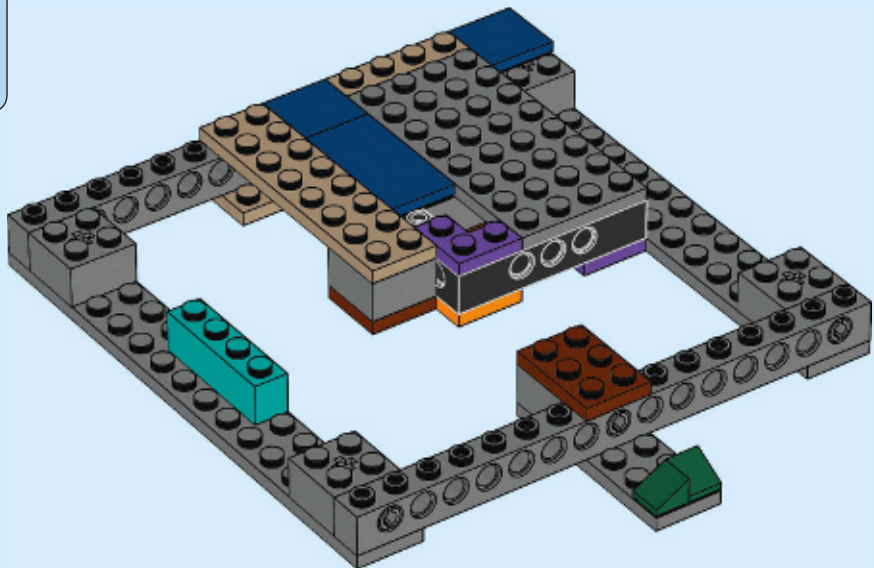
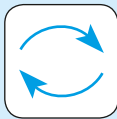

57

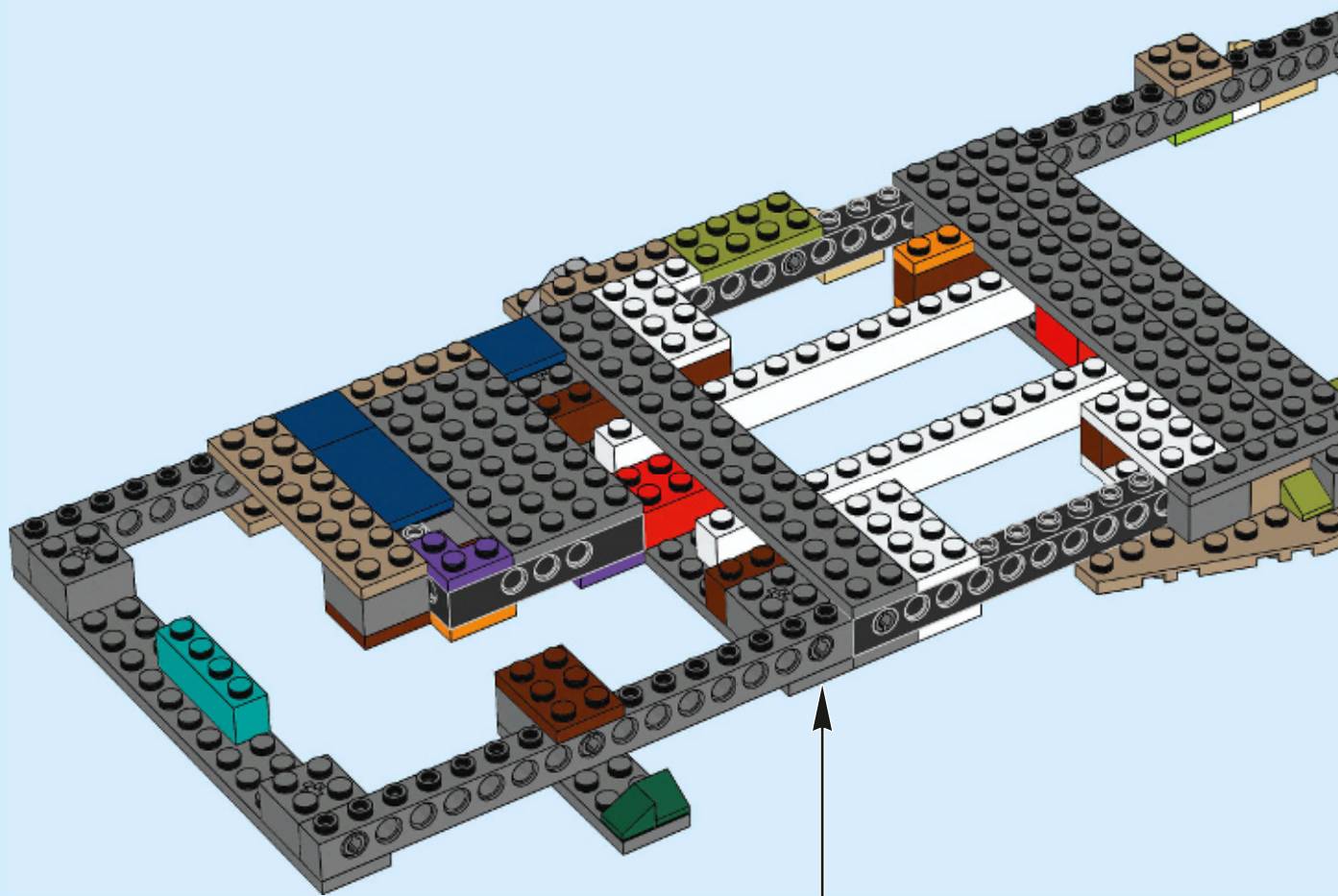

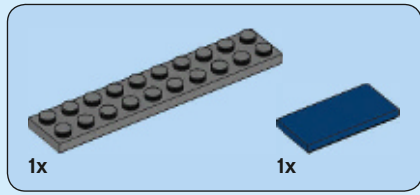

58

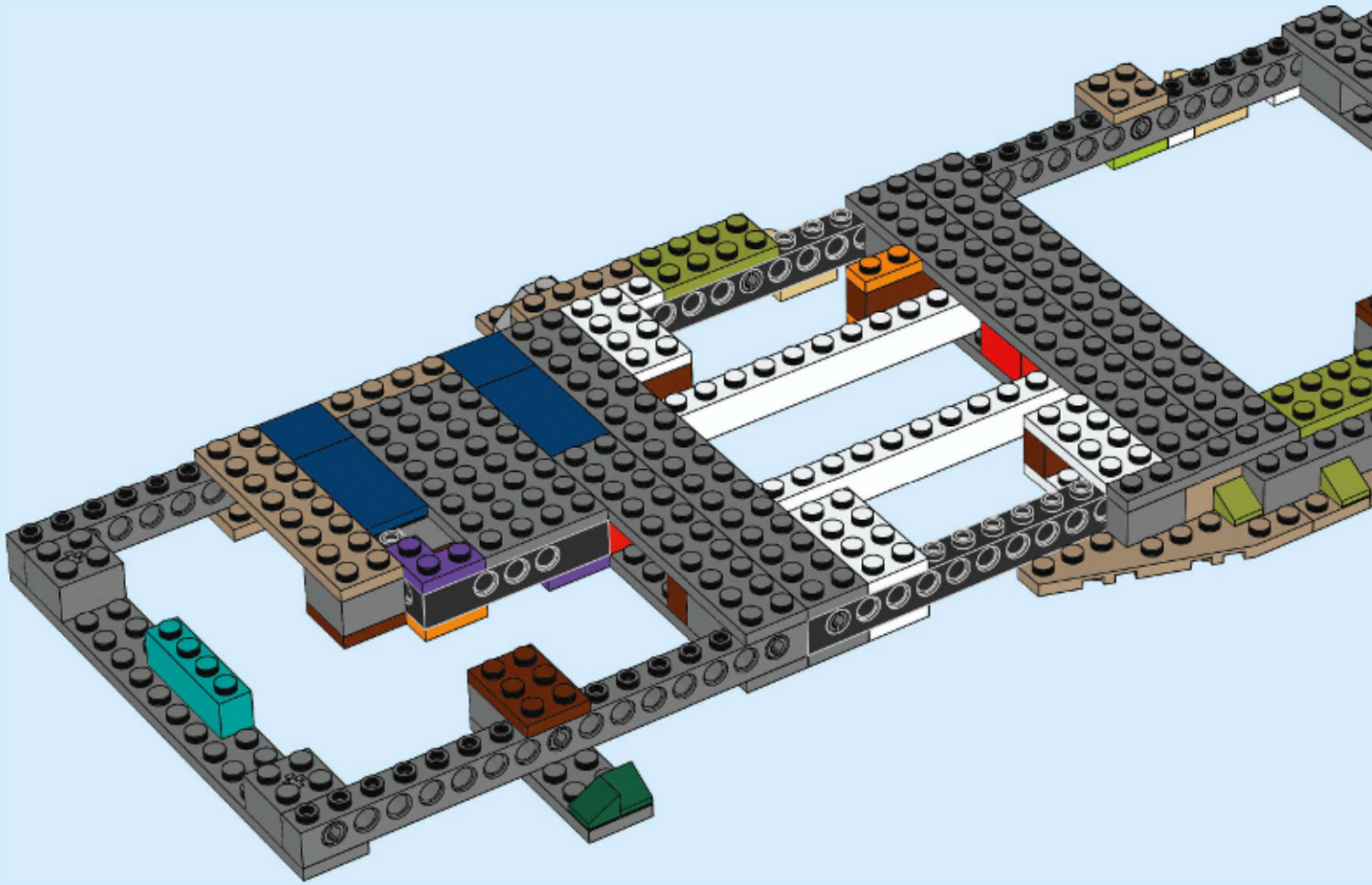

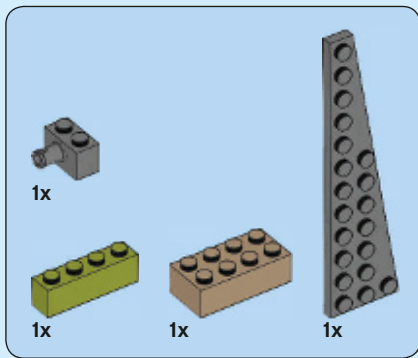

59

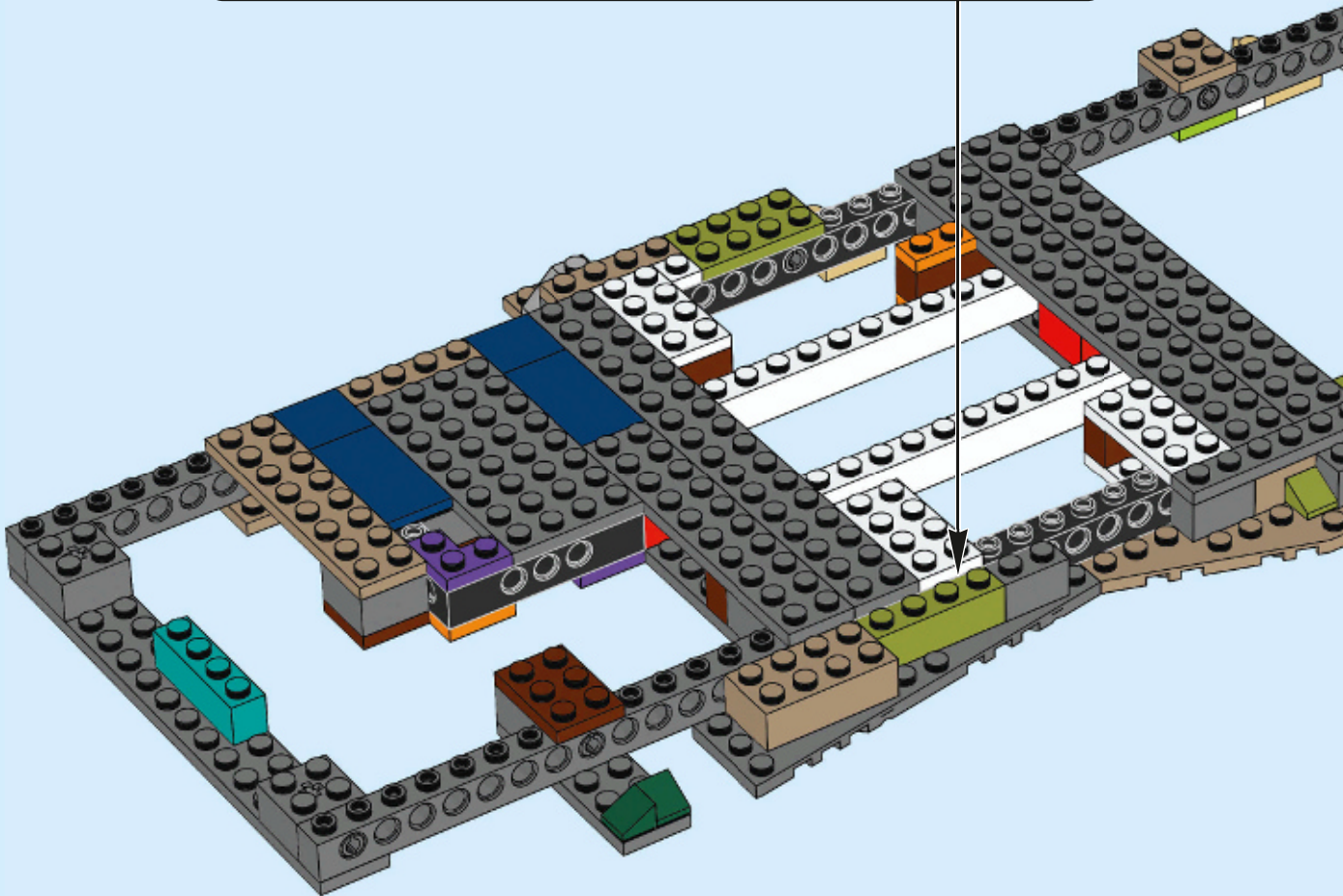
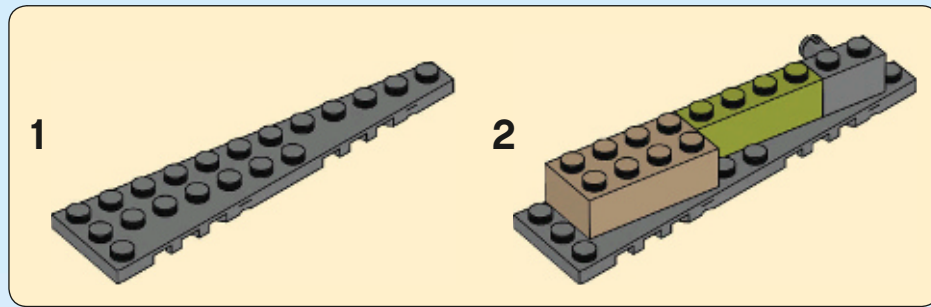

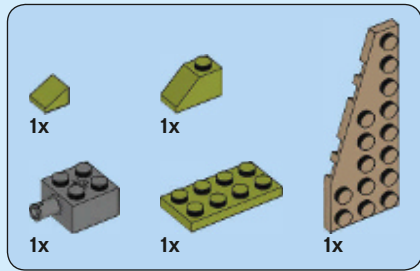

60

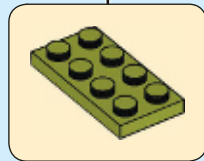
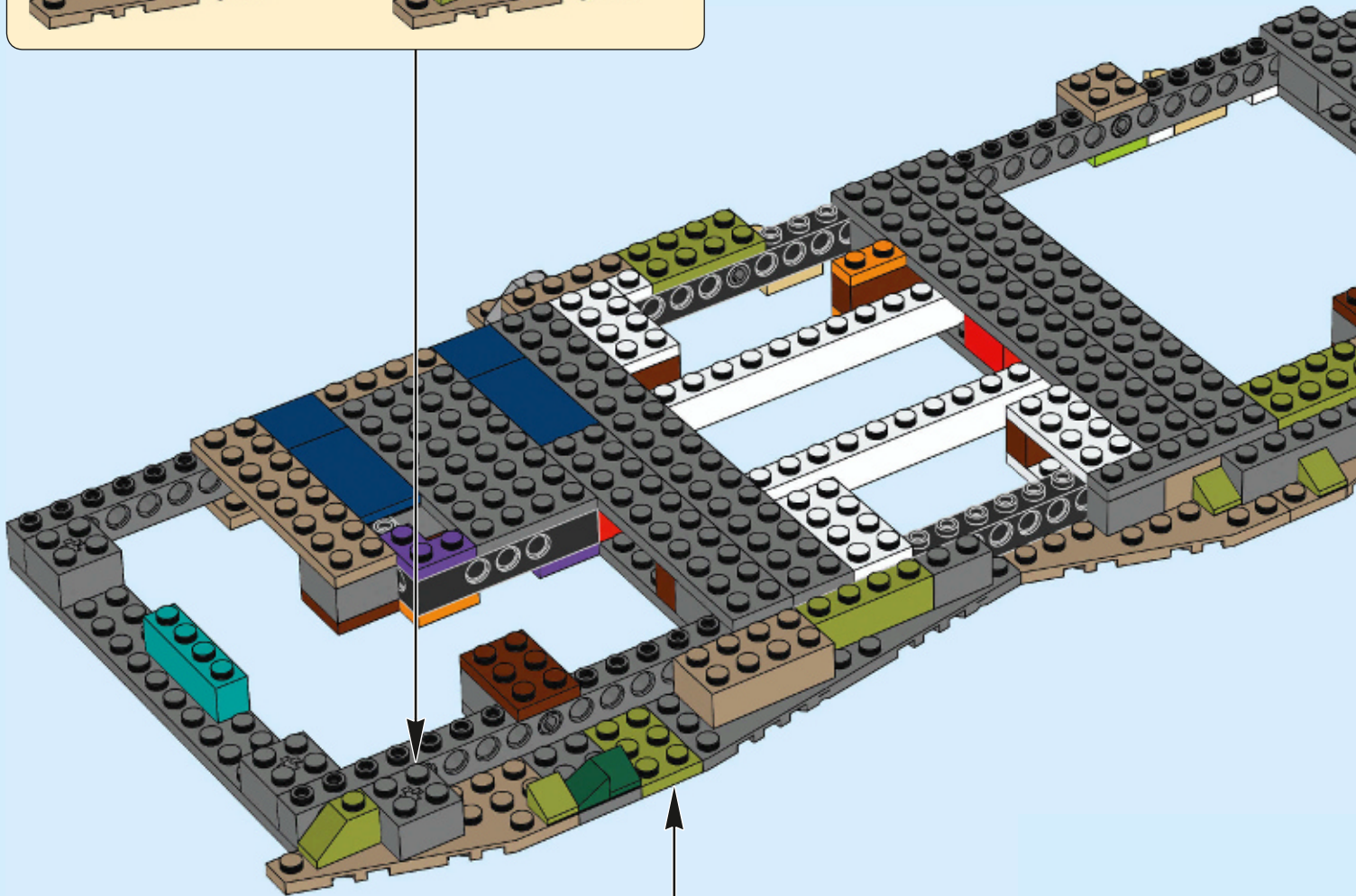
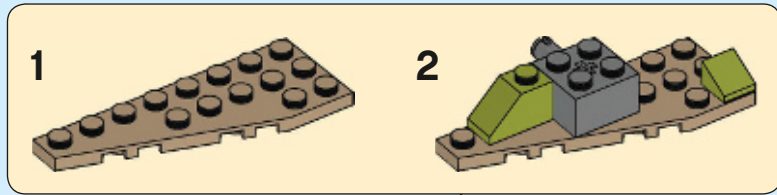

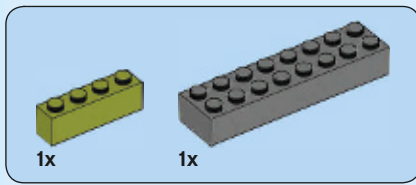

61

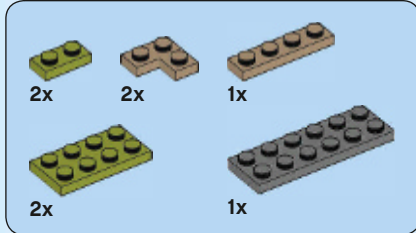
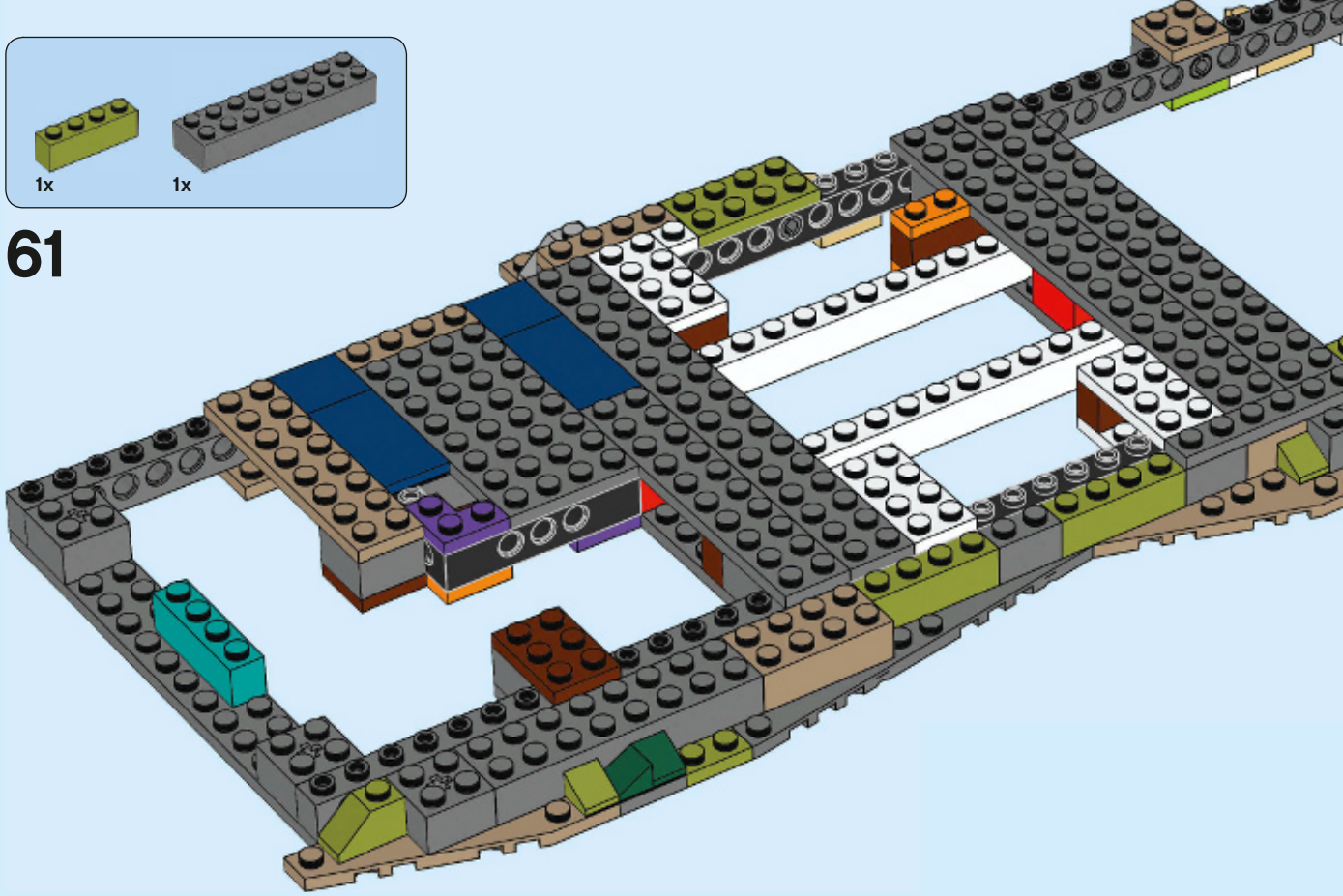

62

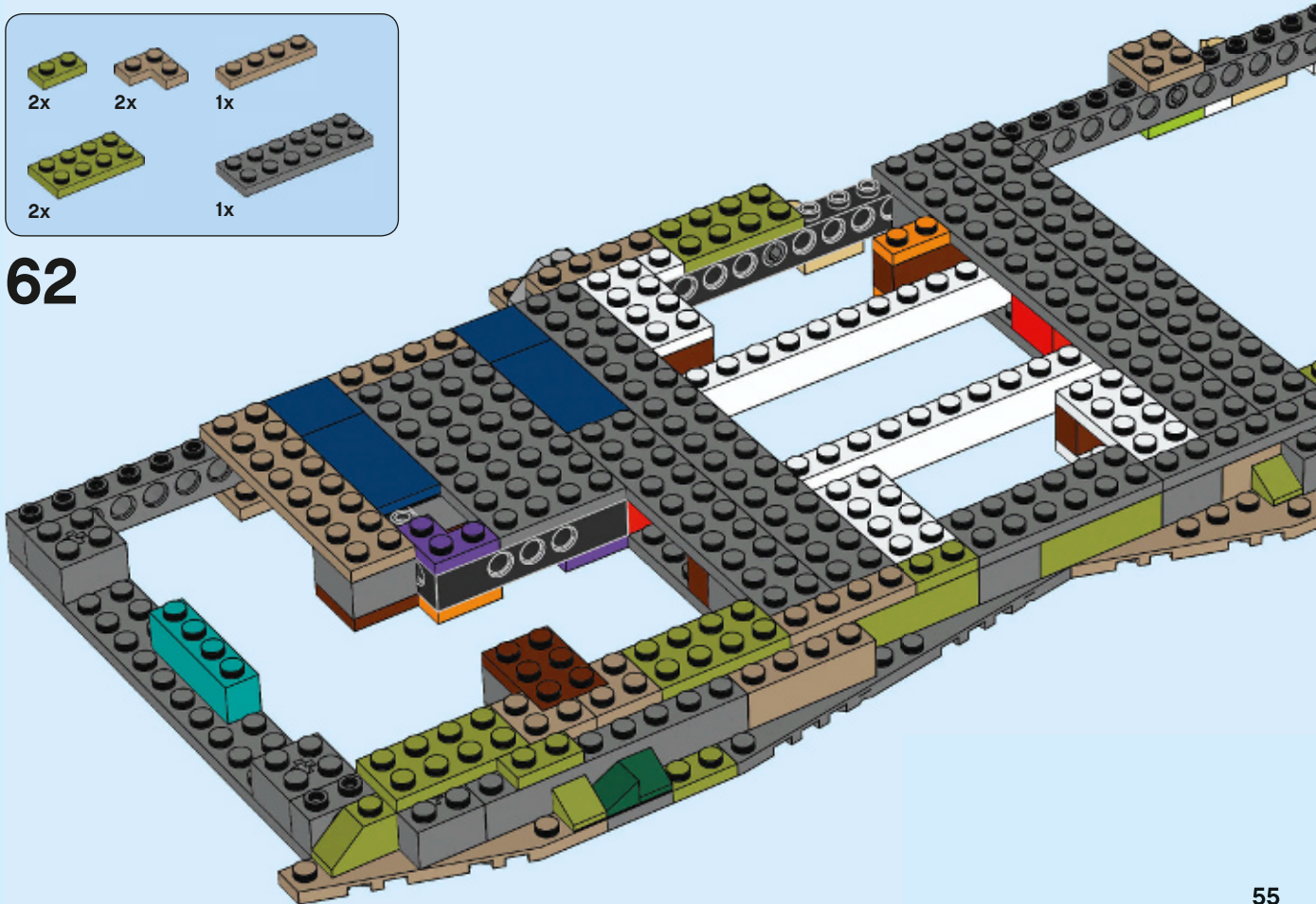

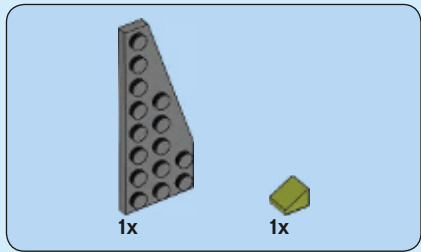

63

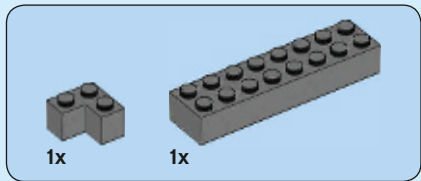

64

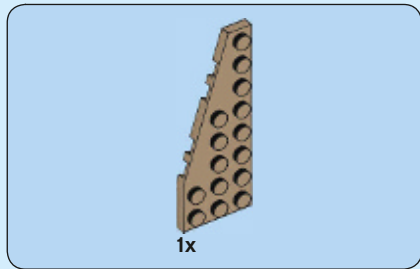
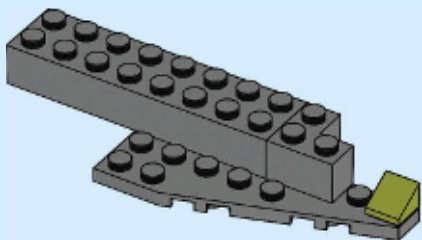

65

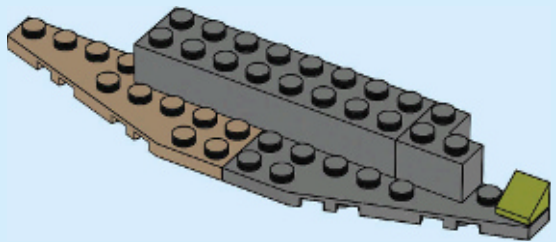

66

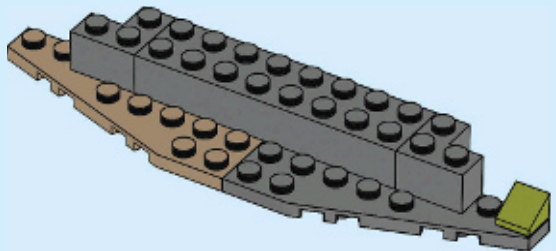

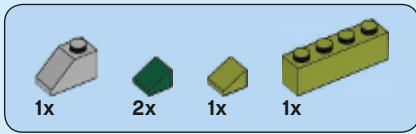

67

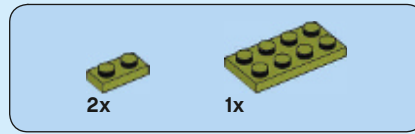
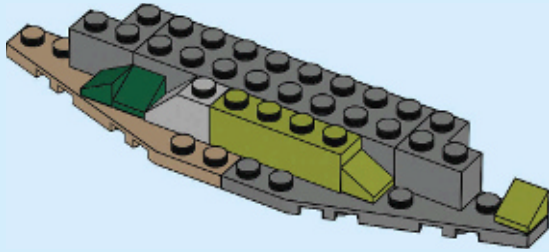

68

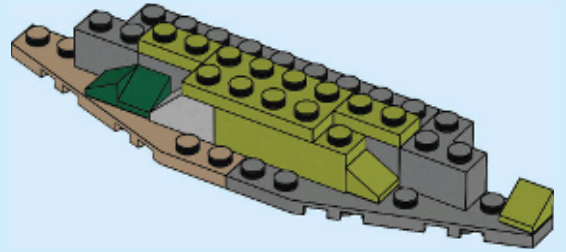

69

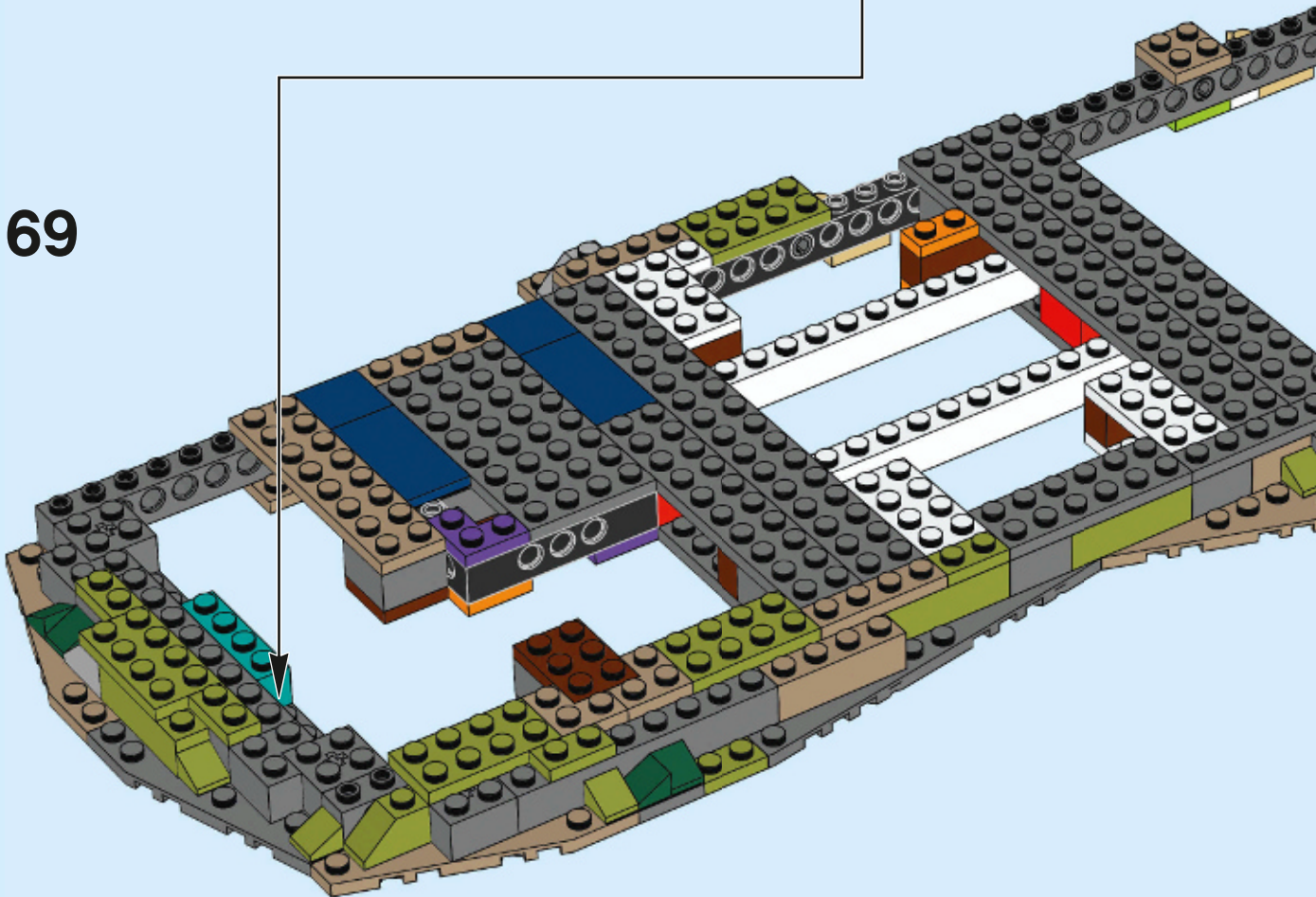

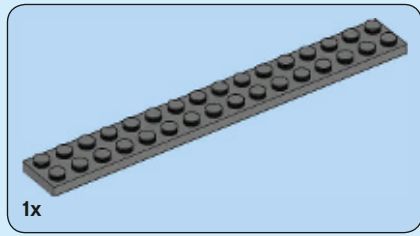

70

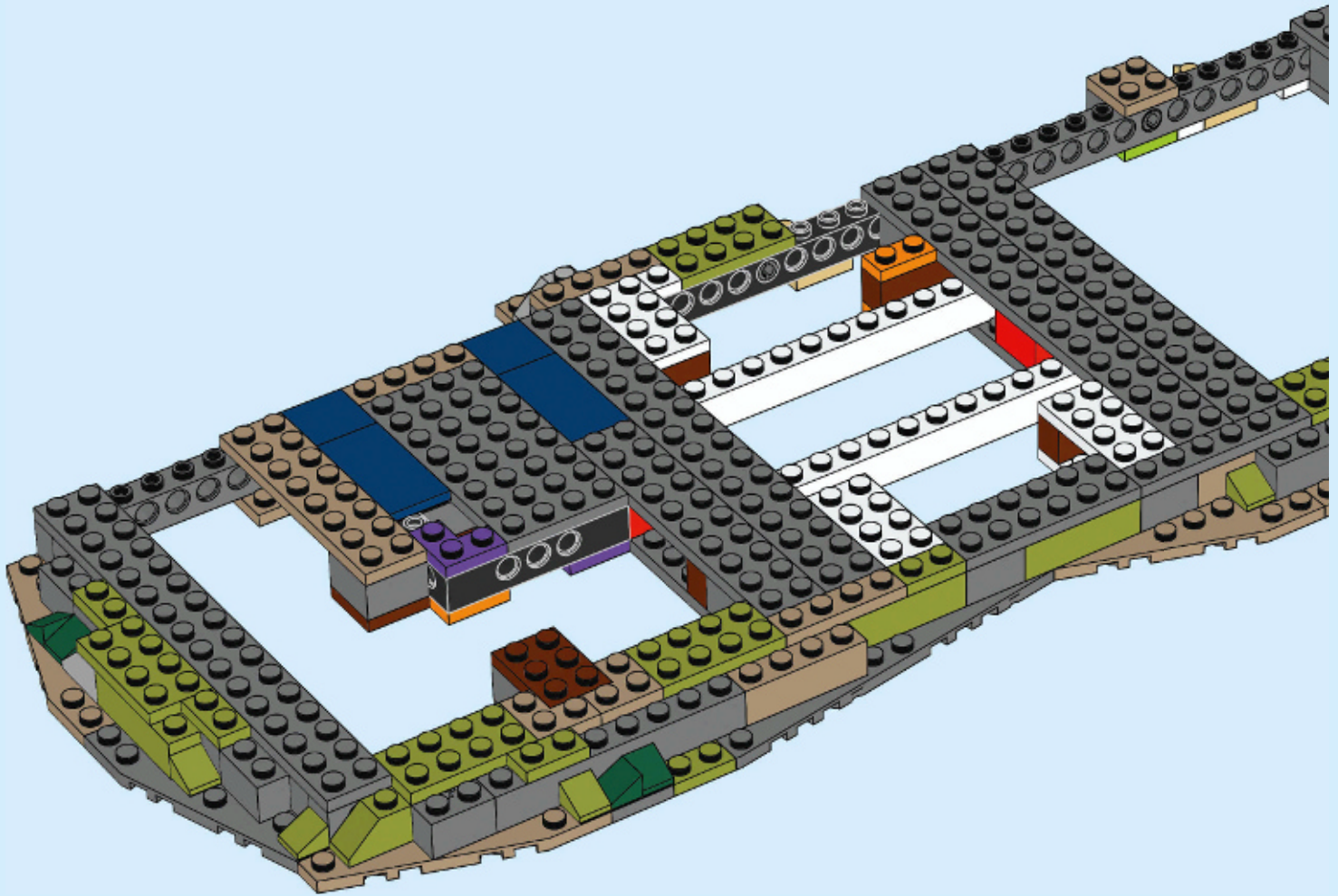

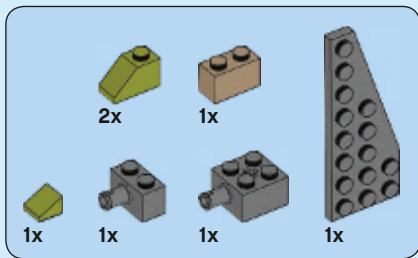

71

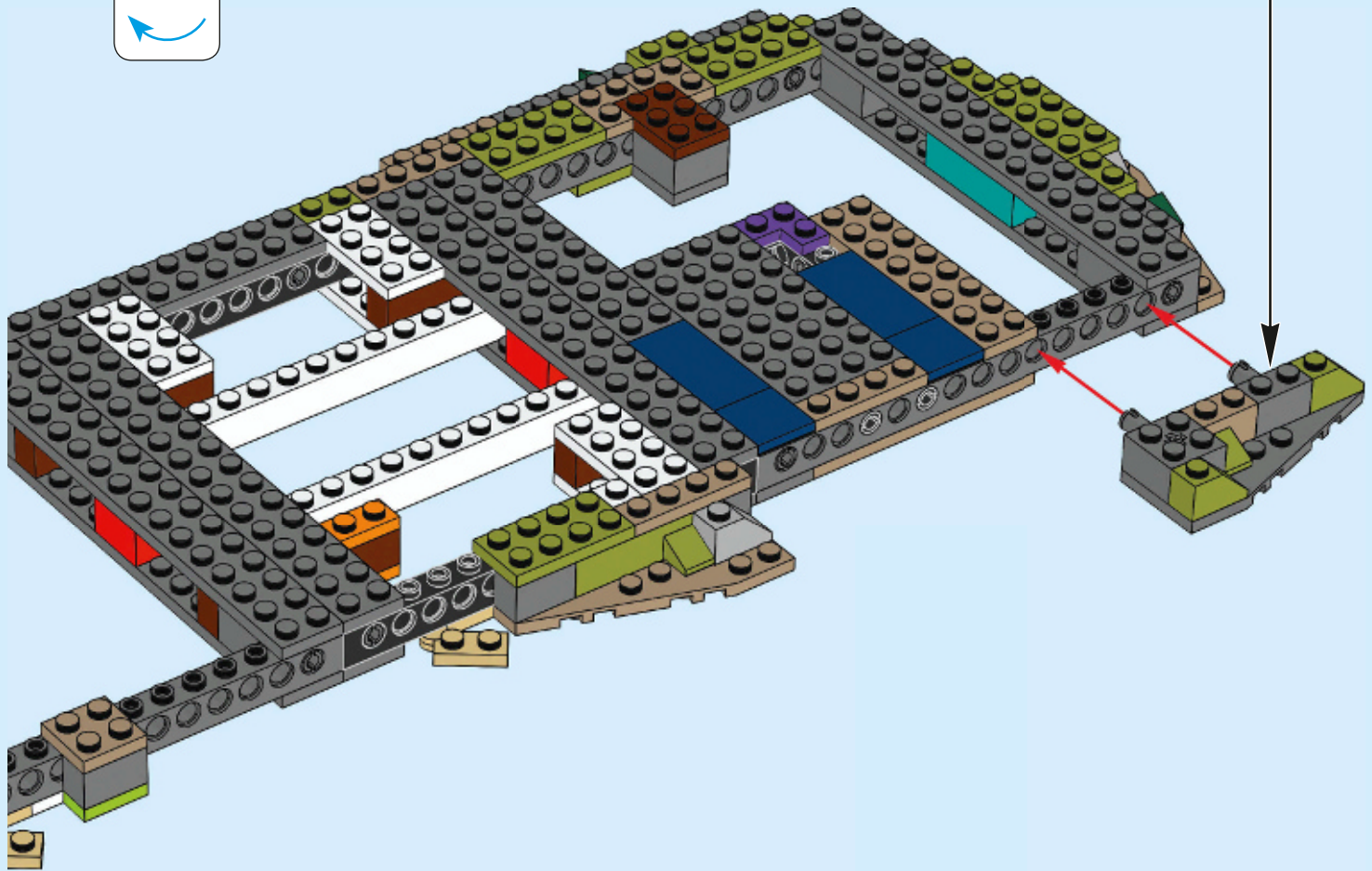
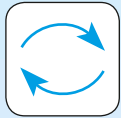
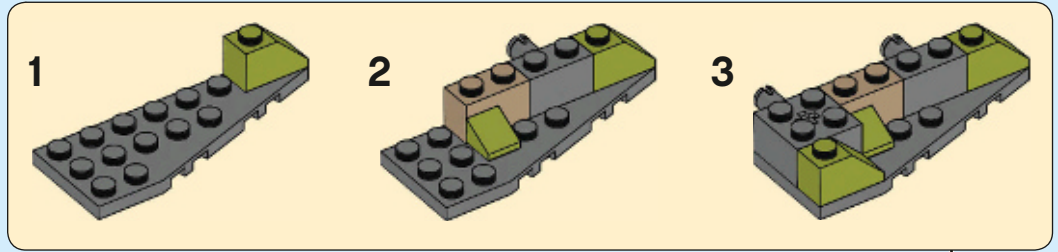

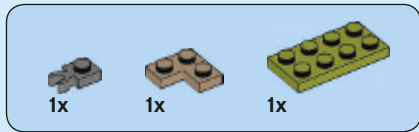

72

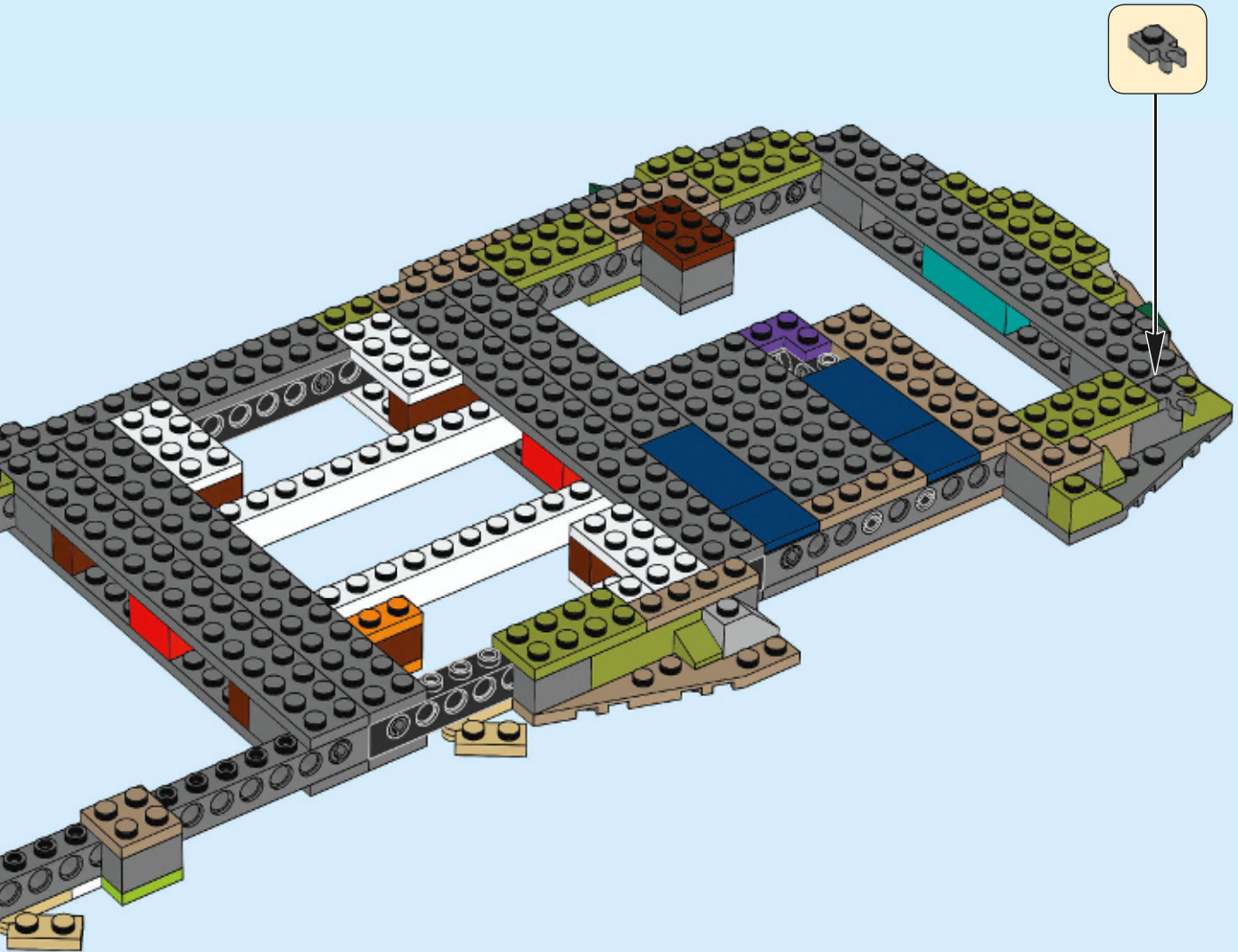

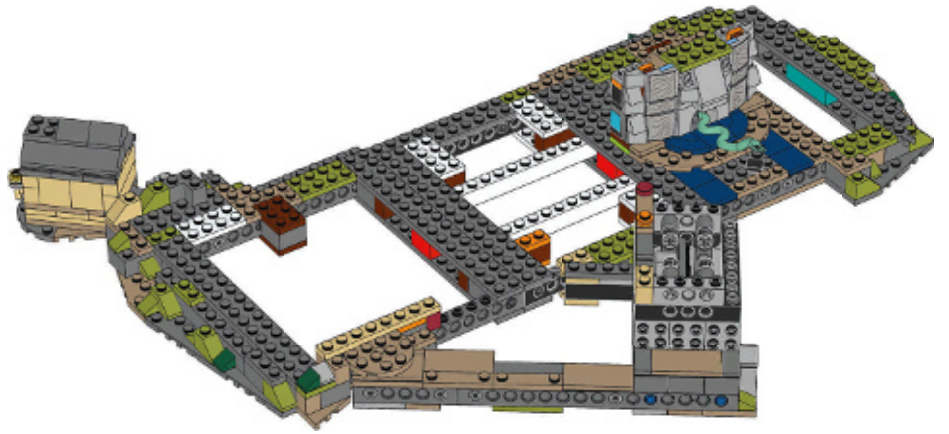

1x



2x



1x

73

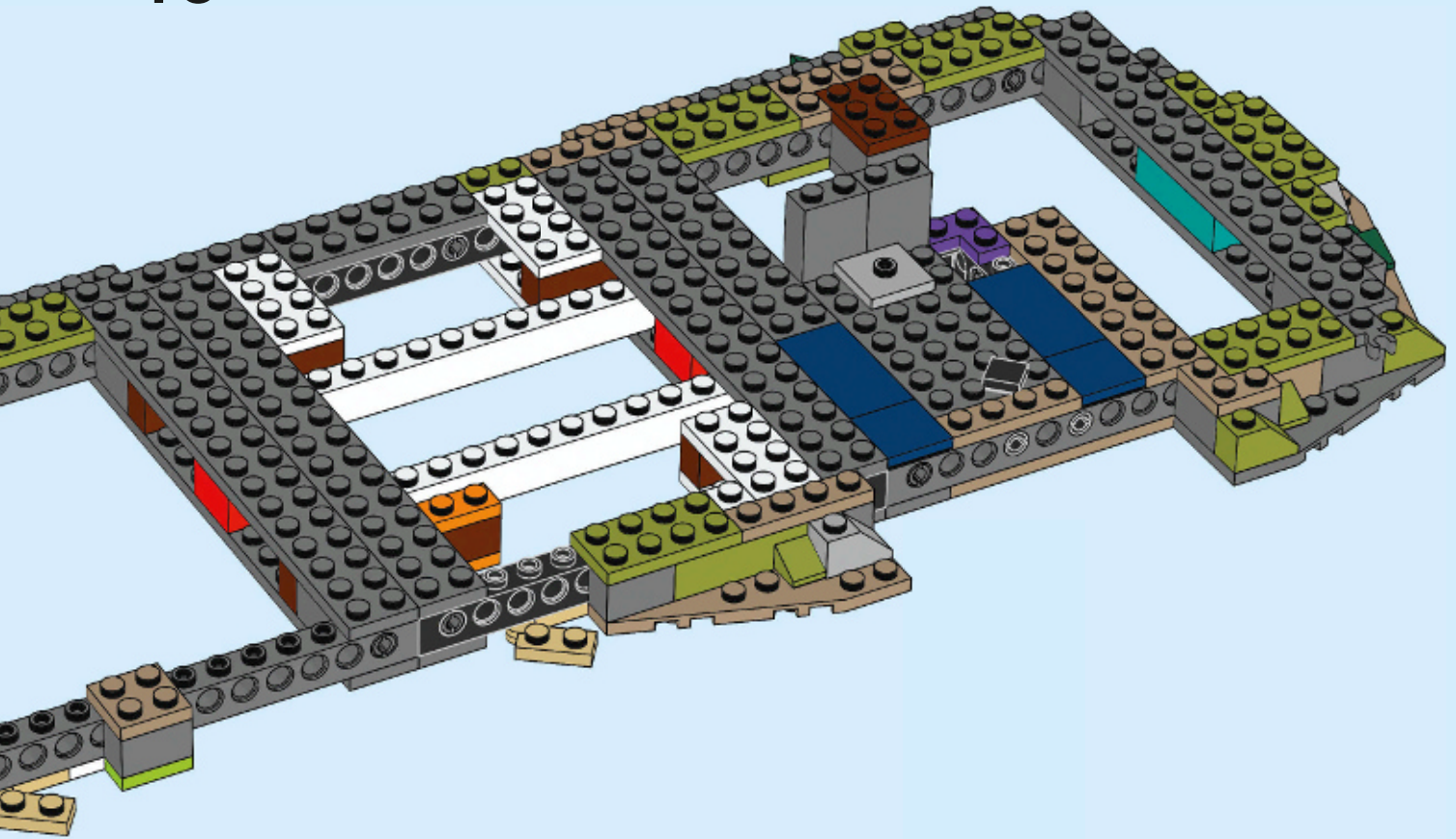



74



75



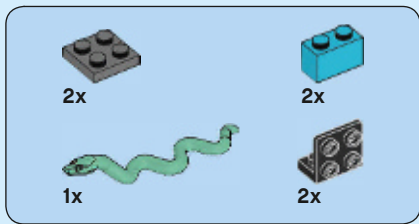

76

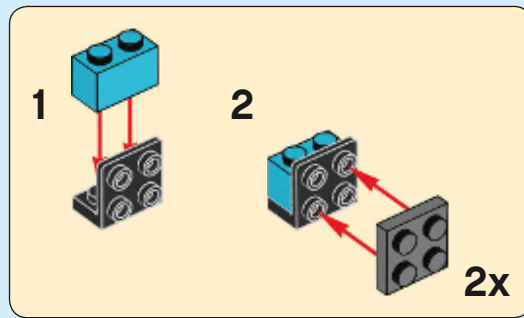

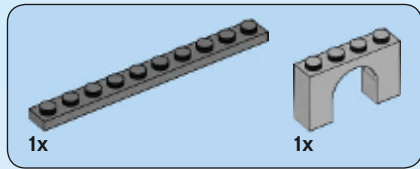

77

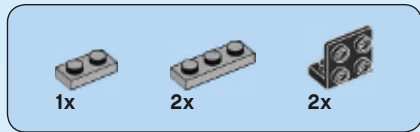
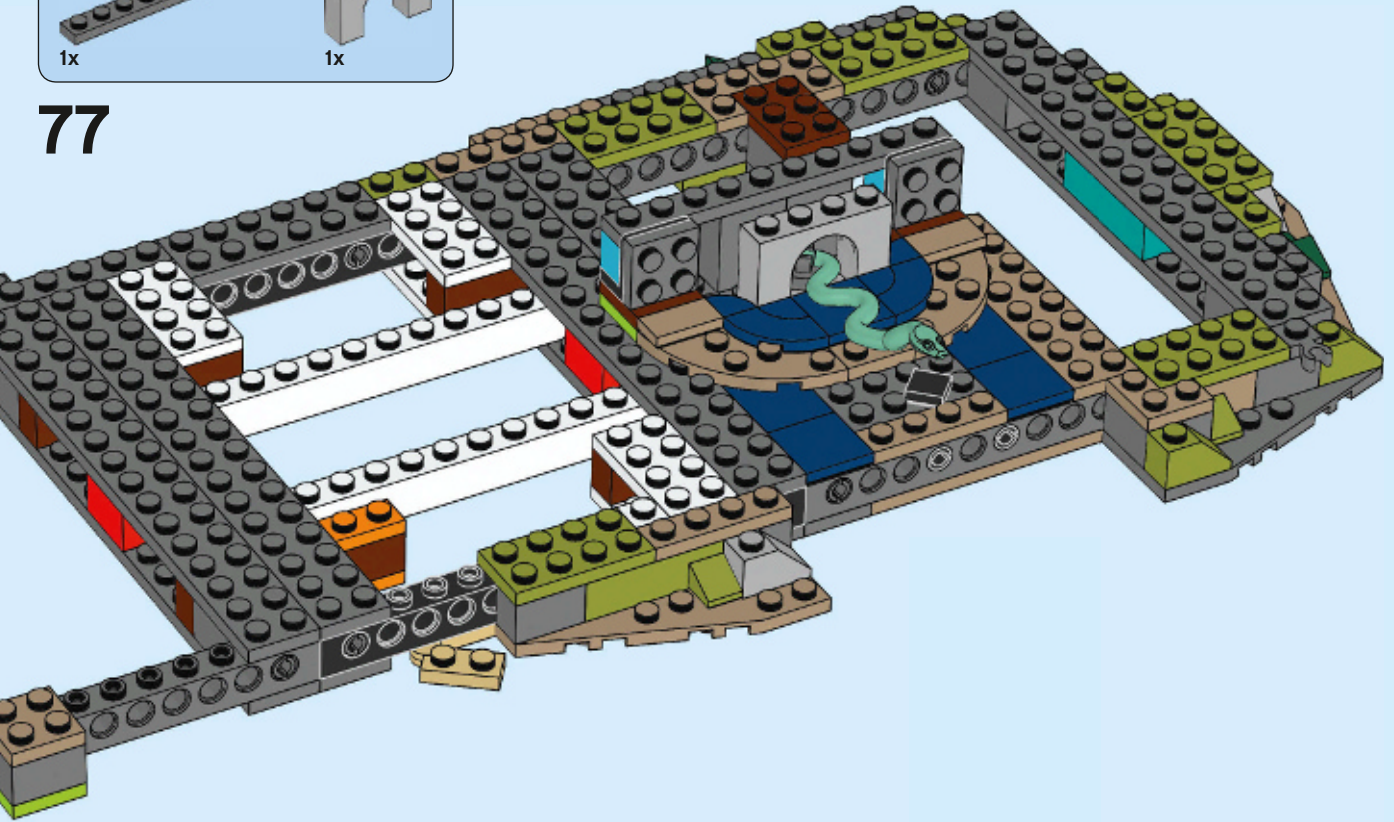

78

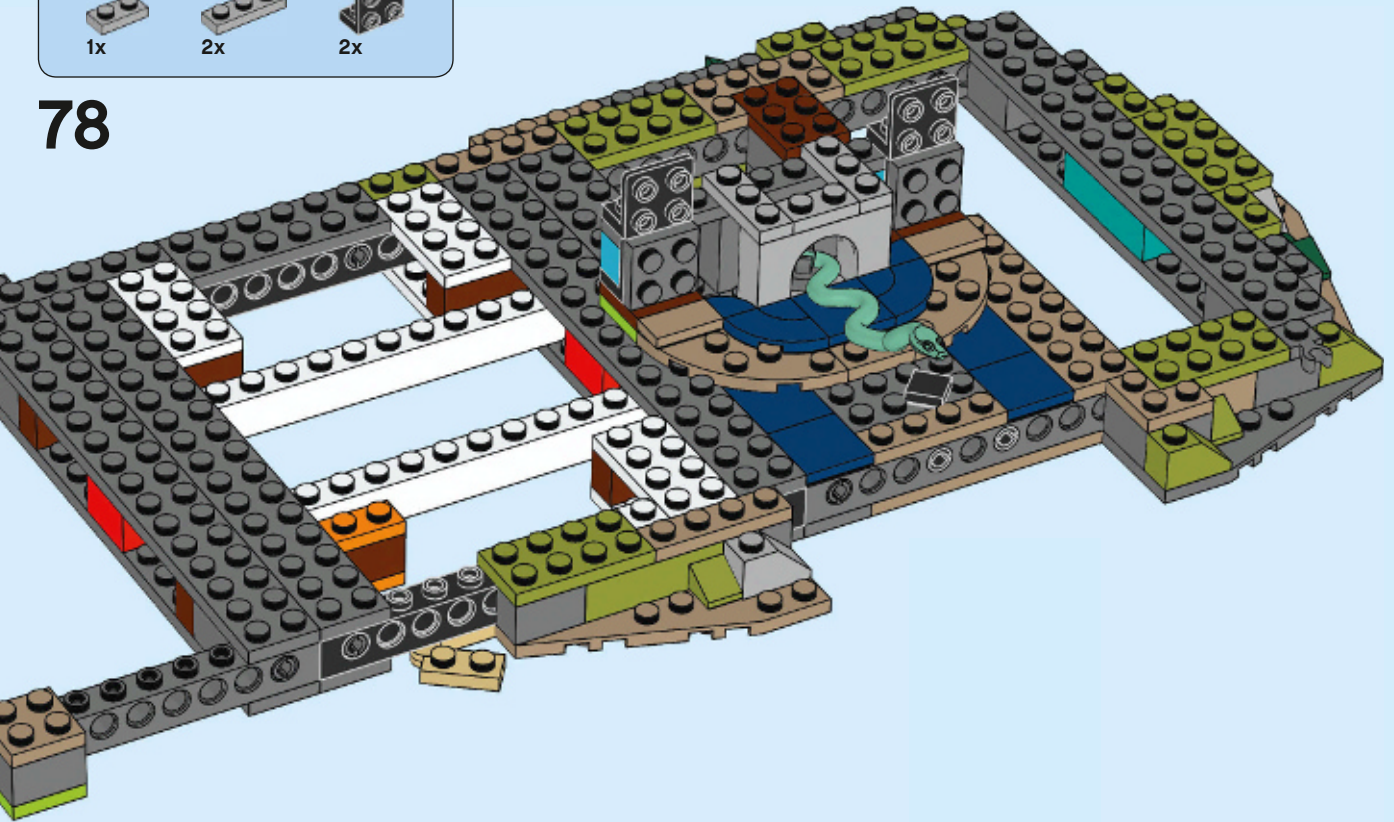

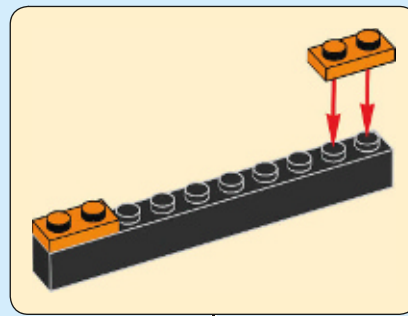
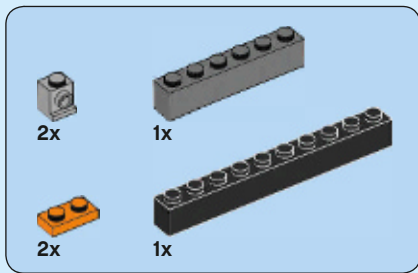

79



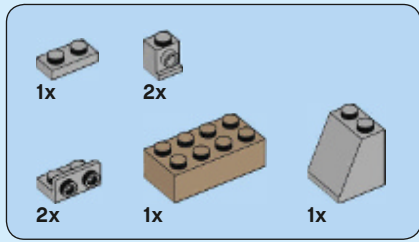

80

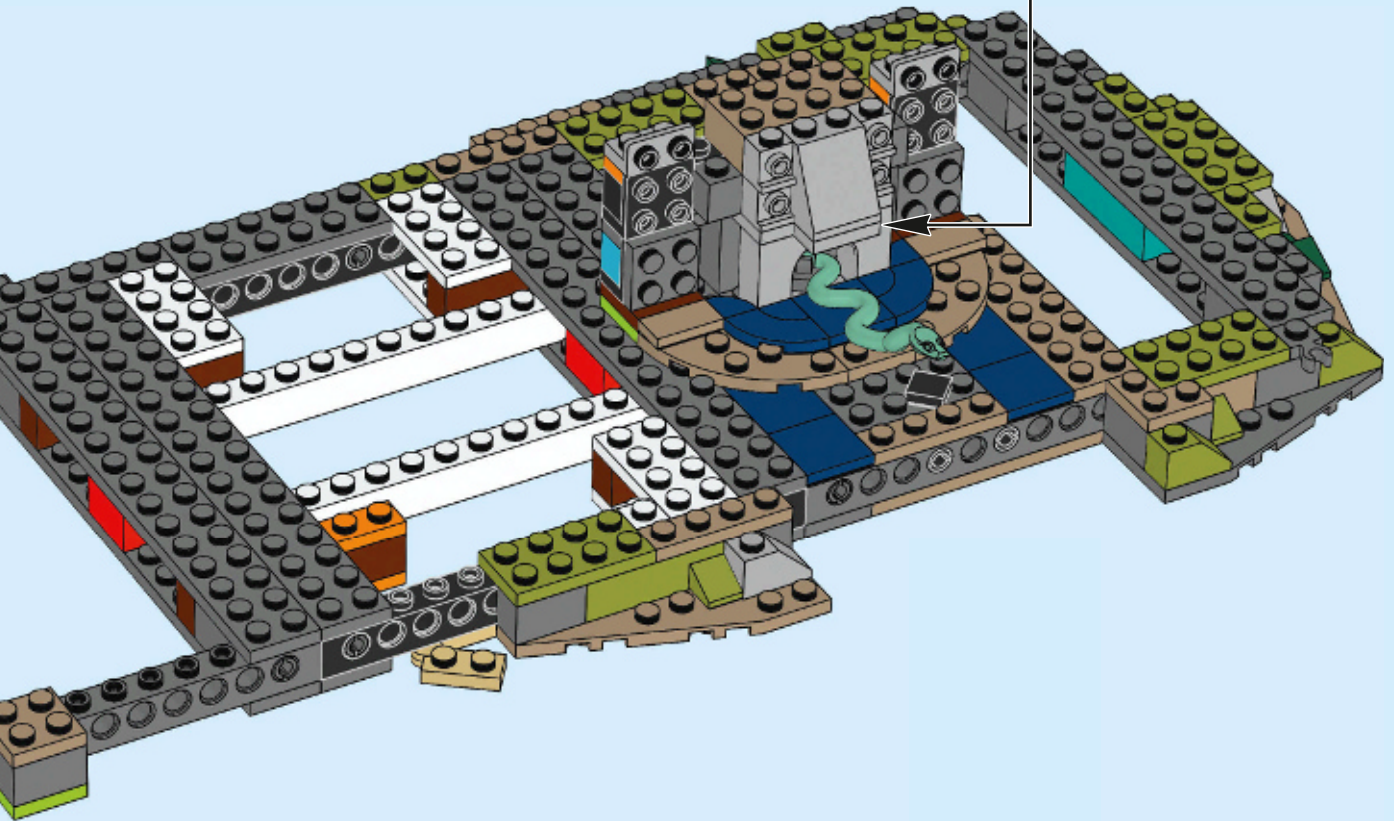
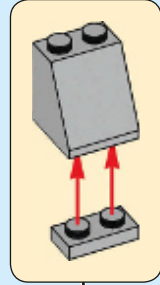

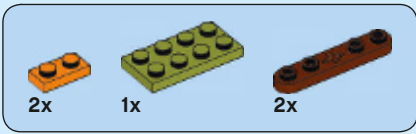

81

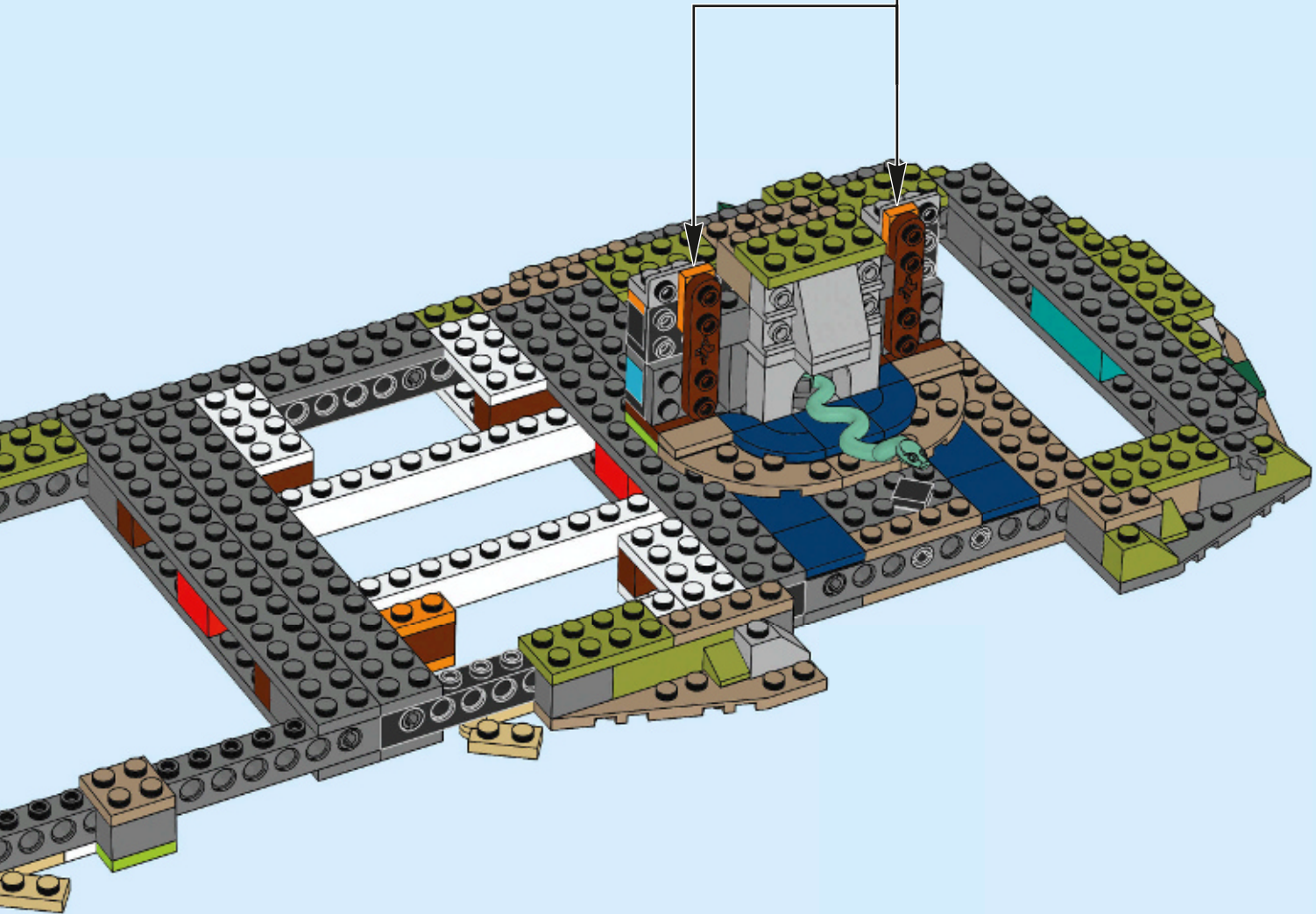
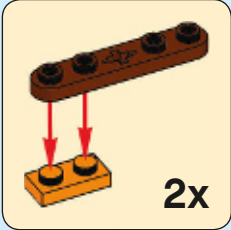



82

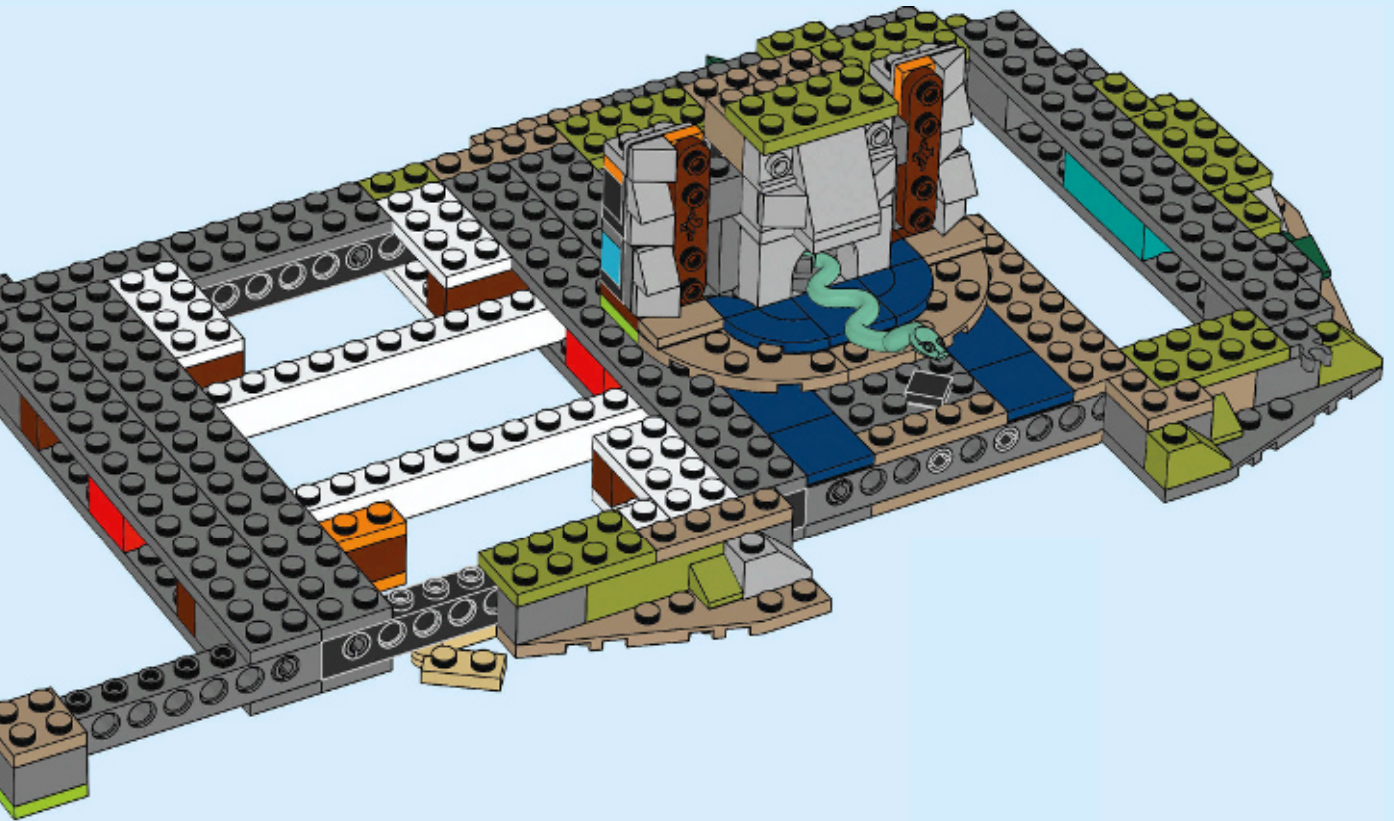

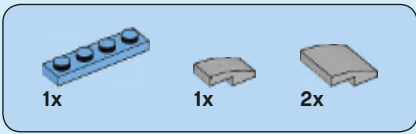

83

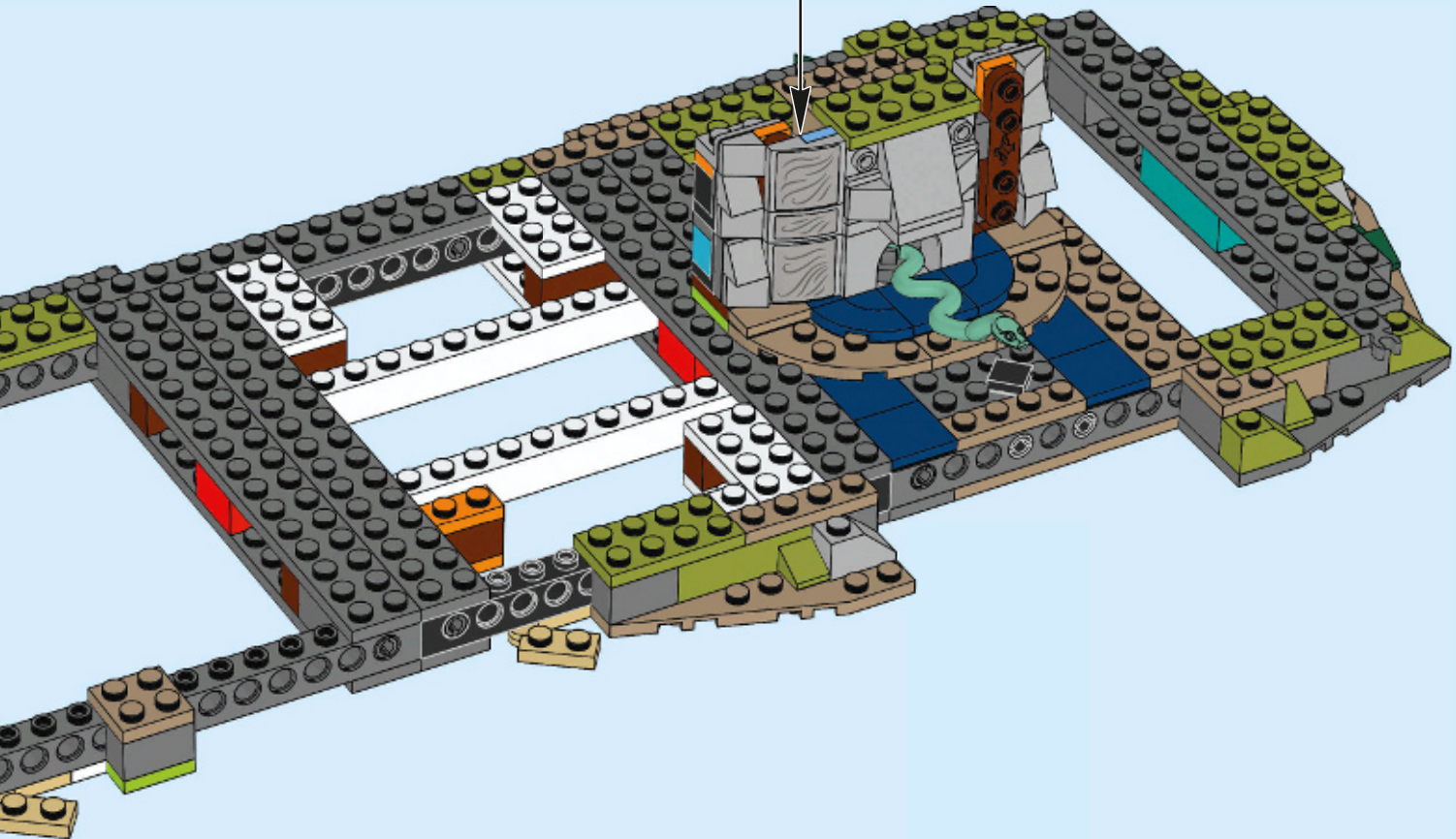
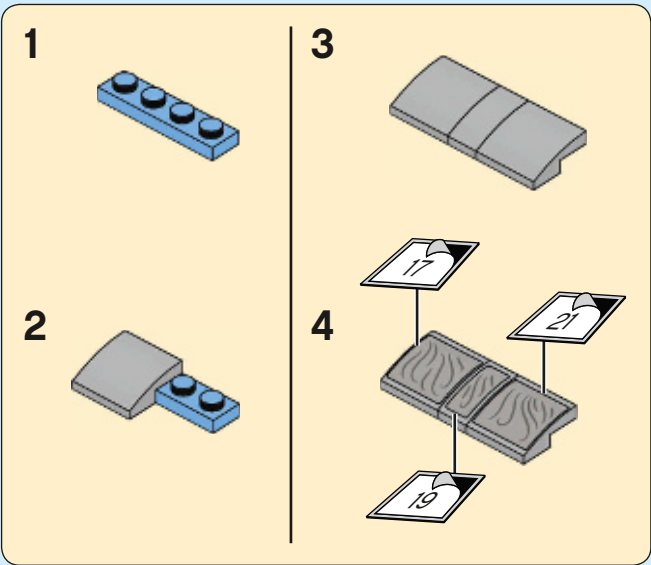

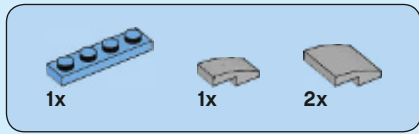

84

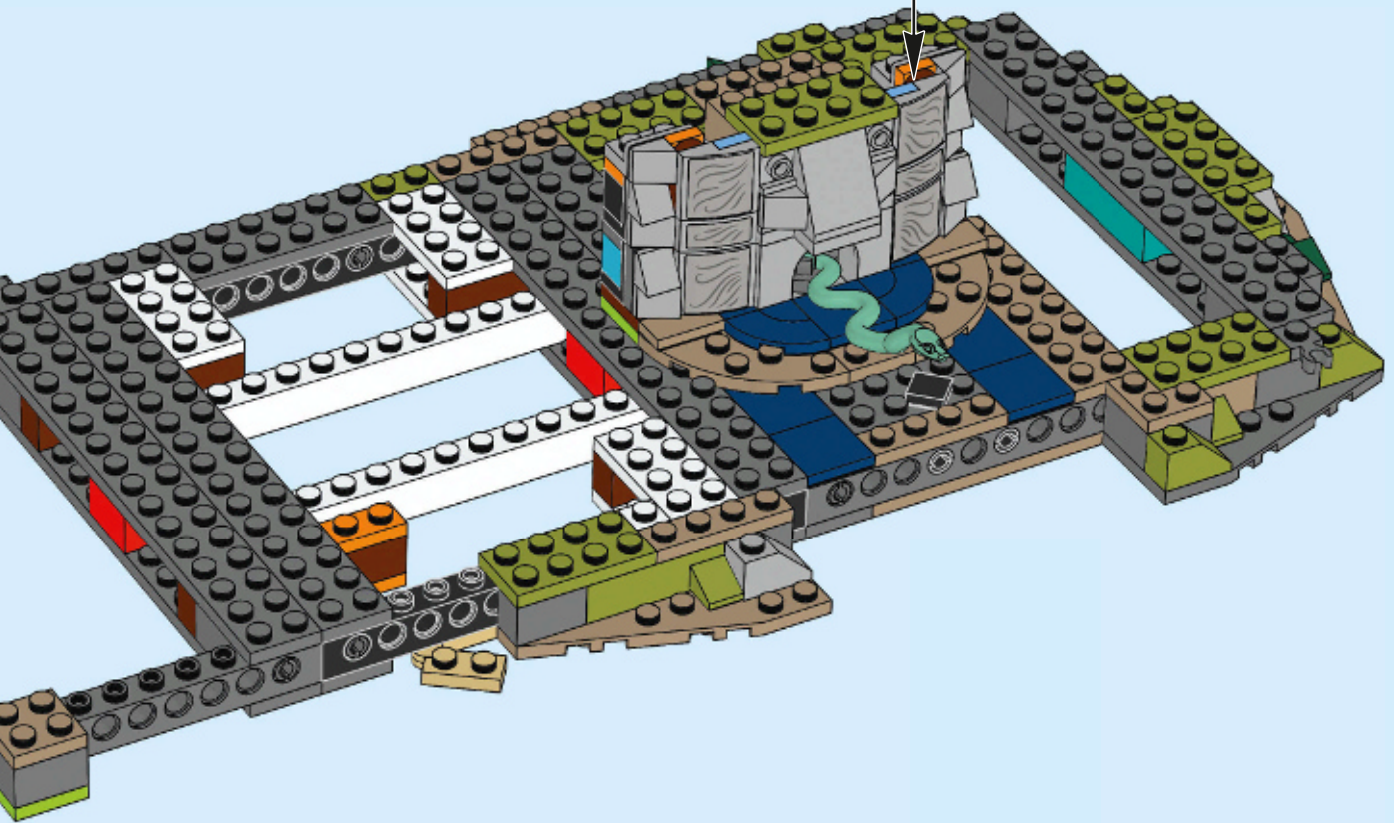
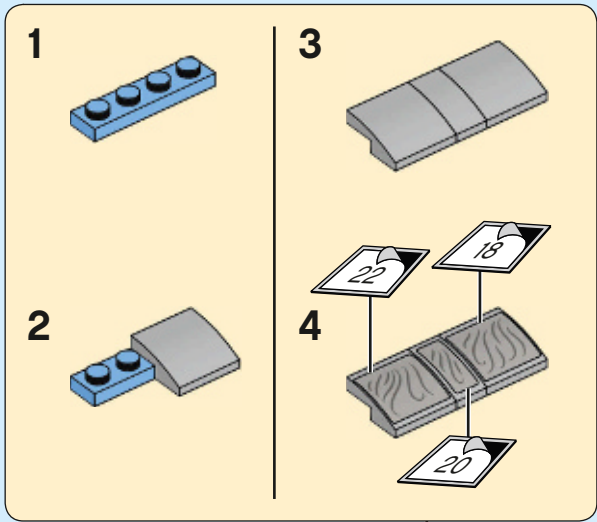

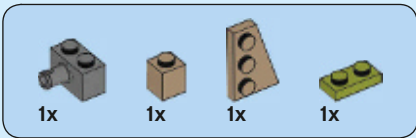

85

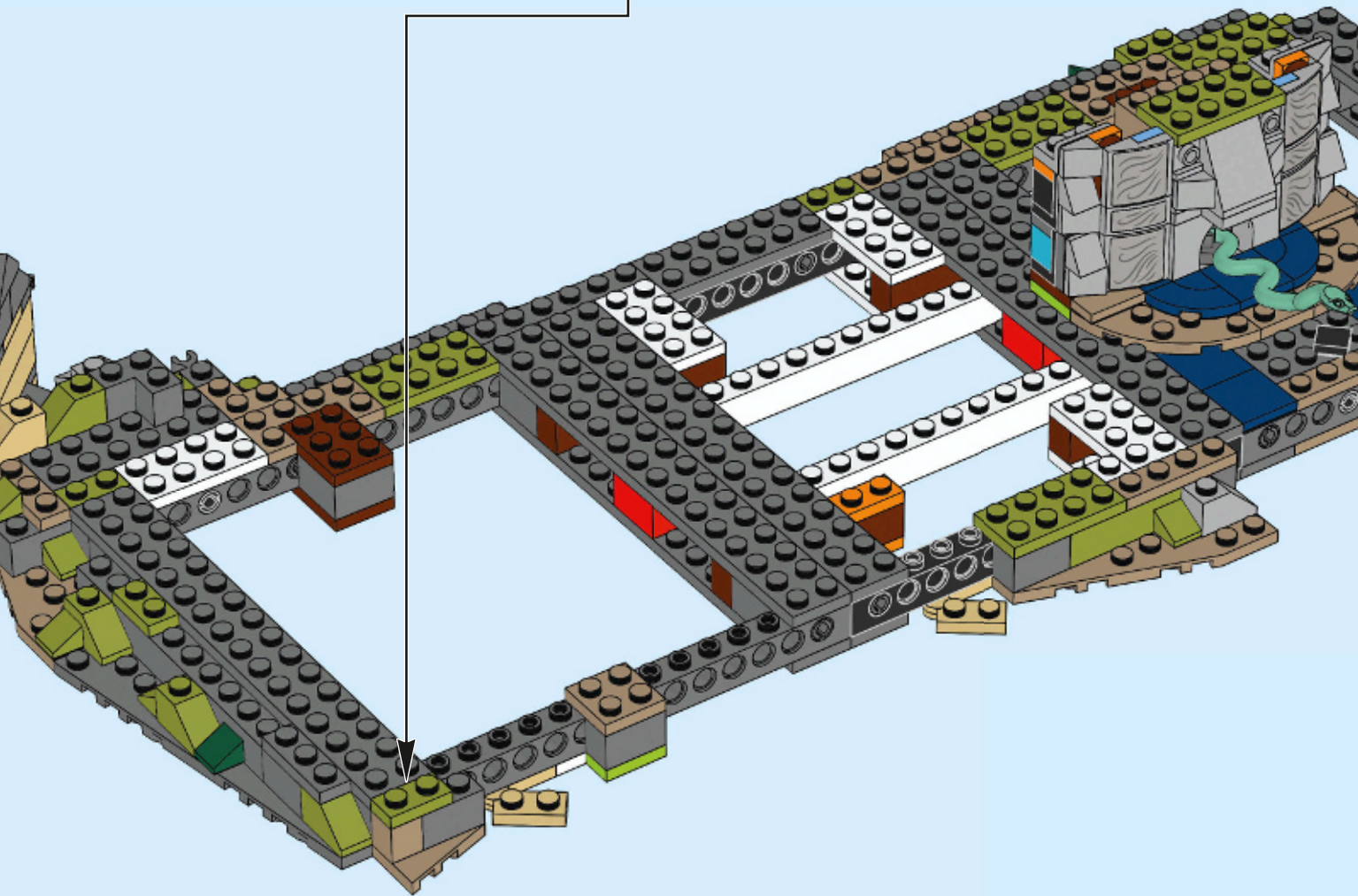
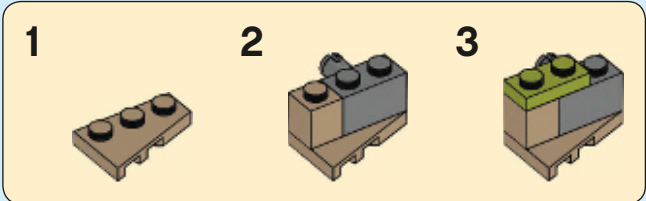

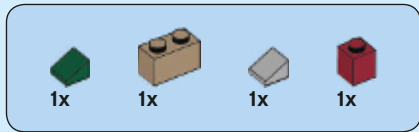

86

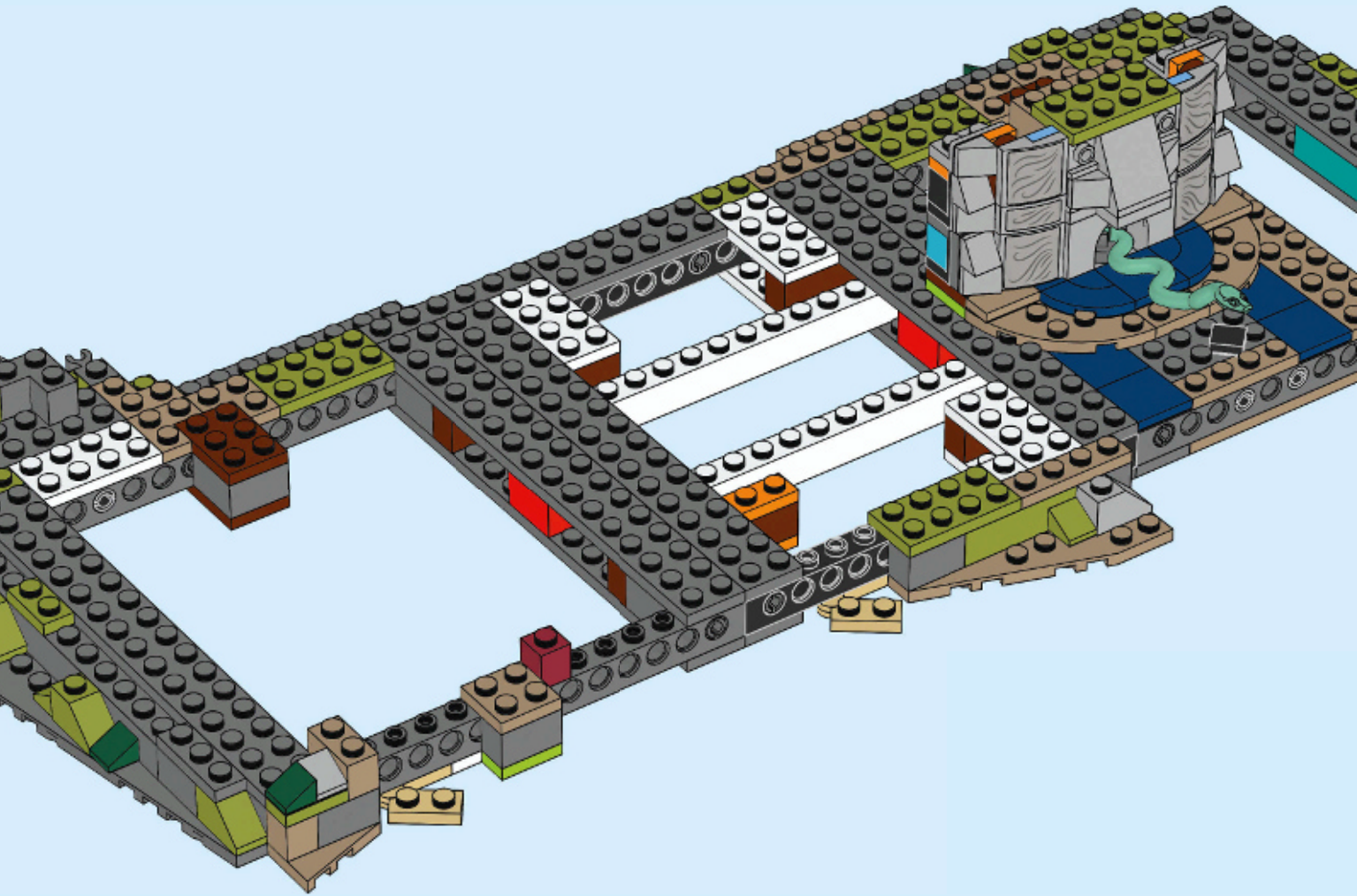

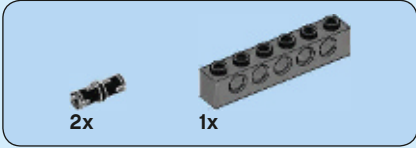
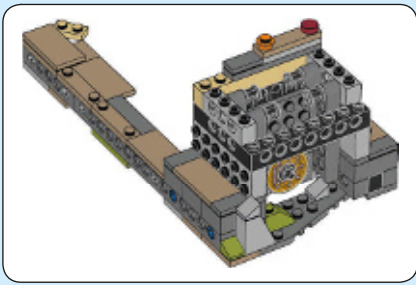

87

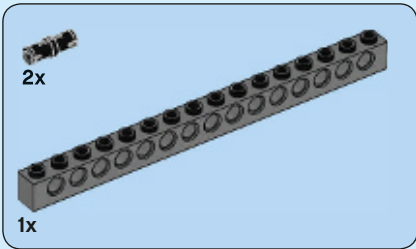
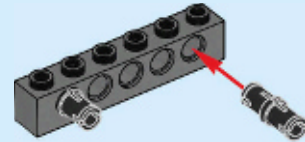

88

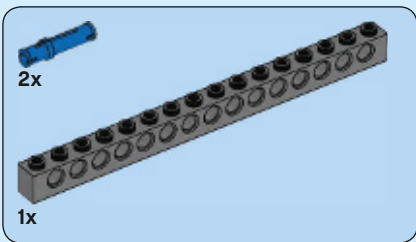
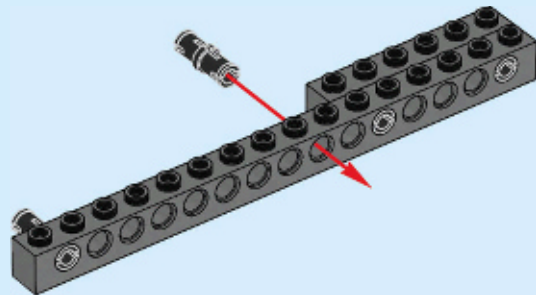

89

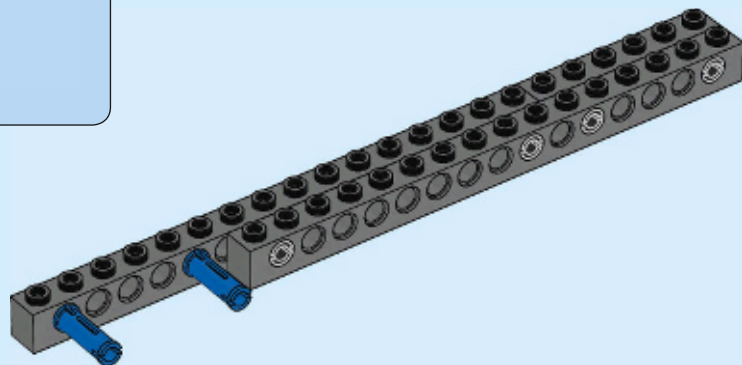

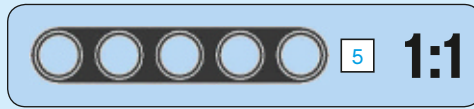
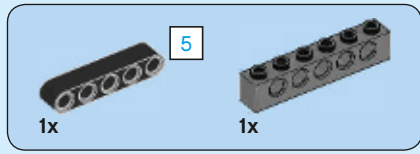

90

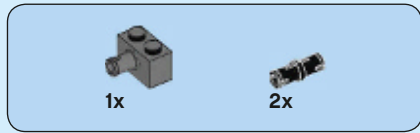
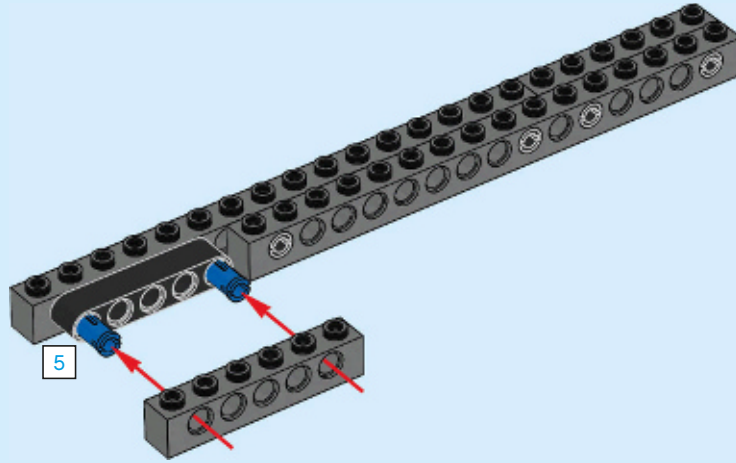

91

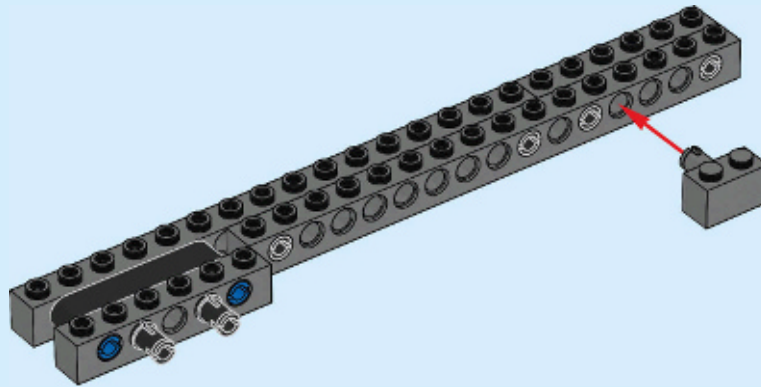

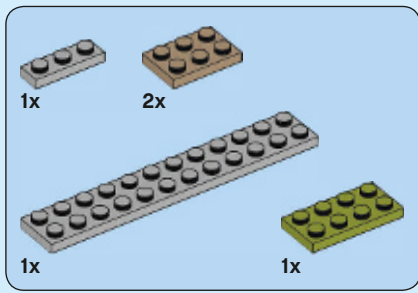

92

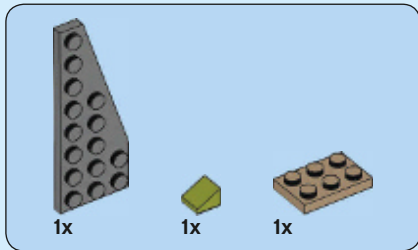
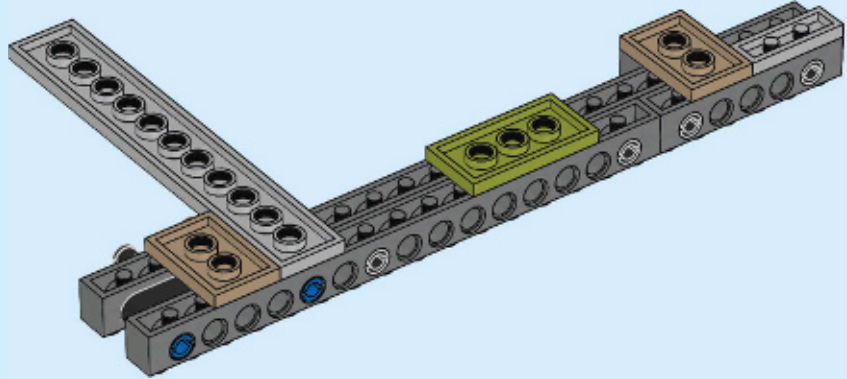
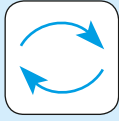

93

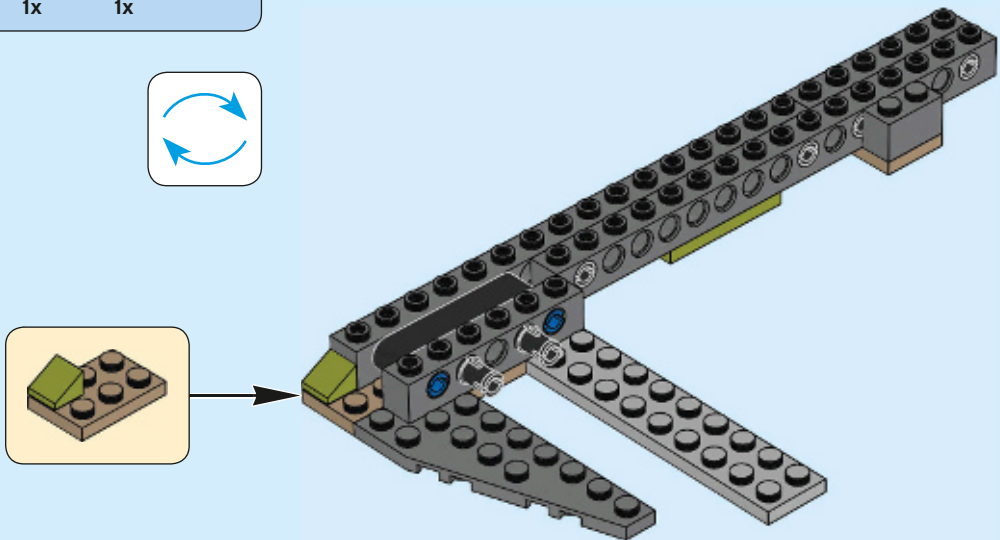
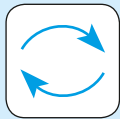

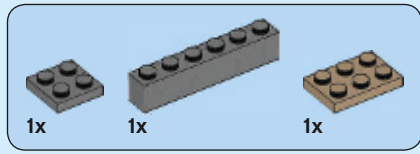

94

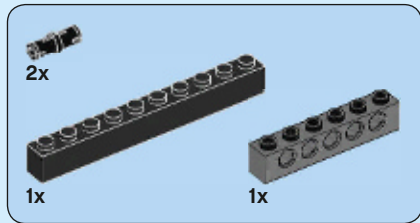
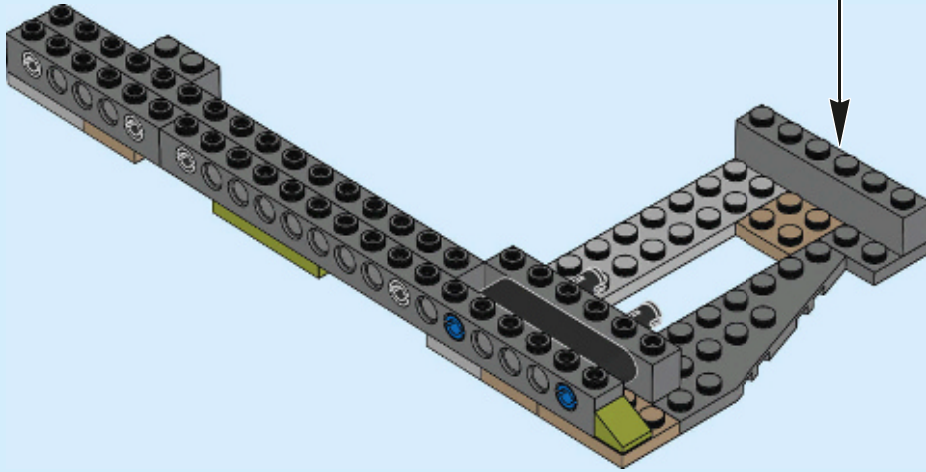
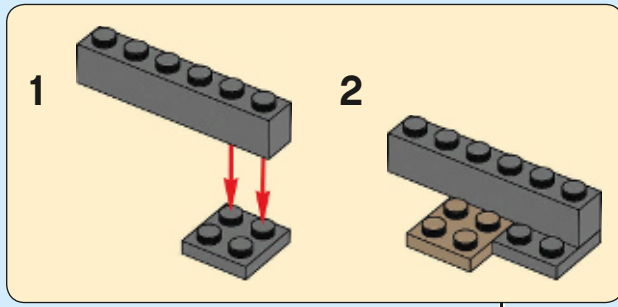
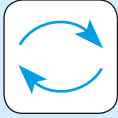

95

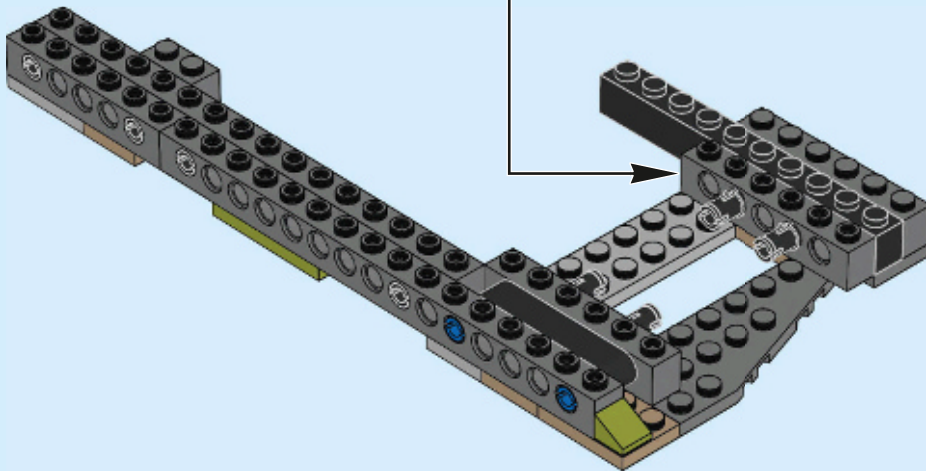
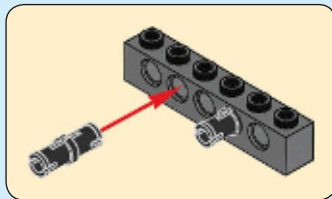

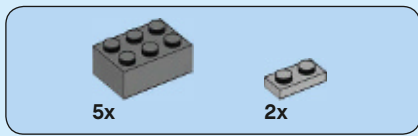

96

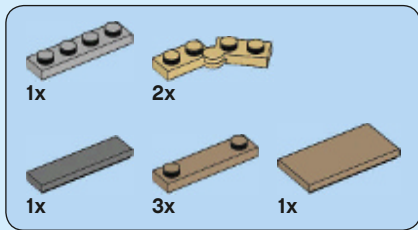
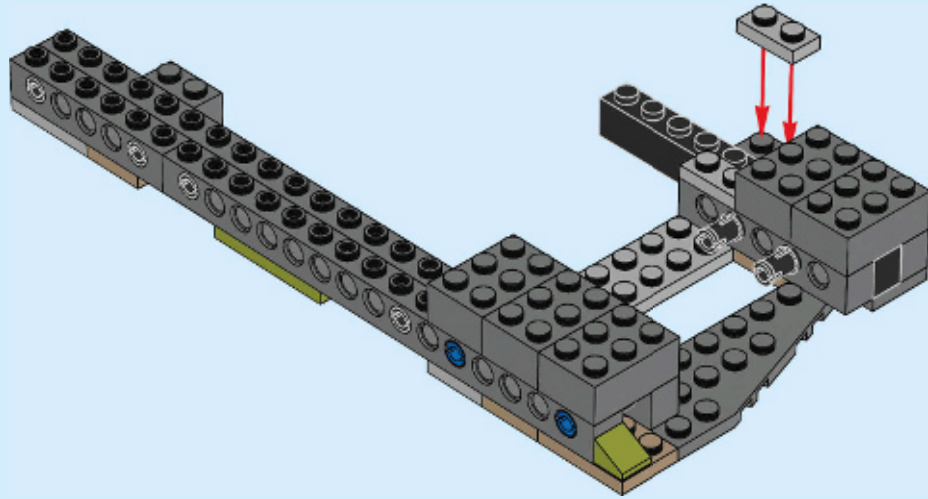

97

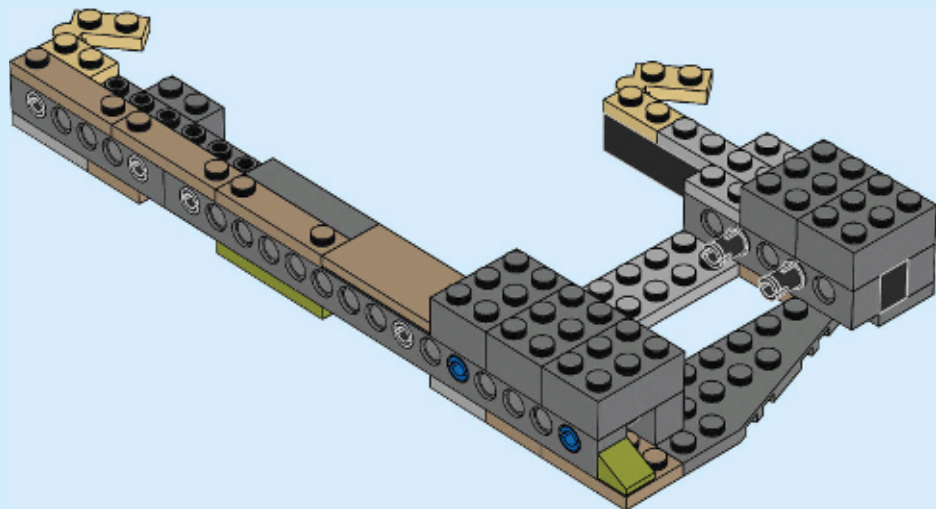

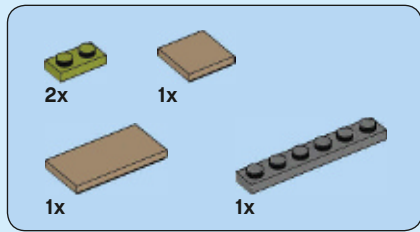

98

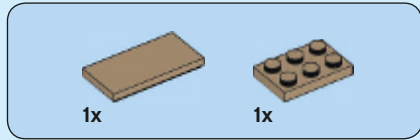
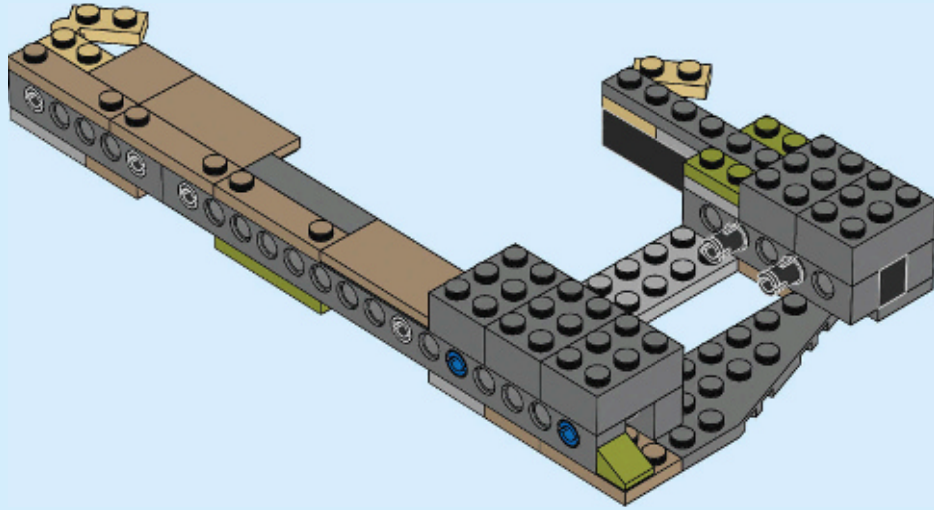

99

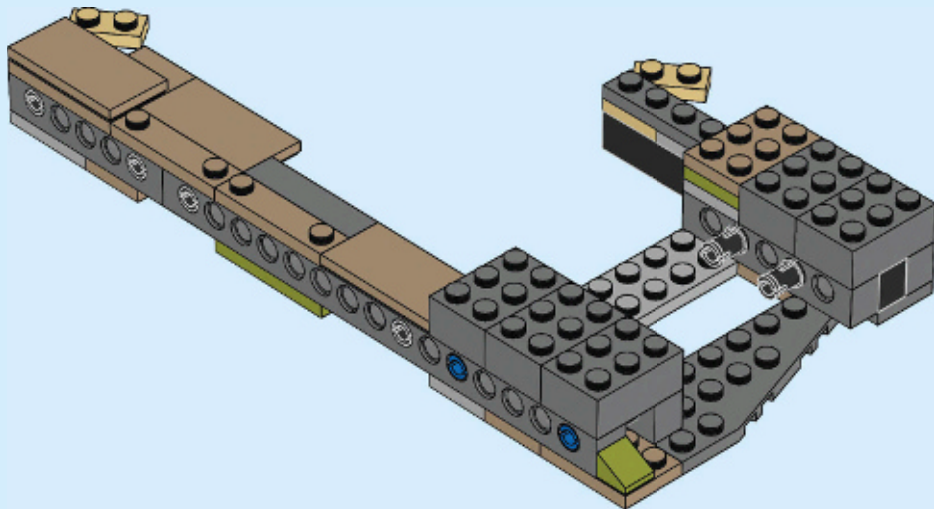

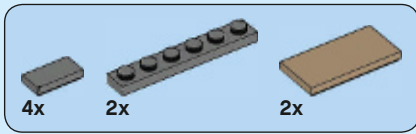

100

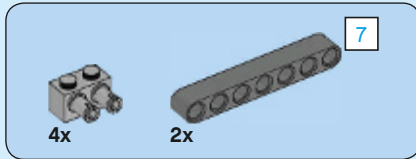
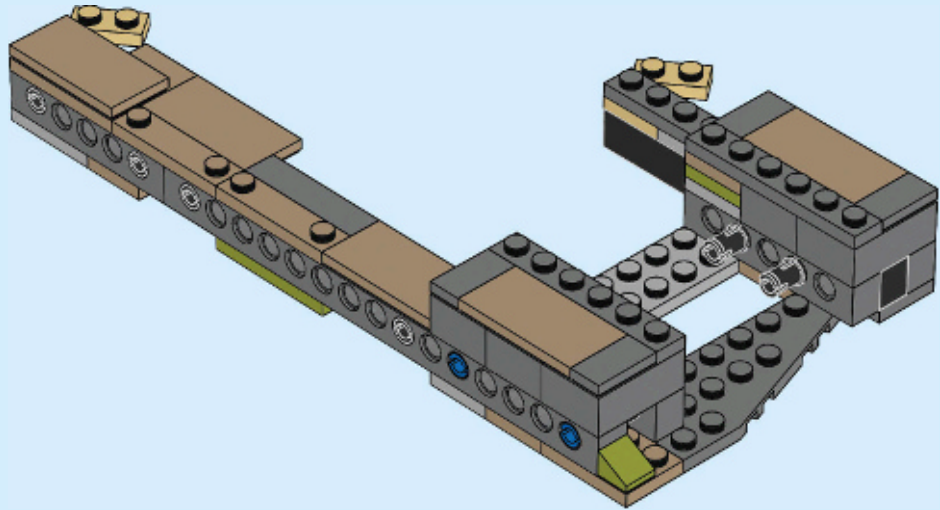

101

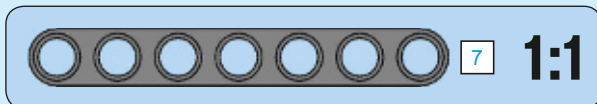
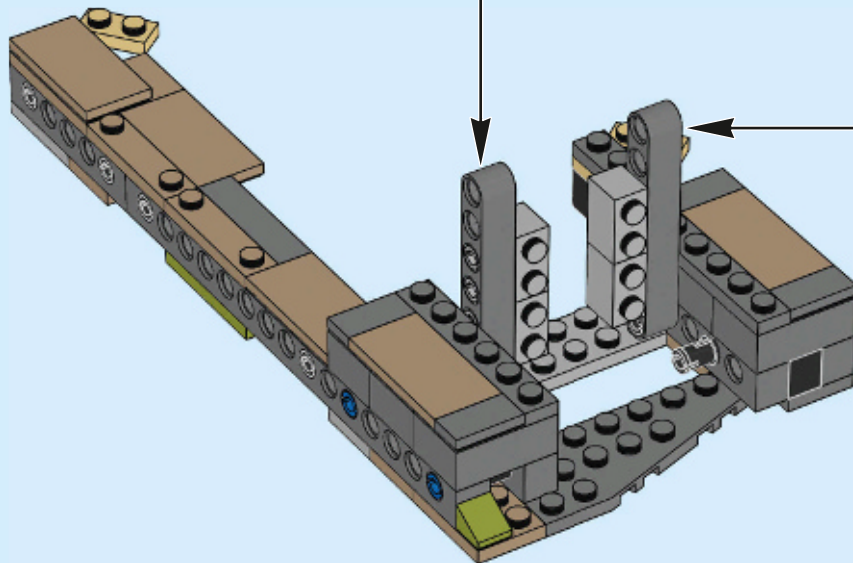
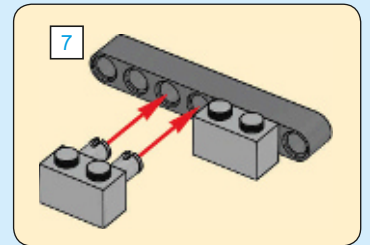
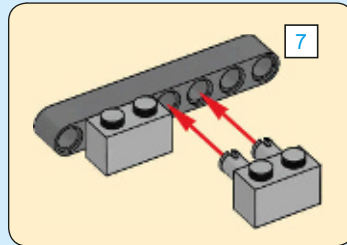

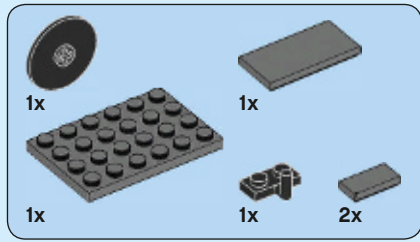

102

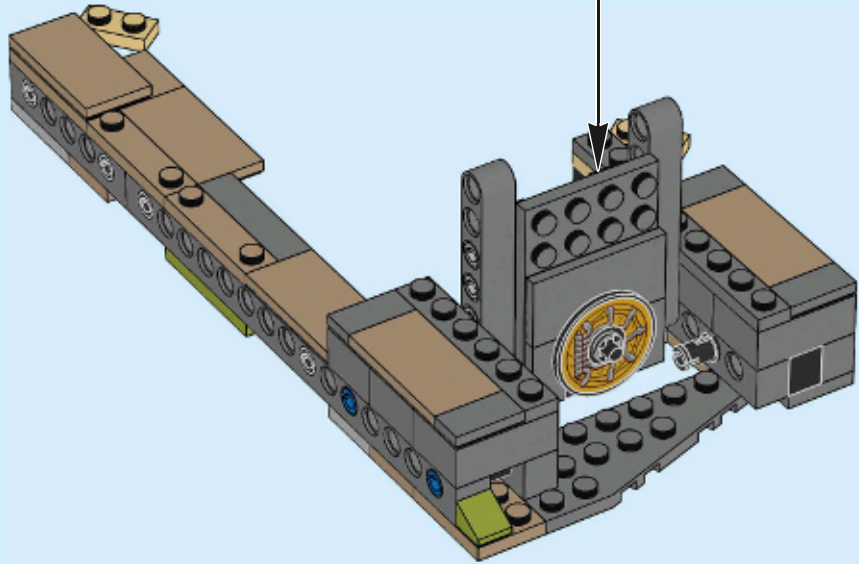
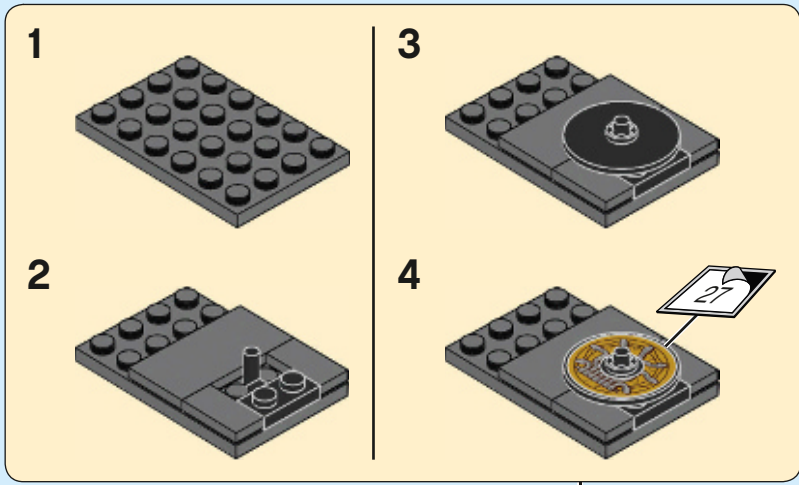

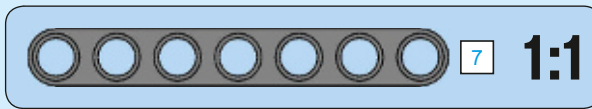
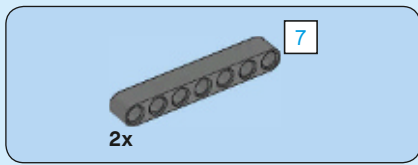

103

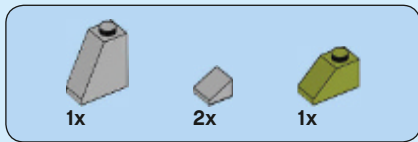
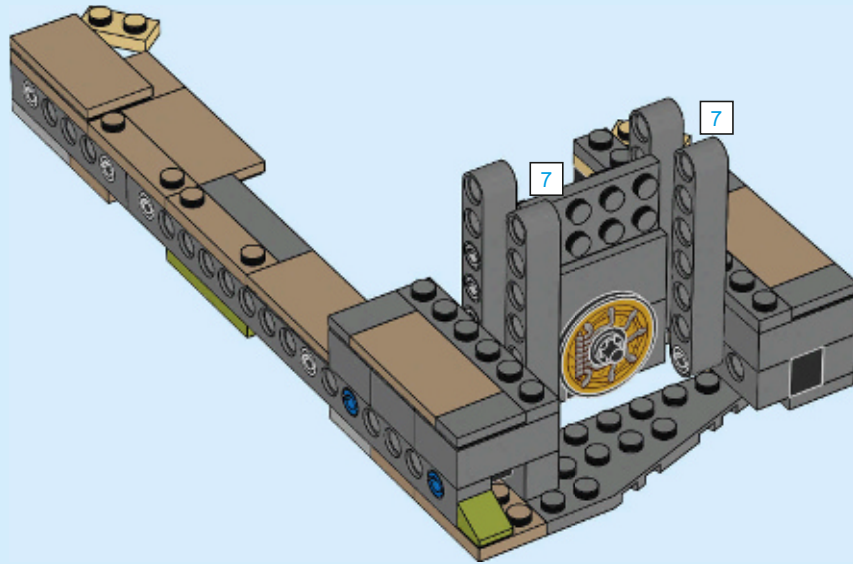

104

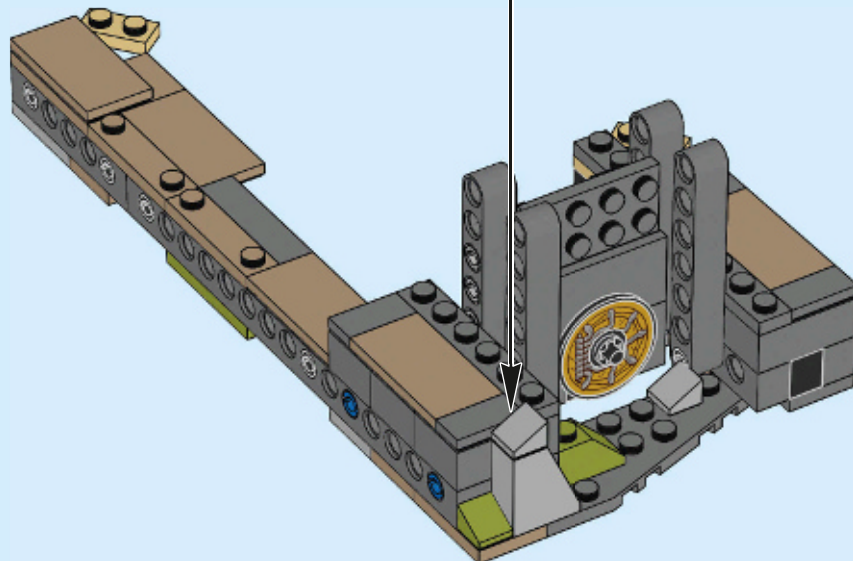
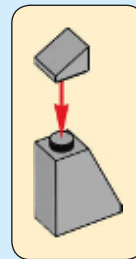



6x

105

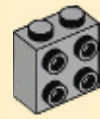
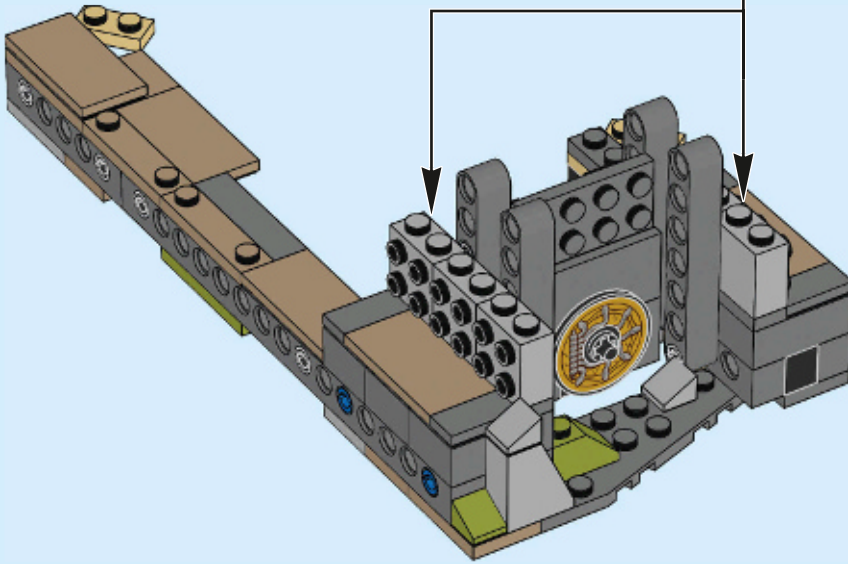

6x



1x

106

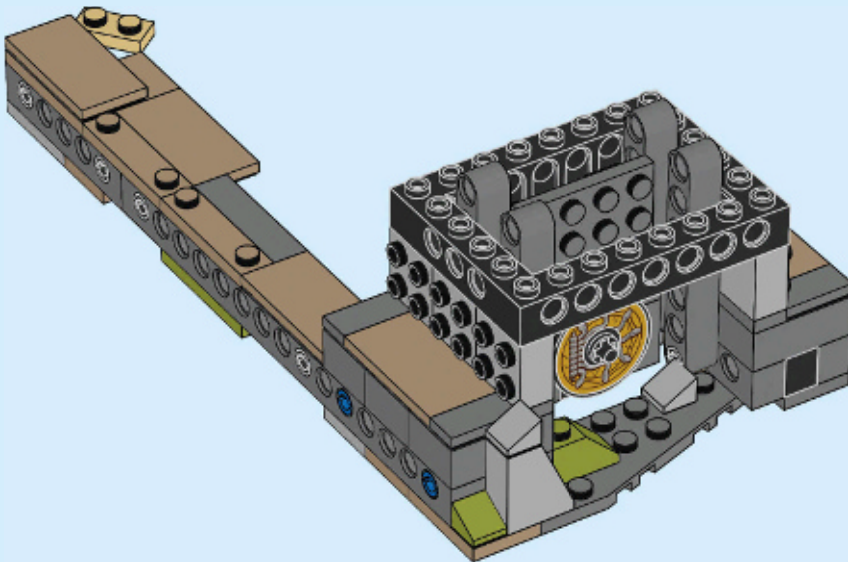

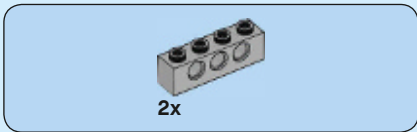

107

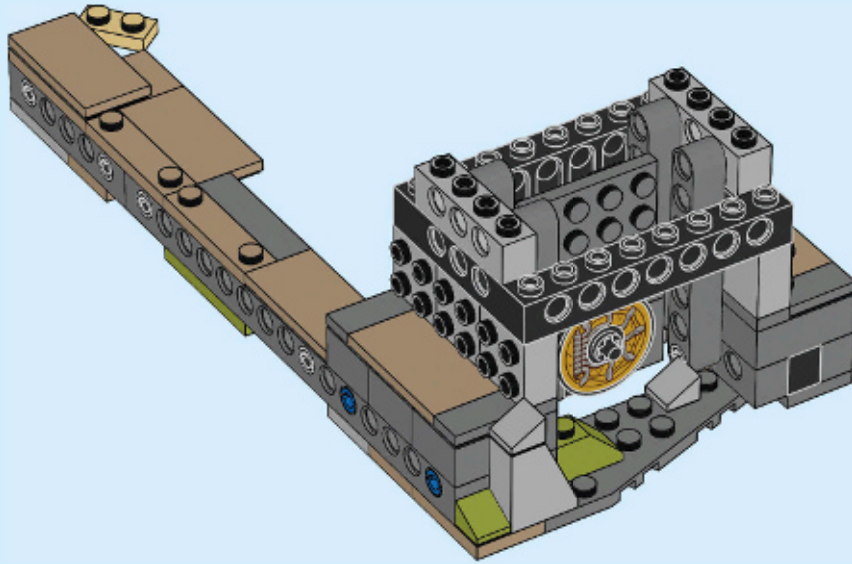

108

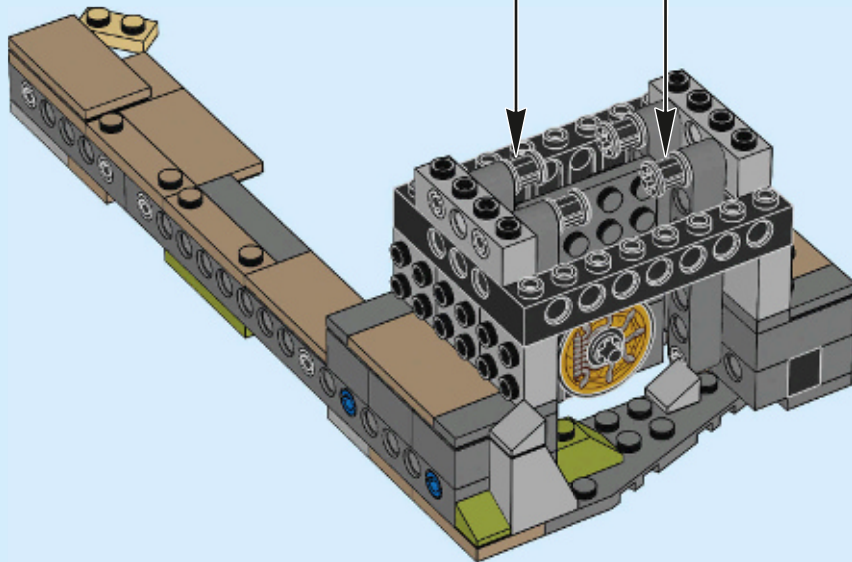

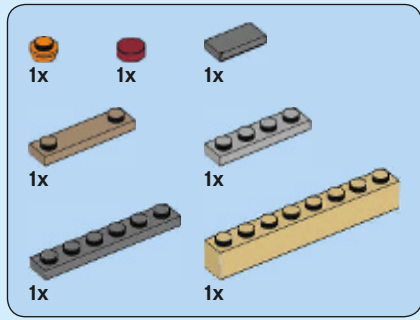

109

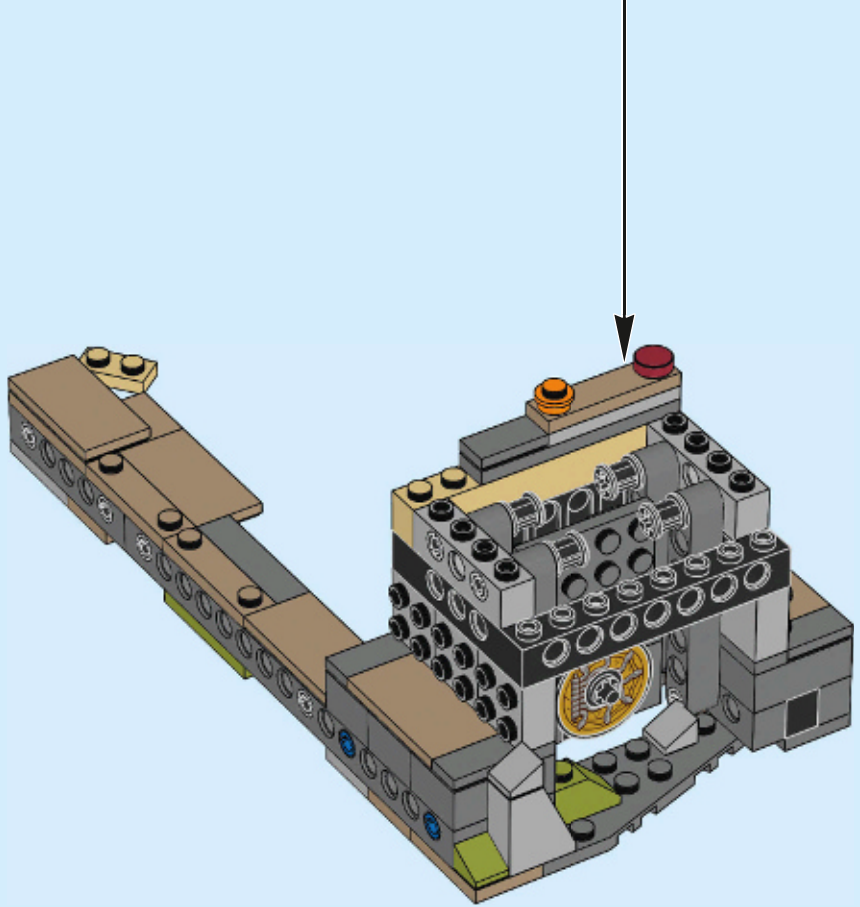
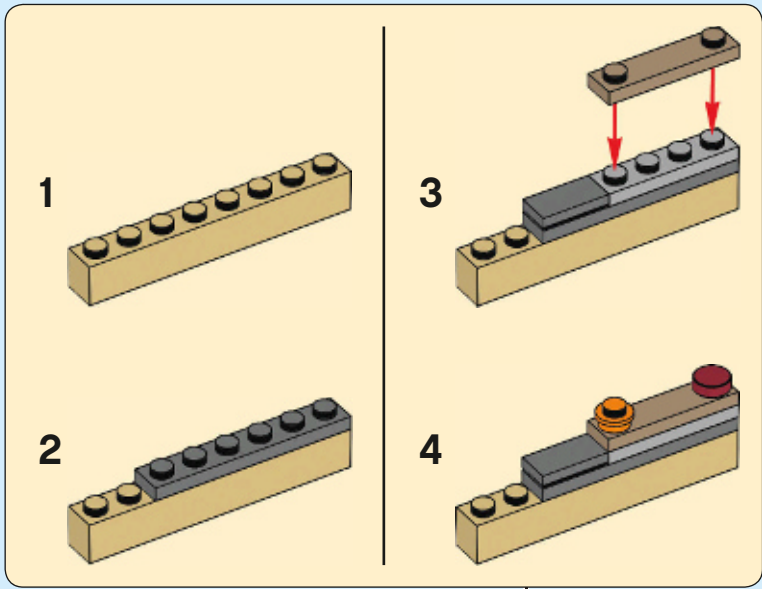

110

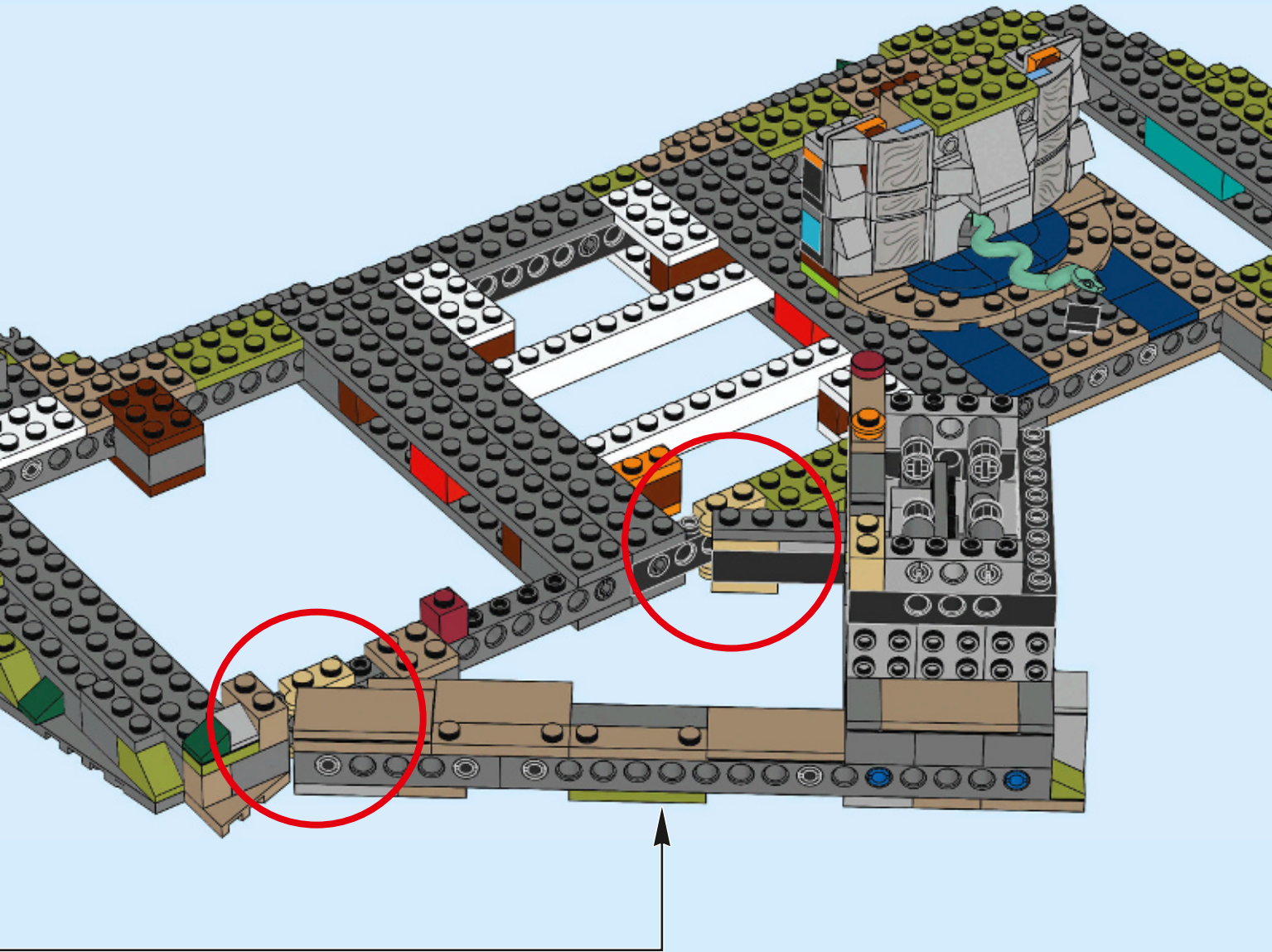

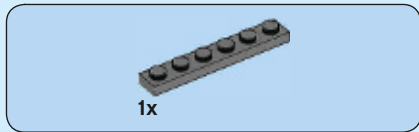

111

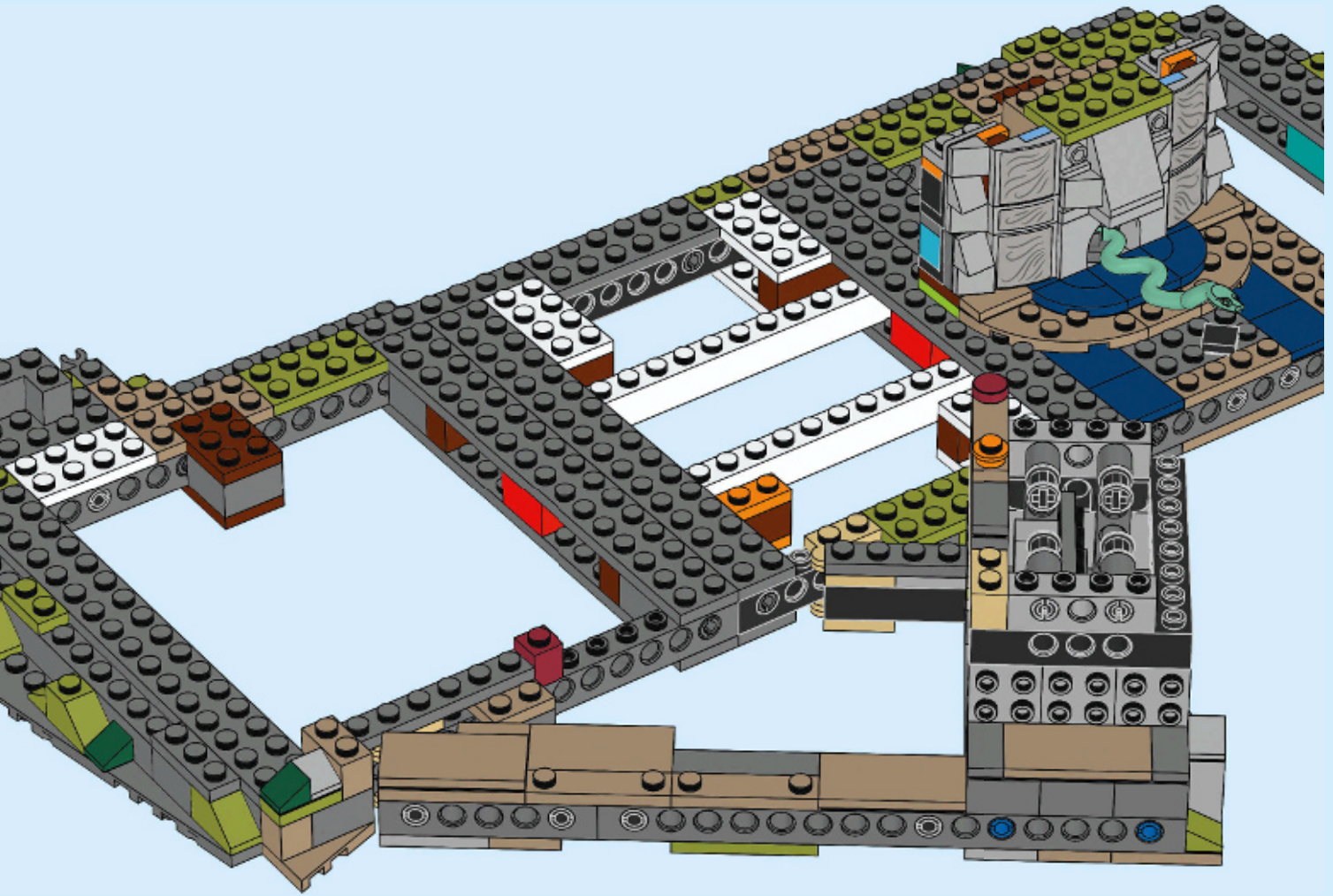

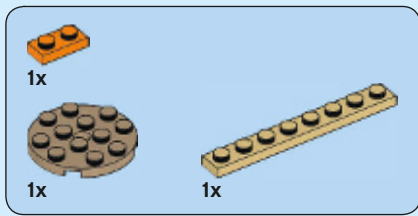

112

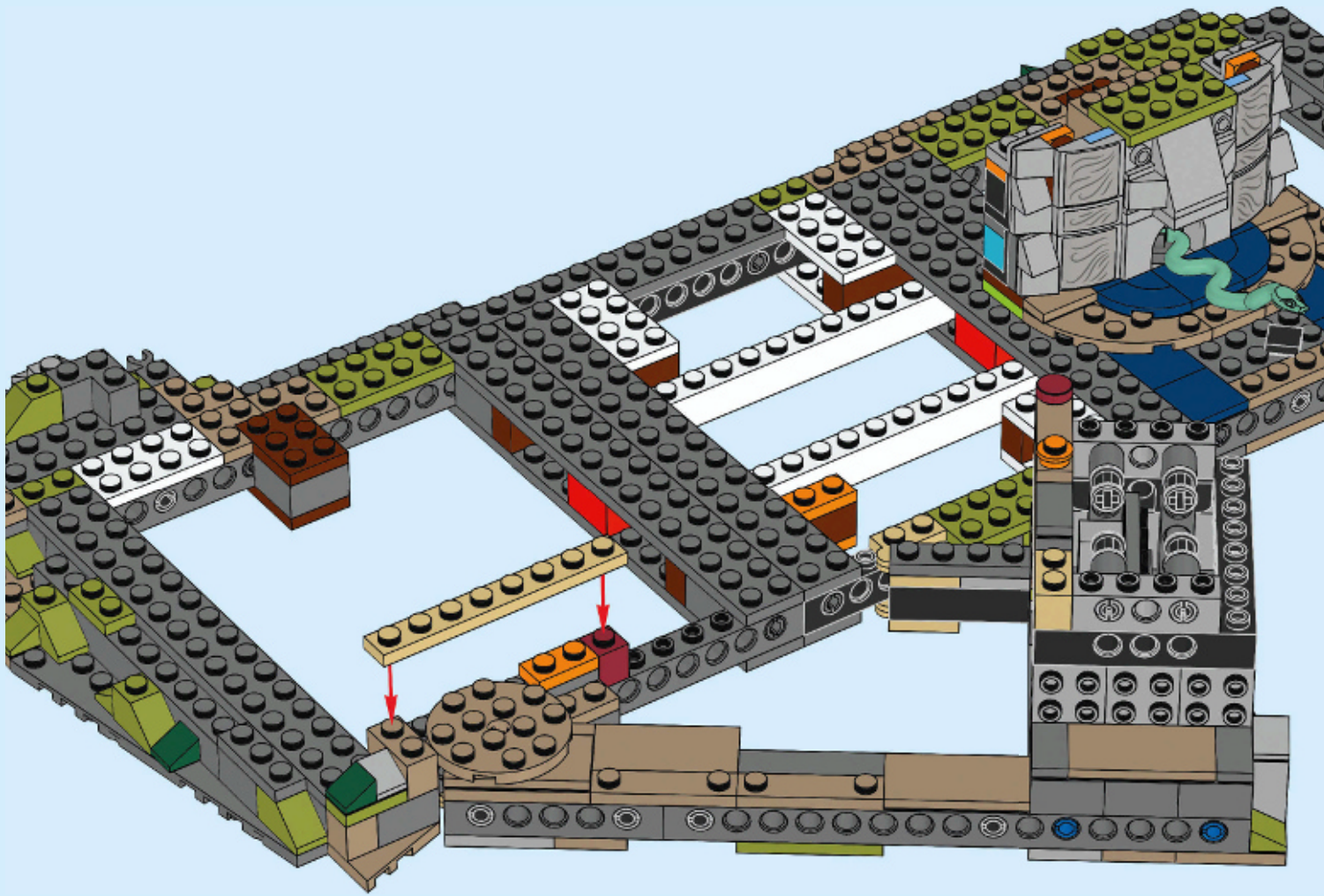

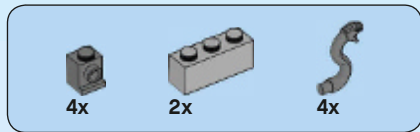
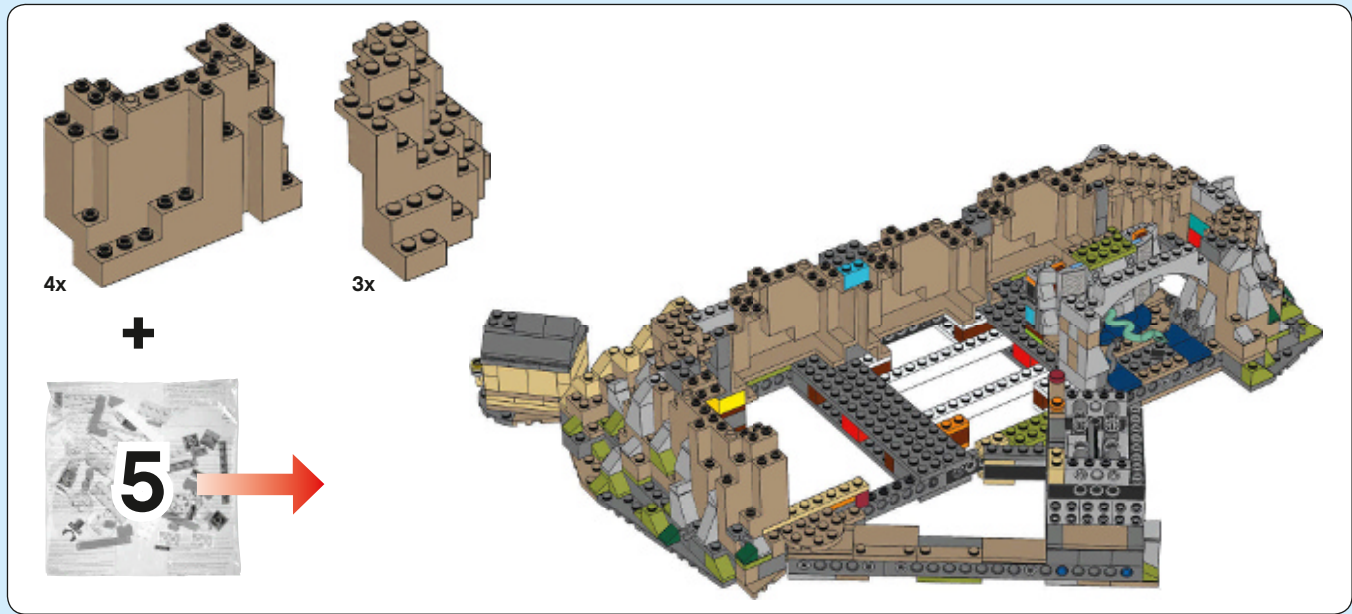

113

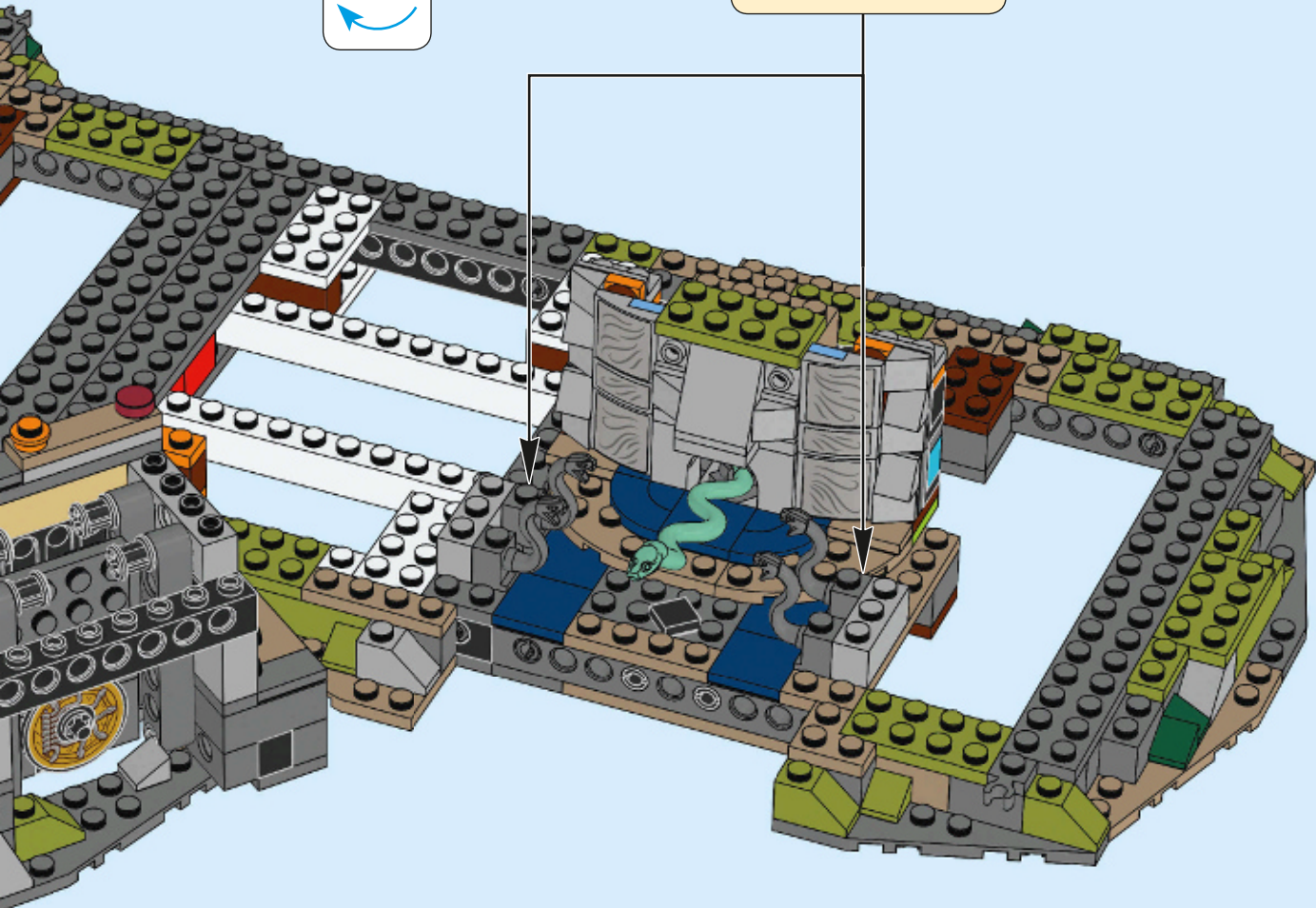
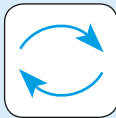

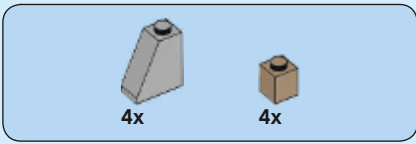

114

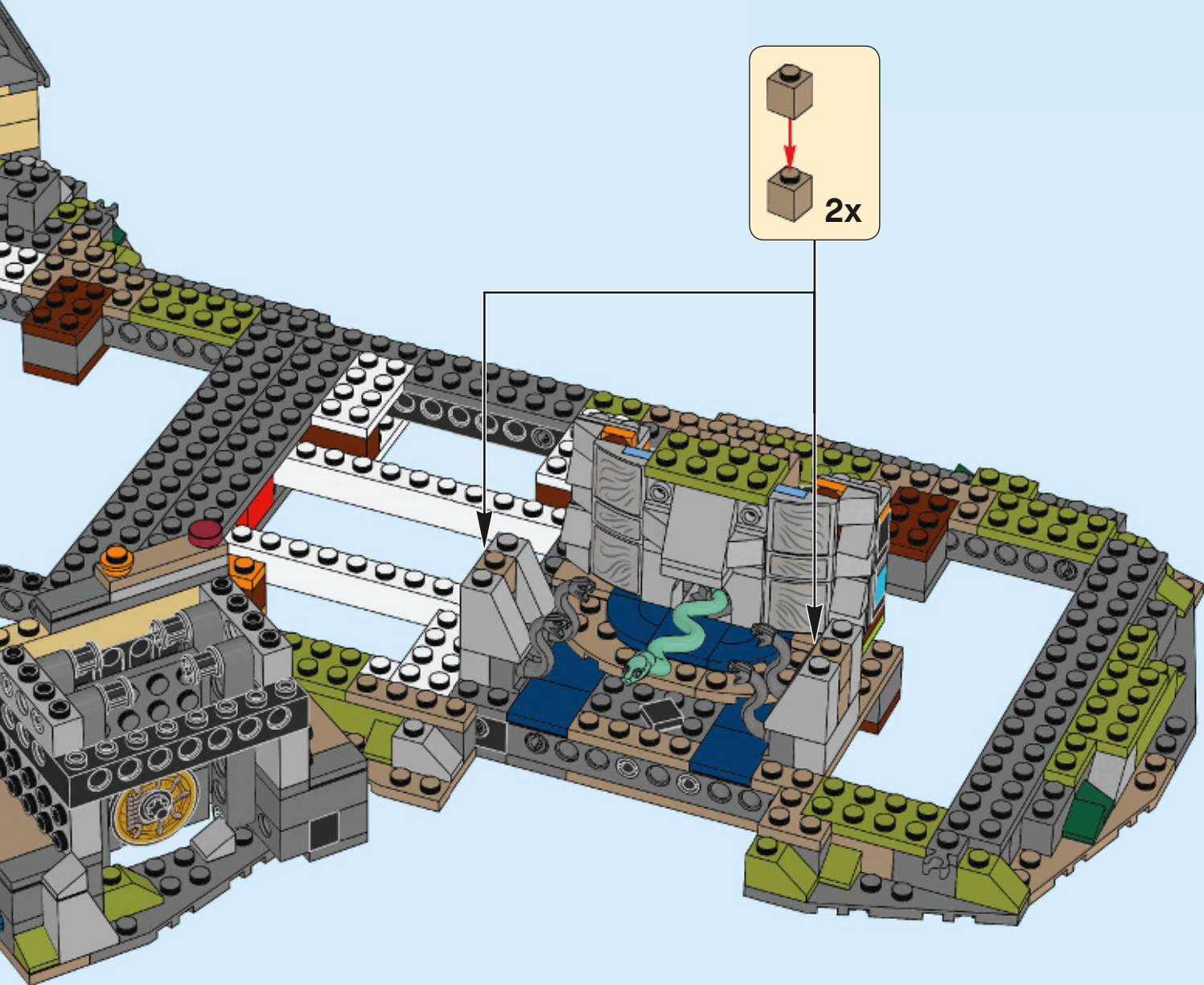

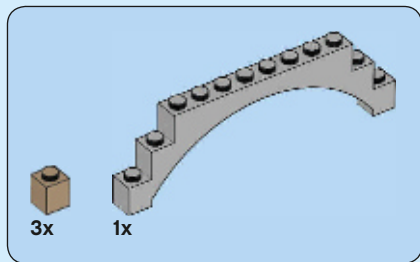

115

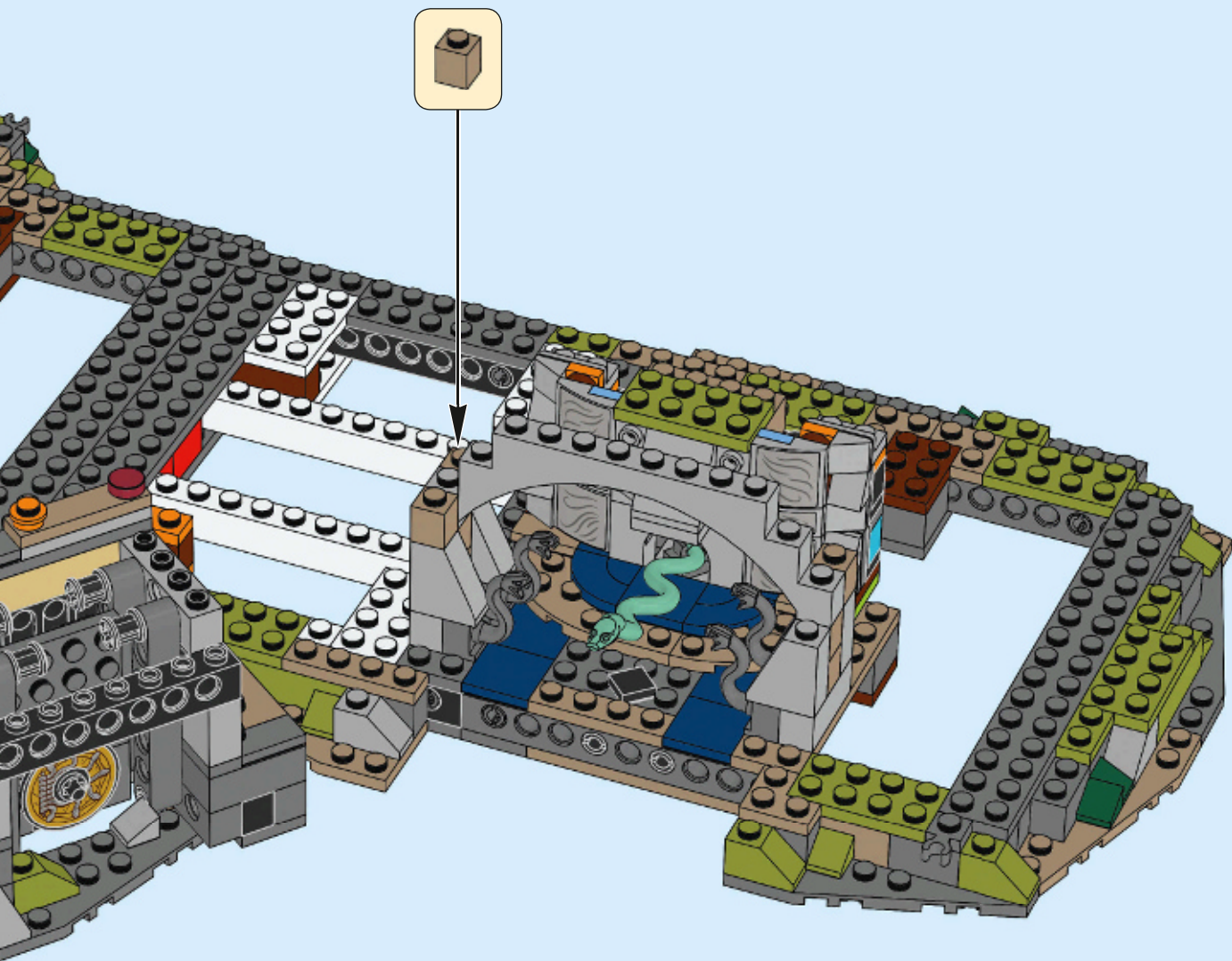

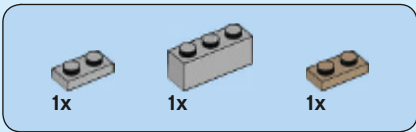

116

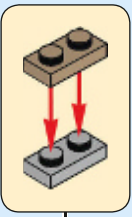
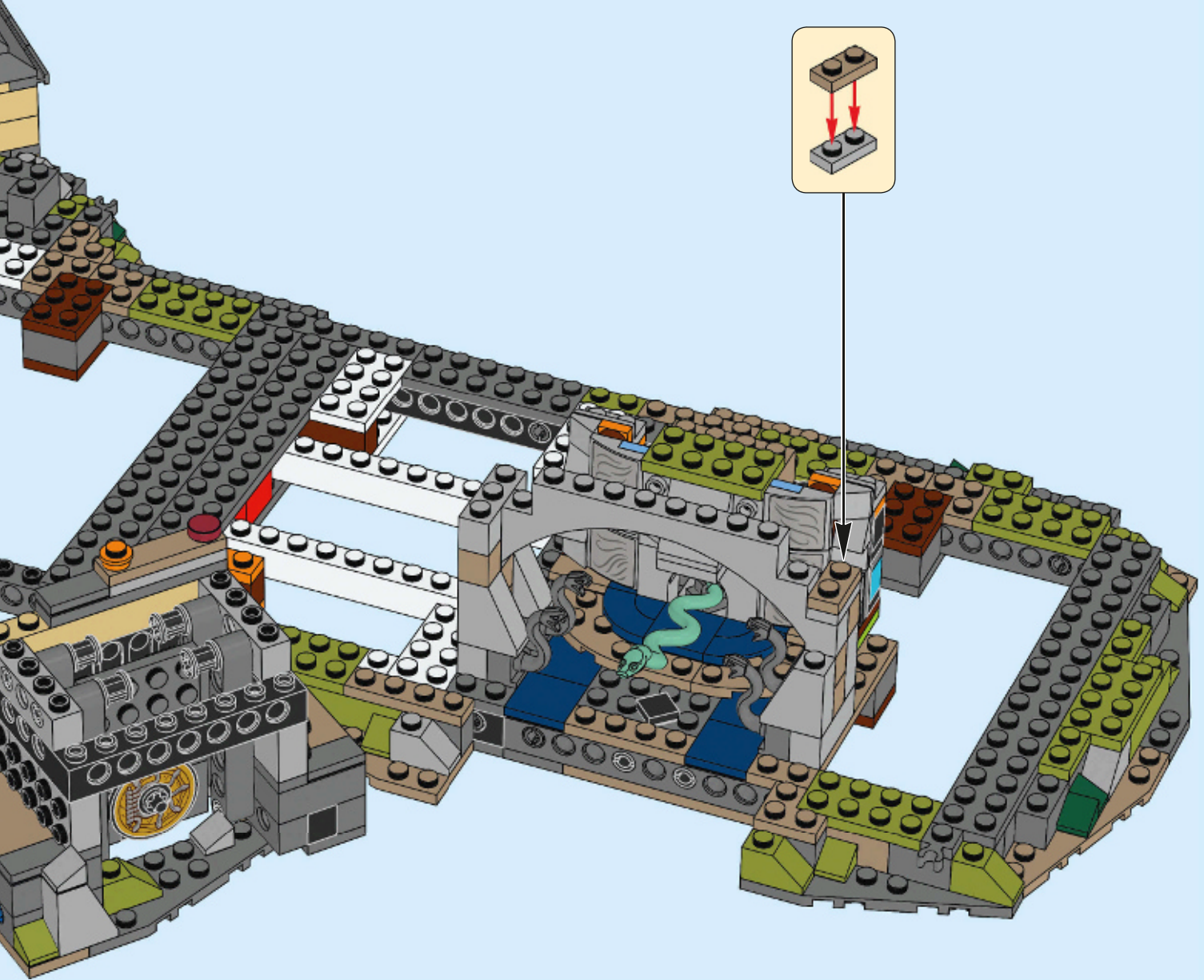

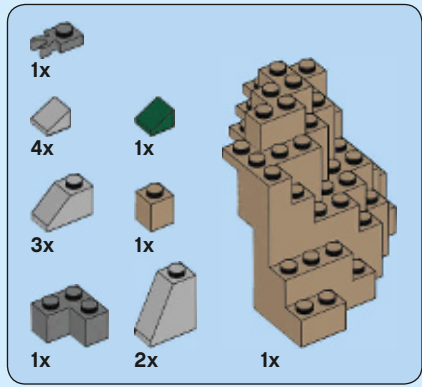

117

1

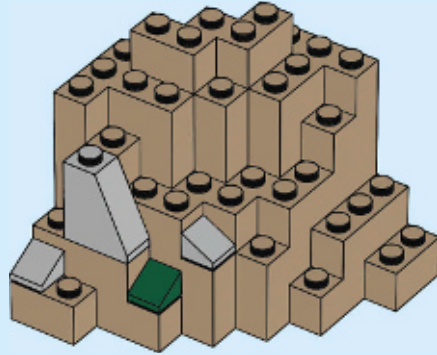

2

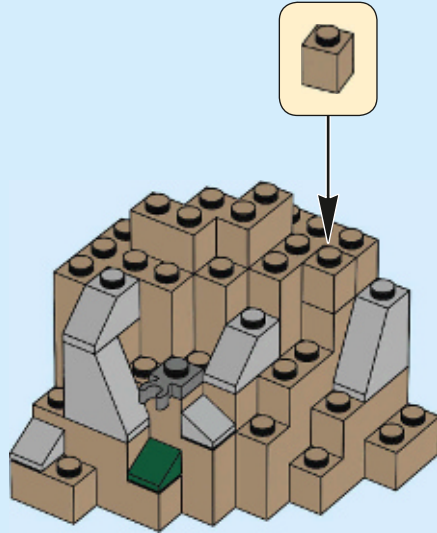

3

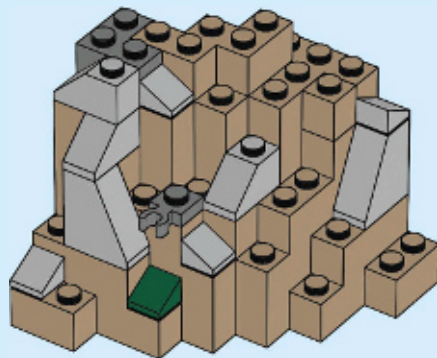

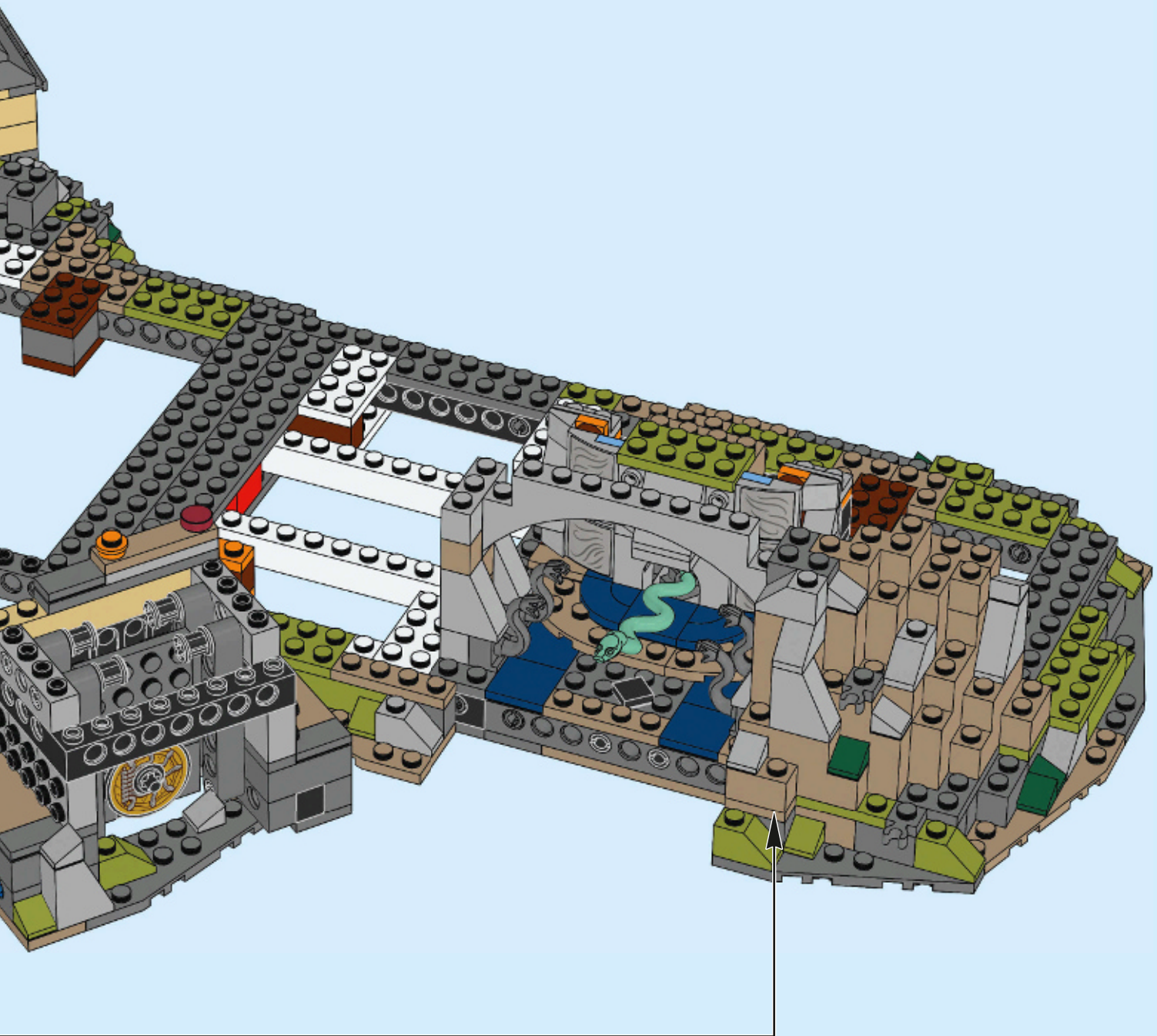

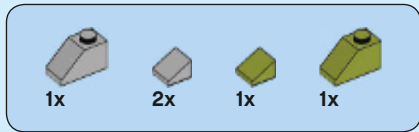

118

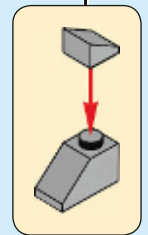
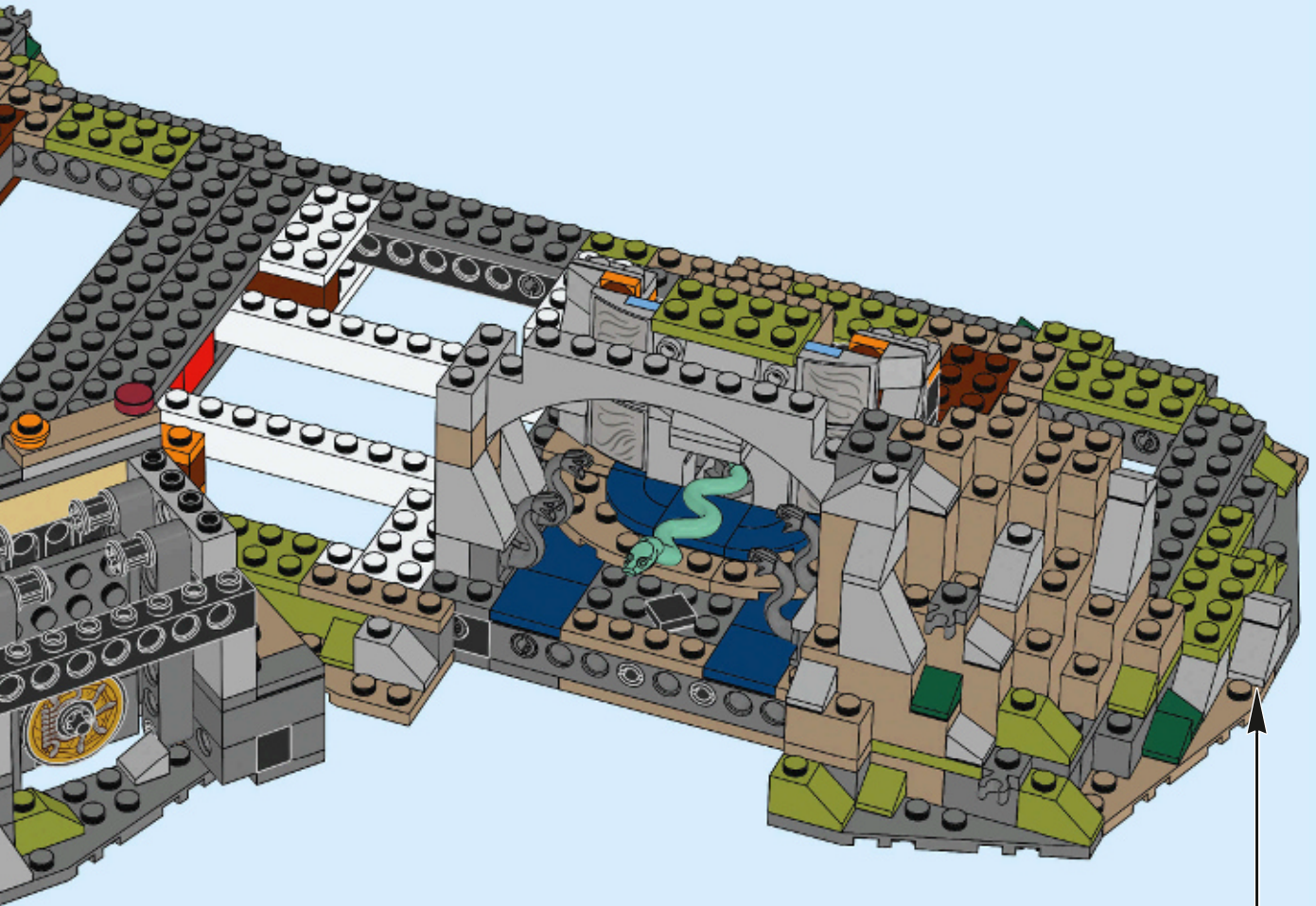

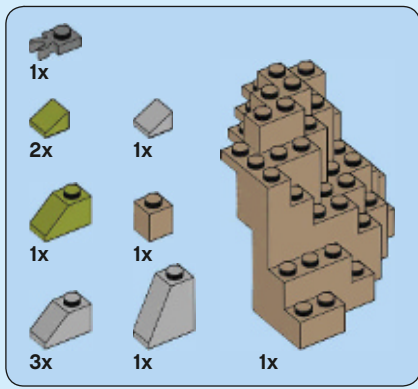

119

1

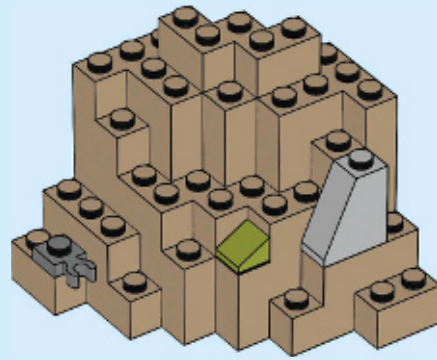

2

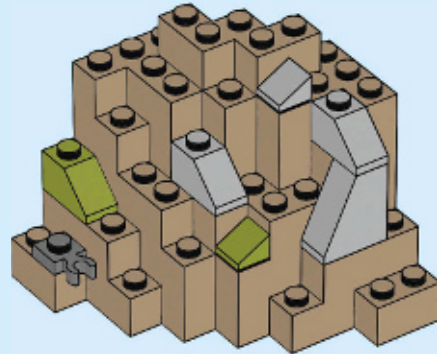

3

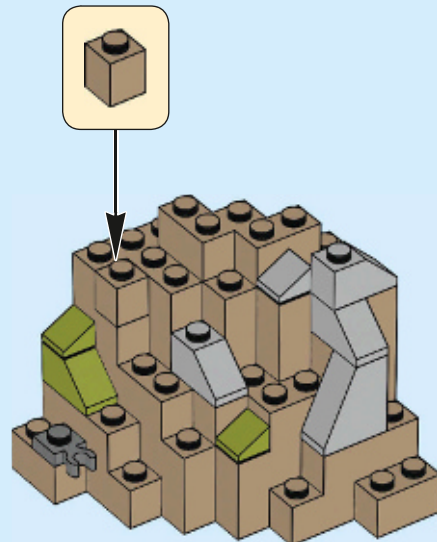

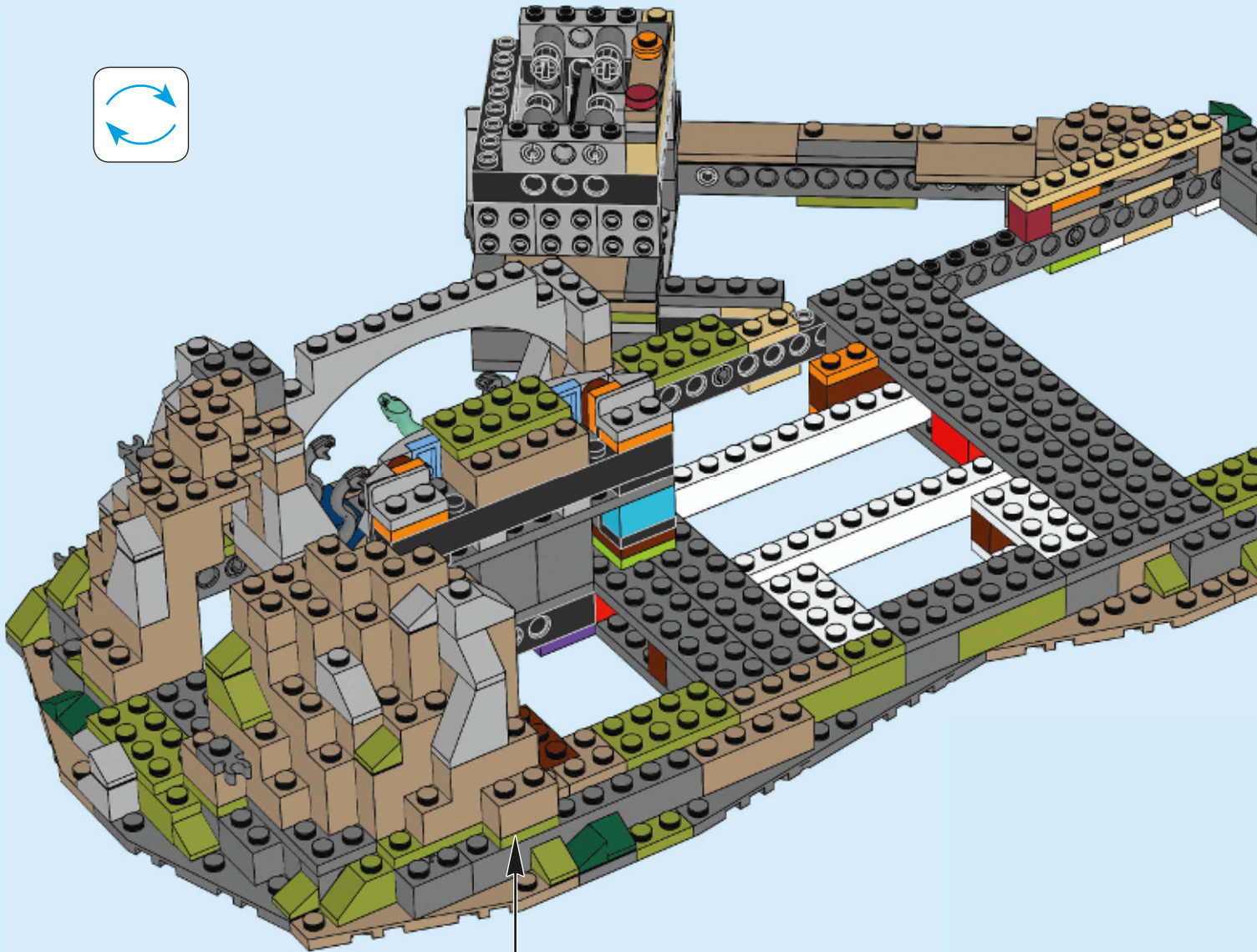
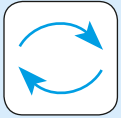

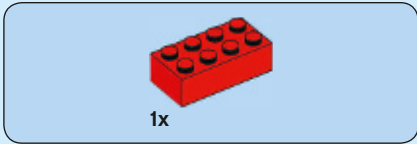
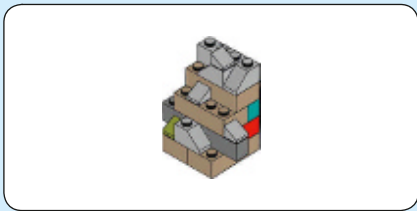

120

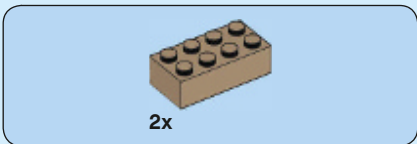
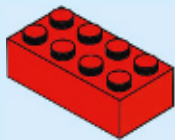

121

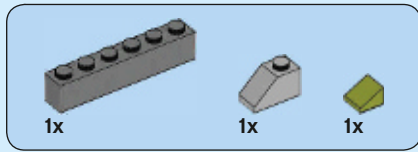
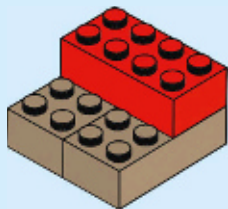

122

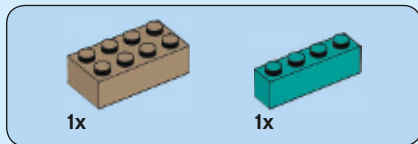
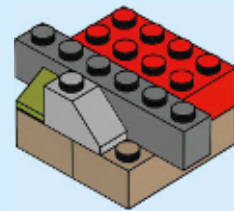

123

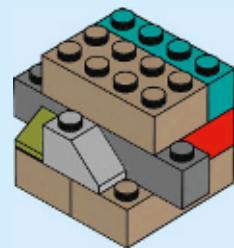

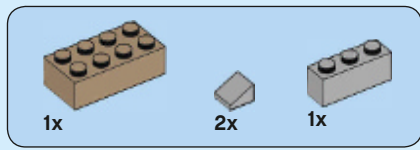

124

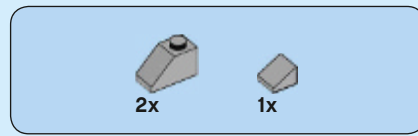
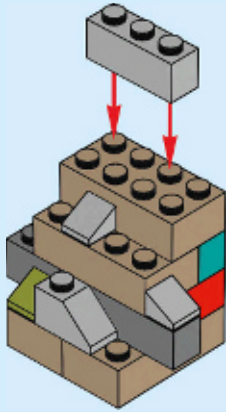

125

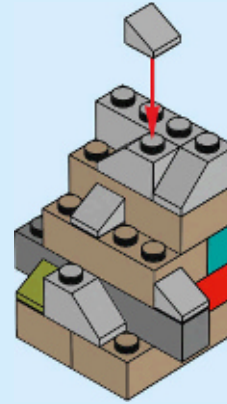

126

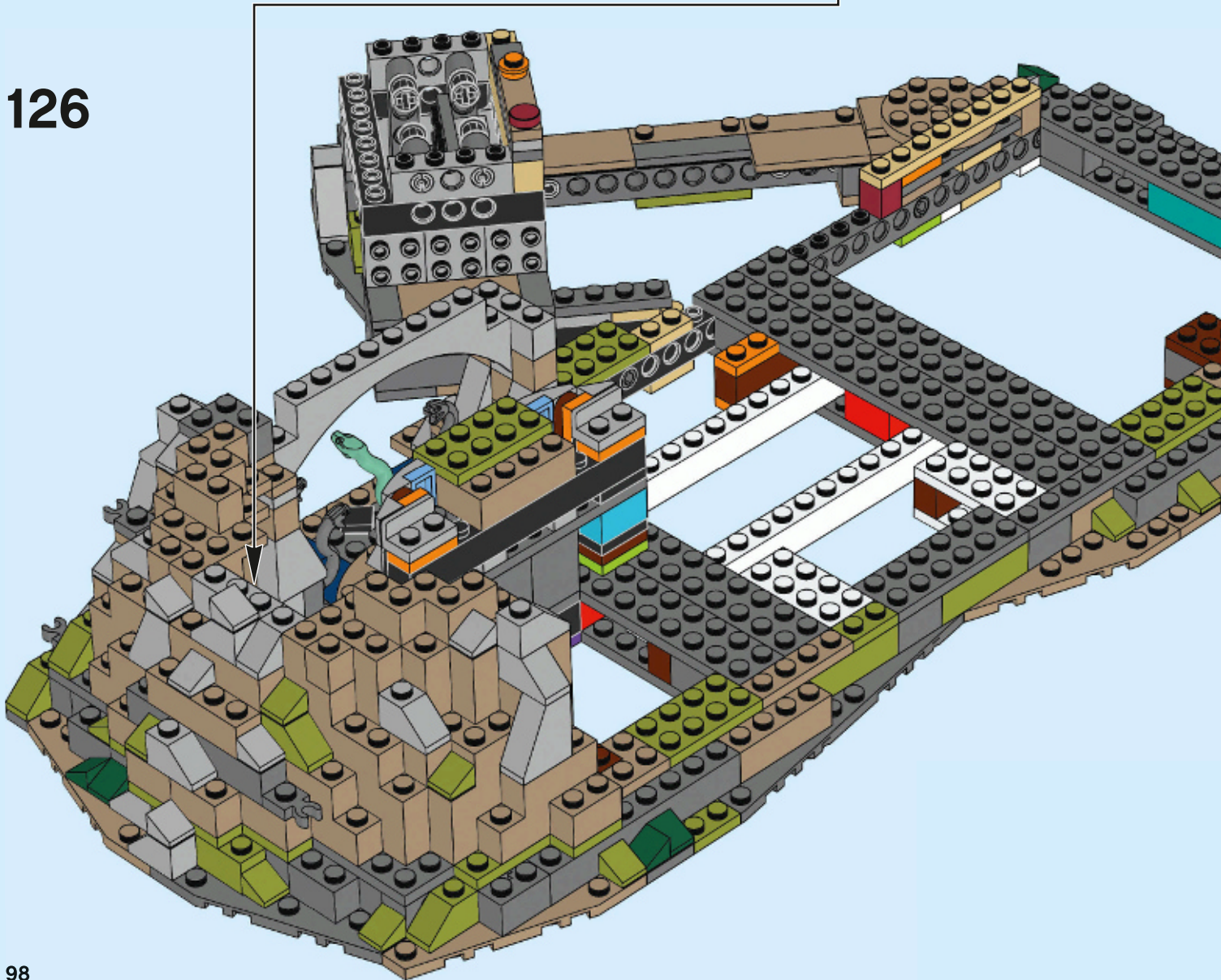



127

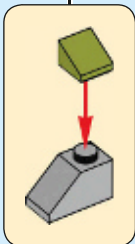
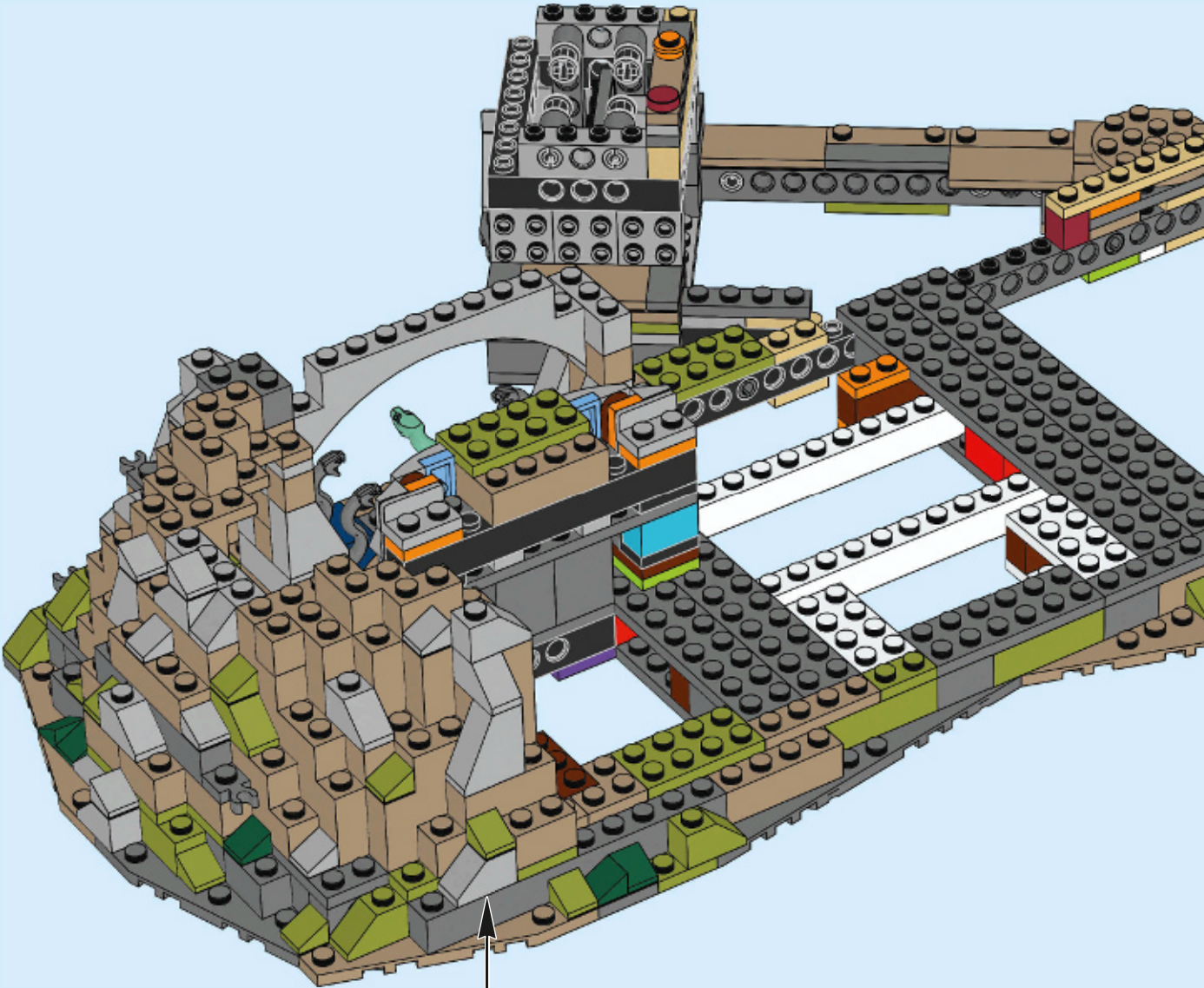

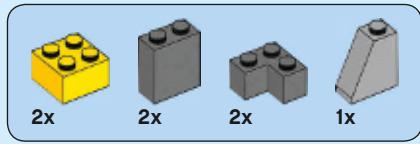

128

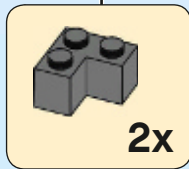
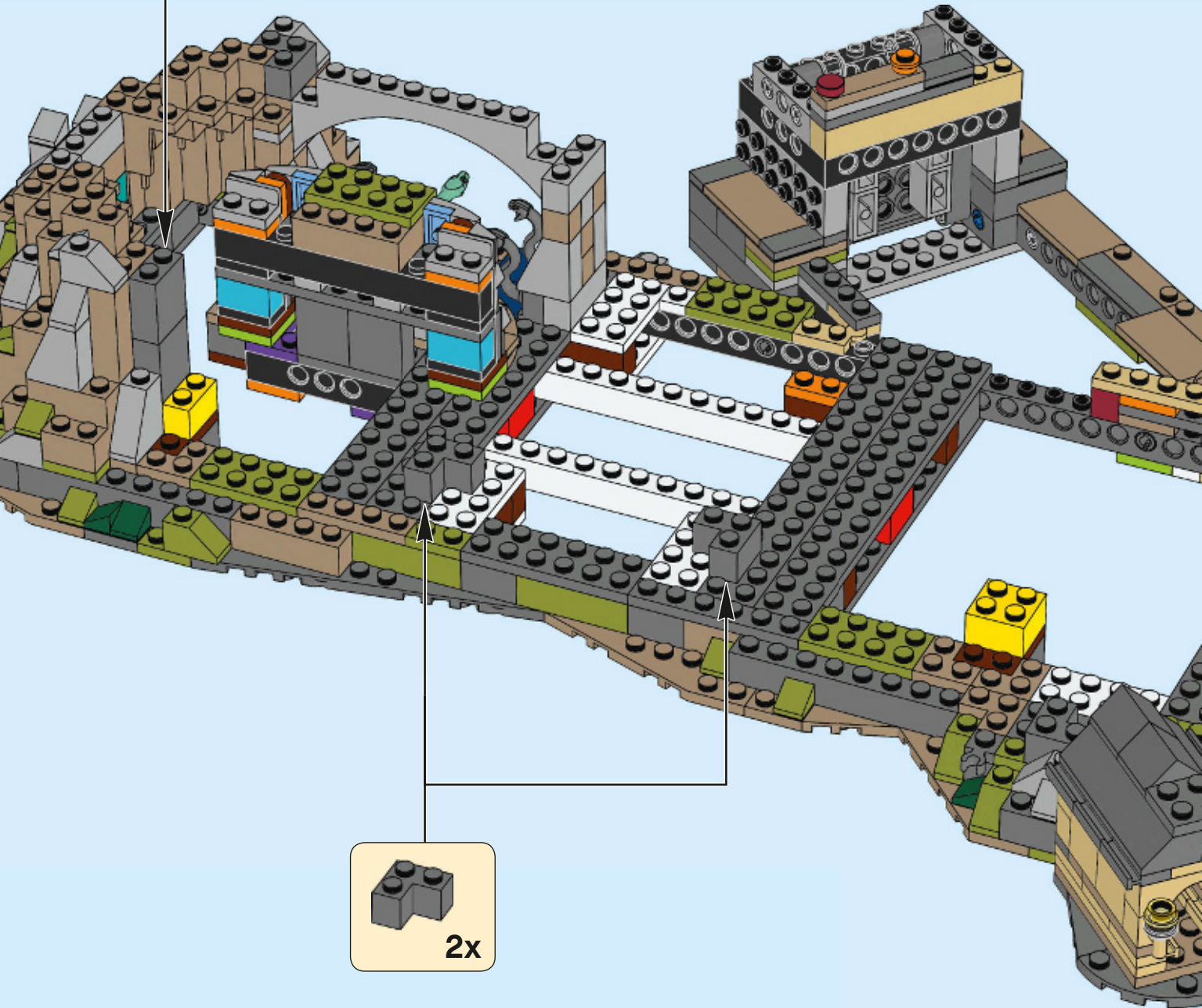
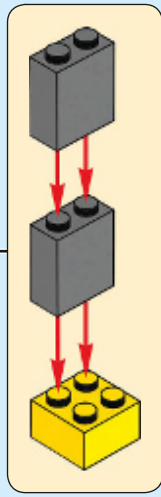
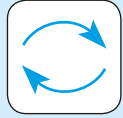

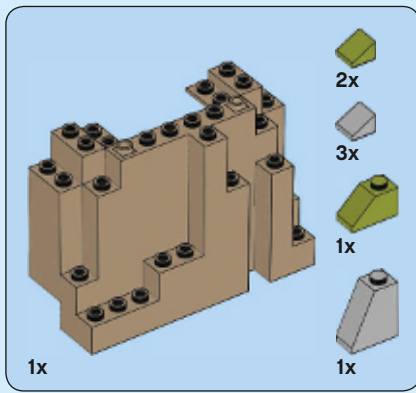

129

1

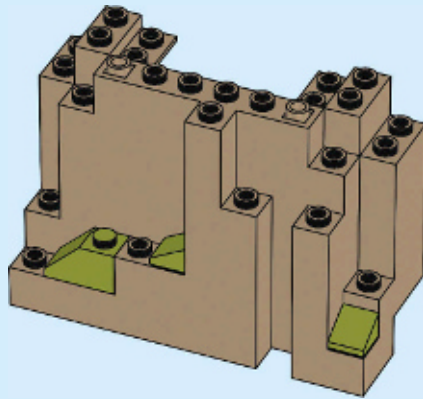

2

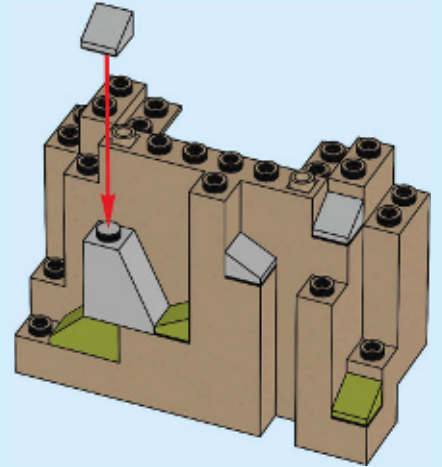

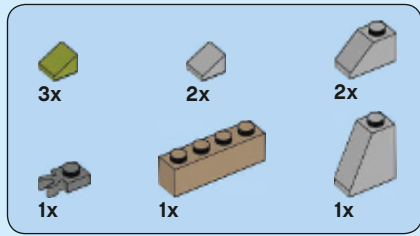

130

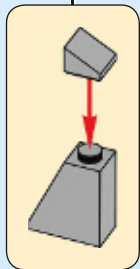
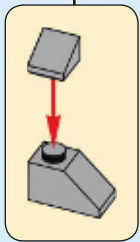
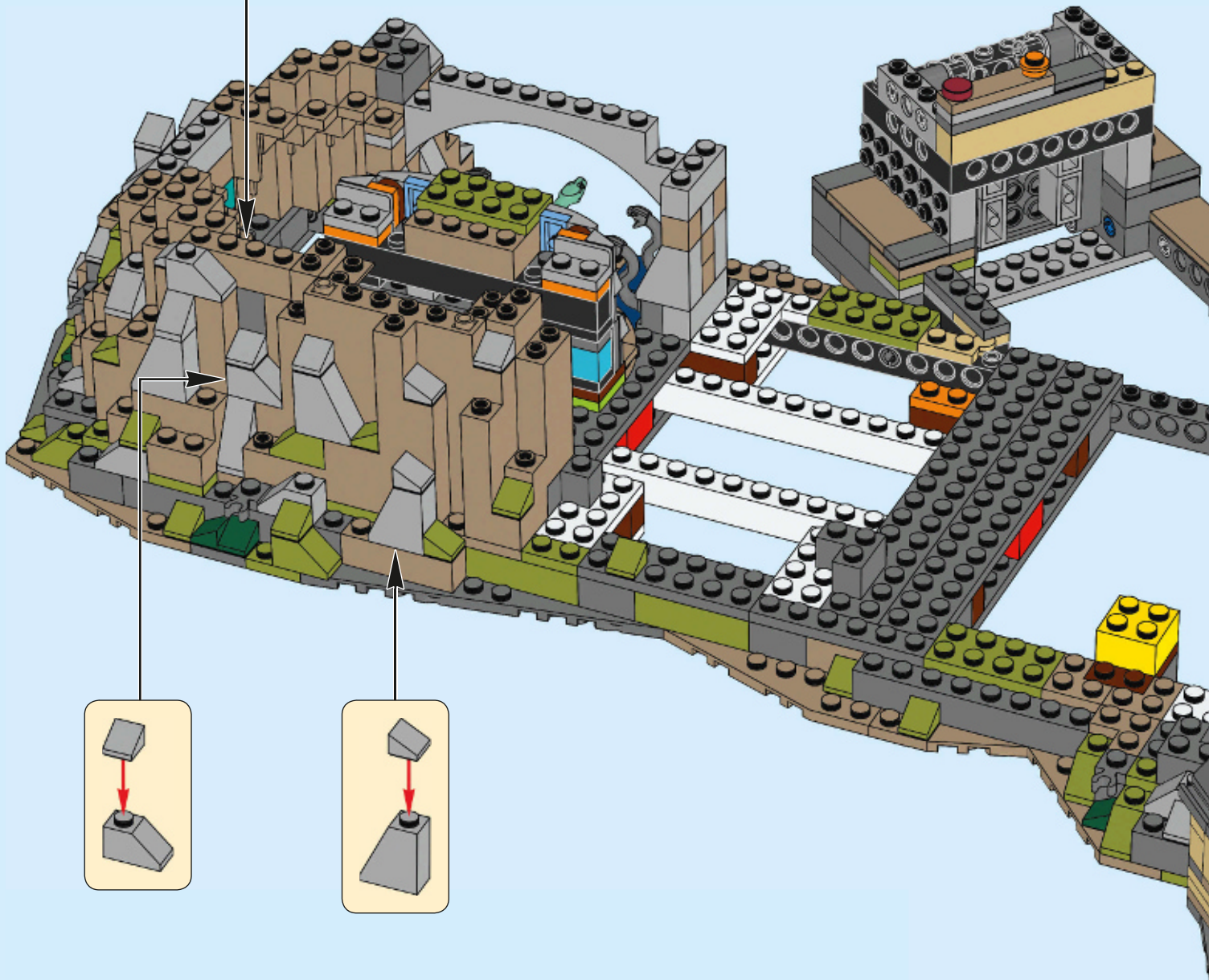
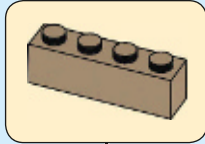

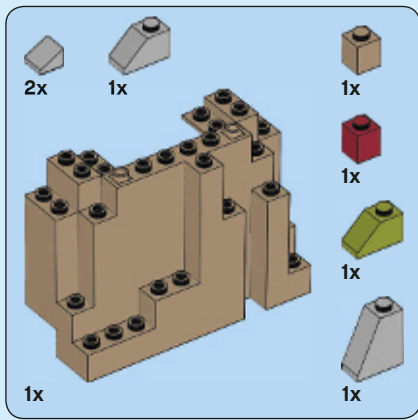

131

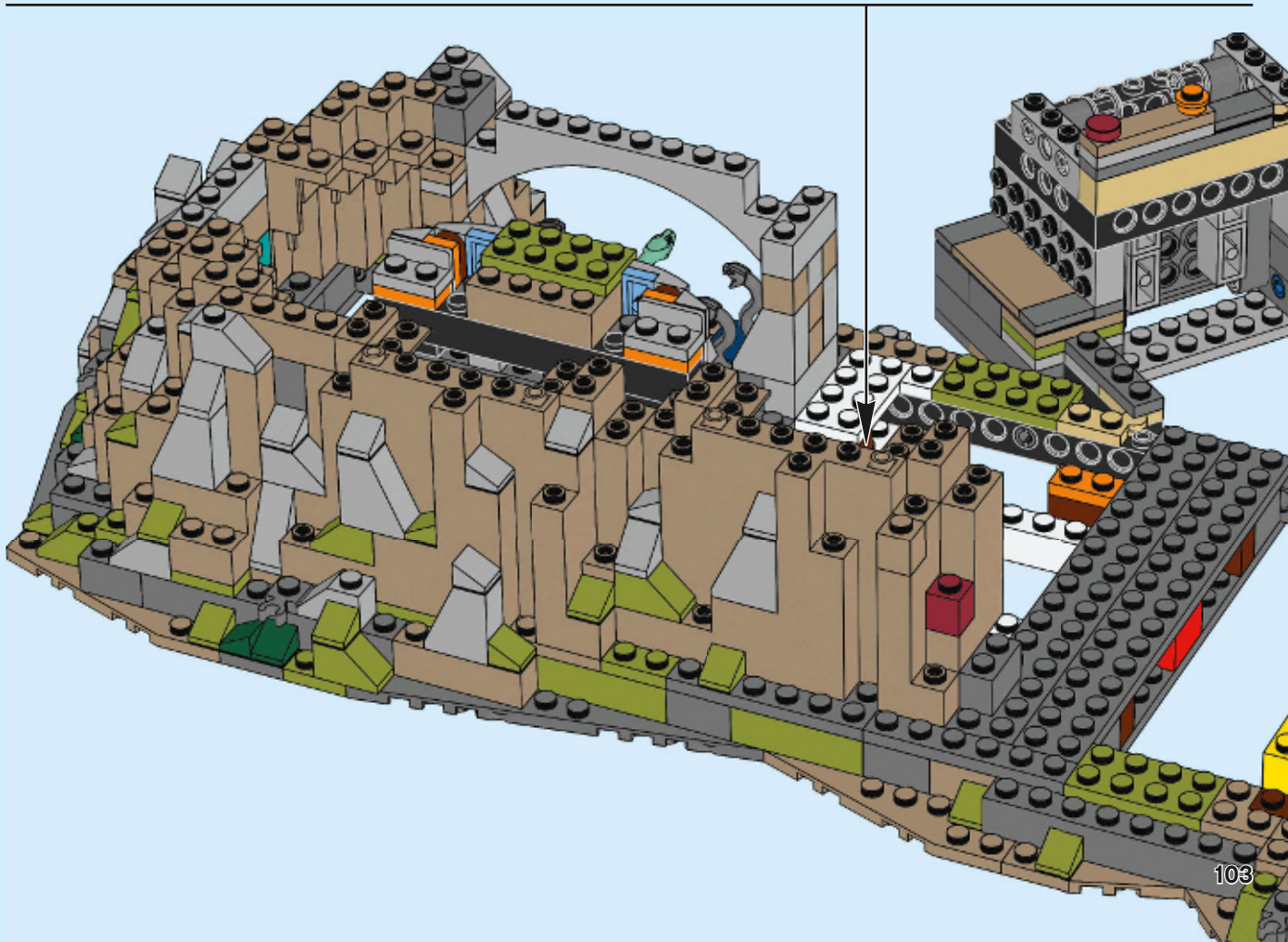
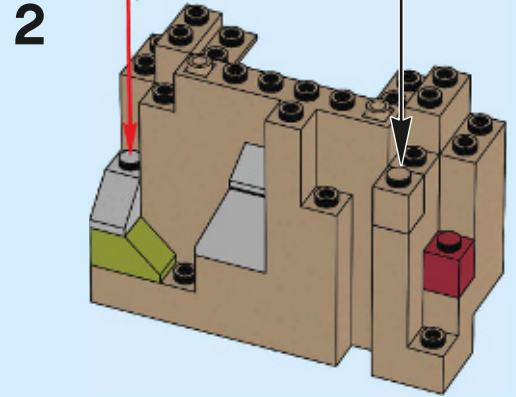
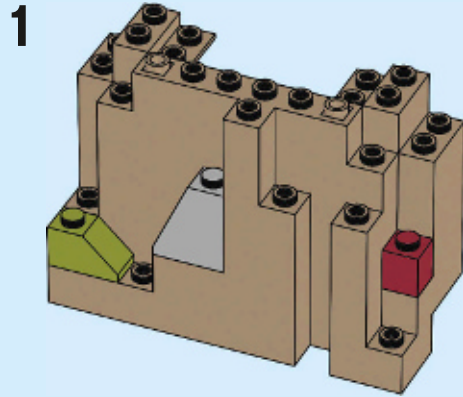

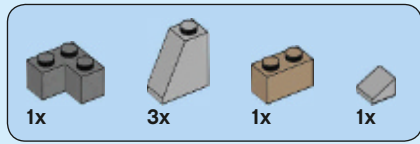

132



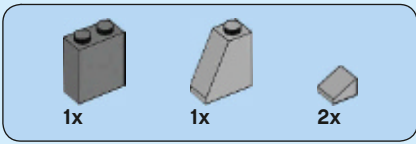

133

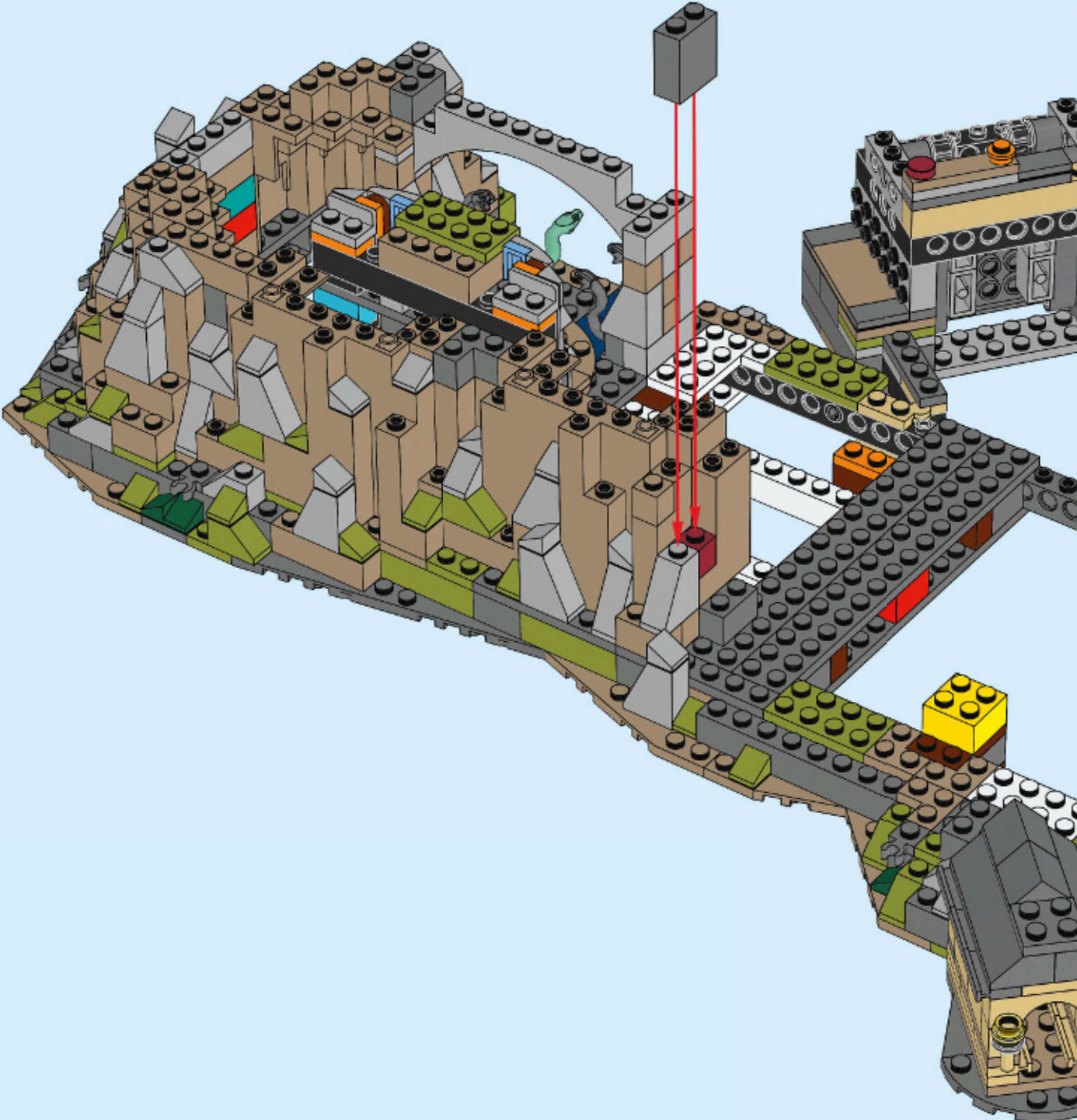

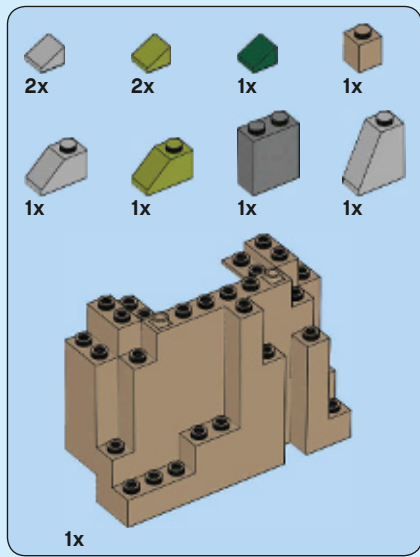

134

1

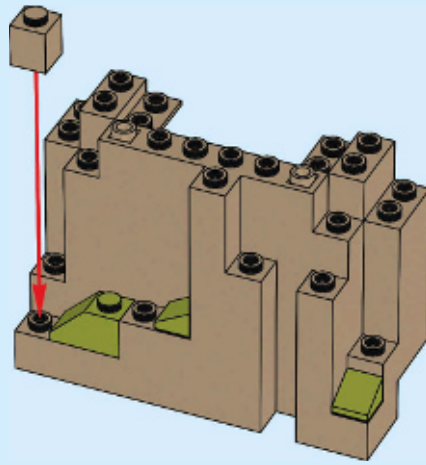

2

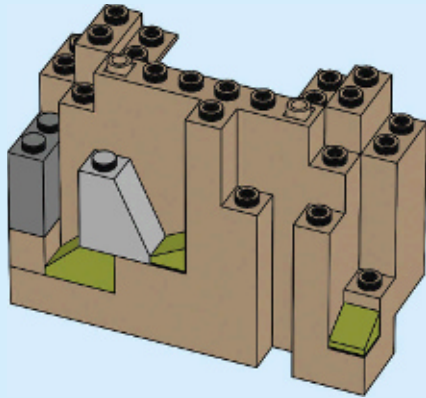

3

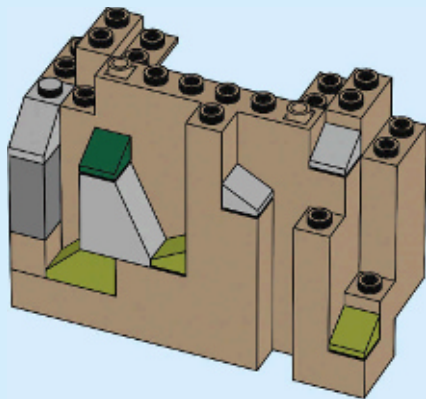

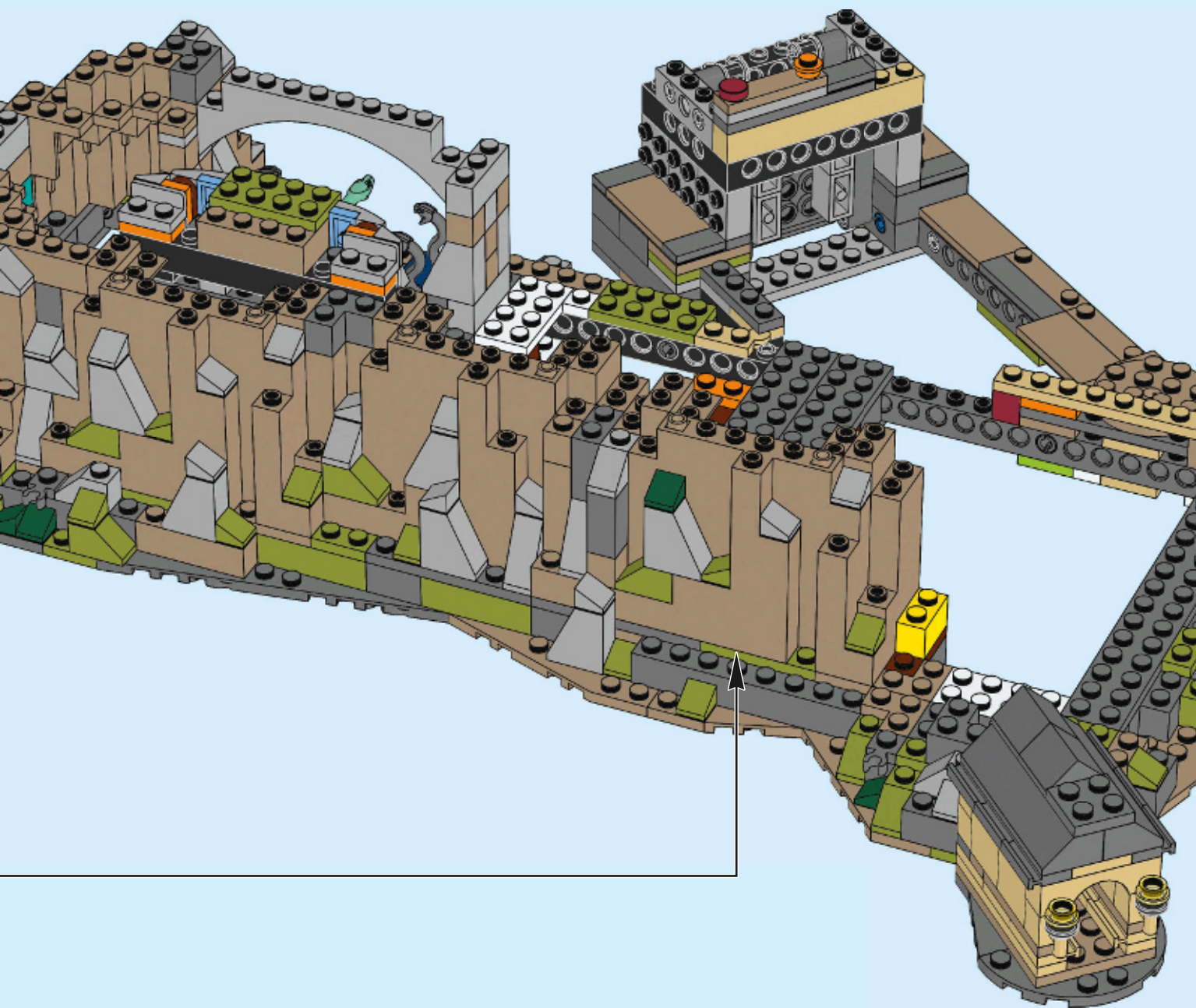

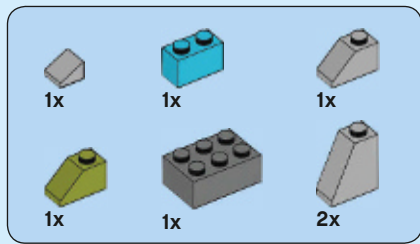

135

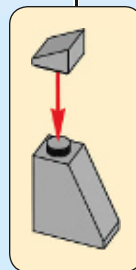
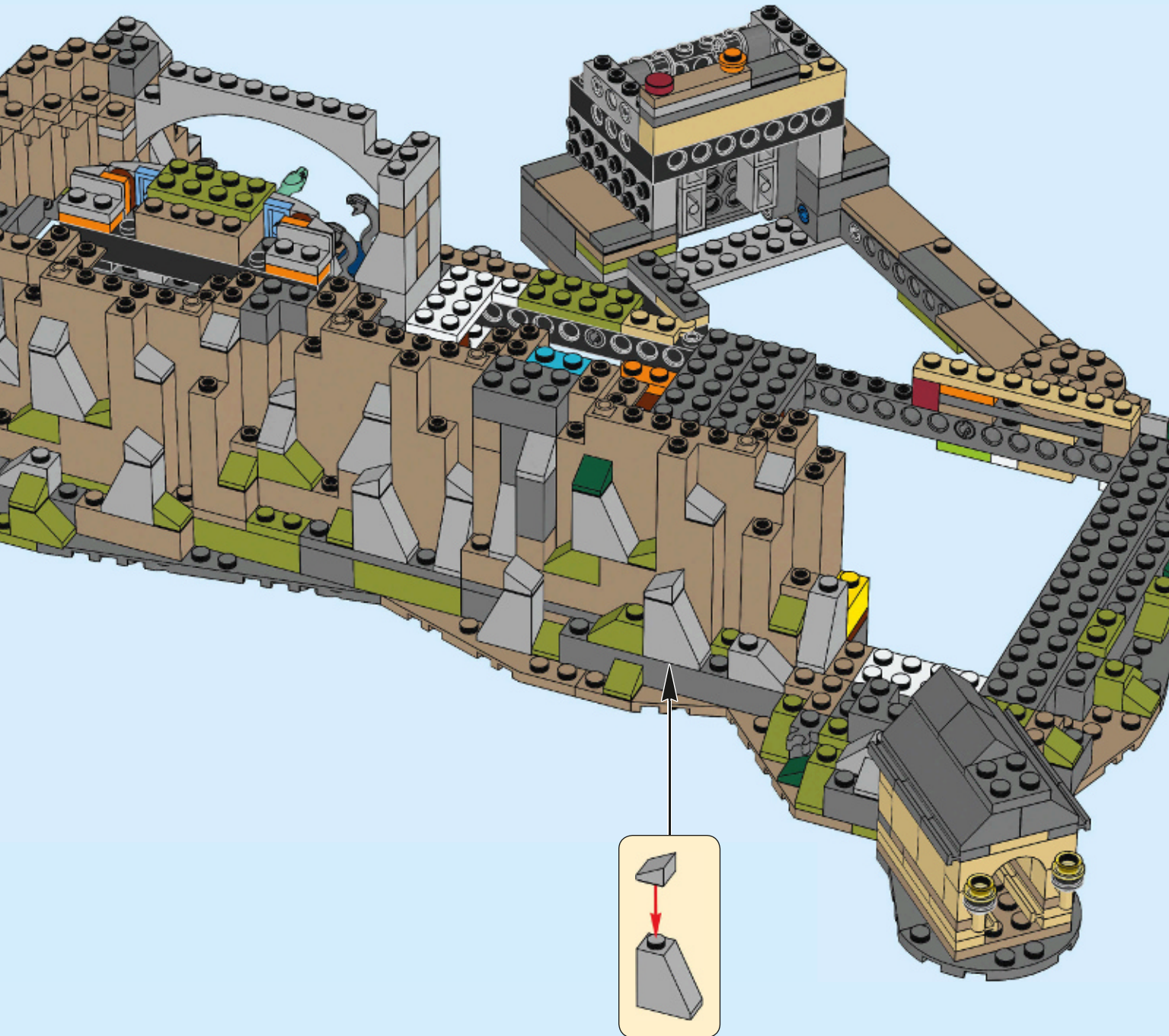

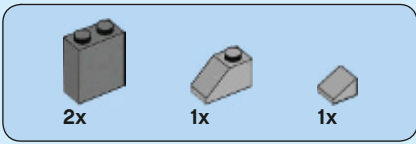

136

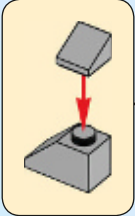
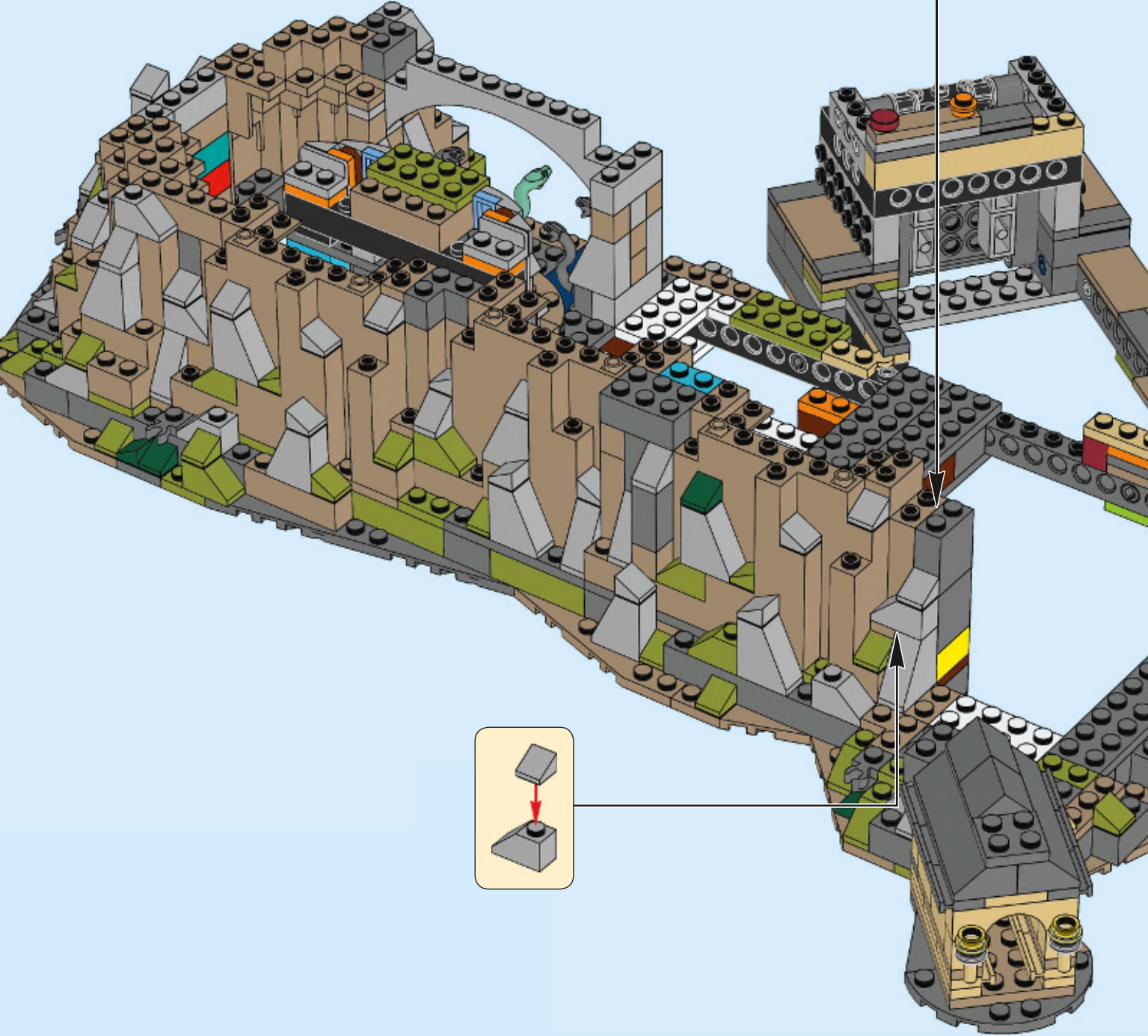
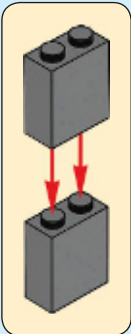

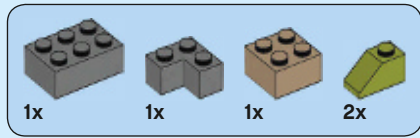

137



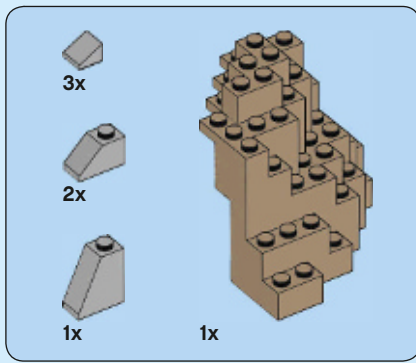

138

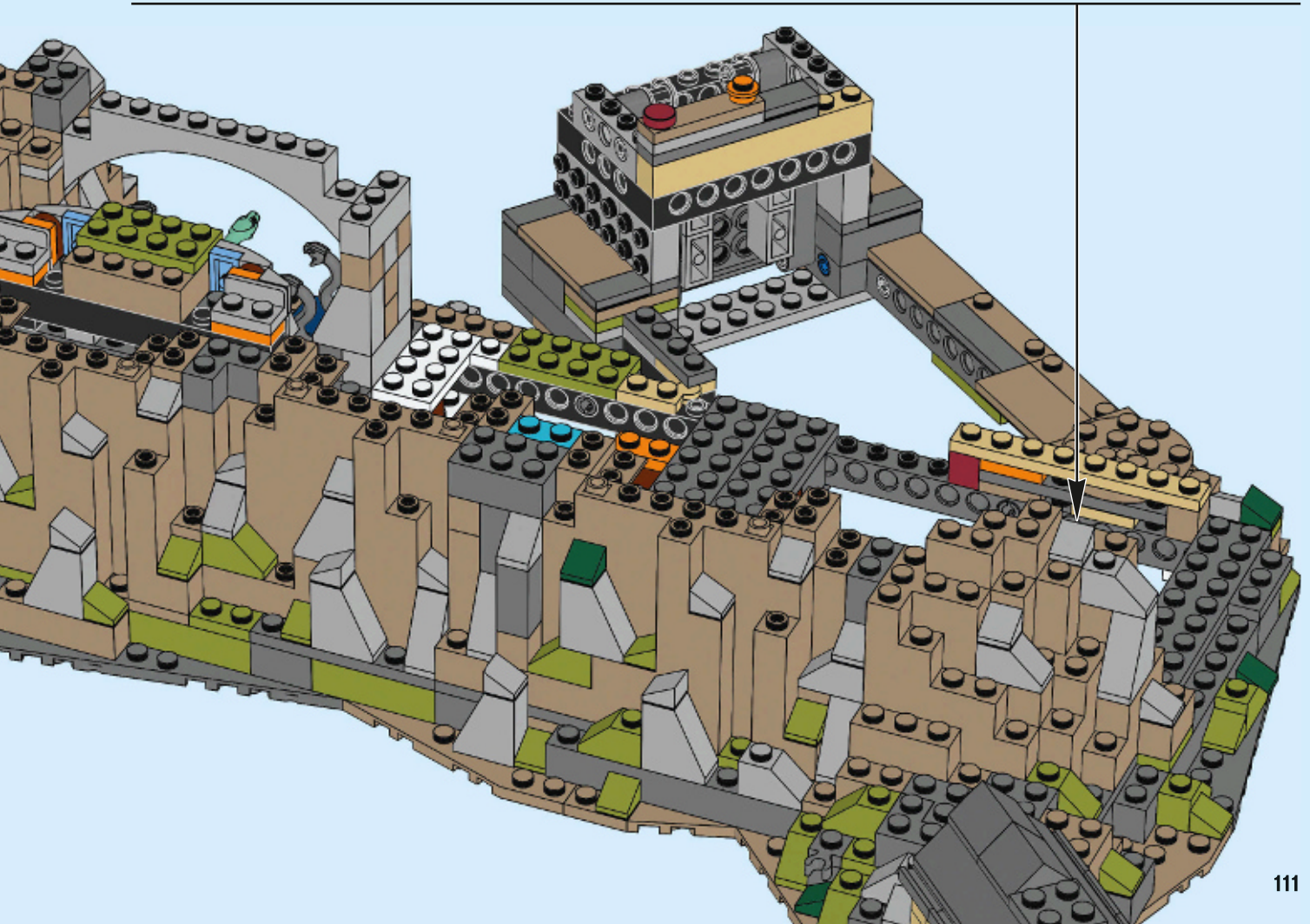
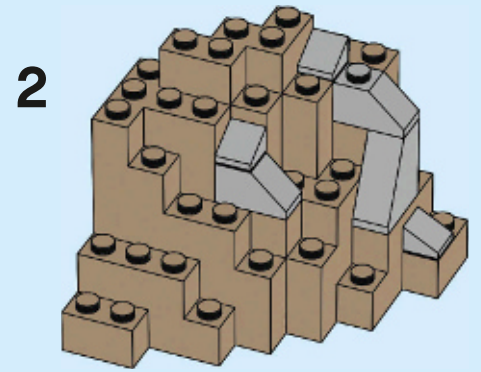
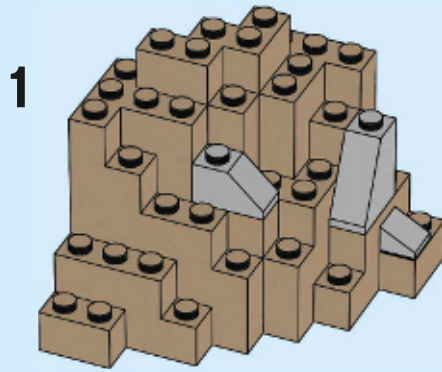

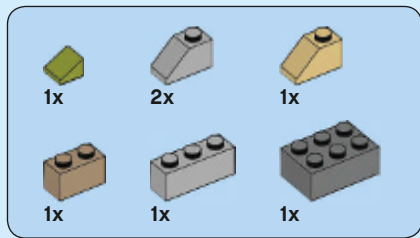

139

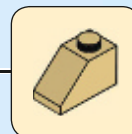

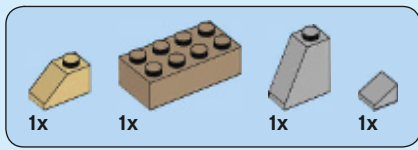

140



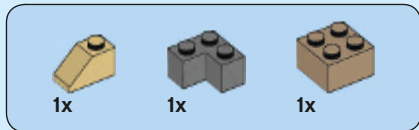

141



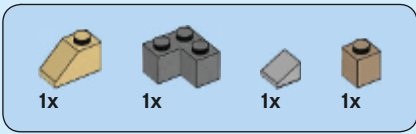

142



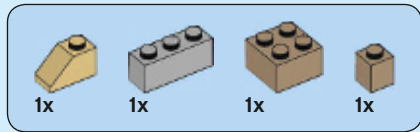

143



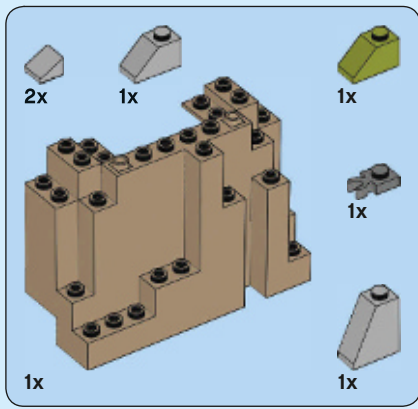

144

1

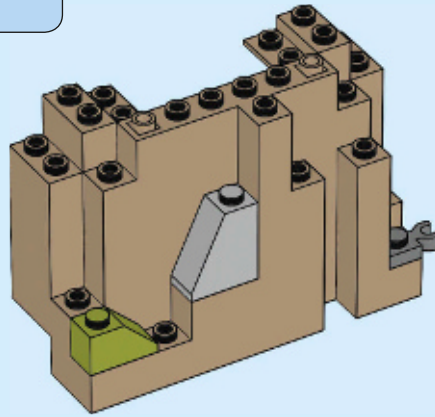

2

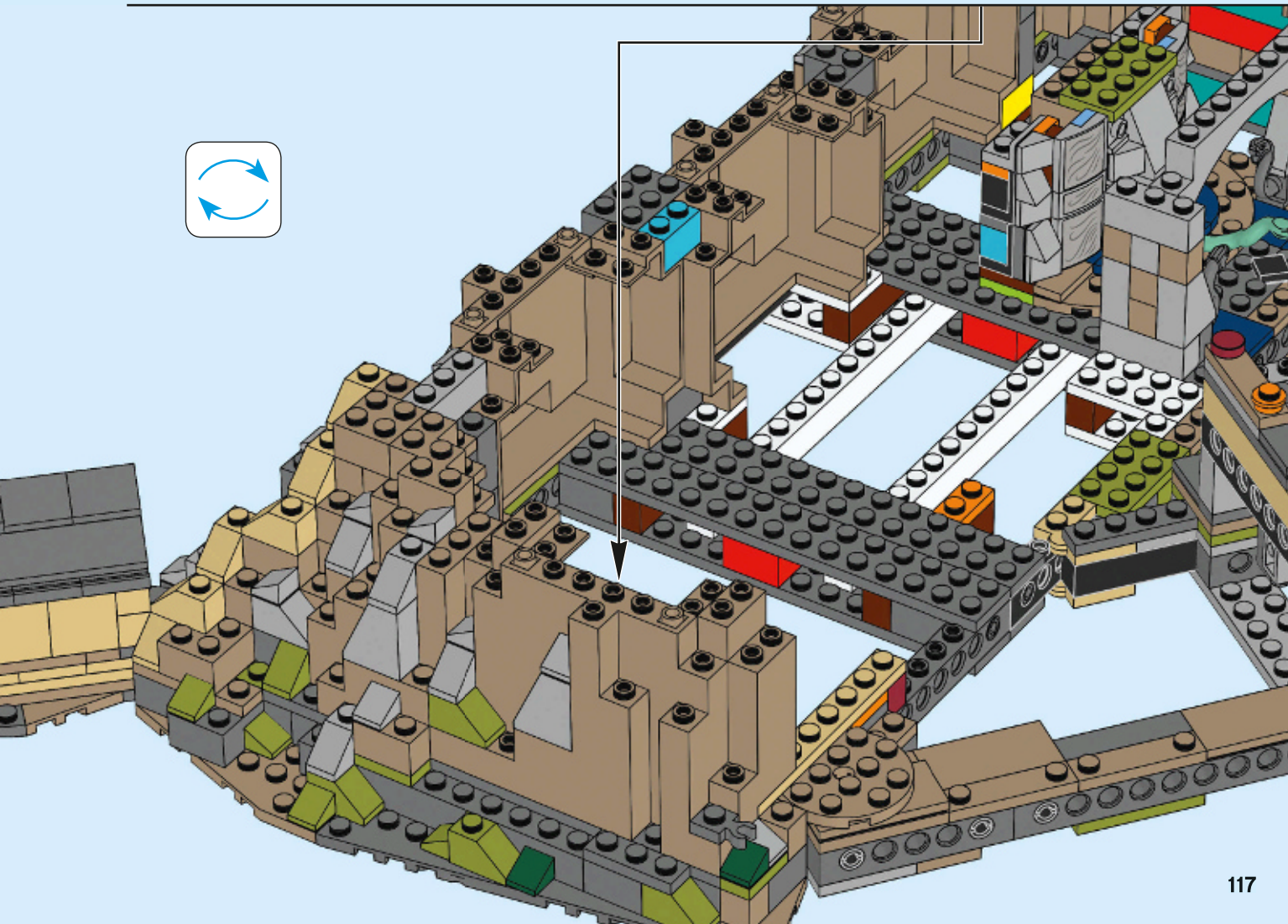
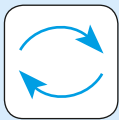
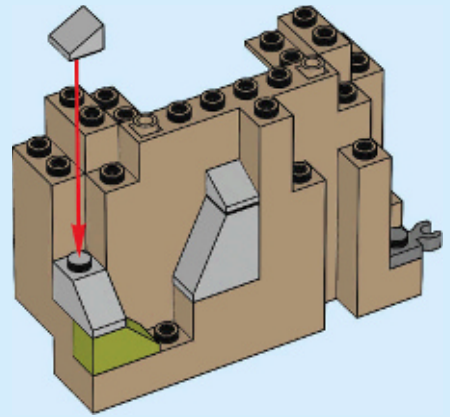

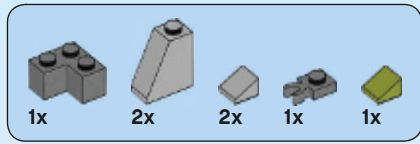

145

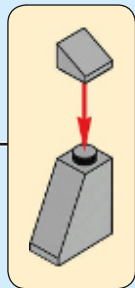
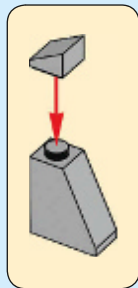
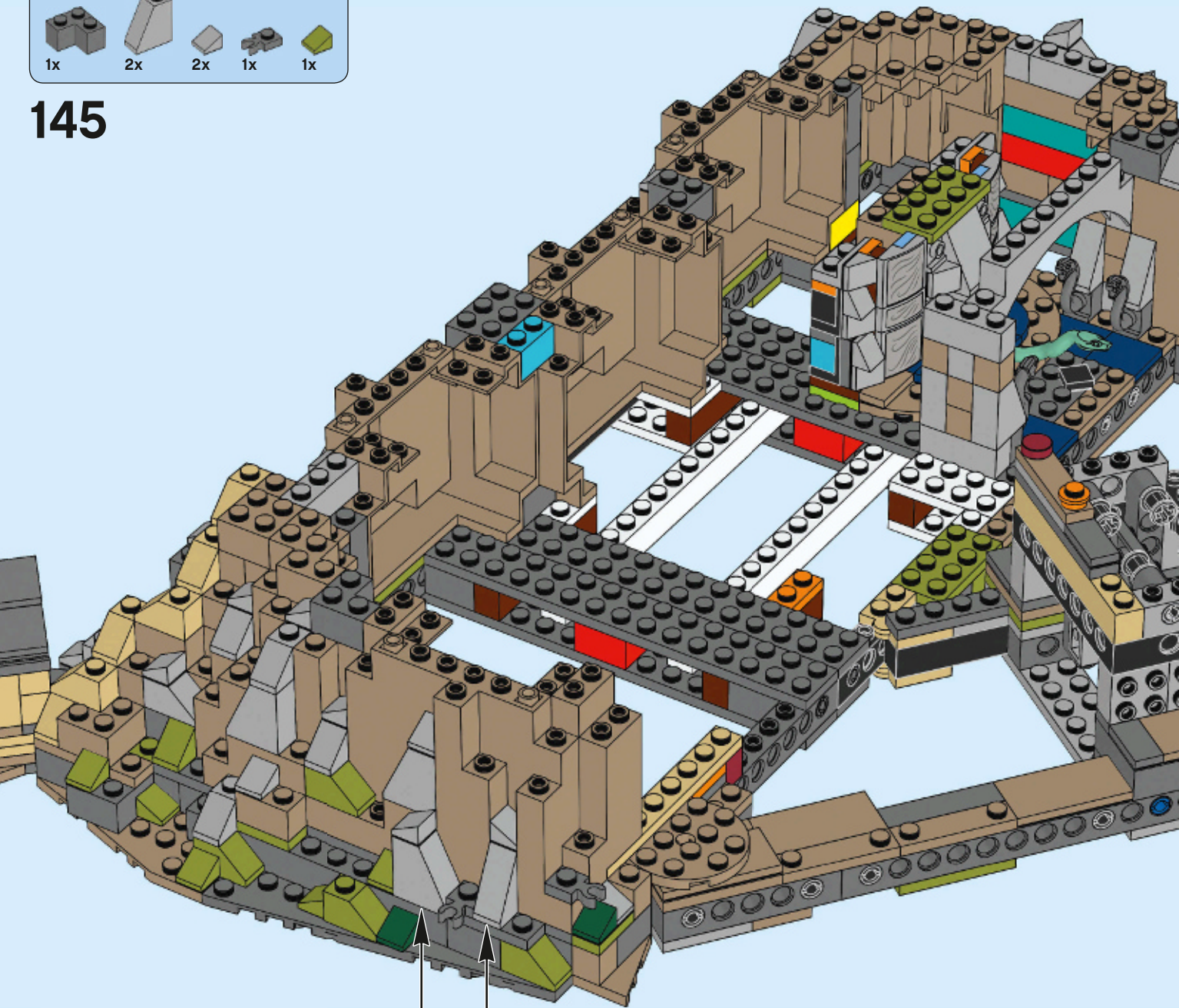

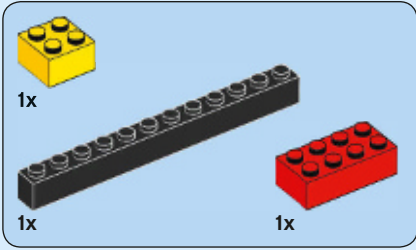

146

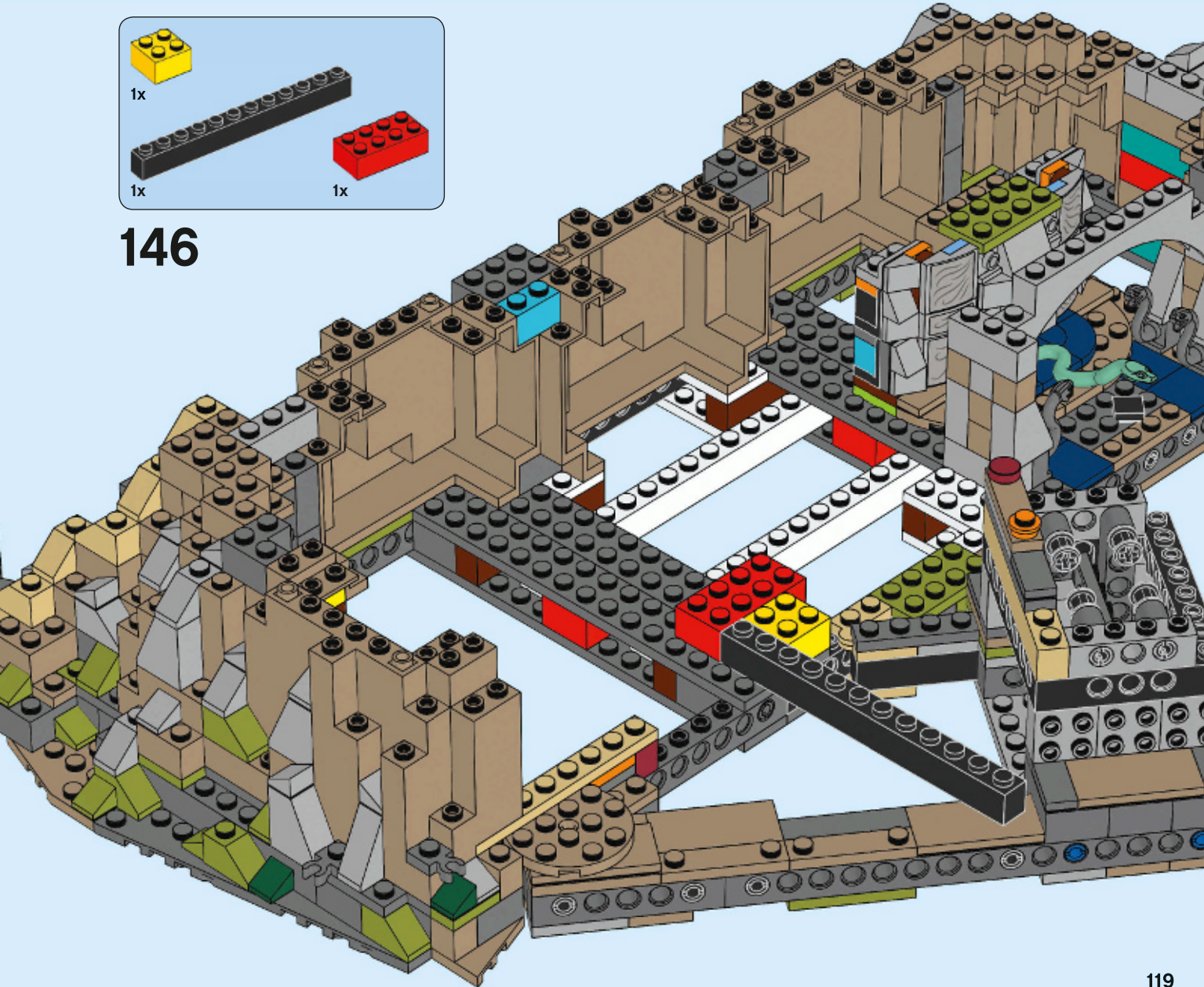

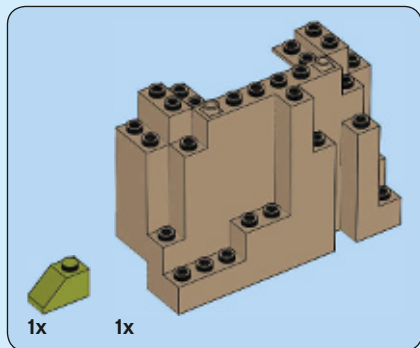

147

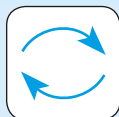

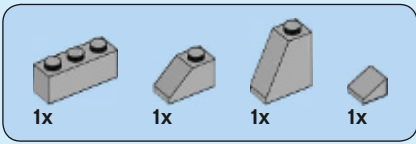

148

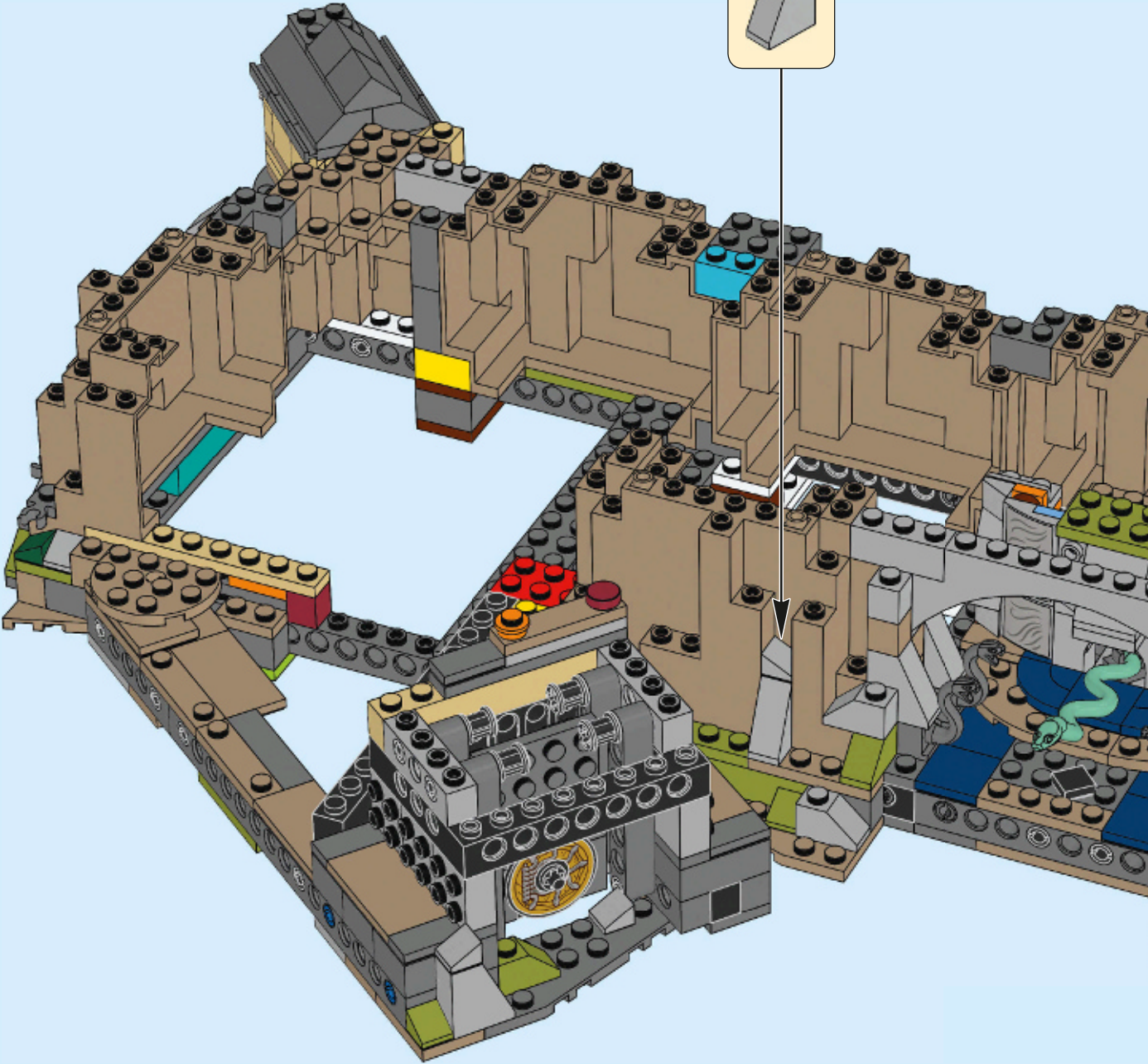
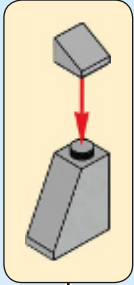

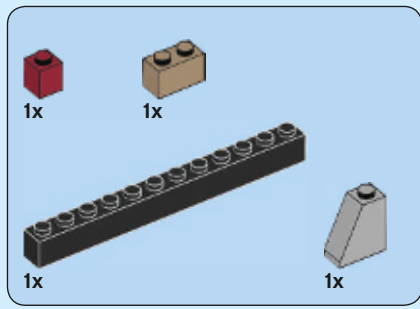

149

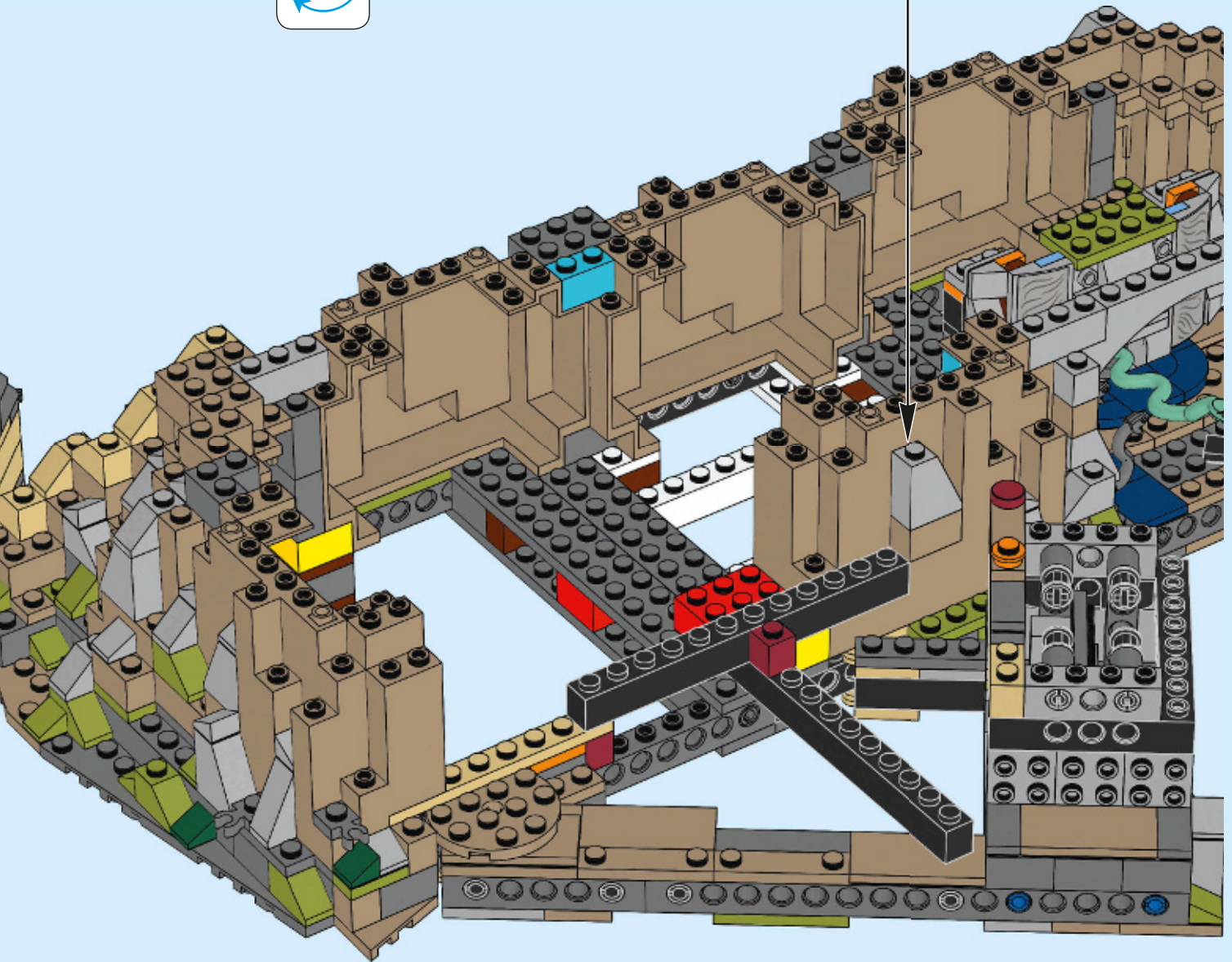
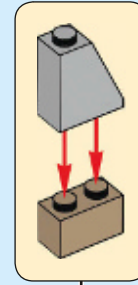
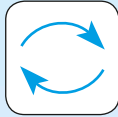

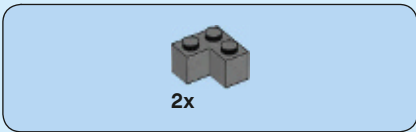

150

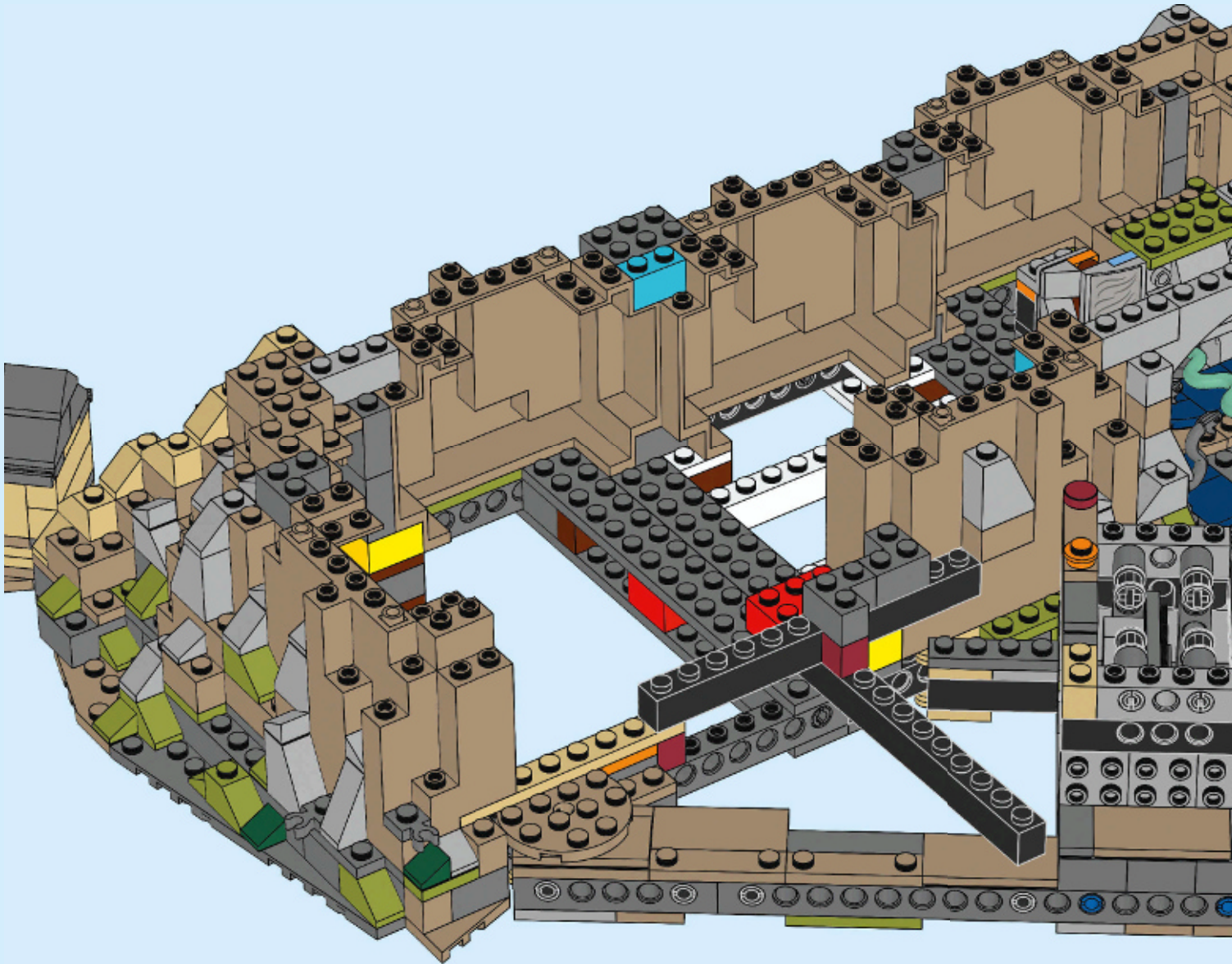

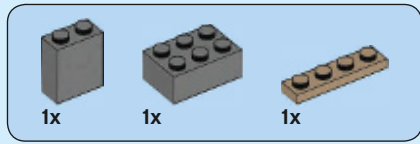

151

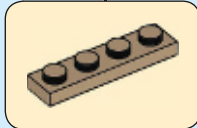
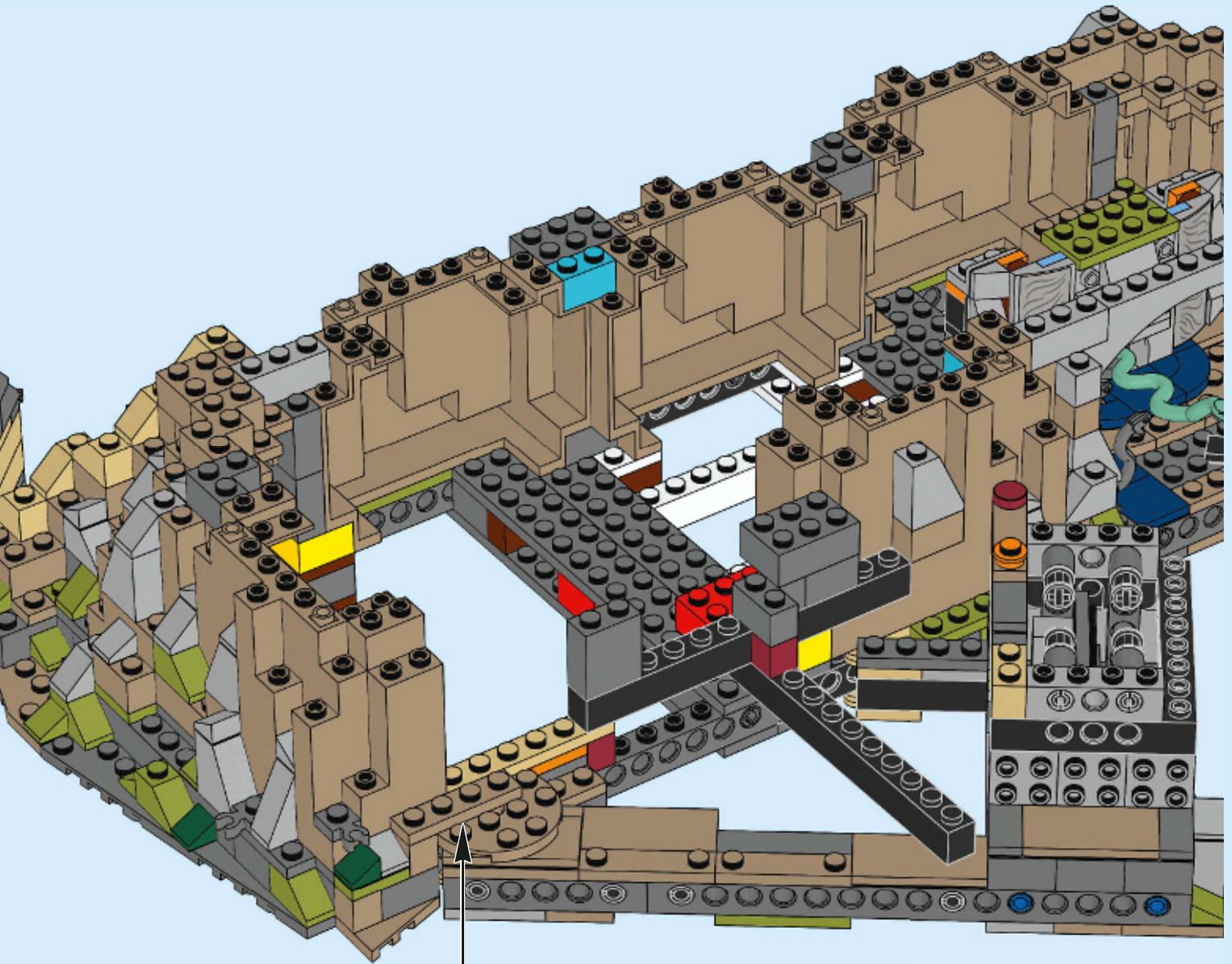

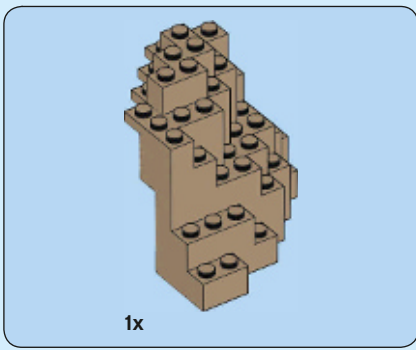

152

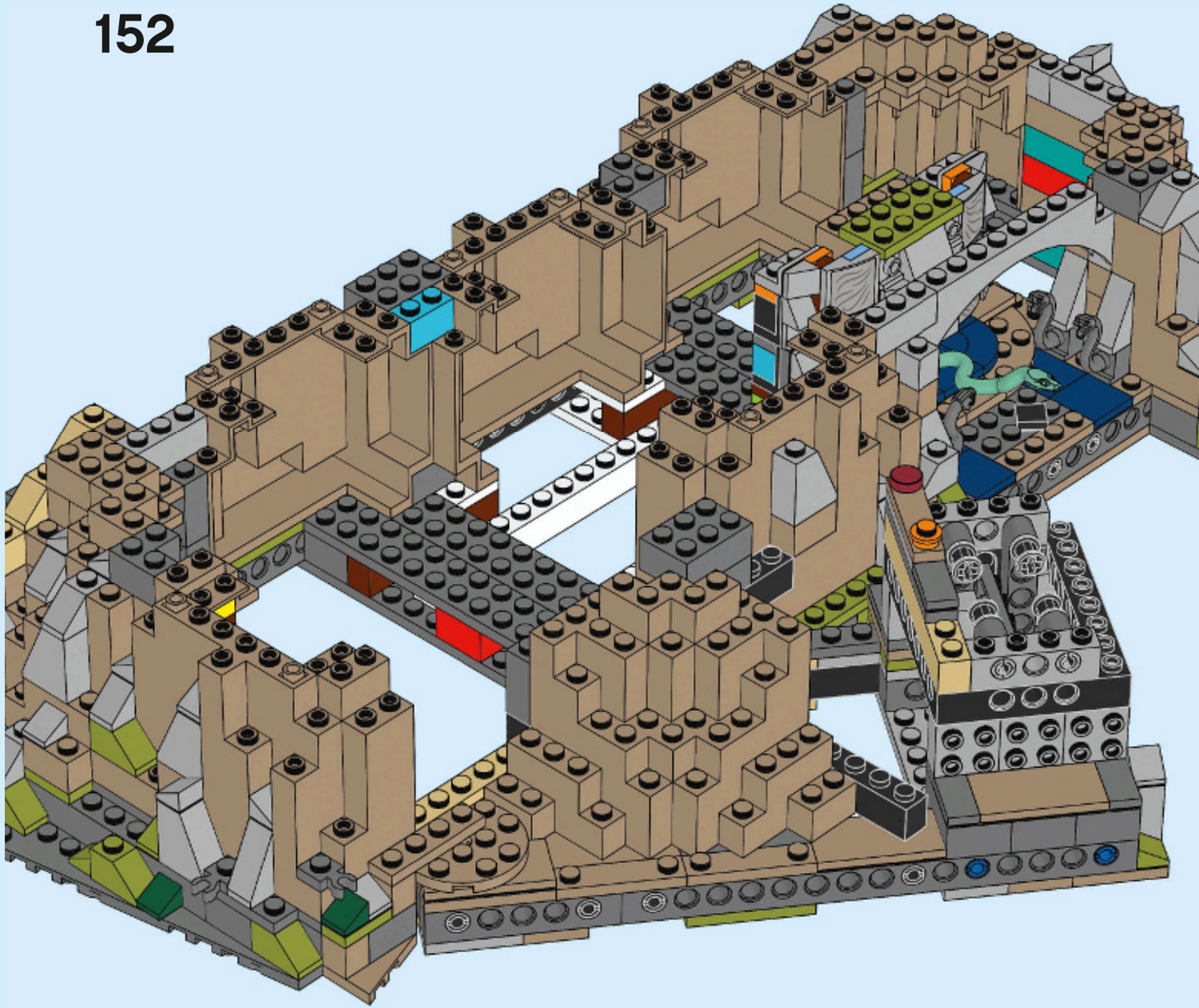

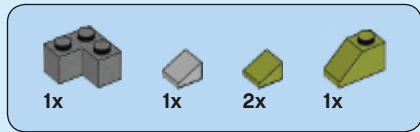

153

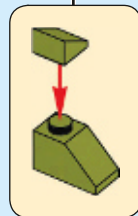

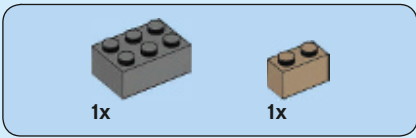

154

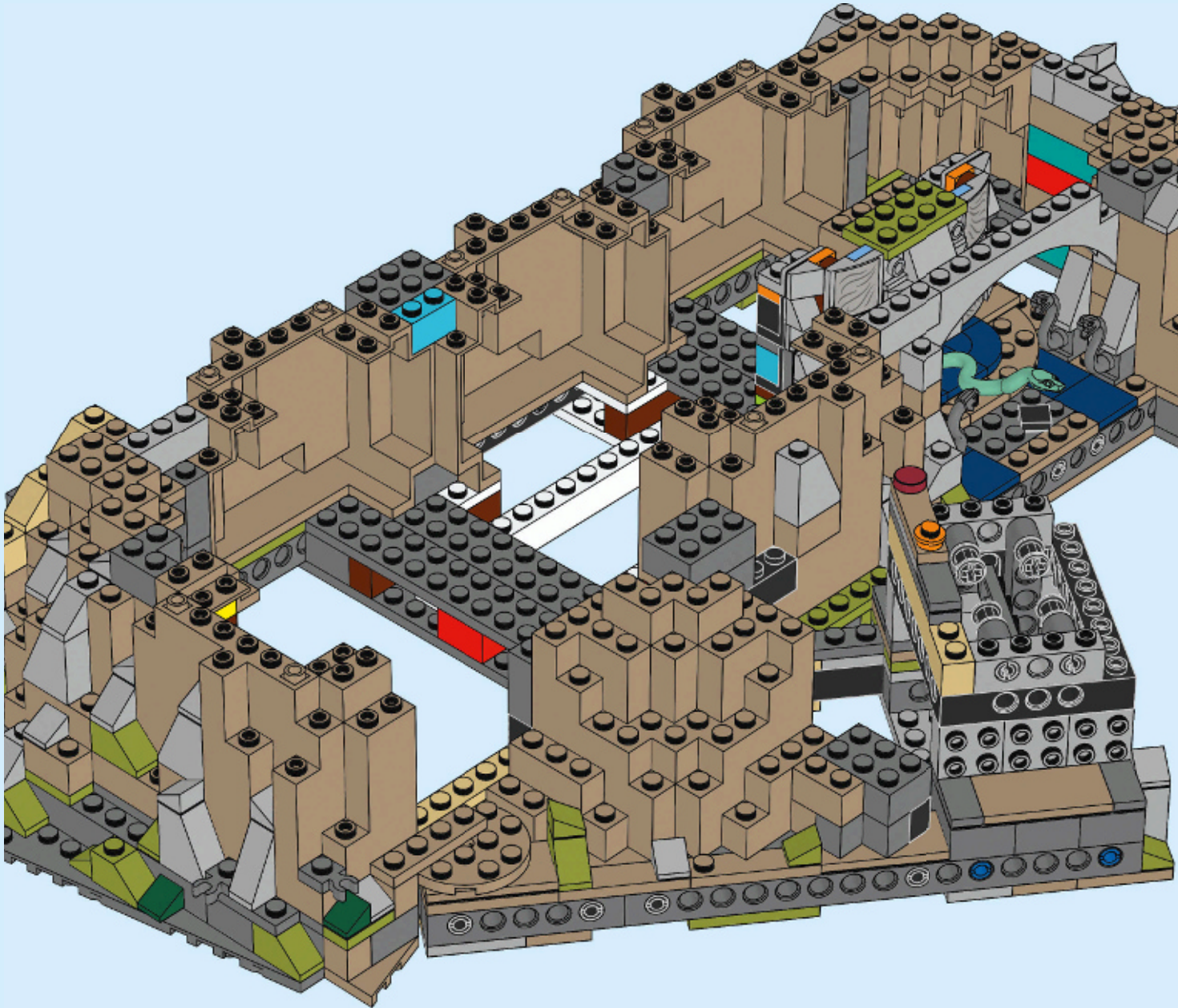



155

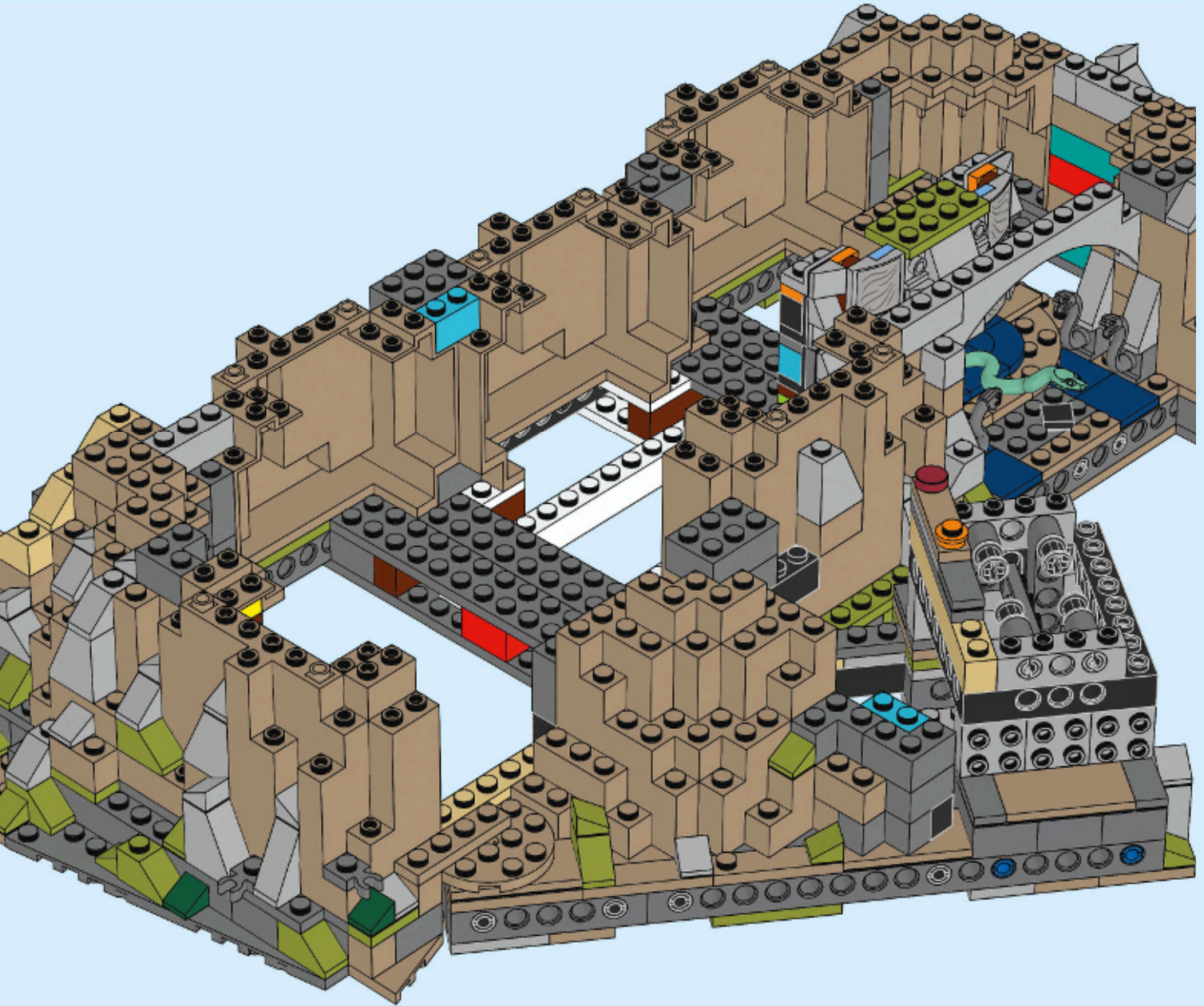

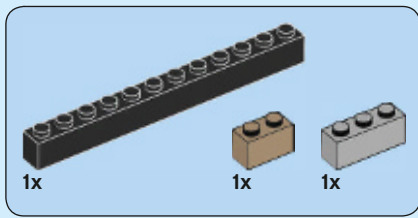

156



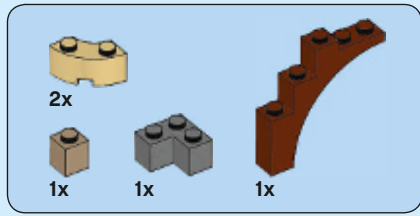

157



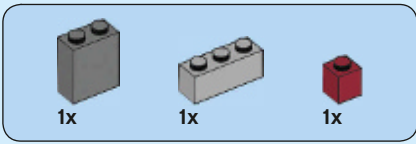

158



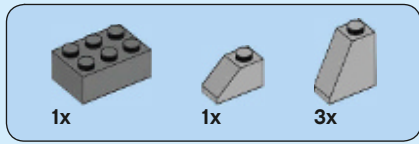

159



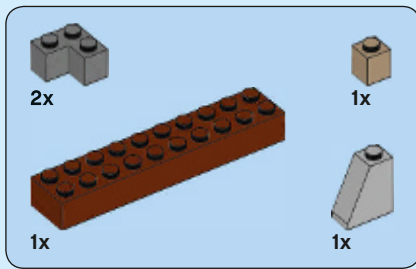

160



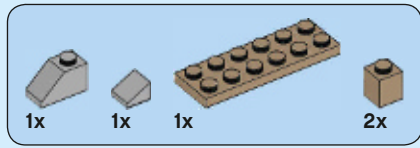

161



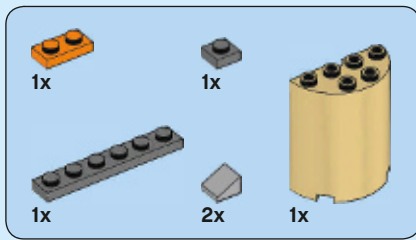

162



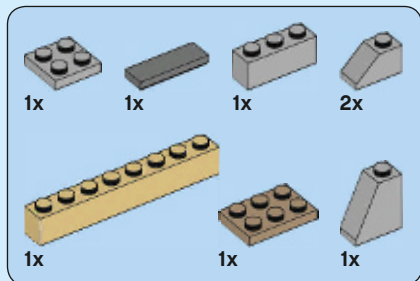

163

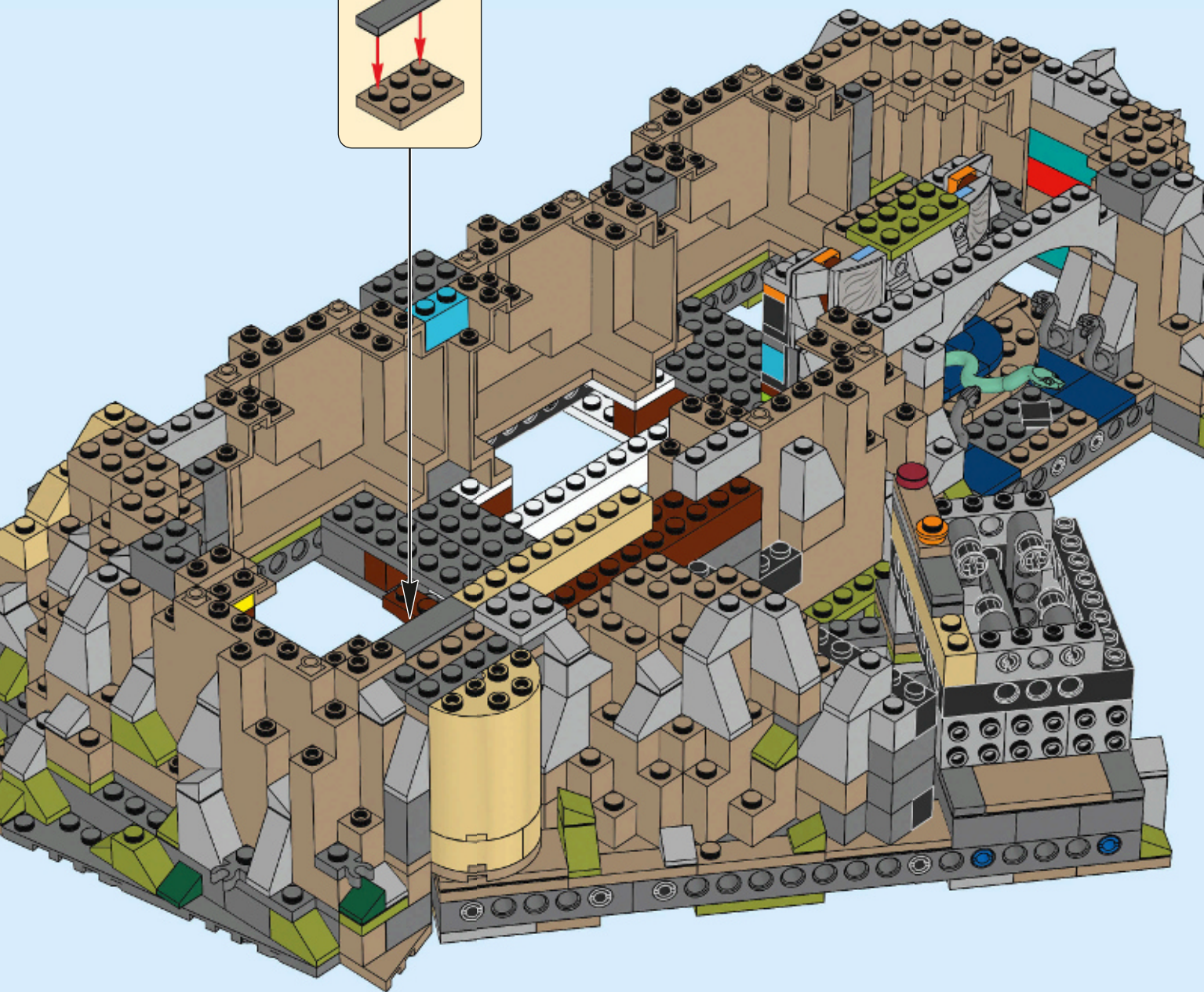
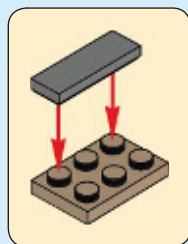

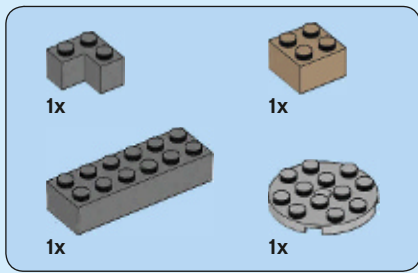

164

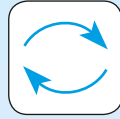

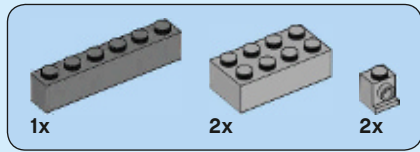

165



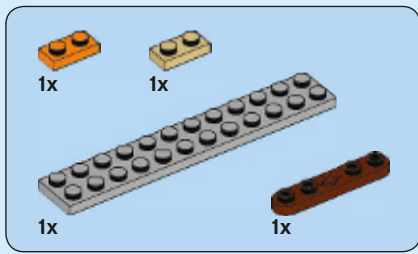

166

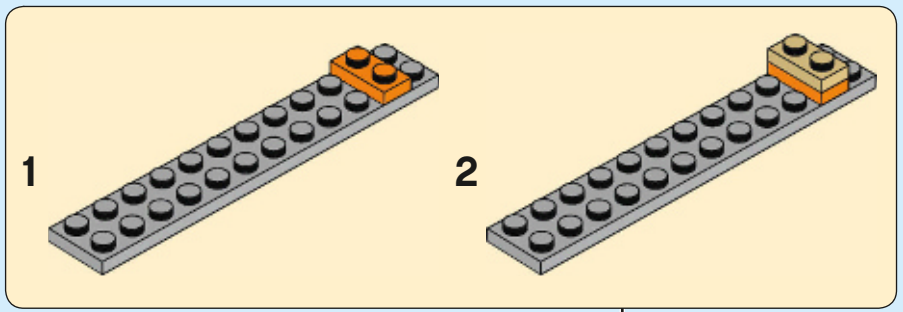

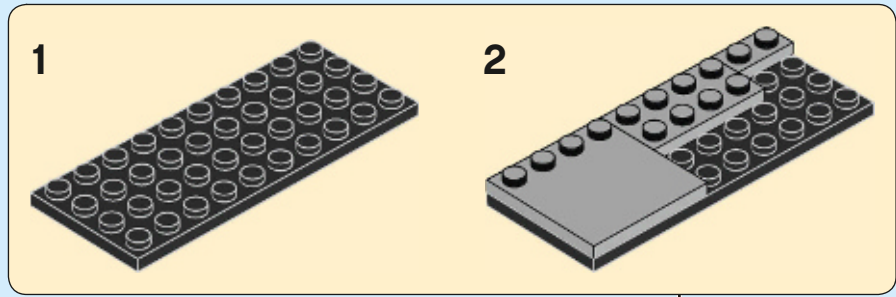
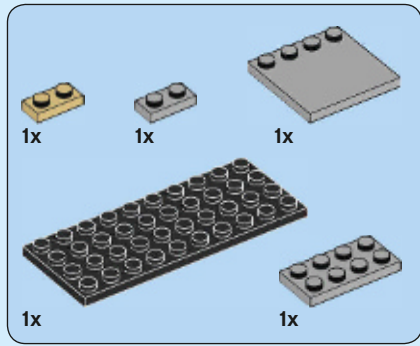

167



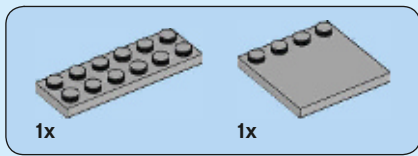

168

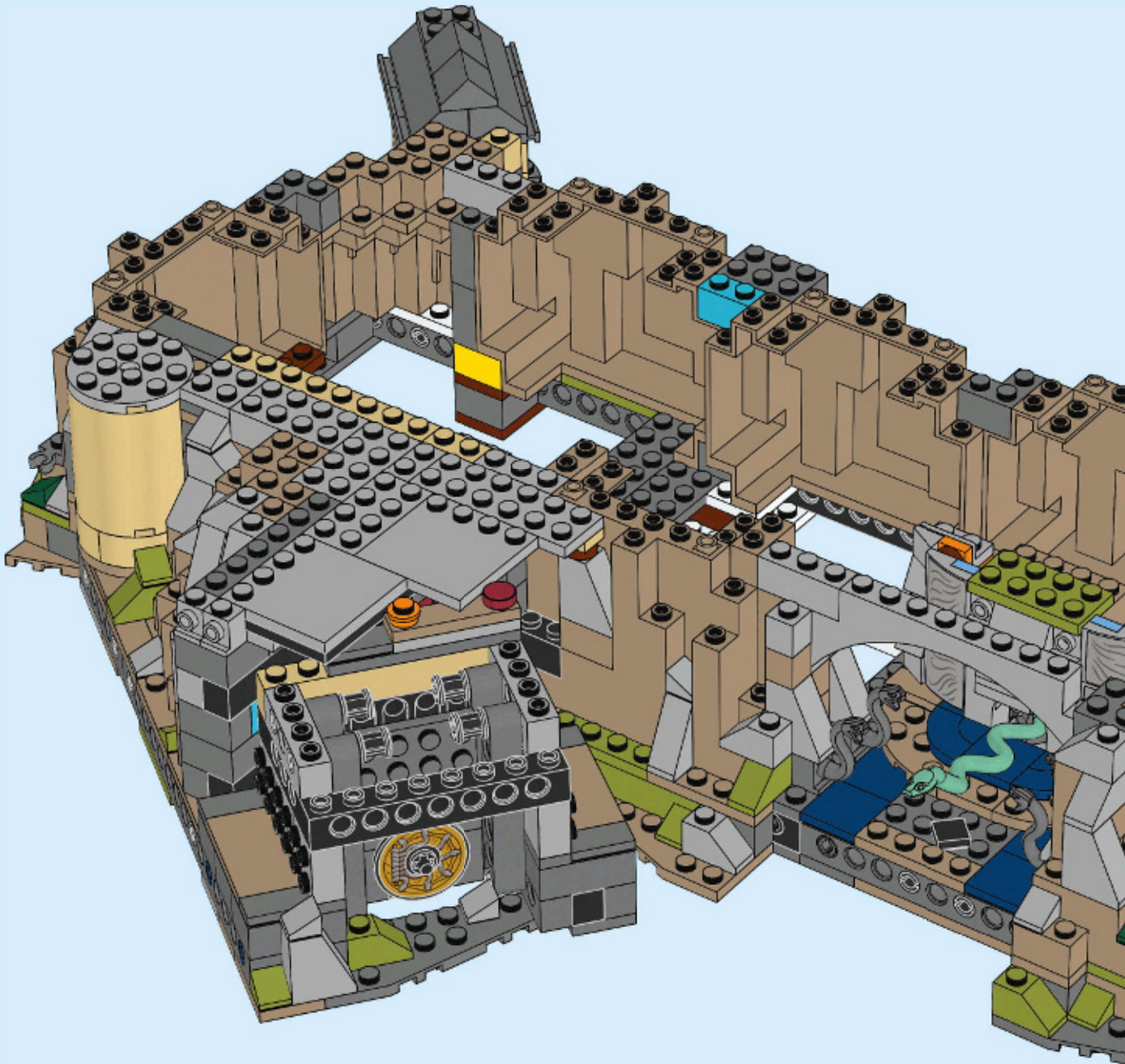

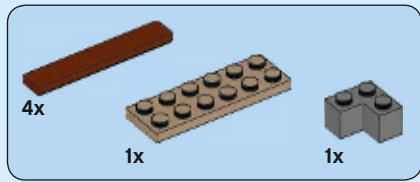

169

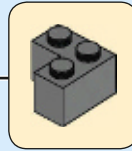



170

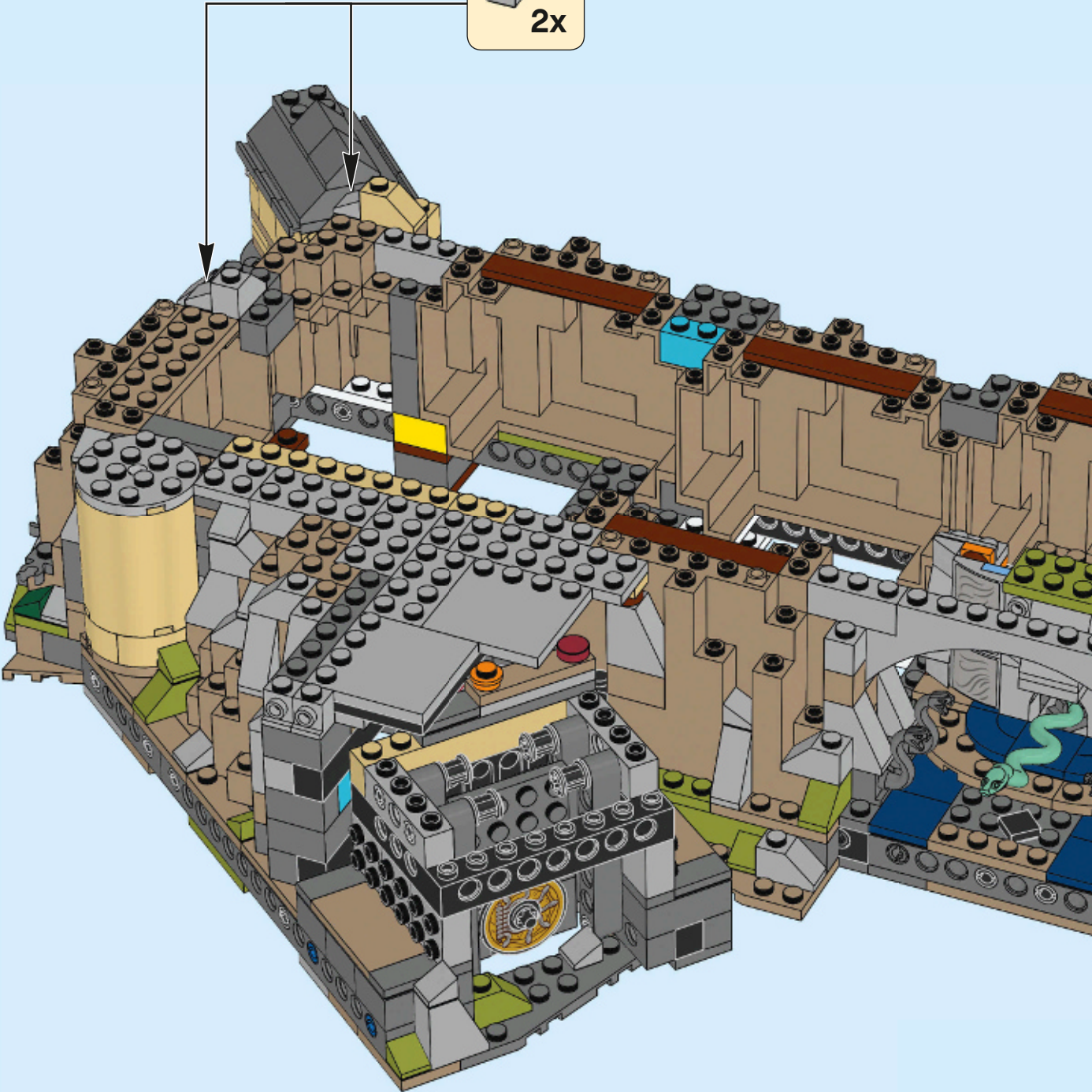
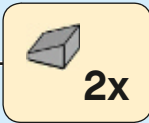

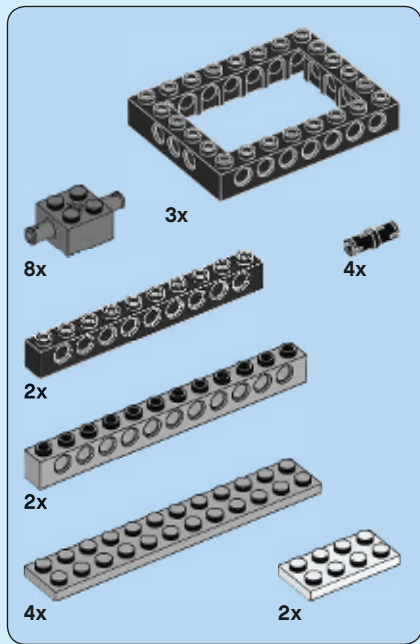

171

1

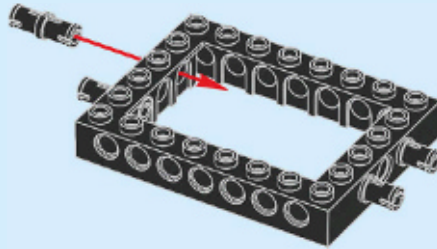

2

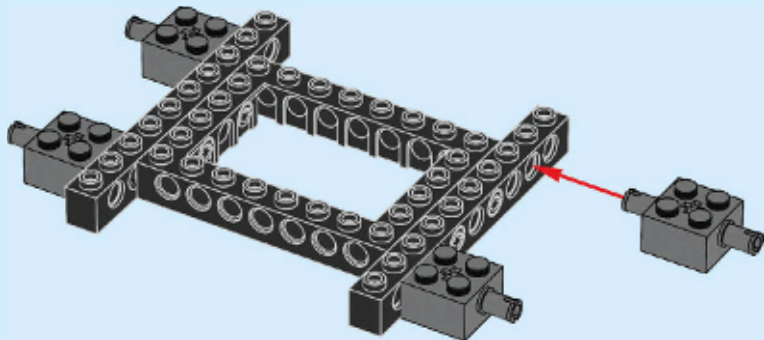

3

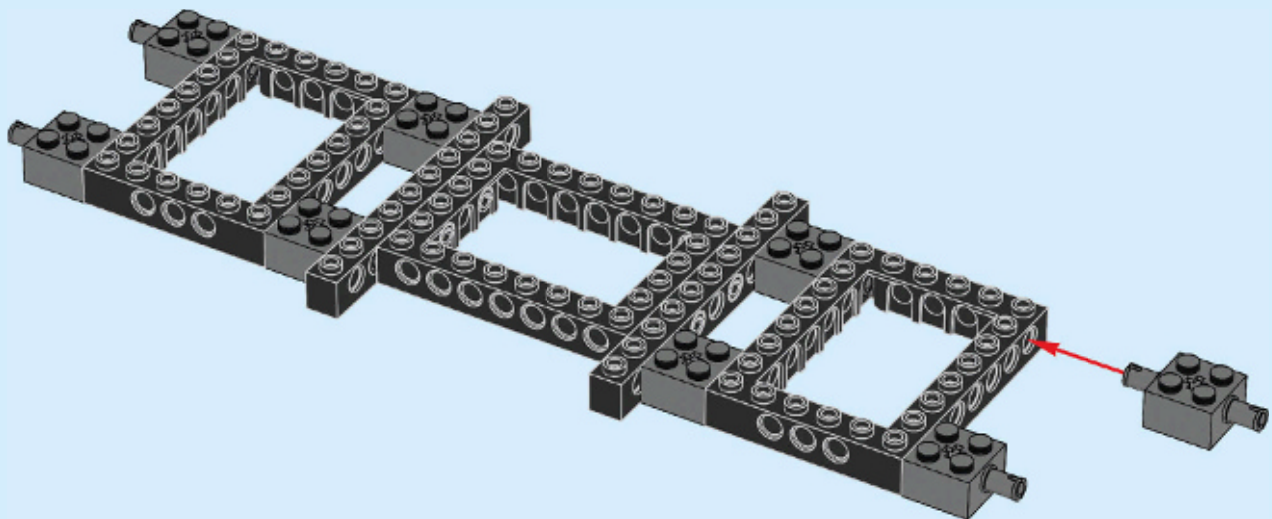

4

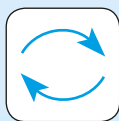
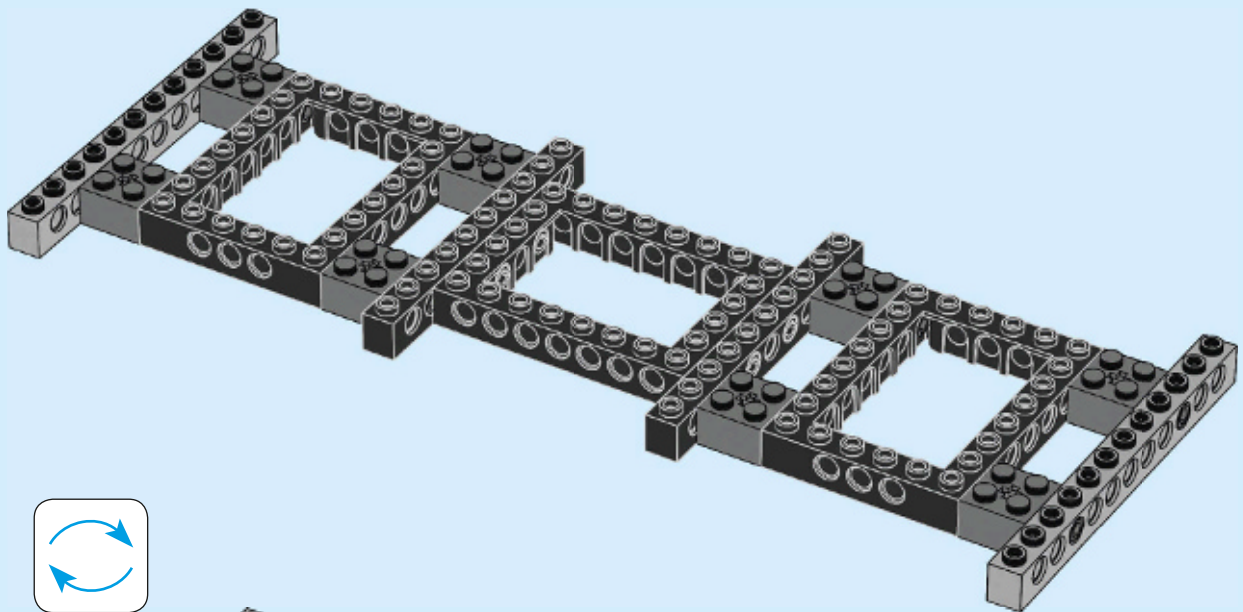

5

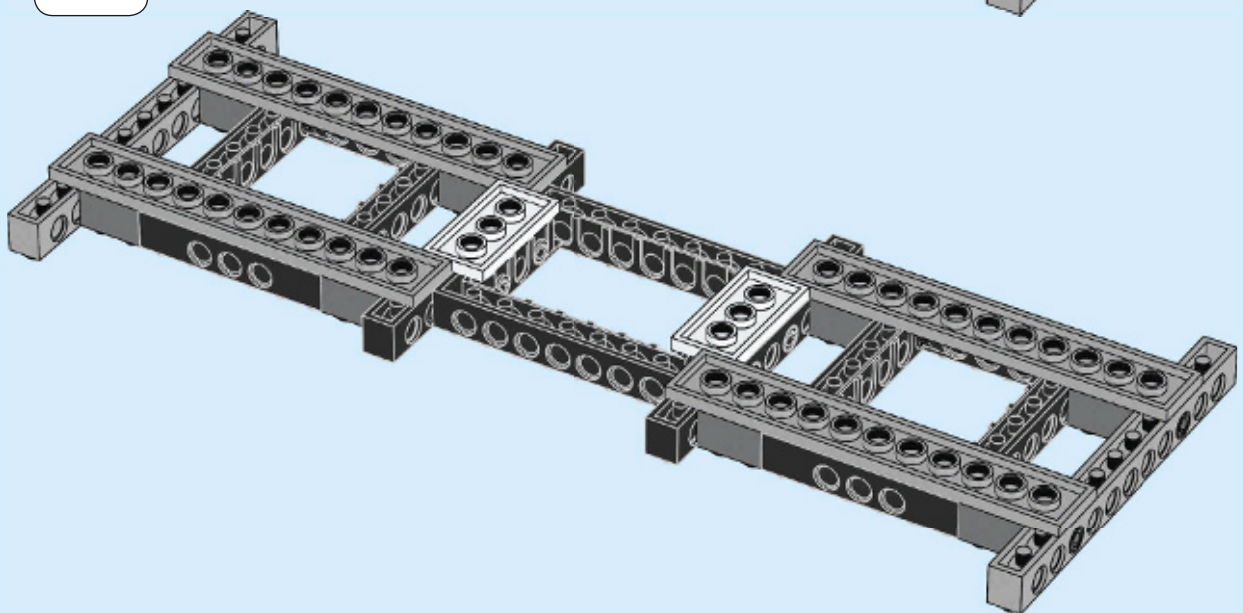

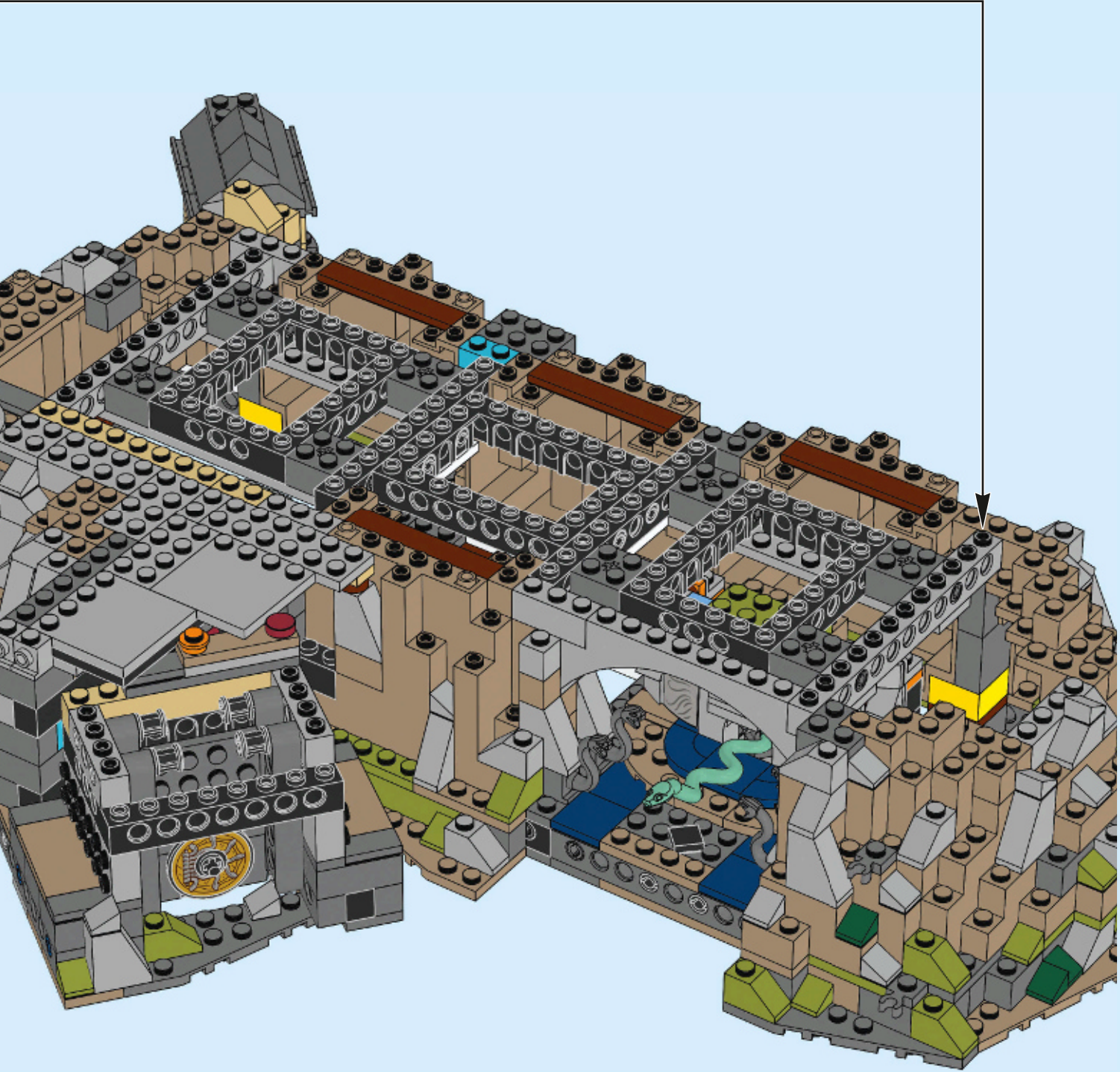

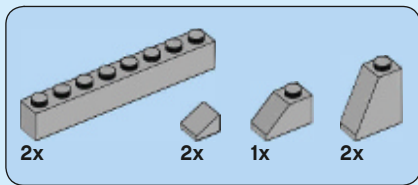

173





6x



4x



2x

174

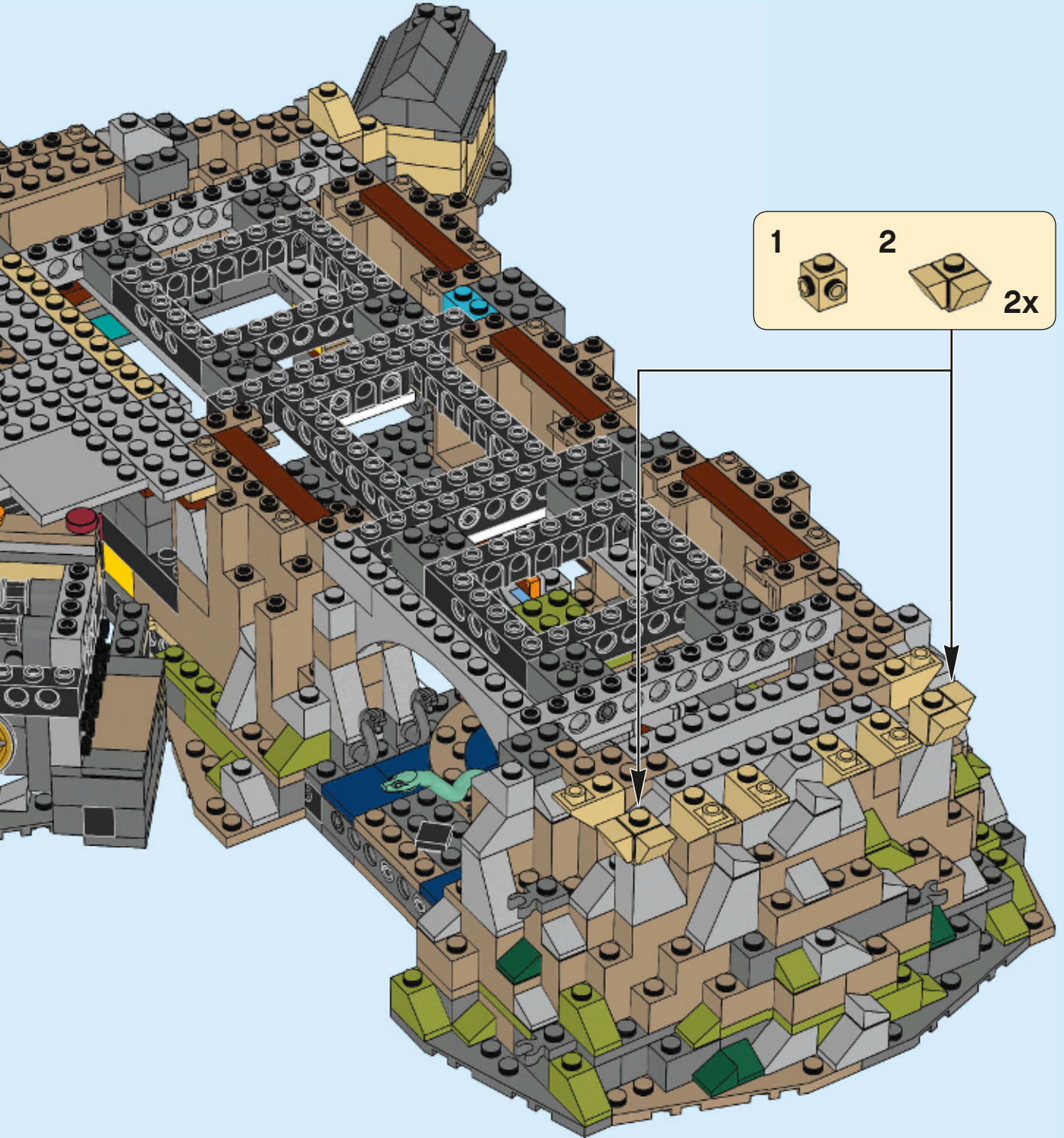

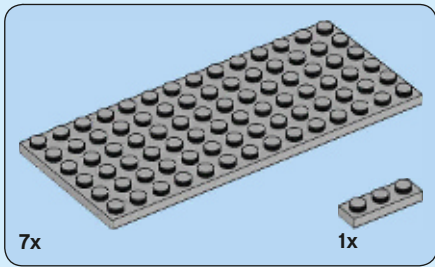

175

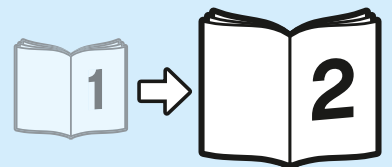
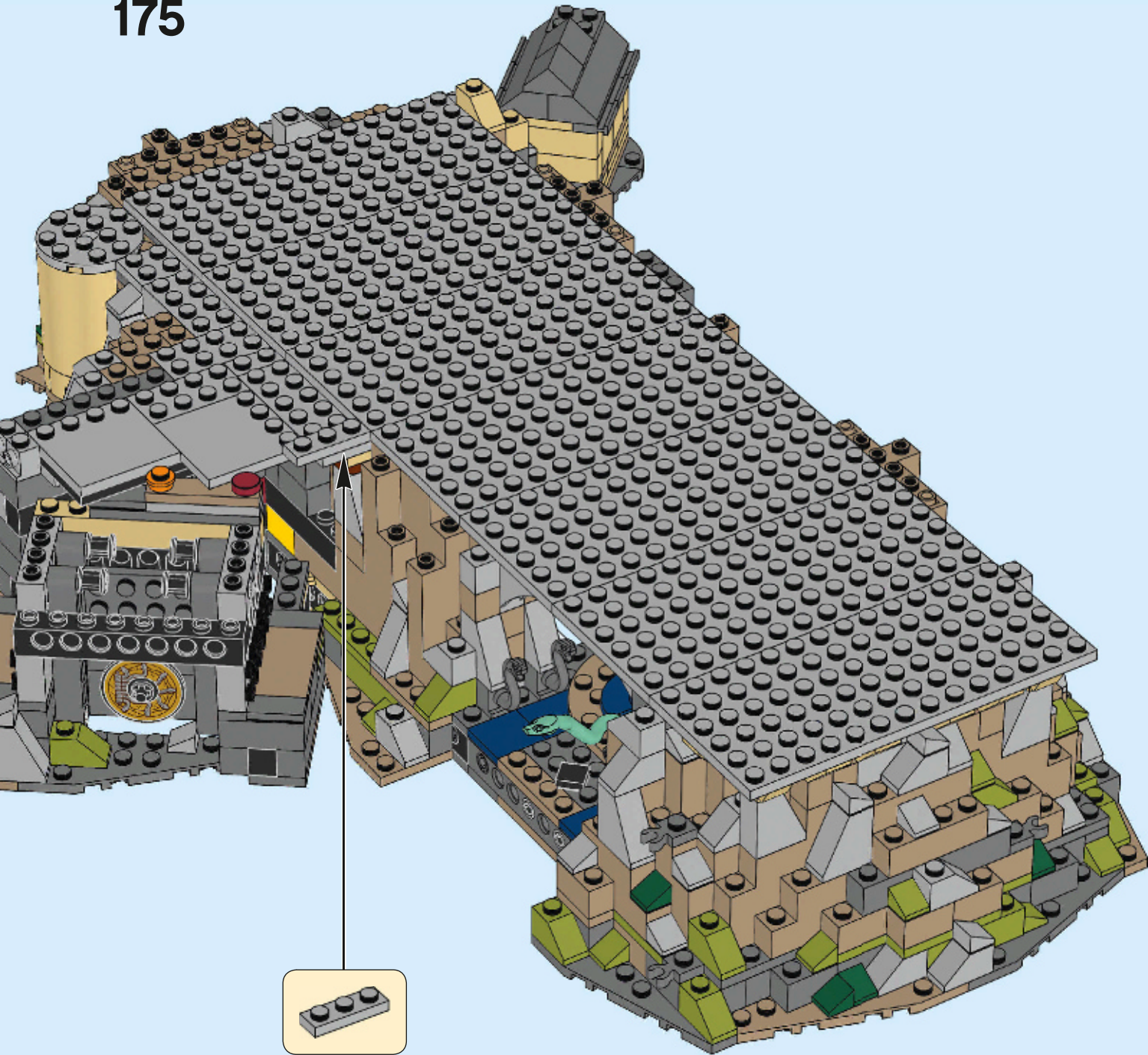

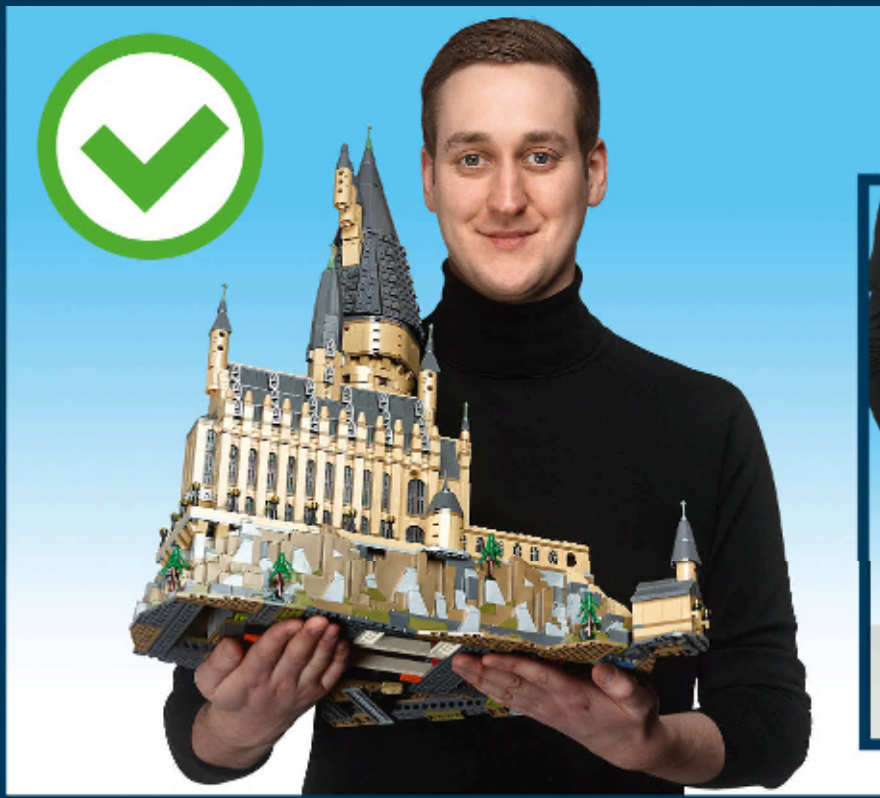



LEGO.com/life



WIN

GO TO WWW.LEGO.COM/PRODUCTFEEDBACK
AND GIVE US YOUR SHORT **FEEDBACK**
ABOUT THIS LEGO® SET FOR A CHANCE
TO WIN A COOL LEGO PRIZE.

Terms & Conditions apply



LEGO.com/productfeedback

GEWINNE

Erzähle uns auf
www.LEGO.com/productfeedback

etwas über die Erfahrungen, die du mit
diesem LEGO® Set gemacht hast, und
sichere dir die Chance auf einen coolen
LEGO Preis!

Es gelten die Teilnahmebedingungen

GAGNE

Rends-toi sur
www.LEGO.com/productfeedback

et donne-nous quelques commentaires
sur ce produit LEGO® pour avoir une
chance de gagner un prix LEGO !

Voir Conditions Générales

GANAN

Visita
www.LEGO.com/productfeedback

y envíanos tu opinión acerca de este
set LEGO®. ¡Participarás en el sorteo
de un premio LEGO!

Términos y Condiciones aplicables

获取奖品

登录
www.LEGO.com/productfeedback

给出关于此乐高®套装的简短反馈，
就有机会获得炫酷乐高奖品

《条款及条件》适用

경품 당첨 기회

www.LEGO.com/productfeedback

페이지로 이동하여 이 레고® 세트에 대한
간략한 피드백을 보내 주시고 멋진 레고
경품을 탈 수 있는 기회도 잡으십시오

약관 적용

ЗАПОЛНИ АНКЕТУ И ПОЛУЧИ ПРИЗ

Перейди по ссылке
www.LEGO.com/productfeedback

ответь всего на несколько вопросов
об этом наборе LEGO®, и у тебя появ-
ится шанс выиграть замечательный
приз от компании LEGO.

Применяются Условия и правила
участия



LEGO and the LEGO logo are trademarks of the/son des marques de commerce du/son marcas registradas de LEGO Group. ©2018 The LEGO Group.
Anglia is a trademark owned and licensed by Ford Motor Company.
HARRY POTTER characters, names and related indicia are © & ™ Warner Bros. Entertainment Inc. WB SHIELD: © & ™ WBEI.
WIZARDING WORLD trademark and logo © & ™ Warner Bros. Entertainment Inc.
Publishing Rights © JKR. (s18)

6254647