



NINJAGO™

Masters of Spinjitzu

70743

AIRJITZU™ MORRO



1



2



3



4



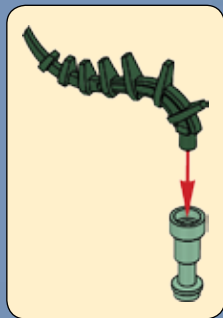



2x



2x



1x

1



2



3



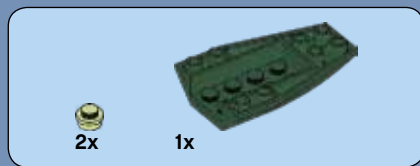

1

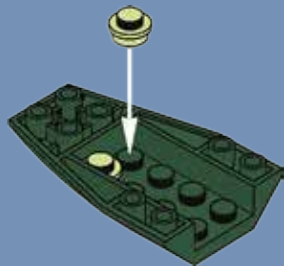

2





1x

3

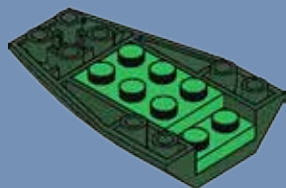

6



1x

4

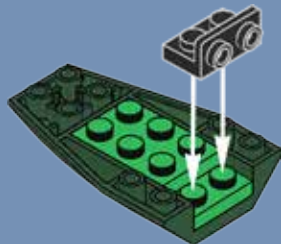

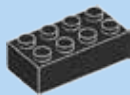

1x

5

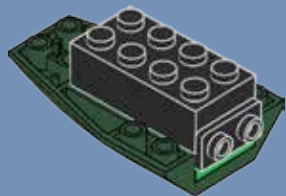

1x

6

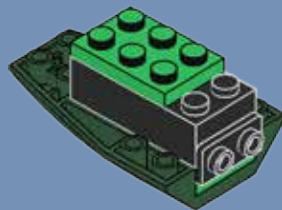



1x

7

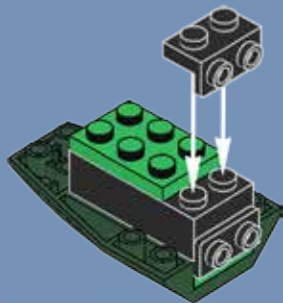

8



2x



2x

8

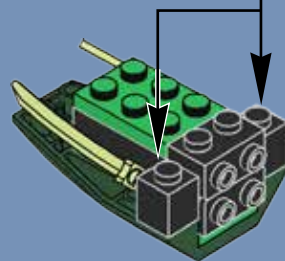
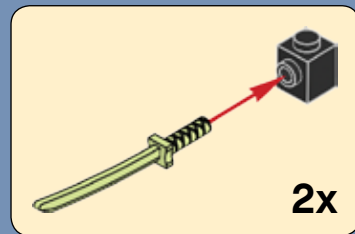



1x

9

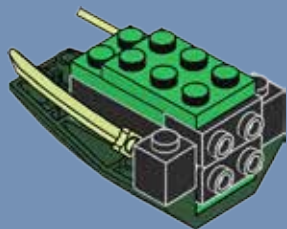

1x

10

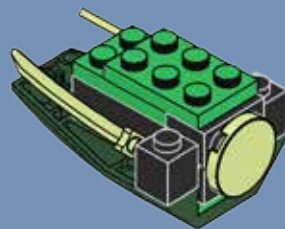

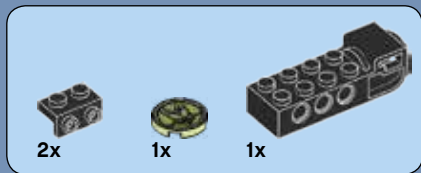

11

1

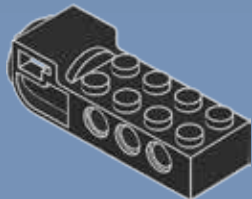

2

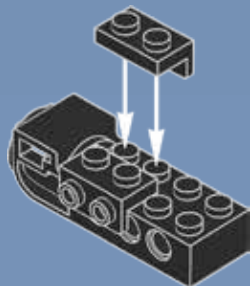

3

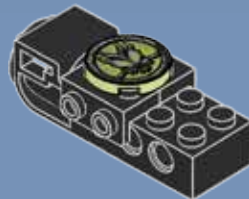

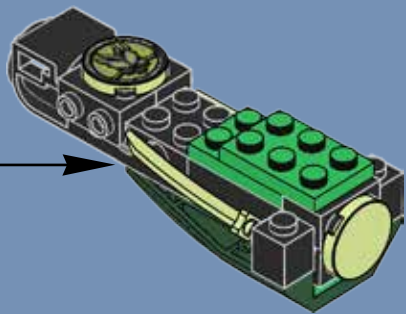

12

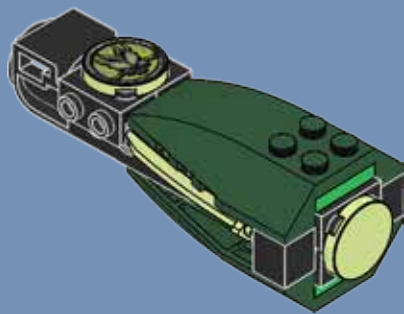



2x

13

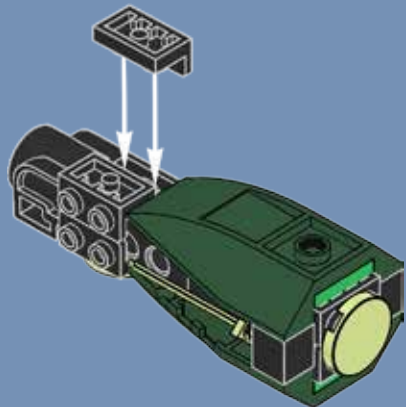
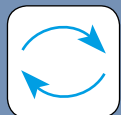

1x

14

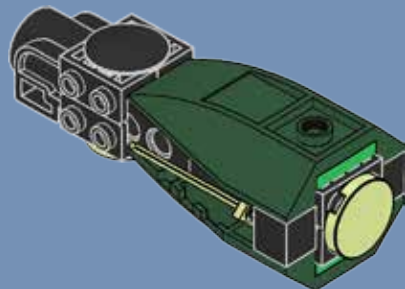



2x

15

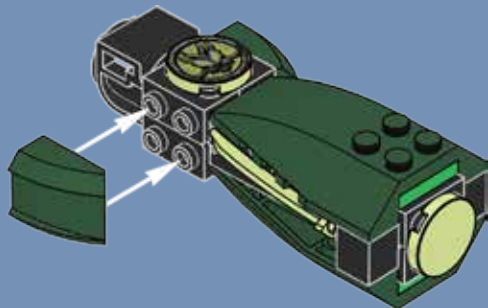

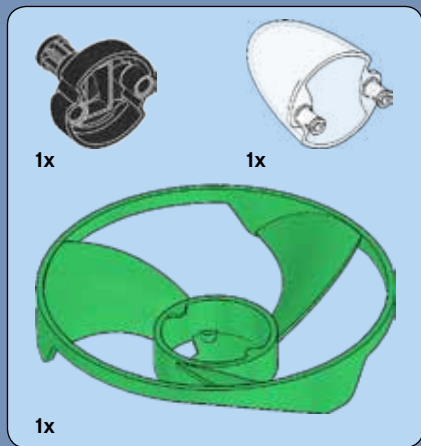

16

1



2



3

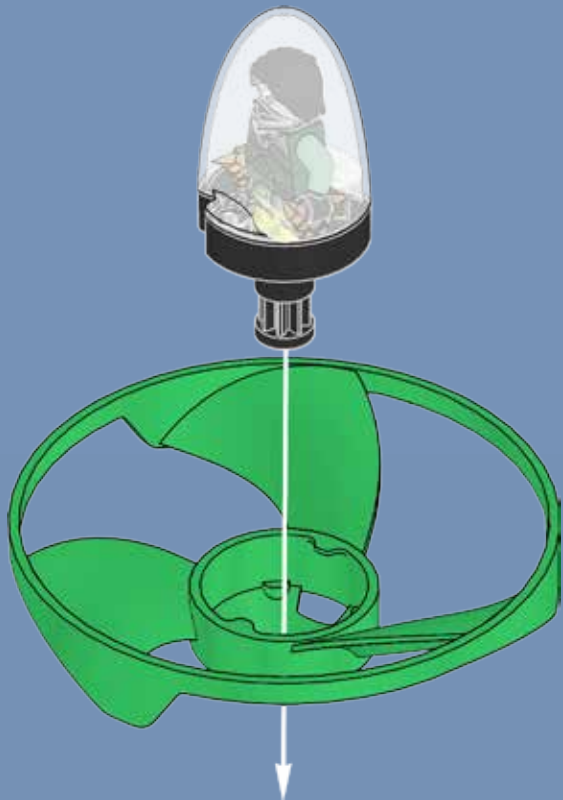

4



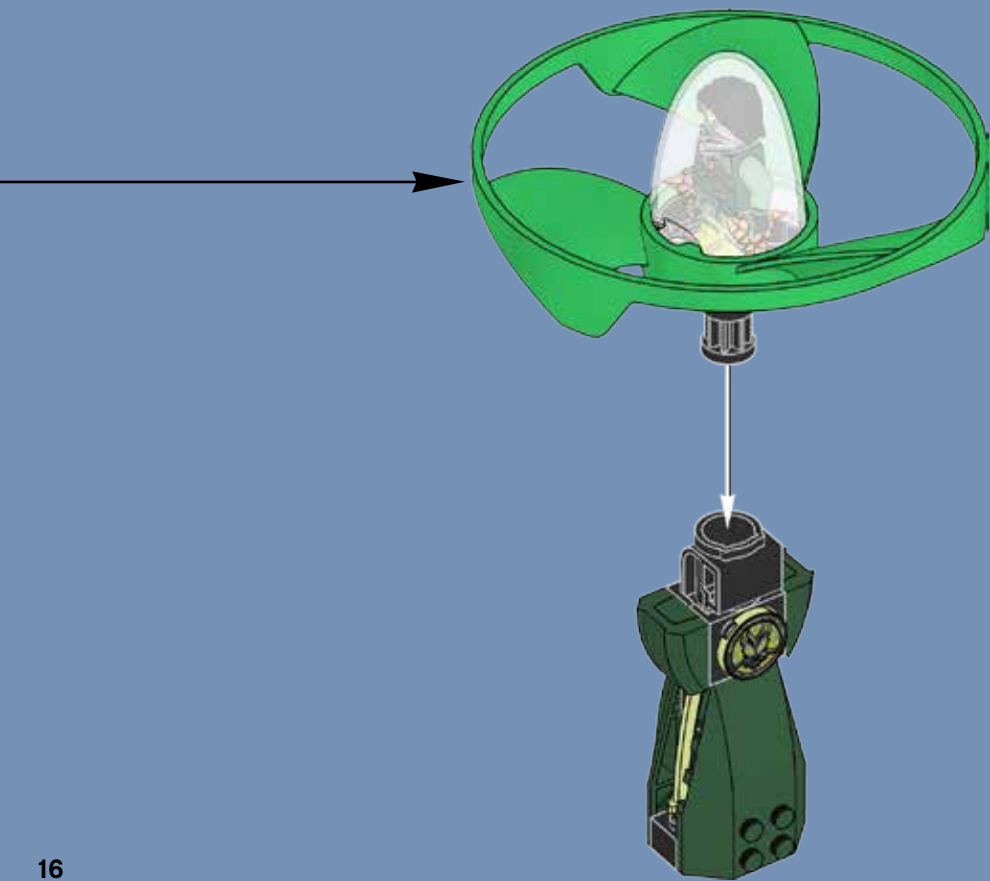

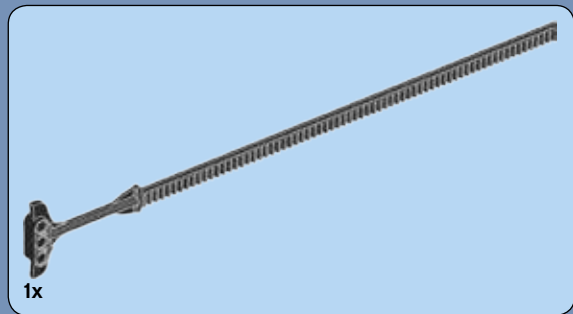

17





NINJAGOTM
Masters of Spinjitzu



AIRJITZUTM



3 FLY
FLIEGEN . VOLE
VUELA . VOAR
REPÛL . 飞行

2 RIP
ZIEHEN . TIRE
TIRA . DISPARAR
RANT . 撕裂

1 BUILD
BAUEN . CONSTRUIS
CONSTRUYE
CONSTRUIR . ÉPÎT . 拼砌



NINJAGO™

Masters of Spinjitzu

COOL TRICKS ONLINE
COOLE TRICKS ONLINE . DES ASTUCES COOL EN LIGNE
LOS MEJORES TRUCOS ONLINE
TRUQUES FANTÁSTICOS ONLINE
VAGÁNY TRÜKKÖK ONLINE
在线炫酷技巧



WWW.LEGO.COM/AIRJITZU





NINJAGO™

Masters of Spinjitzu



70739



70740



70741



70742



70743



70744



NINJAGO™

Masters of Spinjitzu



LEGO

NINJAGO™

Masters of Spinjitzu



70736



70735



70738



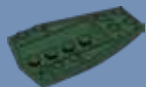

1x
6113029



1x
300126



1x
4568933



2x
6004345



2x
6057898



1x
6109894



1x
4652932



2x
4558954



1x
6054856



1x
4649065



1x
6115726



4x
302128



1x
6127359



2x
6066102



1x
4656377



2x
6070905



1x
6113047



2x
6116600

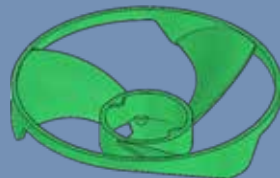

1x
6121337



1x
6115008



3x
6020193

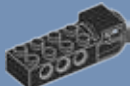

1x
6110042



1x
6114925



1x
6115089



1x
6108477



1x
4294148



3x
6016172



1x
6110044



2x
6113046



1x
4140303



1x
6109891



1x
6110044



1x
6109891



1x
6110044



1x
6109891



1x
6110044



1x
6109891



1x
6110044



1x
6109891



1x
6110044



1x
6109891



1x
6110044



1x
6109891



1x
6110044



1x
6109891



1x
6110044



1x
6109891



1x
6110044



1x
6109891



1x
6110044



1x
6109891



1x
6110044



1x
6109891



1x
6110044



1x
6109891



1x
6110044



1x
6109891



1x
6110044



1x
6109891



1x
6110044



1x
6109891



1x
6110044



1x
6109891



1x
6110044



1x
6109891



1x
6110044



1x
6109891



1x
6110044



1x
6109891



1x
6110044



1x
6109891



1x
6110044



1x
6109891



1x
6110044



1x
6109891



1x
6110044



1x
6109891



1x
6110044



1x
6109891



1x
6110044



1x
6109891



1x
6110044



1x
6109891



1x
6110044



1x
6109891



1x
6110044



1x
6109891



1x
6110044



1x
6109891



1x
6110044



1x
6109891



1x
6110044



1x
6109891



1x
6110044



1x
6109891



1x
6110044



1x
6109891



1x
6110044



1x
6109891



1x
6110044



1x
6109891



1x
6110044



1x
6109891



1x
6110044



1x
6109891



1x
6110044



1x
6109891



1x
6110044



1x
6109891



1x
6110044



1x
6109891



1x
6110044



1x
6109891



1x
6110044



1x
6109891



1x
6110044



1x
6109891



1x
6110044



1x
6109891



1x
6110044



1x
6109891



1x
6110044



1x
6109891



1x
6110044



1x
6109891



1x
6110044



1x
6109891



1x
6110044



1x
6109891



1x
6110044



1x
6109891



1x
6110044



1x
6109891



1x
6110044



1x
6109891



1x
6110044



1x
6109891



1x
6110044



1x
6109891



1x
6110044



1x
6109891