



LEGENDS OF  
**CHIMA**

70004



EN IMPORTANT: Never modify the elements or use other projectiles than provided with this toy.  
 DE WICHTIG: Die Elemente dürfen nicht verändert werden. Es dürfen ausschließlich die mit dem Spielzeug mitgelieferten Geschosse verwendet werden.  
 FR IMPORTANT : Ne jamais modifier les éléments ni utiliser d'autres projectiles que ceux fournis avec ce jouet.  
 IT IMPORTANT: non modificare gli elementi o utilizzare proiettili non forniti con questo prodotto.  
 NL BELANGRIJK! Verander niets aan de elementen en gebruik geen andere projectielen dan de bij het speelgoed geleverde.  
 ES IMPORTANTE: No modifique los elementos ni utilice otros proyectiles diferentes a los suministrados junto con este juguete.  
 DA VIGTIGT: Elementerne må ikke ændres, og der må ikke bruges andre projektiler end dem, der følger med legetøjet.  
 FI TÄRKEÄÄ: Älä koskaan tee osiin muutoksia tai käytä lelussa muita kuin sen sisältämiä ammuksia.  
 SV VIKTIGT: Modifiera aldrig delarna och använd aldrig andra projektiler än de som medföljer denna leksak.  
 PT IMPORTANTE: Nunca modifique os elementos nem utilize projécteis que não tenham sido fornecidos com este brinquedo.  
 EL ΣΗΜΑΝΤΙΚΟ: Ποτέ μην τροποποιείτε τα στοιχεία του παιχνιδιού και μην χρησιμοποιείτε άλλα βλήματα εκτός από αυτά που συνοδεύουν αυτό το παιχνίδι.  
 JA 重要：部品を改造したり、本製品に付属の発射体以外のものを使用しないでください。  
 ZH 重要提示：切勿更改组件或使用并非由本玩具附带的弹丸。  
 KO 중요함: 이들 부품을 수정하거나 이 완구와 함께 제공된 것이 아닌 발사체는 결코 사용하지 마십시오.  
 RU ВАЖНО: запрещается вносить изменения в элементы или использовать другие снаряды, отличные от тех, которые поставляются с данной игрушкой.  
 PL WAŻNE: Nigdy nie modyfikować elementów zabawki ani nie używać pocisków innych niż dostarczone z zabawką.  
 CZ UPOZORNĚNÍ: Nikdy nepravujte součástky a nepoužívejte jiné projektily než ty, které jsou dodávány s touto hračkou.  
 SK UPOZORNENIE: Nikdy nepravujte súčiastky a nepoužívajte iné projektily než tie, ktoré sú dodávané s touto hračkou.  
 HU FONTOS: Az elemeket nem szabad módosítani, és a játékhöz adott lövedékek helyett sem szabad másat használni.  
 UA ВАЖЛИВО: забороняється вносити зміни до елементів або використовувати інші снаряди на відміну від тих, що поставляються з цією іграшкою.  
 HR VAŽNO: Nemojte nikad mijenjati elemente ili koristiti druge projektilne osim onih koji su bili priloženi uz ovu igračku prilikom kupnje.  
 SR Важно: Немојте да модификујете елементе и не користите друге пројектиле осим оних који долазе уз ову играчку.  
 SL POMEMBNO: Nikoli ne spreminjajte elementov in uporabljajte le izstrelke, ki so bili priloženi tej igrači.  
 RO IMPORTANT: Nu modificați niciodată elementele și nu utilizați alte proiectile decât cele furnizate cu această jucărie.  
 BG ВАЖНО: Не видоизменяйте елементите и не използвайте други снаряди освен приложените към тази играчка.  
 LV SVARĪGĪ! Nekad nepārveidojiet rotālietas elementus, vienmēr izmantojiet tikai tās komplektā iekļautās lodītes.  
 ET OLULINE: Mänguasja osi ei tohi teistega asendada, kasutada võib ainult kaasasolevat heitkeha.  
 LT DĖMESIO! Niekuomet nekeiskite elementų ir naudokite tik tuos šovinius, kurie yra pridėti prie šio žaislo.  
 TR ÖNEMLİ: Hiçbir zaman parçalarda değişiklik yapmayın veya bu oyuncakla sağlananlar dışında mermiler kullanmayın.







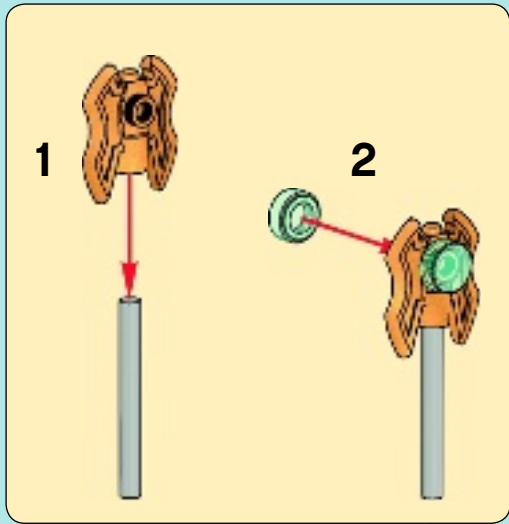

4

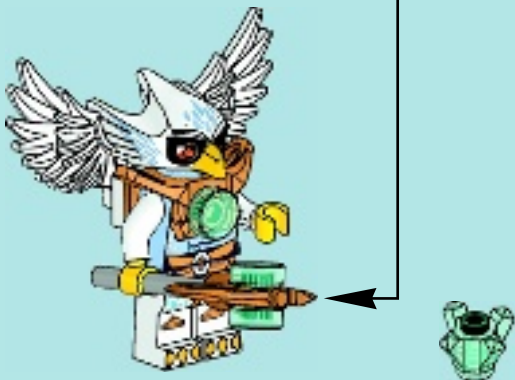



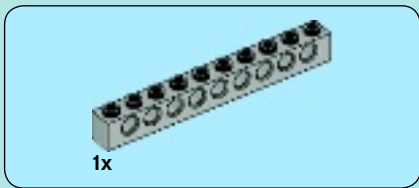

1

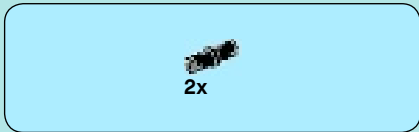
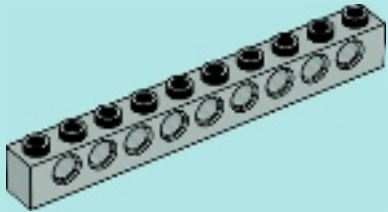

2

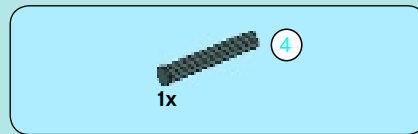
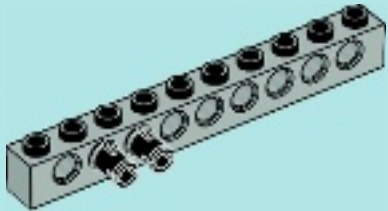

3

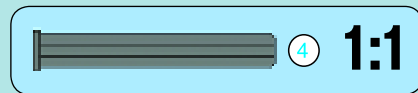
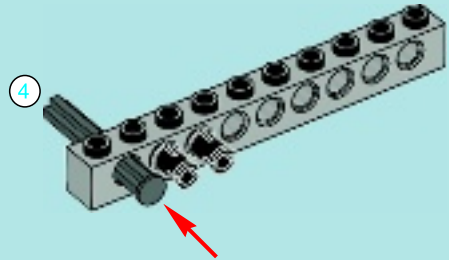

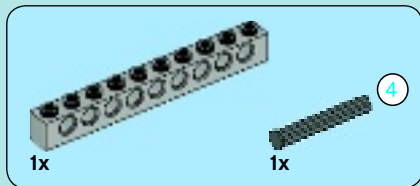

4

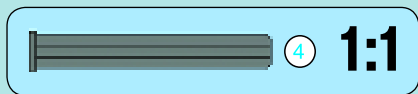
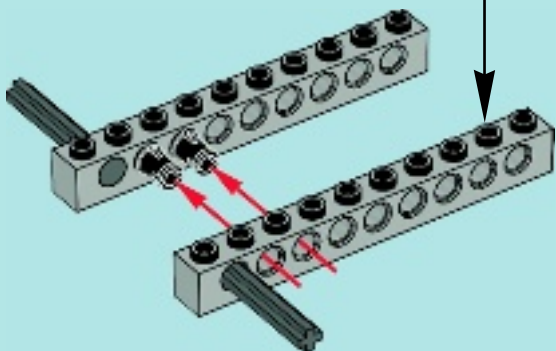
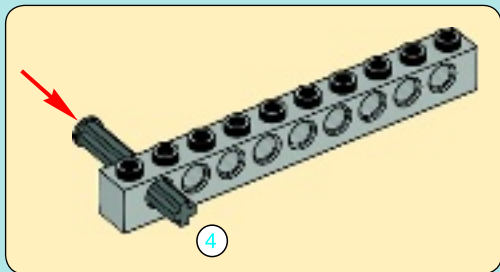

6

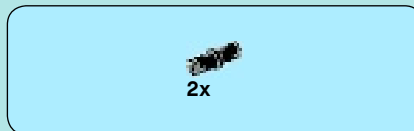

5

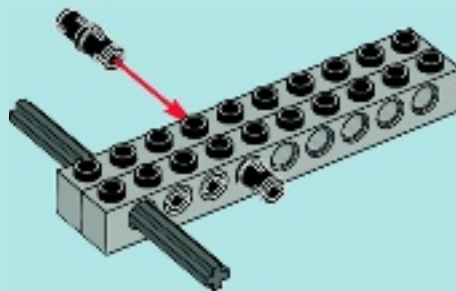

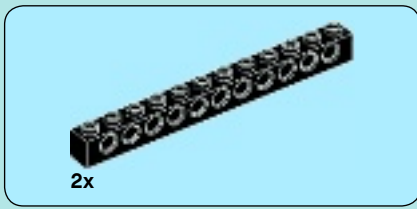

6

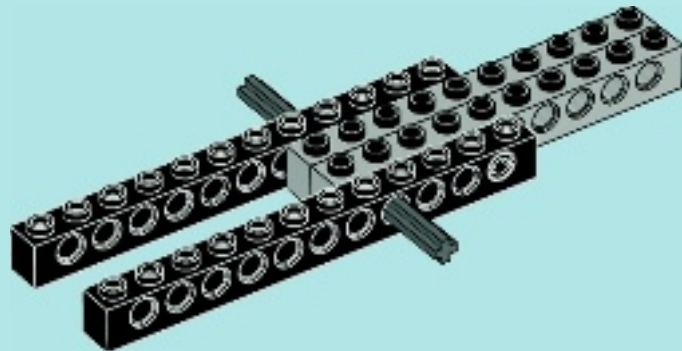





4x

7

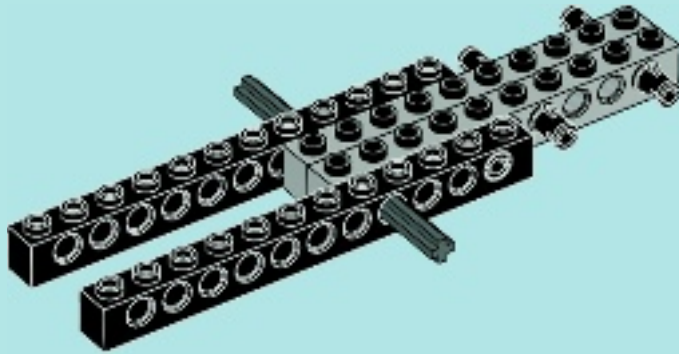

8

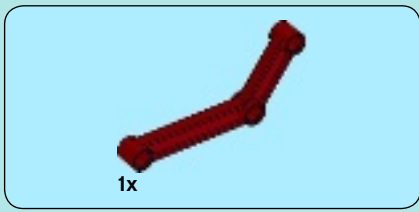

8

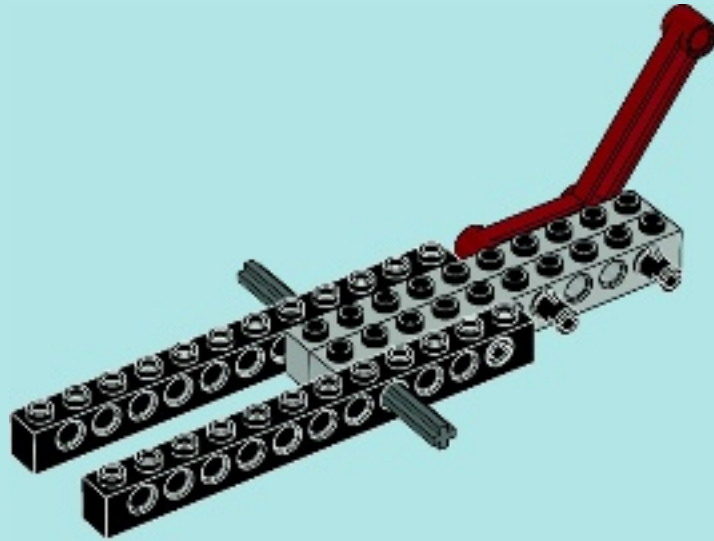

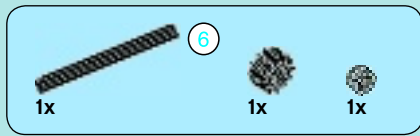

9

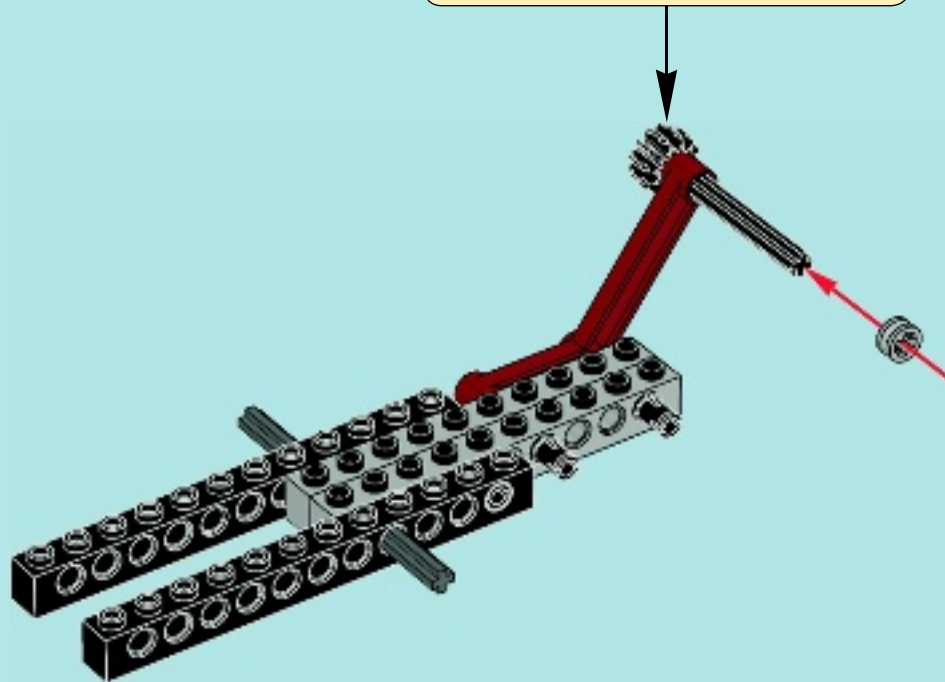
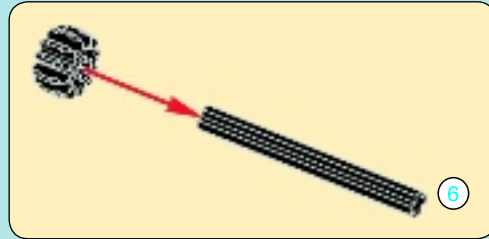





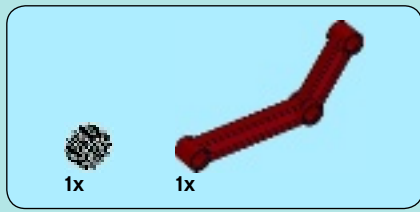

11

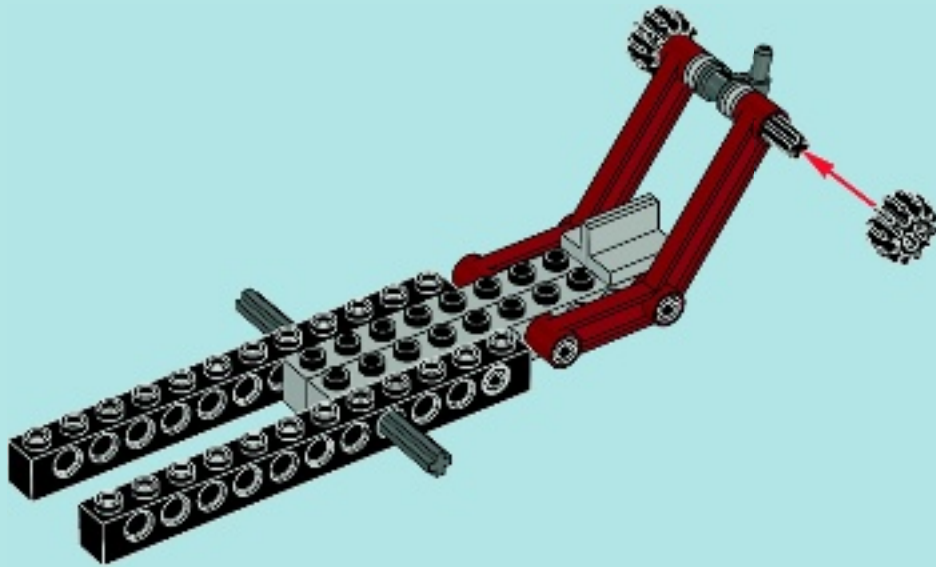



2x



2x

# 12

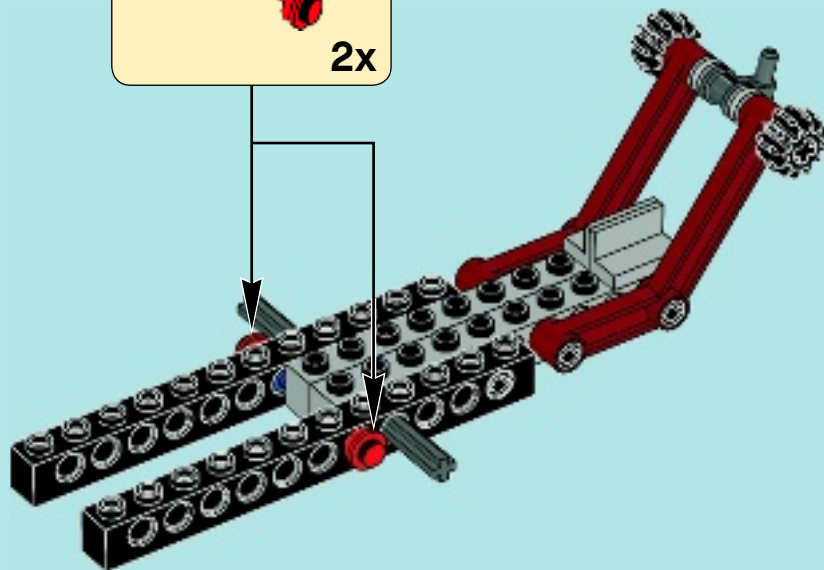
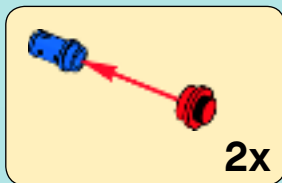





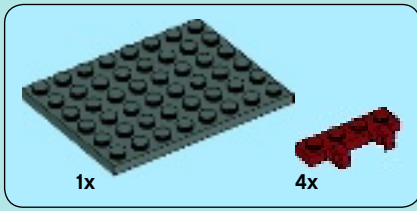

14

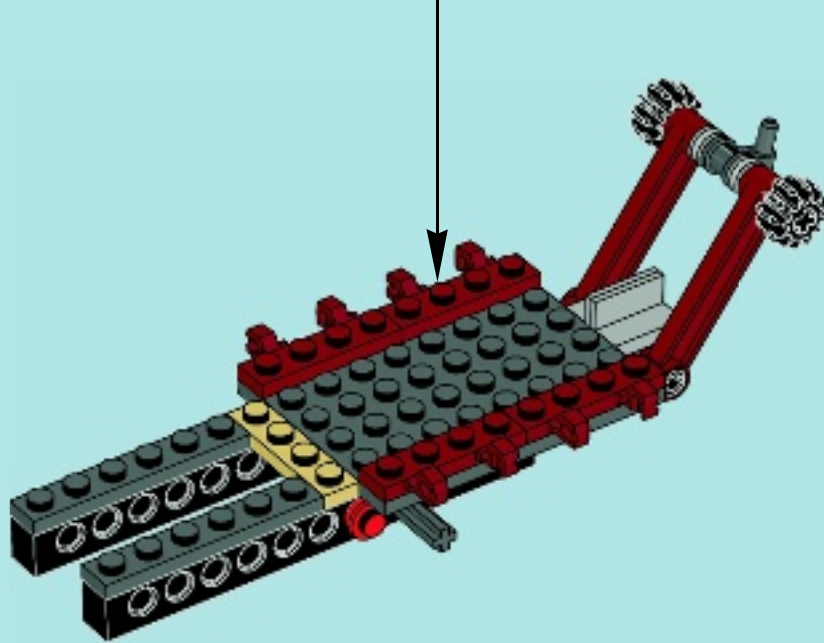
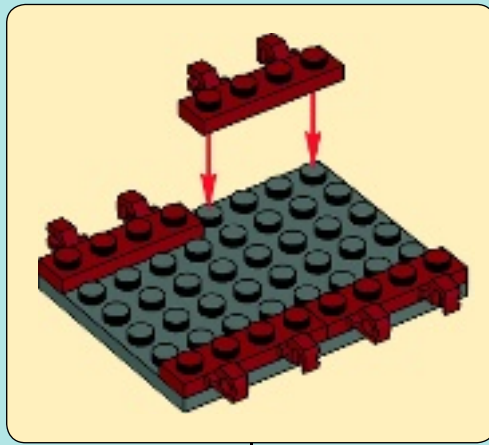



1x

# 15

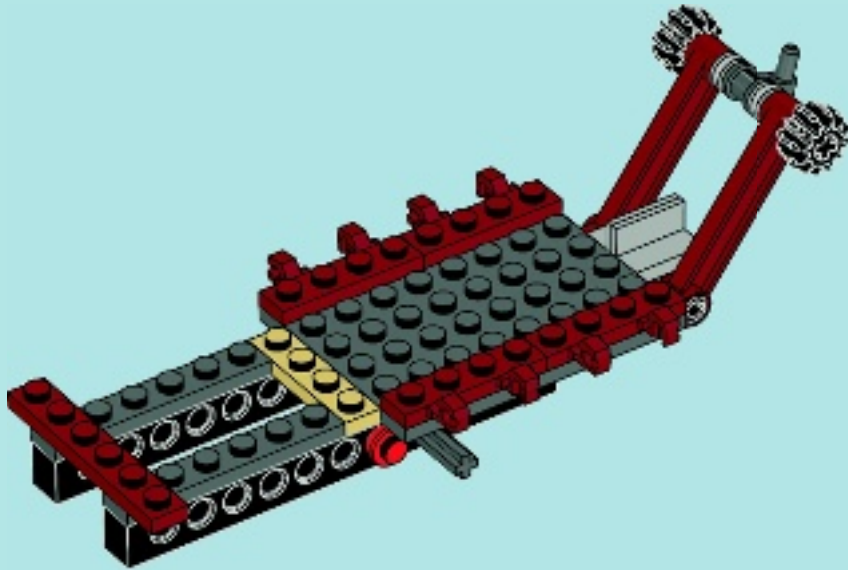



16

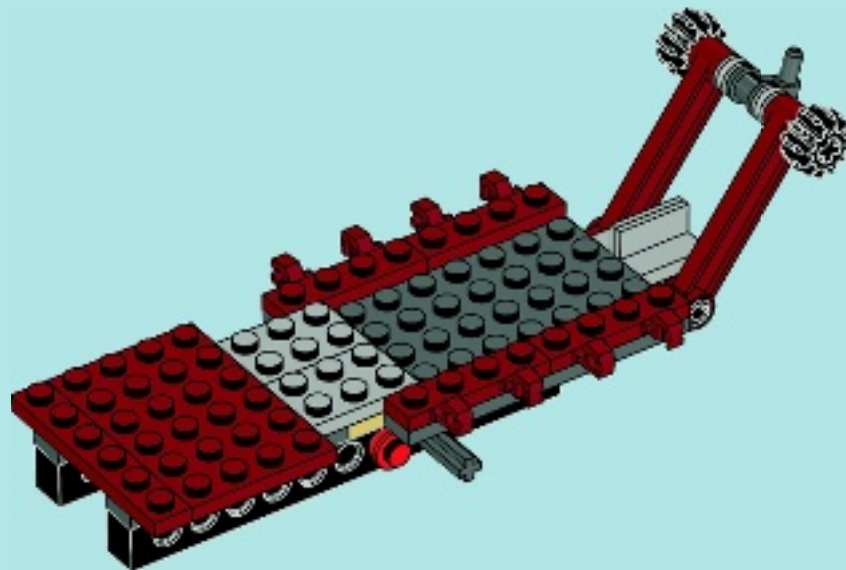



4x



1x

# 17

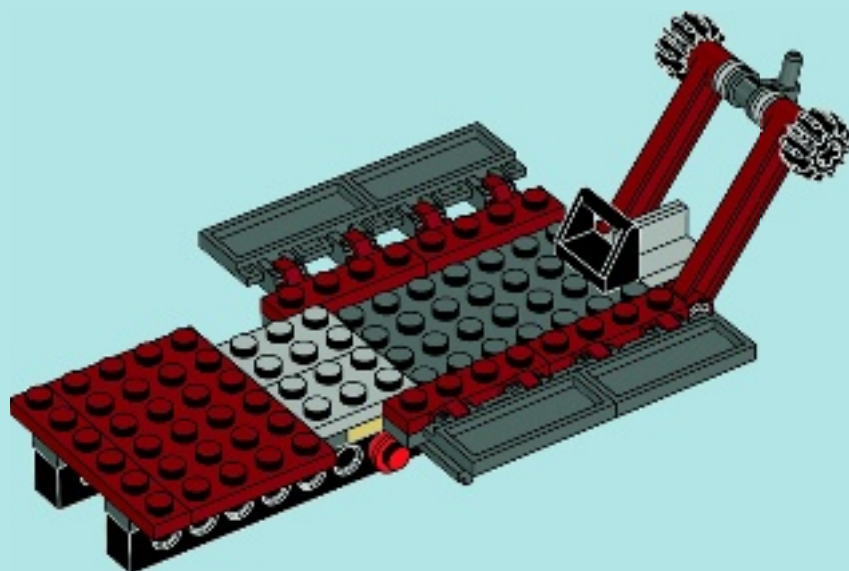

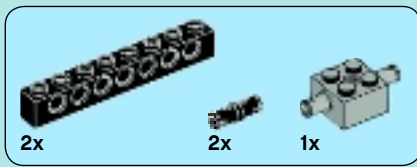

# 18

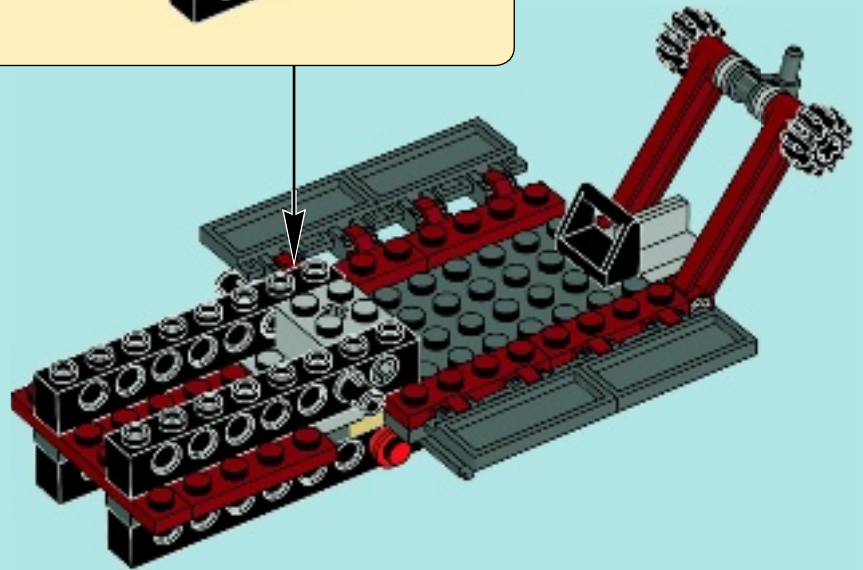
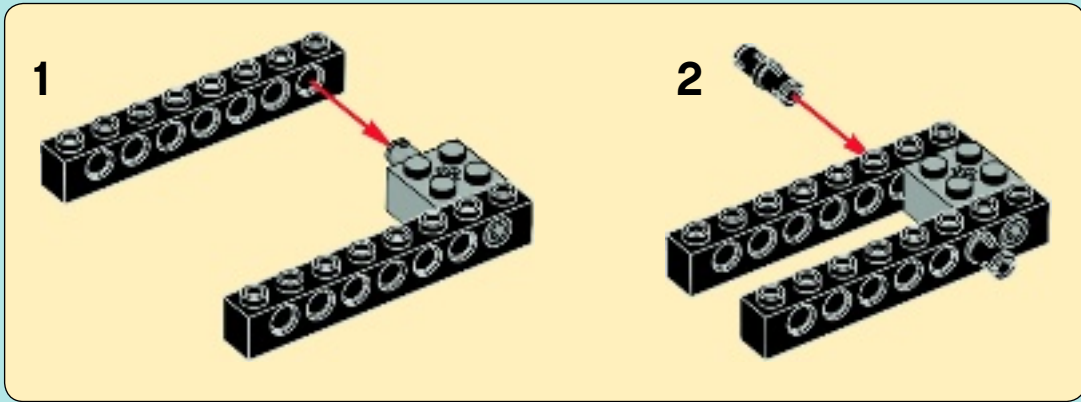



2x



2x

# 19

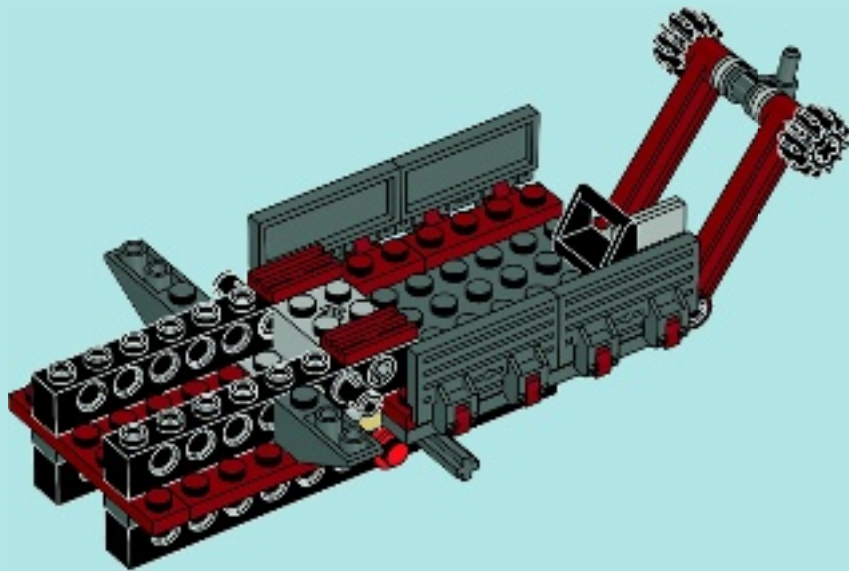





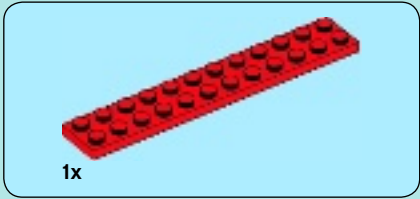
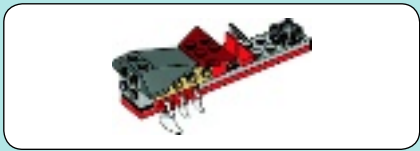

1x

1

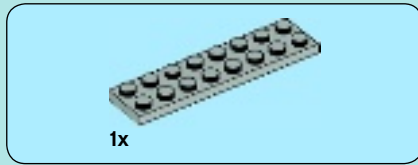
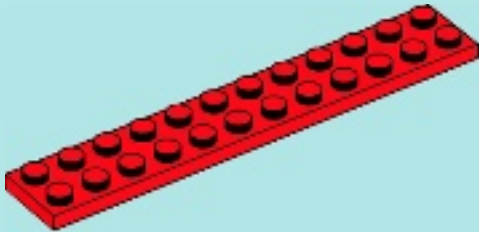

1x

2

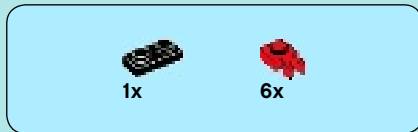
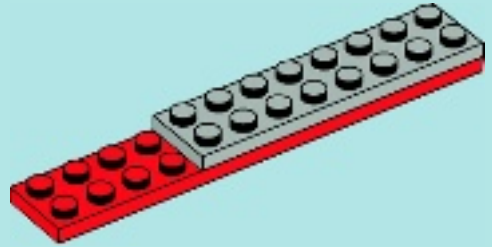

1x

6x

3

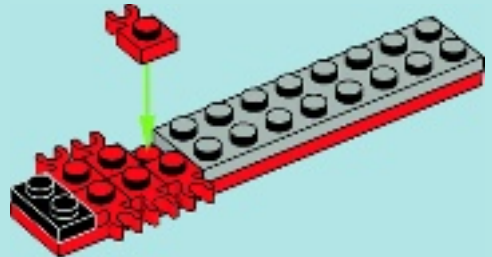



4

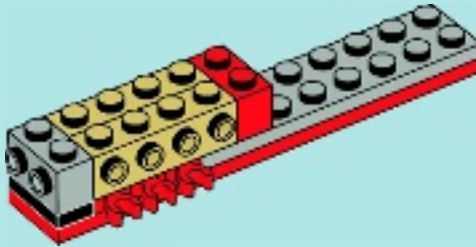

5

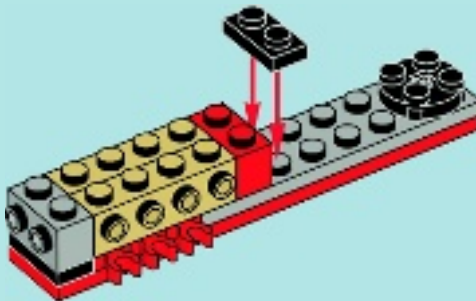



1x



1x

# 6

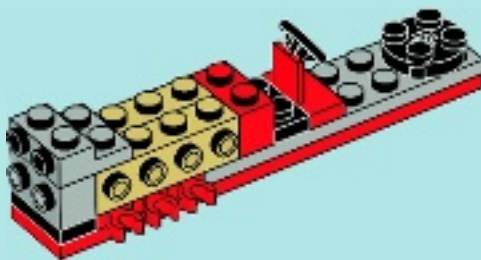

1x



1x

# 7

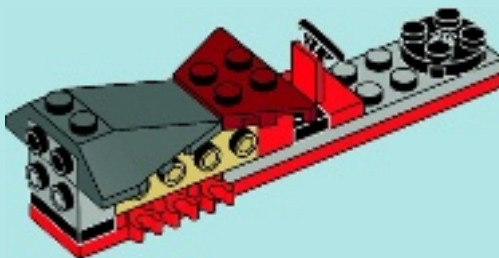

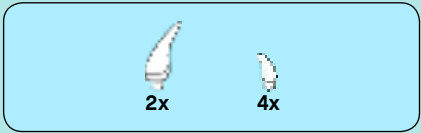

8

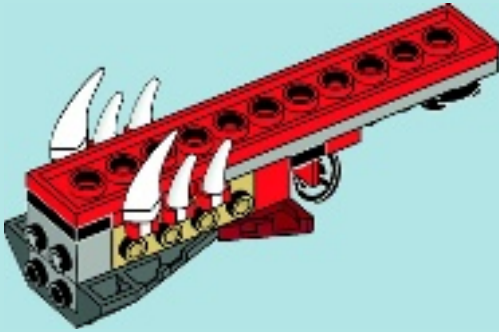

9

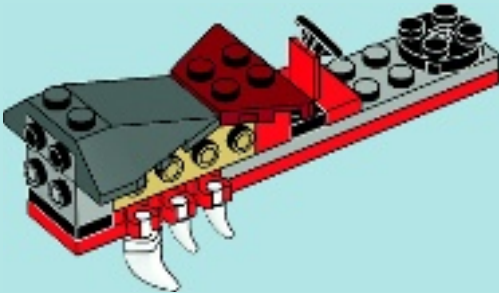
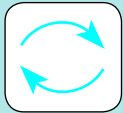

21

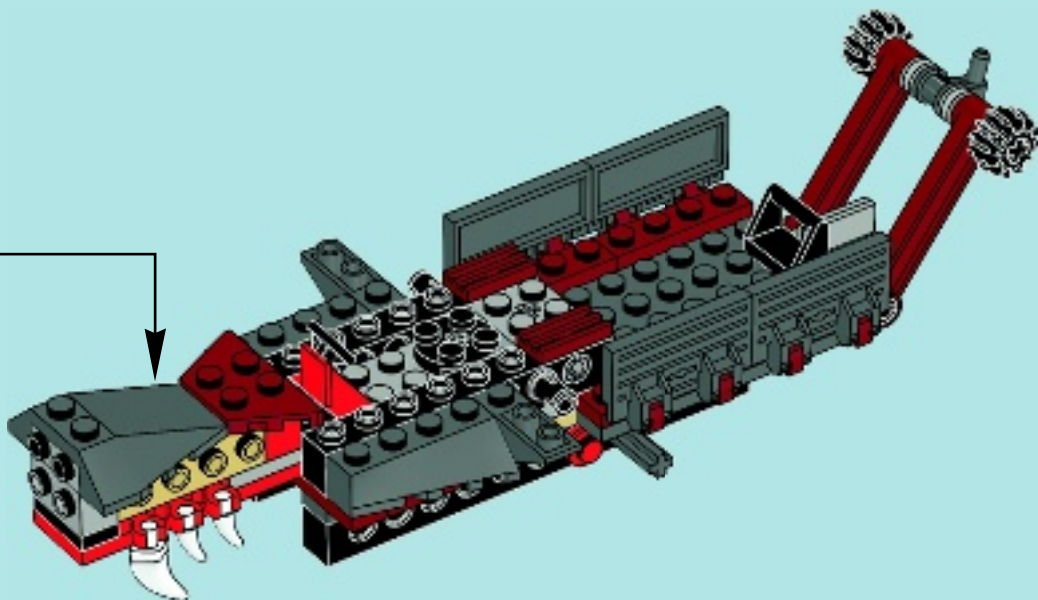

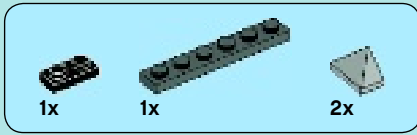
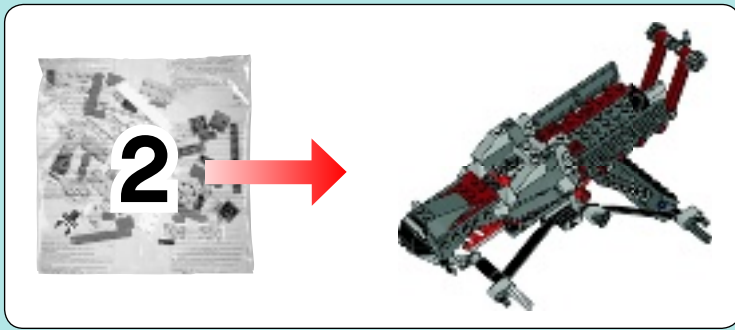

22

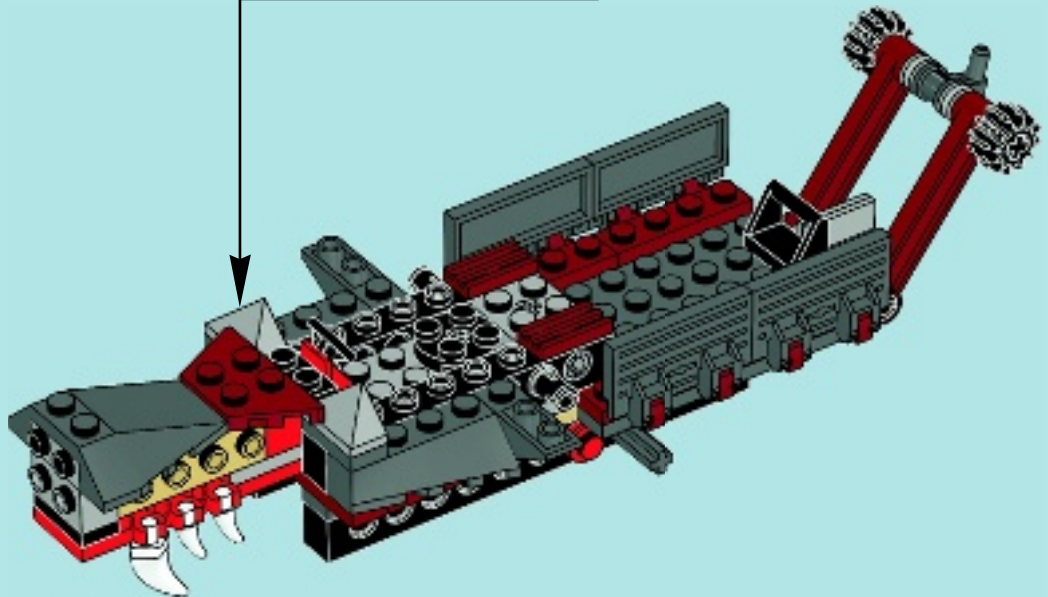
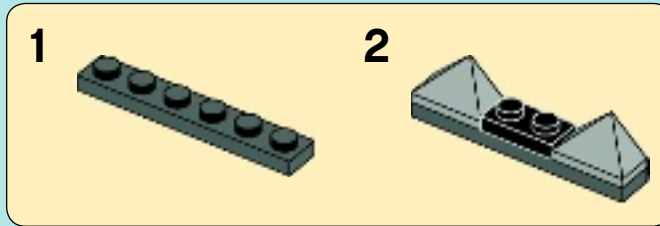



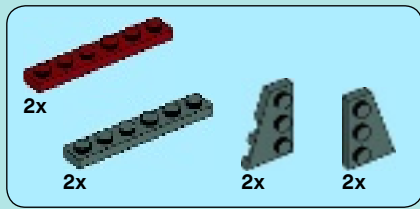

23

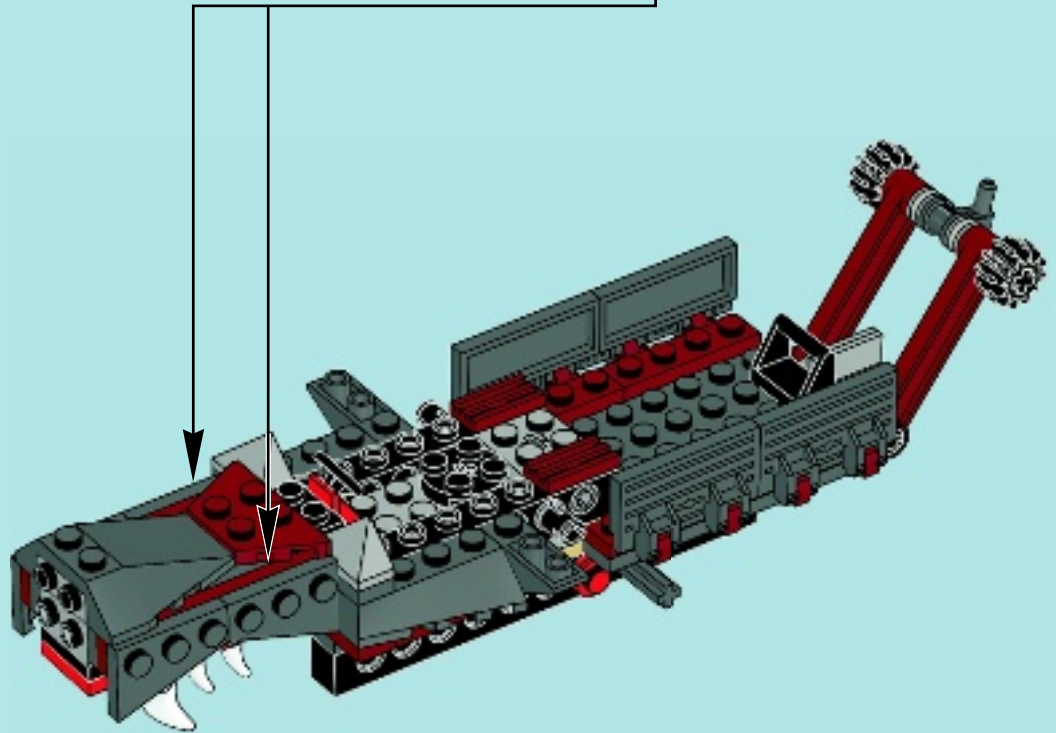
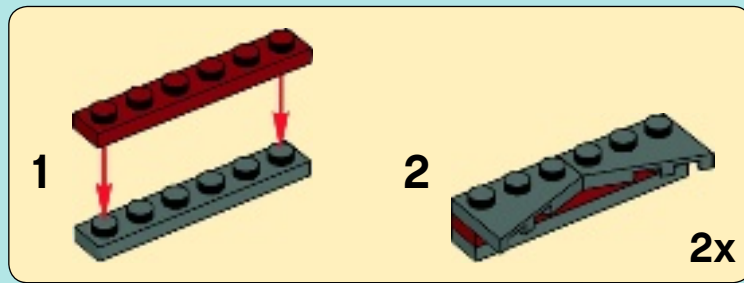



1x



2x

# 24

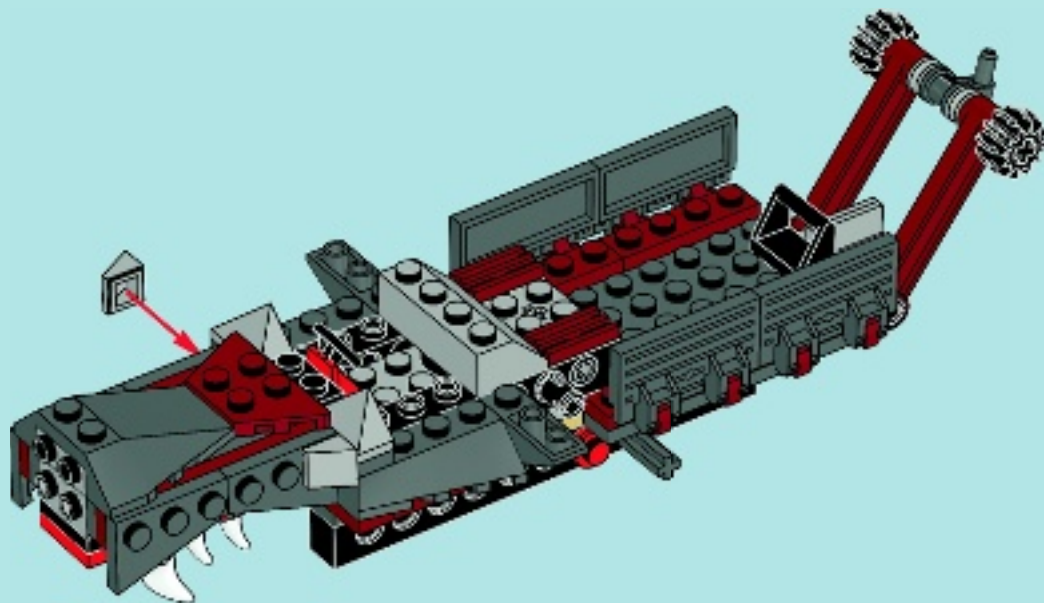

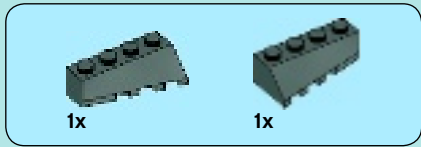

# 25

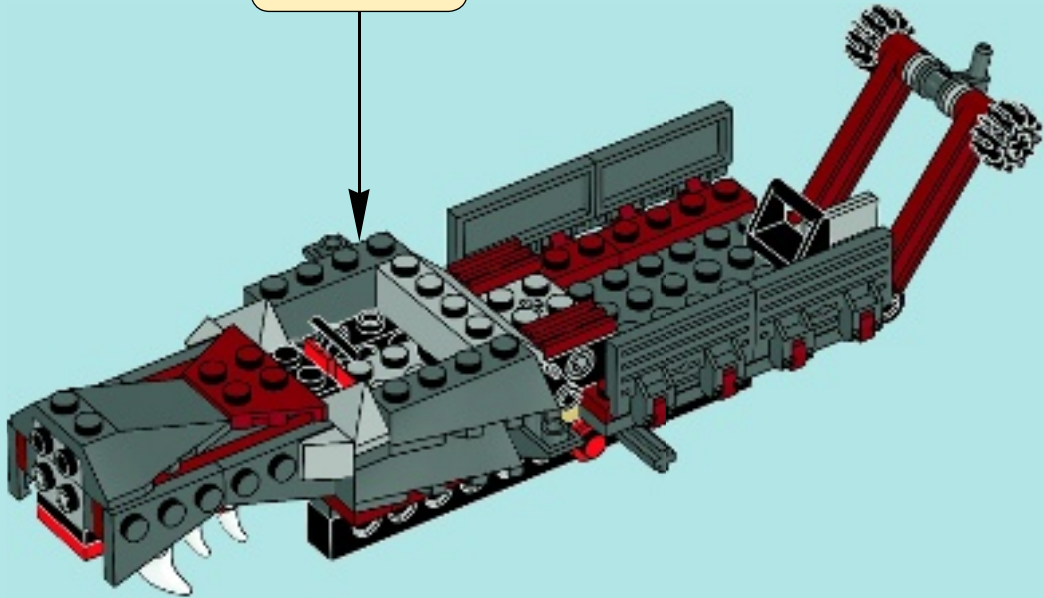
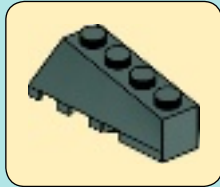

2x

2x

# 26

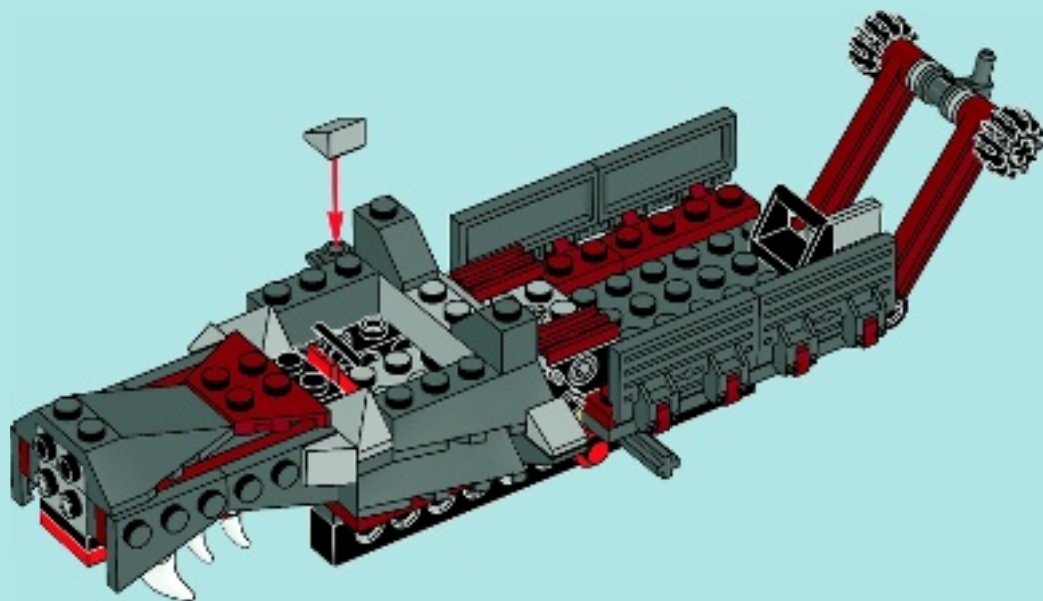



2x

# 27

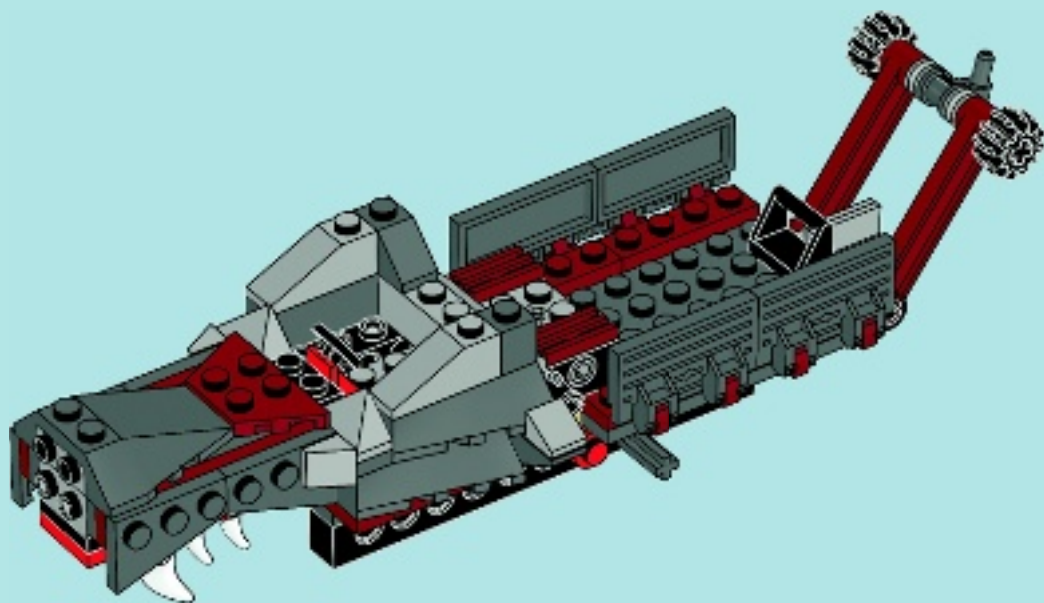

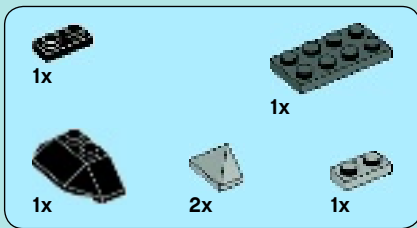

# 28

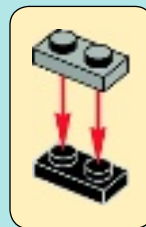
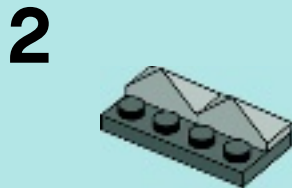
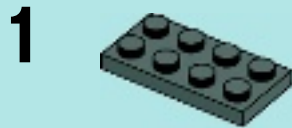

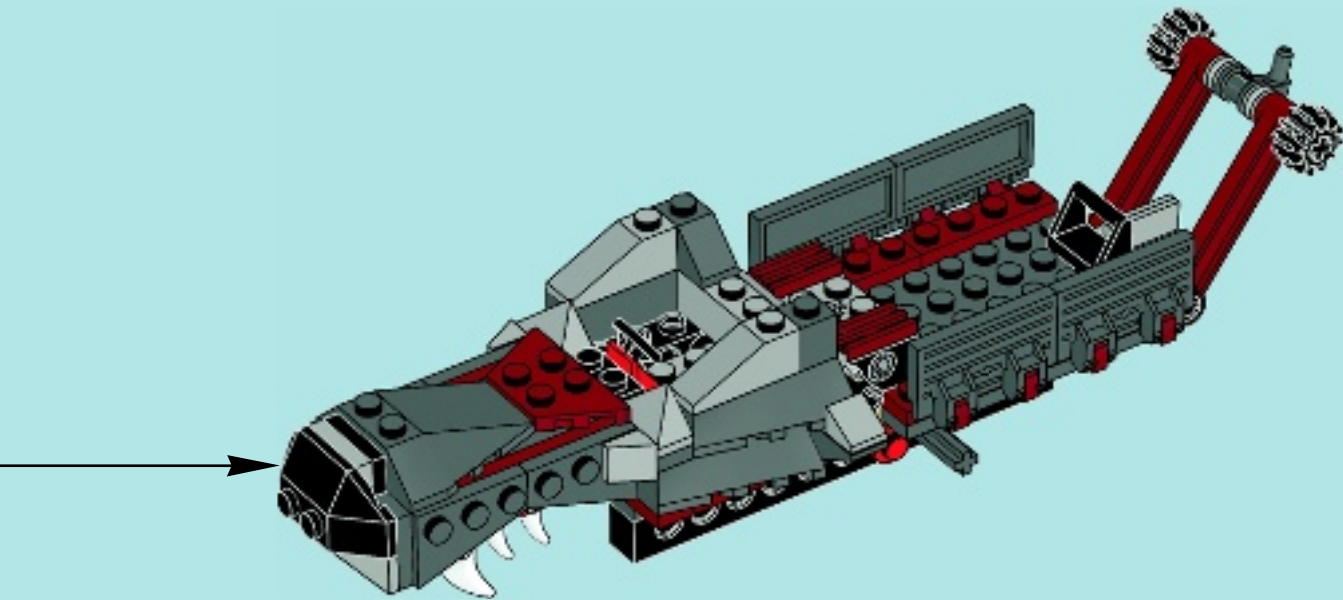



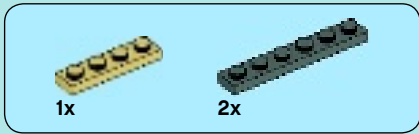

# 29

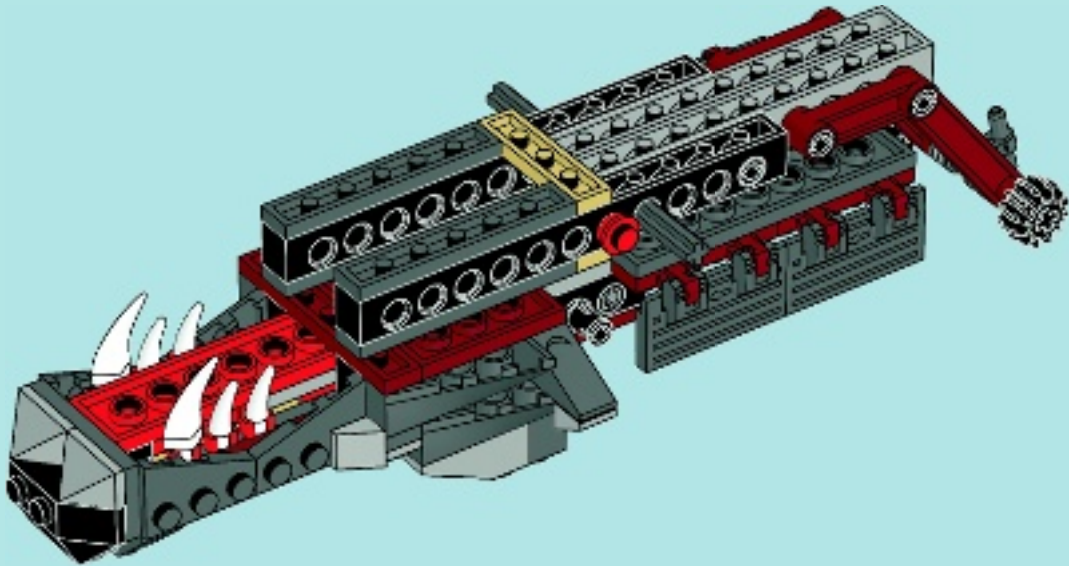
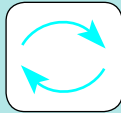

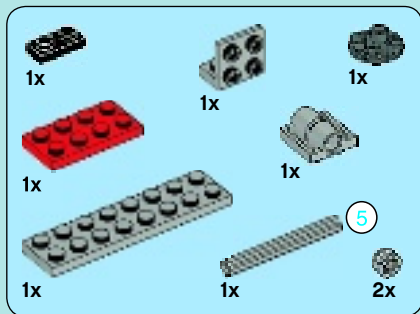

# 30

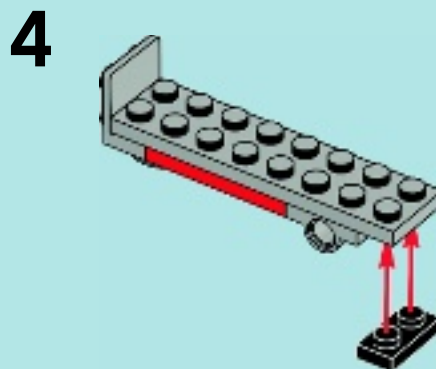
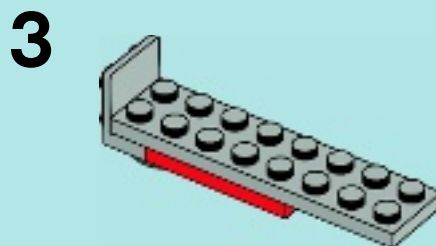
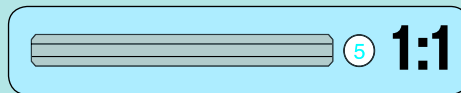
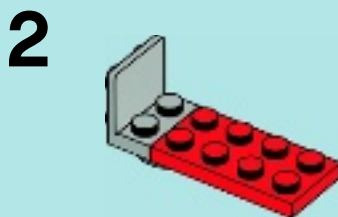
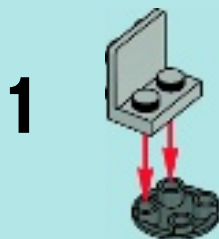

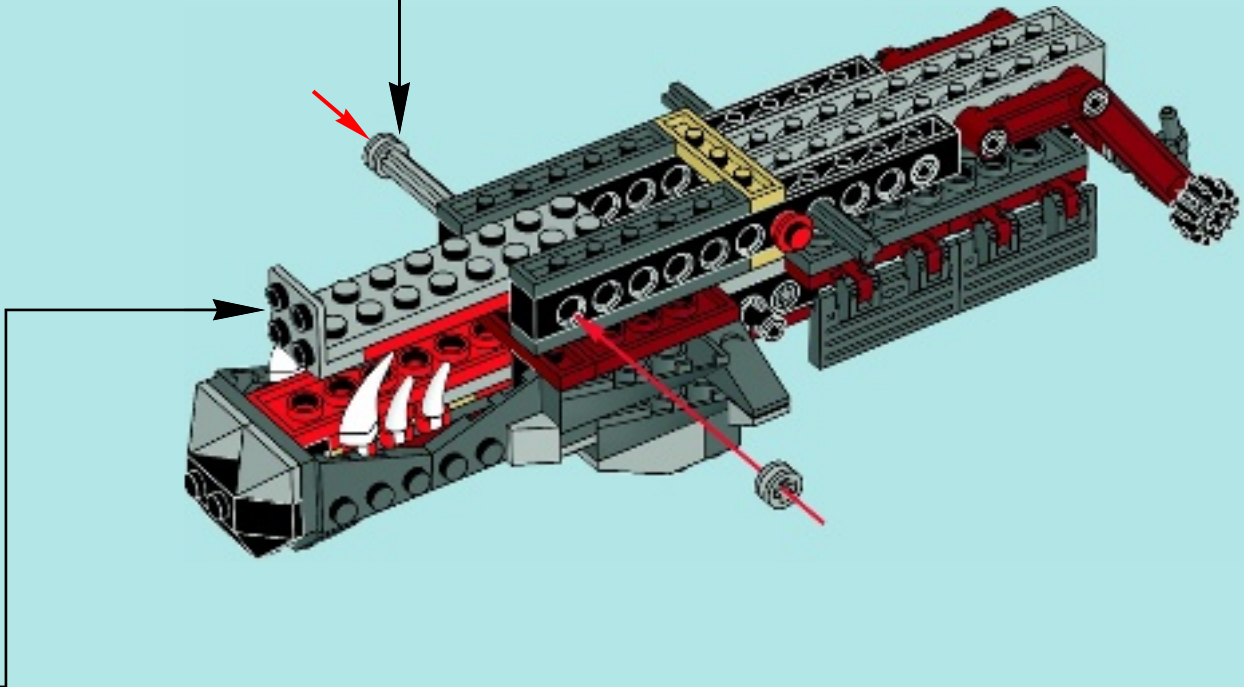
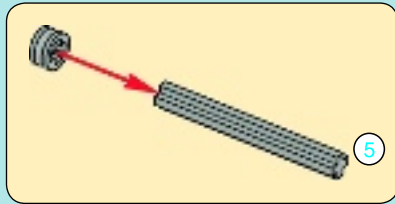

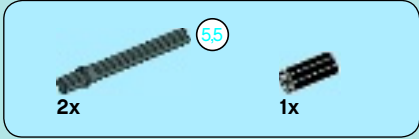

1

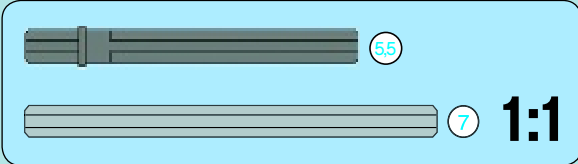

2

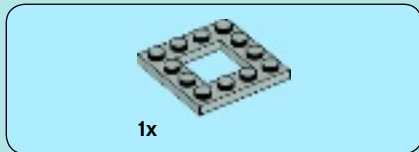
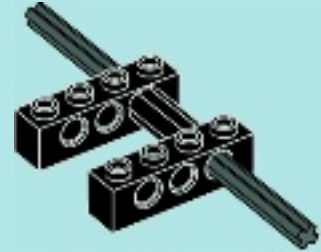

3

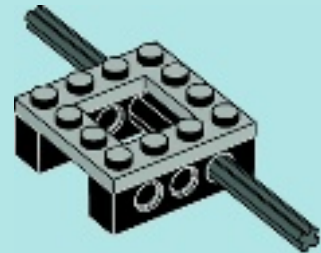

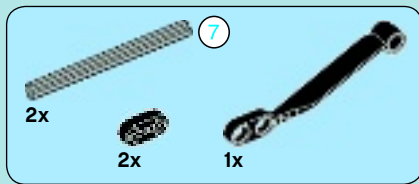

4

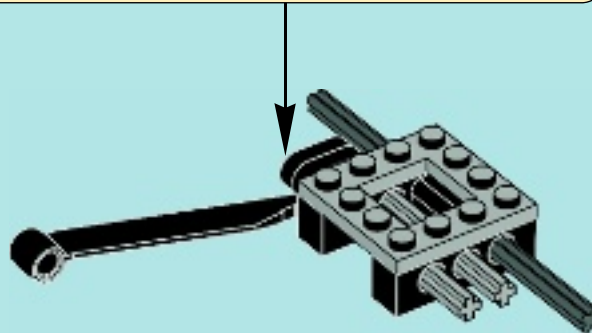
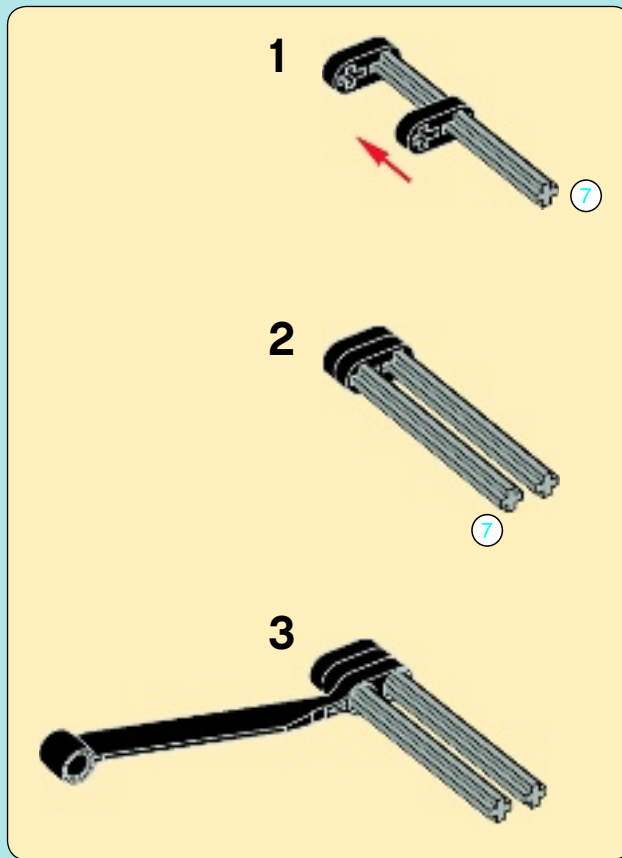

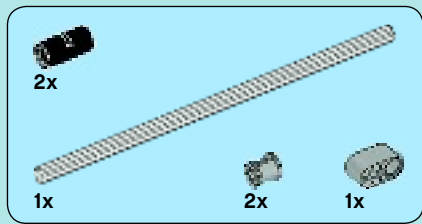

5

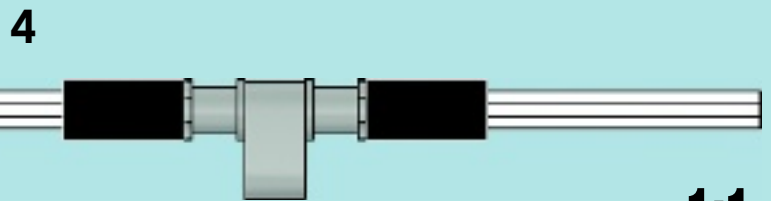
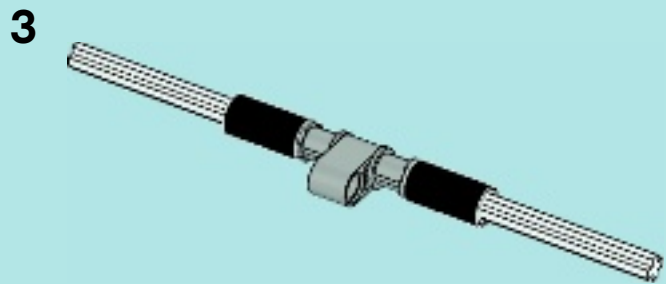
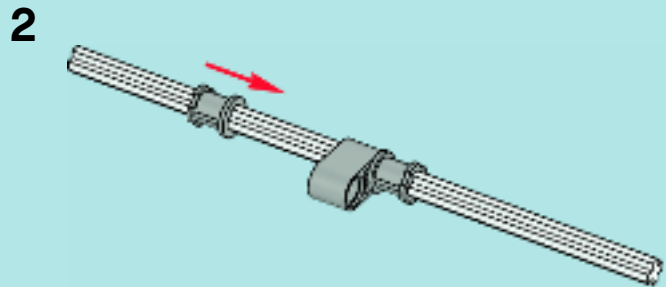
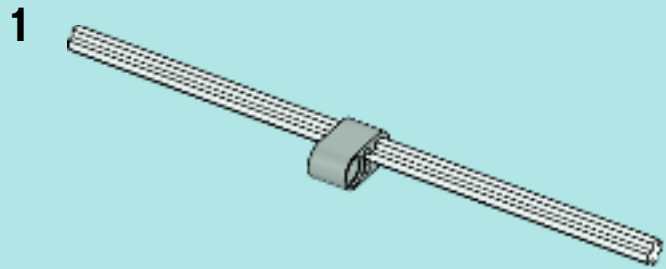

1:1





# LEGENDS OF CHIMA

## WATCH THE VIDEO

WATCH THE VIDEO - WATCH THE VIDEO  
HELIEN LA VIDEO - MIRA EL VIDEO  
VEO VIDEO - REGARDE A VIDEO

## SCAN THE QR CODE

SCAN THE QR CODE - SCANNE DEN QR-CODE  
SCANNE LE QR CODE - CAPTURA EL CÓDIGO QR  
FAZ SCAN DO CÓDIGO QR - OLVARO DE A QR KÓDUT



[LEGO.COM/CHIMA](http://LEGO.COM/CHIMA)





# LEGENDS OF CHIMA

LAVAL



70005 70115

LONGTOOTH



70005 70113

LENNUX



70002 70006  
70104 70011

LEONIDAS



70001 70006  
70102

EWALD



70011

ERIS



70003

EQULA



70004 70013  
70101

EGLOR



70013 70105

EWAR



70012





**ROMINUS**



7006 70103

**CRODGER**



70006 70115

**CROOLER**



70006

**CRUG**



70002

**CRAWLEY**



70001 70005

**RAWZOM**



70006

**RAZAR**



70003 70012  
70100

**RIZZO**



70003 70012

**RAZCAL**



70000

**WORRIZ**



70011

**WAKZ**



70004 70113

**WILHURT**



70013

**WINZAR**



70004 70106







# LEGENDS OF CHIMA

WATCH THE MODEL  
IN ACTION

ERLEBE DAS MODELL IN AKTION

REGARDE LA DÉMO DU MODÈLE EN ACTION

MIRA EL MODELO EN ACCIÓN

VÊ O MODELO EM AÇÃO

NÉZD MEG A MODELLT MŰKÖDÉS KÖZBEN

SCAN THE QR CODE

SCANNE DEN QR-CODE

SCANNE LE QR CODE

CAPTURE EL CÒDIGO QR

FAZ SCAN DO CÒDIGO QR

OLVASD BE A QR KÓDOT



LEGO.COM/CHIMA

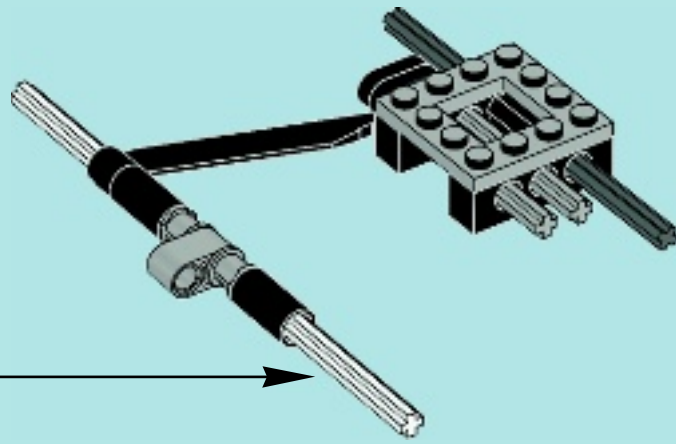

6

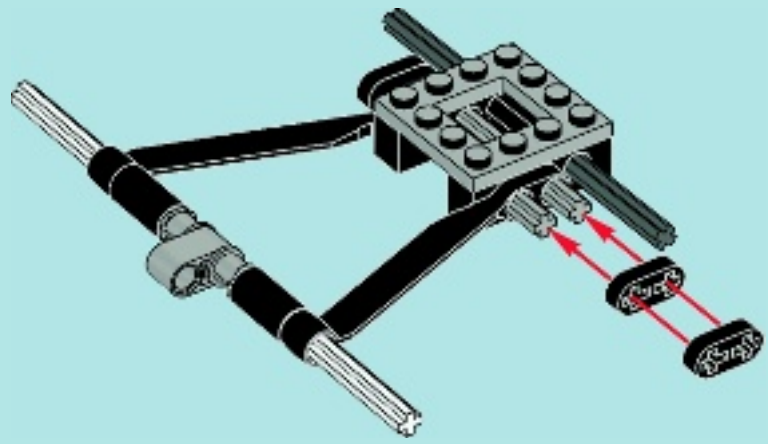

31

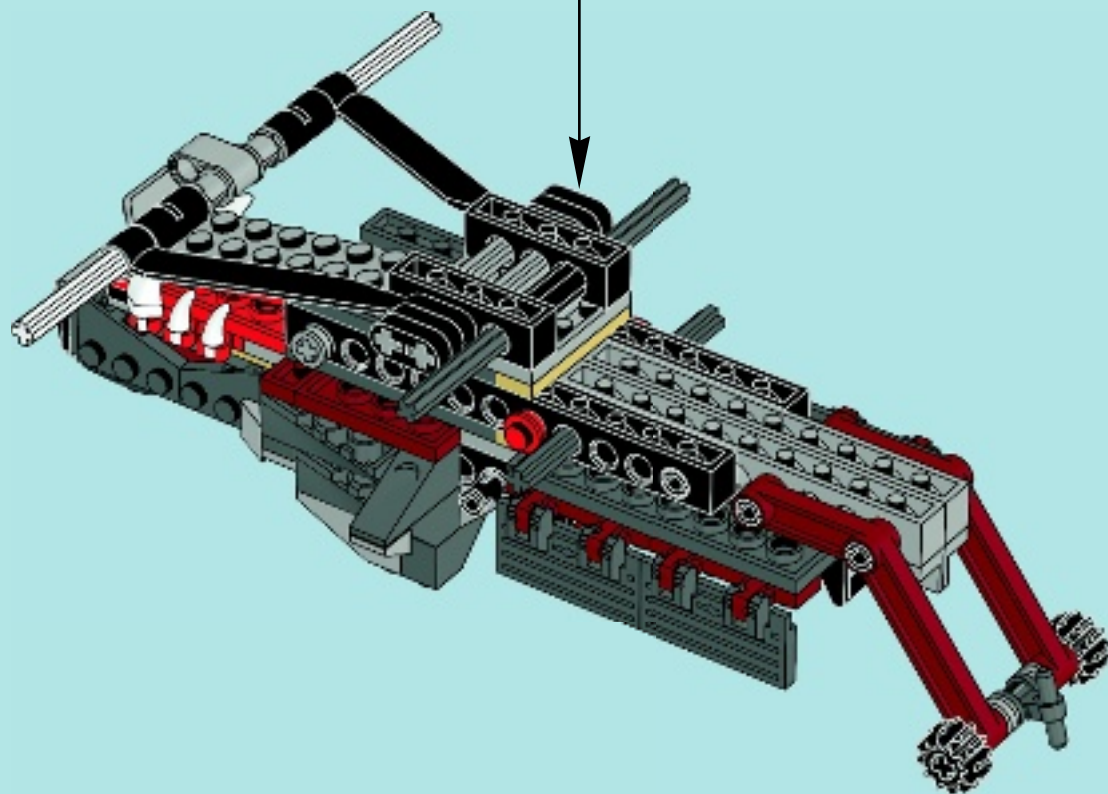

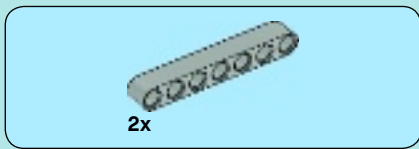

32

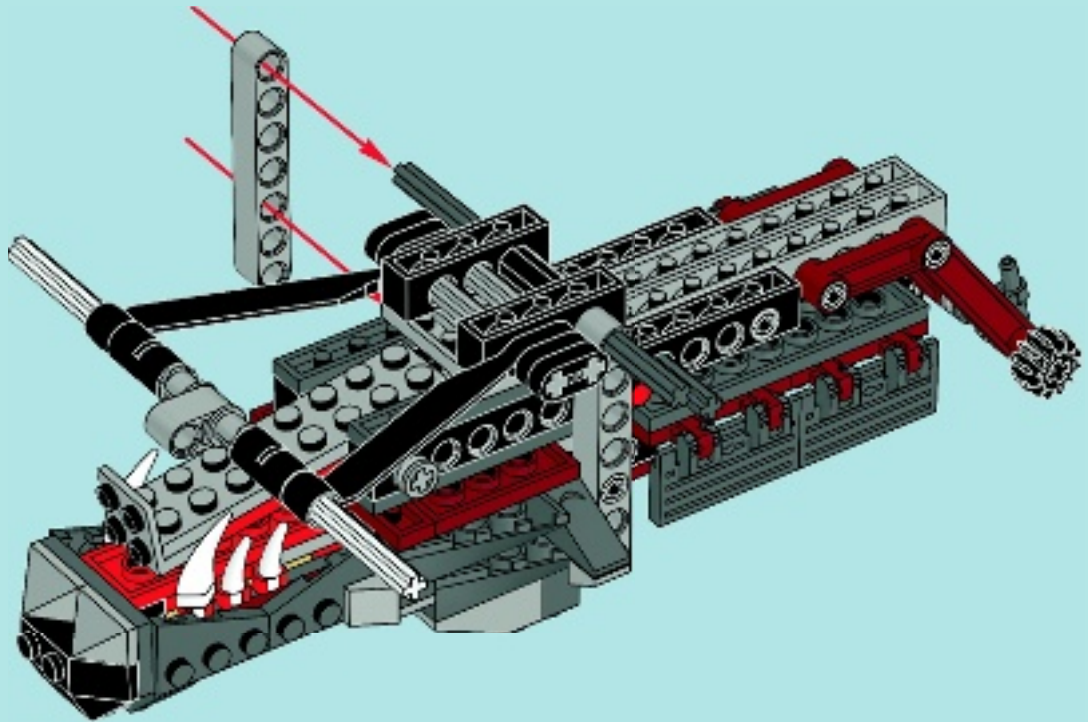





2x

# 33

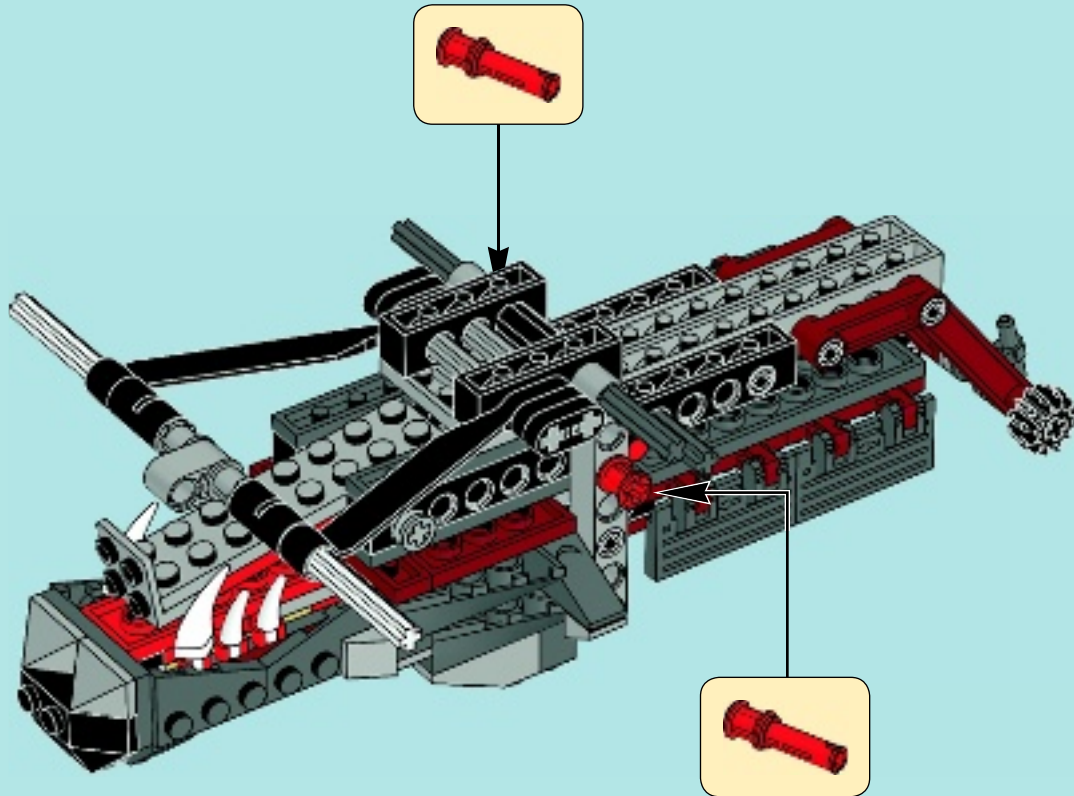



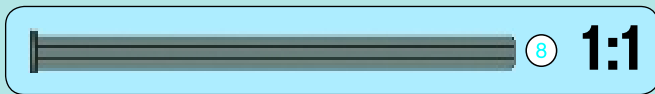
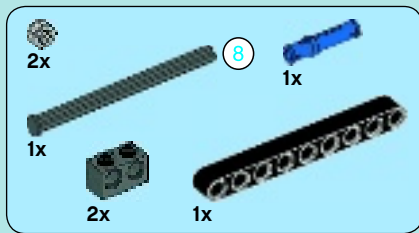

# 34

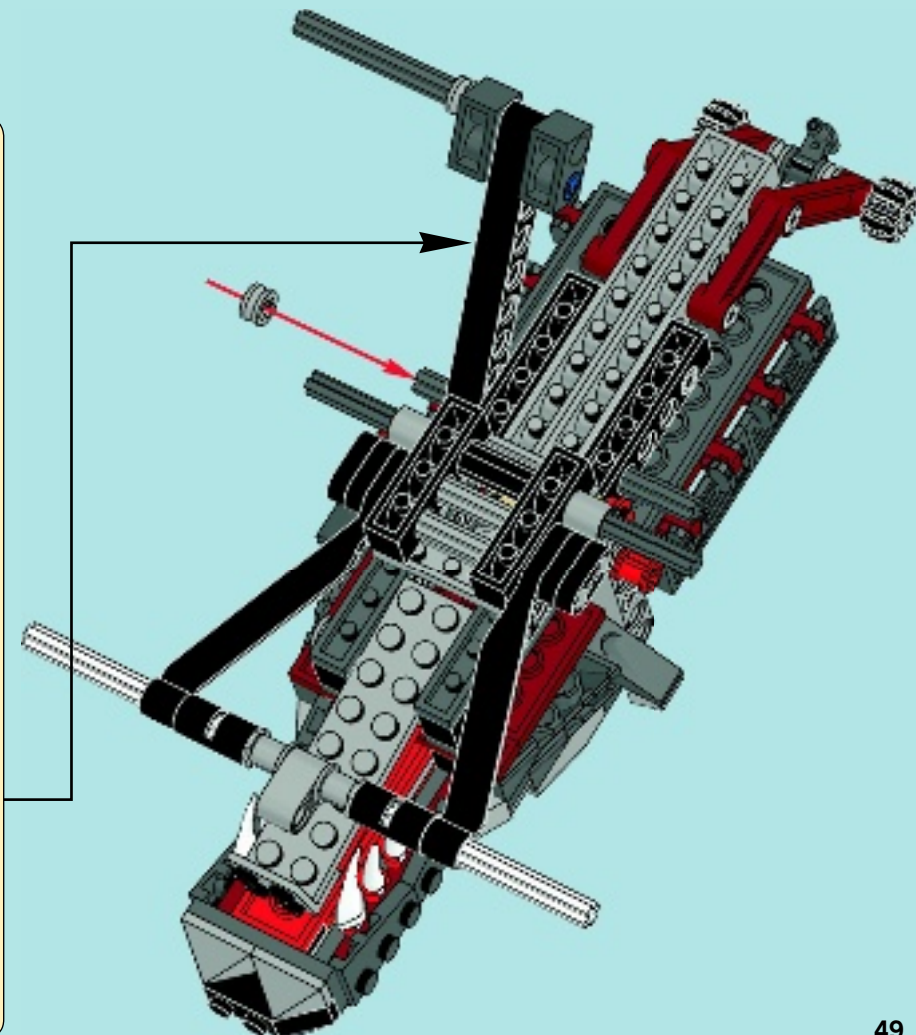
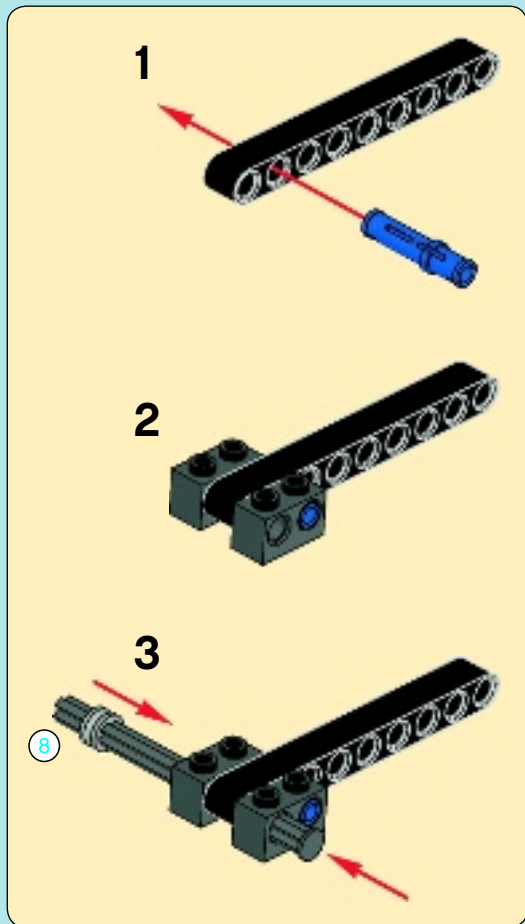

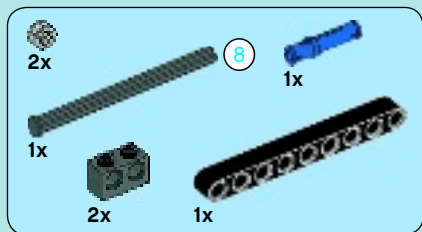

# 35

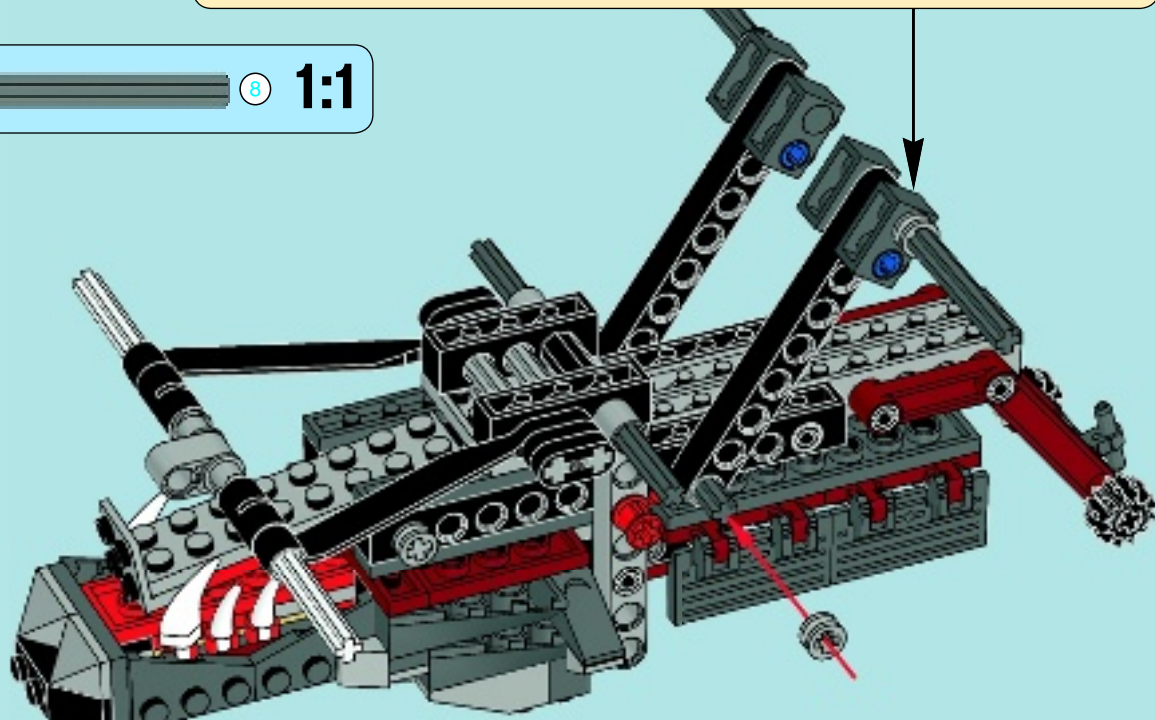
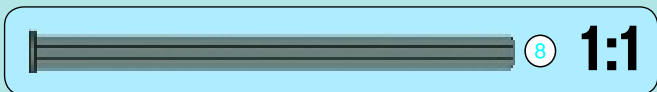
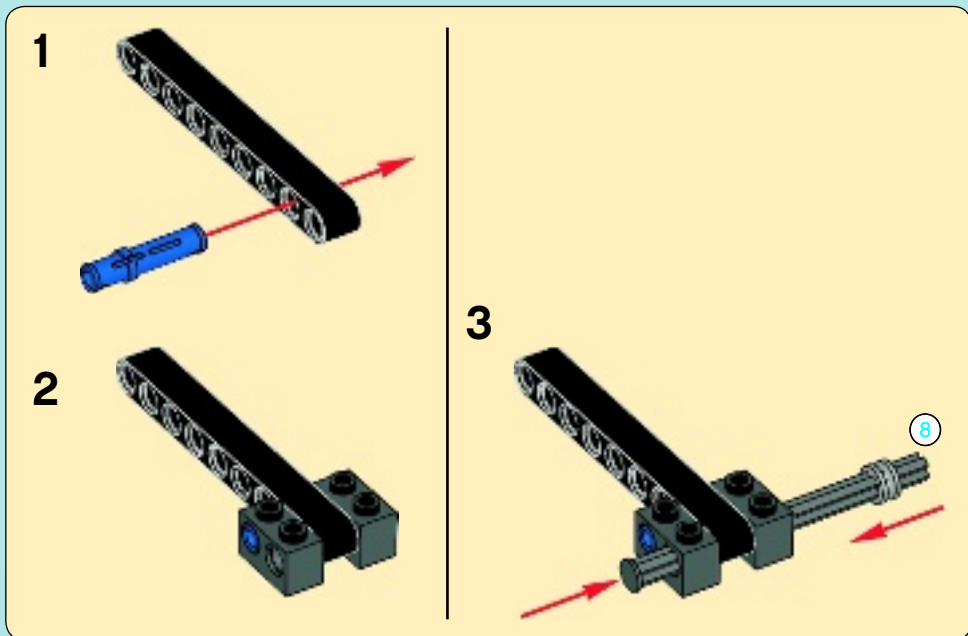

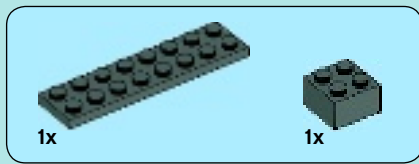

36

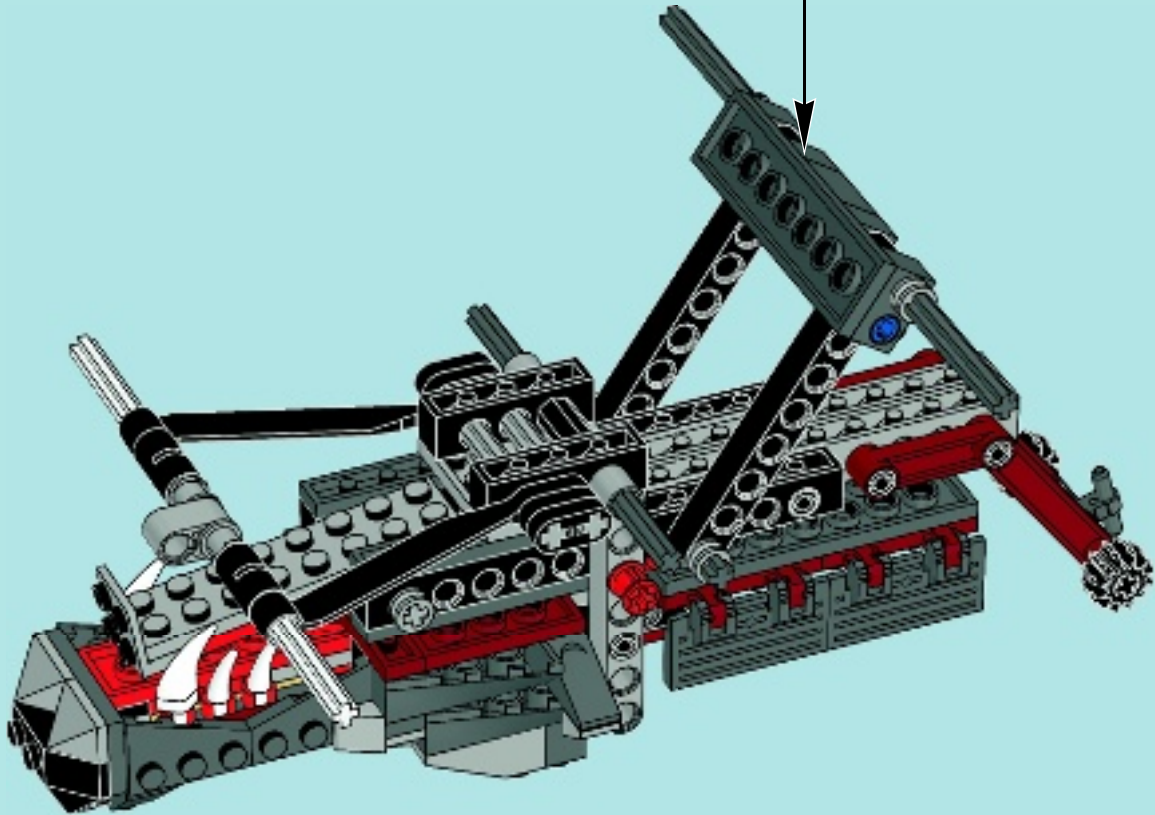
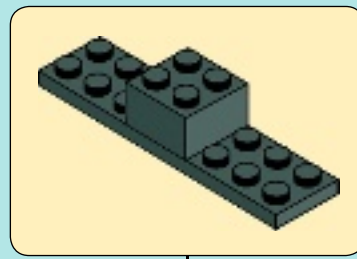



37

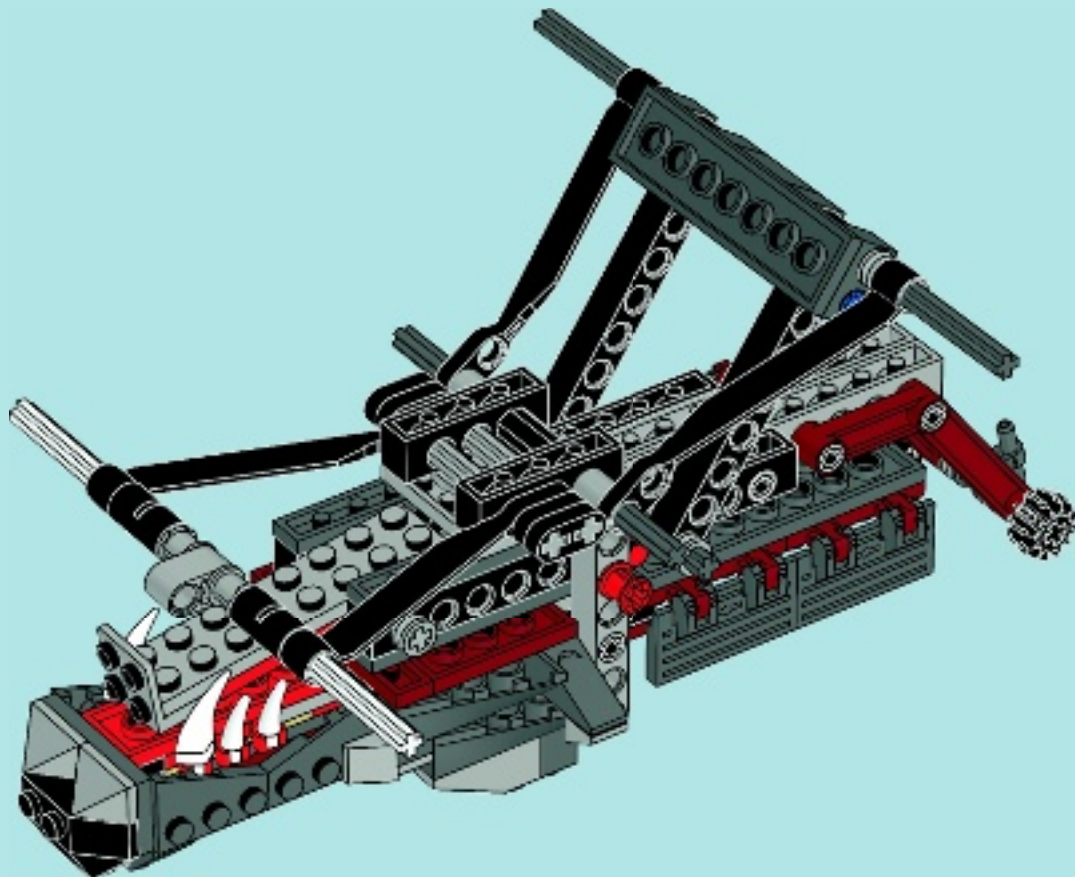



2x

2x

# 38

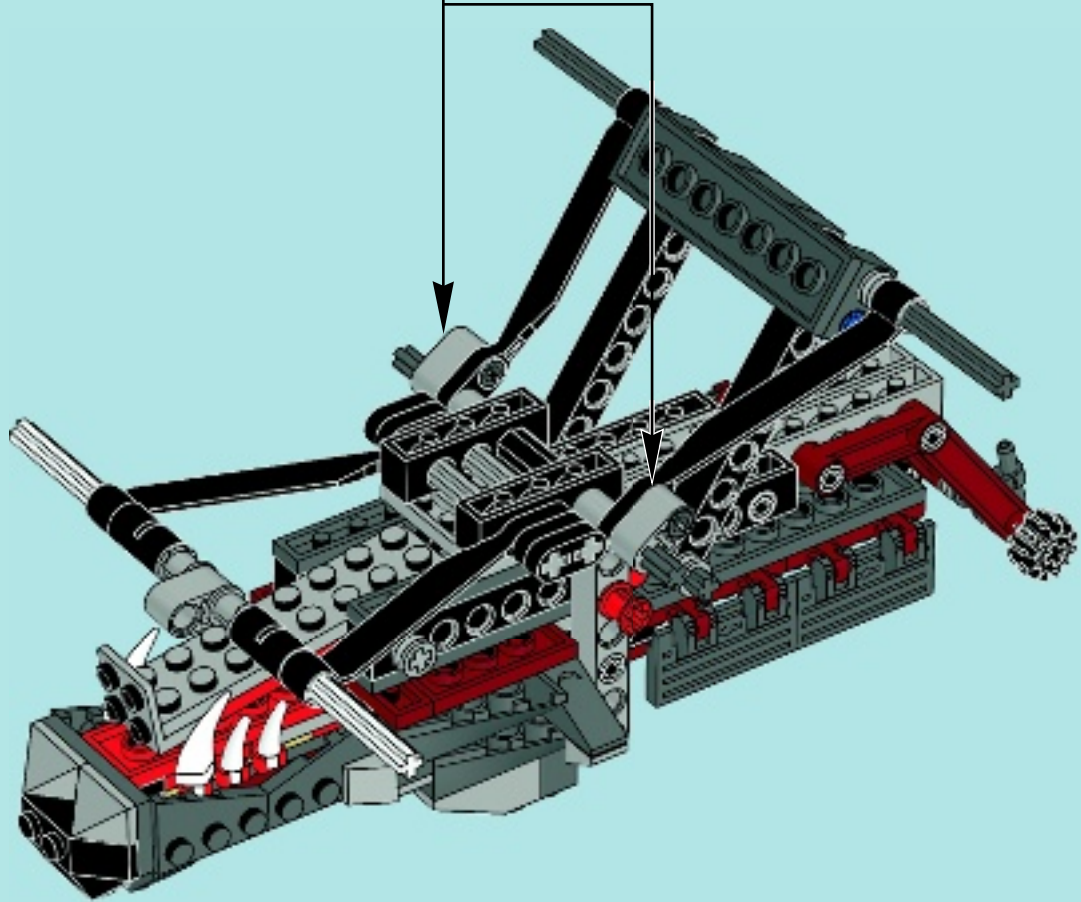
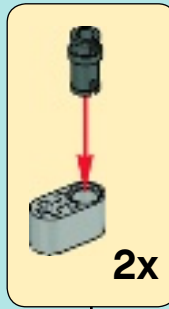

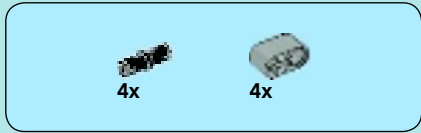

39

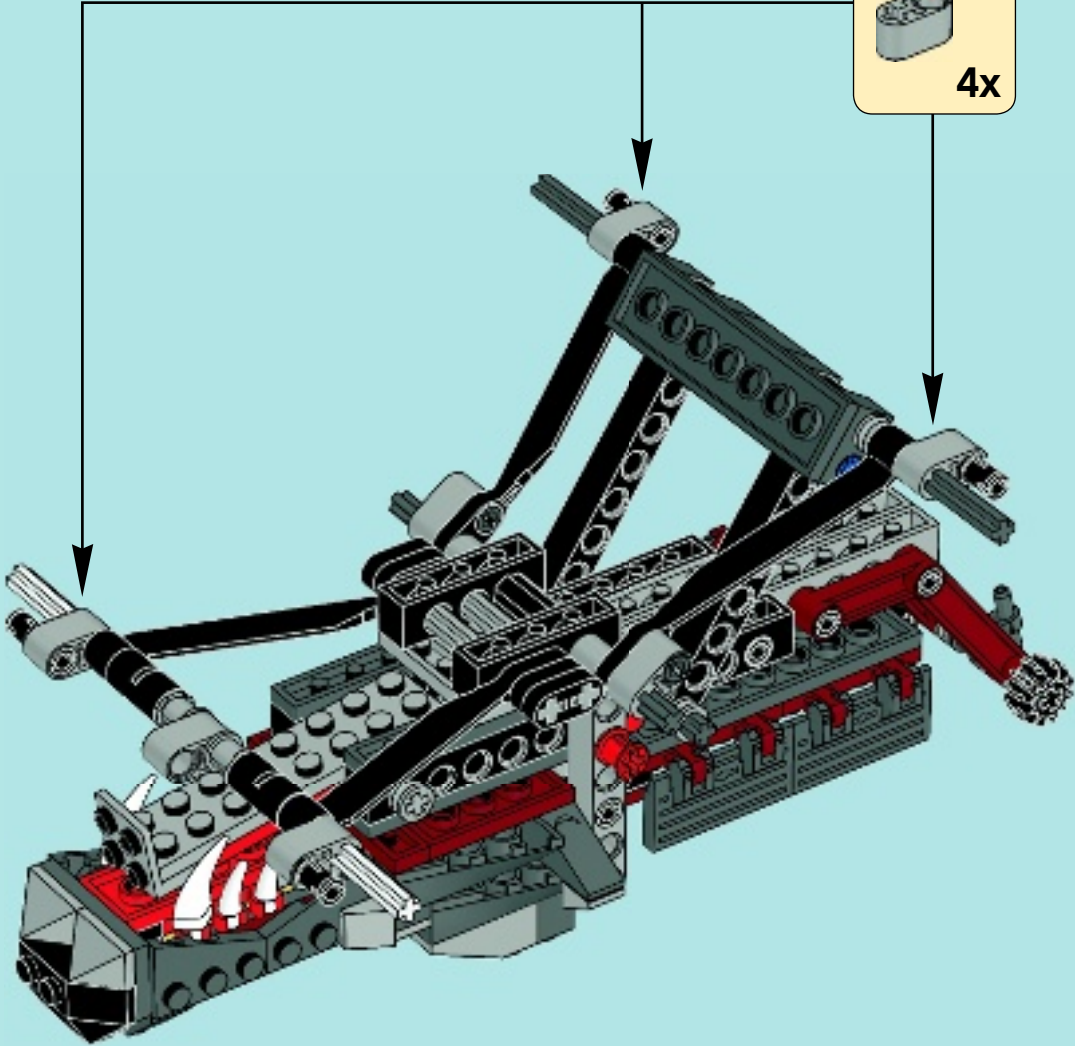
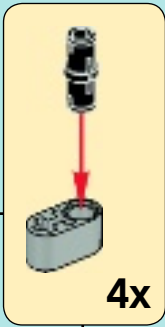

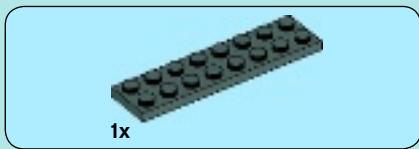

40

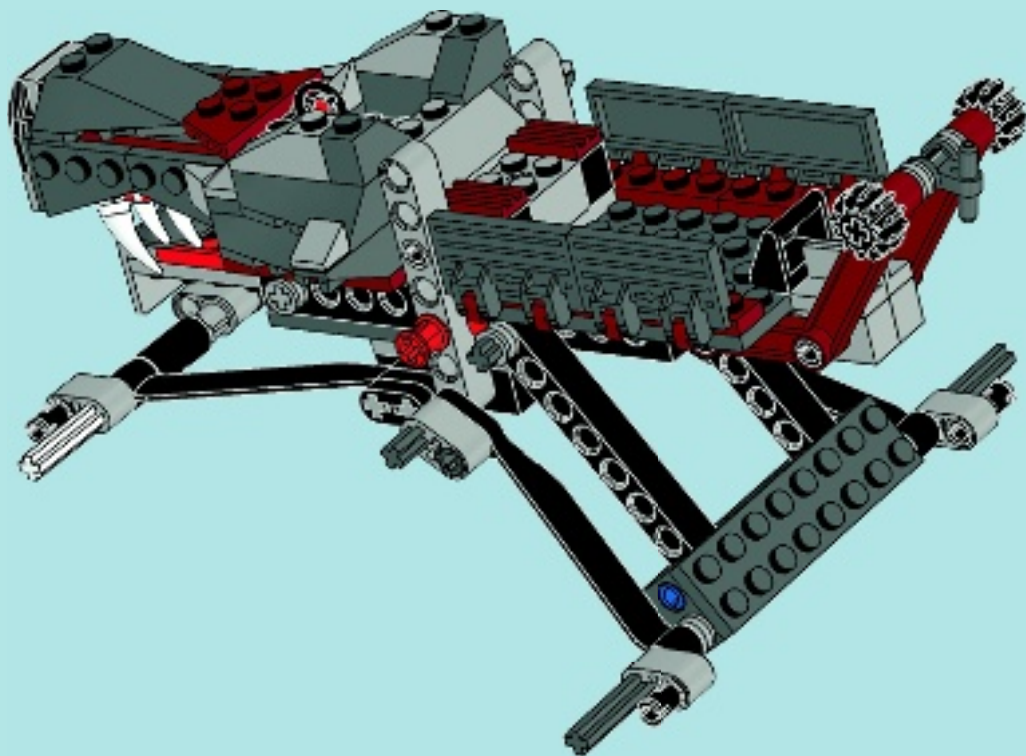
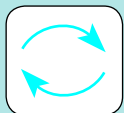



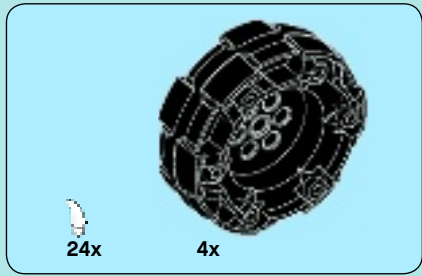
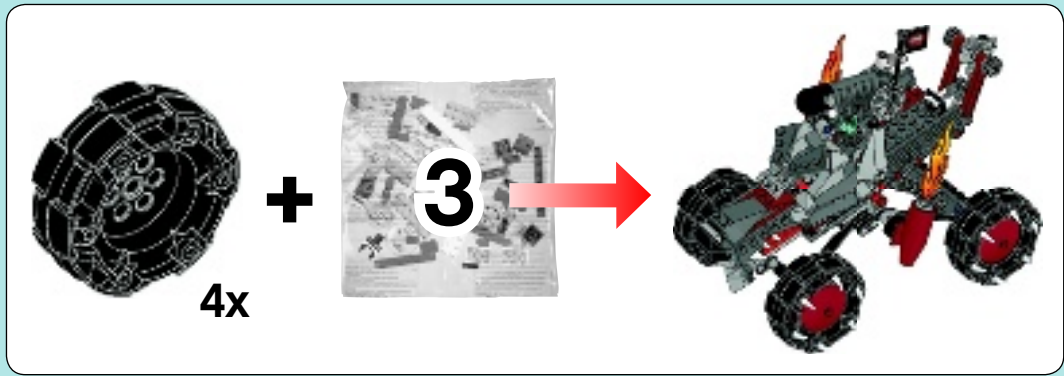

41

1

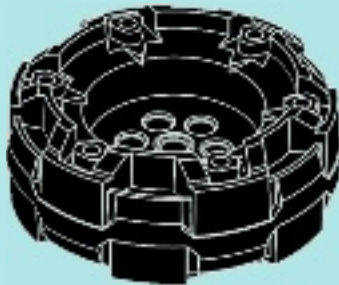

2



4x

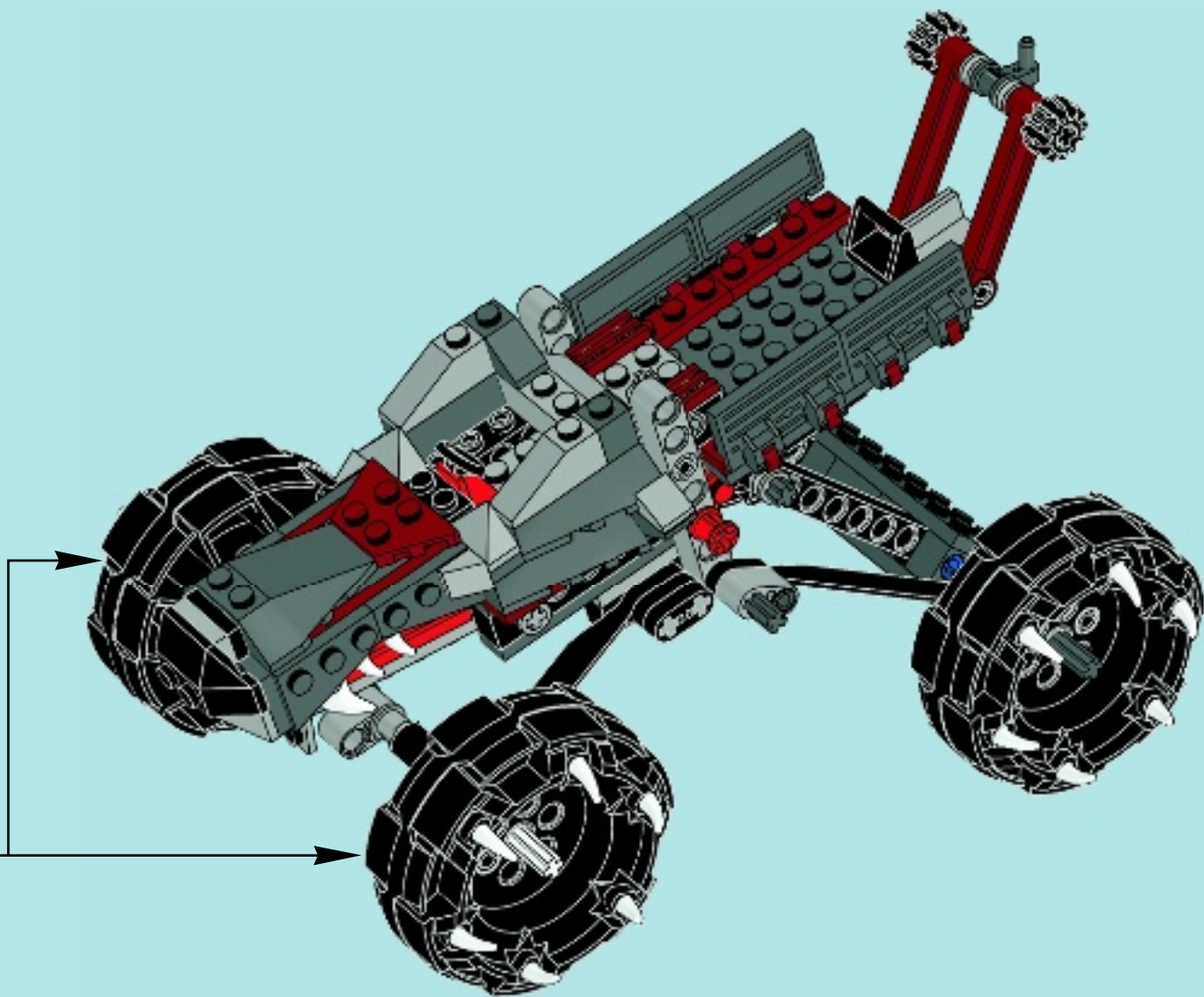



4x



4x

42

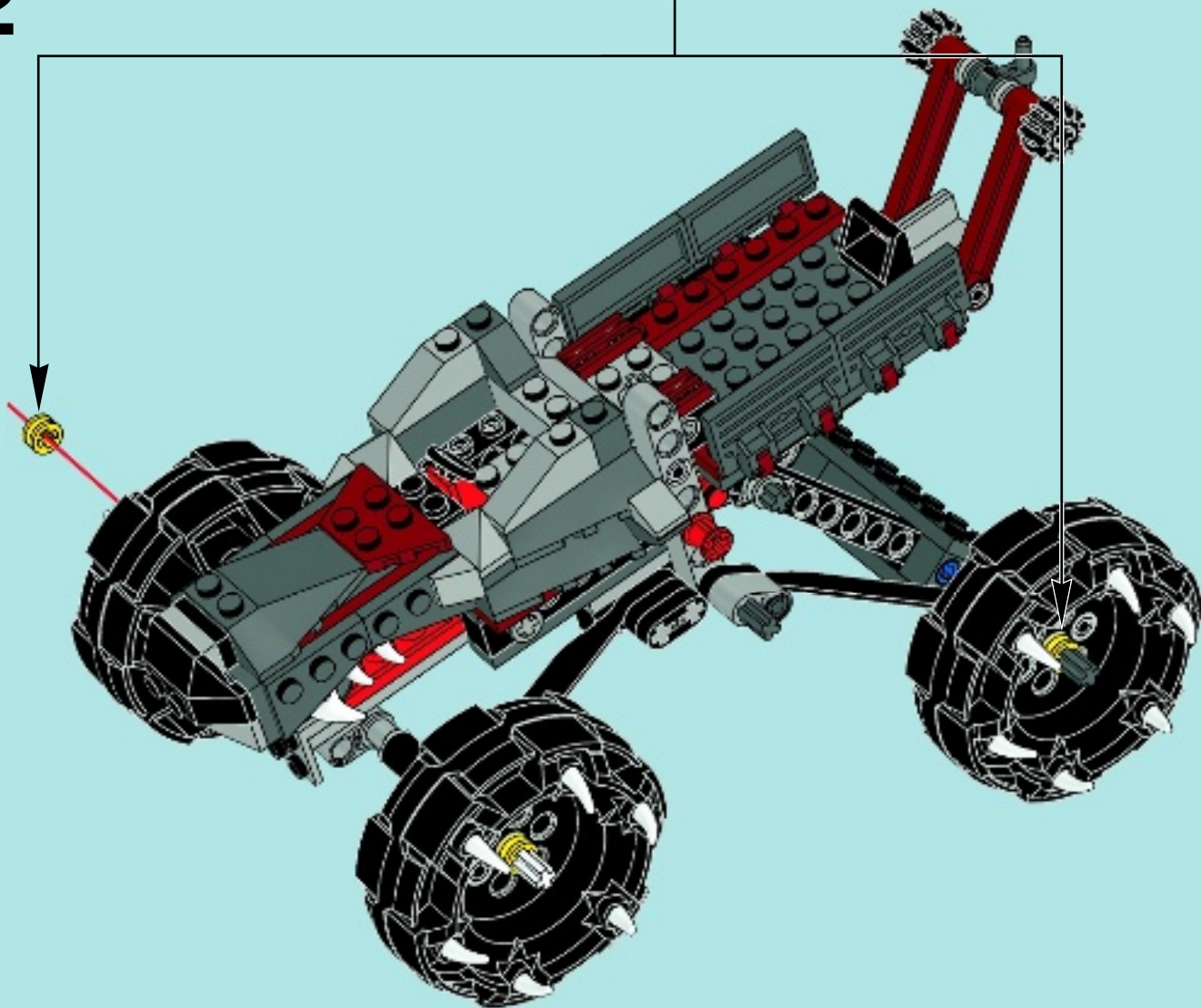



4x



4x

# 43

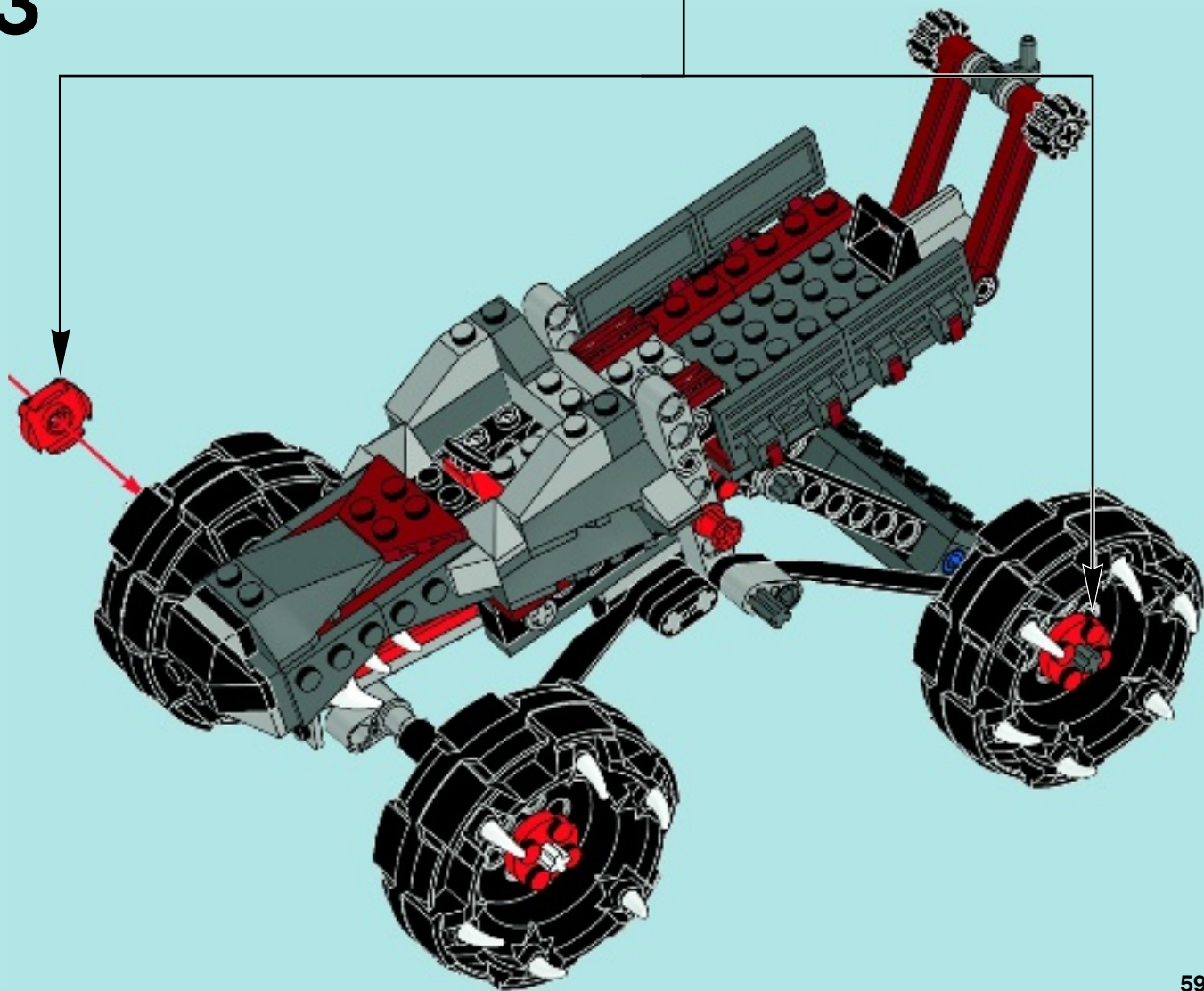





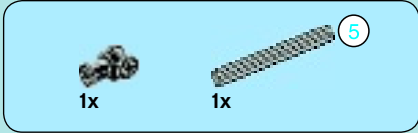

1

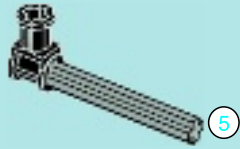

2

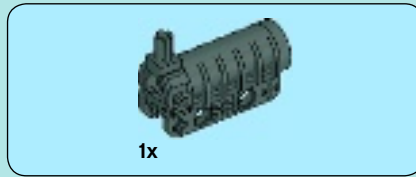
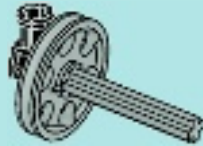

3

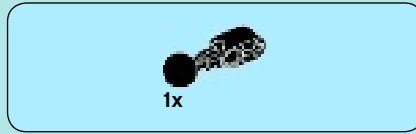
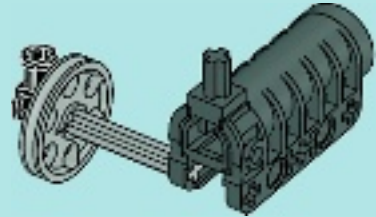

4

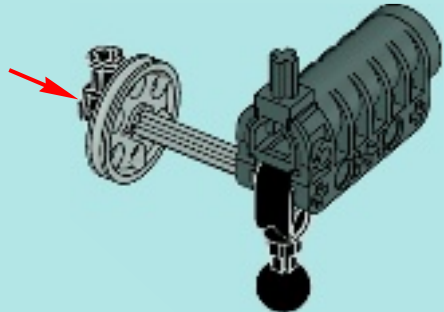

5

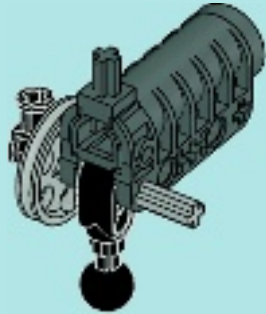

1x



1x

6

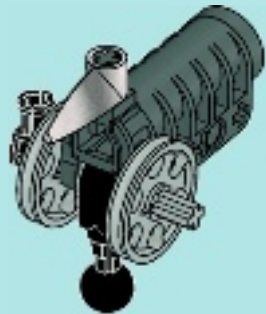

7



1x

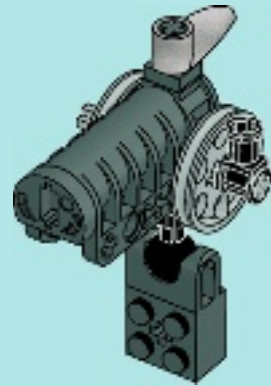
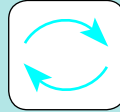



45

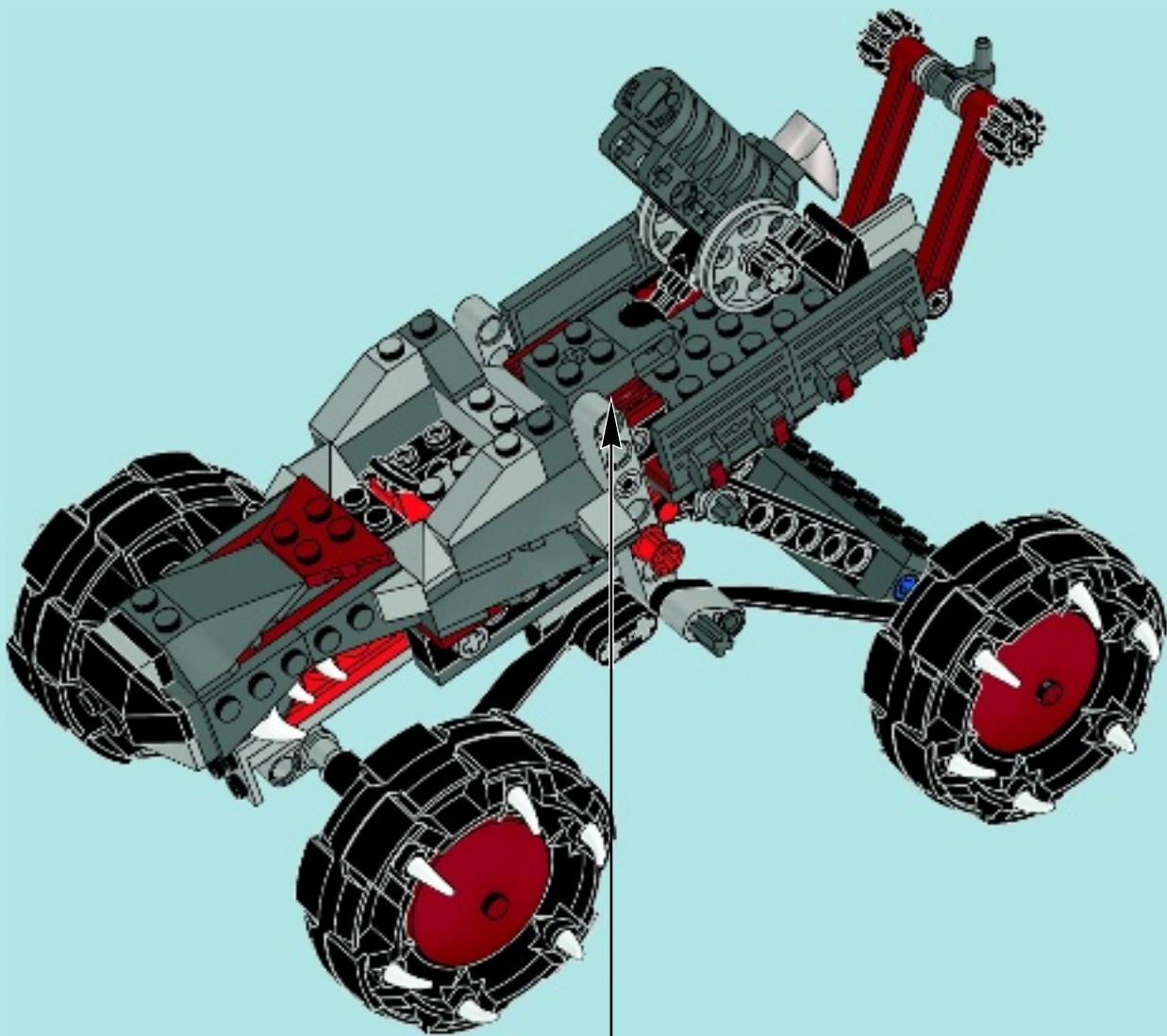



1x



1x

# 46

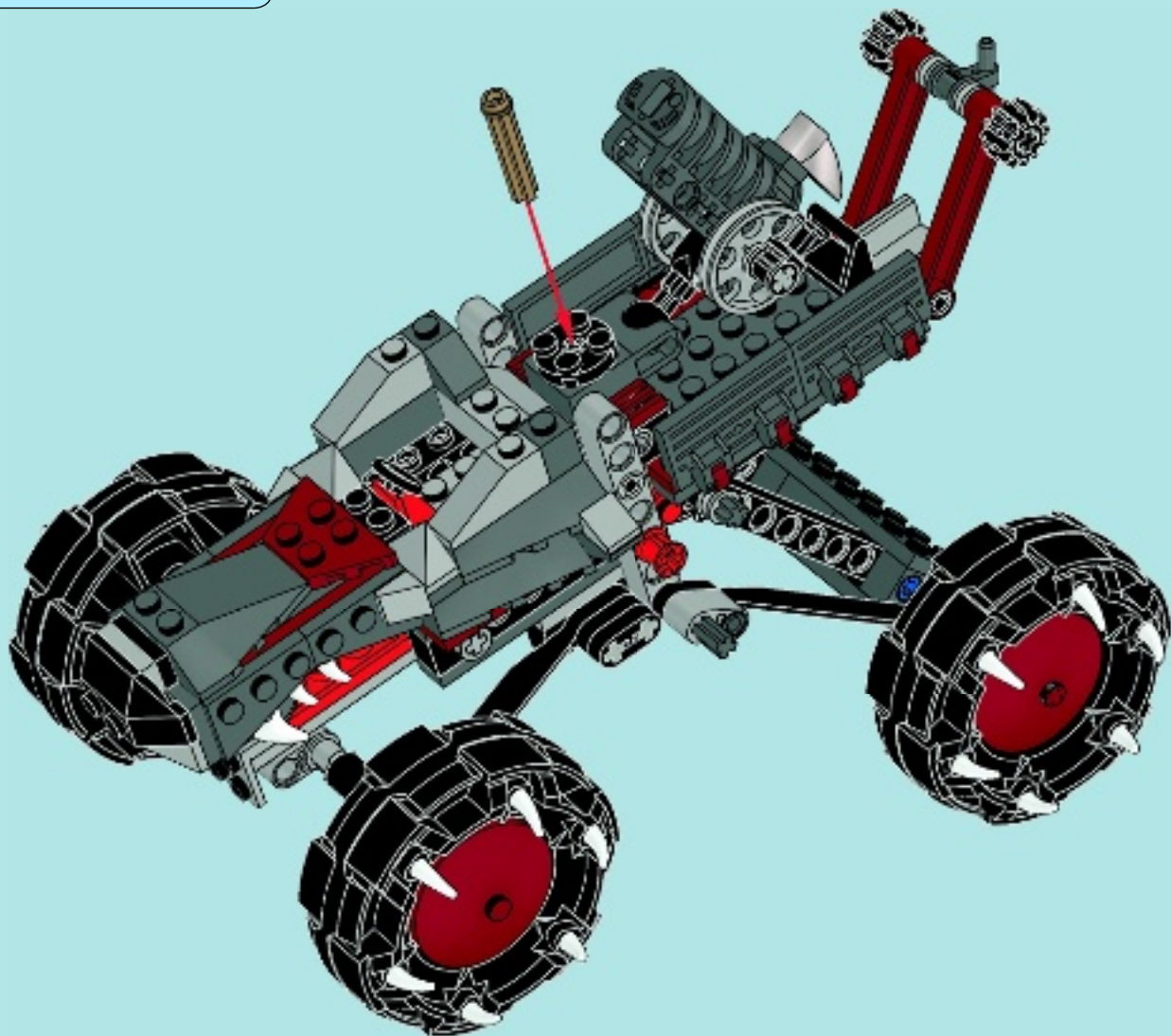

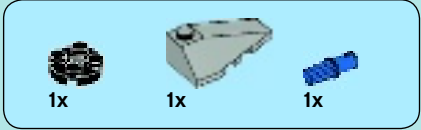

47

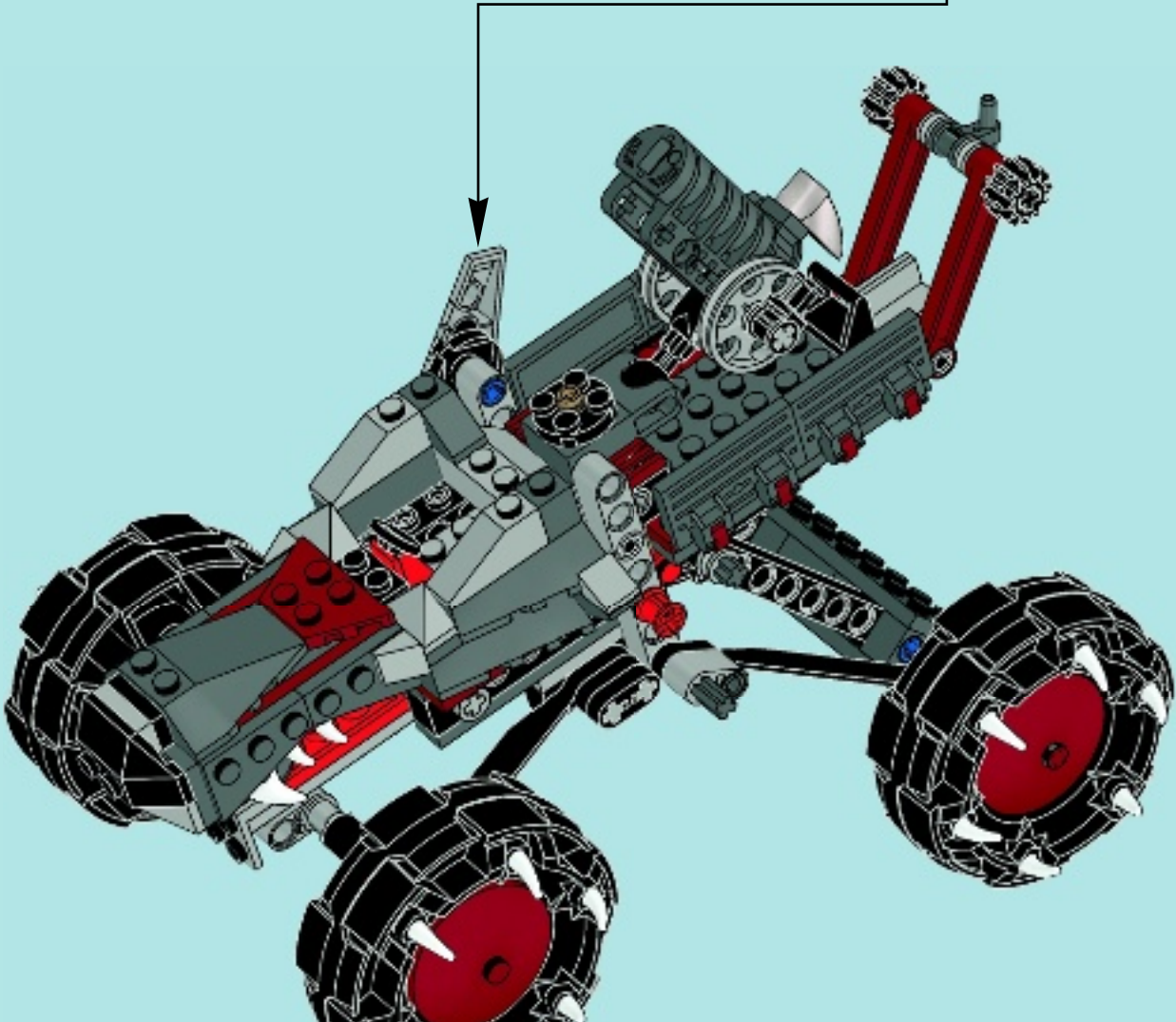
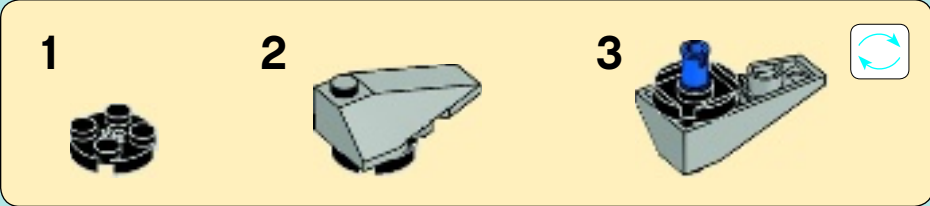



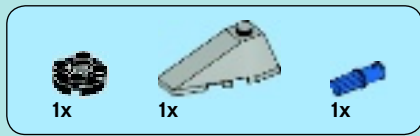

48

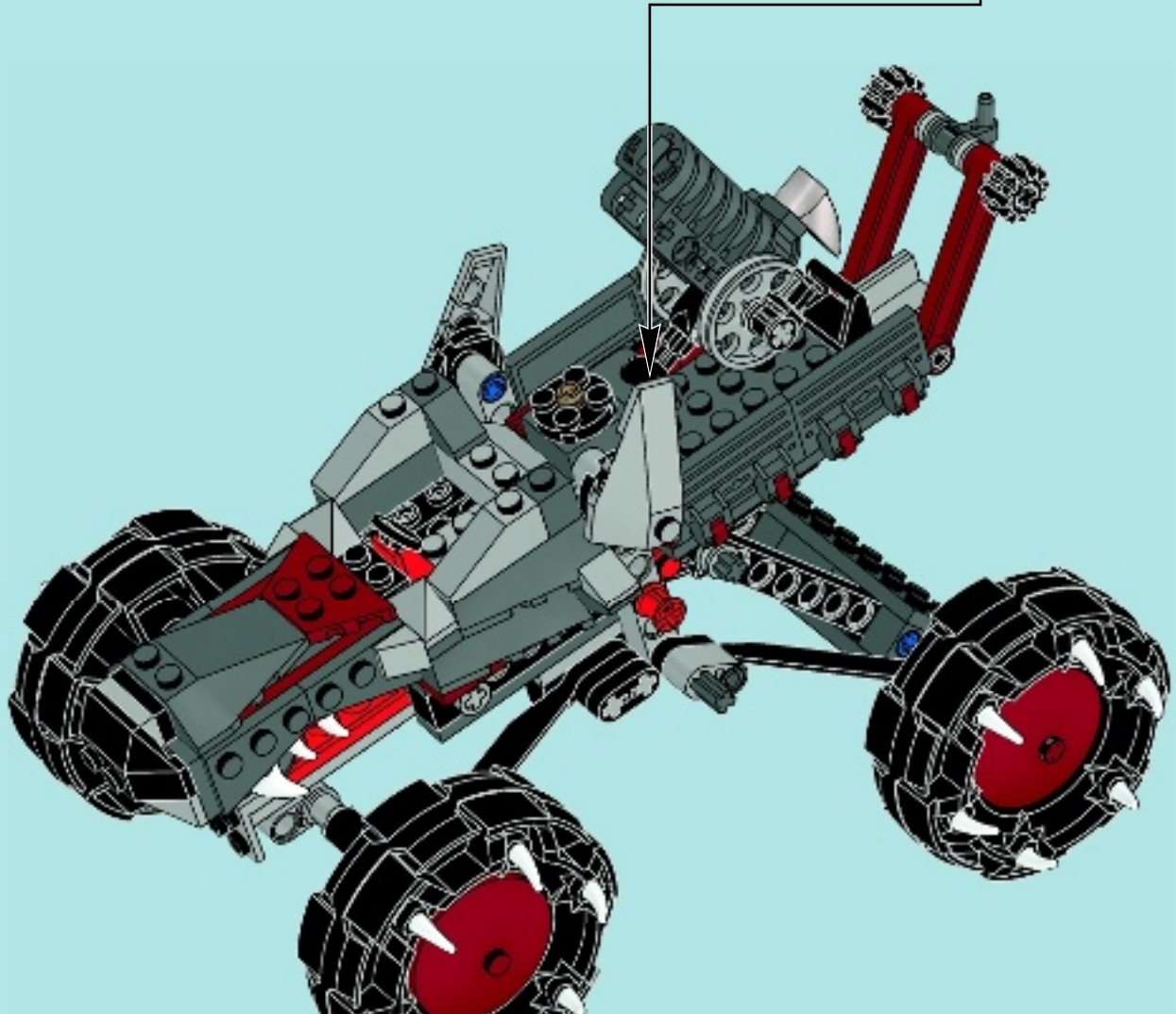



2x



1

# 49

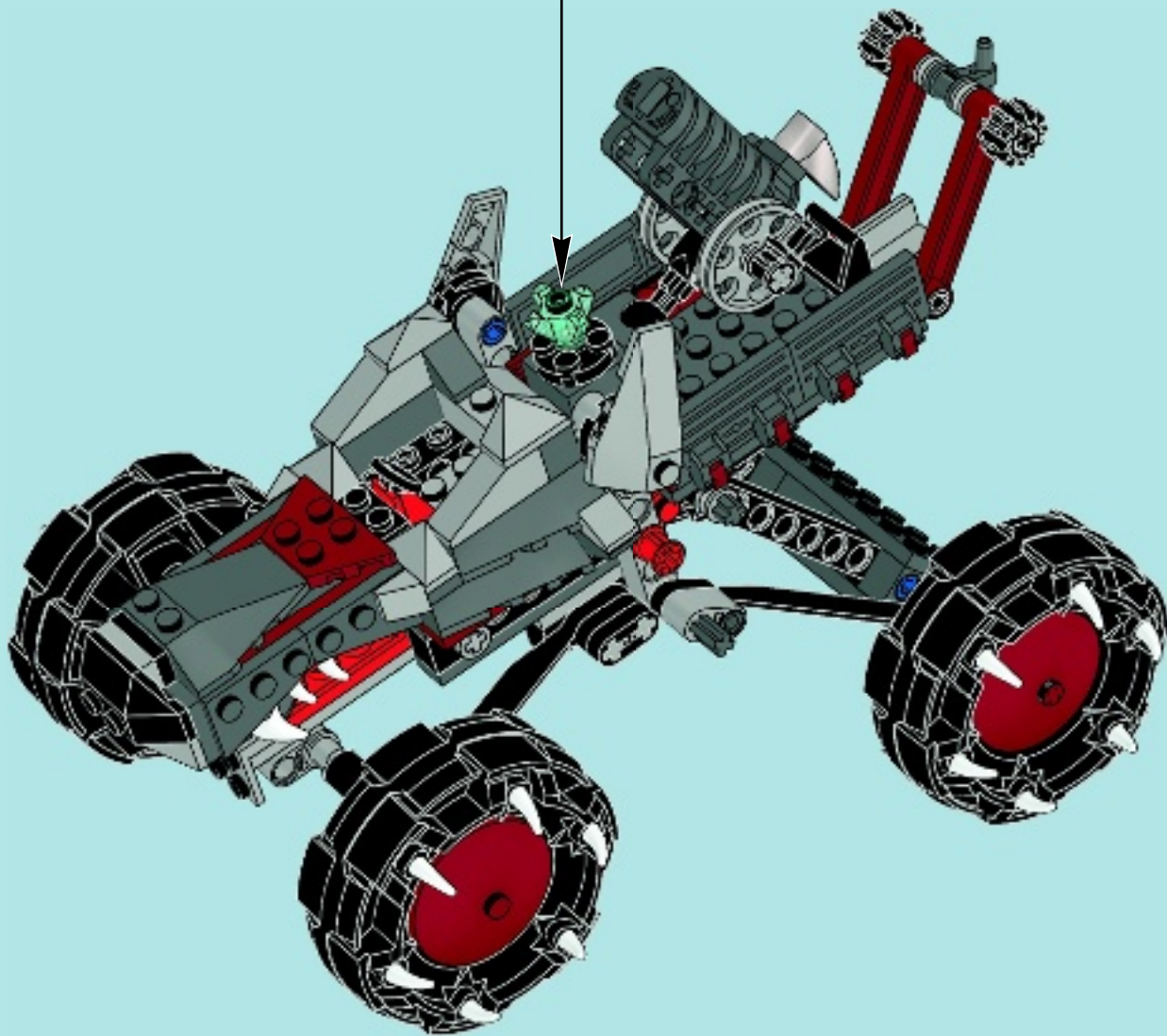

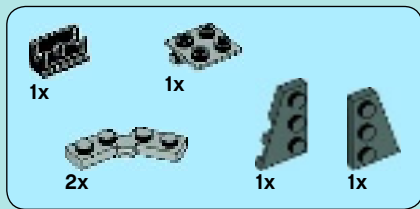

# 50

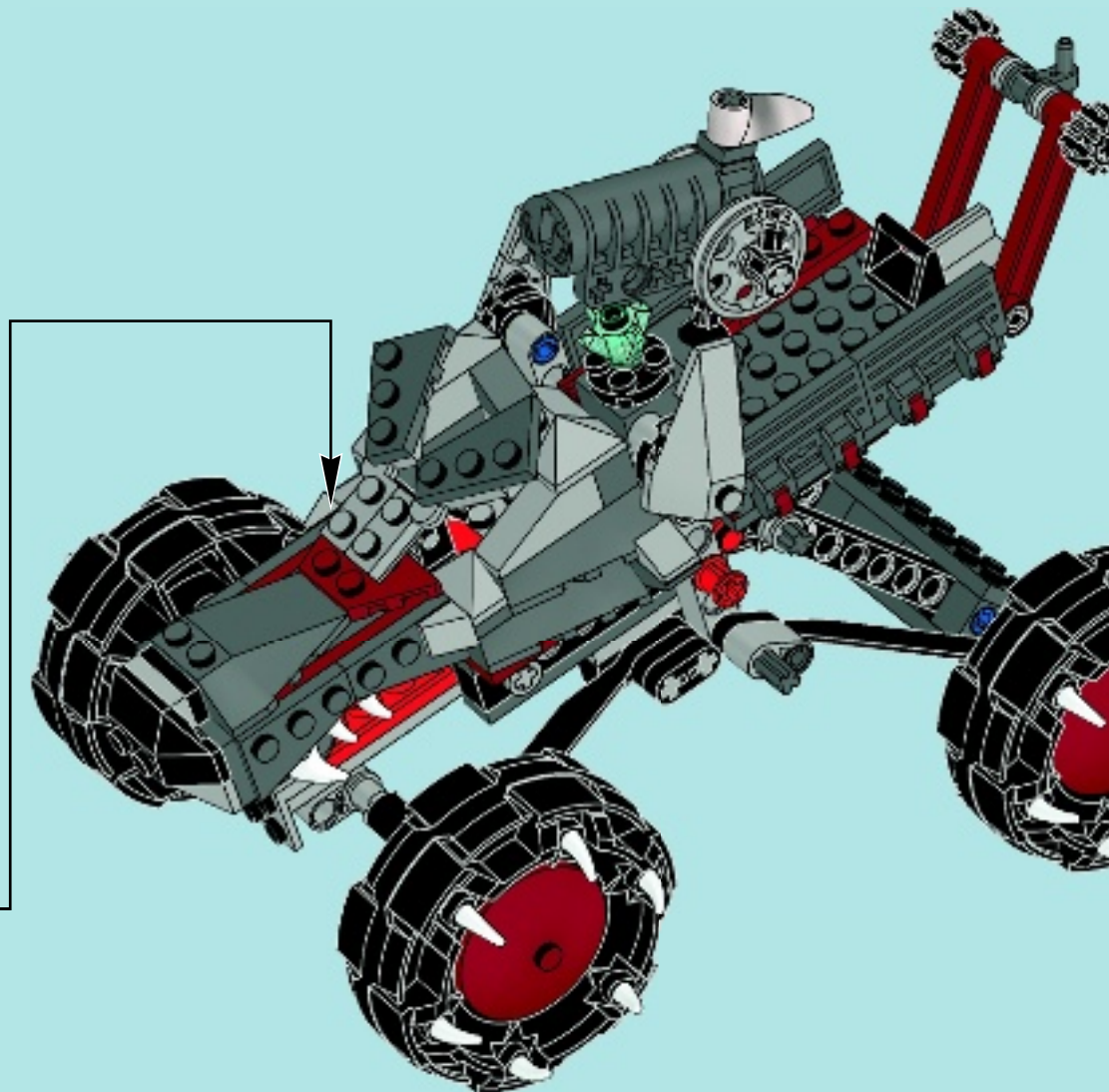
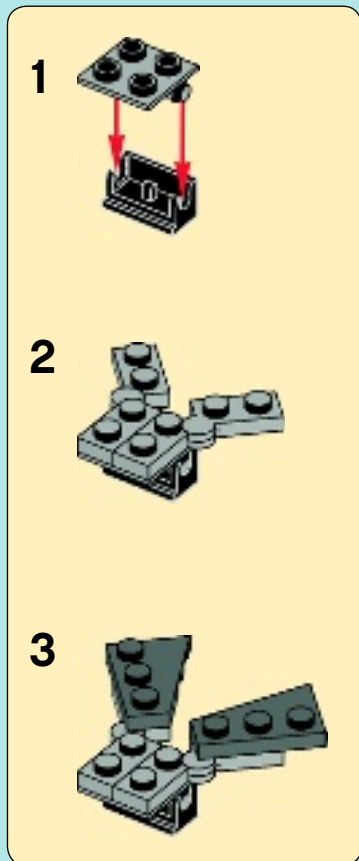



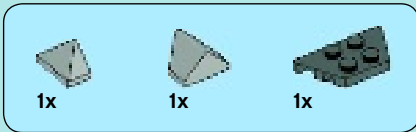

# 51

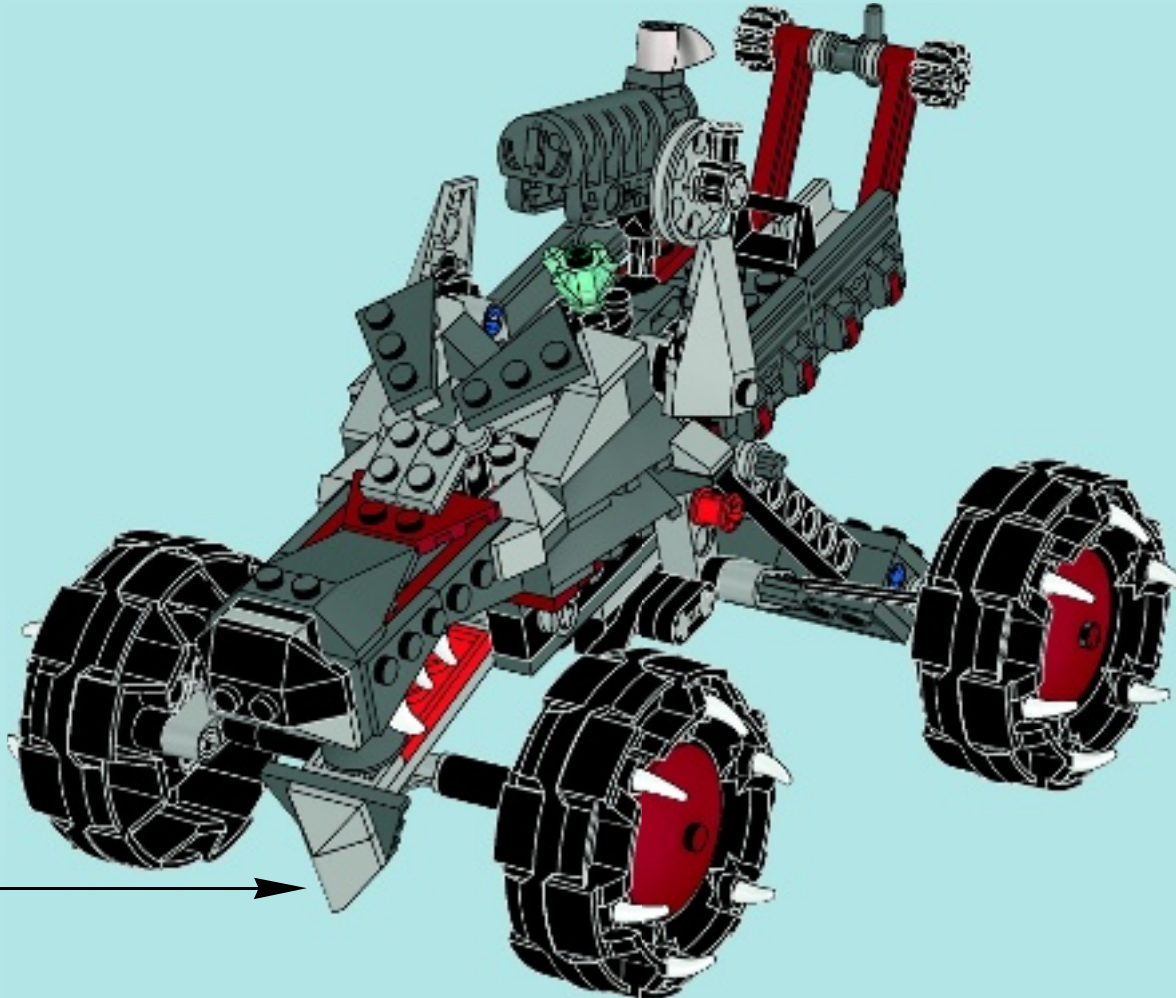



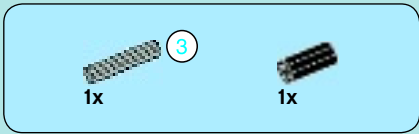

1

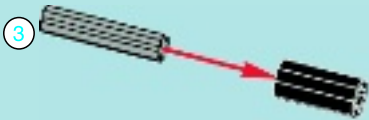

2

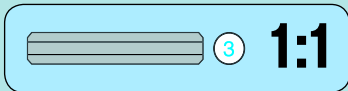

3



4





1x

5

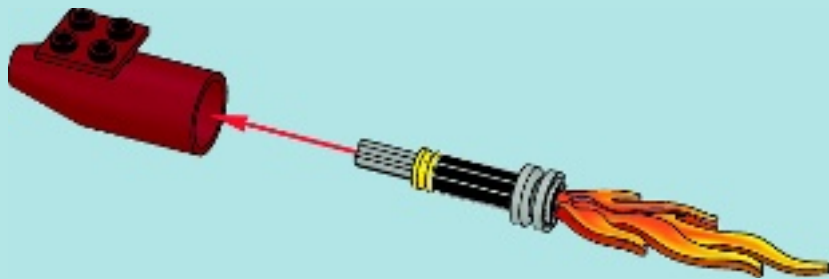

1x

6



2x

52

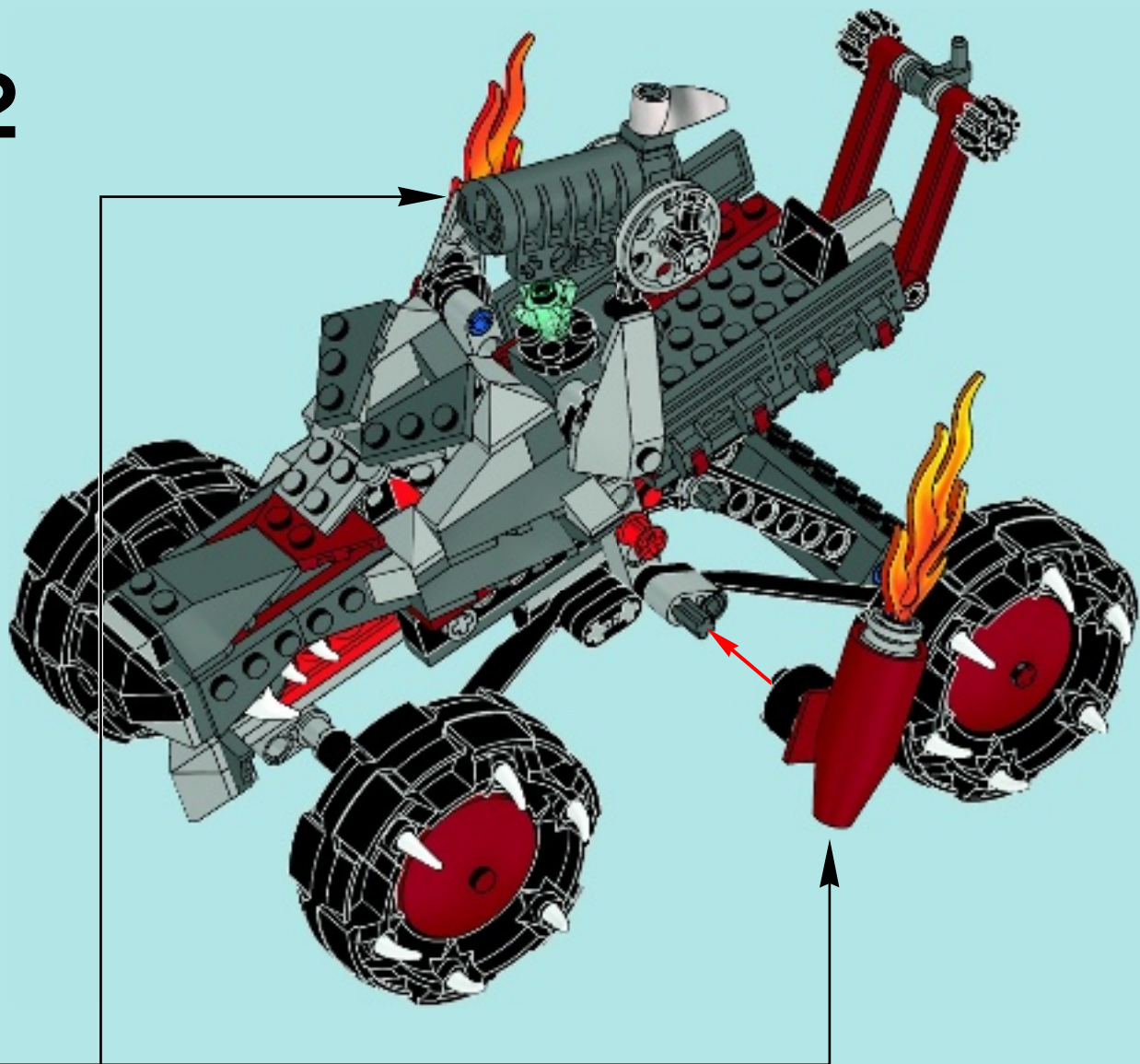



53

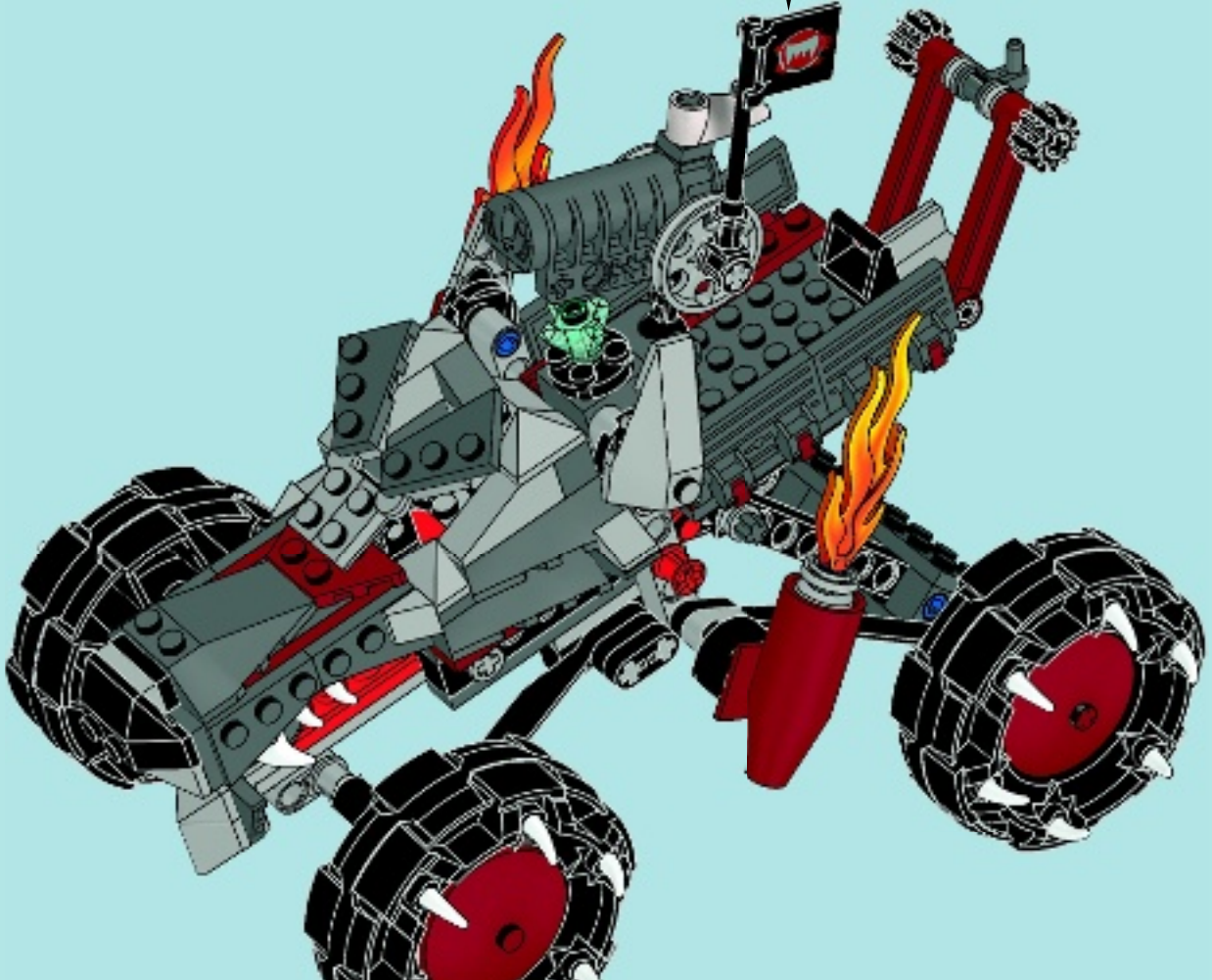
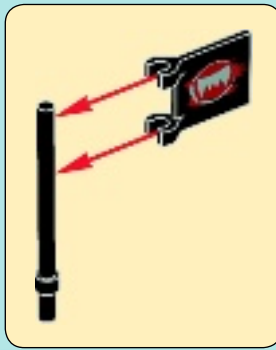

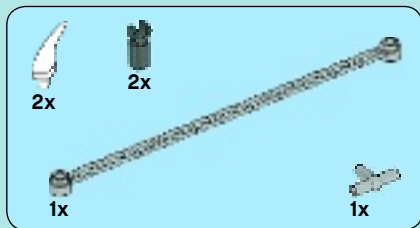

# 54

1



2



3



4





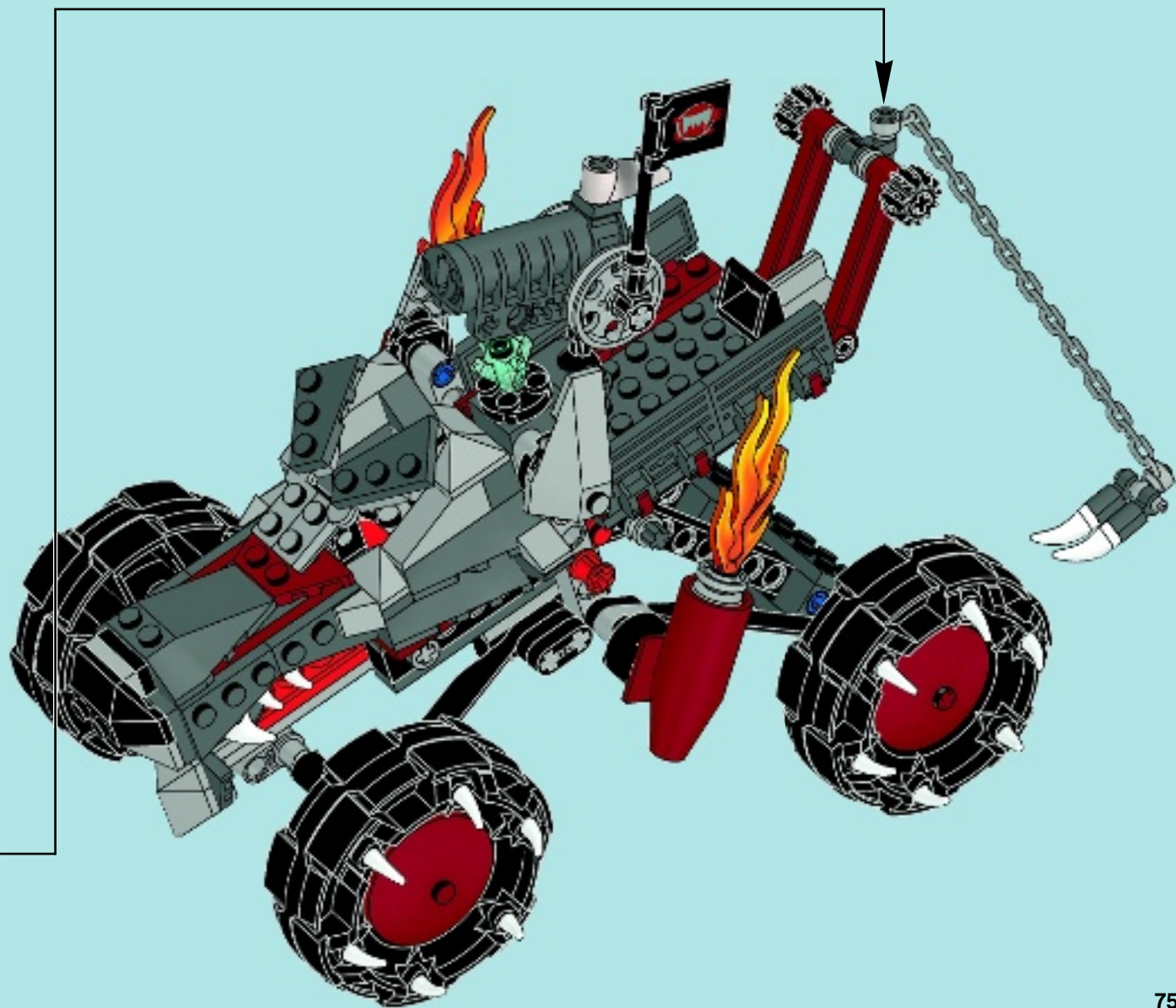



















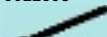



















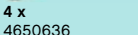





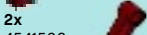





























55



 2x 6030716	 4x 403221	 4x 6019988	 2x 4177431	 4x 6021564
 1x 6022987	 1x 9552	 1x 6022893	 1x 4124108	 1x 4211376
 1x 6022296	 2x 4140806	 1x 4538722	 2x 4548009	 1x 4654577
 1x 4233225	 2x 4143005	 1x 4538722	 4x 6022171	 1x 4211752
 28x 4568387	 4x 4206482	 4x 4164133	 1x 6019570	 4x 4521921
 4x 4566256	 2x 4514553	 1x 393726	 1x 4566927	 4x 4211411
 4x 4566256	 6x 4239601	 4 x 4650636	 2x 4541506	 7x 4211411
 2x 6018302	 1x 4213298	 1x 4560108	 2x 6021580	 1x 4653091
 2x 4201062	 5x 302326	 1x 4521715	 3x 4539062	 2x 4211488
 2x 4113233	 4x 403226	 14x 4121715	 1x 6020122	 1x 4211409
 1x 300421	 1x 243226	 1x 4107081	 1x 4541544	 1x 4180418
 1x 302021	 2x 614326	 3x 4512363	 4x 4541386	 1x 4180408
 6x 4588003	 2x 370126	 2x 4526982	 1x 6022559	 1x 4211515
 2x 614121	 2x 370226	 2x 4154767	 2x 6024071	 2x 4211374
 1x 4255035	 2x 389526	 1x 370626		

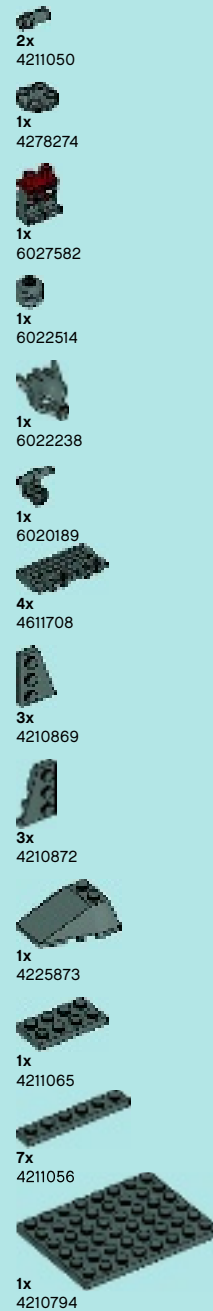
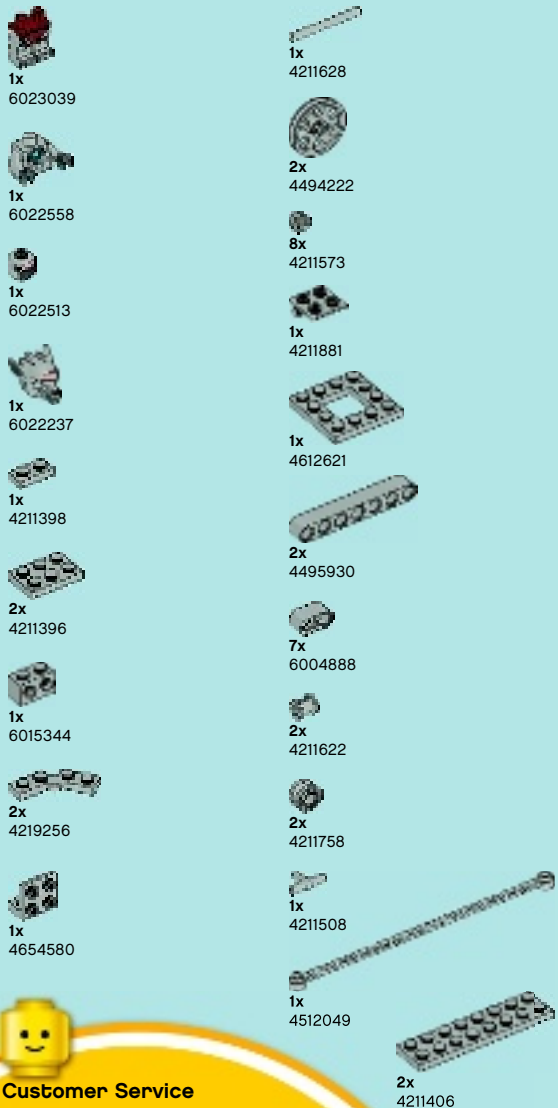

**Customer Service**  
Kundenservice  
Service Consommateurs  
Servicio Al Consumidor  
[LEGO.com/service](http://LEGO.com/service) or dial







# LEGO CHIMA



LENNOX CRAEGER

70006



70000



70001



70006



70005



70004



70003



70002





# LEGO CHIMA

# SPEEDORZ



70115



70115



**WATCH THE MODEL IN ACTION**  
 ERLEBE DAS MODELL IN AKTION  
 REGARDE LA DÉMO DU MODÈLE EN ACTION  
 MIRA EL MODELO EN ACCIÓN  
 VÉ O MODELO EM ACÃO  
 NÉZD MEG A MODELLT MŰKÖDÉS KÖZBEN



70100

70103

70102

70113







# LEGEND OF CHIMA



# LEGO.COM/CHIMA





# WORLD OF CHIMA

## 4DX MOVIE EXPERIENCE

4D-MOVIE-XPRIENCE  
EXPERIENCE FILM EN 4D  
EXPERIENCIA CINEMATOGRAFICA 4D  
EXPERIÊNCIA DE FILME EM 4D  
4D FILM-ÉLMÉNY



 **EXCLUSIVELY  
AT LEGOLAND  
- THE 4D CHIMA  
EXPERIENCE**

**FIND OUT MORE AND GET SPECIAL OFFERS AT  
LEGOLAND-CHIMA.COM**



**EXKLUSIV IM LEGOLAND: DAS CHIMA 4D-ERLEBNIS  
WEITERE INFORMATIONEN UND SONDERANGEBOTE UNTER  
LEGOLAND-CHIMA.COM**



**EN EXCLUSIVITÉ À LEGOLAND - L'EXPÉRIENCE CHIMA EN 4D  
OBTENEZ PLUS D'INFORMATIONS ET DES OFFRES SPÉCIALES SUR  
LEGOLAND-CHIMA.COM**



**SÓLO EN LEGOLAND: LA EXPERIENCIA CHIMA 4D  
MÁS INFORMACIÓN Y OFERTAS ESPECIALES EN  
LEGOLAND-CHIMA.COM**



**EXCLUSIVAMENTE NA LEGOLAND - A EXPERIÊNCIA CHIMA EM 4D  
DESCOBRER MAIS E OBTÉM OFERTAS ESPECIAIS EM  
LEGOLAND-CHIMA.COM**



**CSAK LEGOLANDBAN - 4D CHIMA ÉLMÉNY  
OLVASS RÓLA BŐVEBBEN, ÉS KERESD A KÜLÖNLEGES AJÁNLATOKAT A  
LEGOLAND-CHIMA.COM HONLAPON**



1



2



3

www.LEGOclub.com/Max

www.LEGOclub.com/Max



club™

FREE\*! GRATIS! GRATUIT!

\*Paid subscription in Australia and New Zealand. \*Abonnement payant en Australie et Nouvelle-Zélande.





# WIN!

Go to [www.LEGOsurvey.com/product](http://www.LEGOsurvey.com/product)  
to fill out a survey for a chance  
to win a cool LEGO® Product.  
No purchase necessary.  
Open to all residents where not prohibited.



## [www.LEGOsurvey.com/product](http://www.LEGOsurvey.com/product)

### GEWINNE! WIN!

Nimm an der Umfrage auf  
[www.LEGOsurvey.com/product](http://www.LEGOsurvey.com/product)  
teil und hab die Chance ein cooles  
LEGO® Produkt zu gewinnen!

Die Teilnahme am Gewinnspiel führt zu keinerlei  
Kaufverpflichtungen. Teilnahme in allen nicht  
ausgeschlossenen Ländern möglich.

Ga naar [www.LEGOsurvey.com/product](http://www.LEGOsurvey.com/product),  
vul een  
enquêteformulier in en maak  
kans op een cool LEGO® product.

Geen aankoopverplichting.  
Iedereen mag deelnemen, uitgezonderd  
ingezetenden van landen waar een  
enquêteverbod geldt.

### GAGNE! 当てよう!

Visite [www.LEGOsurvey.com/product](http://www.LEGOsurvey.com/product)  
pour répondre à un  
questionnaire et avoir une chance de  
gagner un produit LEGO® très cool!

Aucune obligation d'achat.  
Ouvert à tous les résidents des pays  
autorisés.

[www.LEGOsurvey.com/product](http://www.LEGOsurvey.com/product) にアクセスして、  
アンケートにご記入ください。当選者にはレゴ  
製品を差し上げます。

お買い上げの必要はありません

禁止されていない限り、すべての皆様にご利用いただけます。



LEGO.com

6036613

LEGO and the LEGO logo are trademarks of the LEGO Group. ©2013 The LEGO Group.