



LEGENDS OF  
**CHIMA**



70002





32

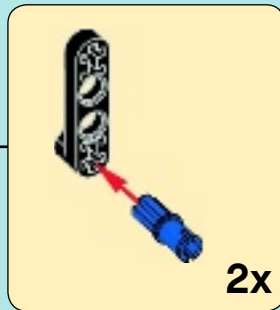
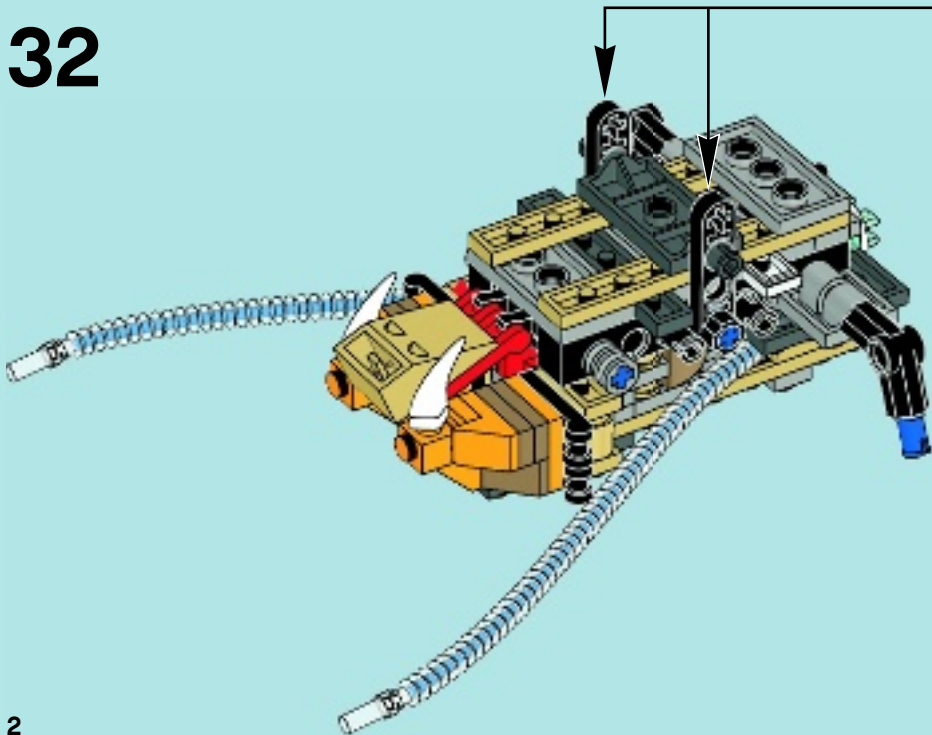



33

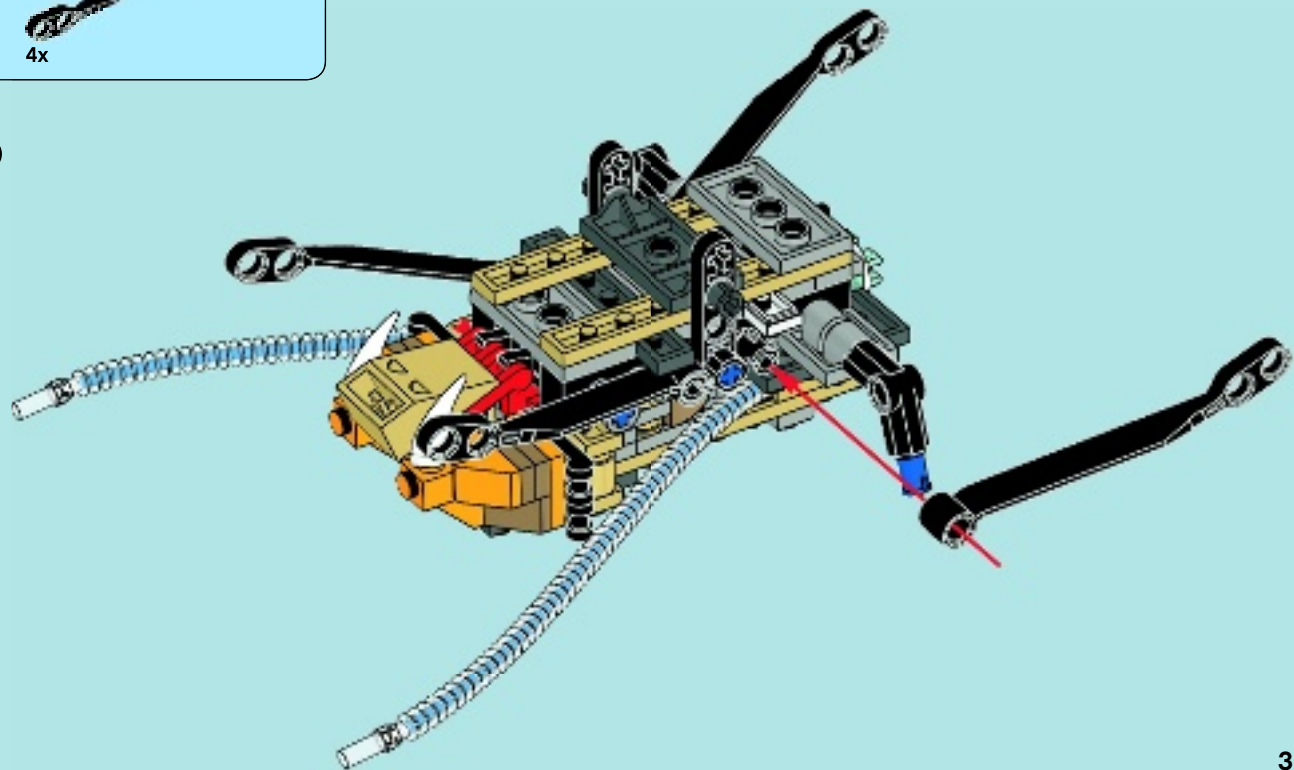

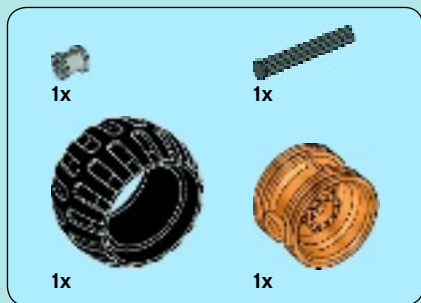

**34**

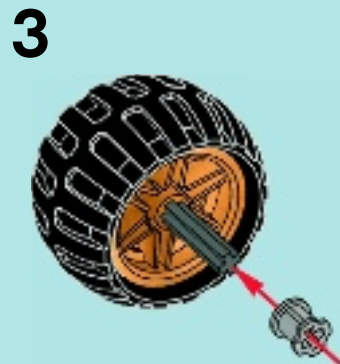
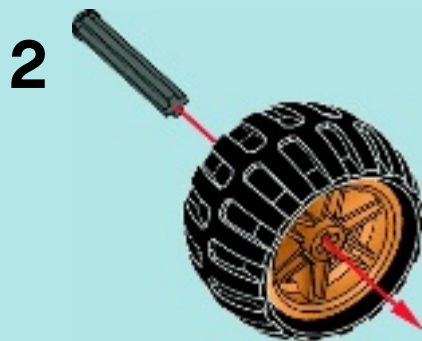
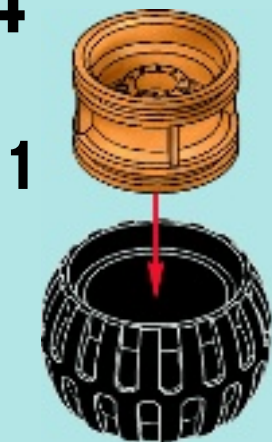

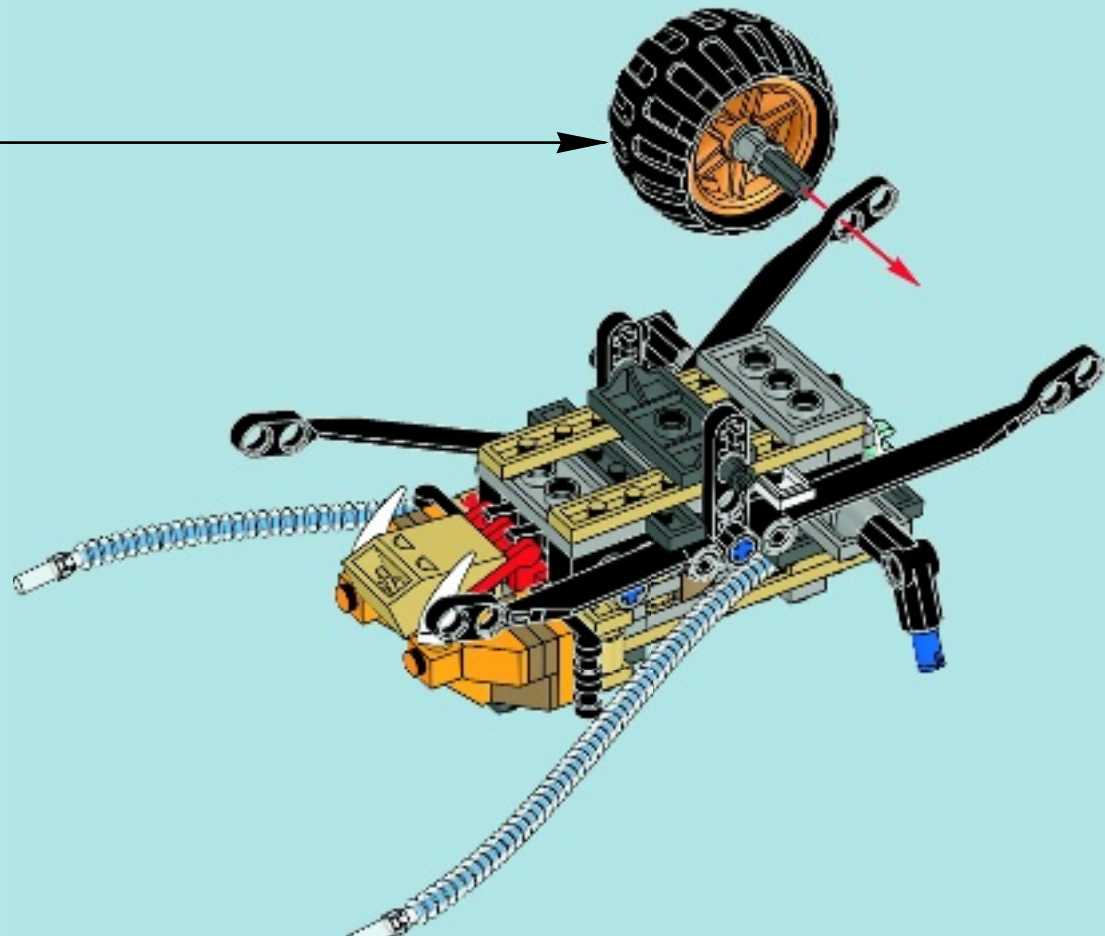



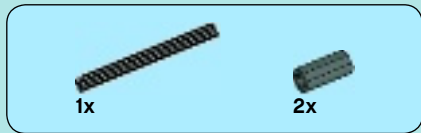

35

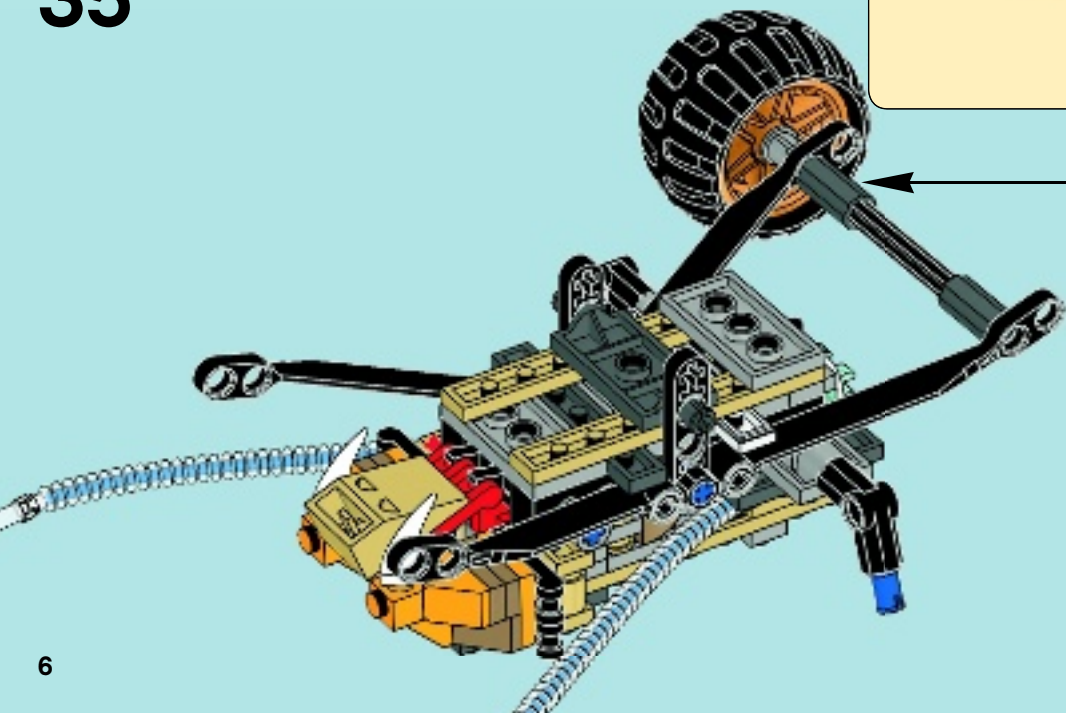
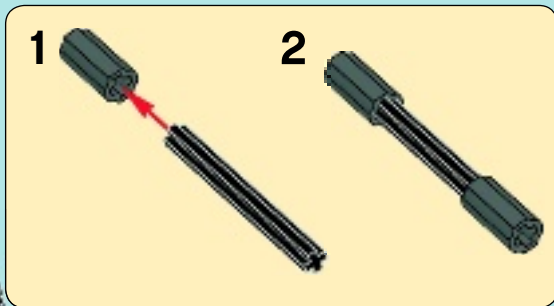

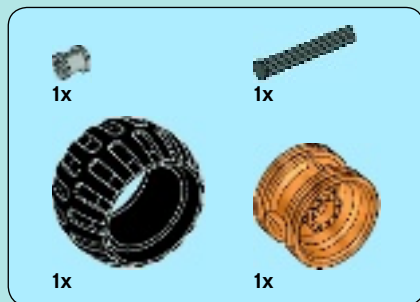

**36**

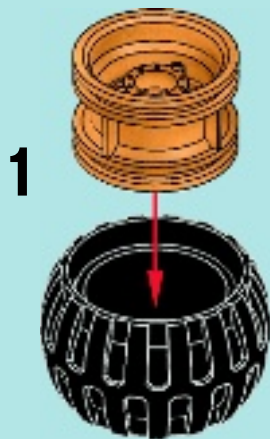

**2**



**3**

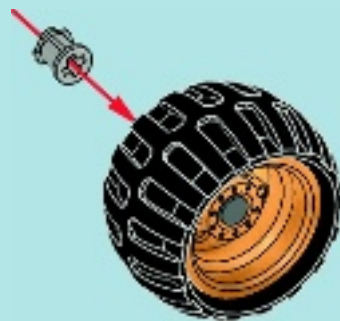

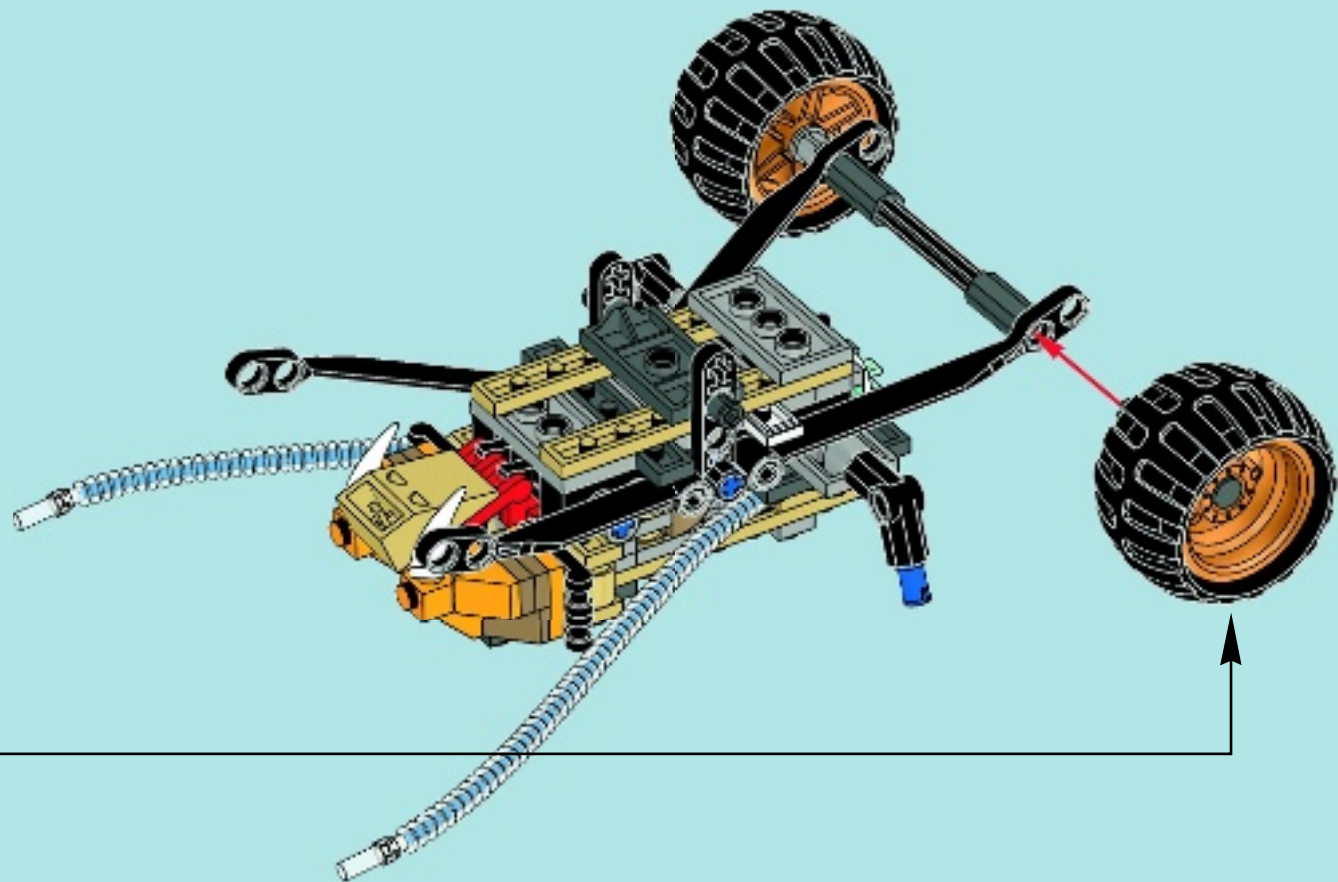



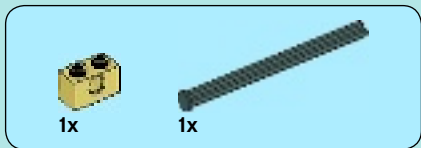

1

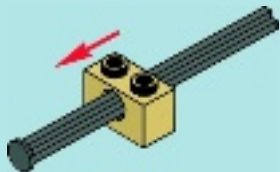

2

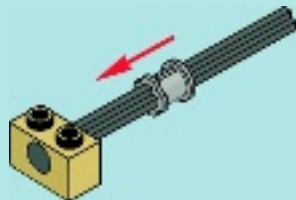



1x



1x

3

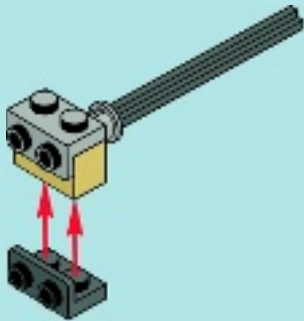

1x



1x

4

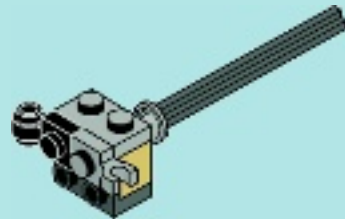



1x

5

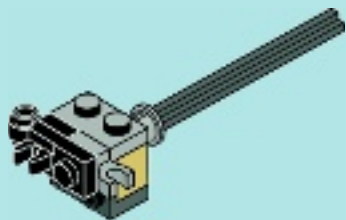

1x



1x

6

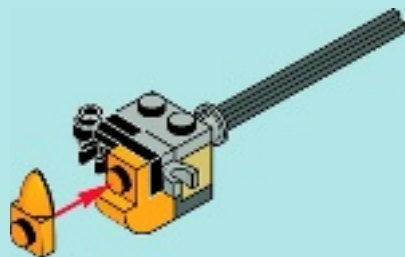



7

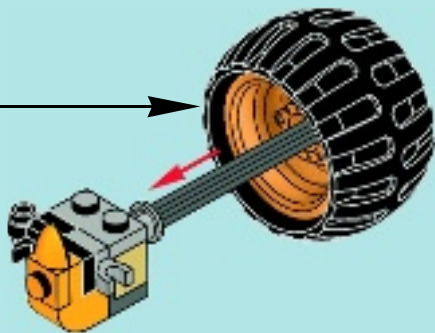
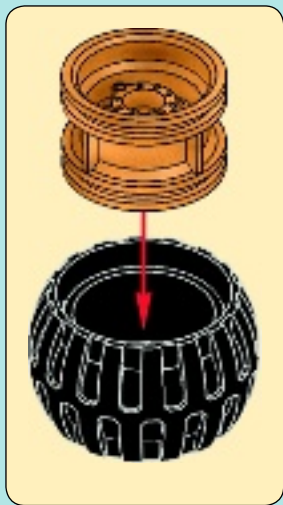



1x

8

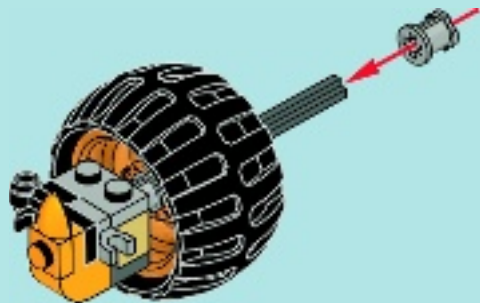

2x

9



37

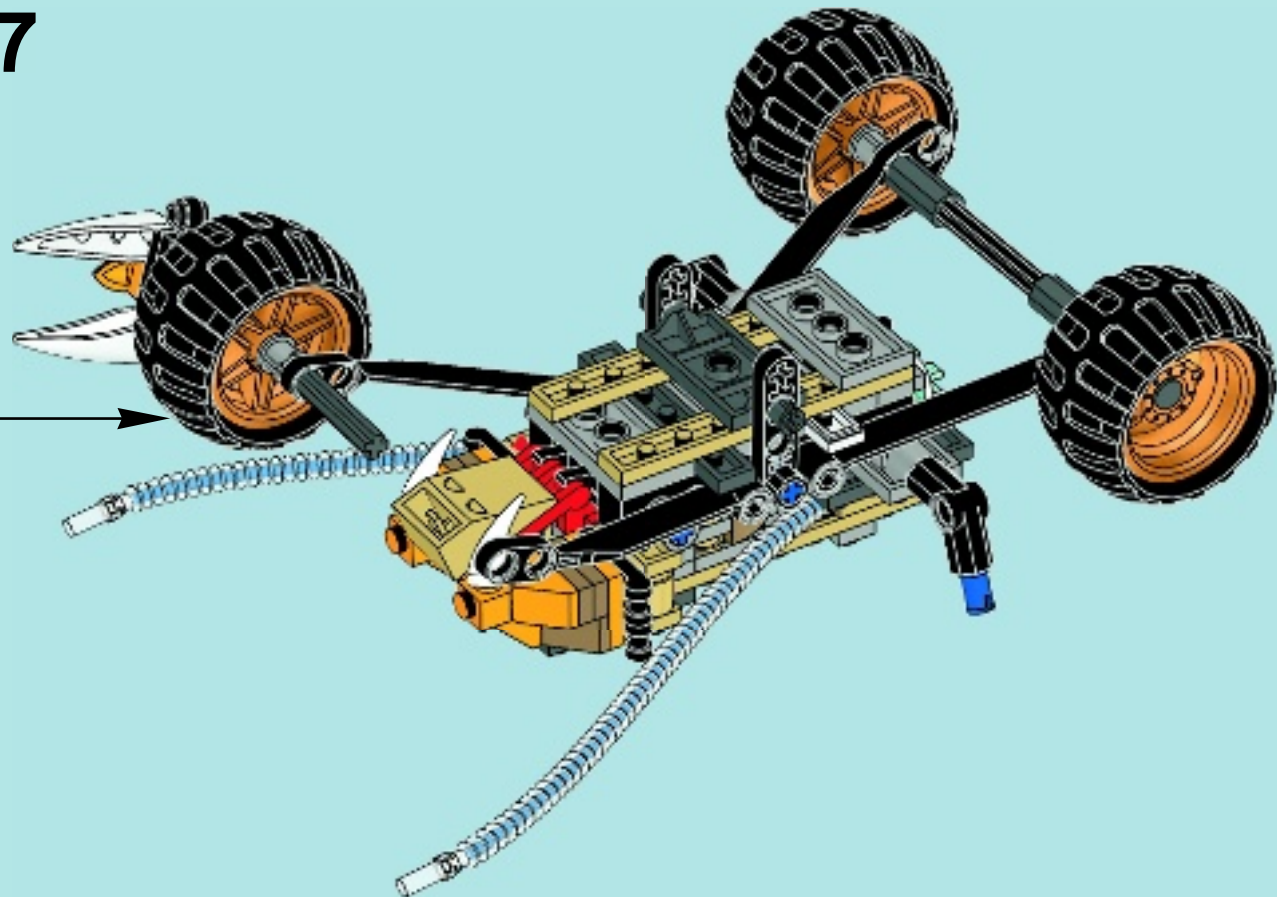





1x

38

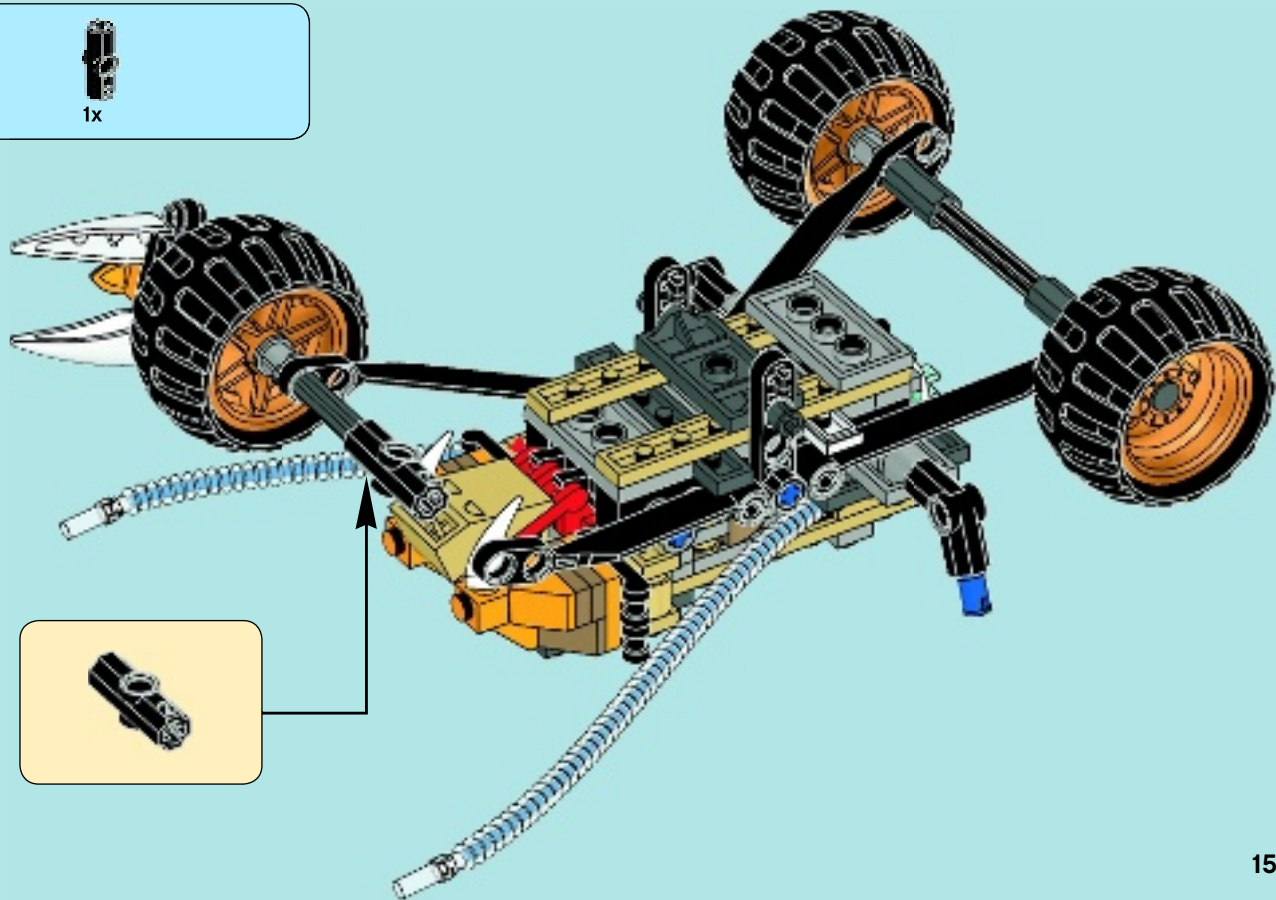

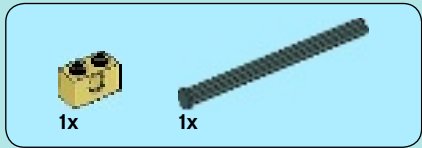

1

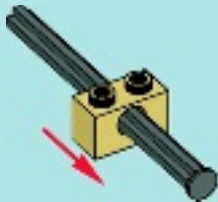

2





1x



1x

3

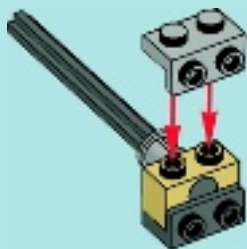

1x



1x

4





1x

5

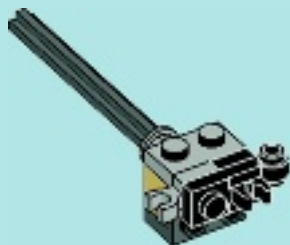

1x



1x

6





7

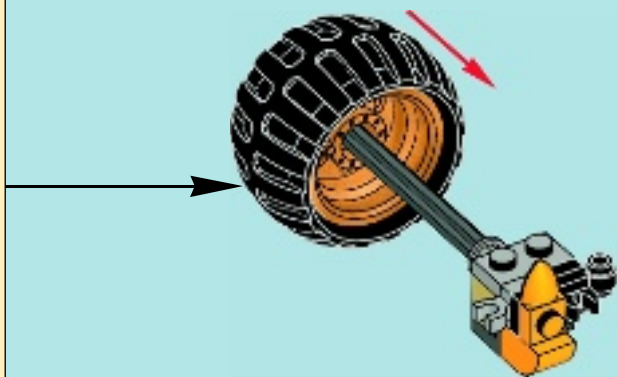
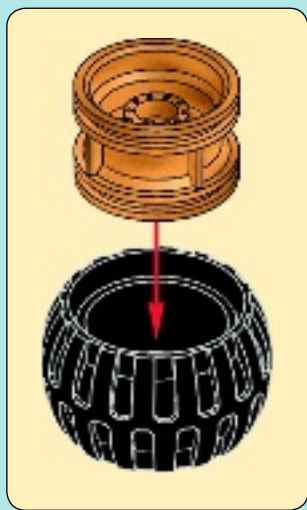



1x

8

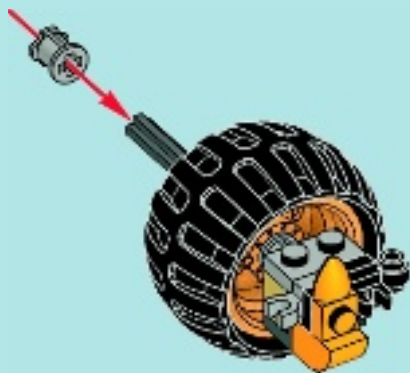

2x

9





39

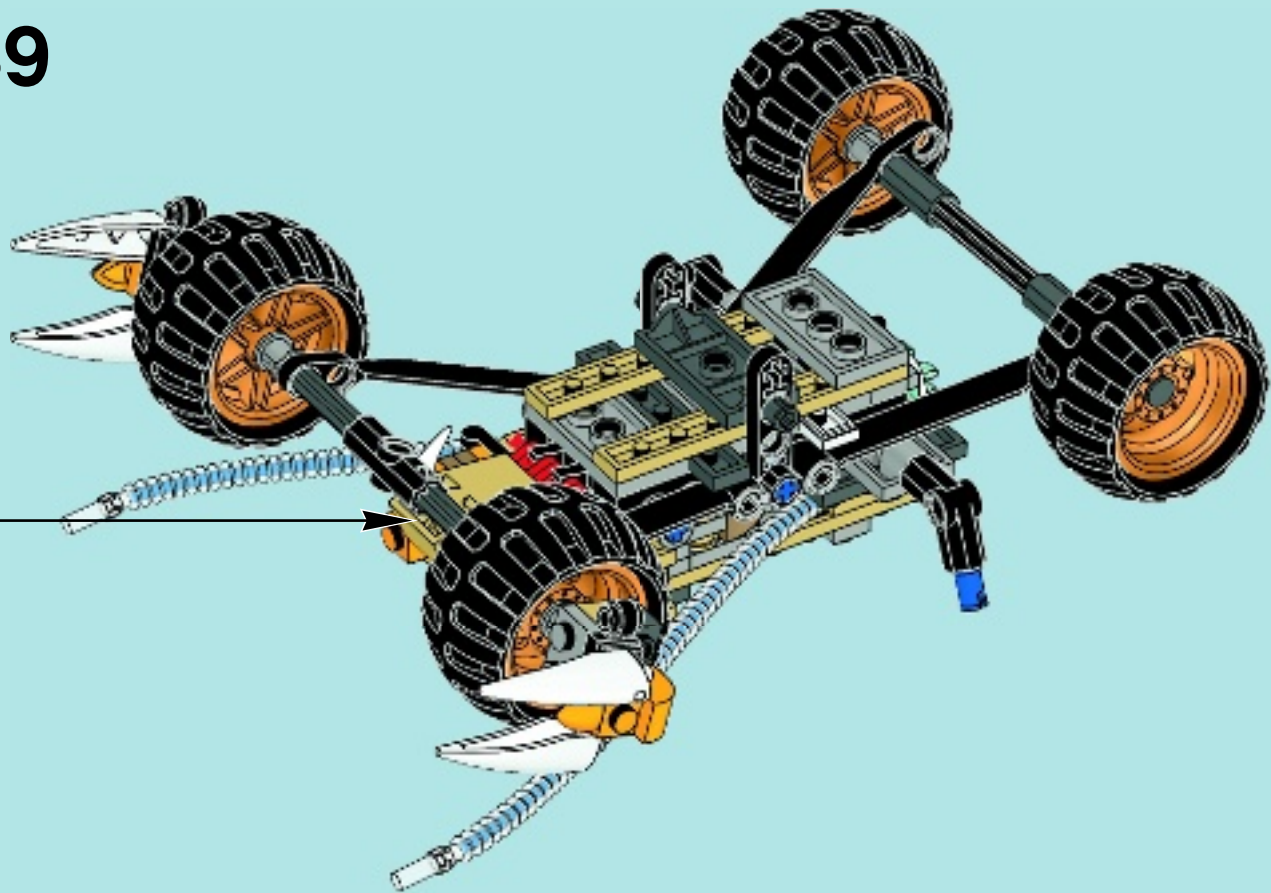

40

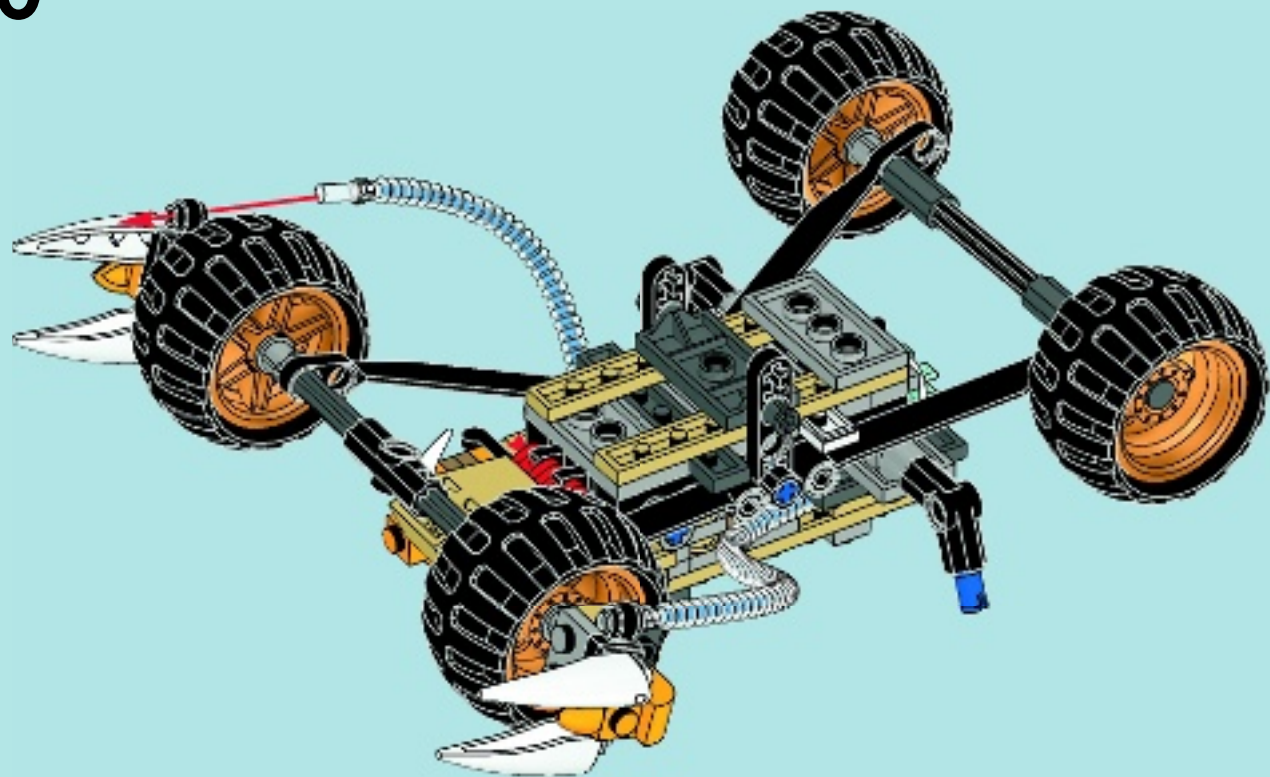



1x



2x

41

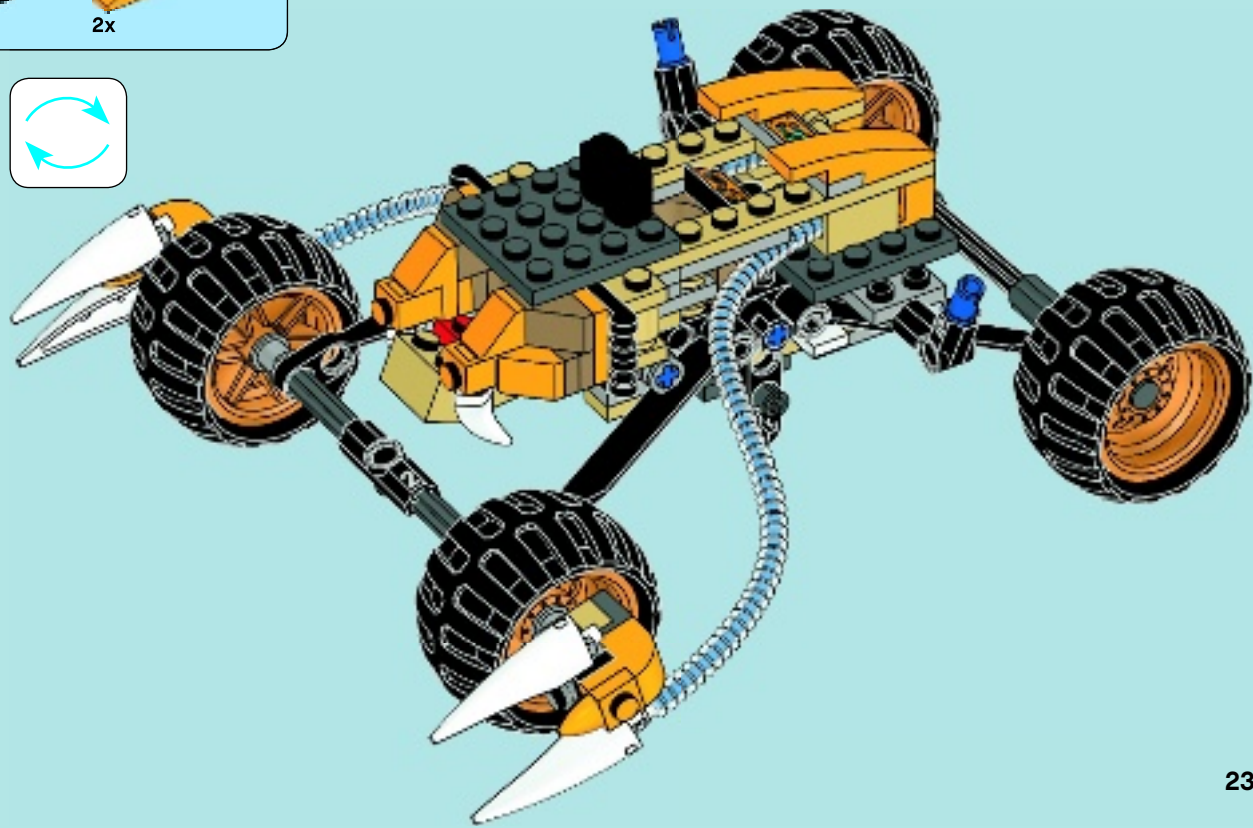
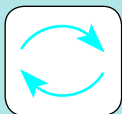

42

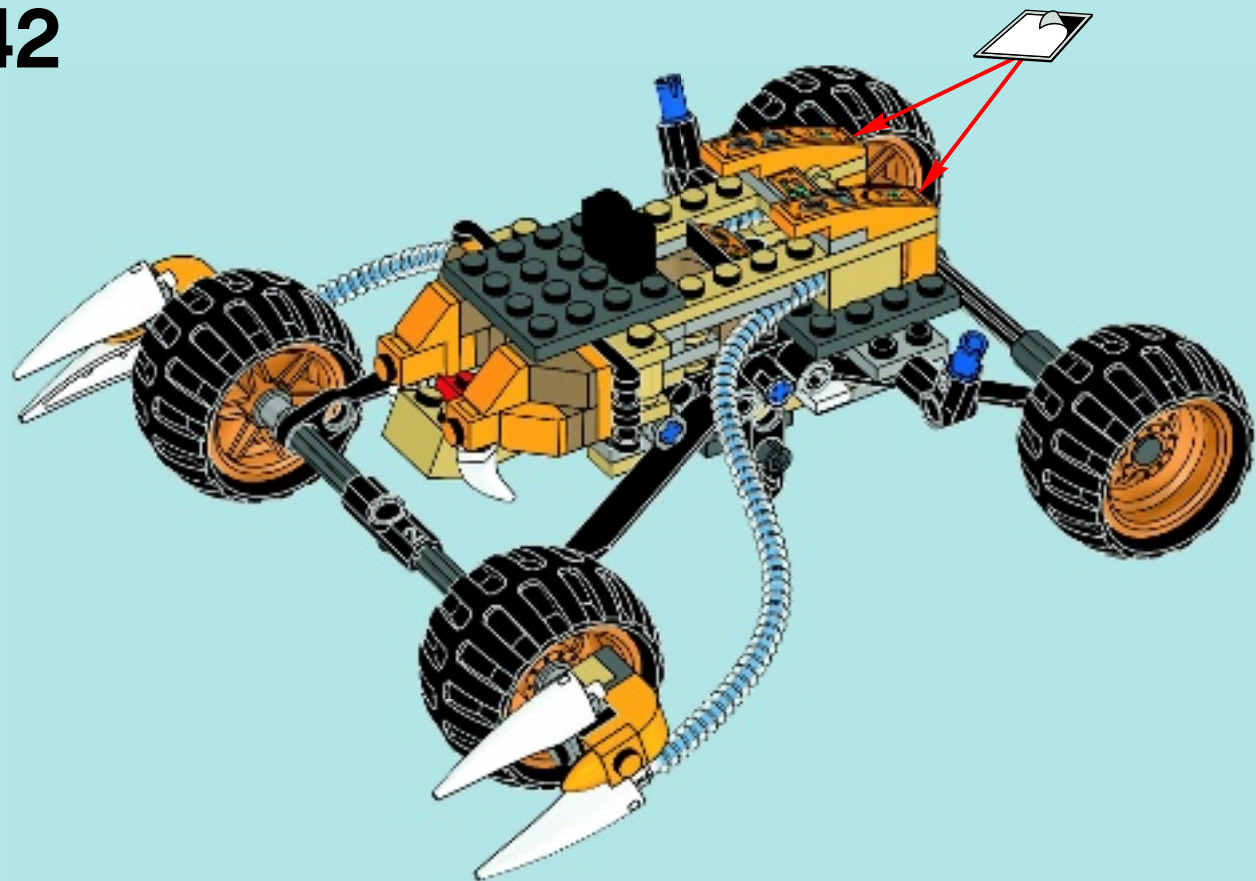

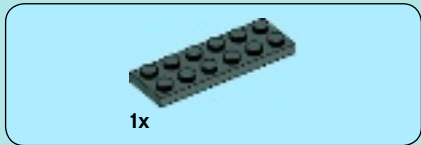

1

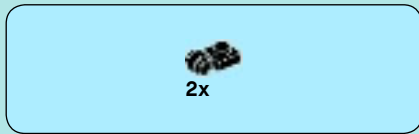
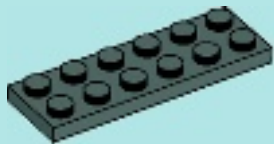

2



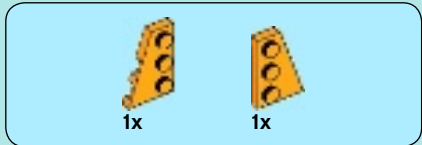

3



4







1x



1x

5



2x

6





1x

7

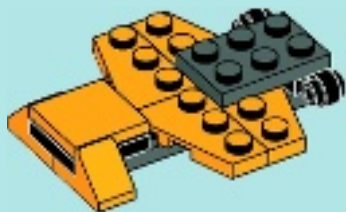

1x

8

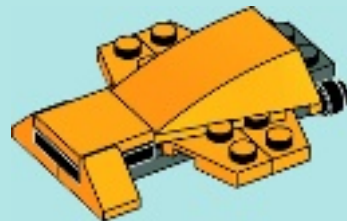



2x



1x



1x

# 9

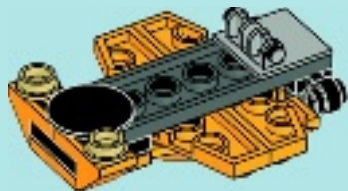
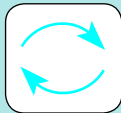



2x



1x

# 10

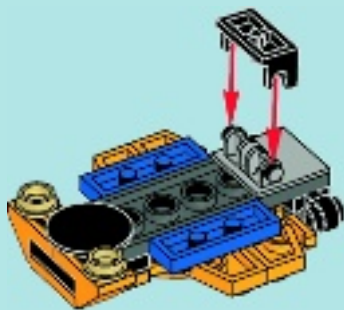

2x

# 11

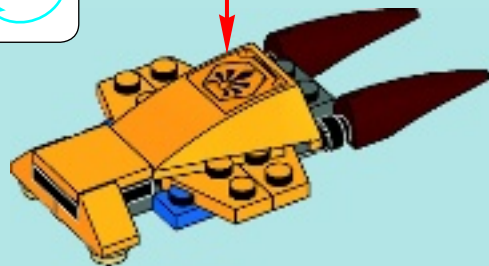
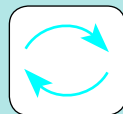

43

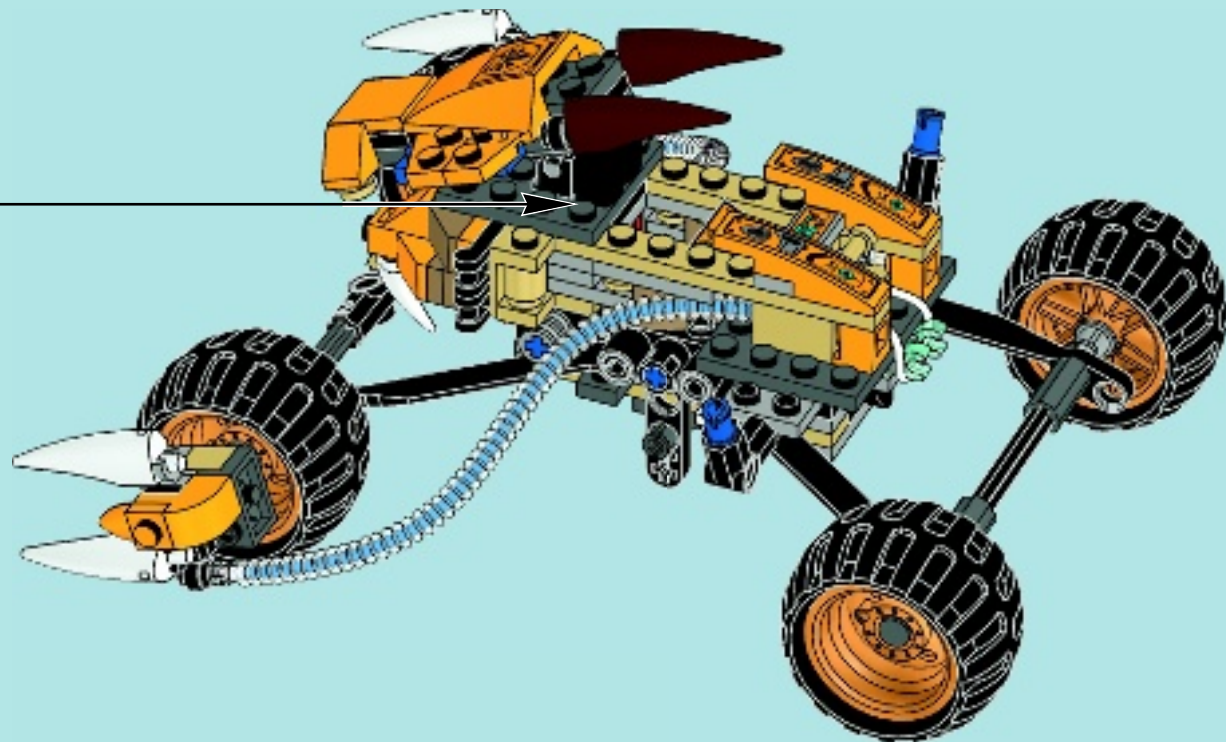

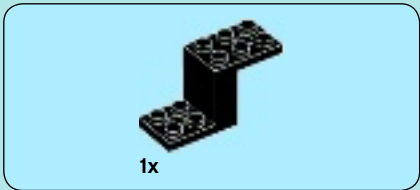

1



2

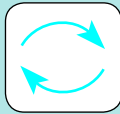



1x

3



1x



1x

4

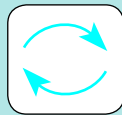

44

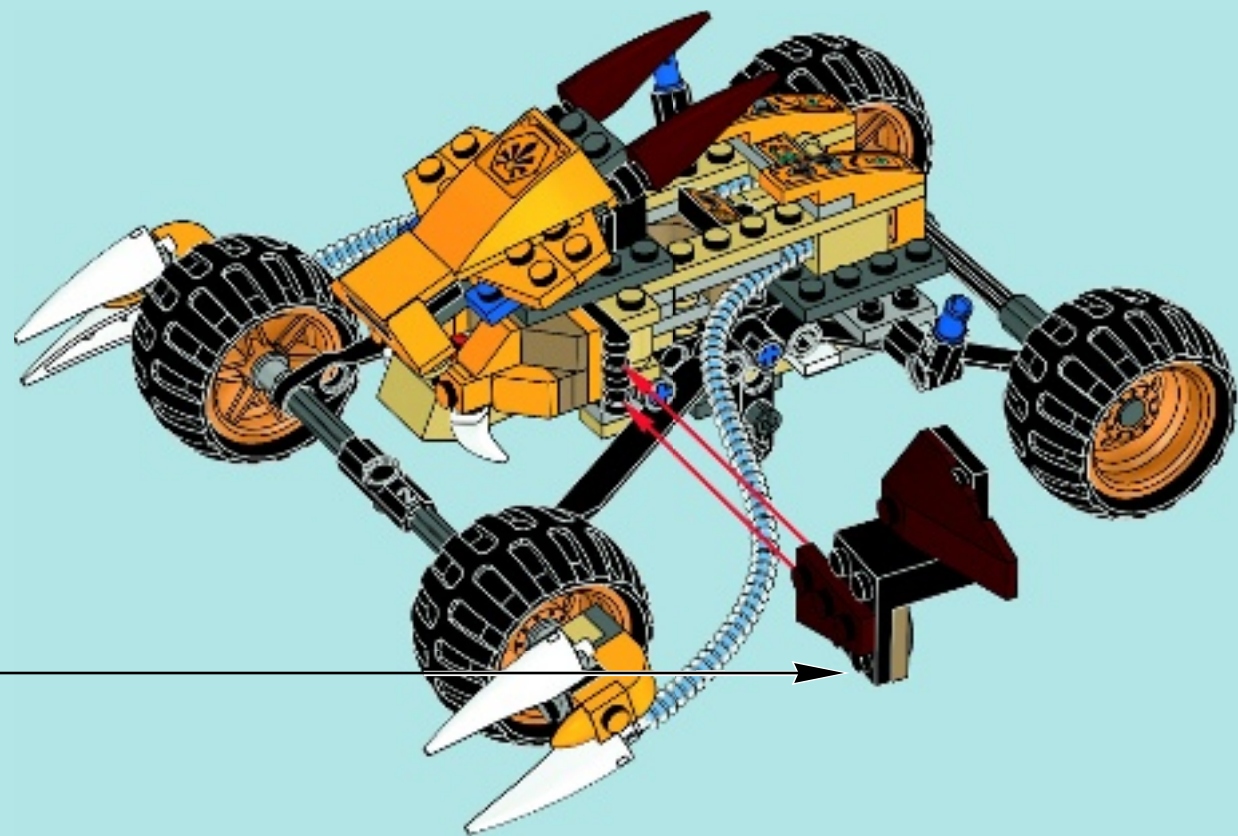



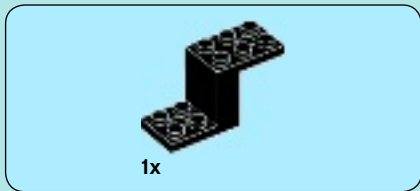

1x

1

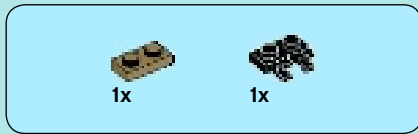

1x

1x

2

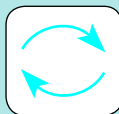



1x

3



1x



1x

4

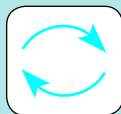

45

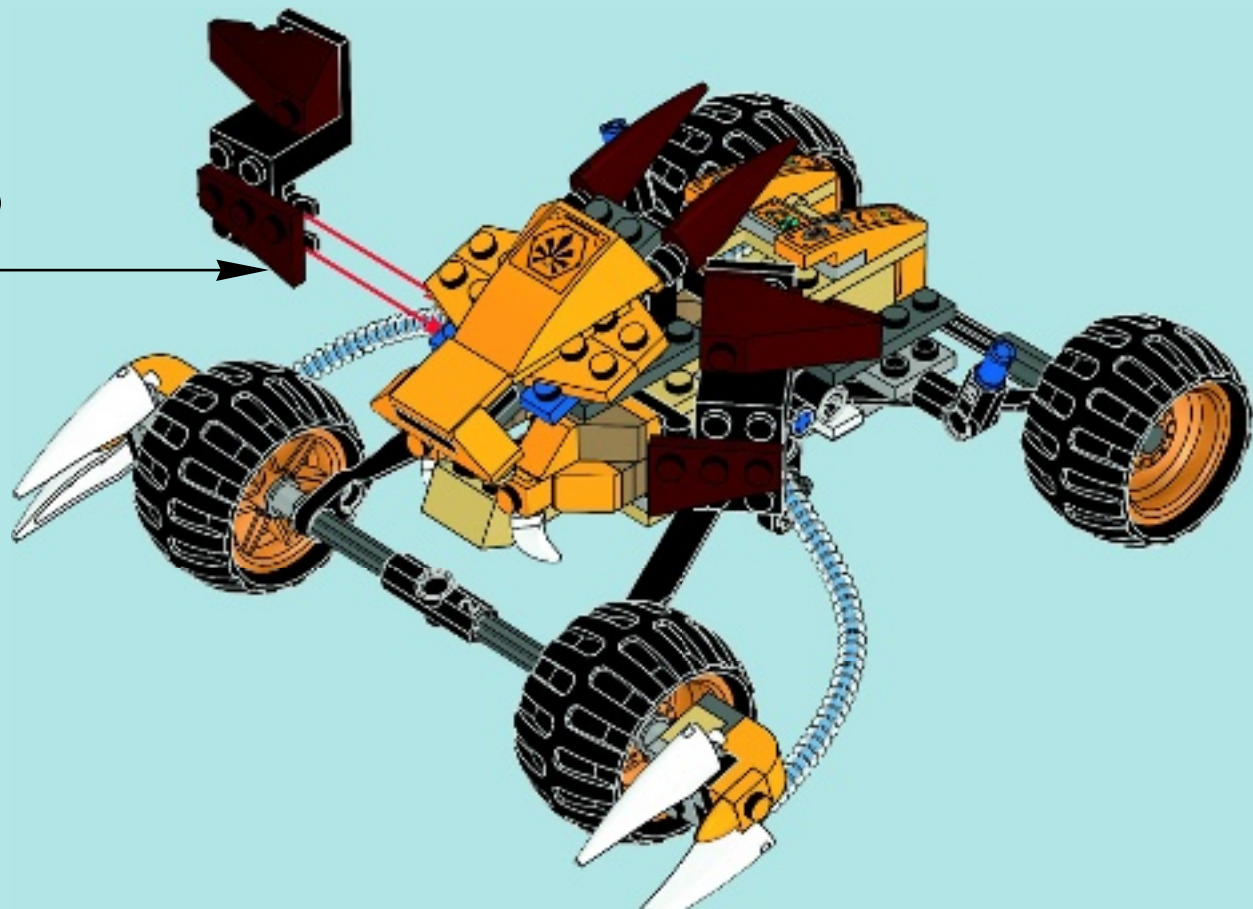



1x



1x

# 46

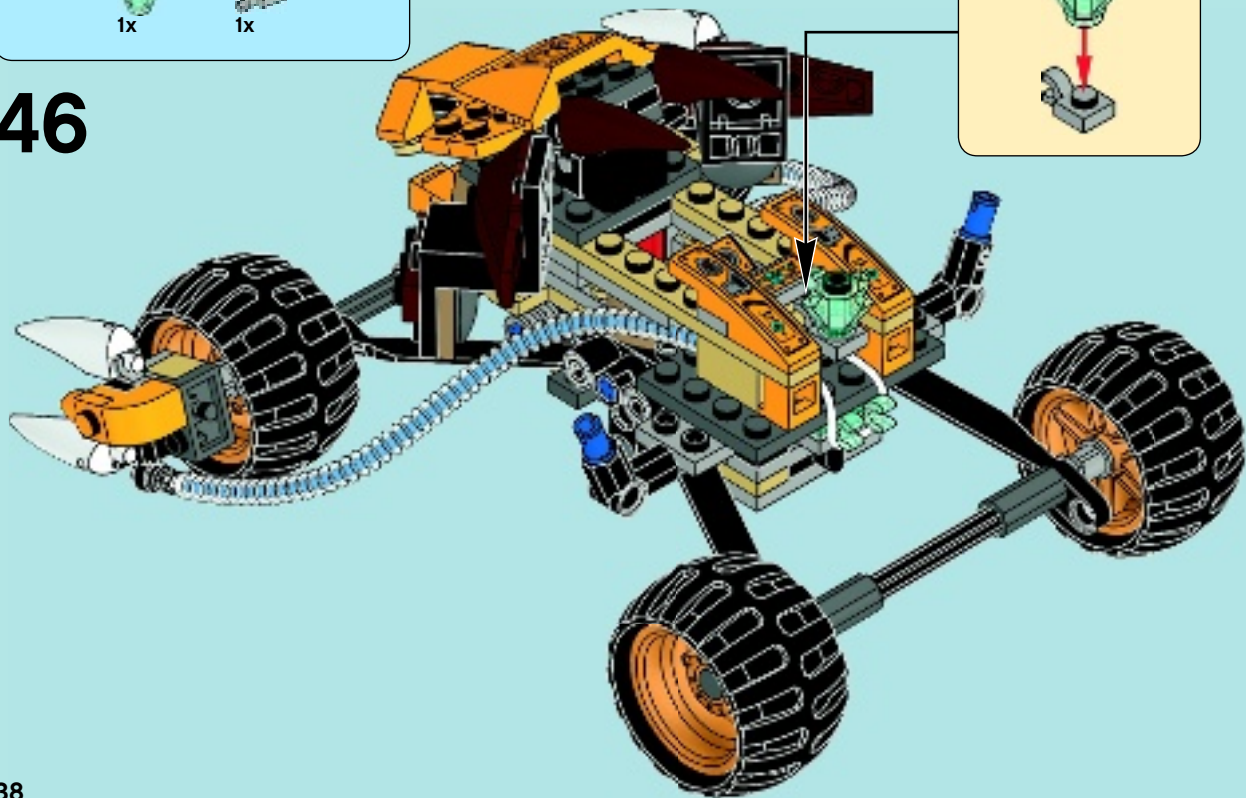
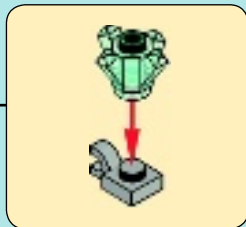



1x



1x



1x



1x



1x



1x

# 47

## 1

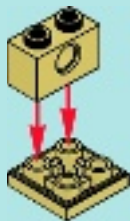

## 2

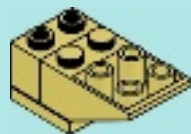

**3**



**4**

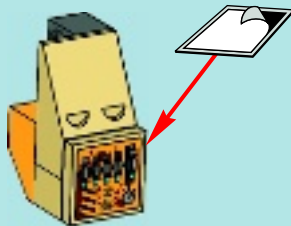
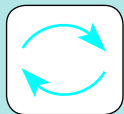

**5**

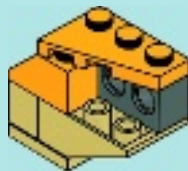
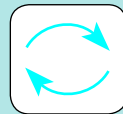

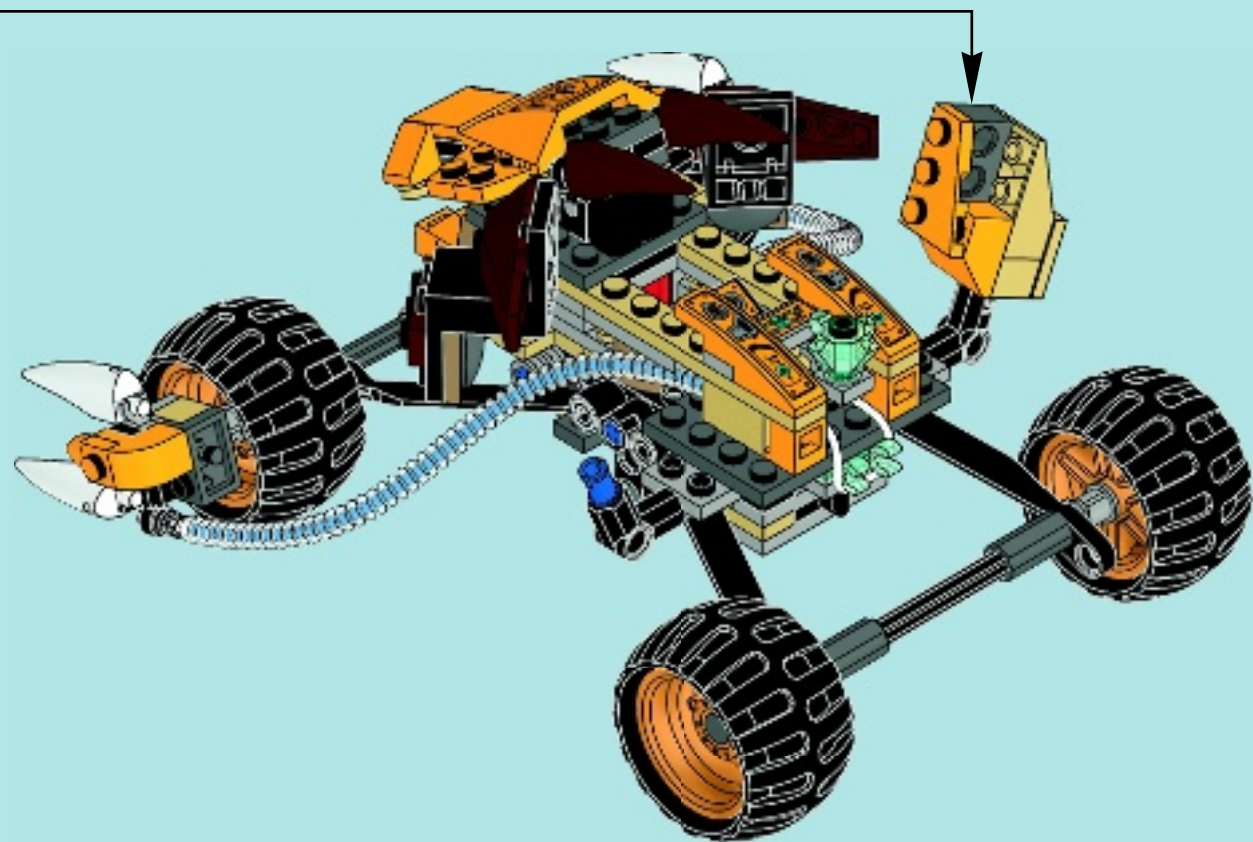



1x



1x



1x



1x



1x



1x

# 48

## 1

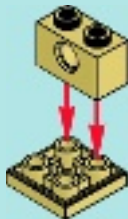

## 2





**3**



**4**

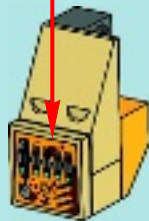
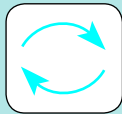

**5**

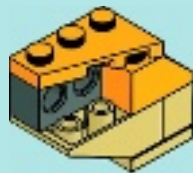
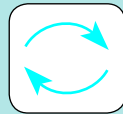

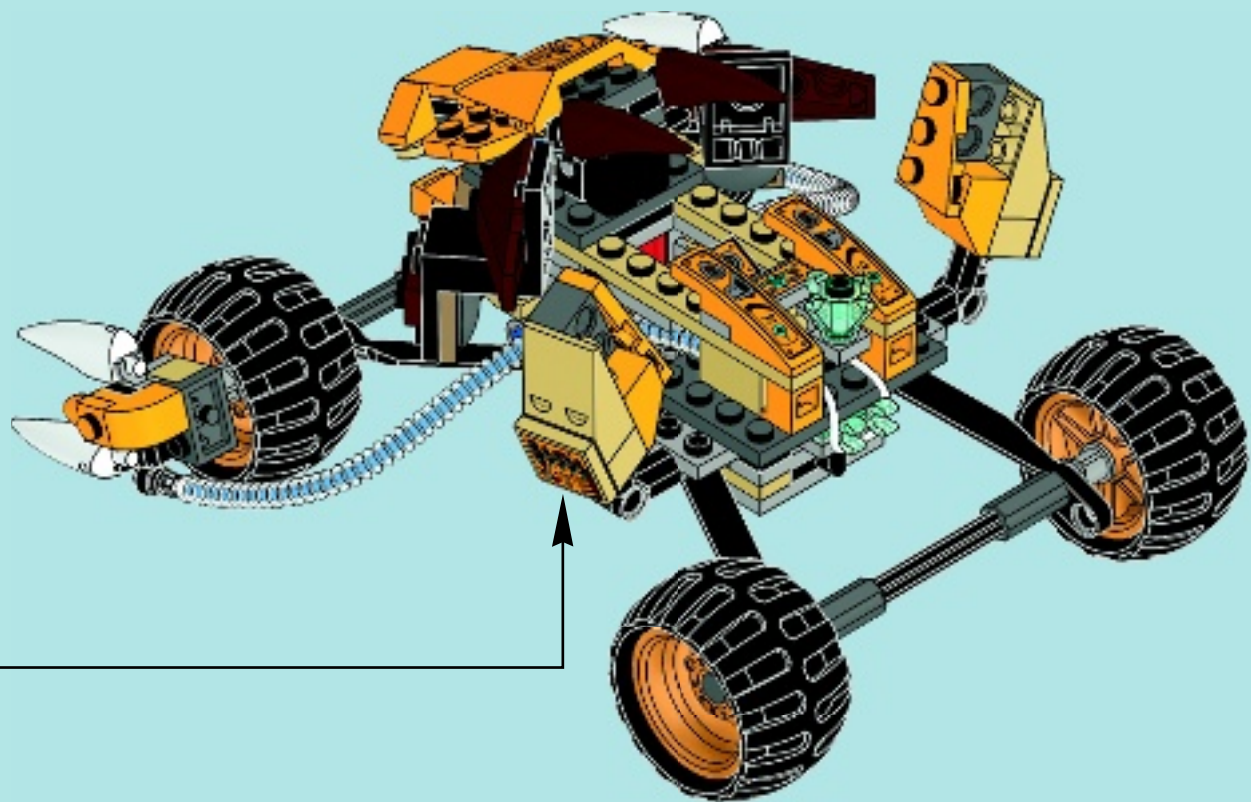

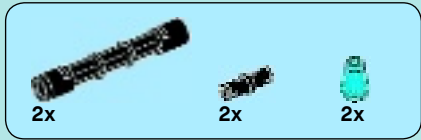

49



2x

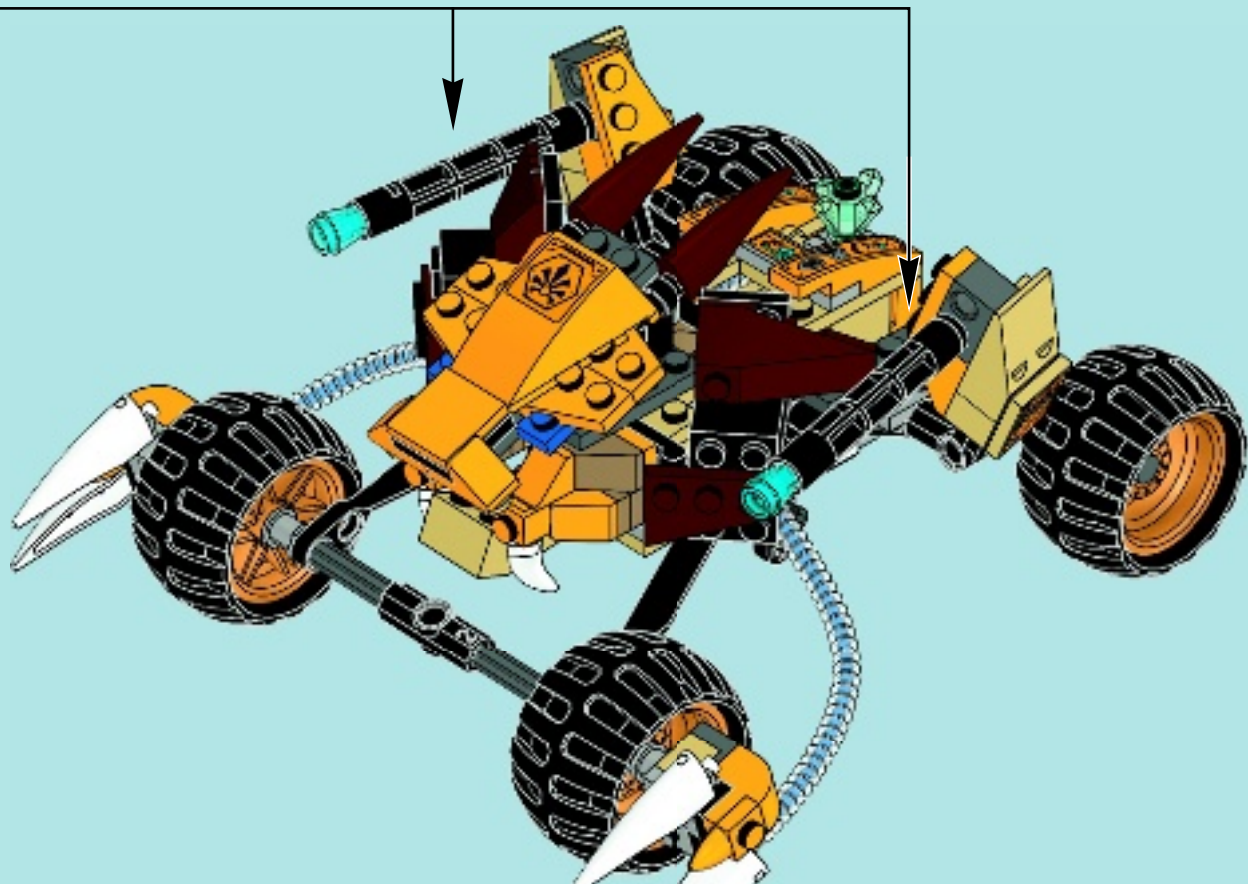



2x



2x

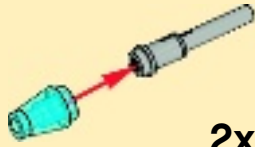

2x

50

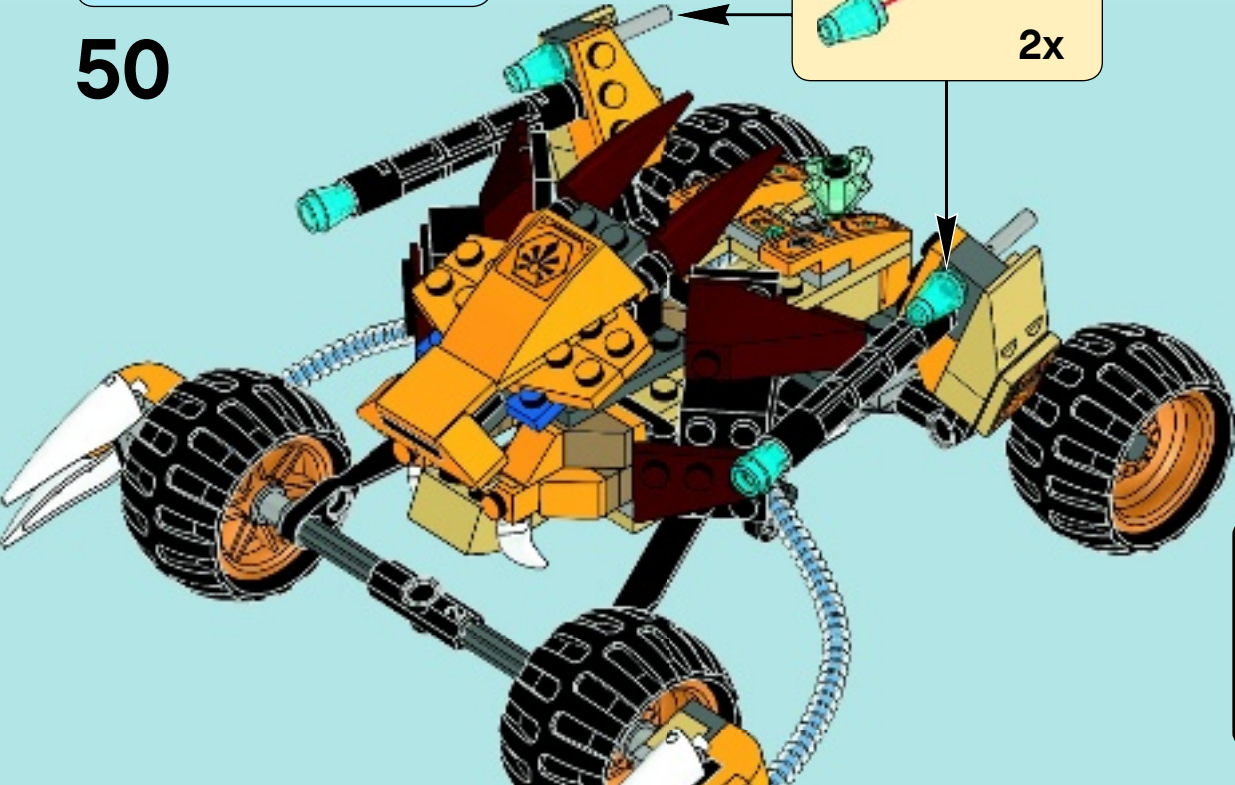



3x



3x

51

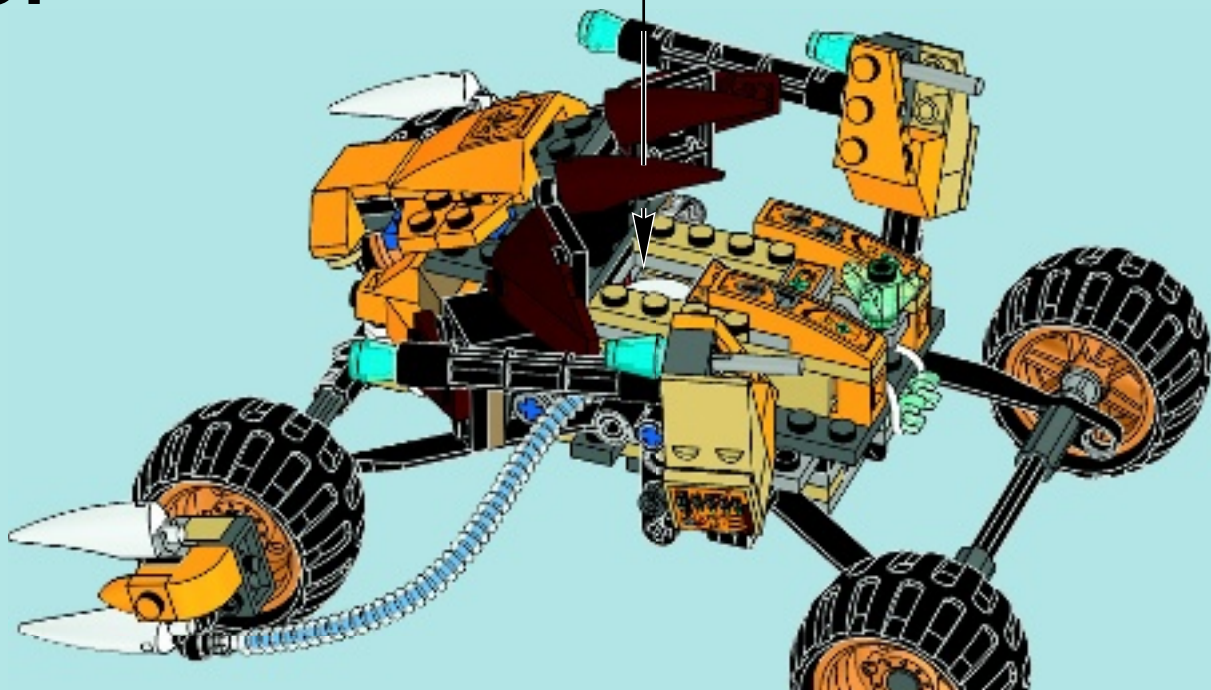

48



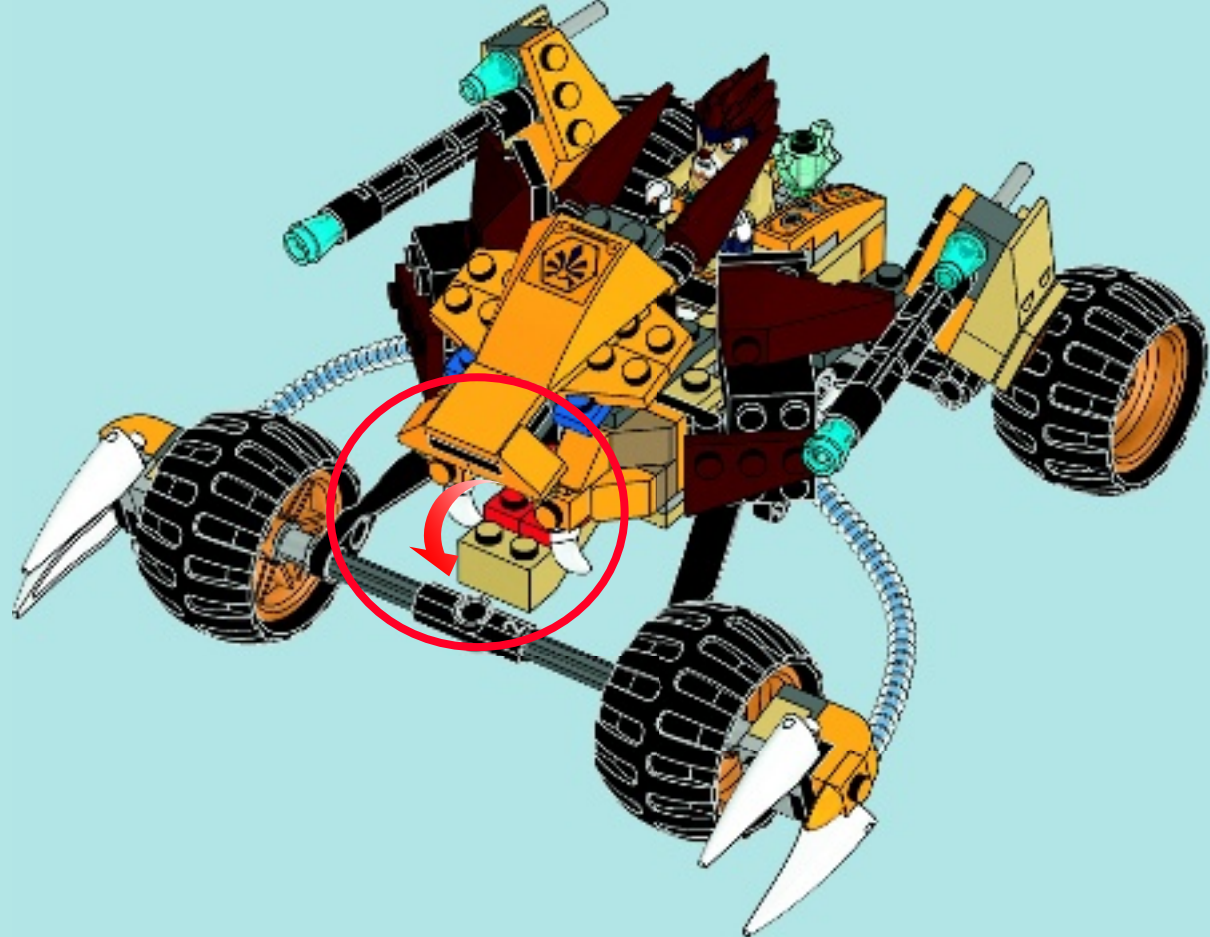

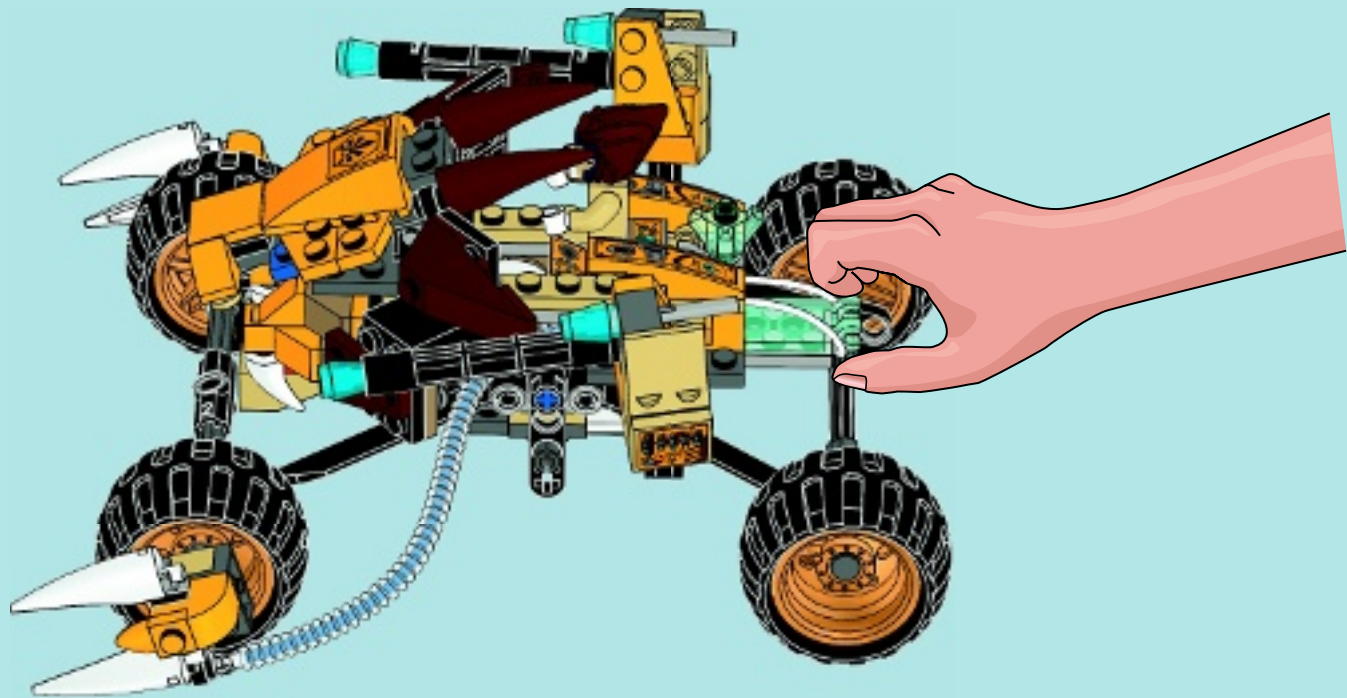



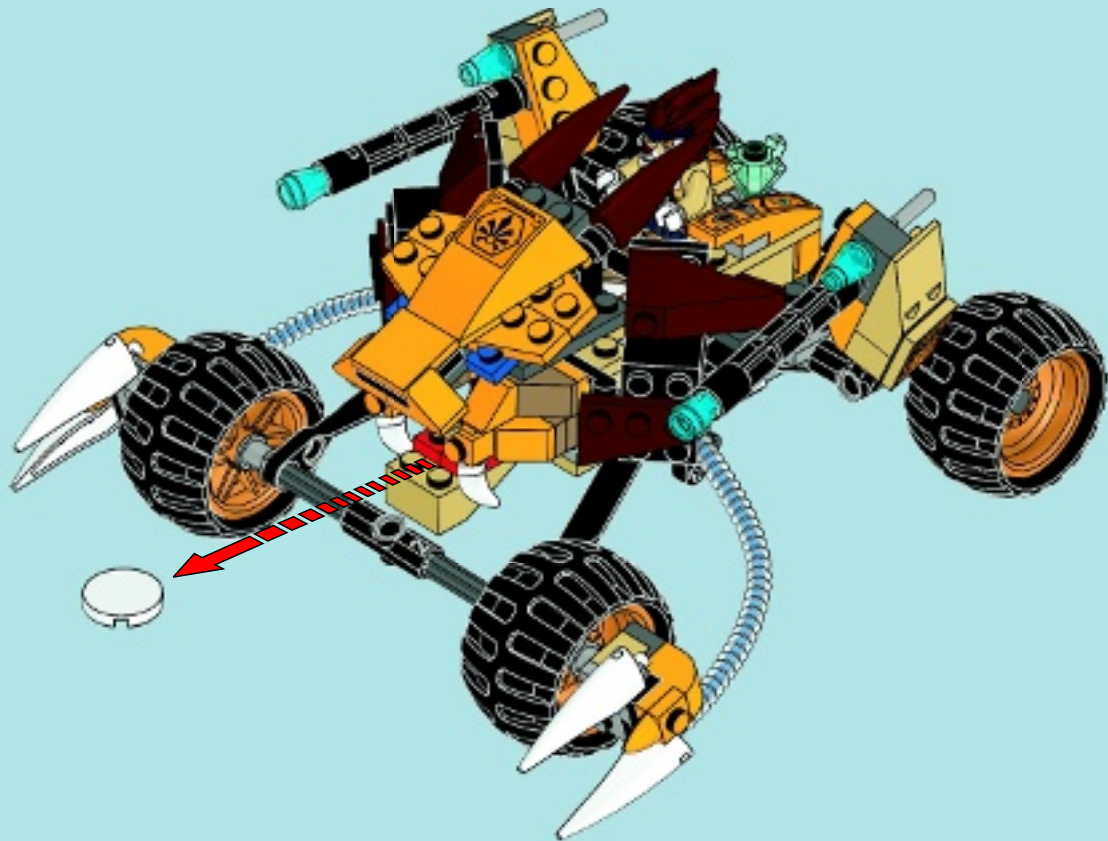



3x  
415001



1x  
663601



2x  
4566256



4x  
6015883



1x  
4544140



2x  
4117070



4x  
4205107



3x  
4500453



2x  
4114077



4x  
4114324



2x  
4278046



1x  
4217562



2x  
6013081



6x  
4161734



2x  
4124460



1x  
6021694



1x  
6022547



1x  
6021597



3x  
306921



2x  
4515365



2x  
362323



8x  
4206482



1x  
3005741



2x  
6012983



2x  
370226



2x  
4569733



3x  
4556158



4x  
4515368



2x  
4560182



1x  
4278359



1x  
393726



2x  
4155558



4x  
4518826



2x  
4598528



1x  
4548180



2x  
3022226



4x  
4632571



1x  
306226



2x  
4107136



4x  
4650636



1x  
4107783



8x  
4121715



2x  
4107084



1x  
370626



2x  
4614561



1x  
6019570



1x  
4603191



4x  
4567331



2x  
6001826



2x  
4530678



7x  
4528604



2x  
6020093



1x  
6020141



4x  
6020098



6x  
6020106



1x  
6020147



3x  
6020145



3x  
6020146



2x  
4282860



2x  
6020181



2x  
6023185



2x  
6003033



1x  
6022569



1x  
6023021



1x  
6023807



2x  
6021493



1x  
6020148



1x  
6020149



1x  
6021339



1x  
6021336



1x  
4211503



1x  
4211881



2x  
4520320



4x  
4211573



6x  
4211622



3x  
4599498



6x  
4211395



3x  
4541978



4x  
4654582



2x  
4211376



4x  
4211429



1x  
4213574



2x  
4210762



1x  
4211043



1x  
4211056



1x  
4243831



1x  
4211002



1x  
4211115



2x  
6000606



2x  
4278274



1x  
4211051



1x  
4509884



2x  
4516546



2x  
4560177



2x  
4499858



4x  
4648531



1x  
4519970



1x  
6028350



1x  
6028340



1x  
6002841



**Customer Service**

**Kundenservice**

**Service Consommateurs**

**Servicio Al Consumidor**

**LEGO.com/service or dial**



**: 00800 5346 5555**

**: 1-800-422-5346**



LEGENDS OF  
**CHIMA**

**WATCH THE VIDEO  
REGARDE LA VIDEO  
MIRA EL VIDEO**

**SCAN THE QR CODE  
SCANNEZ LE CODE QR  
CAPTURA EL CÓDIGO QR**



**LEGO.COM/CHIMA**



LEGO

# LEGO CHIMA



70006



LENNOX CRAEGER



70000



70001



70006



70005



70004



70003



70002

 [LEGO.com/chima](http://LEGO.com/chima)



# LEGO CHIMA

# SPEEDORZ



70115



70115



WATCH THE MODEL IN ACTION  
REGARDEZ LE MODÈLE EN ACTION  
MIRA EL MODELO EN ACCIÓN



70100



70103



70102



70113





LEGO

LEGO CHIMA



LEGO.COM/CHIMA



LEGOLAND  
**CHIMA 4D**



**EXCLUSIVELY  
AT LEGOLAND  
- THE 4D CHIMA  
EXPERIENCE**

FIND OUT MORE AND GET SPECIAL OFFERS AT  
[LEGOLAND-CHIMA.COM](http://LEGOLAND-CHIMA.COM)



**EN EXCLUSIVITÉ  
À LEGOLAND  
- L'EXPERIENCE  
CHIMA EN 4D**

OBTENEZ PLUS D'INFORMATIONS ET DES  
OFFRES SPECIALES SUR  
[LEGOLAND-CHIMA.COM](http://LEGOLAND-CHIMA.COM)



**SÓLO EN LEGOLAND:  
LA EXPERIENCIA  
CHIMA 4D**

MÁS INFORMACIÓN Y OFERTAS ESPECIALES EN  
[LEGOLAND-CHIMA.COM](http://LEGOLAND-CHIMA.COM)



**NEW  
NOUVEAU  
NUEVO**



**LEGOLAND**  
DISCOVERY CENTERS



**LEGOLAND**  
PARKS





3

[www.LEGOclub.com/Max](http://www.LEGOclub.com/Max)

**LEGO** club™

**FREE\*! GRATIS! GRATUIT!**

\*Paid subscription in Australia and New Zealand.  
\*Abonnement payant en Australie et Nouvelle-Zélande.

©2013 The LEGO Group.





# WIN!

Go to [www.LEGOsurvey.com/product](http://www.LEGOsurvey.com/product) to fill out a survey for a chance to win a cool LEGO® Product.

No purchase necessary.

Open to all residents where not prohibited.



## [www.LEGOsurvey.com/product](http://www.LEGOsurvey.com/product)

### GEWINNE!

Nimm an der Umfrage auf [www.LEGOsurvey.com/product](http://www.LEGOsurvey.com/product) teil und hab die Chance ein cooles LEGO® Produkt zu gewinnen!

Die Teilnahme am Gewinnspiel führt zu keinerlei Kaufverpflichtungen. Teilnahme in allen nicht ausgeschlossenen Ländern möglich.

### WIN!

Ga naar [www.LEGOsurvey.com/product](http://www.LEGOsurvey.com/product), vul een enquêteformulier in en maak kans op een cool LEGO® product.

Geen aankoopverplichting. Iedereen mag deelnemen, uitgezonderd ingezetenden van landen waar een enquêteverbod geldt.

### GAGNE!

Visite [www.LEGOsurvey.com/product](http://www.LEGOsurvey.com/product) pour répondre à un questionnaire et avoir une chance de gagner un produit LEGO® très cool!

Aucune obligation d'achat. Ouvert à tous les résidents des pays autorisés.

### 当てよう!

[www.LEGOsurvey.com/product](http://www.LEGOsurvey.com/product) にアクセスして、アンケートにご記入ください。当選者にはレゴ®製品を差し上げます。

お買い上げの必要はありません。禁止されていない限り、すべての皆様にご利用いただけます。



LEGO.com

6047604

LEGO and the LEGO logo are trademarks of the/son des marques de commerce de/son marcas registradas de LEGO Group. ©2013 The LEGO Group.