



LEGENDS OF
CHIMA



70002





32

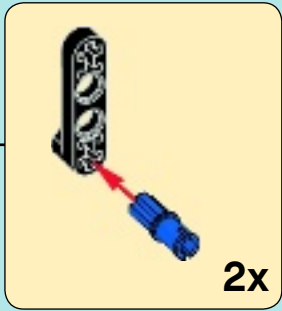
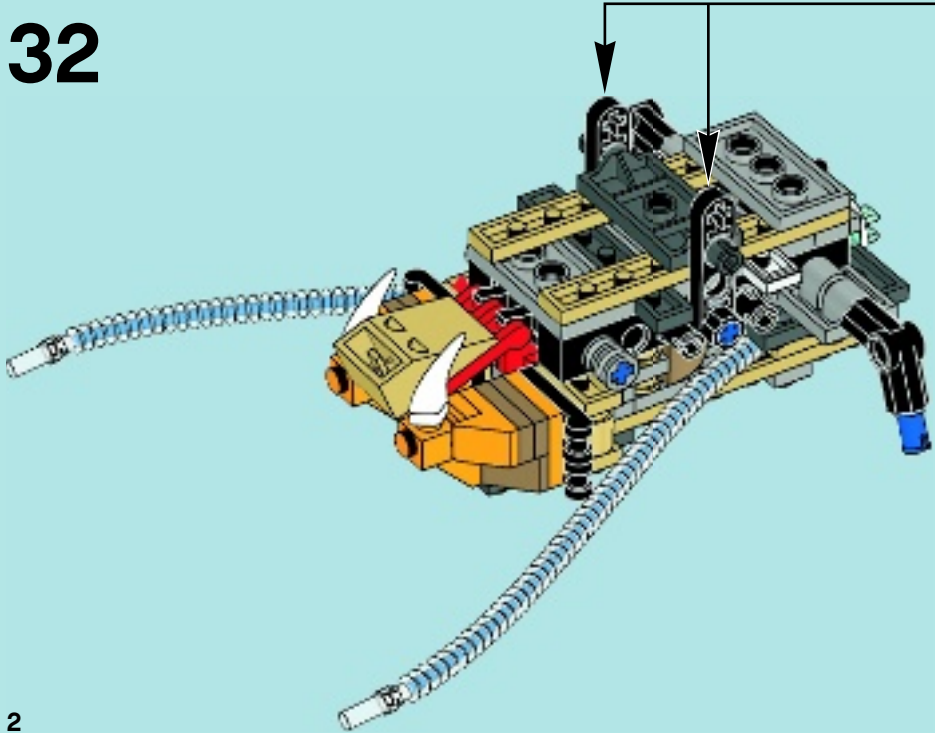



33

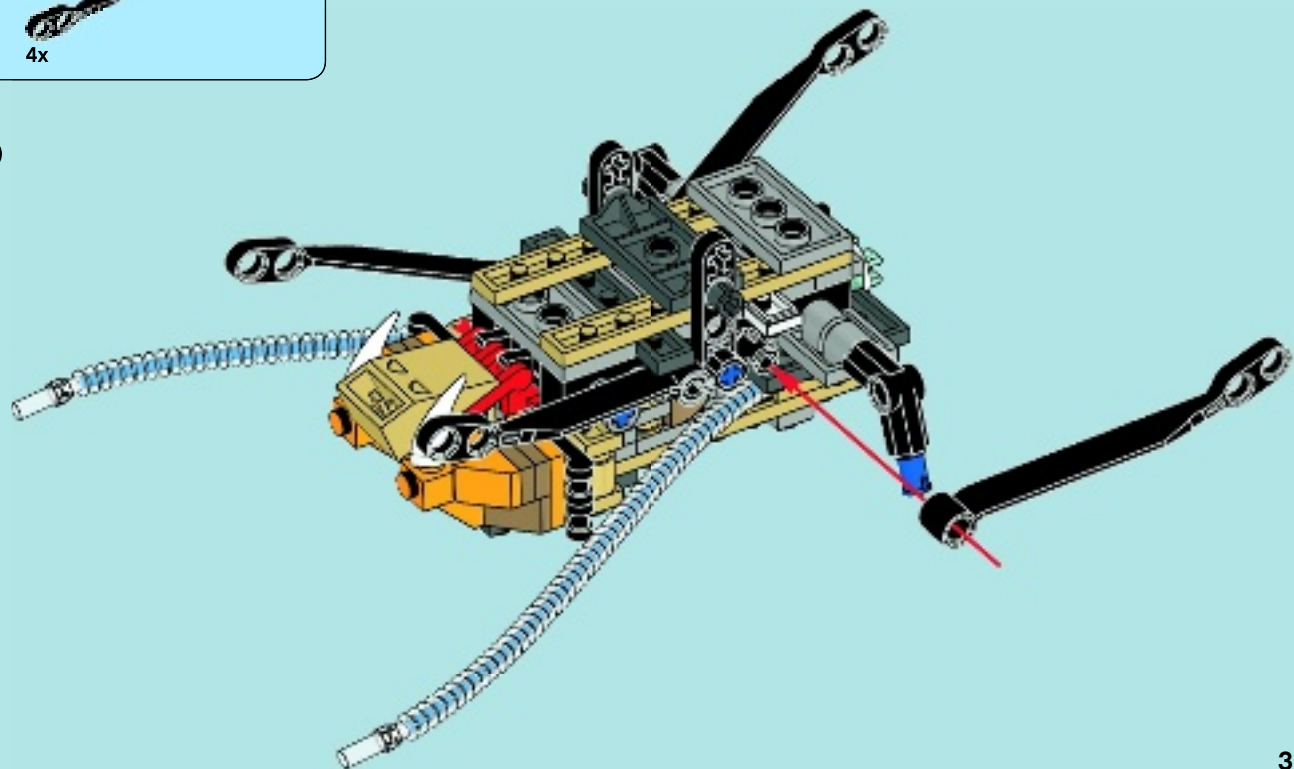

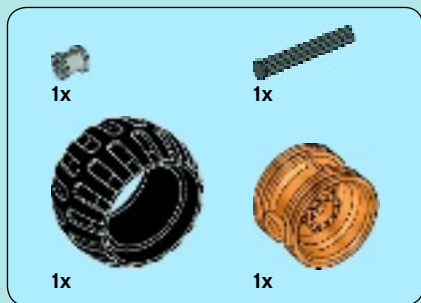

34

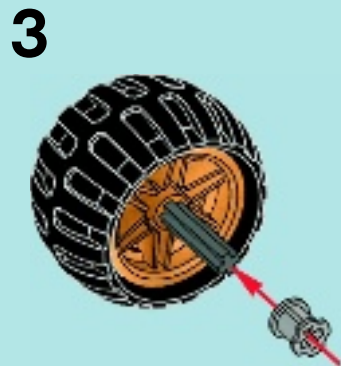
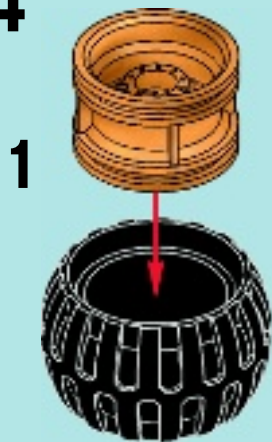

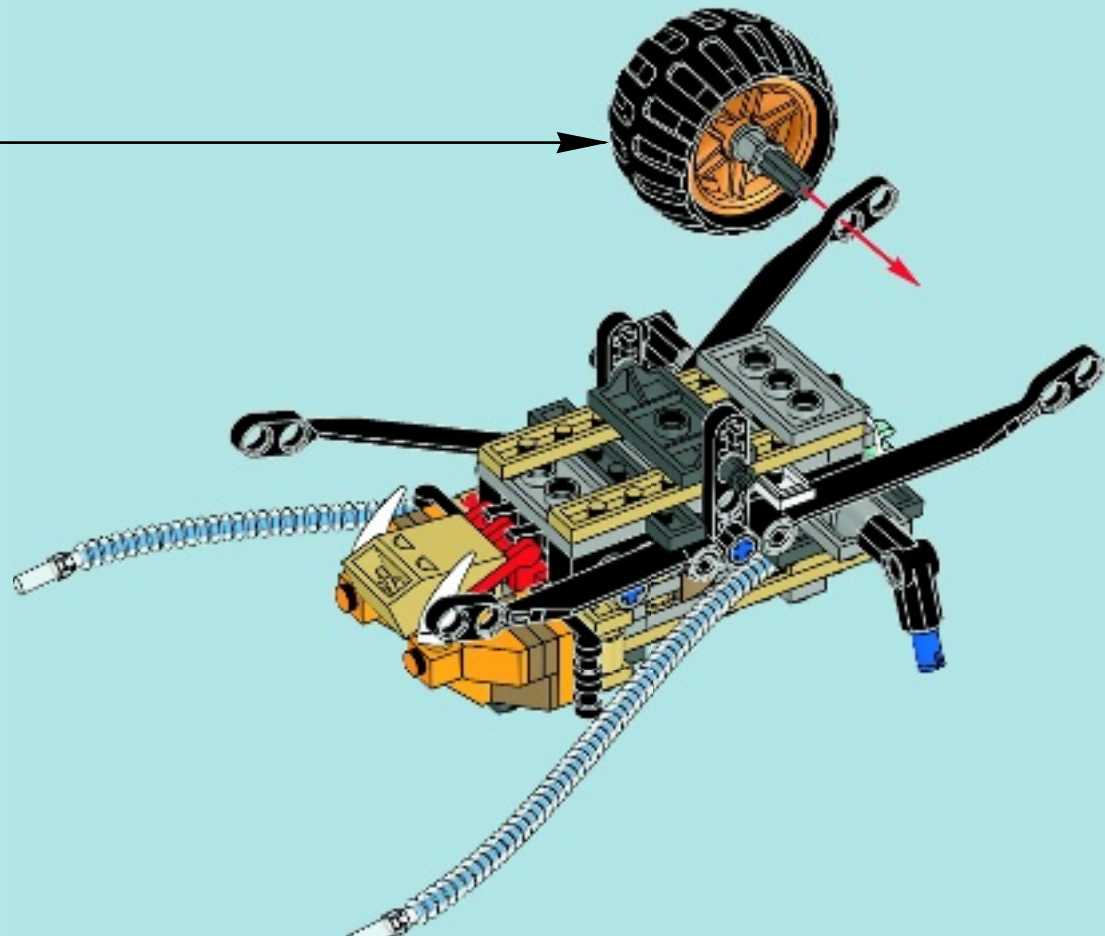

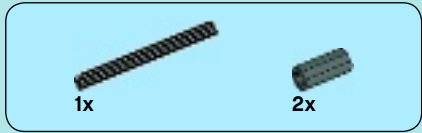

35

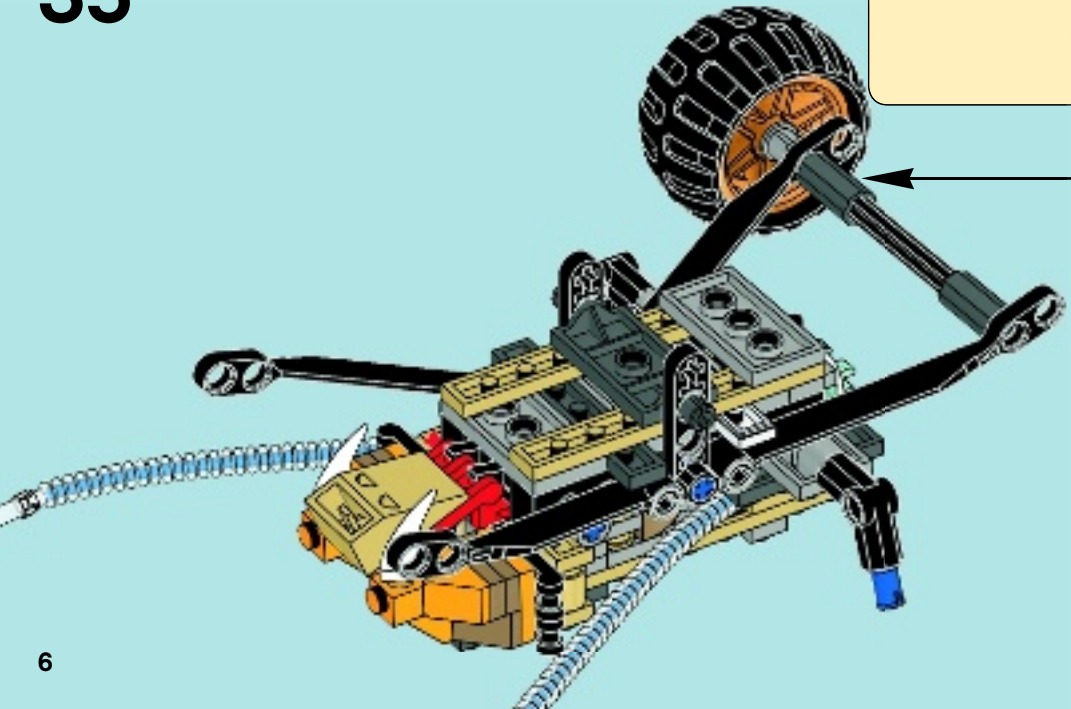
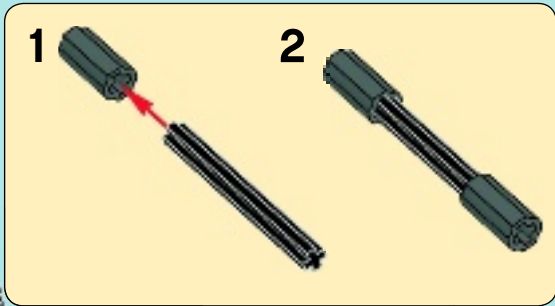

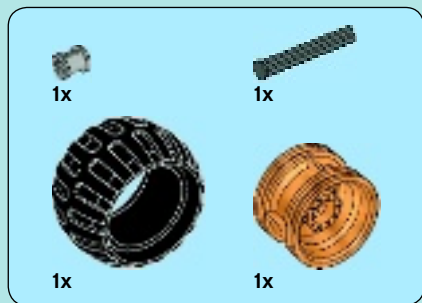

36

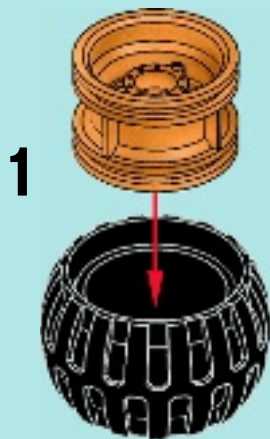

2



3

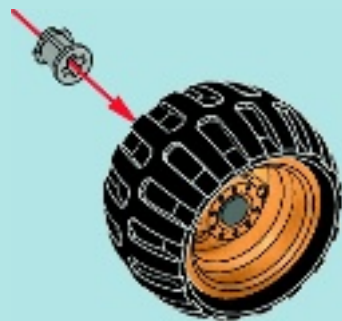

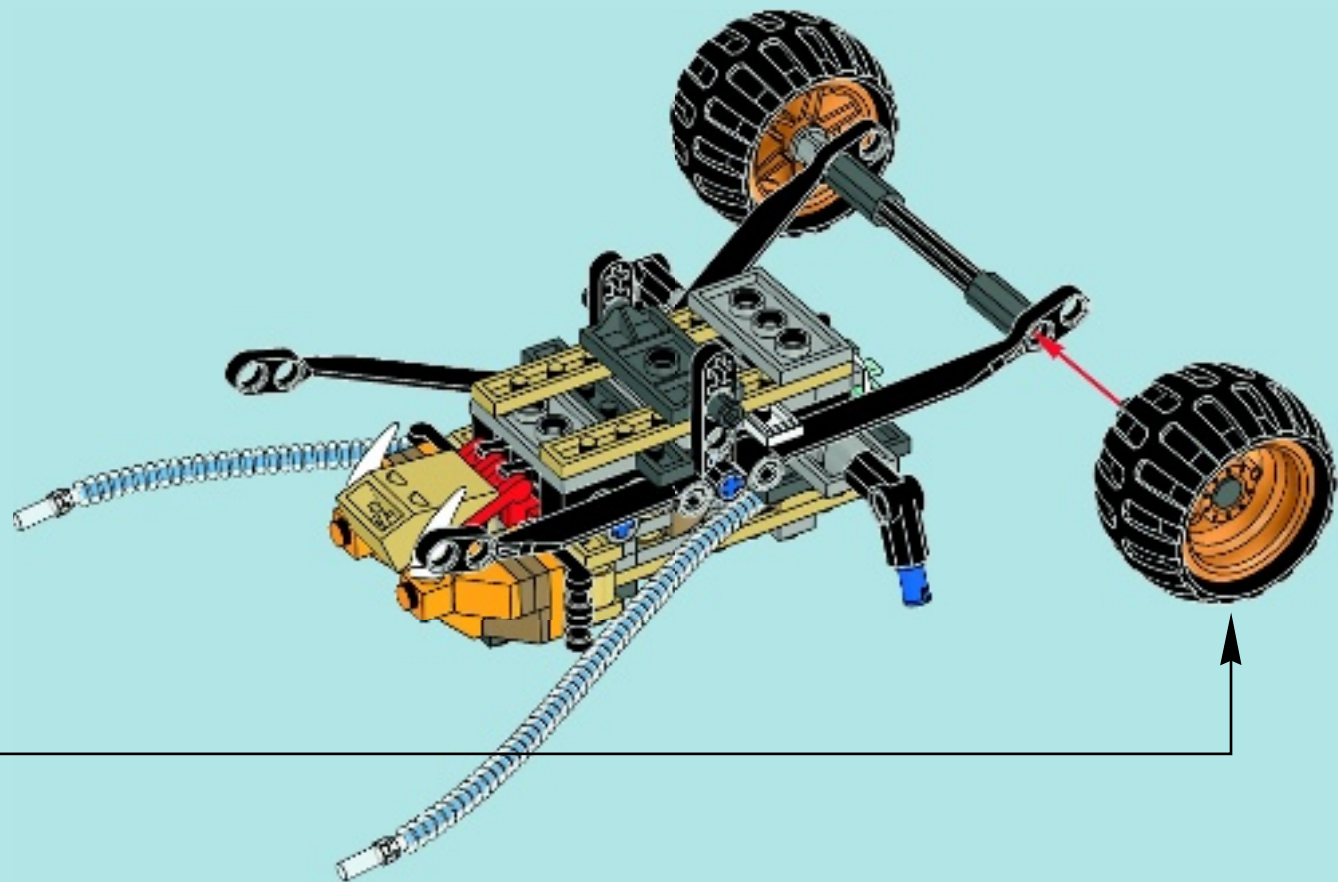

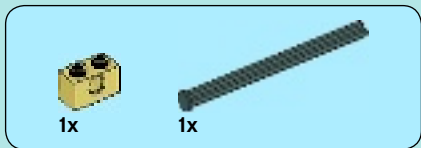

1

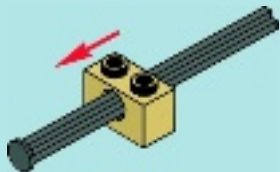

2

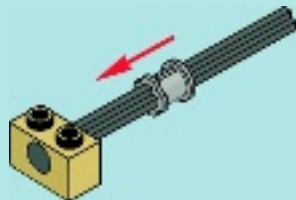



1x



1x

3

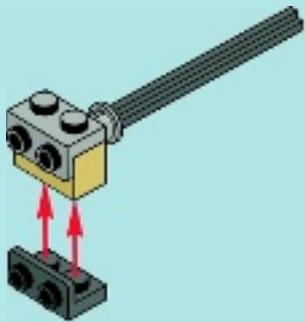

1x



1x

4

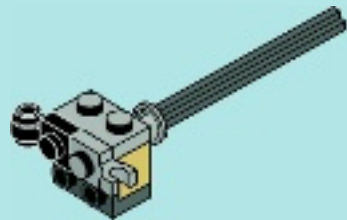



1x

5

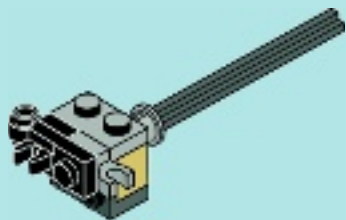

1x



1x

6

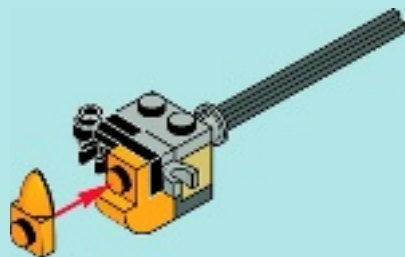



7

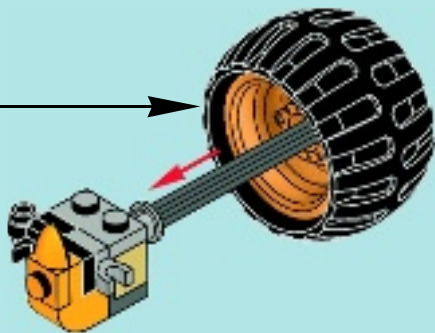
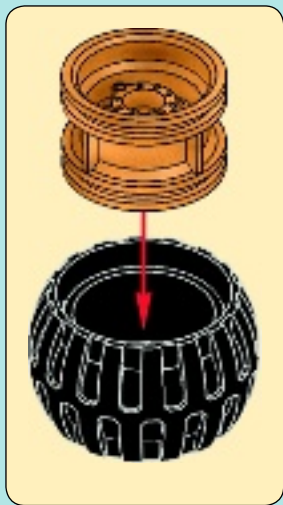



1x

8

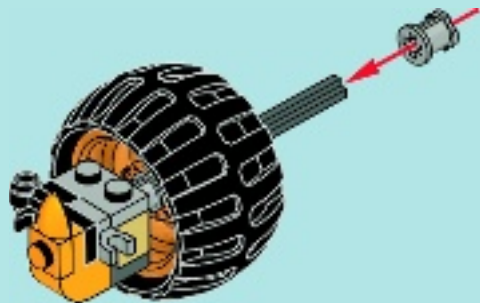

2x

9



37

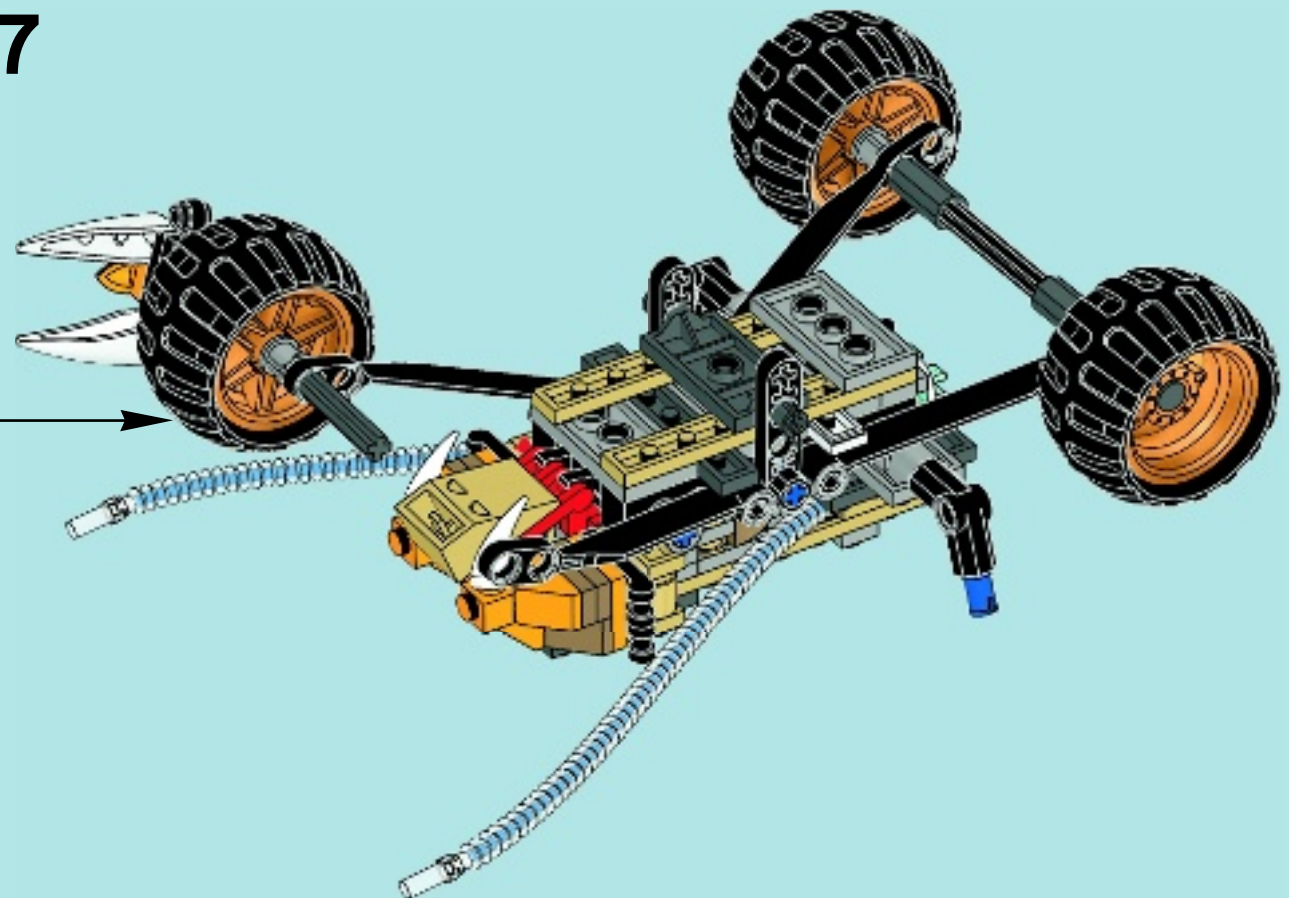



1x

38

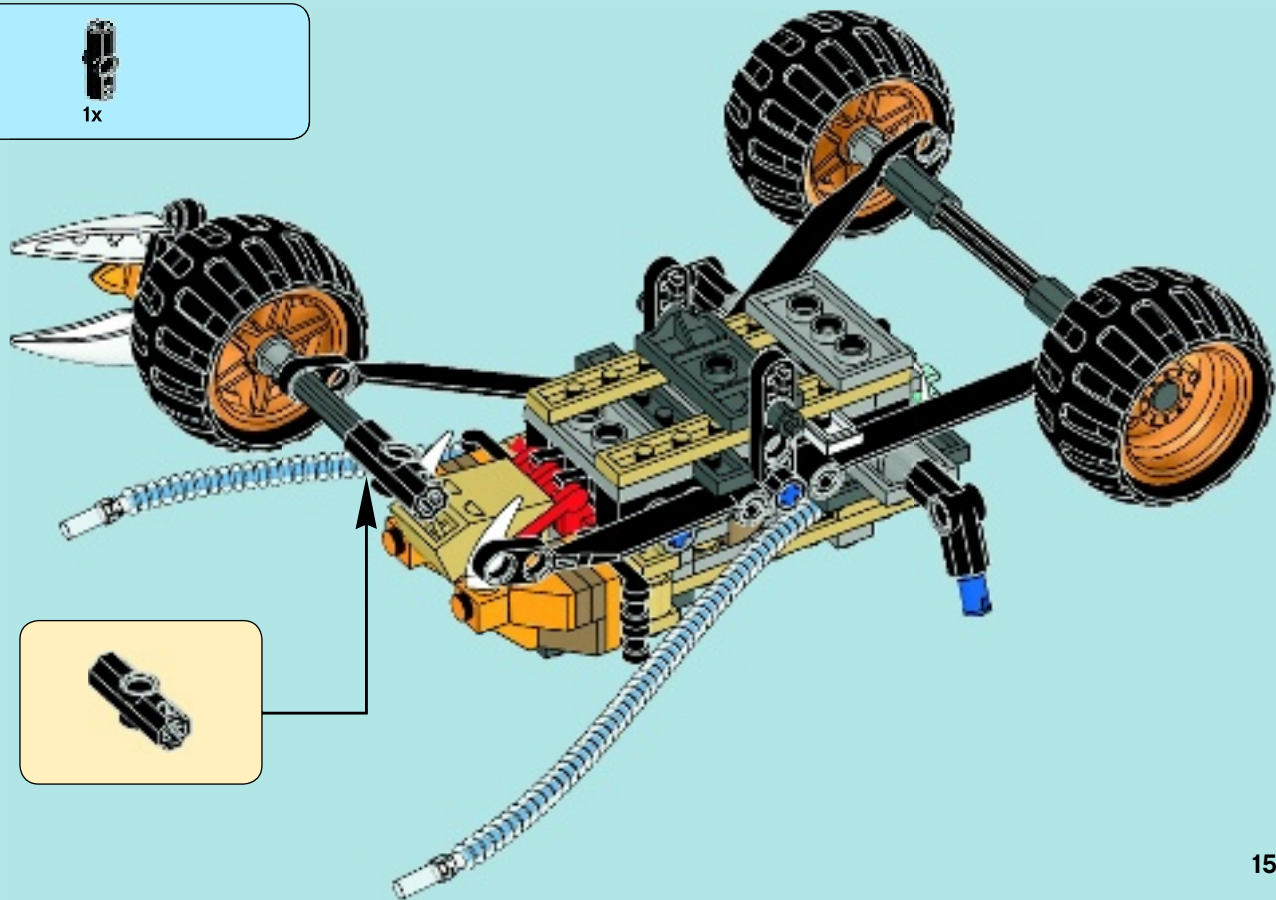

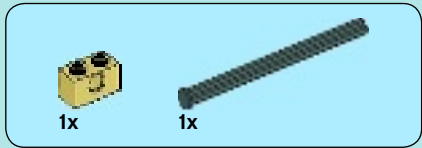

1

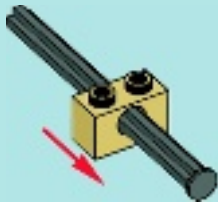

2





1x



1x

3

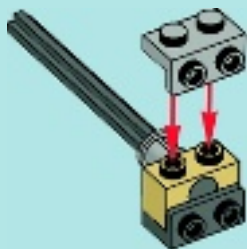

1x



1x

4





1x

5

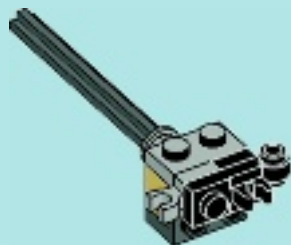

1x



1x

6





7

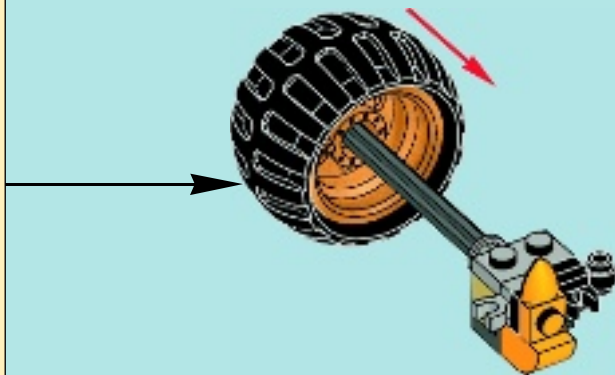
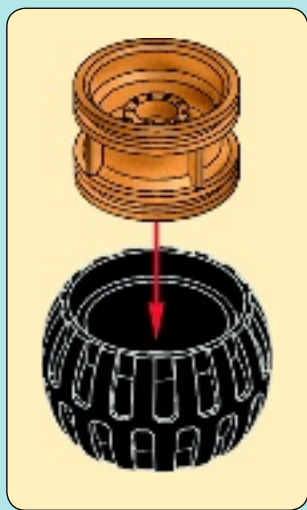



1x

8

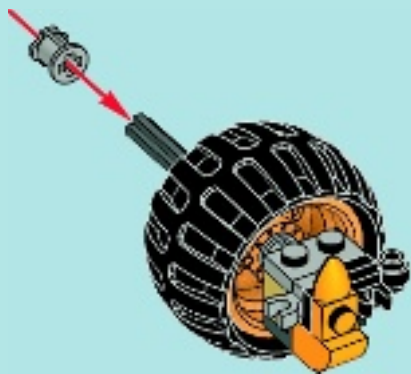

2x

9



39

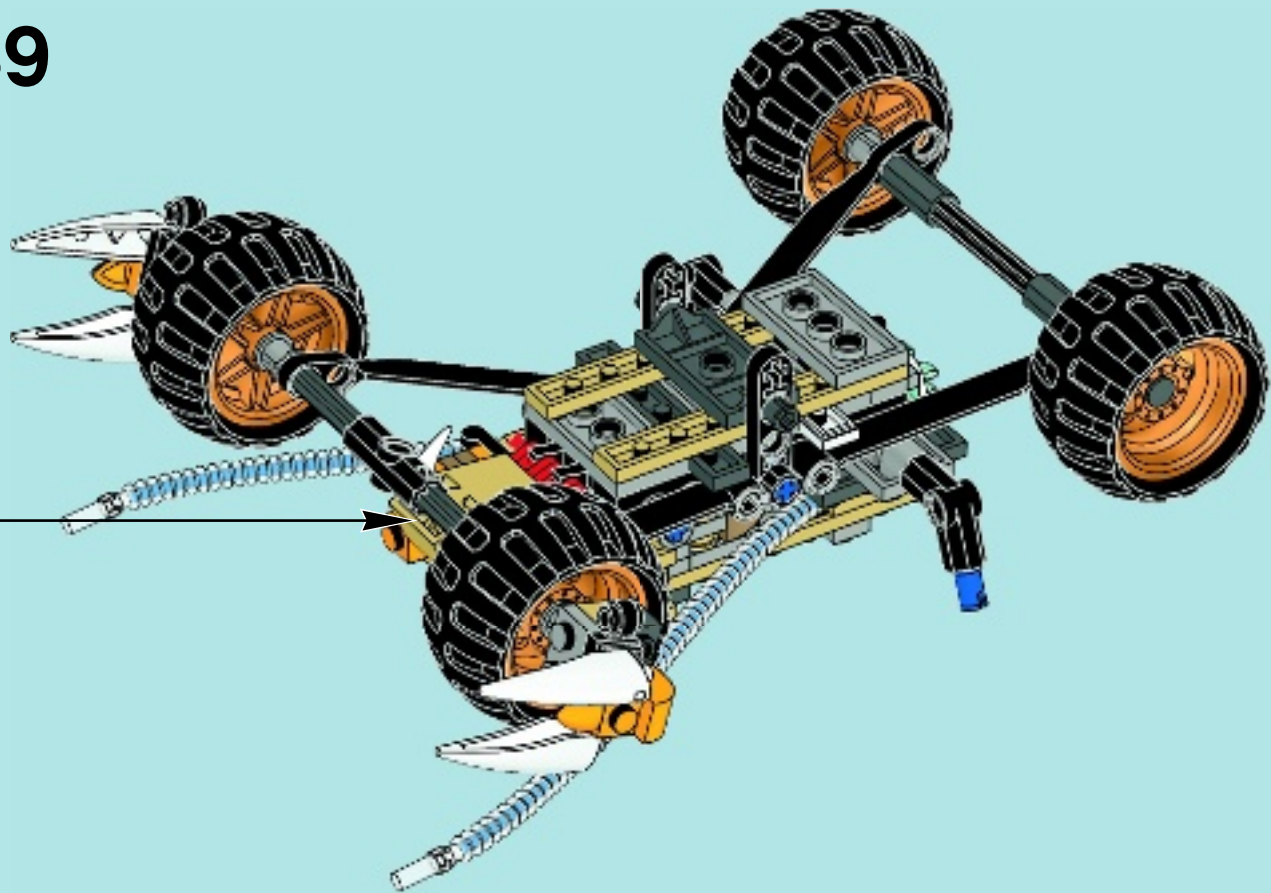

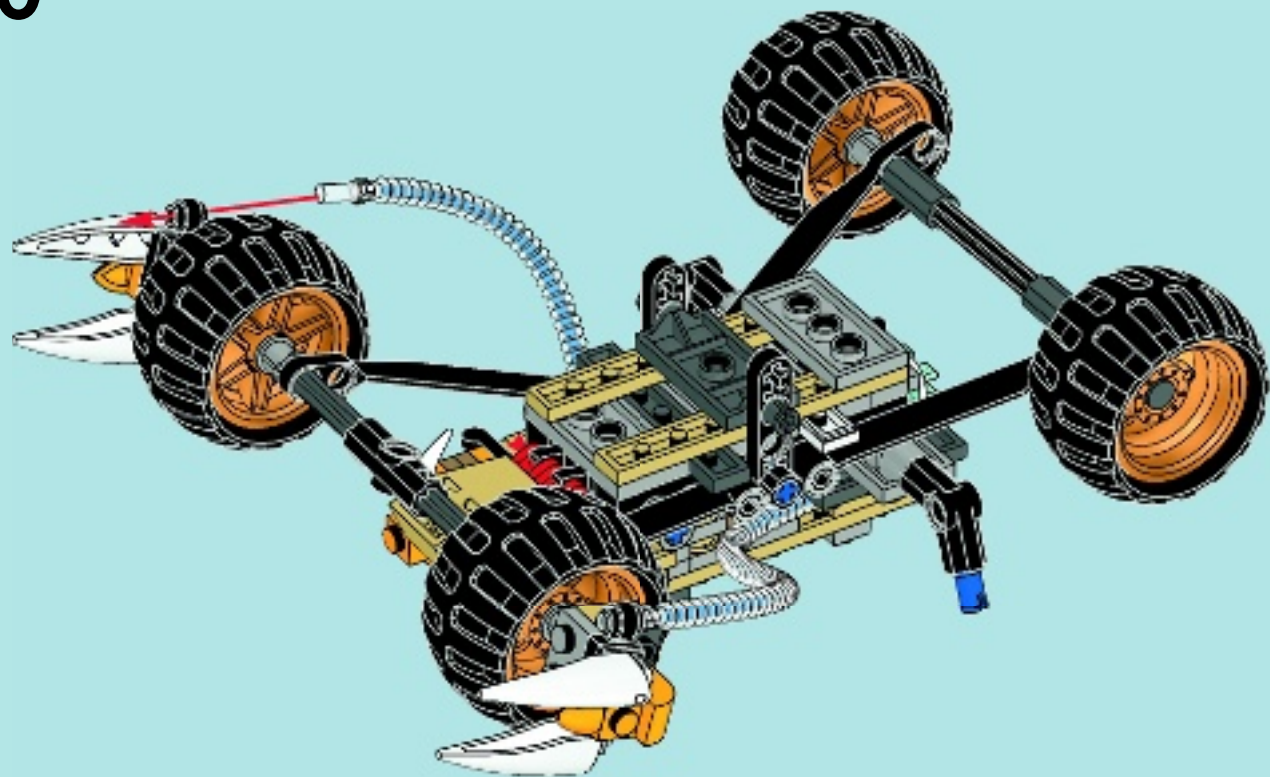



1x



2x

41

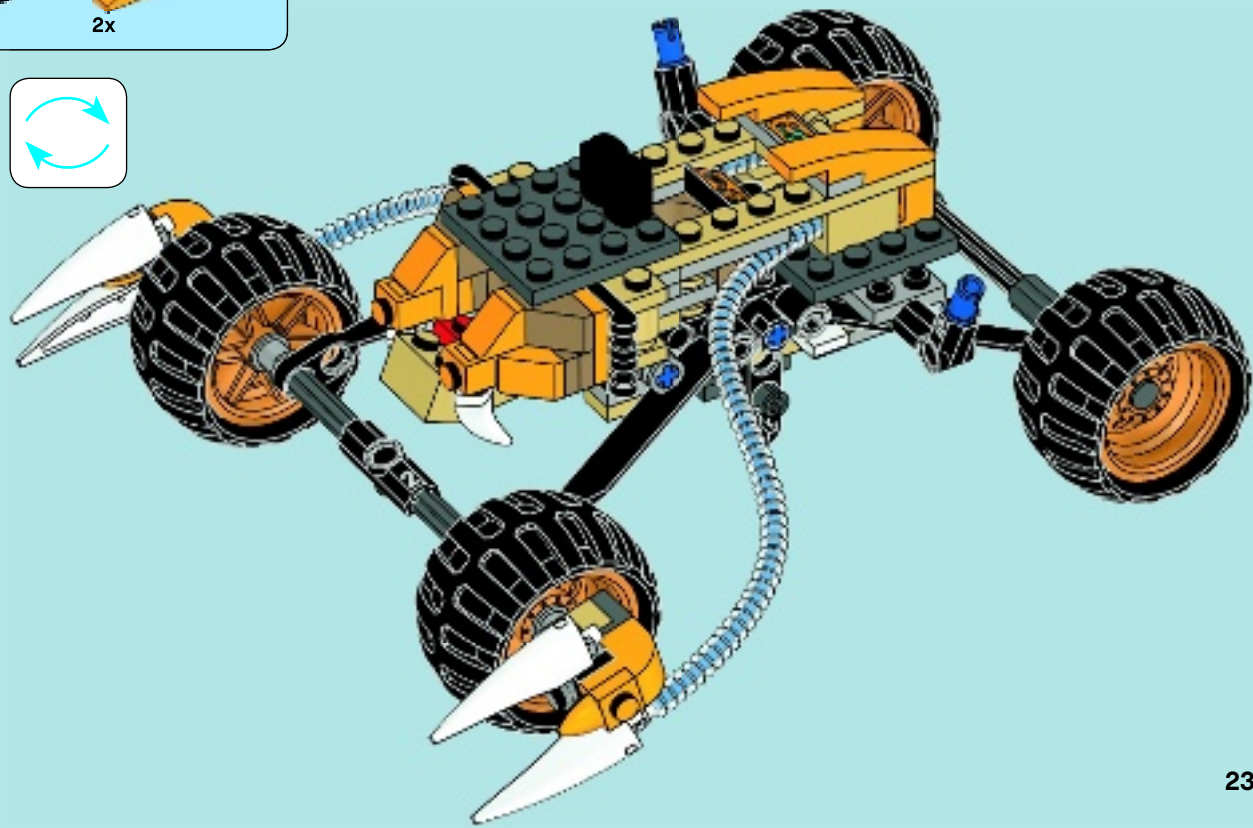
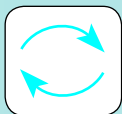

42

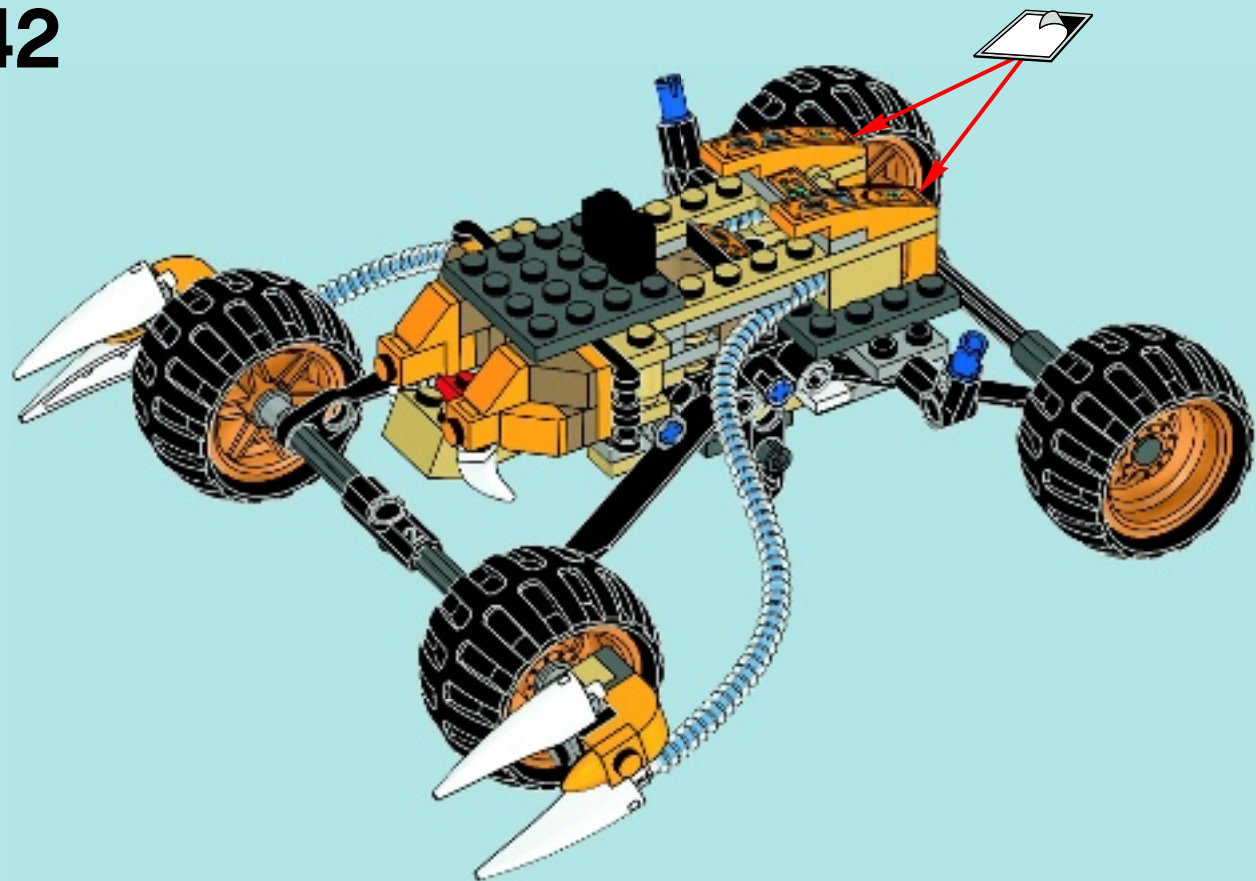

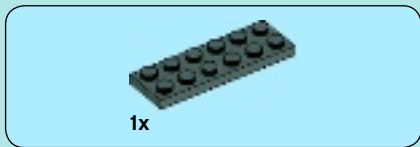

1

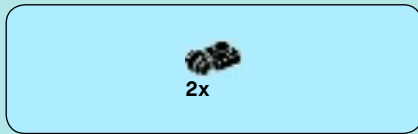
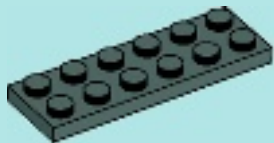

2





3



4





1x



1x

5



2x

6

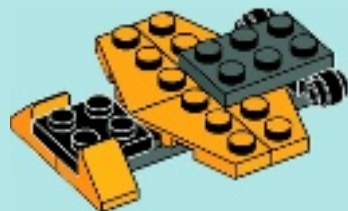



1x

7



1x

8

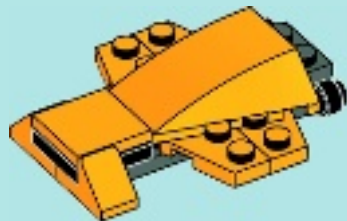



2x



1x



1x

9

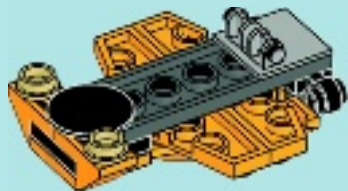
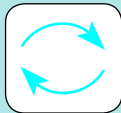



2x



1x

10

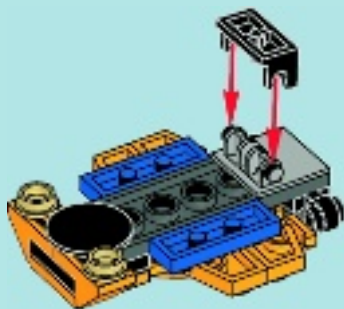

30



2x

11

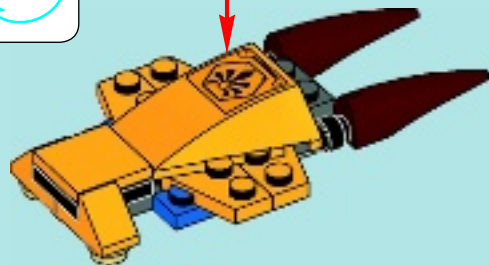
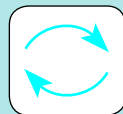

43

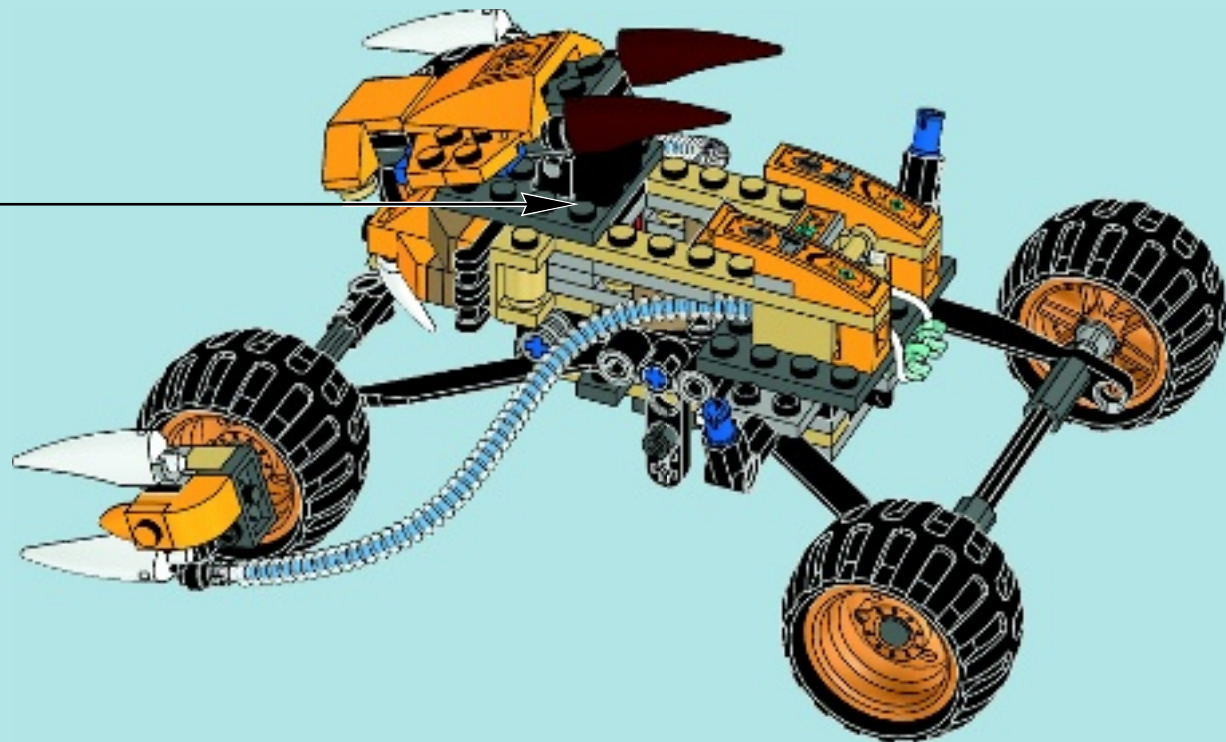

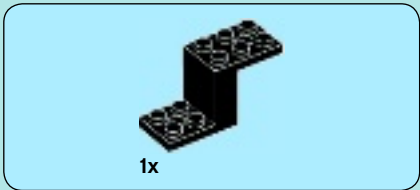

1



2

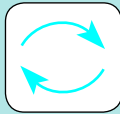



1x

3



1x



1x

4

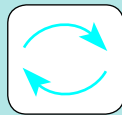

44

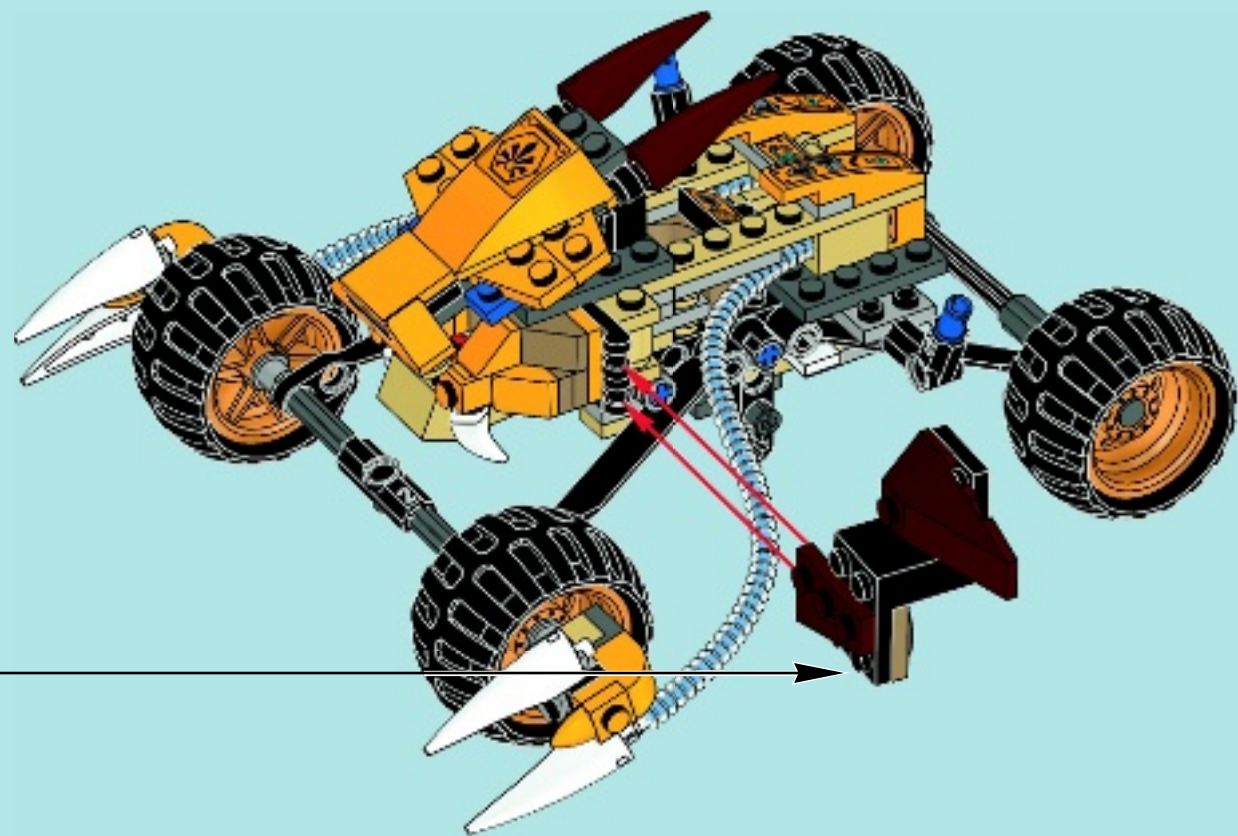



1x

1

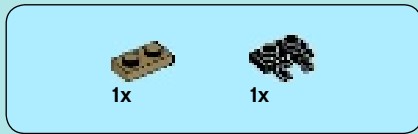

1x

1x

2

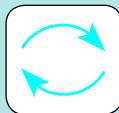



1x

3



1x



1x

4

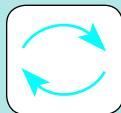

45

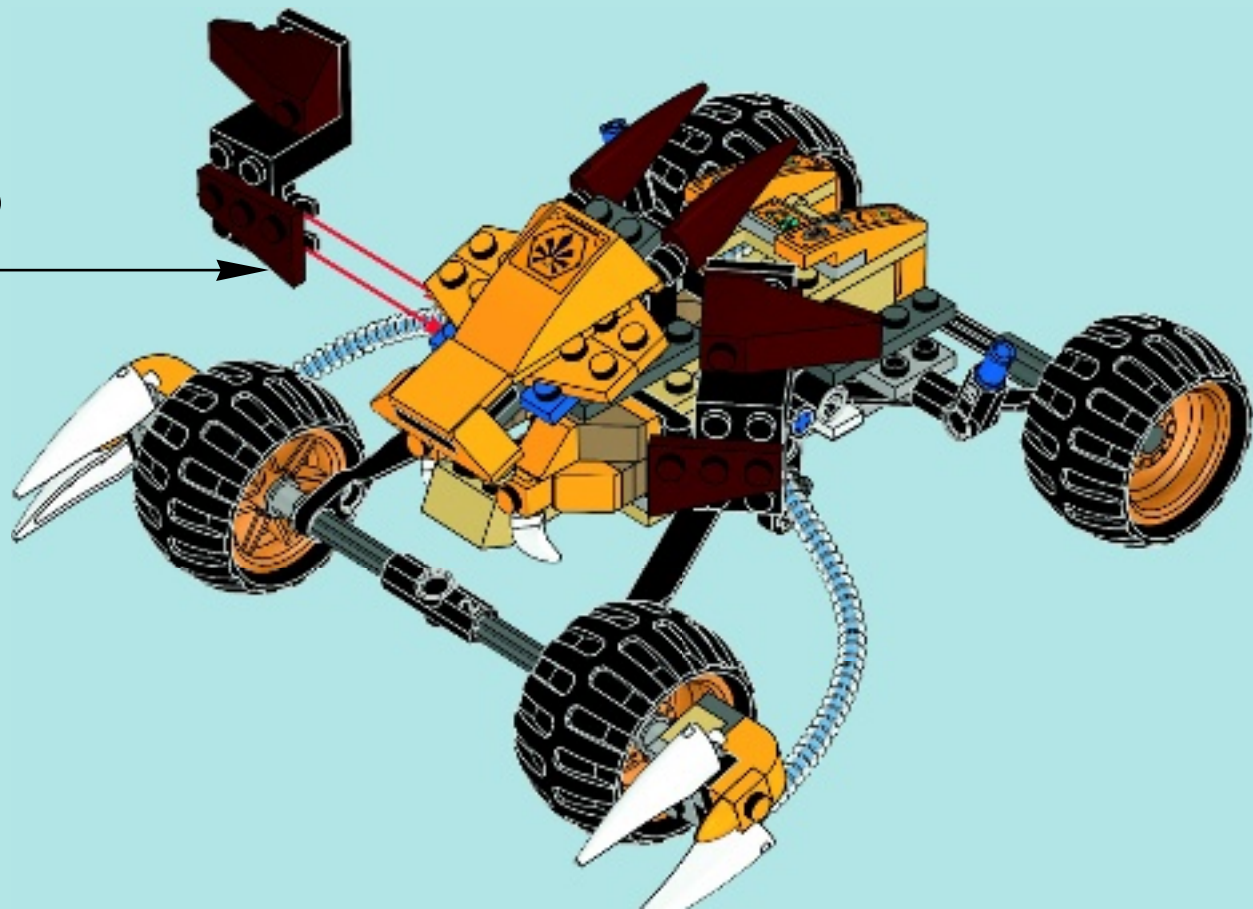



1x



1x

46

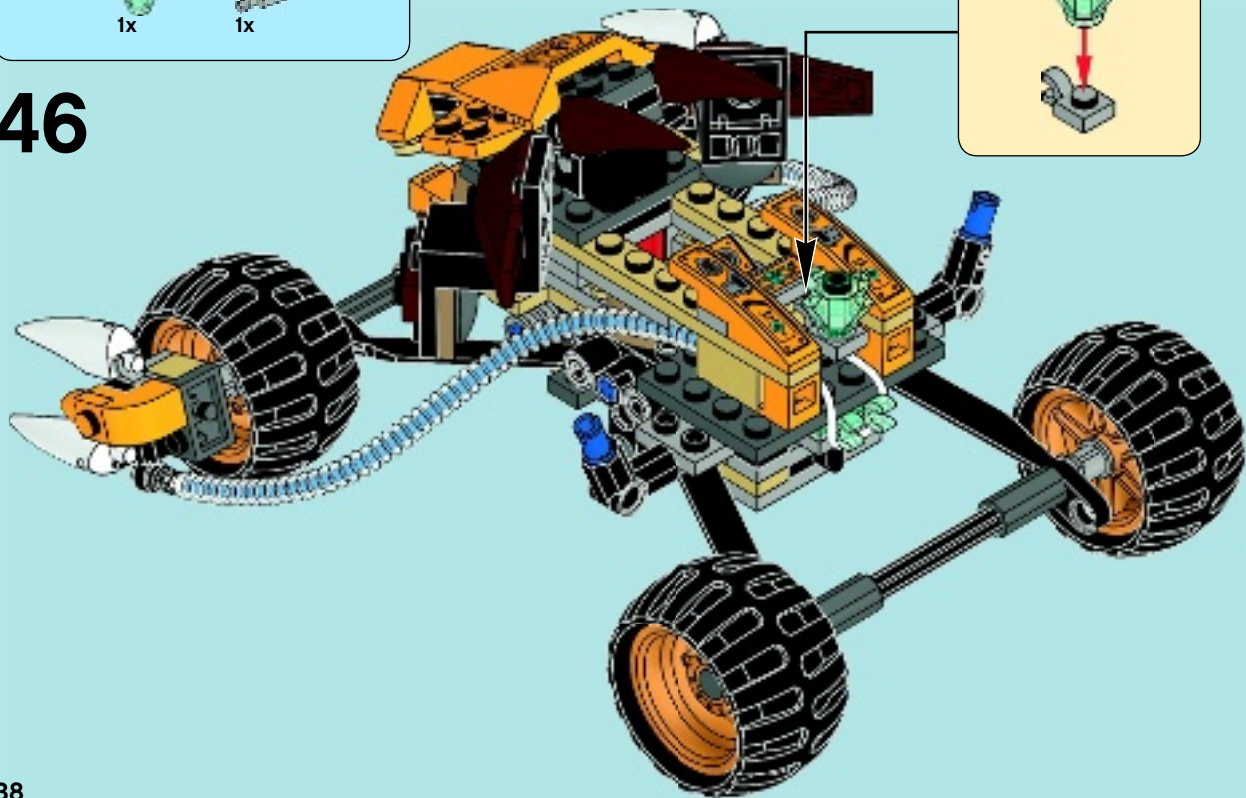
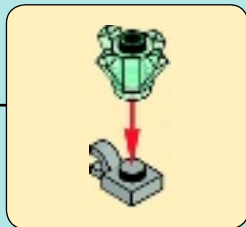



1x



1x



1x



1x



1x



1x

47

1

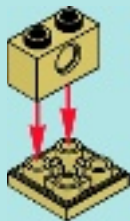

2



3



4

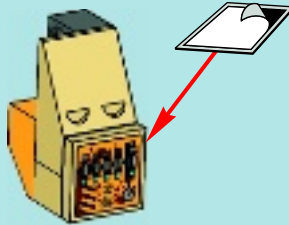
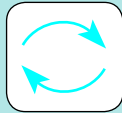

5

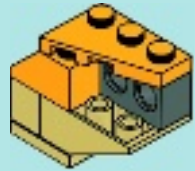
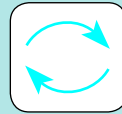

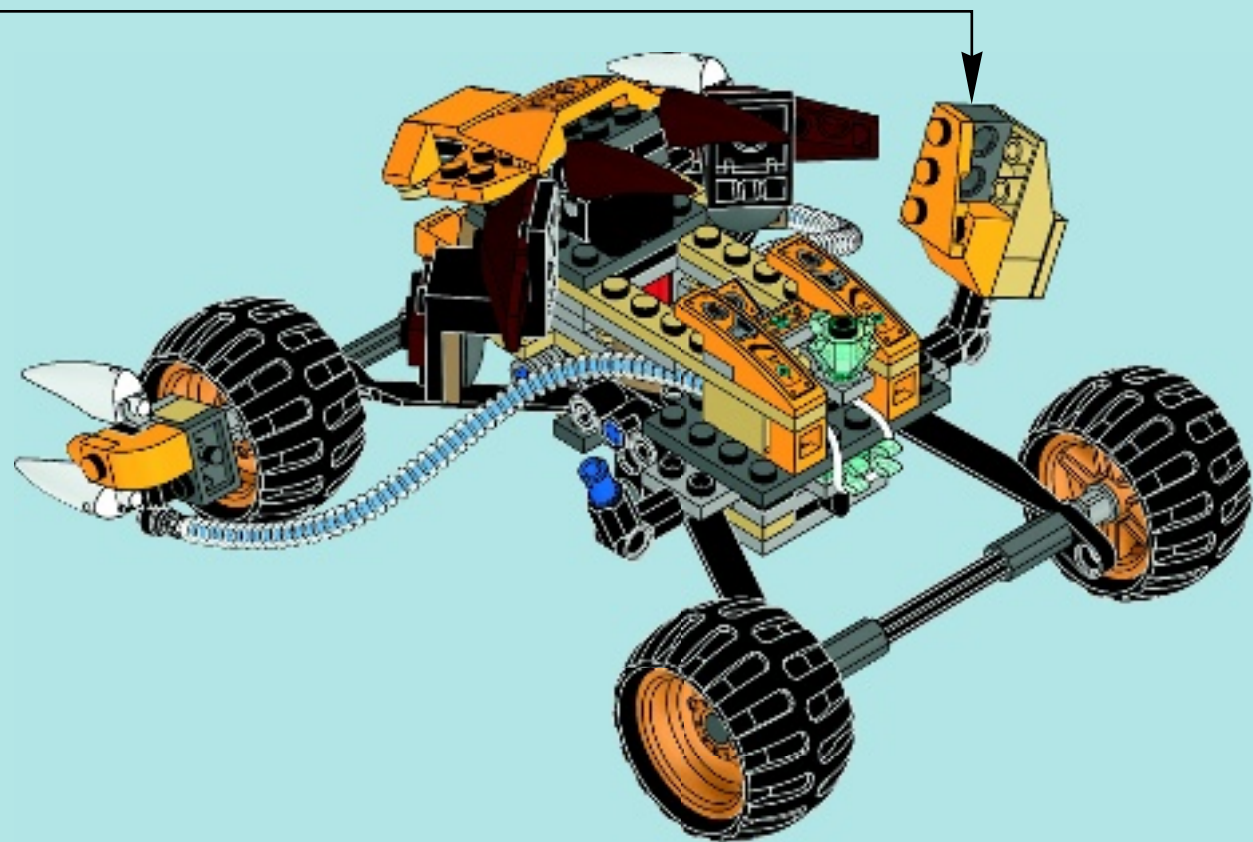



1x



1x



1x



1x



1x



1x

48

1

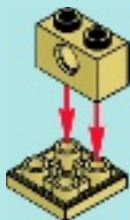

2



3



4

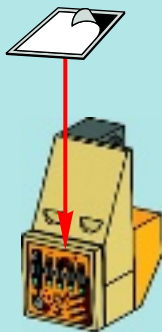
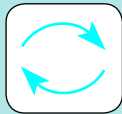

5

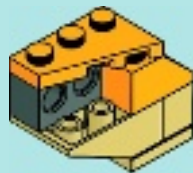
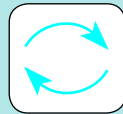

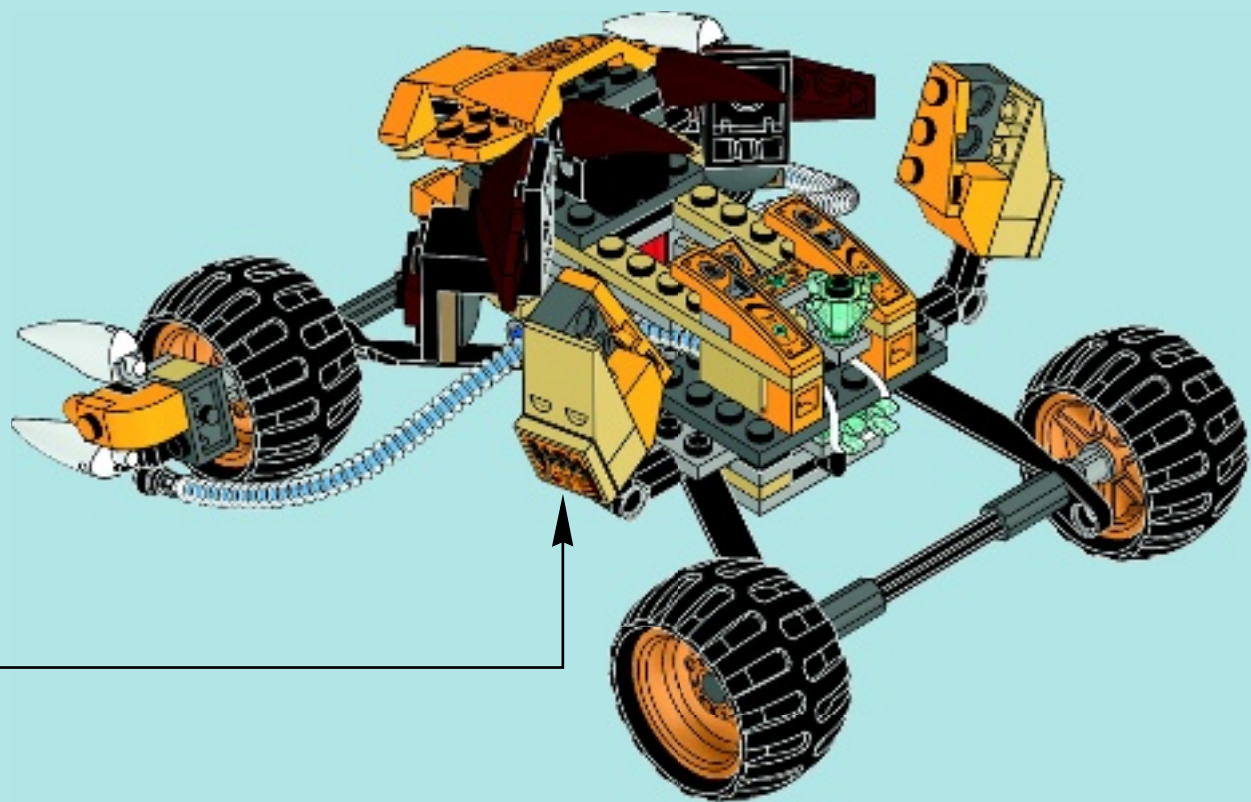

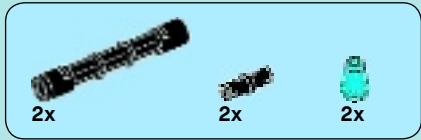

49



2x

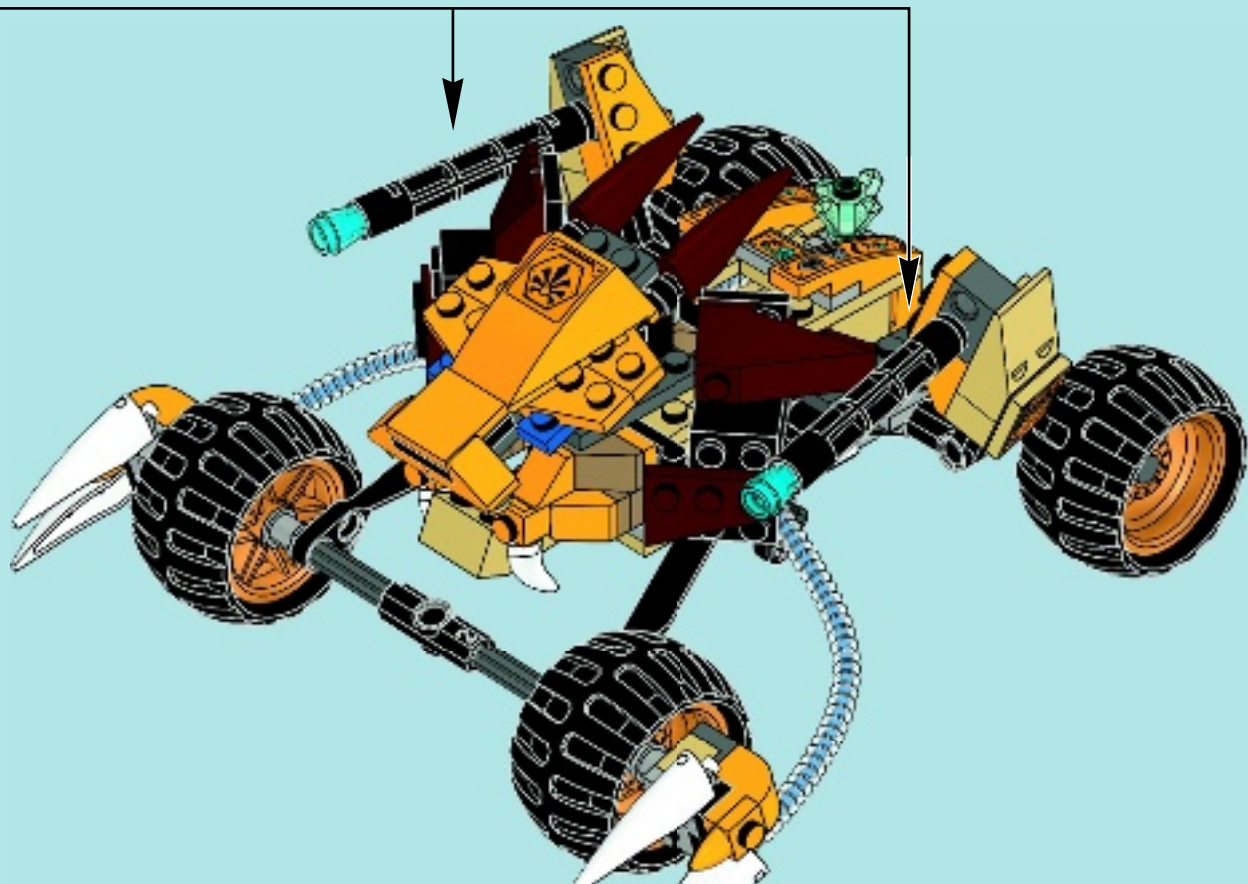



2x



2x

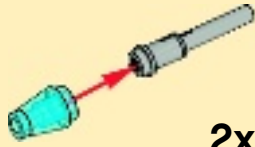

2x

50

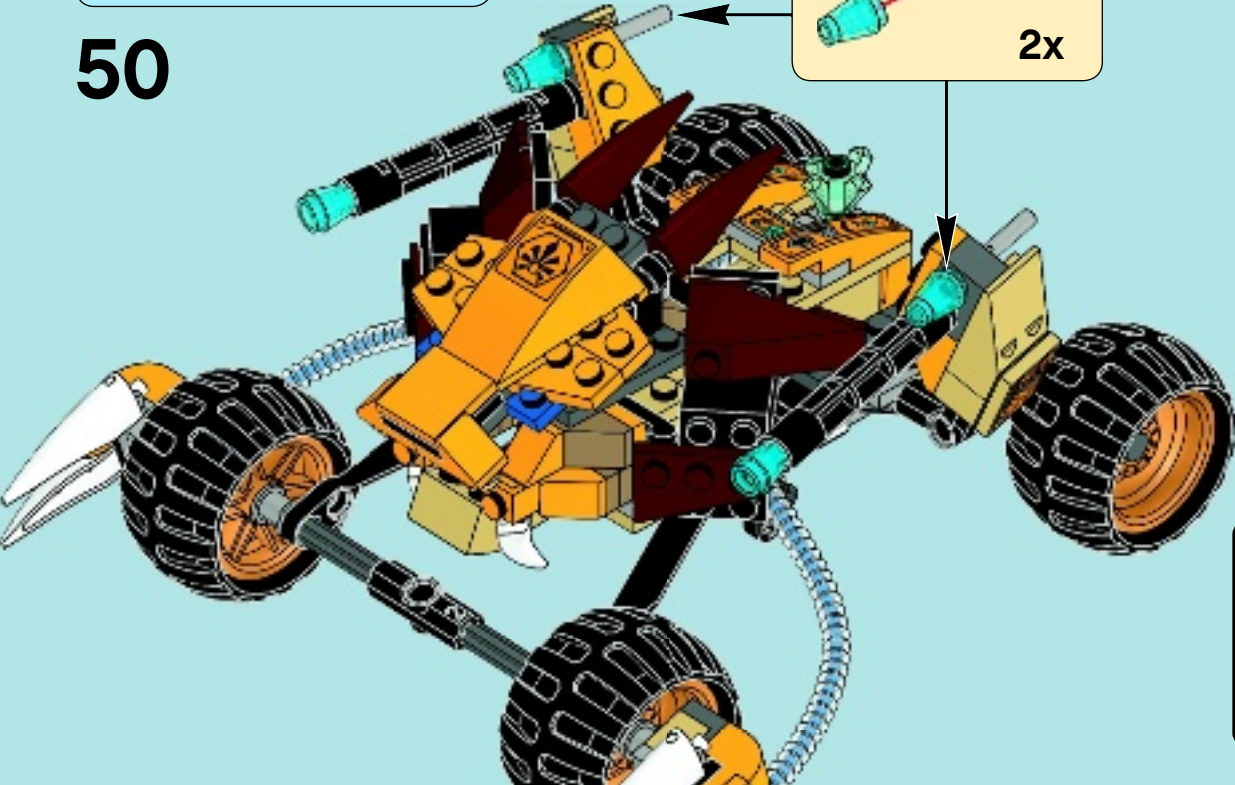



3x



3x

51

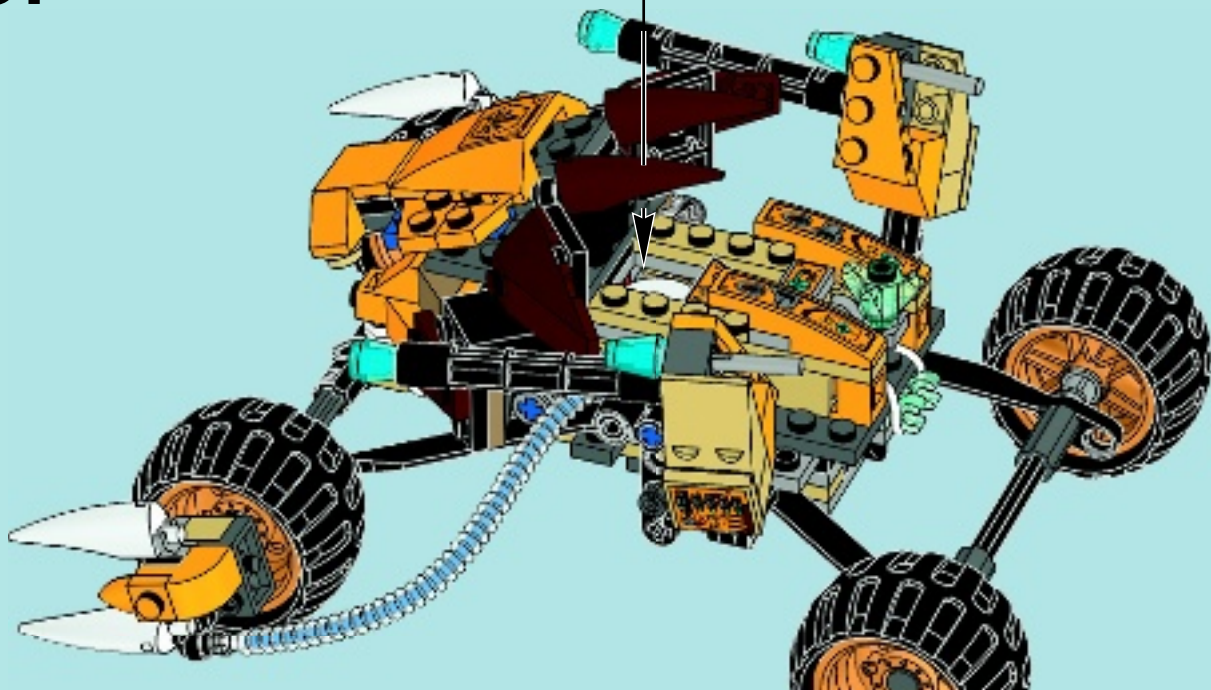

48

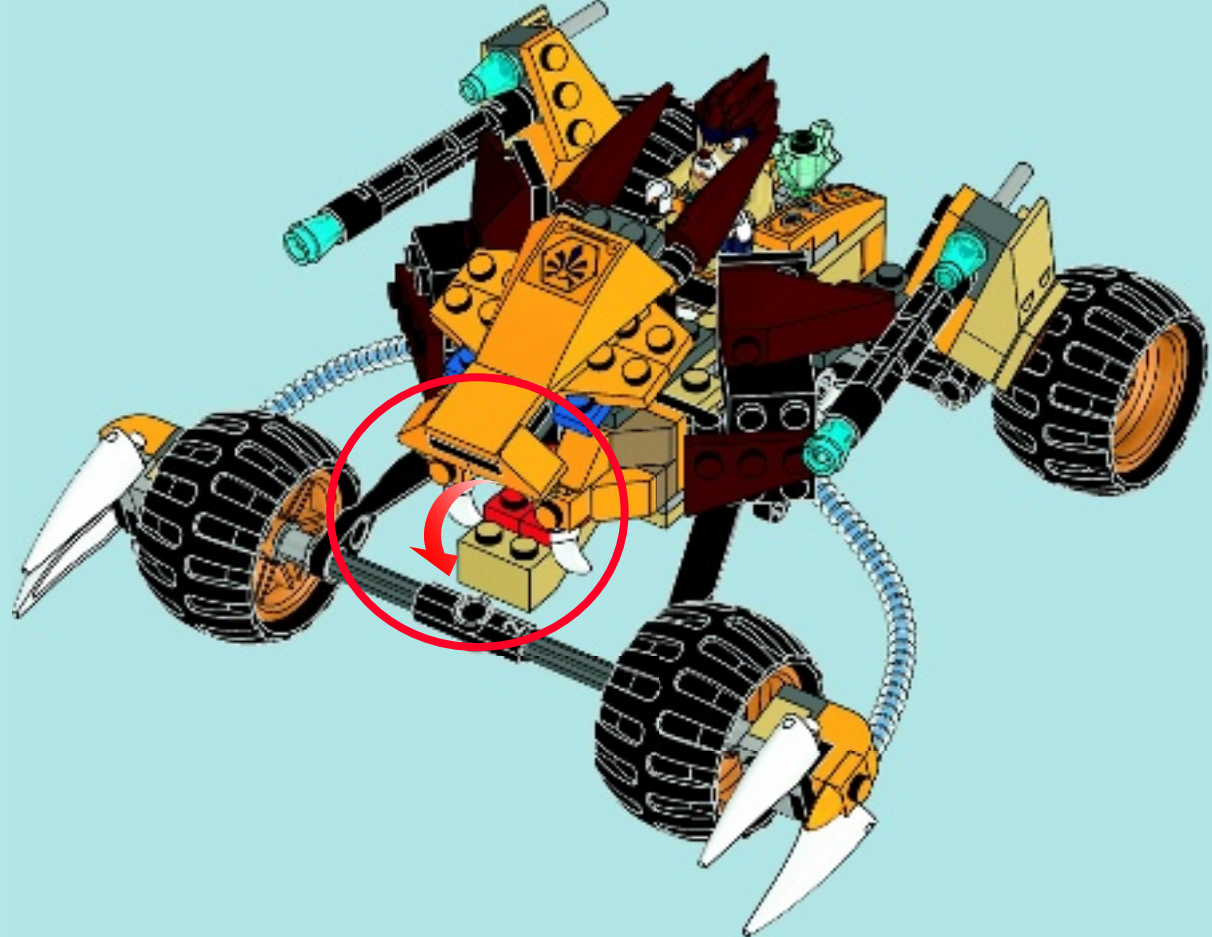

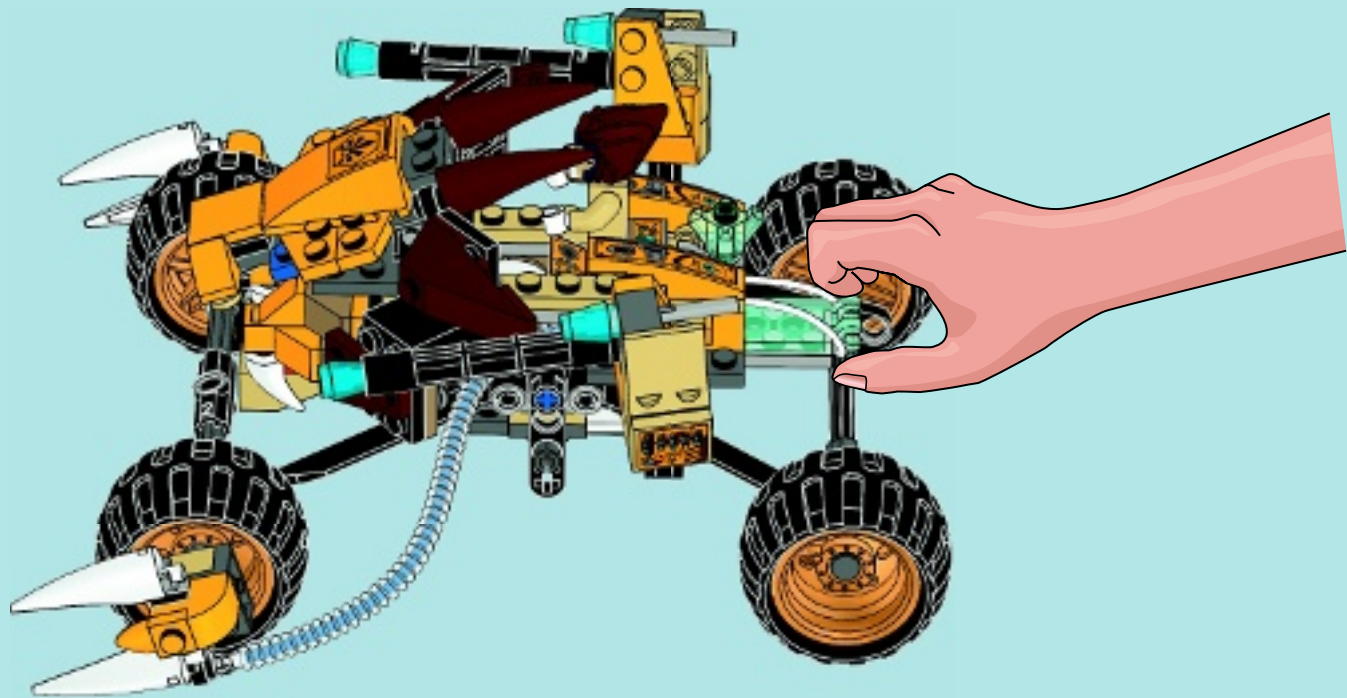

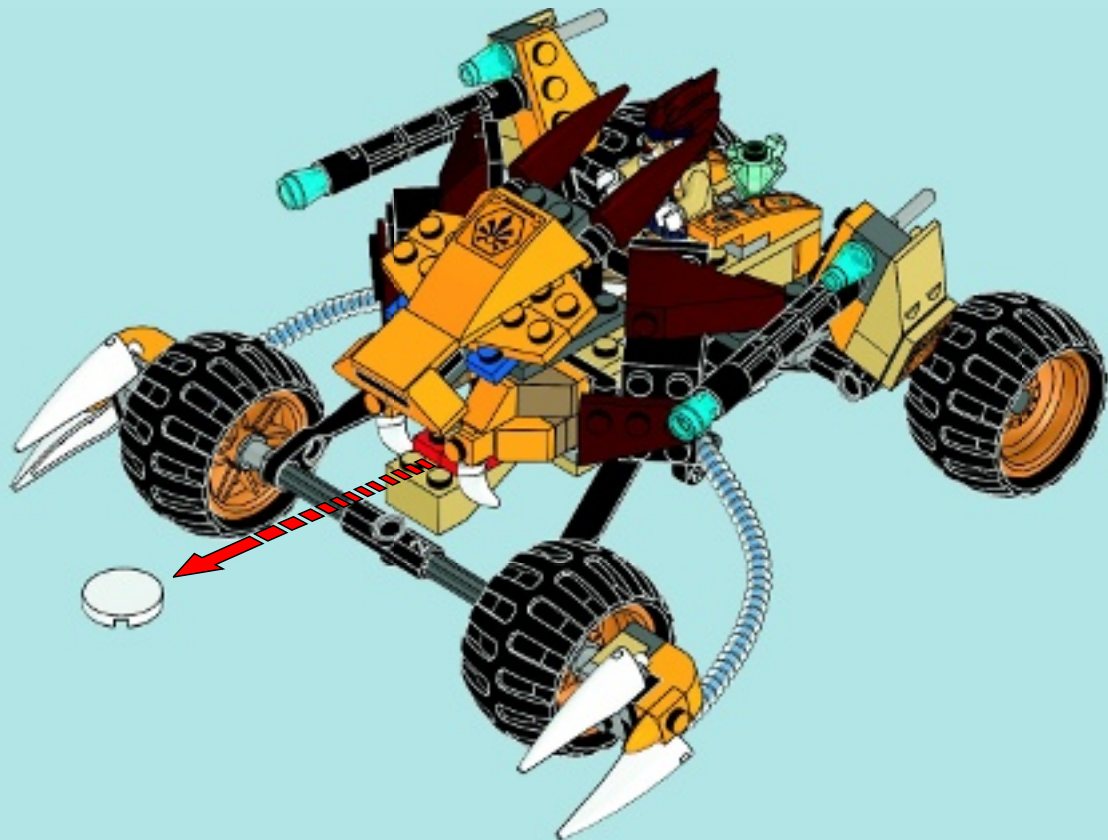



3x
415001



1x
663601



2x
4566256



4x
6015883



1x
4544140



2x
4117070



4x
4205107



3x
4500453



2x
4114077



4x
4114324



2x
4278046



1x
4217562



2x
6013081



6x
4161734



2x
4124460



1x
6021694



1x
6022547



1x
6021597



3x
306921



2x
4515365



2x
362323



8x
4206482



1x
3005741



2x
6012983



2x
370226



2x
4569733



3x
4556158



4x
4515368



2x
4560182



1x
4278359



1x
393726



2x
4155558



4x
4518826



2x
4598528



1x
4548180



2x
3022226



4x
4632571



1x
306226



2x
4107136



4x
4650636



1x
4107783



8x
4121715



2x
4107084



1x
370626



2x
4614561



1x
6019570



1x
4603191



4x
4567331



2x
6001826



2x
4530678



7x
4528604



2x
6020093



1x
6020141



4x
6020098



6x
6020106



1x
6020147



3x
6020145



3x
6020146



2x
4282860



2x
6020181



2x
6023185



2x
6003033



1x
6022569



1x
6023021



1x
6023807



2x
6021493



1x
6020148



1x
6020149



1x
6021339



1x
6021336



1x
4211503



1x
4211881



2x
4520320



4x
4211573



6x
4211622



3x
4599498



6x
4211395



3x
4541978



4x
4654582



2x
4211376



4x
4211429



1x
4213574



2x
4210762



1x
4211043



1x
4211056



1x
4243831



1x
4211002



1x
4211115



2x
6000606



2x
4278274



1x
4211051



1x
4509884



2x
4516546



2x
4560177



2x
4499858



4x
4648531



1x
4519970



1x
6028350



1x
6028340



1x
6002841



Customer Service

Kundenservice

Service Consommateurs

Servicio Al Consumidor

LEGO.com/service or dial



: 00800 5346 5555

: 1-800-422-5346



LEGENDS OF
CHIMA

WATCH THE VIDEO

WATCH THE VIDEO - VEJER DARS VIDEO EN
ESPAÑOL LA VIDEO - MIRA EL VIDEO
VE O VIDEO - NEZO MIRA O VIDEO

SCAN THE QR CODE

SCAN THE QR CODE - SCANNE DEN QR-CODE
SCANNE LE QR CODE - CAPTURA EL CÓDIGO QR
FAZ SCAN DO CÓDIGO QR - OLVARO DE A QR KÓDÓT



LEGO.COM/CHIMA



LEGO CHIMA



LENNOX CRAEGER

70006



70006



70005



70004



70003



70000



70001



70002

LEGO.com/chima



LEGO CHIMA

SPEEDORZ



70115



70115



4

WATCH THE MODEL IN ACTION

ERLEBE DAS MODELL IN AKTION
REGARDE LA DÉMO DU MODÈLE EN ACTION
MIRA EL MODELO EN ACCIÓN
VÊ O MODELO EM ACÃO
NEZD MEG A MODELLETT MŰKÖDÉS KÖZBEN



70100



70103



70102



70113



LEGO

LEGO CHIMA



LEGO.COM/CHIMA



LEGENDS OF CHIMA

4D X MOVIE EXPERIENCE

4D-MOVIE-XPRIENCE
EXPERIENCE FILM EN 4D
EXPERIENCIA CINEMATOGRAFICA 4D
EXPERIENCIA DE FILME EM 4D
4D FILM-ÉLMENY



EXCLUSIVELY AT LEGOLAND - THE 4D CHIMA EXPERIENCE

FIND OUT MORE AND GET SPECIAL OFFERS AT
LEGOLAND-CHIMA.COM



EXKLUSIV IM LEGOLAND: DAS CHIMA 4D-ERLEBNIS WEITERE
INFORMATIONEN UND SONDERANGEBOTE UNTER
LEGOLAND-CHIMA.COM



EN EXCLUSIVITÉ À LEGOLAND - L'EXPÉRIENCE CHIMA EN 4D OBTENEZ
PLUS D'INFORMATIONS ET DES OFFRES SPÉCIALES SUR
LEGOLAND-CHIMA.COM



SÓLO EN LEGOLAND: LA EXPERIENCIA CHIMA 4D MÁS
INFORMACIÓN Y OFERTAS ESPECIALES EN
LEGOLAND-CHIMA.COM



EXCLUSIVAMENTE NA LEGOLAND - A EXPERIÊNCIA CHIMA
EM 4D DESCOBRE MAIS E OBTÉM OFERTAS ESPECIAIS EM
LEGOLAND-CHIMA.COM



CSAK LEGOLANDBAN - 4D CHIMA ÉLMÉNY OLVASS RÓLA
BŐVEBBEN, ÉS KERESD A KÜLÖNLEGES AJÁNLATOKAT A
LEGOLAND-CHIMA.COM HONLAPON





3

www.LEGOclub.com/Max

LEGO club™

FREE*! GRATIS! GRATUIT!

*Paid subscription in Australia and New Zealand.
*Abonnement payant en Australie et Nouvelle-Zélande.

©2013 The LEGO Group.





WIN!

Go to www.LEGOsurvey.com/product to fill out a survey for a chance to win a cool LEGO® Product.

No purchase necessary.

Open to all residents where not prohibited.



www.LEGOsurvey.com/product

GEWINNE!

Nimm an der Umfrage auf www.LEGOsurvey.com/product teil und hab die Chance ein cooles LEGO® Produkt zu gewinnen!

Die Teilnahme am Gewinnspiel führt zu keinerlei Kaufverpflichtungen. Teilnahme in allen nicht ausgeschlossenen Ländern möglich.

WIN!

Ga naar www.LEGOsurvey.com/product, vul een enquêteformulier in en maak kans op een cool LEGO® product.

Geen aankoopverplichting. Iedereen mag deelnemen, uitgezonderd ingezetenden van landen waar een enquêteverbod geldt.

GAGNE!

Visite www.LEGOsurvey.com/product pour répondre à un questionnaire et avoir une chance de gagner un produit LEGO® très cool!

Aucune obligation d'achat. Ouvert à tous les résidents des pays autorisés.

当てよう!

www.LEGOsurvey.com/product にアクセスして、アンケートにご記入ください。当選者にはレゴ®製品を差し上げます。

お買い上げの必要はありません。禁止されていない限り、すべての皆様にご利用いただけます。



LEGO.com

6047601

LEGO and the LEGO logo are trademarks of the LEGO Group. ©2013 The LEGO Group.